

Niedergesäss, Markus

Working Paper

Duration dependence, lagged duration dependence, and occurrence dependence in individual employment histories

University of Tübingen Working Papers in Economics and Finance, No. 26

Provided in Cooperation with:

University of Tuebingen, Faculty of Economics and Social Sciences, School of Business and Economics

Suggested Citation: Niedergesäss, Markus (2012) : Duration dependence, lagged duration dependence, and occurrence dependence in individual employment histories, University of Tübingen Working Papers in Economics and Finance, No. 26, University of Tübingen, Faculty of Economics and Social Sciences, Tübingen, <https://nbn-resolving.de/urn:nbn:de:bsz:21-opus-60246>

This Version is available at:

<https://hdl.handle.net/10419/55220>

Standard-Nutzungsbedingungen:

Die Dokumente auf EconStor dürfen zu eigenen wissenschaftlichen Zwecken und zum Privatgebrauch gespeichert und kopiert werden.

Sie dürfen die Dokumente nicht für öffentliche oder kommerzielle Zwecke vervielfältigen, öffentlich ausstellen, öffentlich zugänglich machen, vertreiben oder anderweitig nutzen.

Sofern die Verfasser die Dokumente unter Open-Content-Lizenzen (insbesondere CC-Lizenzen) zur Verfügung gestellt haben sollten, gelten abweichend von diesen Nutzungsbedingungen die in der dort genannten Lizenz gewährten Nutzungsrechte.

Terms of use:

Documents in EconStor may be saved and copied for your personal and scholarly purposes.

You are not to copy documents for public or commercial purposes, to exhibit the documents publicly, to make them publicly available on the internet, or to distribute or otherwise use the documents in public.

If the documents have been made available under an Open Content Licence (especially Creative Commons Licences), you may exercise further usage rights as specified in the indicated licence.

University of Tübingen
Working Papers in
Economics and Finance

No. 26

Duration Dependence, Lagged Duration Dependence, and
Occurrence Dependence in Individual Employment
Histories

by

Markus Niedergesäss



Duration dependence, lagged duration dependence, and occurrence dependence in individual employment histories ¹

Markus Niedergesäss (University of Tübingen)

This version: 22 January 2012

Abstract. This paper investigates the form and magnitude of a variety of state dependence effects for prime-aged men in Germany. I differentiate between three labor market states: employment, unemployment, and out of labor force. Results indicate that all forms of state dependence are present in the data, in particular, there is strong duration dependence in employment and unemployment. Furthermore, past unemployment experiences are scarring and make future unemployment more likely, while past employment experiences help to find new employment, but do not help to remain employed. Simulations are conducted in order to investigate the effects of possible interventions in the labor market.

JEL-Classification: C33, C41, J64

Keywords: State dependence, Transition data, Event history analysis, Unobserved heterogeneity

Correspondence:

Markus Niedergesäss, Department of Economics, University of Tübingen, Mohlstr. 36, 72074 Tübingen, Germany, Phone: +49-7071-2977662, markus.niedergesaess@uni-tuebingen.de

¹I am grateful to Martin Biewen and to seminar participants in Tübingen, Nuremberg, and Hohenheim for helpful comments and discussions. All errors are my own. The data used in this paper were made available by the Research Data Center of the German Federal Employment Agency.

1 Introduction

It is a well-established finding that past employment states may have a causal impact on future employment states (state dependence). Heckman and Singer (1980) were the first to distinguish state dependence in three forms, namely dependence on the current duration, dependence on the occurrence, and dependence on the duration of past labor market experiences. Most of the existing studies have focused on the effects of past unemployment (see for example Arulampalam, 2001, Arulampalam et al., 2000, 2001, Gregg, 2001, Mühleisen and Zimmermann, 1994, or Flaig et al., 1993), usually called scarring effects. Although there is an increasing number of studies that now deal with this problem (see for example Cockx and Picchio, 2010), less is known about the effects of past employment experiences. Also little is known about how periods out of the labor force affect future labor market outcomes. Furthermore, most studies differentiate between the forms state dependence in a very simplified manner, often because they use annual data.

Differentiating between all three forms of state dependence seems necessary for the following reasons. A first reason is that only in this way the following policy relevant reasons can be answered: Do one or more short-term employment spells help the unemployed to find permanent employment? Is a single and short unemployment period already scarring? Does the current unemployment duration has an effect on the probability of leaving unemployment? What are the cross-effects, e.g. how do past employment spells affect the risk of future unemployment? The case for considering all forms of state dependence simultaneously becomes even stronger if one considers the possibility that the different forms may influence each other. Therefore, omitting one form may result in biased estimates for the other forms. For example, omitting occurrence dependence and lagged duration dependence due to past unemployment experiences may result in biased estimates for the duration dependence of the current unemployment spell, because individuals who are assumed long-term unemployed may also have experienced unemployment periods in the past.

The channels through which past labor market outcomes affect future labor market outcomes are various. Of particular interest are state dependence effects due to past unemployment and employment experiences which are generally related to two different mechanisms. First, in the eyes of potential employers the unemployed may be stigmatized by their unemployment duration or the occurrence of past unemployment. Second, the experience of unemployment may have led to a loss in skills or motivation. Furthermore, state dependence effects due to past employment

experiences are generally related to gains in human capital and broader networks, which may help to find new employment. However, state dependence effects can also be induced by institutional features. For example, dismissal protection laws increase the employment durations for workers with permanent contracts, while they shorten the durations for workers with temporary contracts. By contrast, the absence of a possibility to offer temporary contracts to the unemployed may result in longer unemployment duration.

The goal of the present study is to provide a comprehensive analysis of the form and the magnitude of state dependence effects for the three labor market states employment, unemployment and out of the labor force. Using administrative data for Germany, these effects are investigated for a group of prime-aged men who are at the risk of becoming unemployed or of leaving the labor force during the period under observation. Prime-aged men are of particular interest as they form the largest group in the labor market and also have the highest labor market attachment. They also represent the largest group among the group of the unemployed and are therefore a group of individuals who are most likely subject to policy measures. The focus on prime-aged men is in contrast to much of the literature, which usually focuses on youth unemployment (for example, Doiron and Gorgens, 2008). The analysis of youth labor markets is appealing, as one can observe the labor market entry and hence one can measure for example scarring effects of early unemployment experiences. If one focuses on prime-aged men, however, most available data sets only provide the labor market histories for certain periods which are often not longer than ten years and which do not include the labor market entry. This complicates the econometric analysis of state dependence effects. For example, it is evident that one has to account for initial conditions when modeling unobserved heterogeneity.

In order to investigate the different forms of state dependence, this paper uses a particularly rich administrative data set, the Integrated Employment Biographies Sample (IEBS), which was made available by the Research Data Center of the German Federal Employment Agency. The data set is based on the information from four different administrative registers and allows one to observe the employment histories on daily-basis for the period from 1992 until 2003. The availability of daily information is a major advantage over other data sets. It allows one to model the different forms of state dependence taking advantage of methods of survival analysis in continuous time (see for example, van den Berg, 2000). I distinguish between three labor market states: employment, unemployment, and out of the labor force. In order to model the six possible transition intensities jointly, I estimate a mixed proportional hazard model with competing risk of exit. In order to distinguish between state dependence and other effects, I include a large

set of observed variables and additionally account for unobserved heterogeneity. In contrast to many other studies, I also account for initial conditions. Following the idea of Wooldridge (2000), I condition the likelihood of the transition intensities on the past labor market history using a parsimonious linear specification.

My results indicate that state dependence is present for almost all states. In particular, there is strong negative duration dependence for the transitions from employment, and for the transition between unemployment and employment. Furthermore, the occurrence of past unemployment is scarring, especially if the unemployment period has occurred recently. In addition, the occurrences of past employment spells seem to be beneficial for finding new employment. The results thus indicate that there may be a circle of unemployment and unstable employment, where unstable employment may be considered as temporary employment or low-wage employment. The more frequent transitions between unemployment and employment were in the past, the more difficult it becomes to escape from this circle. The results are therefore in line with the literature on the segmentation of the labor market into individuals with stable employment and individuals who constantly transit between unstable employment and unemployment (see for example Stewart, 2005). Simulation of different policy interventions support these findings. They show that additional employment spells help unemployed to find new employment and that even very short additional unemployment spells are scarring.

The remainder of the paper is structured as follows. Section 2 provides some stylized facts referring to state dependence effects in labor market outcomes and discusses some related literature. Section 3 presents the data set, it shows how labor market states are identified, and describes the sampling scheme. In addition, section 3 presents a descriptive analysis of the final sample. Section 4 then introduces the econometric model. Results are presented and discussed in section 5. Finally, section 6 shows the results of simulated policy interventions, while section 7 concludes.

2 Stylized facts and related literature

There are different possibilities of how past labor market outcomes may influence future labor market outcomes. Heckman and Borjas (1980) were the first to precisely define the concept of state dependence based on the theory of survival analysis and to distinguish between three forms. To start with, duration dependence refers to the dependence on the duration of the current spell. Second, occurrence dependence refers to the possibility that the occurrence of past spells may

affect the probability of leaving the current state. Third, it might not only be the occurrence but also the duration of past spells that affects the probability of leaving the current labor market state. This dependency is labeled lagged duration dependence. The present section gives a short review of some stylized facts and the related literature.

Duration dependence From a theoretical point of view, transitions from employment to unemployment are generally assumed to depend negatively on the current duration (see for example Jovanovic, 1979). Mortensen (1986) shows that these effects might be due to a sorting effect. Employees, who are relatively more productive face a much lower risk to be dismissed and therefore remain longer with their current employer. The resulting survival bias is then perceived as a negative duration dependence. Also, the institutional setting may have an impact on the current employment duration. For example, protection against dismissals of those employees with permanent contracts increases employment durations in comparison to employees with temporary contracts, and therefore induces a negative duration dependence. Transitions from employment to out of the labor force can also be assumed to depend negatively on the current duration. However, the labor market state "out of the labor force" is more heterogenous than the labor market state "unemployment". In particular, transitions to out of the labor force and back are often planned decisions (e.g. maternity leaves). Possible relationships are therefore less obvious. Also, the literature does not provide further evidence for this type of transitions as unemployment and out of the labor force are often aggregated to one single state.

The transition from unemployment to employment is also assumed to exhibit negative duration dependence. This is the transition most studied by the literature. In general, there are two channels through which the current unemployment duration might affect the transition probability. On the one hand, Pissarides (1992) points out that long unemployment durations are accompanied by losses in human capital and therefore employment chances decrease with the time spent in unemployment. On the other hand, employers are generally not able to observe the unemployed's productivity and motivation. They therefore use unemployment durations to infer on the productivity and motivation, as Vishwanath (1989) and Lockwood (1991) point out. In this sense, Blanchard and Diamond (1994) assume that employers rank applicants by their unemployment duration and hire the ones with the shortest durations. This means that the unemployed with longer durations are stigmatized, because always those unemployed with a shorter unemployment duration are hired.

The transition from unemployment to out of the labor force is generally assumed to depend positively on the current duration, at least in the very long-run. Schweitzer and Smith (1974) point out that long unemployment durations may discourage unemployed in their search effort, and unemployed may drop from the labor force the longer they are unemployed. Although there may exist such discouragement effect, in most European countries, unemployed are required to search for a job in order to receive unemployment compensation. Therefore, discouragement effects should be rather limited. Little is known about the transitions from out of the labor force to other labor market states. This is mostly due to the fact that out of the labor force is a relatively heterogeneous labor market state.

Occurrence and lagged duration dependence Many authors found evidence for the hypothesis that past unemployment causes future unemployment (for example, Arulampalam, 2001, Arulampalam et al., 2000, 2001, Gregg, 2001, Mühleisen and Zimmermann, 1994, or Flaig et al., 1993). Past unemployment experiences probably increase the current unemployment duration, because of stigmatization effects or a loss in human capital. Biewen and Steffes (2010), for the case of Germany, find evidence for such stigmatization effects. Gibbons and Katz (1991) show that past unemployment experiences increase the pressure to accept bad job matches, which in turn leads to a higher probability to end up in unemployment again. These effects may become even more pronounced with the number and duration of past unemployment experiences. Winter-Ebmer and Zweimüller (1992) also find evidence for this hypothesis. By contrast, Ehrenberg and Oaxaca (1976) suggest that a longer job search, that means a longer unemployment duration, results in a better job match and has therefore positive effects on the current employment duration.

Past employment experiences are generally assumed to increase the probability of finding a new job. Reasons for this may be that the experience of past employment spells signals a higher productivity or at least a higher motivation to work. Furthermore, past employment periods may have been used to build a network, which may help finding new employment (Ioannides and Loury, 2004). By contrast, Ljungqvist and Sargent (1998) suggest that human capital gained in previous employment periods may be firm-specific and hence not relevant for future employers. Consequentially, future employers are not willing to pay the too high reservation wage and therefore increase the unemployment duration of those searching for a job. Again, institutional features may have an impact. For example, the entitlement period of unemployment benefits depends positively on past employment experiences. As mentioned, the entitlement

period may have a strong effect on the current unemployment duration and therefore may induce spurious effects of past employment experiences.

On first sight, it may be assumed that past employment experiences decrease the probability of a job loss. Although human capital gained may be firm-specific, past employment experiences result in a larger human capital and more work experience and therefore decrease the probability of becoming unemployed. Doiron and Gorgens (2008) find evidence for this hypothesis for Australian school-leavers. However, the effects probably depend on the quality and durations of past employment experiences. Boockmann and Hagen (2006) suggest that such circles may exist between temporary employment and unemployment, while Stewart shows that frequent changes between low-pay employment and unemployment create stigmatization effects and individuals therefore remain in a vicious circle of low-pay employment and unemployment. Similarly, Cockx and Picchio (2010) and Mosthaf (2011) find support for the idea that past temporary employment spells build a bridge to permanent employment for long-term unemployed.

3 Data and Sample Selection

3.1 German Integrated Employment Biographies Sample

The following empirical analysis is based on the Scientific Use File of the German Integrated Employment Biographies Sample (IEBS). The IEBS has been made available by the Research Data Center of the German Federal Employment Agency. It is a 2.2% random sample from a merged data file that integrates data from four different administrative registers.

The first register contains data on individual employment histories ("Beschäftigten-Historie", BeH). Employment periods that are subject to social security contributions are registered by the public pension funds and then used to construct the individual's employment histories. Since employment periods that are not subject to social security contributions are not part of the data set, employment histories of self-employed individuals or life-time civil servants are not part of the data. In total, the BeH provides information on employment spells for the period from 1992 to 2003. In addition, the register provides information on the current employer and personal characteristics.

The second register provides data on individual's histories of receipt of transfers from the unem-

ployment insurance system ("Leistungsempfänger-Historie", LeH), i.e. data on the receipt of unemployment benefits, unemployment assistance and income maintenance during training measures. Data on the receipt of unemployment transfers are available for the period from 1992 to 2004. In addition, relevant information of the level of unemployment benefits or assistance and further personal characteristics are provided.

The third register offers data on the histories of registered unemployment ("Arbeitsuchenden und Bewerbungsangebotsdaten", BewA). The BewA provides information on individuals who were registered as unemployed or searched for a job at their local employment agency. Unfortunately, data from the BewA is only partly available for the period from 1992 to 1999 and completely available for the period from 2000 to 2003.

Finally, the fourth register contains data on individual histories of participation in public sponsored measures of Active Labor Market Policies ("Maßnahme-Teilnehmer-Gesamtdatenbank", MTG), i.e. on job-creation measures ("Arbeitsbeschaffungs-Maßnahmen"), settling-in allowances ("Eingliederungszuschuss"), assistance to start an own business ("Existenzgründerzuschuss"), and further training schemes that range from vocational trainings to language courses. Again, data from the MTG is completely available only for the period from 2000 to 2004.

Merged together, the four registers provide a data set that presents labor market histories of around 1.6 million individuals. The information on start and end dates are very precise, as they are measured on daily basis. Missing information on employment spells for 2004 means that all labor market histories from the end of 2003 onwards are censored. Figure 1 presents the labor market history of a typical person in the IEBS. A spell is left-censored, if it is the individual's first spell recorded by the data set and has a start date that can not be observed, i.e. the spell starts before January 1, 1992. A spell is right-censored, if it is the individual's last spell recorded by the data set and has an end date that can not be observed, i.e. the spell ends after December 31, 2003. Periods with no information from any of the four registers may also occur, because individuals become self-employed, start to work as lifetime civil-servants, are on maternity leave, or completely withdraw from the labor market. Identification of the labor market state is particularly difficult for these periods. In particular, distinction between periods out of the labor force and unemployment periods is often impossible. In certain cases the reason for such a gap in the labor market history can be inferred from the spells before and after the gap. Differentiating between registered unemployment and out of the labor force is particularly difficult between 1992 and 1999 as there may be periods of registered unemployment without

receipt of unemployment benefits.

In addition to aforementioned problems, overlapping spells from one or more registers may exist. On the one hand, overlapping spells provide additional information that makes identification of the correct labor market state more reliable. For example, parallel information on registered unemployment and receipt of unemployment benefits makes the statement that the individual is unemployed more reliable. On the other hand, such overlapping spells can be a burden, because some of the overlaps contradict institutional rules and may be the result of errors. The surveys by Bernhard et al. (2006) and Jaenichen et al. (2005) present comprehensive overviews of such overlaps which contradict institutional rules and also point out possible solutions.

— Figure 1 about here —

3.2 Definition of labor market states

The IEBS does not provide direct information on the current labor market state. These rather have to be identified using the information given in the four registers. In general, the information on the current employment status suffices to identify the labor market state. The situation is more difficult for periods without information. For these periods, the labor market state is identified by making certain assumptions. The following subsection provides more details on the identification of the different labor market states.

Unemployment: In order to identify unemployment periods, the official definition for unemployment in Germany given by the Federal Statistical Office, i.e. individuals, who are registered as unemployed and do not work for more than 15 hours per week, does not suffice. In particular, the period from 1992 until 1999 does not provide complete information on registered unemployment, such that the official definition would not comprise all unemployment periods and has thus to be modified. Therefore, individuals who receive transfers from the unemployment compensation system, individuals who are registered as unemployed or at least searching for a job, or attend some form of public sponsored measures², and individuals who do not work for more than 15 hours per week, are considered as unemployed. This means job-creation measures and settling-in

²Excluding job-creation measures ("Arbeitsbeschaffungs-Maßnahmen"), settling-in allowances ("Eingliederungszuschuss"), assistance to start an own business ("Existenzgründerzuschuss")

allowances are not considered as unemployment, but as employment. For the period from 1992 to 1999 unemployed individuals, particularly those of young age, may not appear in the data set, although they are registered as unemployed, if they are not entitled to receive transfers from the unemployment insurance system. Furthermore, individuals who quitted their job without good cause disqualified themselves for transfers from the unemployment compensation system for up to twelve weeks. Unfortunately, the data set does not include information on the reason of the dismissal. For periods without information on the individual, it is therefore necessary to differentiate whether the individual is unemployed or has dropped out the labor force. In order to do this, I make the following assumptions. To begin with, periods without information on the individual and which lie between an employment period and an unemployment period, are assumed to be unemployment periods, if the individual starts to receive transfer payments or registers as unemployed within three months after the termination of a job. Second, periods with no information on the individual, which are between two unemployment periods, are assumed to be unemployment periods, if the individual starts to receive transfer payments again or renews the registration as unemployed within one month or within three months in the case of cut-off times³. Finally, periods that lie between an unemployment period and an employment period are assumed to be unemployment periods, if the individual starts working again within one month or within three months in the case of cut-off times.

Employment: In general, any type of employment, i.e. full-time and part-time employment, marginal employment, and also subsidized employment like job-creation measures, is considered as employment. However, if the individual is additionally registered as unemployed or receives transfers, and works less than 15 hours per week, the corresponding spell is classified as unemployment. Also, periods, with no information on the individual, between two employment periods are considered as employment, if they are shorter than one month.

Out of Labor Force: The general definition of an individual, who is out of the labor force refers to someone, who is not employed and not actively searching for a job. The data set provides information on whether the individual is employed or unemployed, but not on whether

³Cut-off times are periods, in which the individual is prohibited to receive transfers from the unemployment compensation system. A possible reason may be to quit a job without good cause. Whether a gap is due to a cut-off time is given by the three registers that concern to periods in unemployment, i.e. LeH, BewA, and MTG, but not by the BeH.

the individual actively searches for a job. Therefore, one has to rely on the information given in the data set to identify those periods as employment, or unemployment periods, or out of the labor force for which no information is present. In addition, individuals may become self-employed and may therefore not be observed in the data set. In order to account for this point, if any information about becoming self-employed is available, the individual is completely dropped from the sample. Finally, after identifying all employment and unemployment periods and accounting for self-employment, periods with no information on the individual are considered as periods out of the labor force.

Figure 2 provides an example for the identification of labor markets for a typical person in the IEBS.

— Figure 2 about here —

Table 1 presents the numbers and frequencies of transitions between all three states. The table shows that the present identification strategy yields a relatively homogenous sample, because the frequencies change only slightly across years.

3.3 Sample design

Due to large differences between employment trajectories of men and women, the following analysis focuses on prime aged men. The analysis of women's employment histories is complicated by the fact that women are much more likely to interrupt their career in order to raise children. The final sample therefore consists of men who were born between 1950 and 1970. This means the individuals are at least 22 years old when observed for the first time and at most 53 years old when observed for the last time. Prime aged men constitute a very large subgroup in the labor market and have the lowest propensity to drop from the labor force. Due to this high attachment to the labor market, the labor market histories of prime-aged men are often continuously observed by the four registers. Therefore, distinction between unemployment and out of the labor force is easier than for other subgroups.

The final sample consists only of those men who changed their labor market state at least once during the period from January 1, 2000 until December 31, 2003. In addition, estimation is conducted using only those spells that begin during the period under consideration. This means

the final sample is similar to an inflow sample, which are typically used for single-spell models. By using such a form of sample selection, the resulting sample consists of men who belong to the group of individuals who are most likely to take part in labor market policy measures. The analysis of this sample is therefore highly relevant for the analysis of labor market policies. An additional feature of this sampling mechanism is that those spells which begin prior to the first spell used for estimation can be used to construct the labor market history. Since this preceding labor market history generally covers around eight years, these histories can be used to construct regressors that account for occurrence and lagged duration dependence and that can be used to estimate state dependence effects for prime-aged men, whose labor market entry is typically not observed. Finally, this form of sampling mechanism avoids left-censoring problems, because only spells of which the start date is known enter the sample. In general, only very few authors have dealt with left-censoring issues (see for example D'Addio and Rosholm, 2002b, and Gritz, 1993), and their approaches require strong assumptions.

Nonetheless, sampling individuals in the way described requires some adjustments. First, right-censoring becomes more likely the later is the start date of the first spell after January 1, 2000. For example, if I used the cumulative lagged durations of the three labor market states as regressors, the cumulative lagged durations of all three labor market states of an individual, whose first spell starts on January 1, 2003 would on average be longer than the cumulative lagged durations for an individual, whose first spell starts on January 1, 2001. This means that the first spell of the first individual, who on average has longer cumulative lagged durations, is more likely to be censored than the first spell of the second individual. Therefore, longer lagged durations would erroneously result in a higher probability to be right-censored and coefficient estimates for lagged duration would be biased. In order to avoid this problem, I construct regressors referring to the lagged duration and to the occurrence of past labor market states using only the information from the last eight years of the employment history before the start of a certain spell⁴.

A second point one has to account for, is the initial conditions problem. The initial conditions problem arises when using lagged outcomes as regressors because these are not exogenous with respect to unobserved characteristics. To be more precise, for the first spell of an individual in the estimation sample, the regressors that account for state dependence are based on the history of prior labor market outcomes. These outcomes, which are either not used for estimation or not

⁴The problem with the cumulative occurrence of past labor market states is the same as with the cumulative duration of past labor market states, although the effects are less strong.

observed by the data set, are certainly influenced by unobserved heterogeneity like ability or the attitude to work. Therefore, estimates for state dependence effects will be biased, if one does not account of these prior outcomes. A description of how this is done, will be given in the next section.

Figure 3 gives a short overview of how individuals are sampled and what parts of the individual's history are used.

— Figure 3 about here —

3.4 Descriptive Analysis of the Data Set

There are altogether 208,909 individuals born between 1950 and 1970, which comply with the requirements of the overall sample. Of these 69,820 individuals have spells that begin during the period from 2000 to 2003. Basic summary statistics for the final sample are presented in Table 2. The average duration of the sum of all spells that begin after January 1, 2000 and that are observed until December 31, 2003 is 969 days, which is a little more than two-and-a-half years. Of this average duration, on average 533 days (54.97% of the total time) are spent in employment, 317 days (32.67%) in unemployment, and 120 days (12.36%) out of labor force.

In total there are 224,709 spells, 91,977 of which are employment spells, 95,733 are unemployment spells, and 36,999 are out of the labor force spells. Although there are more unemployment than employment spells, the last spell observed is mostly spent in employment (35,788 employment spells vs 25,662 unemployment spells and 8,370 spells out of the labor force). Most of the transitions occur from unemployment to employment (58,105 transitions or 37.51% of all transitions) or vice versa (48,472 or 31.29%). Incidence rates display the number of exits per year and type of spell. Results indicate that the individuals observed, on average, experience even more periods in unemployment than in employment. However, employment periods on average are longer and therefore individuals spend more time in employment than in unemployment.

The bottom panel of Table 2 shows deciles for the distribution of all three types of spells. For instance, the 10%-decile shows that 10% of all employment spells are shorter than 45 days and 90% are longer. In general, for all deciles, except the last two, employment spells are longer than unemployment spells and spells out of the labor force, while for all deciles spells out of the labor force are longer than unemployment spells. The median length of employment spells is 337 days,

while that of unemployment and out of labor force spells is 152 days and 183 days respectively.

— Table 2 about here —

Table 3 provides summary statistics for some of the personal characteristics. The mean age for the year 2000 for all individuals in the estimation sample is 38.94 years. The individual's occupation can be assigned to the sectors of manufacturing or service in almost 89% of the cases, while only a small number is employed or searches employment in the other sectors. Information on individual's education shows that 18.8% of all individuals have not obtained any educational degree until the last observation. Most individuals have passed a vocational training (67.6%), while only few individuals have obtained higher educational degrees. The overproportional number of individuals with low educational degrees is explained by the selection of only those individuals, who are not continuously employed during the period from 1992 to 2003.

— Table 3 about here —

4 Econometric Methods

In the next section I present the econometric method that is employed to estimate the conditional transition intensities. The methodology is similar to that used by Doiron and Gorgens (2008). However, due to a different sample design, it is necessary to account for initial conditions. This is done following an approach similar to the one suggested by Wooldridge (2000).

4.1 Outcome and explanatory variables

I use the labor market history of an individual i as the outcome variable of the model. The history includes two aspects: transition times and destination states. Let $T_{i,j}$ be the calendar time for the start date of the j th spell of individual i , $S_{i,j}$ be the respective type of the labor market state, i.e. whether the individual is employed (E), unemployed (U), or out of the labor force (O), and let $j = 0, 1, 2, \dots, n_i$. This definition implies that $S_{i,j-1} \neq S_{i,j}$ and $T_{i,j-1} < T_{i,j}$, i.e. spells end when individuals switch to another state. In order to estimate conditional transition intensities, I use only spells that begin during the period $[T_{i,0}, C_i]$, where $T_{i,0}$ is the start date of the first

complete spell after January 1, 2000 and C_i is a random variable, which indicates the censoring point. Observed spells with start date earlier than January 1, 2000 are used to construct the labor the history of each individual.

To clarify the discussion, it is essential to distinguish between exogenous and lagged endogenous explanatory variables in the notation. Let $X_i(t)$ be the vector of exogenous explanatory variables for individual i at time t , and $\mathbf{X}_i(t)$ be the path of exogenous explanatory variables until t . Further, define $\mathbf{Y}_i(t, s)$ to be the path of outcome variables recorded until point t , where s is the labor market state taken at t and t is not necessarily a transition time.

It is well-known that it is difficult to separate state dependence effects from spurious dependence on past outcomes if unobserved heterogeneity is not accounted for. In order to account for unobserved heterogeneity, I therefore include random effects in the model. To this end, let V_i be a random vector that captures unobserved personal and environmental characteristics.

4.2 Transition intensities, right censoring and the likelihood function

As the data set provides daily information on transitions between labor market states, continuous measurement of time can be assumed. To this end, let $h(t, s | \mathbf{y}(\tilde{t}, \tilde{s}), \mathbf{x}(t), v)$ be the transition intensity for a transition from state \tilde{s} to state s at time t , given that the current spell began at time \tilde{t} and conditional on the labor market history, $\mathbf{y}(\tilde{t}, \tilde{s})$, the path of explanatory variables $\mathbf{x}(t)$ and the value of unobserved heterogeneity, v .

Throughout the paper lowercase letters indicate realized values of random variables. The contribution to the likelihood function of individual i conditional on $\mathbf{X}_i(C_i) = \mathbf{x}_i(c_i)$, and $V_i = v_i$, is then given by

$$\begin{aligned} \mathcal{L}(\mathbf{y}_i(t_{i,n_i}, s_{i,n_i}), c_i | \mathbf{x}_i(c_i), v_i) &= \mathcal{L}(c_i | \mathbf{y}_i(t_{i,n_i}, s_{i,n_i}), \mathbf{x}_i(c_i), v_i) \\ &\times \left(\prod_{j=1}^{n_i} \mathcal{L}(t_{i,j}, s_{i,j} | \mathbf{y}_i(t_{i,j-1}, s_{i,j-1}), \mathbf{x}_i(t_{i,j}), v_i) \right) \\ &\times \mathcal{L}(\mathbf{y}_i(t_{i,0}, s_{i,0}) | \mathbf{x}_i(t_{i,0}), v_i) \end{aligned} \quad (1)$$

Equation (1) displays the likelihood contribution using the joint distribution of all outcomes

conditional on observed and unobserved heterogeneity. The first term of equation (1) is then the likelihood contribution for the last spell observed. For the last spell neither the transition time, nor the transition state is completely known. However, the likelihood of survival in state S_{i,n_i} up to the censoring point C_i can be given. Assuming that C_i is distributed independently from the past history and from observed and unobserved characteristics, the likelihood contribution for the last spell evolves as

$$\mathcal{L}(c_i | \mathbf{y}_i(t_{i,n_i}, s_{i,n_i}), \mathbf{x}_i(c_i), v_i) = \exp \left(- \sum_{\substack{k=E,U,O \\ k \neq s_{i,n_i}}} \int_{t_{i,n_i}}^{c_i} h(u, k | \mathbf{y}_i(t_{i,n_i}, s_{i,n_i}), \mathbf{x}_i(u), v_i) du \right). \quad (2)$$

Equation (2) then simply describes the probability that no transition takes place during the period $[T_{i,n_i}, C_i]$.

The second term of equation (1) captures the likelihood contribution of all completed spells with a start date later than January 1, 2000. Conditional on $\mathbf{Y}_i(t_{i,j-1}, s_{i,j-1}) = \mathbf{y}_i(t_{i,j-1}, s_{i,j-1})$, $\mathbf{X}_i(t_{i,j}) = \mathbf{x}_i(t_{i,j})$, and $V_i = v_i$ the likelihood contribution for the j -th spell of individual i is

$$\begin{aligned} \mathcal{L}(t_{i,j}, s_{i,j} | \mathbf{y}_i(t_{i,j-1}, s_{i,j-1}), \mathbf{x}_i(t_{i,j}), v_i) &= h(t_{i,j}, s_{i,j} | \mathbf{y}_i(t_{i,j-1}, s_{i,j-1}), \mathbf{x}_i(t_{i,j}), v_i) \\ &\times \exp \left(- \sum_{\substack{k=E,U,O \\ k \neq s_{i,j-1}}} \int_{t_{i,j-1}}^{t_{i,j}} h(u, k | \mathbf{y}_i(t_{i,j-1}, s_{i,j-1}), \mathbf{x}_i(u), v_i) du \right). \end{aligned} \quad (3)$$

Equation (3) describes the likelihood contribution for a transition of individual i from state $s_{i,j-1}$ to $s_{i,j}$ at time $t_{i,j}$. While the first term describes the intensity for a transition to state $s_{i,j}$ at time $t_{i,j}$, the second term equals the probability for surviving in the current state from $t_{i,j-1}$ until $t_{i,j}$. Obviously, individuals always face two competing destination states.

The last term in equation (1) captures the likelihood contribution of all spells that begin prior to January 1, 2000 conditional on observed covariates $\mathbf{X}_i(t_{i,0})$ and unobserved heterogeneity V_i . As I only estimate the transition intensities for the period $[T_{i,0}, C_i]$, it is not necessary to specify the functional form of this term. However, omitting this term would result in biased estimates, particularly estimates that refer to state dependence effects would be concerned.

4.3 Initial conditions and unobserved heterogeneity

In order to take account of this initial conditions problem, I follow Wooldridge (2005) and condition the likelihood contribution of individual i on $\mathbf{Y}_i(t_{i,0}, s_{i,0})$. Doing so eliminates the need to specify the last term of equation (1), but requires to specify the probability function of V_i conditional on $\mathbf{Y}_i(t_{i,0}, s_{i,0})$, in order to integrate out the unobserved effect V_i . Wooldridge (2005) suggests to specify the probability function of V_i conditional on $\mathbf{Y}_i(t_{i,0}, s_{i,0})$ as a parsimonious function, so that the unobserved effect V_i conditional on $\mathbf{Y}_i(t_{i,0}, s_{i,0})$ can be integrated out easily. I therefore assume V_i to be a linear function of $\mathbf{Y}_i(t_{i,0}, s_{i,0})$ and a residual random effect U_i , whose distribution is independent of everything else. This means that the last term of equation (1) vanishes. Besides, integrating out V_i conditional on $\mathbf{Y}_i(t_{i,0}, s_{i,0})$ results in integrating over the unconditional distribution of the random effect U_i and estimating some additional coefficients that refer to $\mathbf{Y}_i(t_{i,0}, s_{i,0})$, i.e. to the "initial conditions". The resulting likelihood contribution of individual i is then given by

$$\mathcal{L}(\mathbf{y}_i(t_{i,n_i}, s_{i,n_i}), c_i | \mathbf{y}_i(t_{i,0}, s_{i,0}), \mathbf{x}_i(c_i)) = \int_{-\infty}^{\infty} \mathcal{L}(\mathbf{y}_i(t_{i,n_i}, s_{i,n_i}), c_i | \mathbf{y}_i(t_{i,0}, s_{i,0}), \mathbf{x}_i(c_i), u_i) dA^*(u), \quad (4)$$

where A^* is the time-invariant marginal distribution of U_i .

The support of the unconditional distribution of U_i is assumed to take on only a small number of points. This is common practice in the literature (see Heckman and Singer (1984)) and allows one to think of the points of support as different types of persons, of which each has different characteristics with regard to the six transitions. Allowing for M types of persons, equation (4) is given by

$$\mathcal{L}(\mathbf{y}_i(t_{i,n_i}, s_{i,n_i}), c_i | \mathbf{y}_i(t_{i,0}, s_{i,0}), \mathbf{x}_i(c_i)) = \sum_{m=1}^M \mathcal{L}(\mathbf{y}_i(t_{i,n_i}, s_{i,n_i}), c_i | \mathbf{y}_i(t_{i,0}, s_{i,0}), \mathbf{x}_i(c_i), u_m) p_m, \quad (5)$$

where U_i has discrete support $\{u_1, \dots, u_M\}$ and $p_m = P(U_i = u_m)$ is the corresponding probability function.

4.4 Parametrization and estimation

In general, the transition intensities of an individual i depend on the paths of $\mathbf{X}_i(t)$ and $\mathbf{Y}_i(t, s)$. However, estimation would become impossible including the entire paths as regressors. The literature therefore suggests to specify that a random vector $X_i(t)$, which captures the contemporaneous exogenous variables that sufficiently represent the path $\mathbf{X}_i(t)$. Higher sufficiency can be achieved by including lagged variables. With regard to the endogenous variables, it can be assumed that the path $\mathbf{Y}_i(t, s)$ affects the transition intensity only by a finite-dimensional random vector $Y_i(t)$, which summarizes the information of the path $\mathbf{Y}_i(t, s)$. Furthermore, let $Y_i^*(t_0)$ be a finite-dimensional random vector that summarizes the information of the path $\mathbf{Y}_i(t_{i,0}, s_{i,0})$. I further assume that $Y_i^*(t_0)$ captures also the effects of path of observed heterogeneity $\mathbf{X}_i(t_{i,0})$ given at point $T_{i,0}$.

Following Heckman and Singer (1984) already a small number of support values suffices to model unobserved heterogeneity. In the following, the number of points of support is chosen to be $M = 3$. Different selection criteria chose the model with $M = 3$ to have the best fit. The points of support for the distribution of the unobserved effect U_i can be displayed as a $M \times 6$ random matrix

$$\begin{bmatrix} u_1^{s_E, s_U} & \dots & u_M^{s_E, s_U} \\ \vdots & \ddots & \vdots \\ u_1^{s_O, s_U} & \dots & u_M^{s_O, s_U} \end{bmatrix}, \quad (6)$$

with s_k indicating the states $k = E, U, O$. The columns can be considered as column vectors that represent the $M = 3$ types of persons and their intensity for each of the six transitions. I do not make assumptions on the location of the points of support. In particular, the correlations between the transitions are unconstrained. With $M = 3$, this results in the estimation of $3 \times 6 = 18$ parameters that relate to the support and two parameters that relate to the probability function.

Now, let $u^{\tilde{s}, s}$ denote the M -dimensional row vector representing the M points of support for the transition \tilde{s} to s . Further, let $z(v) = (\mathbf{1}(v = u_1), \dots, \mathbf{1}(v = u_M))'$ be an M -dimensional vector function indicating the support points, and let $\mathbf{1}[\cdot]$ be the indicator function. Then $z(v)'u^{\tilde{s}, s}$ is the component of the support that corresponds to the transition of type v from state \tilde{s} to state s .

Each transition is modeled as a mixed proportional hazard model. This means that a baseline transition intensity, which is only a function of time, is multiplied by a function of observed

covariates and a function of the unobserved heterogeneity. Including also the parameters that account for initial conditions ($= \delta_{\tilde{s},s}$), the transition intensity from \tilde{s} to s is given by

$$h(t, s | \mathbf{y}(\tilde{t}, \tilde{s}), \mathbf{x}(t), v) = \lambda_{\tilde{s},s}(t - \tilde{t}; \alpha_{\tilde{s},s}) \exp \left(x(t)' \beta_{\tilde{s},s} + y(\tilde{t})' \delta_{\tilde{s},s} + y^*(t_0)' \gamma_{\tilde{s},s} + z(v)' u_{\tilde{s},s} \right), \quad (7)$$

$$t \geq \tilde{s}, s \neq \tilde{s}, \text{ and } v \in \{u_1, \dots, u_M\}$$

where $\lambda_{\tilde{s},s}(t - \tilde{t}; \alpha_{\tilde{s},s})$ represents the baseline transition intensity from state \tilde{s} to state s and $\alpha_{\tilde{s},s}$, $\beta_{\tilde{s},s}$, $\delta_{\tilde{s},s}^j$, and $\gamma_{\tilde{s},s}$ are parameters to estimate. The baseline transition intensities are parameterized as piecewise constant functions

$$\lambda_{\tilde{s},s}(t - \tilde{t}; \alpha_{\tilde{s},s}) = \exp \left(\sum_{k=1}^{K_{\tilde{s},s}} \alpha_{k,\tilde{s},s} \mathbf{1}(\tau_{k-1} < t - \tilde{s} \leq \tau_k) \right), \quad (8)$$

where $\tau_0 = 0$, $\tau_{k-1} < \tau_k$ and $\tau_{K_{\tilde{s},s}} = \infty$. In order to identify the model $\alpha_{1,\tilde{s},s}$ is set to zero.

Finally, the unknown parameters $\alpha_{\tilde{s},s}$, $\beta_{\tilde{s},s}$, $\delta_{\tilde{s},s}$, and $\gamma_{\tilde{s},s}$ are estimated by the method of Maximum Likelihood using analytical first and second derivatives.

5 Results

5.1 Estimated transition intensities

Table 5 presents estimates for the econometric model described in the previous section. The three forms of state dependence are accounted by defining a specific set of covariates. First, occurrence dependence is controlled for using the type of the preceding spell, and the cumulative duration of all previous spells in the three labor market states. Lagged duration dependence is captured by including the duration of the preceding spell and the cumulative duration of all previous spells in the three labor market states. By differentiating between the occurrence and duration of the preceding spell and the occurrence and duration of all other previous spells, it is possible to distinguish, at least partially, between short-run and long-run effects. Finally, dependence on the current duration is captured by the time dummies that refer to the piecewise constant functions

of the baseline transition intensities. Effects that relate to initial conditions are measured by the cumulative number and duration of all previous spells in any of the three states given at point $T_{i,0}$. In total there are 292 parameters to estimate. The large number of parameters is due to the fact that each variable affects six transition intensities. Results are given in table 4 and reported as marginal effects, because maximum likelihood estimates cannot be interpreted directly. All results represent the change in the probability to transit to a certain state within the first year after the start of a spell⁵.

Duration dependence Figure 4 plots the baseline transition intensity curves, which capture the current duration dependence, for the six transitions. The figure displays that generally both transitions from employment exhibit negative duration dependence. Negative duration dependence is especially strong for the transition into unemployment. There are several explanations for these findings. To begin with, higher severance payments for workers with more tenure can result in increasing dismissal costs. In addition, rising opportunity costs exist, because the worker probably becomes more valuable for a firm, the longer he is employed. Finally, Germany's strict Dismissal Protection Law can yield negative duration dependence, since dismissing workers with permanent contracts is only possible under certain circumstances resulting in high dismissal costs. While workers with temporary contracts can not be dismissed, their contracts run out at specific points of time without the possibility of continuation. This often means that workers with temporary contracts end up in unemployment within two years after the start of their employment period, while workers with permanent contracts remain employed. This conjecture is supported by the finding of two slight spikes in the baseline transition intensity at one and two years. The spikes correspond to the typical durations of temporary contracts in Germany, which normally last for one or two years.

— Figure 4 about here —

The general course of the transition from unemployment to employment also exhibits negative duration dependence. The slight increase in the intensity between one and three months can be explained by the fact that even the high-skilled unemployed have to adjust to unemployment and generally do not find a job within the first month. The baseline hazard has no spikes at

⁵Following Kyyrä (2008), the marginal effects are calculated at the mean of the large set of covariates. In the case of dummy variables, effects are calculated for a representative category.

the points where the entitlement periods of unemployment benefits usually end. The negative duration dependence in unemployment is typically related to decreases in human capital or to stigmatization effects. The transition from unemployment to out of the labor force also exhibits negative duration dependence. This finding contradicts the existence of discouragement effects as proposed by Schweitzer and Smith (1974). However, the fact that there is no evidence for discouragement effects can be explained by the fact that unemployment assistance is unlimited in duration, if the unemployed remains registered as unemployed and keeps on searching for a job.

Both transition intensities from out of the labor force to employment and unemployment exhibit unclear patterns. While in the medium-run the duration dependence seems to be negative, there are strong increases in the intensity to return to the labor market at the beginning of both transitions. Such strong increases are most likely influenced by the definition of labor market states, in particular, how labor market states are identified for periods without information. The strong increase in the transition intensity for transitions to employment can also be explained by job-to-job transitions with short sabbaticals. Negative duration dependence in the medium-run for both transitions may be due to decreases in skills or motivation. The strong and significant increases of the baseline transition intensity in the long-run are again a consequence of how labor market states are defined⁶.

Occurrence dependence and lagged duration dependence For the transition from employment to unemployment, the estimates indicate that the occurrence of past unemployment experiences induce future unemployment. An individual who has been unemployed in the period before has a probability to end up in unemployment within the first year that is higher by almost 16.4 percentage points compared to an individual that has been out of labor force the period before. Furthermore, an additional unemployment experience in the past increases the probability to become unemployed by 2.0 percentage points. These effects are large and statistically significant. Interestingly, the number of past employment spells also negatively affects the current employment duration. An additional employment experience in the past increases the probability to become unemployed by 0.6 percentage points. The reason for this is that individuals, who experienced many unemployment spells, by construction of the labor market states, must also have experienced many employment spells. Finally, an additional period out of the labor force

⁶Since individuals with missing information of more than two years at the end of the observation period are dropped, all spells with more than two years of duration end up in employment or unemployment. This implies the strong and significant increase in the baseline transition intensity.

has no effect on the probability to transit from employment to unemployment. By contrast, no lagged duration dependence is found for the transition from employment to unemployment. Although some of the coefficients for lagged duration dependence are significant, the effects are rather small.

For the transition from employment to out of the labor force for individuals who were unemployed the period before, the probability to leave the labor force within the first year is reduced by 4.5 percentage points. Furthermore, additional employment and unemployment spells reduce the probability by 0.3 percentage points, while an additional spell out of the labor force increases the probability to leave the labor force by 0.7 percentage points. This means that past employment and unemployment periods increase the attachment to the labor market, even though the effects are small. On the other hand, individuals who have already spent time away from the labor market are more likely to leave the labor force again. As for the transition to unemployment, lagged duration dependence does not play a role.

For the transition from unemployment to employment, past employment spells are beneficial to become employed again. Having been employed in the preceding period increases the probability to find a job by 7.0 percentage points and an additional employment spell increases the probability by 1.7 percentage points. Similarly, past unemployment spells also increase the probability to become employed, although the effects are also often smaller. A possible explanation is that those individuals who often were employed also often were unemployed. Again, there is little evidence for lagged duration dependence. It seems that human capital gained in especially long-lasting jobs is not considered to be transferable by future employers.

In general, results indicate positive effects of past employment experiences. On first sight this finding might be related to a positive signaling or network effects due to past employment experiences. This is not entirely clear, however, as nothing can be said about the quality of the subsequent job, in particular, whether it is a temporary or a permanent one. Taking into consideration the results for the transition from employment to unemployment, the results indicate that those individuals with frequent transitions between employment and unemployment are more likely to lose their jobs again, i.e. the quality of their job matches tends to be poor. The results therefore suggest the existence of a circle of unemployment and unstable employment with exits becoming more unlikely in the presence of frequent transitions. This is consistent with a segmentation of the labor market into individuals with stable long-term employment on the one hand and individuals who frequently transit between unemployment and unstable employment on

the other hand. This finding is in line with other findings in the literature. For example, Stewart (2005) finds the existence of circles between unemployment and low-wage employment, while Boockmann and Hagen (2006) suggest the possibility that circles between unemployment and temporary employment exist.

For both transitions from out of the labor force, the type of the preceding spell is an indicator for the subsequent transition state. A preceding employment spell increases the probability to move to employment by 17.3 percentage points and decreases the probability to move to unemployment by 36.7 percentage points compared to a preceding unemployment spell. In addition, past employment spells help to return to employment, while past unemployment spells increase the probability to become unemployed and decrease the probability to become employed. This means that an increasing number of past employment and unemployment periods increase the attachment to the labor market, while past periods out of the labor force diminish this attachment. Finally, it seems that the only transition that exhibits lagged duration dependence is the transition from out of the labor force to employment. The coefficients suggest that the cumulative durations of all labor market states decrease the probability of becoming employed. The magnitude of these effects is still small, however.

Summing up, the results show that occurrence dependence is present for all transitions, while there is only little evidence for lagged duration dependence.

Personal characteristics and labor market conditions One of the key variables with strong effects on the transition intensities is the level of qualifications. As expected, a higher educational level decreases the probability to move from employment to unemployment. For example, the probability for a transition to unemployment is 8.9 percentage points lower for individuals with a vocational degree than for individuals without any educational degree. Moreover, for individuals with a university degree the probability is even 17.6 percentage points lower. The educational level does not only protect against unemployment, in addition, it helps the unemployed to find employment, although the magnitude is less strong. For example, having a vocational degree increases the probability to find a job within the first year by 5.1 percentage points. However, in comparison with a vocational degree the probabilities do only change slightly for higher educational degrees. This means that in particular unskilled individuals have difficulties in finding new employment.

Interestingly, also the probability for a transition from out of the labor force to unemployment

decreases, if the the educational level is higher. A possible reason may be that periods of self-employment or working as a lifetime civil servant can not be distinguished from real periods out of the labor force, and individuals with an educational degree more often become self-employed or lifetime civil servants⁷ than unskilled individuals. Therefore, employment periods may in some cases be erroneously assumed to be periods out of the labor force for skilled individuals, while for unskilled individuals periods out of the labor force might be extended unemployment periods but without being registered as unemployed.

The occupation only has a significant effect on the transition from employment to unemployment and vice versa. In particular, working in the sectors of engineering and the provision of services significantly decreases the probability of becoming unemployed. The probability to find a job for someone who has worked in the sector of mining is 17.8 percentage points lower than for someone who has worked in manufacturing. This strong effect is explained by the fact that the mining sector is in strong decline in Germany.

Further personal characteristics like age or nationality also play a role for some transitions. Foreigners have a lower probability to move from employment to unemployment, but also a lower probability to move from unemployment to employment. However, these effects are small. The effect of age on all transitions is negligible, because most coefficients are insignificant and very small if significant. This result is probably due to the fact that the estimation sample is homogenous with respect to the age of the individuals.

In addition to personal characteristics, the current labor market situation and the state of the economy have strong effects on labor market outcomes. Current unemployment rates have the expected effects. For example, an increase in the unemployment rate by one percentage point results in an increase in the probability to move from employment to unemployment by 3.3 percentage points. For the opposite transition, the probability decreases by 3.5 percentage points. Moreover, the probability of returning to employment from out of the labor force is significantly smaller if unemployment is high. Besides, the probability to lose one's job is significantly higher in regions with bad labor market conditions, while the probability to find a job is significantly lower in these regions. Coefficients for business cycle effects also provide expected results. For example, an increase in GDP-growth by one percentage point increases the probability to find a job by 3.7 percentage points. Summing up, it seems that, in particular, the transitions between employment and unemployment and vice versa exhibit a pro-cyclical behavior.

⁷In Germany only individuals, who have at least passed a vocational training can become a lifetime civil servant.

Unobserved heterogeneity Table 5 presents results for the maximum likelihood coefficients, which include the coefficients for the distribution of unobserved heterogeneity. As already mentioned, the values of support can be considered as types of persons, who differ in their transition behavior. All values of support and the probabilities are statistically significant. The first and the third type are the most frequent ones (42.2% and 37.0%). The transition behaviors of these two types are also similar for the transitions from employment to unemployment and to out of the labor force, and from unemployment to out of the labor force. Both types have a low probability for transition from employment. However, the first type has a higher probability to move from unemployment to employment and also from out of the labor force to employment. Therefore, the first type can be considered as the type with the best unobserved characteristics with regard to employment. The third type has, as mentioned, a low probability to move from employment, but also a lower probability to find employment when unemployed or being out of the labor force. Finally, the second type has a high probability to move from employment to unemployment and out of the labor force, and a low probability to become employed when unemployed or being out of the labor force. The second type can therefore be considered as the type with the worst unobserved characteristics with regard to employment chances.

5.2 Model fit

In this section, I check the how well the model fits the main characteristics of the data. In order to verify the fit of the estimated model, no simple test is available. Rather, employment histories have to be simulated and then compared to the original data. For the given sample of individuals, I conduct the simulations dynamically from the beginning of their first spell after January 1, 2000 until the end of the observational period. The state of the first spell is given by the original data. For the simulations, a given set of exogenous and lagged endogenous explanatory variables is used. In a first step, I assign each individual in the sample a value of the random effect, i.e. I determine of which type the individual is. The values of the random effect are drawn from the estimated distribution of unobserved heterogeneity.

The second step is to assign to each individual its transition times and destination states. Given the set of exogenous and lagged endogenous explanatory variables, the random effect, and the estimated model, I draw the transition times for each individual from the distribution function of transition times. The destination states are then determined using the hazard ratios of the respective destination states. After a transition has taken place, the employment history is

updated to reflect the type and duration of the first spell. Then, for the second spell transition times and destination states are assigned using the updated history. This process is repeated until the end of the observation period. The resulting data set is a random history, which is compatible with the exogenous and endogenous explanatory variables. Finally, the simulation results are averaged over the distribution of unobserved heterogeneity. The result of this exercise is then compared to the raw data.

In order to assess the model fit, ten histories are simulated for each individual in the sample. Table 6 presents summary statistics for both the simulated data and raw data. As one can see, the model fits the data relatively well for short and medium duration. In general, it tends to slightly overestimate employment durations at all quantiles and underestimate durations for spells in unemployment and out of the labor force. Figure 5 plots the simulated and empirical survivor functions for each state. Again, one can see that model fits well for short and medium durations, while particularly for the 80% and 90%-quantile the employment durations tend to be overestimated.

6 Simulation of policy interventions

Medium and long-run effects of policy interventions can differ markedly from short-term impacts in the presence of occurrence dependence. Nonetheless, evaluation of policy interventions often only looks at short-run effects. The present simulation study therefore accounts for such medium and long-run effects by simulating the effects of interventions that force transitions between labor market states at certain times in an individual's history.

Because the focus is on state dependence effects, the interventions are simulated for representative persons living in a stationary environment. I therefore fix unemployment rates and GDP growth rates at their mean value. Furthermore, simulations are conducted for individuals who have a vocational training degree and who work in the manufacturing sector. The representative individual is born between 1958 and 1962, German and lives in a highly urbanized region with high unemployment rate in the western part of Germany.

I differentiate between interventions for two groups. The first group consists of individuals who were unemployed for more than three years between 1992 and 1999 and who have been unemployed for more than three months, but less than two years on January 1, 2000, i.e. the group

can be considered as one of long-term unemployed. The second group consists of individuals who were employed for more than three years between 1992 and 1999, and who have been employed for more than half a year, but less than three years on January 1, 2000. The fraction of individuals varies between the two groups and the final sample for which simulations are conducted consists of 10.000 individuals.

The simulated interventions are presented graphically as the proportions of individuals in each state, measured on daily-basis. The graphs show the difference between the proportions of the treatment and the control group, that means for example the employment rate of the treatment group minus the employment rate of the control group.

Figure 6 shows the intervention of a 30 day employment period for the group of unemployed, i.e. the treatment group experiences a 30 day employment spell from January 1, 2000 until January 31, 2000 and is then again set to unemployment. During the 30 day employment period transitions to other states are prohibited. After the employment experience the labor market history of the individual is updated in order to reflect the additional spell in unemployment. The simulations therefore display the effect of the occurrence of a 30 day employment. The intervention can be thought of a form of temporary employment. The results show that in the treatment group the employment period the unemployment rate is higher and the employment rate lower immediately after the treatment has ended. However, the situation turns round after further six months and in the long run the 30 day employment period leads to an increase in the employment rate and a decrease in the unemployment rate by around 14 percentage points, while nonparticipation is more or less unaffected. An intervention of this type may therefore help to reduce the unemployment rate, and the effects are strong even for such a short period.

— Figure 6 about here —

Figure 7 presents the intervention of a 180 day employment period, again for the same group of unemployed. The simulations are conducted as above, except for a now longer employment period. In the long run results show that the 180 day employment period leads to an increase in the employment rate and a decrease in the unemployment rate by 13 and 14 percentage points. Therefore, results do practically not differ from the 30 day employment period. This reflects the absence of lagged duration dependence in the data. One has to note that the simulated intervention does not take into account direct transitions to regular employment, which are an important way for unemployed to find stable employment (see Boockmann and Hagen, 2006). For

the intervention investigated, the results generally imply that an additional employment experience leads to an increase in the employment rate and a decrease in the unemployment rate and that the effects are quite strong. However, nothing can be said about the quality of the subsequent jobs.

— Figure 7 about here —

I also conduct simulations for the group of employed. Figure 8 shows the intervention of a 30 day unemployment period for the group of employed, i.e. the treatment group experiences a 30 day unemployment spell from January 1, 2000 until January 31, 2000 and is then again set to employment. Again no transitions are allowed to take place during the treatment period. A possible motivation for this kind of intervention is as follows. While the treatment and control group consist of individuals who are about to be affected by a (mass) lay-off, the control group receives a direct treatment and remains in employment and the treatment group receives the treatment only after a 30 day unemployment period. The long-run results show that this additional employment period leads to a decrease in the employment rate by around ten percentage points, while it increases the unemployment ratio by also ten percentage points. This means that even a 30 day unemployment period has strong scarring effects.

— Figure 8 about here —

In order to measure whether the duration of an unemployment period plays a role, I simulate a 180 day unemployment period. The corresponding results are given in Figure 9. As can be seen directly, there is hardly any difference in the rates of each state between the 30 and 180 day unemployment intervention, which again reflects the lack of lagged duration dependence. Since even short unemployment spells seem to have severe scarring effects, the results suggest labor market policies that help employed, who are at the risk to become unemployed, before they become unemployed.

— Figure 9 about here —

Summing up, the simulated interventions show that scarring effects due to past unemployment exist and are induced even by short unemployment periods. Furthermore, additional employment

experiences seem to help in bringing down the unemployment rate. Finally, the effects for all interventions are very strong and they do hardly differ for the varying durations. The simulation results therefore also conform the absence of lagged duration dependence and the strong duration dependence of unemployment and employment.

7 Conclusion

This paper investigated the form and magnitude of state dependence effects for prime-aged men in Germany. The empirical results can be summarized as follows. They show that employment is strongly duration dependent, which is most likely related to institutional features, in particular dismissal protection and the possibility for temporary contracts. The opposite transition is also duration dependent. The results also indicate that there is occurrence dependence. Past employment spells help the unemployed to find new employment, while past unemployment spells are scarring and increase the probability to become unemployed again. This may result in a circle of unemployment and unstable employment from which an exit becomes the more unlikely the more frequent the transitions between unemployment and employment were in the past. An important finding is that lagged duration dependence does not seem to influence the transitions, while occurrence dependence does. In addition to the results from occurrence dependence, this means that past employment spells are beneficial and help to find new employment, no matter how long the employment spells were. However, this also means that even short unemployment spells are scarring. The effects found also persist over time. Nonetheless, the preceding state plays an important role and strongly determines the transition times and destinations states, and implies that recent labor market outcomes have stronger effects than outcomes occurred earlier.

Simulating policy interventions provides evidence that even very short unemployment spells have severe scarring effects. The effects of unemployment spells with longer durations do not differ much from this finding. As already rather short unemployment spells have scarring effects, these results suggest to implement labor market policies that help those employed to find a new job, who are at the risk to become unemployed. Furthermore, the simulated interventions show that past employment experience strongly help to find new employment. Also for this simulation, the results imply that the duration of the intervention is not important. For labor market policies this implies that in order to find new employment, short employment periods in the past are as beneficial as longer ones. However, it is not clear whether the newly found jobs are stable ones.

The clear evidence for the different forms of state dependence also suggests that omitting variables that refer to past labor market history (occurrence and lagged duration dependence) may lead to biases in estimates that relate to duration dependence or to certain policy measures. In comparison to other papers, the results also imply that in order to analyze state dependence effects it is important to differentiate between the certain forms of state dependence and it does not suffice to condition only on the pre-period state. In particular, only by taking the different forms of state dependence into account, one can detect a vicious circle between unstable employment and unemployment.

8 References

Abbring, J. and G. van den Berg (2003): The identifiability of the mixed proportional hazards competing risks model, *Journal of the Royal Statistical Society: Series B (Statistical Methodology)* 65, pp. 701-710.

Arulampalam, W. (2001): Is unemployment really scarring? Effects of unemployment experiences on wages, *Economic Journal* 111, pp. 585-606.

Arulampalam, W., A. Booth, and M.P. Taylor (2000): Unemployment persistence, *Oxford Economic Papers* 52, pp. 24-50.

Arulampalam, W., P. Gregg and M. Gregory (2001): Unemployment scarring, *Economic Journal* 111, pp. 577-584.

van den Berg, G. (2001): Duration Models: Specification, Identification and Multiple Durations, *Handbooks in Econometrics, Vol. 5*.

Bernhard, S., C. Dressel, B. Fitzenberger, D. Schnitzlein and G. Stephan (2006): Overlapping spells in the IEBS: descriptives and interpretation, FDZ Methodenreport No. 200604, Institute for Employment Research, Nuremberg.

Biewen, M., B. Fitzenberger, A. Osikominu, and M. Waller (2007): Which program for whom? Evidence on the comparative effectiveness of public sponsored training programs in Germany, IZA Discussion Paper No. 2885, Institute for the Study of Labor, Bonn.

Biewen, M. and S. Steffes (2010): Unemployment persistence: Is there evidence for stigma effects?, *Economics Letters* 106, pp. 188-190.

Blanchard, O.J. and P. Diamond (1994): Ranking, Unemployment Duration, and Wages, *Review of Economic Studies* 61, pp. 417-434.

Blien, U. and F. Hirschenauer (2005): Welche Arbeitsagenturen sind vergleichbar?, IAB Kurzbericht No. 18, Institute for Employment Research, Nuremberg.

Boockmann, B. and T. Hagen (2006): Befristete Beschäftigungsverhältnisse - Brücken in den Arbeitsmarkt oder Instrumente der Segmentierung?, ZEW Wirtschaftsanalysen No. 80, Baden-Baden.

Bundesagentur für Arbeit (1988): Klassifizierung der Berufe, Federal Employment Agency, Nuremberg.

Bundesagentur für Arbeit (2009): Sondernummer der Amtlichen Nachrichten der Bundesagentur für Arbeit: Arbeitsmarkt 2009, Federal Employment Agency, Nuremberg.

Cockx, B. and M. Picchio (2010): Are Short-Lived Jobs Stepping Stones to Long-Lasting Jobs?, Discussion Paper 2010-95, Center for Economic Research, Tilburg University.

D'Addio, A.C. and M. Rosholm (2002a): Left-Censoring in Duration Data: Theory and Applications, Working Paper 2002-5, School of Economics and Management, University of Aarhus.

D'Addio, A.C. and M. Rosholm (2002b): Labour Market Transitions of French Youth, Working Paper 2002-14, School of Economics and Management, University of Aarhus.

Doiron, D and T. Gorgens (2008): State Dependence in Youth Labor Market Experiences, and the Evaluation of Policy Interventions, *Journal of Econometrics* 145, pp. 81 - 97.

Dolton, P. and J. Smith (2011): The Impact of the UK New Deal for Lone Parents on Benefit Receipt, IZA Discussion Papers No. 5491, Institute for the Study of Labor, Bonn.

Ehrenberg, R.G. and R.L. Oaxaca (1976): Unemployment Insurance, Duration of Unemployment, and Subsequent Wage Gain, *American Economic Review* 66, pp. 754-766.

Fitzenberger, B., A. Osikominu and R. Völter (2007): Get Training or Wait? Long Run Employment Effects of training Programs for the Unemployed in West Germany, *Annales d'Economie et de Statistique* 91-92, pp. 321-355.

Fitzenberger, B., A. Osikominu and R. Völter (2006): Imputation rules to improve the education variable in the IAB employment subsample, *Journal of Applied Social Sciences* 126, pp. 405 - 436.

Fitzenberger, B. and R. Völter (2007): Long-Run Effects of Training Programs for the Unemployed in East Germany, *Labour Economics* 14, pp. 730-755.

Fitzenberger, B. and R.A. Wilke (2010): Unemployment Durations in West Germany before and after the Reform of the Unemployment Compensation System during the 1980s, *German Economic Review* 11, pp. 336-366.

Flaig, G., G. Licht, and V. Steiner (1993): Testing for State Dependence Effects in a Dynamic Model of Male Unemployment Behaviour in (H. Bunzel, P.Jensen, and N. Westergard-Nielsen, eds), *Panel Data and Labour Market Dynamics*, Amsterdam: Elsevier Science.

Gibbons, R. and L.F. Katz (1991): Layoffs and Lemons, *Journal of Labor Economics* 9, pp. 351 - 379

Gregg, P. (2001): The Impact of Unemployment on Adult Unemployment in the NCDS, *Economic Journal* 111, pp. 626 - 653.

Gritz, M.R. (1993): The Impact of Training on the Frequency and Duration of Employment, *Journal of Econometrics* 57, pp. 21 - 51.

Hall, R.E. (2005): Employment efficiency and sticky wages: Evidence from flows in the labor market. *The Review of Economics and Statistics* 87, pp. 397 - 408.

Ham, J.C. and R. J. LaLonde (1996): The Effect of Sample Selection and Initial Conditions in Duration Models: Evidence from Experimental Data on Training, *Econometrica* 64, pp. 175 - 205.

Heckman, J.J. and G.J. Borjas (1980): Does Unemployment Cause Future Unemployment? Definitions, Questions and Answers from a Continuous Time Model of Heterogeneity and State Dependence, *Economica* 47, pp. 247 - 283.

Heckman, J.J., R.J. Lalonde and J.A. Smith (1999): The economics and econometrics of active labor market policy. *Handbook of Labor Economics*, Vol. 3

Ioannides, Y.M. and L.D. Lounsbury (2004): Job Information Networks, Neighborhood Effects, and Inequality, *Journal of Economic Literature* 42, pp. 1056 - 1093.

Jaenichen, U., T. Kruppe, G. Stephan, B. Ullrich and F. Weißner (2005): You can split it if you really want, FDZ Datenreport No. 4, Institute for Employment Research, Nuremberg.

Kyyrä, T. (2009): Marginal Effects for Competing Risks Models with Piecewise Constant Hazards, *Oxford Bulletin of Economics and Statistics*, 71, pp. 539 - 565.

Ljungqvist, L. and T. Sargent (1998): The European Unemployment Dilemma, *Journal of Political Economy* 106, pp. 514-550.

Lockwood, B. (1991): Information Externalities in the Labour Market and the duration of Unemployment, *Review of Economic Studies*, 58, pp. 733-753.

Magnac, Thierry (2000): Subsidised Training and Youth Employment: Distinguishing Unobserved Heterogeneity from State Dependence in Labour Market Histories, *Economic Journal* 110, pp. 805 - 837.

Mühleisen, M. and K. Zimmermann (1994): New Patterns of Labour Mobility: A panel analysis of job changes and unemployment, *European Economic Review* 38, pp. 793-801.

Pissarides, C.A. (1992): Loss of Skill during Unemployment and the Persistence of Employment Shocks, *Quarterly Journal of Economics* 107, pp. 1371 - 1391.

Schweitzer, S.O. and R.E. Smith (1974): The Persistence of the Discouraged Worker Effect, *Industrial and Labor Relations Review*, 27 pp. 249 - 260.

Vishwanath, T. (1989): Job Search, Stigma Effect, and Escape Rate from Unemployment, *Journal of Labor Economics* 7, pp. 487 - 502.

Winter-Ebmer, R. and J. Zweimüller (1992): Do They Come Back Again? Job Search, Labour Market Segmentation and State Dependence as Explanations of Repeat Unemployment, *Empirical Economics* 17, pp. 273 - 292.

Wooldridge, J.M. (2005): Simple Solutions to the Initial Conditions Problem in Dynamic, Nonlinear Panel Data Models with Unobserved Heterogeneity, *Journal of Applied Econometrics*, 20, pp. 39 - 54.

A Institutional Framework

The design of the unemployment compensation system is an aspect that affects labor market outcomes and which may be particularly relevant for the current unemployment duration (see for example Chetty, 2008 or Tatsimaras, 2010). For the period from 1998 to 2004, the German unemployment insurance system consisted of two components, unemployment benefits ("Arbeitslosengeld") and unemployment assistance ("Arbeitslosenhilfe"). The Hartz reforms in 2005 abolished the unemployment assistance. There are now two new components of the unemployment compensation system, ALG I and ALG II. ALG I is similar to unemployment benefits, although replacement ratios and entitlement periods have changed. ALG II combines unemployment assistance and social assistance. For the present study, only unemployment benefits as well as the former unemployment assistance and the former social assistance are relevant.

Unemployment benefits are insurance benefits with a limited entitlement period. To become eligible, the claimant first has to be registered as unemployed at his local Employment Agency. Being registered as unemployed requires that the individual is actively searching for a job of at least 15 hours a week and is available on short notice for a suitable job or a training measure. Furthermore, to receive unemployment benefits, a claimant has to be employed subject to social contributions for at least twelve months within the last two years prior to the unemployment spell. The level of unemployment benefits is calculated based on the average gross daily income over the last twelve months net of income taxes and further contributions. This amount is then multiplied by the replacement ratio, which is 67% for unemployed with dependent children and 60% without. Finally, the length of the benefit entitlement is a function that depends positively on the number of months worked prior to the unemployment spell and on the unemployed's age at the beginning of the spell.

Individuals receiving unemployment assistance have either exhausted the maximum length of unemployment benefits or they were never eligible for unemployment benefits, because they did not fulfill the minimum requirement of employment subject to social security contributions. Unemployment assistance was tax-funded and required the unemployed to pass a means-test. It was further unlimited in time and the replacement ratios were lower than in the case of unemployment benefits (57% with and 53% without children). Individuals receiving unemployment assistance were mostly long-term unemployed and therefore the suitability criteria what job the unemployed had to accept, were somewhat stricter than in the case of unemployment benefits.

Unemployment benefits and unemployment assistance both allowed the unemployed to work for up to 15 hours per week. The level of the entitlement was adjusted in these cases, depending on the income from the additional employment.

In distinction to unemployment benefits and unemployment assistance, the social assistance ("Sozialhilfe") provided a basic income protection for all individuals residing in Germany independent of their current labor market status. It was also paid as an additional income support, if the level of unemployment assistance was below some critical value. Hence, one could assume an at least marginal influence of the level of social assistance on labor market outcomes, especially for transitions from out of the labor force. Nonetheless, the level of social assistance only changed marginally during the period under consideration, so that the fact that the data does not contain information on social assistance is not a major problem.

A further institutional feature that affects unemployment and employment durations are Active Labor Market Policies (ALMPs). Such ALMPs usually provide a diverse set of measures with the goal to bring back unemployed into permanent employment. The set of ALMPs during the period from 1997 until 2003 comprised job-creation measures ("Arbeitsbeschaffungsmaßnahmen") and settling-in allowances ("Eingliederungszuschuss"), which were forms of employment subsidies. In addition, the unemployed received financial support when they tried to become self-employed ("Existenzgründerzuschuss"). Lastly, a broad set of training measures existed that ranged from activation measures or German language courses to vocational training. Individuals, that are registered as unemployed, may receive maintenance allowance ("Unterhaltsgeld") while participating in a public sponsored training measure.

Finally, protection against dismissal has clear effects on the employment duration, but it is also assumed that it indirectly affects unemployment duration by constraining unemployed, especially older ones, in their return to employment. The Dismissal Protection Law protected employees with permanent contracts in Germany against unfair dismissal, who had been employed for more than six months. It was further only related to firms with more than five employees⁸. Although the law allowed for dismissals due to personal, behavioral, or operational reasons, it protected employees against unfair dismissal and acted as a counterbalance to a hire-and-fire policy. However, firms had the possibility to employ workers on temporary contracts in order to adjust to short-run labor demand fluctuations. The maximum duration of temporary employment is two years⁹ and

⁸For the period from 1996 to 1998, the minimum size is ten employees.

⁹There were a number of sectors, where the maximum duration was up to six or more years, e.g. academia

a subsequent contract at the same firm has to be permanent. Temporary employment was introduced to allow firms to adjust their labor force more flexibly, but also to provide bridges to permanent employment for the unemployed.

B Covariates

Estimation is conducted using a large set of explanatory variables. These represent personal characteristics as well as external factors. Most of the covariates are time-varying. The following sub-section provides a short overview of the covariates used.

Age As only the year of birth is known, age is measured on a yearly basis and changes for every year on January 1. In order to account for nonlinearities, I additionally use squared age.

Education The level of education is one of the most important variables to include, as it is an indicator for the level of human capital. However, the education variable is not available for the LeH and not reliable for the BeH. In order to account for these points, some adjustments have to be made and the variable has to be imputed for periods with information from the LeH¹⁰. The resulting variable displays whether the individual has no degree, has passed a vocational training, finished high school, finished high school and additionally passed a vocational training, has a degree from a technical college, or a university degree.

Occupation Controlling for the individual's occupation is important, because labor market conditions differ by occupation. I therefore use a categorical variable indicating groups of occupations by a two-digit index¹¹ and construct six dummy-variable using only the first digit. The resulting variable differentiates between manufacturing, farming, mining, engineering, service, and miscellaneous occupations.

¹⁰Like most studies dealing with the IEBS or IABS, I follow the approach by Fitzenberger et al. (2005). I thank Aderonke Osikominu for generously providing their code.

¹¹See Bundesanstalt für Arbeit (1988).

Nationality I also use a dummy variable that indicates whether or not the individual is a German.

Labor market conditions In order to control for local labor market conditions, I use a set of dummy variables, that are generated from a categorical variable, which categorizes regional labor market conditions into five different groups¹². The five categories are: Regions in Eastern Germany with an overbearing shortcoming in employment, highly urbanized regions in Western Germany with a high unemployment rate, more rural regions in Western Germany with an average unemployment rate, highly dynamical centers with favorable labor market conditions, and highly dynamical regions in Western Germany with good labor market conditions.

The overall labor market conditions are captured by monthly unemployment rates, which are made available by the Federal Employment Agency. Moreover, I use quarterly GDP growth rates published from the Federal Statistical Office to account for business cycle effects.

¹²See Blien and Hirschenauer (2005).

C Tables

Table 1 – Transitions across years

Transition	1992	1993	1994	1995	1996	1997	1998	1999	2000	2001	2002	2003	Total
E → U	14,232	17,970	15,688	16,574	20,658	21,062	18,864	18,985	19,275	19,631	20,023	20,826	223,788
E → O	7,102	6,643	7,746	7,656	7,054	5,705	5,601	6,571	4,344	5,324	6,507	5,030	75,283
U → E	10,196	15,613	16,939	15,381	17,818	19,978	19,768	19,834	18,939	17,387	16,823	17,645	206,321
U → O	2,135	3,698	4,978	4,499	4,451	4,476	4,568	3,591	3,486	3,530	4,482	4,296	48,190
O → E	16,216	9,922	6,538	8,391	6,123	6,164	8,040	6,362	6,695	4,740	5,034	4,713	88,938
O → U	1,044	2,988	3,422	4,124	4,209	4,120	4,864	4,035	3,712	3,884	4,287	4,095	44,784
Total	50,925	56,834	55,311	56,625	60,313	61,505	61,705	59,378	56,451	54,496	57,156	56,605	687,304

Table 2 – Data overview

	<i>Origin state</i>			Total
	E	U	O	
<i>Number of histories starting after 01/01/2000</i>				
Total				69,820
<i>Time under observation (days)</i>				
Average per person	532.88	316.64	119.82	969.34
Per cent	54.97	32.67	12.36	100.00
Maximum history length				1460
<i>Number of spells</i>				
Total	91,977	95,733	36,999	224,709
Right-censored	35,788	25,662	8,370	69,820
Uncensored	56,189	70,071	28,629	154,889
<i>Destination state</i>				
E	0	58,105	14,991	
U	48,472	0	13,638	
O	7,717	11,966	0	
<i>Incidence rate (exits per year)</i>				
Total	0.55	1.16	1.25	
<i>Destination state</i>				
E	0	0.96	0.65	
U	0.48	0	0.60	
O	0.07	0.20	0	
<i>Duration quantiles (days)</i>				
10%	45	27	40	
20%	103	53	60	
30%	181	79	91	
40%	257	108	123	
50%	337	152	183	
60%	539	223	274	
70%	965	347	364	
80%		576	470	
90%		1198	744	

E: Employment, U: Unemployment, O: Out of labor force. *Notes:* Quantiles are based on the Kaplan-Meier product limit estimator. The 80th and 90th percentile are not identified due to right-censoring.

Table 3 – Explanatory Variables

<i>Explanatory variable</i>	<i>Date</i>	<i>Mean</i>	<i>Standard deviation</i>
<i>Age</i>	January 1, 2000	38.94	5.88
	last spell	41.86	5.93
<i>Occupation</i>	last spell		
Farming		0.041	0.199
Mining		0.003	0.058
Manufacturing		0.477	0.499
Engineering		0.057	0.232
Service		0.413	0.492
Miscellaneous		0.009	0.093
<i>Education</i>	last spell		
No degree		0.188	0.391
Vocational Training		0.676	0.468
High School		0.008	0.091
High School + Vocational Training		0.039	0.193
Technical College		0.028	0.166
University Degree		0.060	0.238

Table 4 – Marginal Effects

	<i>Transitions</i>					
	<i>E → U</i>	<i>E → O</i>	<i>U → E</i>	<i>U → O</i>	<i>O → E</i>	<i>O → U</i>
State dependence:						
Occurrence dependence						
<i>Previous spell (base: preceding O spell)</i>						
Preceding E spell			0.070*** (0.015)	0.062*** (0.014)	0.173*** (0.019)	-0.367*** (0.014)
Preceding U spell	0.164*** (0.019)	-0.045*** (0.006)				
<i>Cumulative number of previous spells</i>						
Previous cum. E spells	0.006** (0.003)	-0.003** (0.001)	0.017*** (0.003)	-0.011*** (0.002)	0.027*** (0.005)	0.008 (0.005)
Previous cum. U spells	0.020*** (0.003)	-0.003*** (0.001)	0.008*** (0.003)	0.005*** (0.002)	-0.018*** (0.005)	0.030*** (0.006)
Previous cum. O spells	-0.003 (0.004)	0.007*** (0.002)	-0.011** (0.004)	0.014*** (0.003)	0.006 (0.005)	-0.040*** (0.007)
Lagged duration dependence						
<i>Duration of preceding spell</i>						
Preceding E duration			-0.001*** (0.000)	0.000*** (0.000)	0.000 (0.000)	-0.003*** (0.001)
Preceding U duration	0.001*** (0.000)	-0.000** (0.000)			-0.005*** (0.000)	0.001*** (0.000)
Preceding O duration	-0.003*** (0.000)	-0.000** (0.000)	0.001 (0.000)	-0.000* (0.000)		
<i>Cumulative duration of previous spells (measured in months)</i>						
Previous cum. E duration	-0.000 (0.000)	-0.000 (0.000)	-0.002*** (0.000)	0.000 (0.000)	-0.004*** (0.001)	0.002** (0.001)
Previous cum. U duration	0.000 (0.000)	-0.000* (0.000)	-0.004*** (0.001)	-0.000 (0.000)	-0.005*** (0.001)	-0.002** (0.001)
Previous cum. O duration	-0.003*** (0.001)	-0.001*** (0.000)	-0.002*** (0.001)	0.000 (0.000)	-0.005*** (0.001)	0.002 (0.001)
Personal characteristics						
<i>Age structure</i>						
Age	0.001 (0.002)	-0.002*** (0.000)	-0.002 (0.002)	-0.002* (0.001)	-0.007** (0.003)	0.011*** (0.003)
<i>Nationality (base: German)</i>						
Foreigner	-0.025*** (0.005)	0.004*** (0.002)	-0.019*** (0.006)	-0.001 (0.003)	0.018*** (0.006)	-0.008 (0.008)

Table 4 – (continued)

	<i>Transitions</i>					
	E → U	E → O	U → E	U → O	O → E	O → U
<i>Occupation (base: manufacturing)</i>						
Farming	0.016** (0.007)	-0.006 (0.004)	-0.004 (0.010)	-0.004 (0.005)	-0.044** (0.017)	-0.007 (0.017)
Mining	-0.038 (0.036)	0.004 (0.013)	-0.178*** (0.051)	0.020 (0.023)	0.046 (0.050)	-0.037 (0.041)
Engineering	-0.095*** (0.016)	-0.001 (0.003)	-0.019 (0.013)	-0.016** (0.007)	-0.006 (0.011)	-0.033* (0.019)
Service	-0.055*** (0.008)	0.005* (0.003)	-0.013*** (0.005)	0.001 (0.003)	0.005 (0.006)	-0.016** (0.008)
Miscellaneous	0.000 (0.017)	0.019** (0.009)	-0.044 (0.029)	-0.021* (0.012)	-0.034 (0.022)	-0.047 (0.032)
<i>Education (base: no degree)</i>						
Voc. Train.	-0.089*** (0.009)	-0.001 (0.001)	0.051*** (0.005)	-0.006*** (0.002)	-0.001 (0.005)	-0.058*** (0.007)
HS degree	-0.081** (0.019)	0.012** (0.006)	0.007 (0.025)	-0.009 (0.009)	-0.017* (0.014)	-0.101*** (0.020)
HS + VT	-0.145*** (0.016)	-0.000 (0.003)	0.060*** (0.010)	-0.001 (0.005)	-0.015 (0.010)	-0.108*** (0.014)
Tech. College	-0.160*** (0.018)	-0.010*** (0.003)	0.079*** (0.012)	-0.016 (0.006)	-0.017 (0.011)	-0.116*** (0.017)
Uni. degree	-0.176*** (0.019)	-0.008*** (0.002)	0.060*** (0.010)	-0.012** (0.005)	-0.055*** (0.010)	-0.168*** (0.014)
<i>Environmental characteristics</i>						
<i>Business cycle</i>						
Lagged GDP growth	-0.002 (0.002)	-0.011*** (0.002)	0.037*** (0.003)	-0.020*** (0.003)	-0.015*** (0.005)	0.002 (0.004)
<i>Labor market situation in Germany (dynamic)</i>						
Unemployment rate	0.033*** (0.003)	-0.008*** (0.001)	-0.035*** (0.003)	-0.002 (0.002)	-0.069*** (0.007)	-0.003 (0.004)
<i>Regional labor market situation in Germany (static, base: West, hi. dyn. regions + good LM-cond.)</i>						
East, shortcoming in employment	0.096*** (0.012)	-0.006** (0.003)	-0.060*** (0.008)	-0.025*** (0.006)	-0.044*** (0.011)	0.070*** (0.013)
West, hi. urbanized + hi. U-rate	0.038*** (0.008)	0.005* (0.002)	-0.092*** (0.009)	-0.006 (0.004)	-0.008 (0.008)	0.035*** (0.013)
West, more rural + avg. U-rate	0.014** (0.006)	-0.004* (0.002)	-0.032*** (0.007)	-0.009** (0.004)	-0.010 (0.008)	0.002 (0.011)
West, hi. dyn. centers + g. LMC	0.010 (0.009)	0.006 (0.004)	-0.039*** (0.011)	0.005 (0.005)	0.004 (0.011)	-0.018 (0.015)

Marginal effects are given at the mean of X . Standard errors in parentheses. Significance on 10%, 5% and 1%-level is indicated by *, ** and ***.

Table 5 – Model coefficients

	<i>Transitions</i>					
	E → U	E → O	U → E	U → O	O → E	O → U
<i>Duration dependence</i>						
<i>Elapsed Duration (base: elapsed 0-29 days)</i>						
Elapsed 30-91	-0.240*** (0.013)	-0.232*** (0.031)	0.087*** (0.010)	0.001 (0.027)	0.699*** (0.020)	0.233*** (0.020)
Elapsed 91-182	-0.296*** (0.017)	-0.403*** (0.039)	0.009 (0.017)	-0.014 (0.032)	0.010 (0.030)	0.198*** (0.034)
Elapsed 183-364	0.039** (0.020)	-0.399*** (0.043)	-0.410*** (0.023)	-0.236*** (0.035)	0.184*** (0.028)	-0.093** (0.043)
Elapsed 365-546	-0.760*** (0.025)	-0.513*** (0.053)	-0.634*** (0.032)	-0.297*** (0.043)	-0.073 (0.047)	-0.269*** (0.053)
Elapsed 547-729	-0.635*** (0.027)	-0.588*** (0.063)	-0.753*** (0.040)	-0.383*** (0.053)	-0.210*** (0.059)	-0.151** (0.064)
Elapsed 730-1094	-1.226*** (0.031)	-0.796*** (0.073)	-0.963*** (0.048)	-0.523*** (0.062)	0.942*** (0.074)	0.795*** (0.082)
Elapsed 1095-1460	-1.610*** (0.053)	-1.279*** (0.119)	-1.183*** (0.089)	-0.667*** (0.116)		
<i>Occurrence dependence</i>						
<i>Previous spell (base: other type of spell)</i>						
Preceding E spell			0.316*** (0.032)	-0.663*** (0.041)	0.527*** (0.055)	-1.155*** (0.088)
Preceding U spell	0.921*** (0.032)	-0.738*** (0.054)				
<i>Cumulative number of previous spells</i>						
Previous cum. E spells	0.021* (0.011)	-0.066*** (0.025)	0.041*** (0.010)	-0.106*** (0.015)	0.126*** (0.020)	0.087*** (0.025)
Previous cum. U spells	0.085*** (0.011)	-0.075*** (0.026)	0.045*** (0.011)	0.073*** (0.017)	-0.074*** (0.022)	0.139*** (0.024)
Previous cum. O spells	-0.002 (0.017)	0.201*** (0.031)	-0.001 (0.015)	0.154*** (0.020)	0.020 (0.023)	-0.208*** (0.030)
<i>Lagged duration dependence</i>						
<i>Duration of previous spell (measured in months)</i>						
Preceding duration	-0.013*** (0.002)	-0.007*** (0.002)	0.002 (0.002)	-0.003 (0.002)	-0.025*** (0.003)	-0.002 (0.001)
Preceding E duration			-0.004** (0.002)	0.003 (0.002)	0.025*** (0.003)	-0.011*** (0.002)
Preceding U duration	0.008*** (0.002)	-0.001 (0.003)				
<i>Cumulative duration of previous spells (measured in months)</i>						
Previous cum. E duration	-0.001 (0.002)	-0.005 (0.004)	-0.009*** (0.002)	-0.001 (0.003)	-0.017*** (0.004)	0.004 (0.004)
Previous cum. U duration	0.000 (0.002)	-0.010* (0.005)	-0.018*** (0.002)	-0.012*** (0.004)	-0.023*** (0.004)	-0.019*** (0.004)
Previous cum. O duration	-0.015*** (0.003)	-0.026*** (0.005)	-0.009*** (0.002)	-0.001 (0.004)	-0.207*** (0.005)	0.001 (0.005)

Table 5 – (continued)

	<i>Transitions</i>					
	E → U	E → O	U → E	U → O	O → E	O → U
Personal characteristics						
<i>Age structure</i>						
Age	-0.008 (0.014)	-0.114*** (0.012)	-0.007 (0.013)	-0.055** (0.024)	-0.043* (0.023)	0.082*** (0.030)
Age ²	0.000 (0.000)	0.001*** (0.000)	-0.000 (0.000)	0.001** (0.002)	0.000 (0.000)	-0.001** (0.000)
<i>Nationality (base: German)</i>						
Foreigner	-0.109*** (0.020)	0.105** (0.047)	-0.081*** (0.020)	-0.059* (0.032)	0.096*** (0.031)	-0.031 (0.039)
<i>Occupation (base: manufacturing)</i>						
Farming	0.060*** (0.021)	-0.025 (0.078)	-0.032 (0.023)	-0.022 (0.047)	-0.186*** (0.067)	-0.196*** (0.065)
Mining	-0.164 (0.130)	0.066 (0.294)	-0.592*** (0.132)	-0.244 (0.166)	0.301** (0.138)	-0.132 (0.194)
Engineering	-0.525*** (0.038)	-0.147** (0.069)	-0.096*** (0.031)	-0.270*** (0.066)	-0.055 (0.041)	-0.174** (0.072)
Service	-0.245*** (0.013)	0.080** (0.032)	-0.060*** (0.012)	-0.032 (0.022)	-0.003 (0.021)	-0.129*** (0.028)
Miscellaneous	0.021 (0.050)	0.376*** (0.100)	-0.276*** (0.074)	-0.251** (0.127)	-0.118 (0.091)	-0.372*** (0.126)
<i>Education (base: no degree)</i>						
Voc. Train.	-0.459*** (0.016)	-0.129*** (0.043)	0.206*** (0.016)	0.035 (0.025)	-0.041 (0.028)	-0.315*** (0.032)
HS degree	-0.395*** (0.099)	0.226* (0.130)	0.009 (0.095)	-0.127 (0.124)	-0.156** (0.077)	-0.585*** (0.124)
HS + VT	-0.842*** (0.049)	-0.165** (0.079)	0.242*** (0.040)	0.029 (0.071)	-0.143*** (0.054)	-0.647*** (0.084)
Tech. College	-0.980*** (0.059)	-0.514*** (0.106)	0.310*** (0.047)	-0.048 (0.092)	-0.158** (0.062)	-0.688*** (0.106)
Uni. degree	-1.122*** (0.046)	-0.460*** (0.072)	0.231*** (0.039)	-0.040 (0.070)	-0.431*** (0.049)	-1.123*** (0.085)
Environmental characteristics						
<i>Business cycle</i>						
Lagged GDP growth	-0.030*** (0.010)	-0.318*** (0.026)	0.104*** (0.010)	-0.173*** (0.022)	-0.067*** (0.021)	-0.010 (0.022)
<i>Current labor market situation in Germany</i>						
Unemployment rate	0.139*** (0.009)	-0.182*** (0.020)	-0.148*** (0.009)	-0.089*** (0.017)	-0.312*** (0.016)	-0.127*** (0.018)

Table 5 – (continued)

	<i>Transitions</i>					
	E → U	E → O	U → E	U → O	O → E	O → U
<i>Regional labor market segregation in Germany (base: West, hi. dyn. regions + good LM-cond.)</i>						
E, shortcoming in employment	0.344*** (0.018)	-0.141*** (0.050)	-0.251*** (0.017)	-0.470*** (0.033)	-0.205*** (0.033)	0.299*** (0.041)
W, hi. urbanized + hi. U-rate	0.145*** (0.021)	0.096** (0.045)	-0.361*** (0.019)	-0.229*** (0.032)	-0.041 (0.029)	0.133*** (0.040)
W, more rural + avg. U-rate	0.066*** (0.018)	-0.094** (0.044)	-0.146*** (0.017)	-0.197*** (0.031)	-0.051* (0.027)	0.003 (0.039)
W, hi. dyn. cent. + good LM	0.046* (0.028)	0.146*** (0.053)	-0.153*** (0.026)	0.009 (0.041)	-0.009 (0.034)	-0.030 (0.050)
Initial conditions						
<i>Cumulative number of previous spells at t₀</i>						
Previous cum. E spells at	0.045*** (0.011)	0.131*** (0.026)	0.035*** (0.011)	0.061*** (0.015)	-0.027 (0.022)	-0.114*** (0.024)
Previous cum. U spells at	-0.045*** (0.011)	0.012 (0.028)	-0.011 (0.011)	-0.034* (0.018)	0.045** (0.023)	-0.058** (0.023)
Previous cum. O spells at	0.044** (0.017)	0.014 (0.033)	-0.062*** (0.015)	-0.022 (0.021)	-0.014 (0.024)	0.175*** (0.030)
<i>Cumulative duration of previous spells at t₀ (measured in months)</i>						
Previous cum. E duration	-0.003** (0.002)	-0.005 (0.004)	0.006*** (0.001)	-0.002 (0.003)	0.011*** (0.003)	-0.001 (0.004)
Previous cum. U duration	0.007*** (0.002)	0.011** (0.005)	-0.004** (0.002)	0.004 (0.003)	0.010** (0.004)	0.024*** (0.004)
Previous cum. O duration	0.013*** (0.003)	0.026*** (0.005)	0.005** (0.002)	0.003 (0.003)	0.017*** (0.004)	-0.005 (0.005)
Unobserved heterogeneity						
Type 1	-8.331*** (0.300)	-3.660*** (0.108)	-2.545*** (0.294)	-4.565*** (0.544)	-1.455*** (0.491)	-7.395*** (0.664)
Type 2	-6.998*** (0.300)	-1.511*** (0.000)	-3.594*** (0.296)	-3.658*** (0.533)	-1.983*** (0.497)	-6.625*** (0.669)
Type 3	-8.372*** (0.303)	-3.615*** (0.264)	-3.840*** (0.288)	-4.562*** (0.528)	-2.817*** (0.501)	-5.190*** (0.659)
Probability of type 1	0.422 (-)					
Probability of type 2	0.208*** (0.009)					
Probability of type 3	0.370*** (0.014)					

Standard errors in parentheses. Significance on 10%, 5% and 1%-level is indicated by *, ** and ***.

Table 6 – Model fit

	<i>Origin state</i>			Total
	E	U	O	
Raw data				
<i>Time under observation (days)</i>				
Average per person	532.88	316.64	119.82	969.34
Per cent	54.97	32.67	12.36	100.00
Maximum history length				1460
<i>Incidence rate (exits per year)</i>				
Total	0.55	1.16	1.25	
<i>Destination state</i>				
E	0	0.96	0.65	
U	0.48	0	0.60	
O	0.07	0.20	0	
<i>Duration quantiles (days)</i>				
25%	143	64	75	
50%	337	152	183	
75%		440	365	
Model fit				
<i>Time under observation (days)</i>				
Average per person	538.91	312.86	115.91	967.68
Per cent	55.69	32.33	11.98	100.00
<i>Incidence rate (exits per year)</i>				
Total	0.54	1.39	1.51	
<i>Destination state</i>				
E	0	1.18	0.82	
U	0.47	0	0.69	
O	0.07	0.21	0	
<i>Duration quantiles (days)</i>				
25%	127	46	52	
50%	342	121	133	
75%		344	333	

E: Employment, U: Unemployment, O: Out of labor force. *Notes:* Quantiles are based on the Kaplan-Meier product limit estimator. The 80th and 90th percentile are not identified due to right-censoring.

D Figures

Figure 1 – Labor market history of a typical person in the IEBS

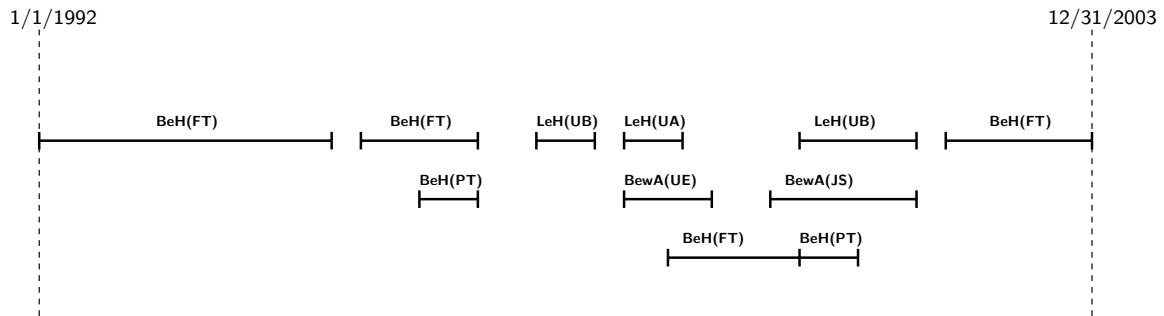

Figure 2 – Identification of labor market states for a typical person in the IEBS

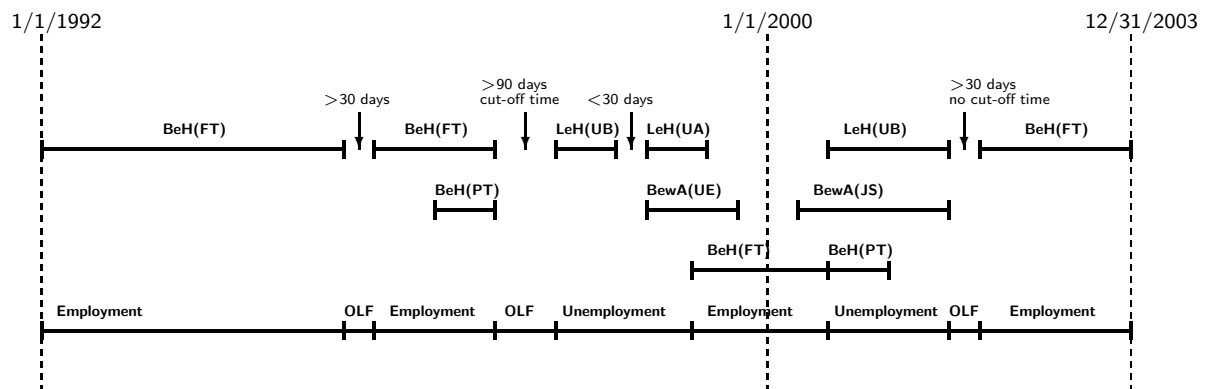
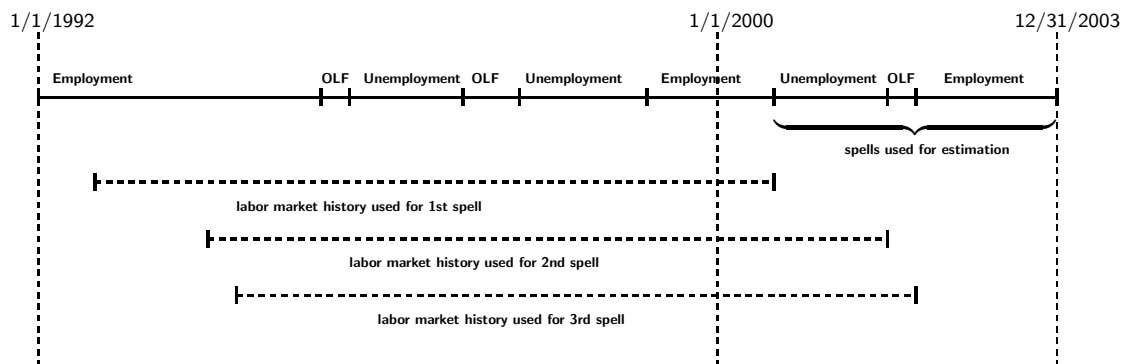

Figure 3 – Sampling strategy



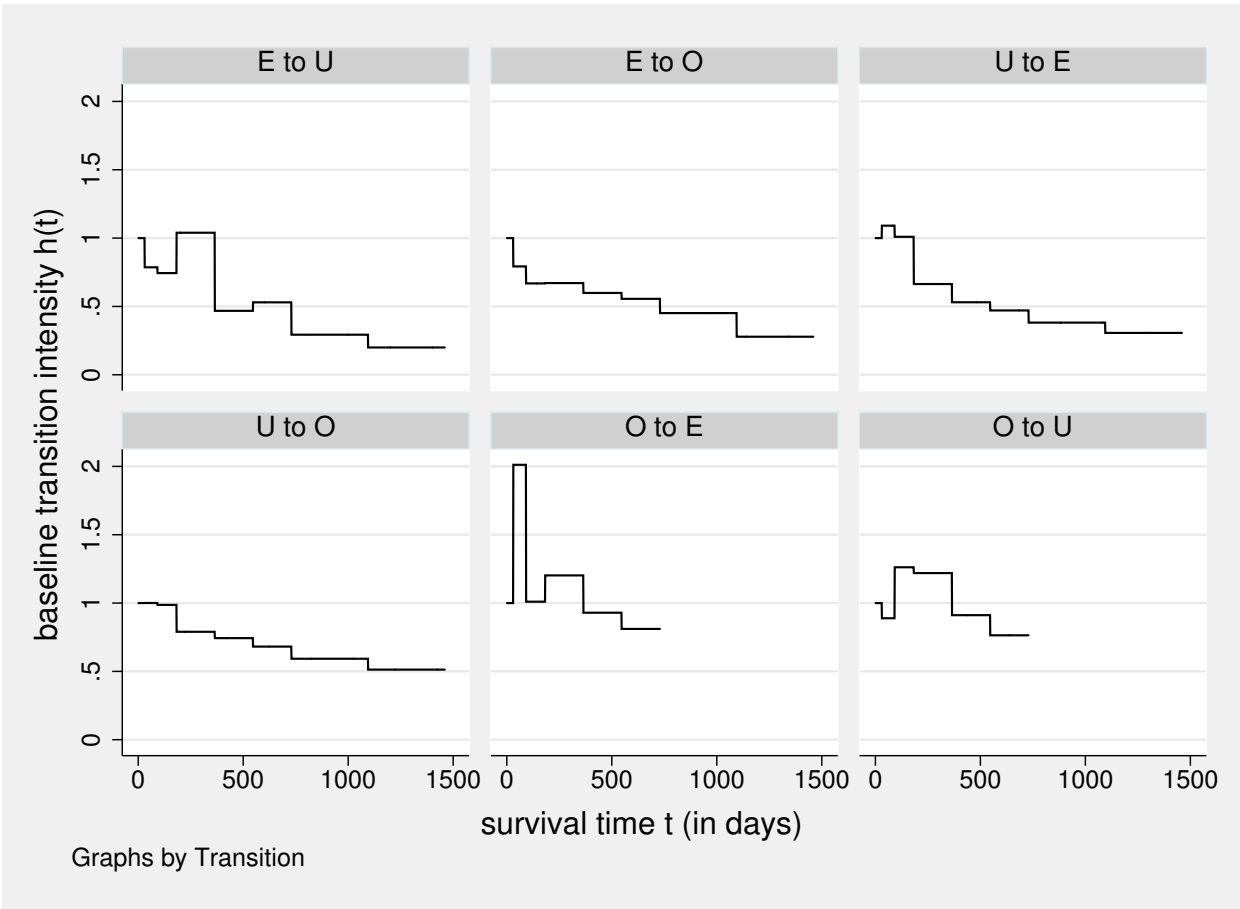

Figure 4 – Estimated baseline transition intensities

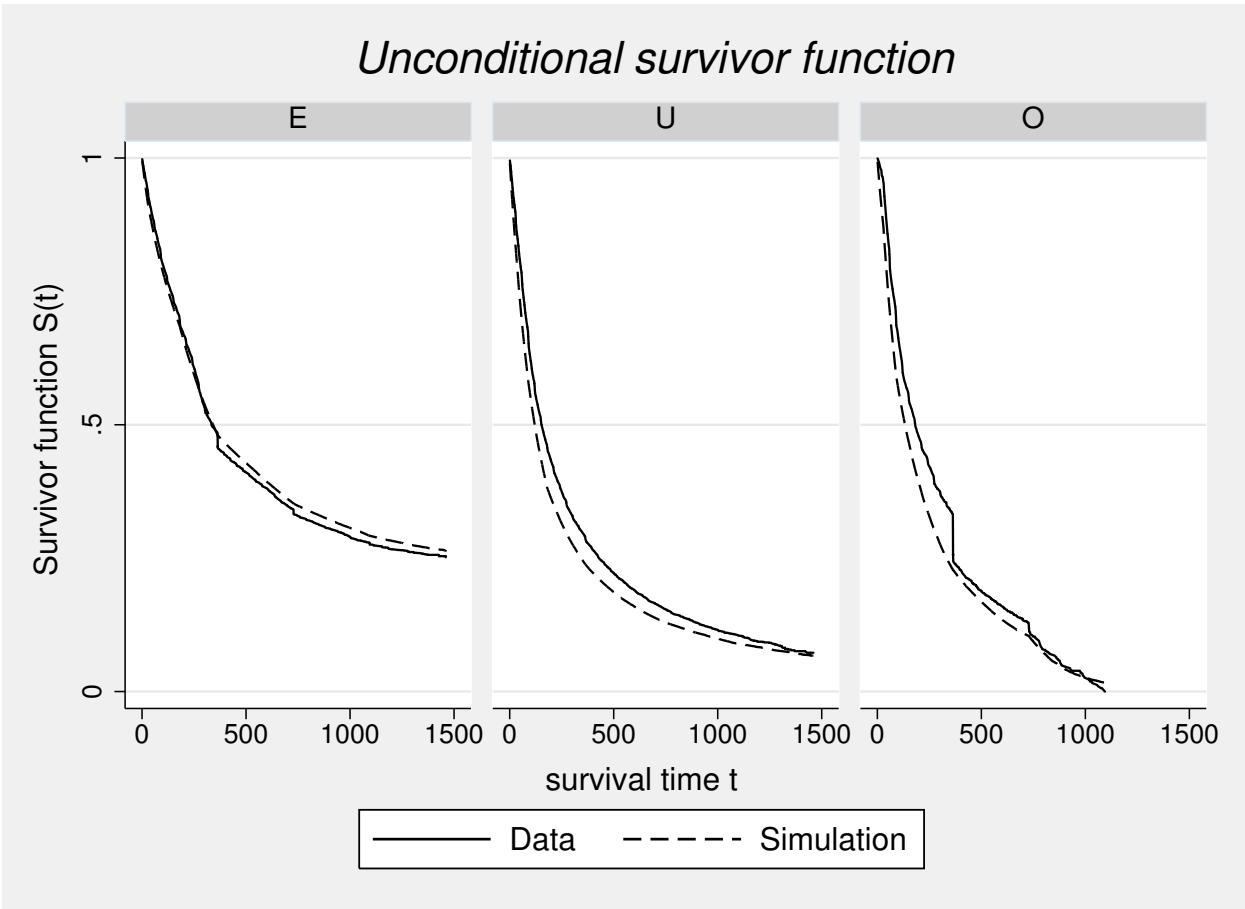

Figure 5 – Model fit

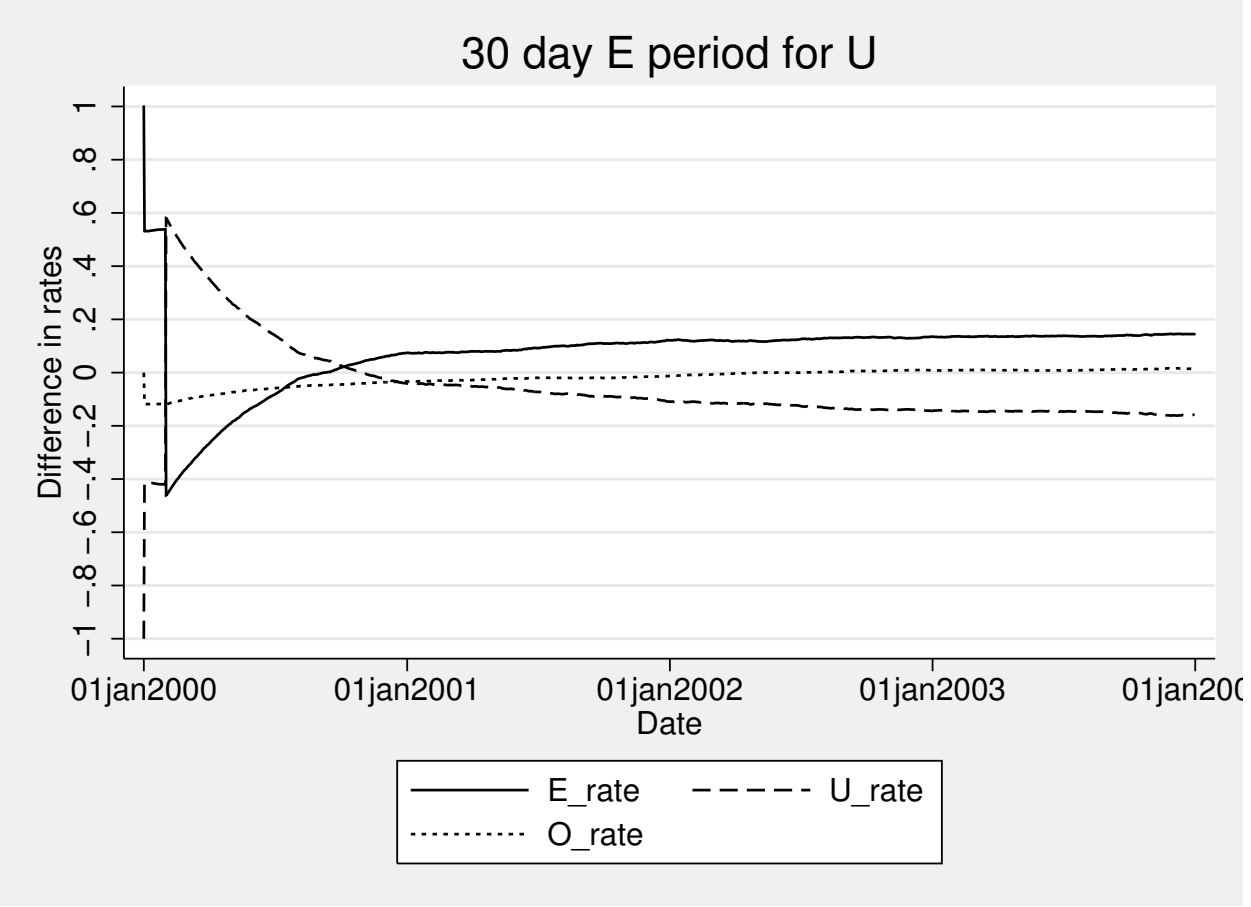

Figure 6 – Simulated interventions: 30 days employment spell for unemployed

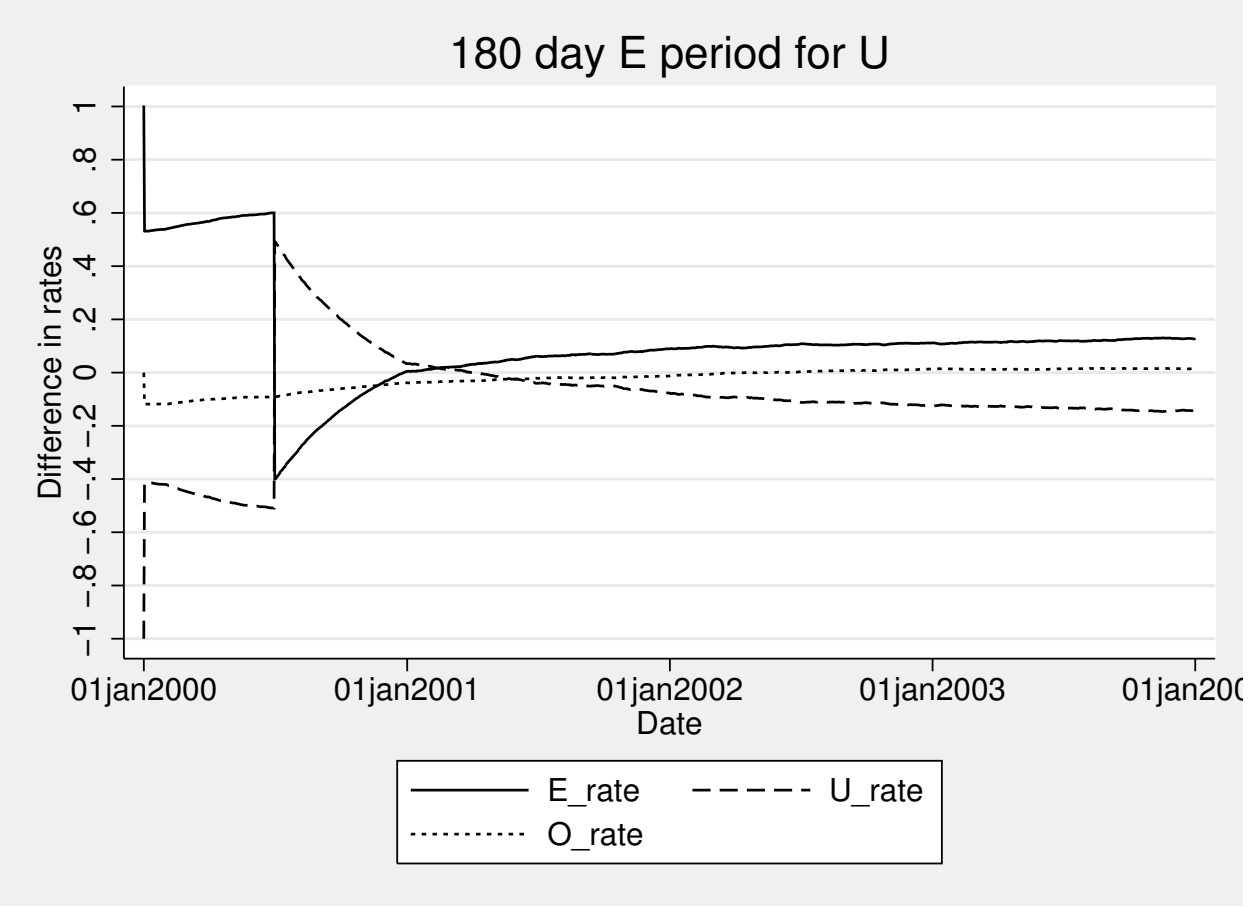

Figure 7 – Simulated interventions: 180 days employment spell for unemployed

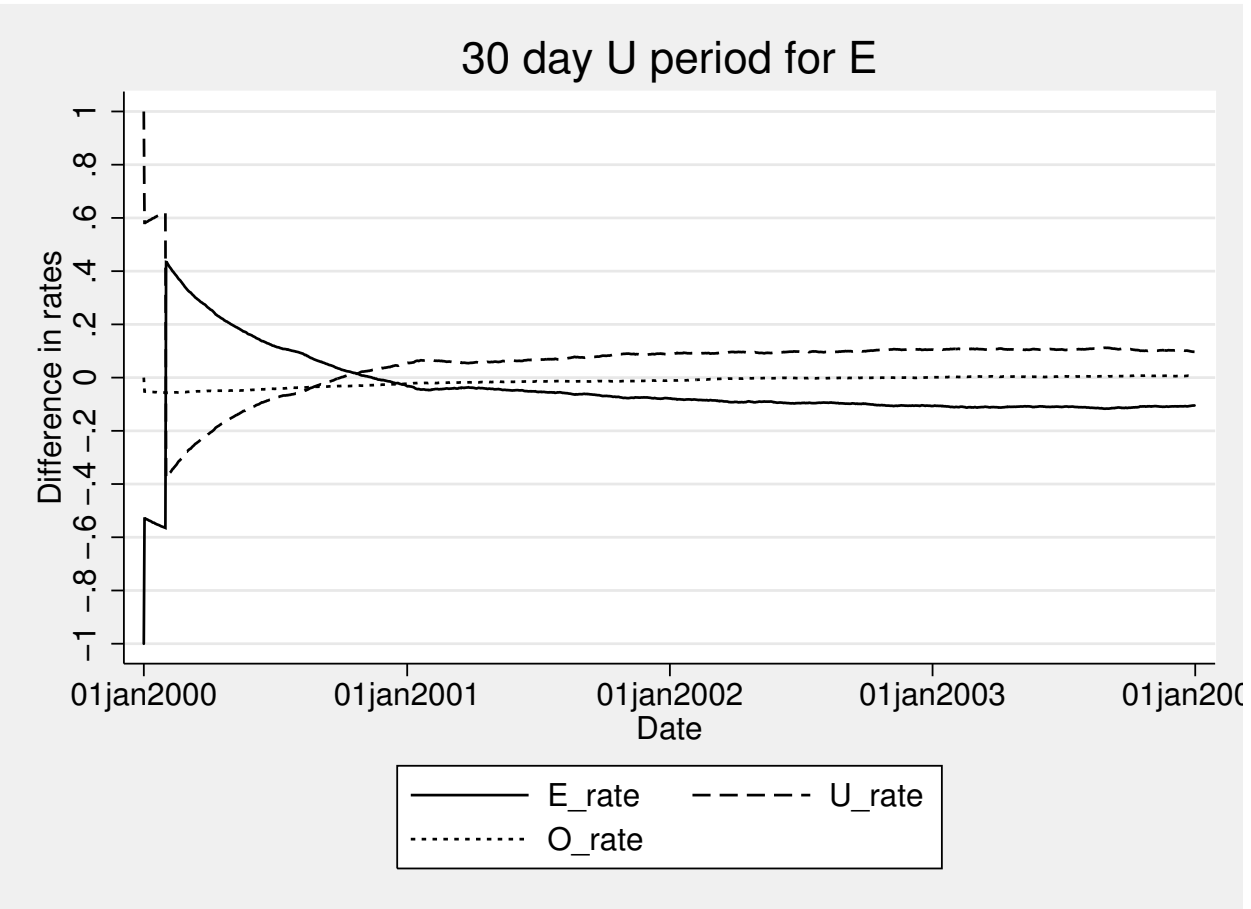

Figure 8 – Simulated interventions: 30 days unemployment spell for employed

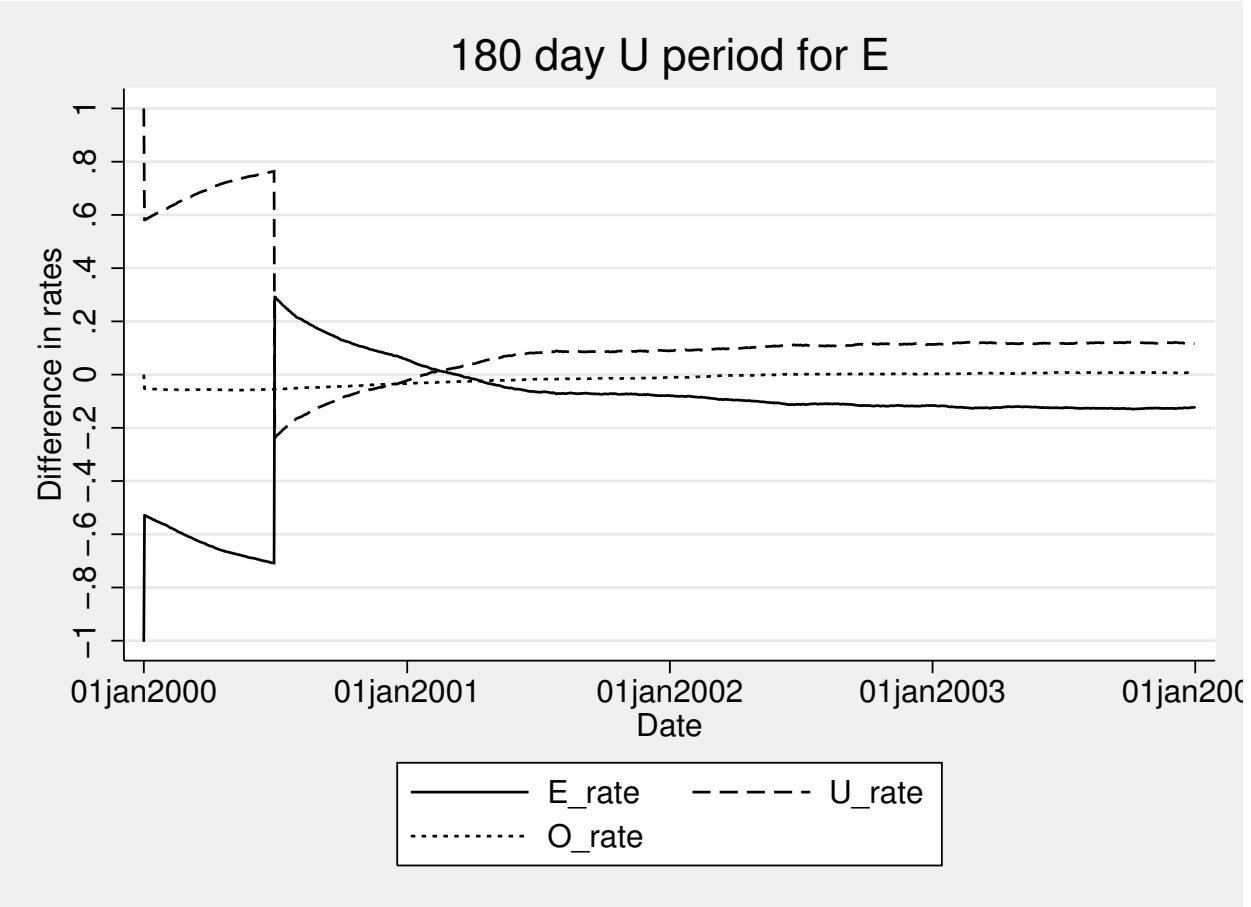

Figure 9 – Simulated interventions: 180 days unemployment spell for employed