

Ruiz Estrada, Mario Arturo; Yap, Su-Fei; Ismail, Noor Azina Binti

Article

Revisiting the Phillips curve: Visualization from a multidimensional graphical perspective

Contemporary Economics

Provided in Cooperation with:

University of Finance and Management, Warsaw

Suggested Citation: Ruiz Estrada, Mario Arturo; Yap, Su-Fei; Ismail, Noor Azina Binti (2017) : Revisiting the Phillips curve: Visualization from a multidimensional graphical perspective, Contemporary Economics, ISSN 2300-8814, University of Finance and Management in Warsaw, Faculty of Management and Finance, Warsaw, Vol. 11, Iss. 1, pp. 67-90,
<https://doi.org/10.5709/ce.1897-9254.229>

This Version is available at:

<https://hdl.handle.net/10419/162106>

Standard-Nutzungsbedingungen:

Die Dokumente auf EconStor dürfen zu eigenen wissenschaftlichen Zwecken und zum Privatgebrauch gespeichert und kopiert werden.

Sie dürfen die Dokumente nicht für öffentliche oder kommerzielle Zwecke vervielfältigen, öffentlich ausstellen, öffentlich zugänglich machen, vertreiben oder anderweitig nutzen.

Sofern die Verfasser die Dokumente unter Open-Content-Lizenzen (insbesondere CC-Lizenzen) zur Verfügung gestellt haben sollten, gelten abweichend von diesen Nutzungsbedingungen die in der dort genannten Lizenz gewährten Nutzungsrechte.

Terms of use:

Documents in EconStor may be saved and copied for your personal and scholarly purposes.

You are not to copy documents for public or commercial purposes, to exhibit the documents publicly, to make them publicly available on the internet, or to distribute or otherwise use the documents in public.

If the documents have been made available under an Open Content Licence (especially Creative Commons Licences), you may exercise further usage rights as specified in the indicated licence.



<http://creativecommons.org/licenses/by/4.0/>

Primary submission: 30.10.2015 | Final acceptance: 22.11.2016

Revisiting the Phillips Curve: Visualization from a Multidimensional Graphical Perspective

Mario Arturo Ruiz Estrada¹, Su-Fei Yap², Noor Azina Binti Ismail²

ABSTRACT

This article explores the possibility of visualizing the Phillips curve from a multidimensional perspective. We use a new multidimensional coordinate space, the mega-dynamic disks multivariable random coordinate space in vertical position, which visualizes the graphical behavior of the Phillips curve from a multidimensional point of view. We take A. W. Phillips's original paper published in *Economica* in 1958, "The Relation between Unemployment and the Rate of Change of Money Wage Rates in the United Kingdom, 1861-1957," as our main bibliographical reference. The same paper also serves as our main database for transforming the original Phillips curve into a multidimensional graphical form. In essence, our paper extends the significance of the Phillips curve beyond mere theory to serve as a practical instrument for solving economic problems.

KEY WORDS:

Inflation, Unemployment, Phillips curve, Multidimensional coordinate spaces, Econographicology

JEL Classification: Y20

¹ Social Security Research Centre (SSRC) & Centre of Poverty and Development Studies (CPDS), Faculty of Economics and Administration, University of Malaya, Malaysia; ² Faculty of Economics and Administration, University of Malaya, Malaysia

1. Introduction

A. W. Phillips's groundbreaking paper was published fifty-five years ago. Now, we are proposing a new graphical model to visualize its great contribution to economics. Therefore, the main inspiration for this paper is based on transforming the original Phillips curve into a multidimensional graphical format that will provide greater understanding about the relation-

ship between unemployment and the rate of change of money wage rates from a multidimensional perspective. Therefore, this paper aspires to compare graphically how the Phillips curve behaves from two-dimensional and multi-dimensional perspectives. Our main objective is to propose an alternative multidimensional graphical framework that can enhance our understanding of the complex and dynamic relationship between unemployment and the rate of change of money wage rates within the same graphical space at different periods of time. This paper is divided into six sections: (i) the evolution of graphical methods in economics; (ii) how multidimensional coordinate spaces work; (iii) the transformation of the Phillips curve into a multidimensional graphical form; (iv) an

Correspondence concerning this article should be addressed to: **Mario Arturo Ruiz Estrada**, Social Security Research Centre (SSRC) & Centre of Poverty and Development Studies (CPDS), Faculty of Economics and Administration, University of Malaya, Kuala Lumpur 50603, Malaysia. T: (+60) 37967-3728. E-mail: marioarui@um.edu.my

introduction to the mega-dynamic disks multivariable random coordinate space in the vertical position; (v) the construction of the Phillips curve in a multi-dimensional graphical form; and (vi) observations about the difference between the two-dimensional and multidimensional graphical models in the visualization of the Phillips curve.

2. The Evolution of Graphical Methods in Economics

Previous research shows a strong link between the introduction of graphical methods in economics and the development of theories, methods and techniques in statistics and mathematics. In the 18th century, for example, several new graphical methods were developed as a result of contemporary advances in mathematics and statistics research. These graphical methods include line graphs of time series data, curve-fitting and interpolation, measurement of error as a deviation from a graphed line, graphical analysis of periodic variation, statistical mapping, bar charts and printed coordinate chapters (Cohn, Cohn, Balch, & Bradley, 2004). Playfair (2005) introduced the application of graphical methods in economic analysis. Playfair constructed a wonderful collection of graphs at the end of the 18th century, which placed him far ahead of other economists at the time in terms of visualizing economic data.

The development of graphical methods in economics can be classified into two distinct phases. The first phase is the *basic graphical method*, which features histograms and scatter-plots. All of these types of graphs are based on the visualization of a single variable (Y) through time (X) in the first quadrant in the two-dimensional Cartesian coordinate system (see Figure 1). The main objective of the *basic graphical method* in economics is to study the behavior of a single economic variable (e.g., exports, unemployment, inflation rate, etc.) within a time frame based on a time series. In fact, Playfair may be considered the pioneer of the *basic graphical method*. The second phase in the development of graphical methods for economics is the *complex graphical method*. In economics, the *complex graphical method* is distinguished by the use of three-dimensional coordinate systems. According to Maas (2005), Jevons first explored the merits of the graphical method for political economy. This is a case of the use

of the *complex graphical method* in economics, where the form of the graph gives an idea of the possible representation of functions describing the relationship between the X, Y, and Z variables that suggests a causal interpretation of the relationship between X, Y and Z. Additionally, the uses of the complex graphical method are based on the two and three-dimensional Cartesian plane, introduced in 1637 by Descartes (Wise, 2011), who made substantial contributions to economics. The two and three-dimensional coordinate spaces opened a new era in economic theory by enabling analysis of a complex and dynamic economic phenomenon based on the relationship between two or three variables. However, it is necessary also to mention the major contribution of Cournot (Mirowski, 1991). Cournot derived the first formula for the rule of supply and demand as a function of price in a two-dimensional view. He was also the first economist to draw supply and demand curves from a graphical view. In addition to Cournot and Jevons, other innovative economists that contributed to the analytical graph system in economics over time include Walras (in the field of general equilibrium) and Marshall (in the field of partial equilibrium) (Boland, 1981). In the 20th century, economists' use and application of the *complex graphical method* was often based on sophisticated graphical techniques introduced during the development of new economic modelling. In particular, economists started to deploy advanced geometry in constructing their graphs. In addition, two- and three-dimensional Cartesian coordinate systems were also a part of complex economics research (Cohn, Cohn, Balch, & Bradley, 2001). High technology and sophisticated analytical machines such as the electronic calculator and the computer facilitated the rapid development of the *complex graphical method*. The development of analytical instruments in economics took place in two stages. The first stage, which took place in the 1950s and 1960s, involved *non-sophisticated computational instruments* such as electronic calculators to compute basic mathematical expressions. The second stage, the *sophisticated computational instruments*, began in the mid-1980s when computers with high speeds and large storage capacities using sophisticated software and applications were first introduced. The use of sophisticated software and applications enabled easy information management, the application of difficult simulations

and high-resolution graphs in a three-dimensions. These analytical instruments undoubtedly contributed substantially to developing research in economics. High-tech computational instruments, backed by sophisticated hardware, applications and software, were utilized to create graphical representations with high resolution. In fact, the *basic graphical method* and *complex graphical method* can be categorized according to either function or dimension. In terms of function, the two graphical methods are either descriptive or analytical. In terms of dimension, they can be two-dimensional, three-dimensional or multidimensional coordinate systems. The *basic graphical method* shows arbitrary information that is used to observe the historical behavior of data from a simple perspective. Alternatively, the *complex graphical method* is available to generate graphs from a multidimensional and dynamic perspective (Ruiz Estrada, 2011b).

3. How do Multidimensional Coordinate Spaces Work?

The main reason to apply multidimensional coordinate spaces is to study any economic phenomena from a multidimensional perspective. This has its roots in the limitations of two-dimensional coordinate space and the need to capture and generate a multidimensional visual effect of any economic phenomena in the same graphical space. Hence, the multidimensional coordinate space leads to an alternative graphical modeling that is more flexible and innovative than the current two-dimensional coordinate space for observing multivariable data behavior. The study of multidimensional coordinate spaces requires basic knowledge about the “n-dimensional space”. Moreover, the application of multidimensional coordinate spaces offers an adaptation for building n-dimensions, sub-dimensions, micro-dimensions, nano-dimensions and ji-dimensions in the visualization of any economic phenomenon. In other words, economists’ use of coordinate spaces is based on plotting different points that represent the relationship between two or more variables in the first and fourth quadrants of two-dimensional coordinate space. They then proceed to join all of these points by lines until it is possible to visualize histograms, line graphs and scatter-plots (see Figure 1). Hence, it is possible to observe the trend and behavior of different variables of any economic dynamic and com-

plex phenomenon, such as the relationship between unemployment/inflation and interest rate/investment, etc. From our point of view, each point plotted on two-dimensional, three-dimensional and multidimensional coordinate spaces represents a single rigid point (Ruiz Estrada, 2011a). Recently, a few economists have started to use three-dimensional coordinate space with three axes: “X-coordinate” (or exogenous variable), “Y-coordinate” (or exogenous variable) and the “Z-coordinate” (or endogenous variable). This is based on the construction of surfaces or three-dimensional manifolds to visualize multivariable economic data behavior (see Figure 2). According to our research, the use of three-dimensional coordinate space is not popular among economists and policymakers. Based on one thousand (1,000) papers published in ten (10) reputable economics journals¹ between the year 1950 and 2000 from JSTOR, it is possible to observe that the most common types of graphical representations applied in the study of social sciences, especially in economics, were of the two-dimensional coordinate space type. A total of 97% of these chapters utilized the two-dimensional Cartesian coordinate system, and only 3% of them used three-dimensional coordinate spaces. This research will proffer several reasons as to *why* economists continue using two-dimensional coordinate space and only sometimes three-dimensional coordinate space in the graphical representation of complex and dynamic economic phenomena. These reasons are as follows:

- The application of two-dimensional coordinate space in the economic graphical analysis has become a **tradition**.
- Two-dimensional space is **easy to use** to visualize basic trends or values in the same graphical space.
- It is difficult to find **alternative and suitable multidimensional graphical models** to transform two-dimensional coordinate space graphical modeling to multidimensional space graphical modeling.

This article introduces a new multidimensional coordinate space that seeks to generate an innovative multidimensional optical effect to visualize complex and dynamic economic phenomena. Multidimensional coordinate spaces can incorporate a large number of exogenous variables that change constantly and directly affect the behavior of endogenous variable(s)

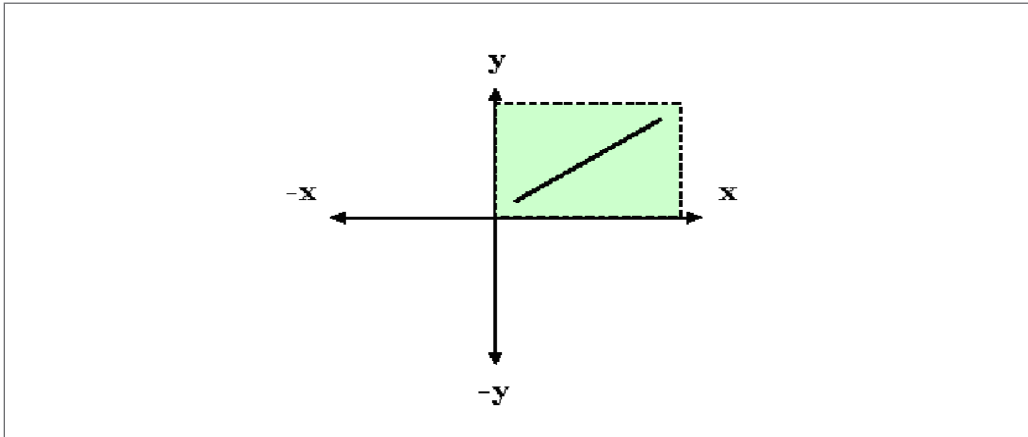

Figure 1. Two-Dimensional Coordinate Space

Source: Adapted from "Multi-dimensional coordinate spaces", by Ruiz Estrada (2011a) in *International Journal of Physical Sciences*, 6(3), 340-357.

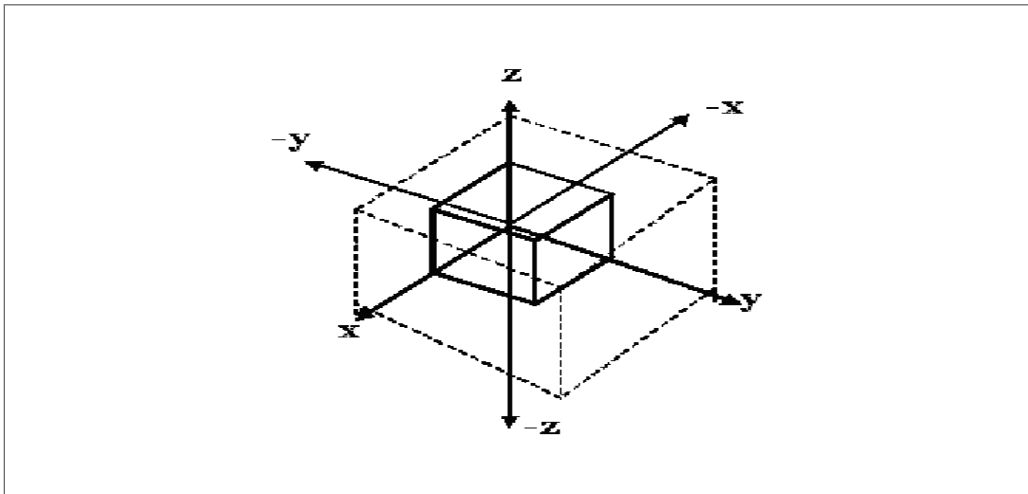

Figure 2. Three-Dimensional Coordinate Space

Source: Adapted from "Multi-dimensional coordinate spaces", by Ruiz Estrada (2011a) in *International Journal of Physical Sciences*, 6(3), 340-357.

in the same graphical space. These new types of multidimensional coordinate spaces are based on the mega-dynamic disks multivariable random coordinate space in vertical position. The multidimensional space enables economists, academics and policymakers to analyze economic phenomena from multi-

dimensional perspectives across time and space. The proposed concept is preferred because it offers an immediate multidimensional perspective of the Phillips curve, thus presenting visually what normally would require a lot of data and substantial explanation. When the original Phillips curve was formulated

(Phillips, 1958), it was not possible to capture a structure beyond two-dimensional analysis.

However, the analysis of economics must move in tandem with the advancement of computers and technology. Thus, our primary argument is that a new analytical and visual tool has been created; our development of the Phillips curve is merely the beginning of new and powerful visuals to present economic phenomena to society. Just as the DNA double helix is now immediately recognized as the representation of a biological code, many economic structures, connectivity and imagery can be given a new lease on life through highly impactful images that capture an otherwise lengthy discussion. While both academic arguments and theoretical frontiers remain necessary, new graphics and visuals will convincingly harness ideas in neat and concise representations, thus furthering our objectives as economists to translate concepts to policies.

4. Transformation of the Phillips Curve into a Multidimensional Graphical Form

4.1. Hypothesis of A. W. Phillips (1958)

A. W. Phillips' original hypothesis is based on the argument that the demand for any good or service is high relative to its supply if we expect the price to rise. According to Phillips (1958), if the demand is low relative to the supply of goods and services, we expect the price to fall so that it can generate a deficiency of demand. Finally, the dramatic fall of demand in goods and services can directly affect the change of wage rates. In our case, we can make reference to the labor price. According to Phillips (1958), if the demand for labor is high, then unemployment is low and vice versa. Hence, fast growth in wages attracts more qualified human capital to firms and industries. Finally, Phillips assumes that the relationship between unemployment and the rate of change of wage rates is highly non-linear (Apergis, 2013).

The second argument is that the rate of change of wage rates is directly related to the demand for labor and unemployment. In fact, the business environment (whether a booming economy or an economic crisis) plays an important role in determining labor demand; if it improves, then logically, unemployment shrinks and vice versa. Therefore, any economic crisis leads to

a weaker position to push for higher wage rates. At the same time, the average unemployment rate is always directly affected by the labor demand (Carrasco & Ferreira 2011; Josifidis, Beker Pucar, Srdić, & Ivan, 2014).

The third argument is that the rate of change of wages is directly connected to the changes of retail prices and the cost of living that is reflected in wage rates. According to Phillips (1958), "The cost of living adjustments will have little or no effect on the rate of change of money wage rates except at times when retail prices are forced up by a very rapid rise in import prices." However, the third argument also mentions that productivity has a strong direct relationship with aggregate demand and unemployment.

Additionally, the third argument is concerned about productivity and aggregate demand having a strong relationship that directly affects unemployment. Phillips presents illustrative examples using simple arithmetic to study the cause and effect of a series of variables such as productivity, aggregate demand, unemployment, import process and retail prices. Phillips' main contribution is based on calculating the rate of change of factor costs minus the rate of change of productivity. Finally, Phillips (1958) said that, "The introduction of cost of living adjustments in wage rates will have no effect, for employers will merely be giving under the name of cost of living adjustments part of the wage increases which they would in any case have given as a result of their competitive bidding for labor." This hypothesis is based on statistical evidence that the rate of change of wage rates in the UK can be explained by the rate of change of unemployment for three periods of analysis, namely 1861-1913, 1913-1948 and 1948-1957. In addition, Phillips includes in his analysis the average price of imports to demonstrate his hypothesis.

Phillips' paper presents (1958) a total of eleven figures based on the use of two-dimensional scatter diagrams to represent the relationship between average unemployment rate (X-axis) and average rate of change of wage rates (Y-axis). The calculation of the average rate of change of wage rates is based on the application of Brown and Hopkins (Pencavel, 2011). In summary, this index uses simple growth rates between two periods (past year and present year). Hence, Phillips' paper (1958) mentions that "The tendency for the rate of change of money wage rates to be high when unem-

ployment is low and to be low or negative when unemployment is high.” This trend is observed in Figures 6 and 15. In fact, Phillips’ main contribution is based on the argument that “There is also a clear tendency for the rate of change of money wage rates at any given level of unemployment to be above the average for that level of unemployment when unemployment is decreasing during the upswing of a trade cycle and to be below the average for that level of unemployment when unemployment is increasing during the downswing of a trade cycle.” Moreover, the mathematical modeling that Phillips uses in his paper is based on a non-linear equation that is shown by equations 1, 2, 3 and 4.

$$y = -a + bx^c \quad (1)$$

$$y + a = bx^c \quad (2)$$

$$\log(y + a) = \log b + c \log x \quad (3)$$

$$\log(y + a) = c \log bx \quad (4)$$

According to Phillips (1958), the rate of change of wage rates is represented by “y” and the percentage unemployment by “x”. The constants b and c were estimated by least squares using the values of y and x corresponding to the crosses in the four intervals between 0 and 5 percent, respectively. The variable of unemployment that is a constant is chosen by random error to make the curve pass or be as close as possible to the remaining two crosses in two intervals between 5 and 11 percent, respectively. Finally, the equation of the fitted curve is represented by:

$$y + 0.900 = 9.638x^{-1.394} \quad (5)$$

$$\log(y + 0.900) = \log 9.638 + \log x^{-1.394} \quad (6)$$

$$\log(y + 0.900) = 0.984 - 1.394 \log x \quad (7)$$

Therefore, Phillips supports the construction of the fitted curve based on a simple multiple regression of y on the variables x and the differentiation between dx/dt. He clearly described the difficulty of finding a suitable linear multiple regression equation to evaluate the relationship between unemployment and the rate of change of money wage rates. From a geometrical point

of view, all of Phillips’s visualizations presented a peculiar fitted curve together with a large series of plotted points representing the relationship between average rates of unemployment and the average rate of change of wage rates. In our opinion, many academicians confuse the fitted curve and try to show that if the unemployment rate is low, then the rate of change of wage rates is high. We can observe that the fitted curve moves from quadrant one (+X, +Y) to quadrant four (+X, -Y) in the two-dimensional Cartesian plane (see Figure 2). Hence, if the unemployment rate is equal to 5.5, then the rate of change of wage rates is zero. The same fitted curve maintains the rate of change of wage rates trend between 10 and -3 in the case of the Y-axis. According to our observations, the unemployment range goes up to 11 for all figures in the same paper. Finally, Phillips assembles all of these points in a logical order around the fitted curve through the use of straight lines. In fact, we can observe that the visualization of all of these lines reveals chaos in the relationship between the unemployment and wages rates in the same graphical space and time. Therefore, Phillips’ accuracy from the fitted curve demonstrates the relationship among these two variables. Therefore, we conclude that Phillips never used inflation, as many economists have assumed. In fact, the Phillips curve only shows the relationship between the change of wages and unemployment rate. He never applies inflation rates based on the CPI; rather, he tries to illustrate labor market behavior in certain periods of time according to his observations.

4.2. Modern Approaches in the Construction of the Phillips Curve: The New Keynesian Phillips Curve (NKPC)

The New Keynesian Phillips Curve (NKPC) is based on the relationship between marginal cost and the output gap. This new curve is based on two basic assumptions: (i) optimal price setting by monopolistically competitive firms; and (ii) constant frictionless markup μ . According to the NKPC, the inflation dynamics are represented by equation 8:

$$\pi_t = \beta E_t \{\pi_{t+1}\} + \lambda f^2 C_{Tt} \quad (8)$$

Therefore, the marginal cost and the output gap are represented in equations 9 and 10.

$$f'C_{Tt} = (\sigma + \varphi) y_t \tag{9}$$

The income gap is equal to:

$$Y_t = Y_t - Y_t \tag{10}$$

We assume that everything produced is consumed in this model.

$$Y_t = C_t \tag{11}$$

$$K = \lambda (\sigma + \varphi) \tag{12}$$

Finally, the New Keynesian Phillips Curve (NKPC) is represented in equation 13.

$$\pi_t = \beta E_t \{ \pi_{t+1} \} + K y_t \tag{13}$$

Accordingly, the New Keynesian Phillips Curve (NKPC) is consistent with rational expectations. The NKPC rests on three basic conditions: (i) inflation leads measure the output gap without trade-off between inflation and output gap stabilization; (ii) disinflation can be achieved without cost; and (iii) inflation is purely forward-looking, and past inflation is irrelevant. A number of studies utilize NKPC, such as Ball and Mazumder in “What Determines the Sacrifice Ratio?” (2011) and Fuhrer and Moore in “Inflation Persistence” (1995). Moreover, Friedman is a sharp critic of the ability to apply rational expectations with the NKPC (Lucas & Sargent, 1981). According to Friedman (1968), “The Keynesian model implicitly relied on the idea that low unemployment could be sustained by allowing high inflation to erode real wages and thus boost labor demand. Friedman pointed out that if policy tried to keep output above its ‘potential’ or ‘equilibrium’ level, then wage-bargainers would get used to the higher level of inflation and adjust their nominal wage demands upwards. The result would be higher inflation without the sustainable low unemployment.” Finally, Friedman (1968) mentioned that the traditional Phillips curve was an inadequate model for rational expectations because they are based on neoclassical micro-foundations such as sticky prices (without some type of rigid prices) for macroeconomic modeling. From a visual perspective, the NKPC continues to use a two-dimensional coordinate system, which does not permit us to depict

completely the real behavior between inflation and unemployment together in the same graphical modeling. Therefore, the next section tries to propose a new multidimensional graphical modeling that it is based on mega-dynamic disks multivariable random coordinate space in vertical position.

5. Mega-Dynamic Disks Multivariable Random Coordinate Space in Vertical Position

This paper proposes a unique multidimensional coordinate space called the mega-dynamic disks multivariable random coordinate space in vertical position (Ruiz Estrada, 2014). The mega-dynamic disks multivariable random coordinate space in vertical position captures n-dimensions in the same graphical space at the same time. Therefore, this new special coordinate space creates the possibility of visualizing a large number of endogenous and exogenous variables that are interconnected and moving in different graphical spaces with different time frameworks without any restriction. It facilitates the observation of how endogenous variables and exogenous variables work together simultaneously. At the same time, one can see how all of these variables interact together through the visualization of an asymmetric spiral-shaped figure with n-faces that constantly moves in real time. This asymmetric spiral-shaped figure with n-faces can show an expansion or contraction that is based on different changes among all variables at different graphical spaces with different time frameworks.

Initially, the mega-dynamic disks multivariable random coordinate space in vertical position proposes a new graphical modeling to visualize a large amount of data. First, this specific coordinate space shows one single vertical straight axis that captures endogenous variable behavior. Hence, we plot our endogenous variables on this single vertical straight axis that is represented by α . Second, each exogenous variable in an analysis is represented by its specific sub-coordinate system such as $\beta_{<SSi,Dj>}$, where “ SS_i ” represents the sub-space level in analysis, in this case either from sub-space level zero (SS_0^0) to sub-space level infinite (SS_{360}^∞), and “ D_j ” represents the disk level in analysis at the same quadrant of exogenous variables (in our case, from disk level 1 = D_1 , disk level 2 = D_2 , disk level 3 = D_3 , ..., to disk level D_ω). In fact, we as-



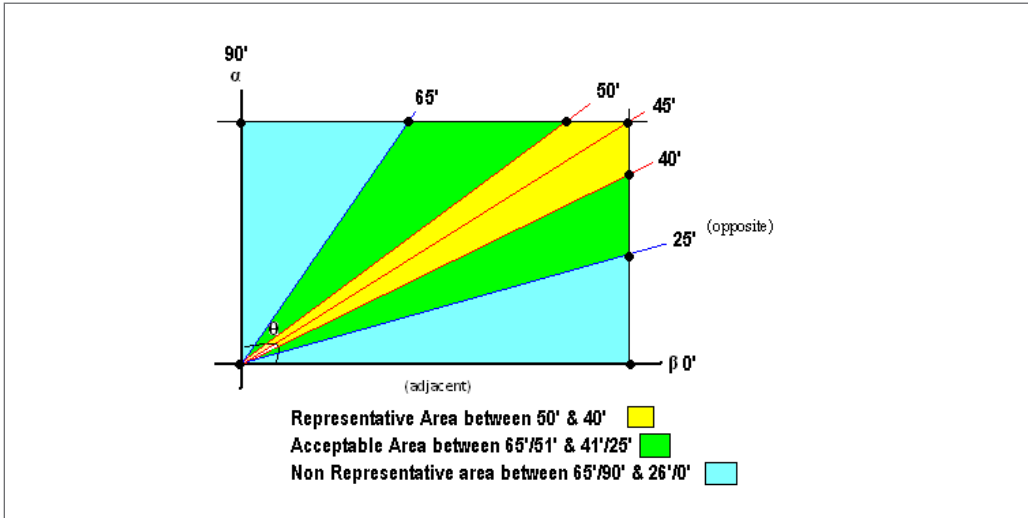

Figure 3. $\tan(\beta/\alpha)^{-1}$

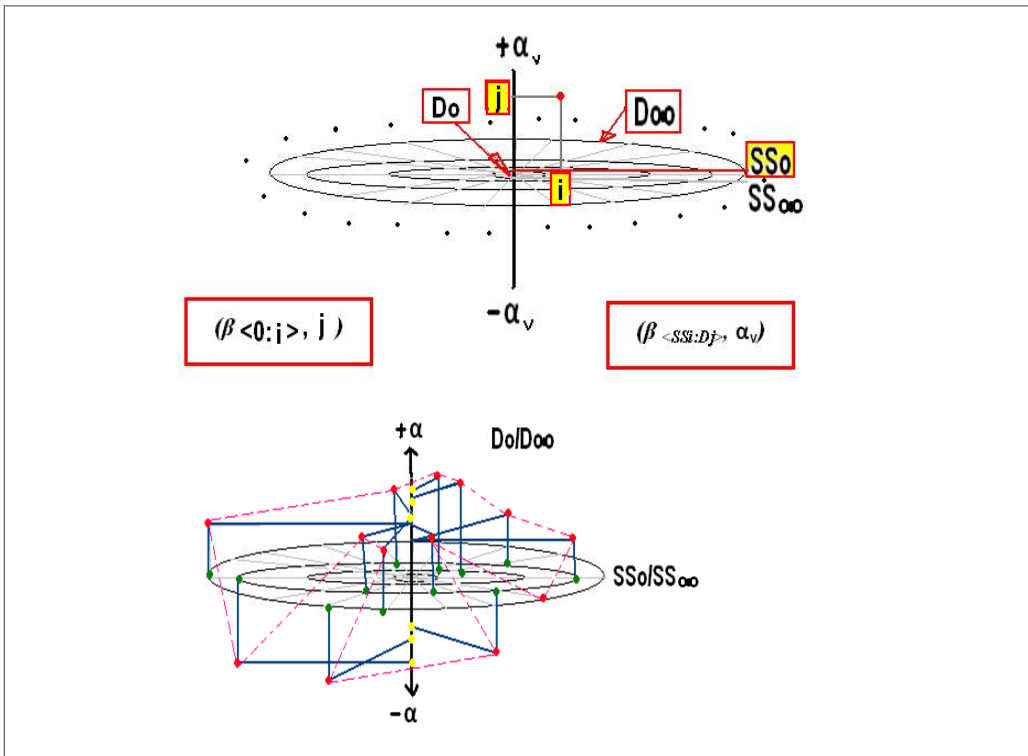

Figure 4. The Mega-Dynamic Disks Coordinate Space in Vertical Position

Source: Adapted from "An introduction to the mega-dynamic disks coordinate space in vertical and horizontal position", by Ruiz Estrada (2014) in *Malaysian Journal of Sciences*, 33(2), 105-109.

sume that all exogenous variables use only real positive numbers (R_+). To plot different exogenous variables in the mega-dynamic disks multivariable random coordinate space in vertical position, each value needs to be plotted directly on its radial subspace in analysis (SS_i) and disk level in analysis (D_j). Each i is a radius that emanates from the origin and is defined by the angle that can range from 0 to just under 360° , a theoretically infinite range. Each disk is a concentric circle that starts from the origin moving outward toward a theoretical infinite value. At the same time, all of these values plotted in different subspace levels in analysis (SS_i) and disk levels in analysis (D_j) need to be joined with its endogenous variable “ α ” until we build a series of coordinates. These coordinates need to be joined by straight lines until they yield an asymmetric spiral-shaped geometrical figure with n -faces (see Figure 4). It is important to mention at this juncture that the endogenous variable “ α ” is fixed according to any change associated with its corresponding exogenous variables in $\beta_{\langle SS_i; D_j \rangle}$ where $i = \{0^\circ, 1^\circ, 2^\circ, \dots, 360^\circ\}$ and $j = \{0, 1, 2, \dots, \infty, \dots\}$, α . Hence, we can imagine a large number of exogenous variables moving constantly in different positions within its radius in real time. We can simultaneously visualize how all of these exogenous variables directly affect the behavior of the endogenous variable (α). Moreover, the endogenous variable (α) can fluctuate freely (see Figure 4). In our case, the endogenous variables (α) can show positive/negative properties according to our multidimensional coordinate space. In the case of exogenous variables, these can only experience non-negative properties. The mega-dynamic disks multivariable random coordinate space in vertical position is represented by:

$$(\beta_{\langle SS_i; D_j \rangle}, \alpha) \text{ where } \beta \geq 0; i = \theta^\circ; j = R_+ \geq 0; \alpha = R_{+/-} \quad (1)$$

$$\alpha = f(\beta_{\langle SS_i; D_j \rangle}) \quad (2)$$

Hence, we are interested in applying a specific trigonometry function such as the tangent $/\tan(\beta/\alpha)$ and inverse tangent $\tan(\beta/\alpha)^{-1}$. Initially, the calculation of the tangent $/\tan(\beta/\alpha)$ is equal to β (adjacent) divided by α (opposite). We apply the absolute value to eliminate negative values in the construction of our Phillips curve. The main objective of calculating the inverse

tangent $\tan(\beta/\alpha)^{-1}$ is to find each angle that is located in the mega-dynamic disks coordinate space in vertical position. Therefore, the $\tan(\beta/\alpha)^{-1}$ can help us study the relationship between α (opposite) and β (adjacent) in different periods of analysis. In fact, we can establish three different parameters: (i) *the representative area* with angles between 50° and 40° ; (ii) *the acceptable area* located between $65^\circ/51^\circ$ and $41^\circ/25^\circ$; and (iii) *the non-representative area* between $65^\circ/90^\circ$ and $26^\circ/0^\circ$ (see Figure 3). Notably, each $\tan(\beta/\alpha)^{-1}$ is located between 0° and 90° .

Finally, all $\tan(\beta/\alpha)^{-1}$ results are organized in ascending order from the smallest angle to the largest angle. Finally, we transfer all of these results to the mega-dynamic disks coordinate space in vertical position to visualize the behavior of all angles that help us to appreciate clearly the behavior of the multidimensional Phillips curve.

6. The Transformation of the Phillips Curve into a Multidimensional Visualization

We intend to observe the non-linear behavior between unemployment and the rate of change of wage rates from two-dimensional and multidimensional perspectives. The analysis of the relationship between unemployment and the rate of change of wage rates is observed in Figure 4, which clearly shows the non-linear relationship between these two variables. In the case of the multidimensional graphical form of the Phillips curve, the non-linear behavior is clear through a descendent spiral curve that is displayed in the mega-dynamic disks multivariable random coordinate space in vertical position (see Figure 5). We can visualize its entirety from a multidimensional graphical space and time and note that the behavior of unemployment in relation to the rate of change of wage rates is non-linear. Before we start the construction of the Phillips curve in multidimensional graphical form, we refer to Phillips’ original manuscript(1958), “The Relation between Unemployment and the Rate of Change of Money Wage Rates in the United Kingdom, 1861-1957.” This paper is our main bibliographical source and database to build the Phillips curve from a multidimensional perspective using the mega-dynamic disks multivariable random coordinate space in vertical position. In Phillips’ paper (p. 285), we observe

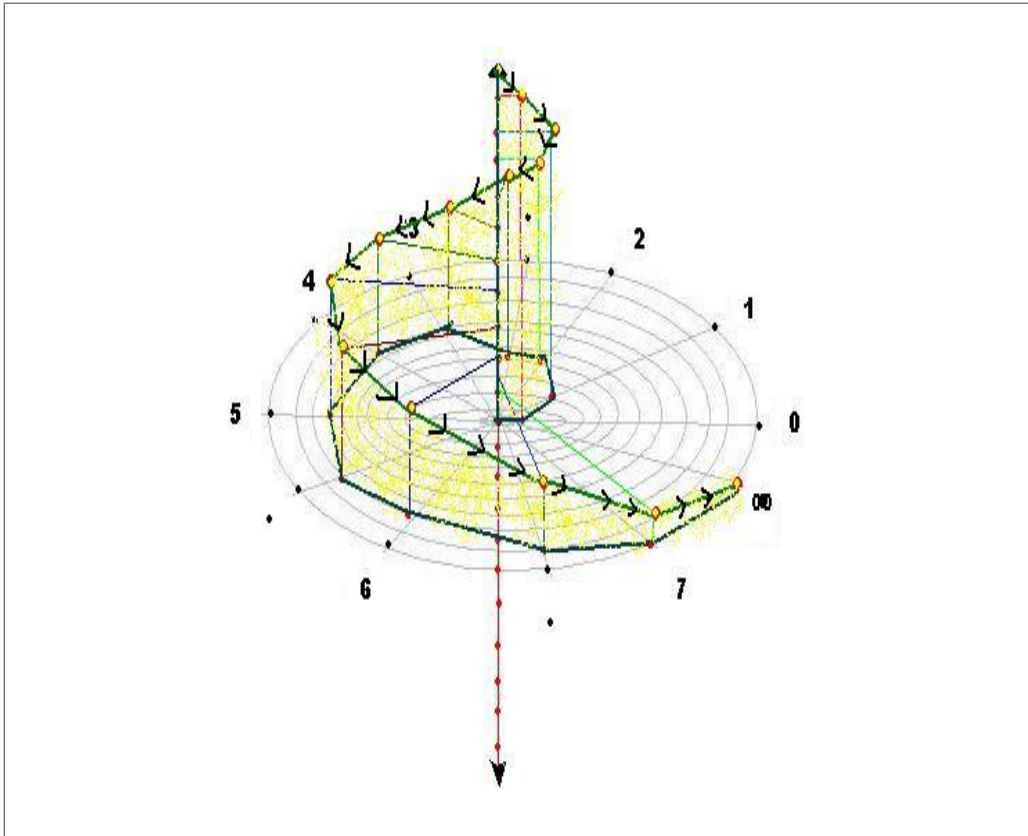

Figure 5. Relationship between the Average Rates of Change of Money & Average Unemployment

Source: Adapted from "The relation between unemployment and the rate of change of money wage rates in the United Kingdom, 1861-1957", by Phillips (1958) in *Economica*, 25(100), 283-299.

a simple scatter diagram that shows a large amount of data (points) spread between the first and fourth quadrant in the two-dimensional Cartesian plane. In fact, the large amounts of points represent different groups of coordinates reflecting the relationship between unemployment rates and wage rates. According to Phillips (1958), "Each dot in the diagrams represents a year, the average rate of change of money wage rates during the year being given by the scale on the vertical axis and the average unemployment during the year by the scale on the horizontal axis."

Moreover, in Figure 5, we also observe a curve that is based on a logarithmic equation in Phillips' paper (1958, p. 290). Phillips tries to show graphically the re-

lationship between the average rate of change of money wage rates during the year represented by the scale on the vertical axis (Y-axis or endogenous variable) and the average unemployment rate during the year represented on the horizontal axis (X-axis or exogenous variable). The unemployment rates can only be positive average rates. Hence, the unemployment average rates restriction is equal to $U = \{x|x: 0 \geq x \leq R_+\}$. The average rate of change of money wage rates has both positive and negative values. Therefore, the average rate of change of money wage rates restriction is equal to $W = \{x|x: R_- \leq x \leq R_+\}$. In Figure 5, we observe that Phillips plots 52 results showing the relationship between the average rate of change of money wage rates

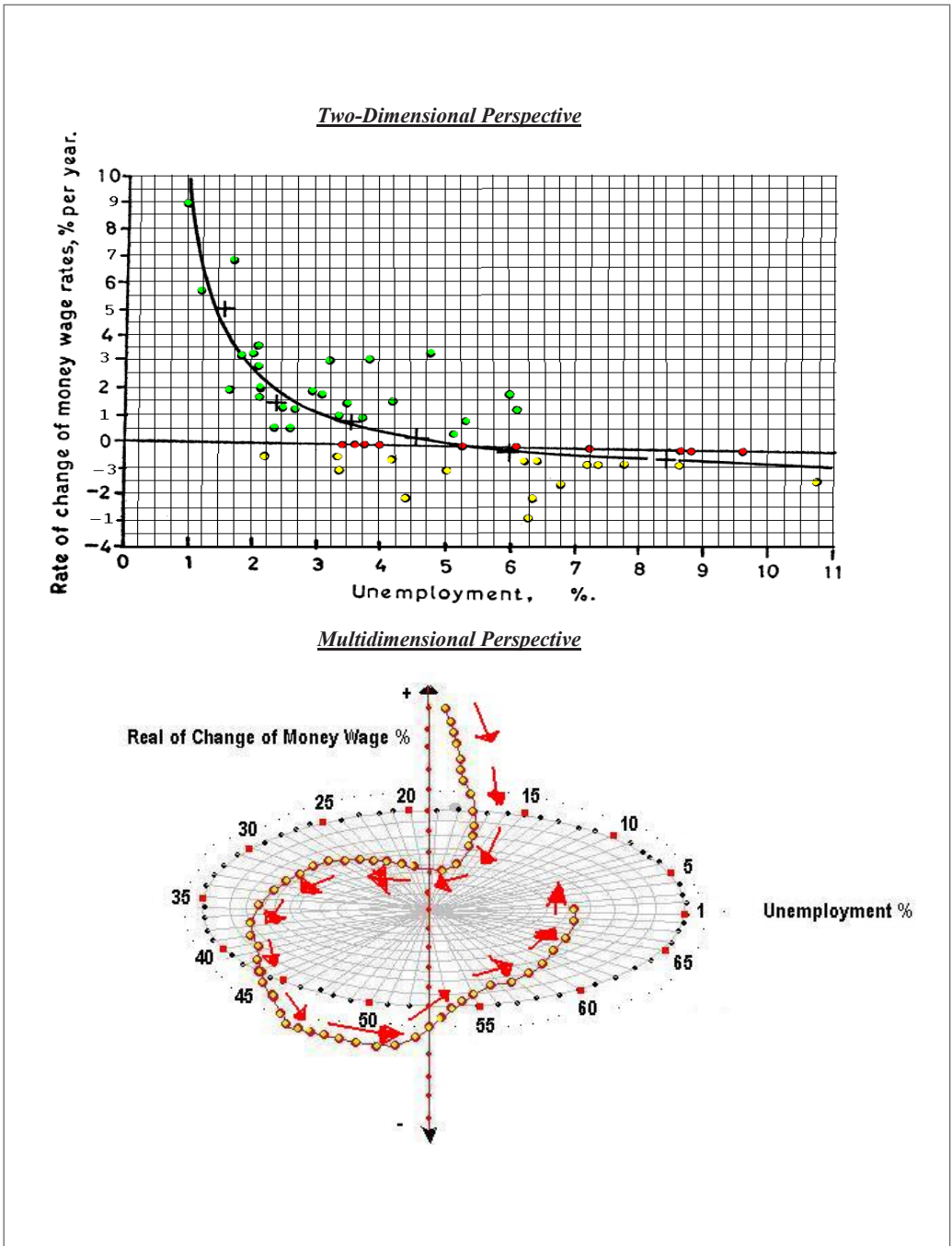

Figure 6. Relationship between the Average Rates of Change of Money & Average Unemployment
 Source: Adapted from "The relation between unemployment and the rate of change of money wage rates in the United Kingdom, 1861-1957", by Philips (1958) in *Economica*, 25(100), 283-299.

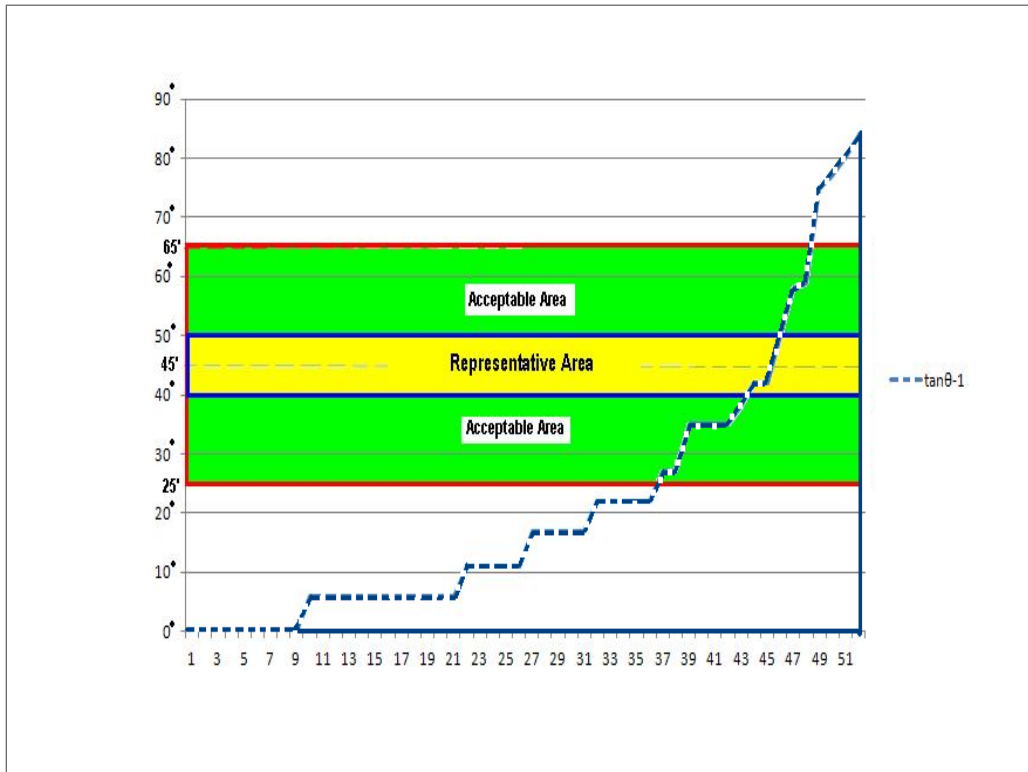

Figure 7. Multidimensional Phillips Curve Diagram

and the average unemployment rates from 1861 to 1913. Additionally, in Figure 6, we observe a perfect Phillips curve from a multidimensional perspective: when the average rate of change of money is high, there are low unemployment rates in the case of perfect competition. Hence, vertically higher positions (with higher money wage rates) are linked to the horizontal inner disk (lower unemployment).

7. Observations about the Difference between the Two-Dimensional and Multidimensional Graphical Models in the Visualization of the Phillips Curve

Figures 8, 9, 10, 11, 12, 13, 14, 15, 16 and 17 present the visualization of the Phillips curve from a multidimensional perspective. Each set of figures in this paper shows the two-dimensional and multidimen-

sional graphical models of the Phillips curve. Therefore, we clearly can appreciate the multidimensional graphical approach of the Phillips curve, which produces a multidimensional graphical optical effect compared to the two-dimensional perspective. Additionally, we can observe that the average rate of change of money wage rates and the average unemployment rates from 1861 to 1913 (see Figures 7, 8, 9 and 14) have a stronger interconnectivity. The advantage of using the multidimensional graphical approach for the Phillips curve is based on the location of the coordinates that are displayed and follow a logical trajectory in different spaces and time within the same multidimensional coordinate space. Moreover, we can observe how the Phillips curve displayed in different spaces generates a floating effect in the same graphical space. According to Figures 10, 11, 12, 13, and 14, we can observe a non-linear spiral-shape

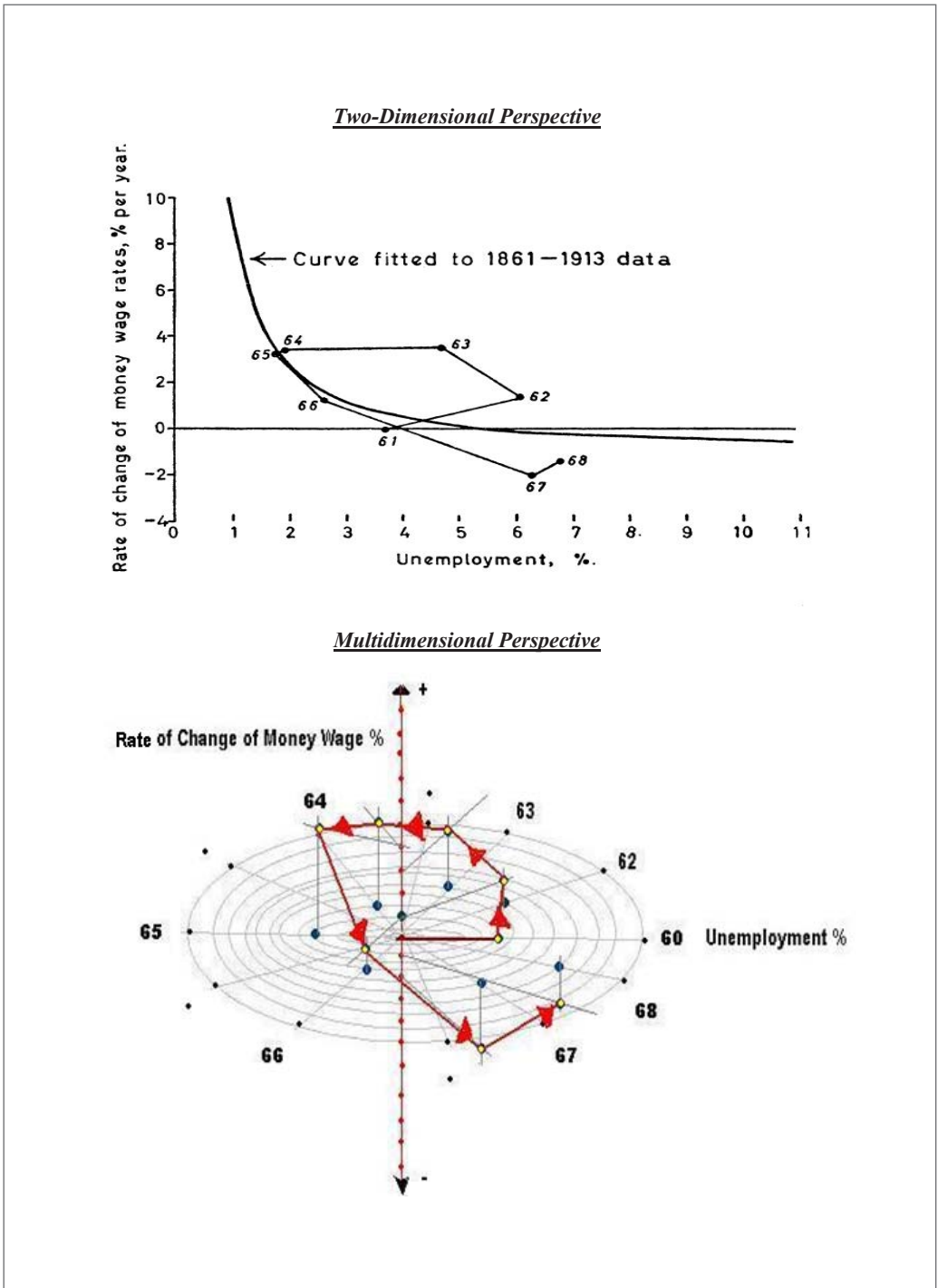

Figure 8. 1861-1913

Source: Adapted from "The relation between unemployment and the rate of change of money wage rates in the United Kingdom, 1861-1957", by Philips (1958) in *Economica*, 25(100), 283-299.

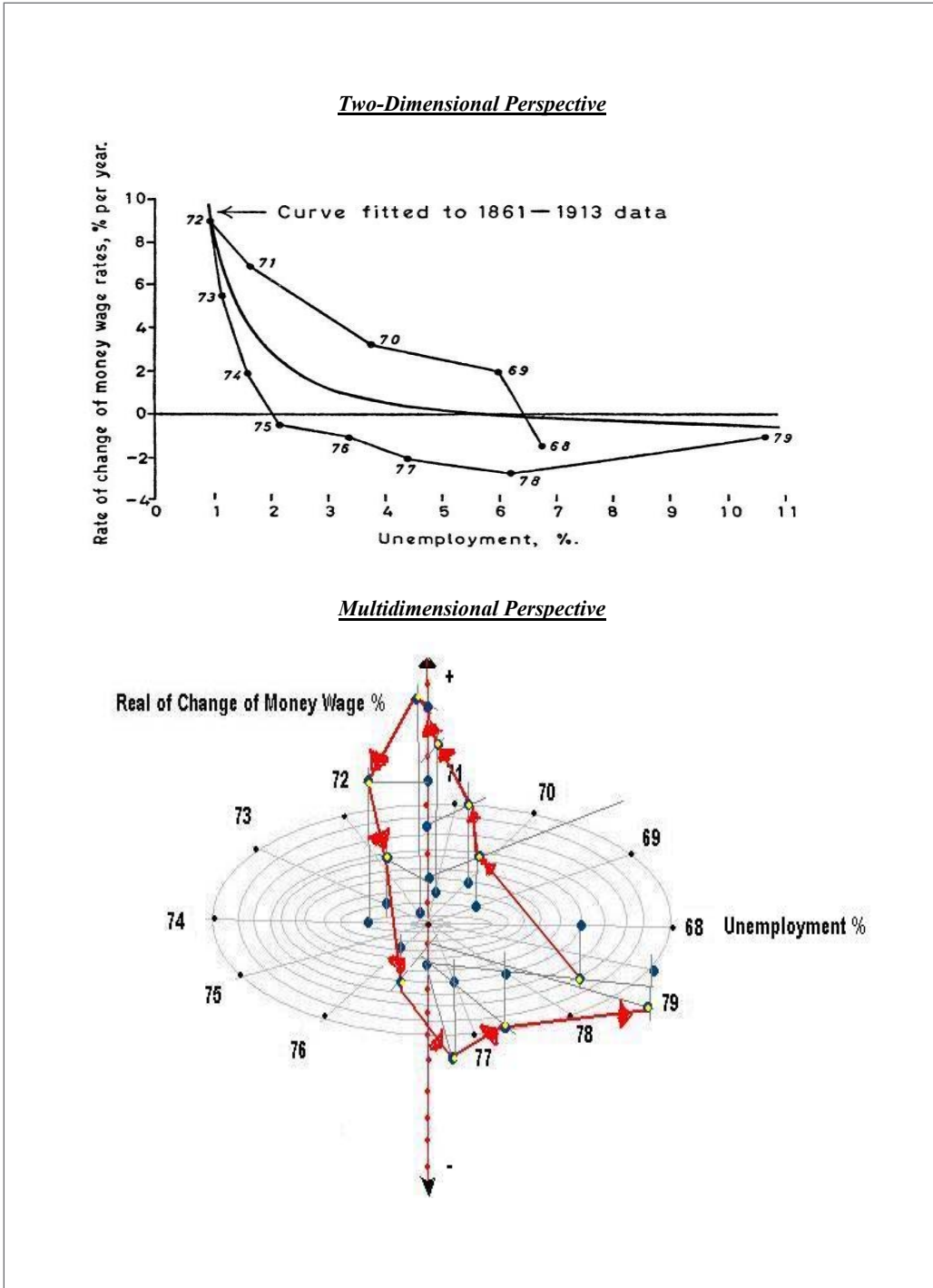

Figure 9. 1868-1879

Source: Adapted from "The relation between unemployment and the rate of change of money wage rates in the United Kingdom, 1861-1957", by Philips (1958) in *Economica*, 25(100), 283-299.

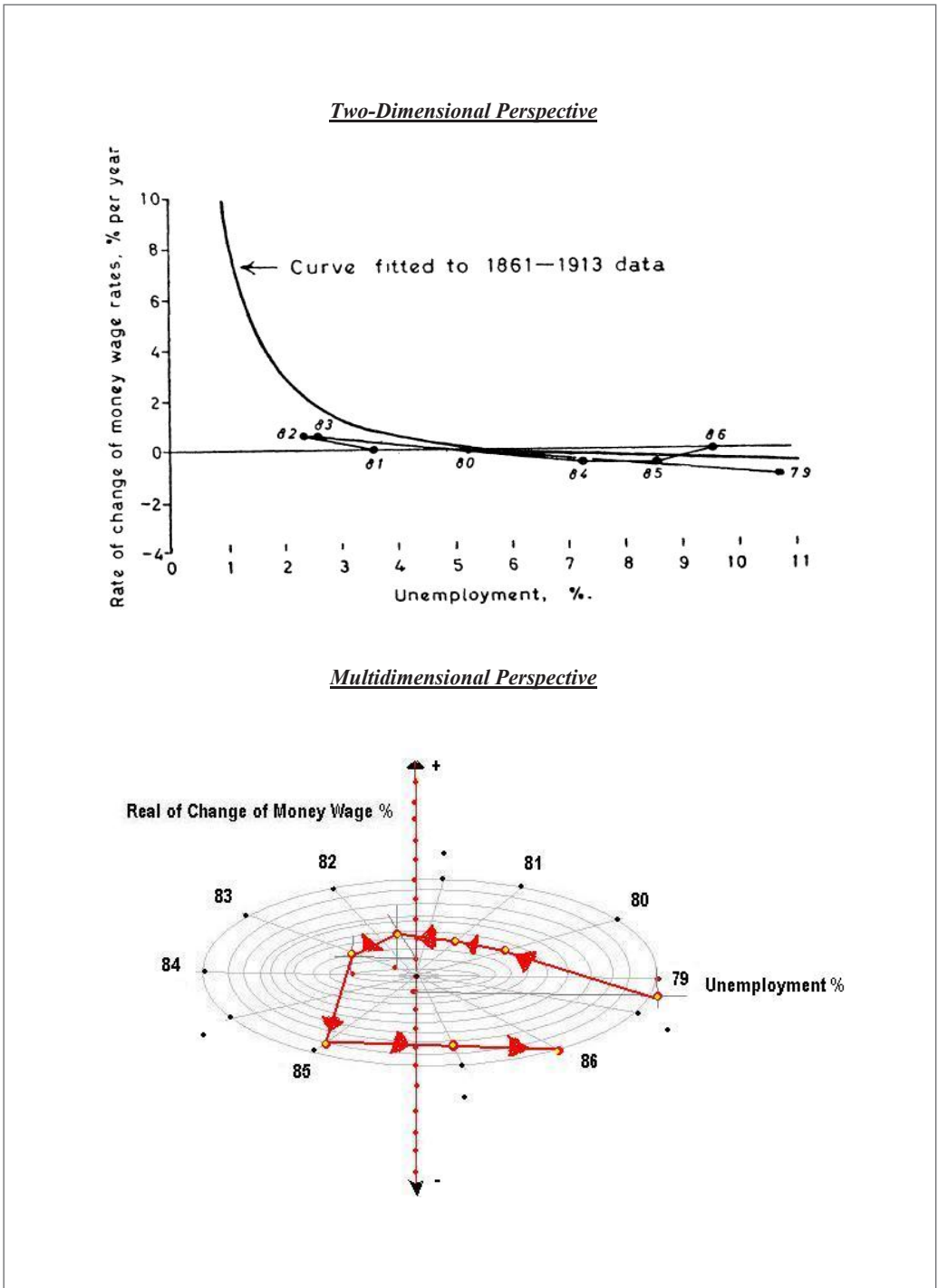

Figure 10. 1879-1886

Source: Adapted from “The relation between unemployment and the rate of change of money wage rates in the United Kingdom, 1861-1957”, by Philips (1958) in *Economica*, 25(100), 283-299.

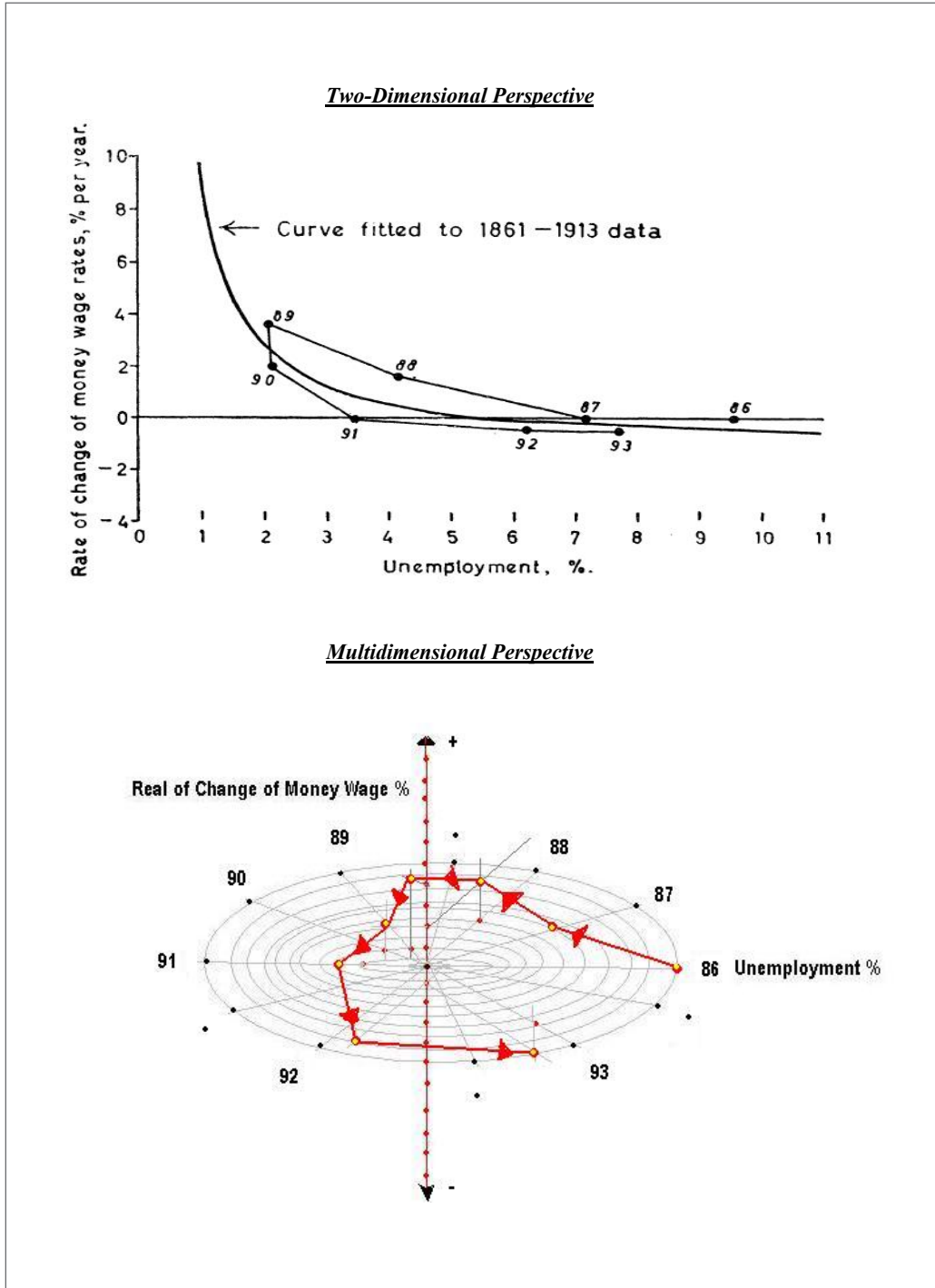

Figure 11. 1886-1893

Source: Adapted from "The relation between unemployment and the rate of change of money wage rates in the United Kingdom, 1861-1957", by Philips (1958) in *Economica*, 25(100), 283-299.

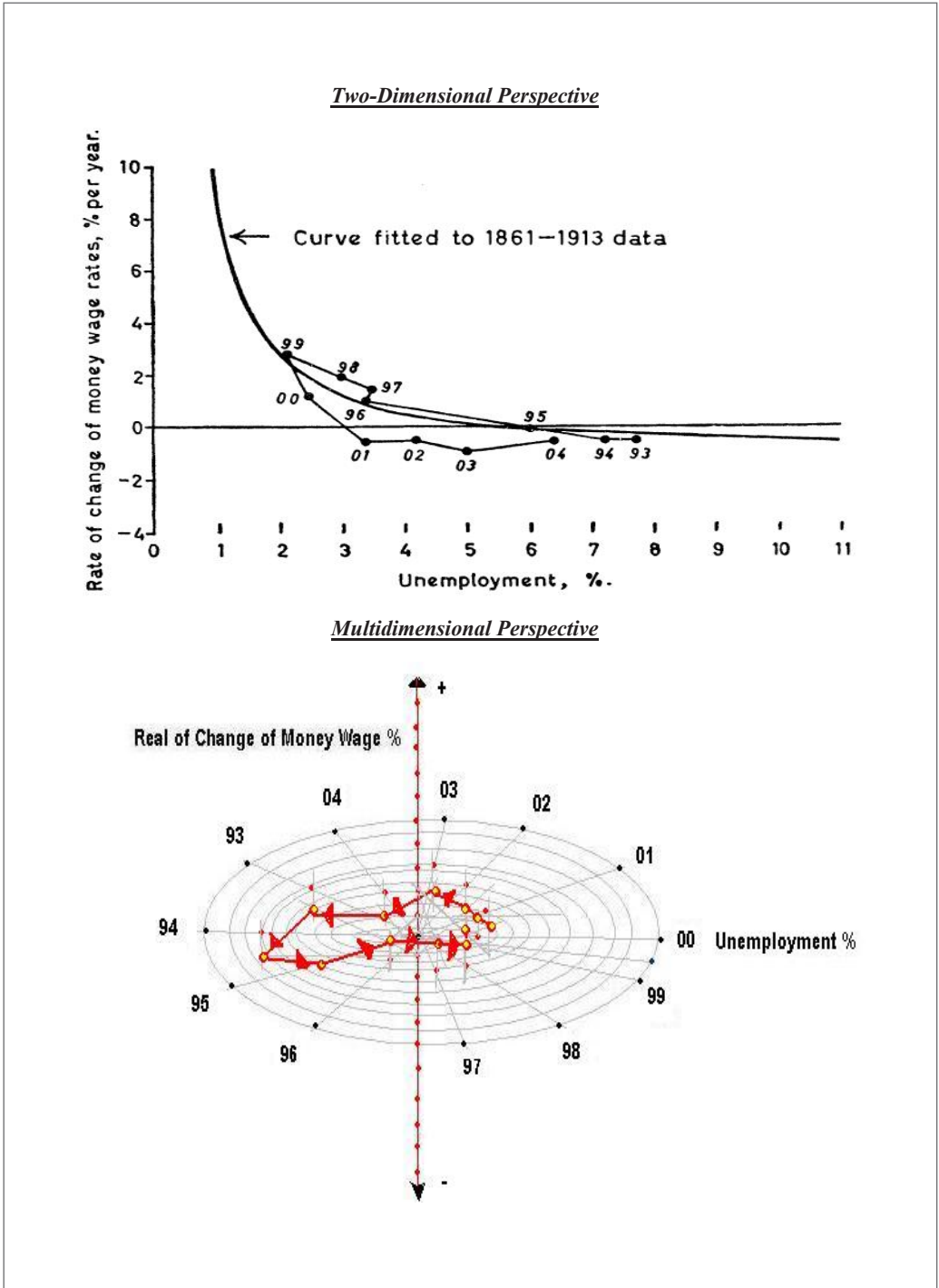

Figure 12. 1893-1904

Source: Adapted from "The relation between unemployment and the rate of change of money wage rates in the United Kingdom, 1861-1957", by Philips (1958) in *Economica*, 25(100), 283-299.

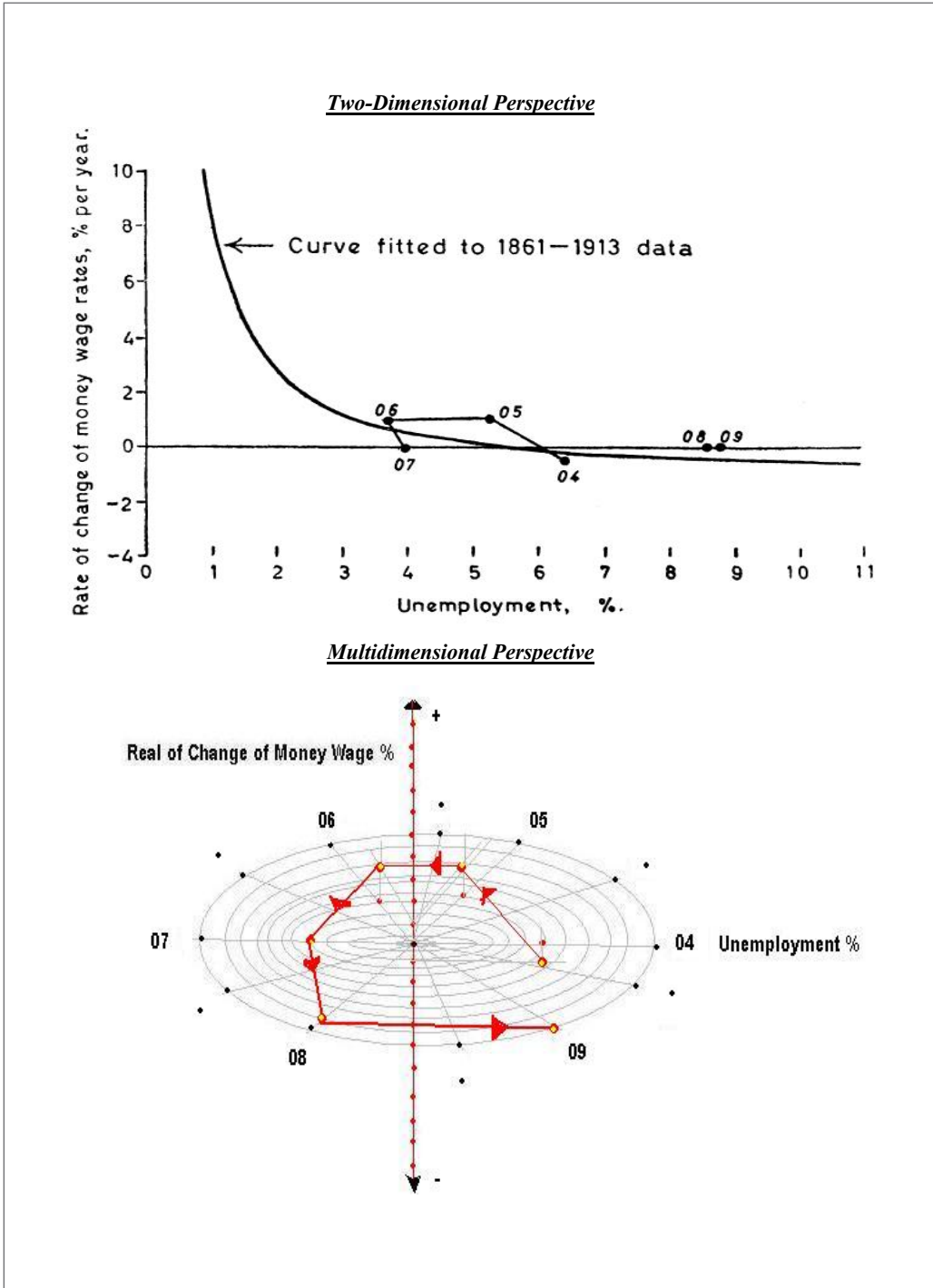

Figure 13. 1904-1909

Source: Adapted from "The relation between unemployment and the rate of change of money wage rates in the United Kingdom, 1861-1957", by Philips (1958) in *Economica*, 25(100), 283-299.

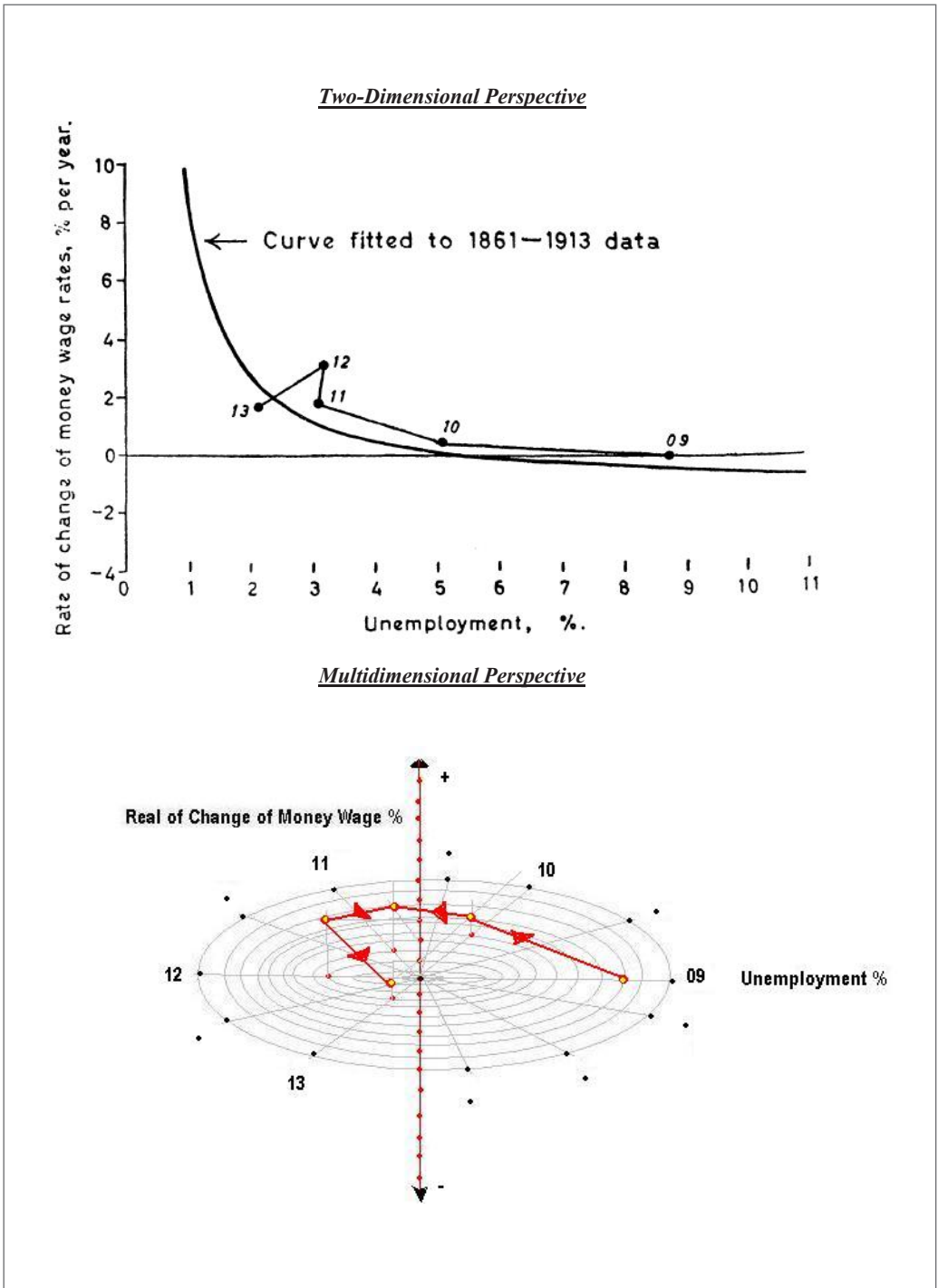

Figure 14. 1909-1913

Source: Adapted from “The relation between unemployment and the rate of change of money wage rates in the United Kingdom, 1861-1957”, by Philips (1958) in *Economica*, 25(100), 283-299.

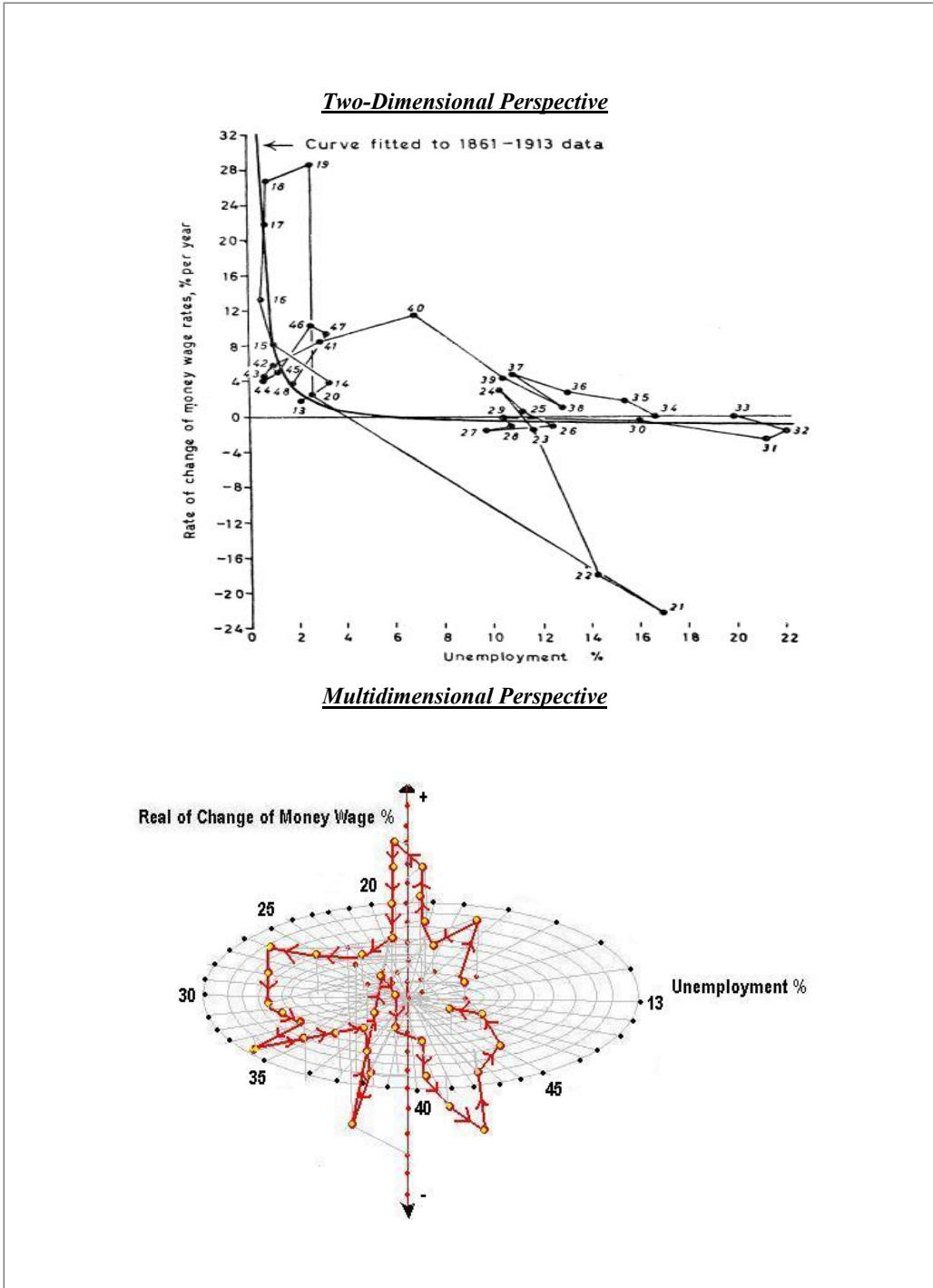

Figure 15. 1913-1948
Source: Adapted from "The relation between unemployment and the rate of change of money wage rates in the United Kingdom, 1861-1957", by Philips (1958) in *Economica*, 25(100), 283-299.

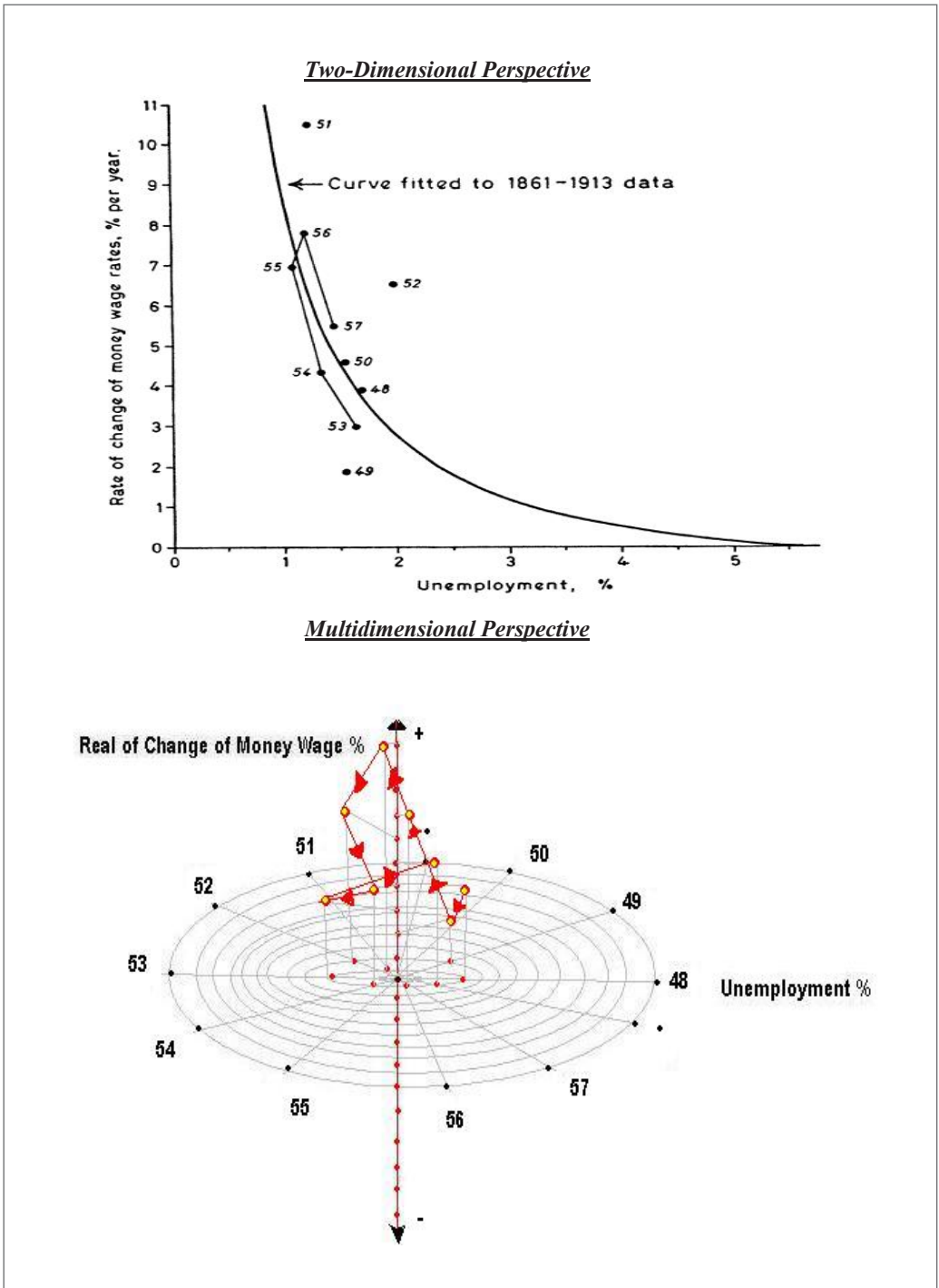

Figure 16. 1948-1957

Source: Adapted from "The relation between unemployment and the rate of change of money wage rates in the United Kingdom, 1861-1957", by Philips (1958) in *Economica*, 25(100), 283-299.

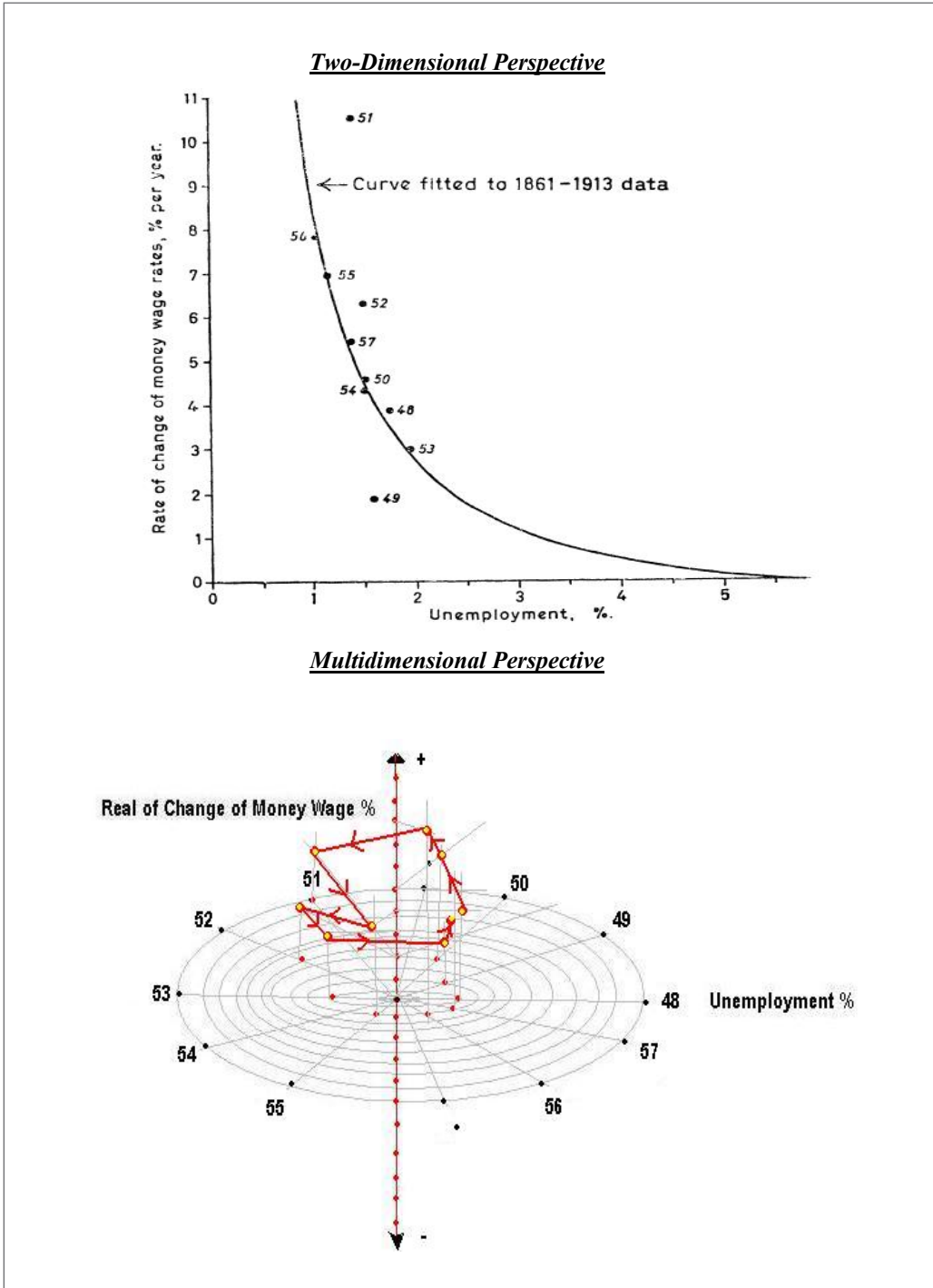

Figure 17. 1948-1957

Source: Adapted from "The relation between unemployment and the rate of change of money wage rates in the United Kingdom, 1861-1957", by Philips (1958) in *Economica*, 25(100), 283-299.

graphical form with a logical trajectory showing the tendency of the rate of change of money wage rates to be high when unemployment is low and to be low or negative when unemployment is high. Figure 15 confirms Phillips' proposition (1958) that "The clear tendency for the rate of change of money wage rates at any given level of unemployment to be above the average for that level of unemployment when unemployment is decreasing during the upswing of a trade cycle and to be below the average for that level of unemployment when unemployment is increasing during the downswing of a trade cycle." According to Phillips (1958), the results shown in Figure 8 are obtained given the typical relation between the rate of change of wage rates and the level and rate of change of unemployment. In fact, as Phillips (1958) concluded, "The rate of change of money wage rates can be explained by the level of unemployment and the rate of change of unemployment, except in or immediately after those years in which there is a sufficiently rapid rise in import prices to offset the tendency for increasing productivity to reduce the cost of living." This is observed in Figures 16 and 17. Finally, we can observe in Figure 7 that when we applied $1/\tan(\beta/\alpha)$ and $\tan(\beta/\alpha)^{-1}$ in each result between the change of money wage rates and the average unemployment rates progressed from 1861 to 1913 in descending order, we can observe that the fifty-two inverse tangent results $\tan(\beta/\alpha)^{-1}$ were plotted in descending order (from smallest angles to largest angles). It is possible to observe that a conic helix figure is displayed perfectly from the bottom to the top of the mega-dynamic disks coordinate space in vertical position. We are assuming that there are not any negative tangent result $\tan(\beta/\alpha)^{-1}$ in the process for building the multidimensional Phillips curve.

8. Conclusion

We can confirm that A. W. Phillips' research (1958) shows a strong relationship between unemployment and wage rates. Phillips' major contribution is the innovative graphical framework and the application of basic statistics to build a fitted curve for different periods of time. He also plots different points around the curve to fit and interconnect these coordinates with straight lines. At first glance, each figure looks chaotic and non-logical, lacking interconnectivity among

these coordinates. According to Phillips (1958), "Each dot in the diagrams represents a year, the average rate of change of money wage rates during the year being given by the scale on the vertical axis and the average unemployment during the year by the scale on the horizontal axis." This paper captures multidimensional graphical modeling based on the mega-dynamic disks multivariable random coordinate space in vertical position that we proposed. We clearly observe the relationship between unemployment and wage rates in a logical and systematic order. Hence, we demonstrate how a non-linear, spiral-shape graphical representation construction can be plotted from the top to the bottom of the mega-dynamic disks multivariable random coordinate space in vertical position. From a multidimensional perspective, the Phillips curve is displayed and follows a consistent behavior to prove that there is a strong relationship between unemployment and wage rates. We affirm A. W. Phillips' great contribution in economics, but as his graphical modeling was restricted to a two-dimensional approach, it was unable to explore more than a basic relationship between unemployment and the rate of change of money wage. We conclude that A. W. Phillips left a great legacy; his huge contribution to economics still persists today.

References

- Apergis, N. (2013). The stylized facts of Greek inflation: New evidence on persistence. *Panoeconomicus*, 60(1), 51-71.
- Ball, L., & Sandeep, M. (2011). Inflation dynamics and the great recession (Working Papers No. 11/121). National Bureau of Economic Research, Inc. Retrieved from <https://www.imf.org/external/pubs/ft/wp/2011/wp11121.pdf>
- Boland, L. (1981). Satisficing in methodology: A Reply. *Journal of Economic Literature*, 19(1), 84-86.
- Carrasco, C. A., & Ferreiro, J. (2011). Inflation targeting and economic performance: The case of Mexico. *Panoeconomicus*, 58(5), 675-692.
- Cohn, E., Cohn, S., Balch, D. C., & Bradley, J. (2001). Do graphs promote learning in principles of economics? *The Journal of Economic Education*, 32(4), 299-310.
- Cohn, E., Cohn, S., Balch, D. C., & Bradley, J. (2004). The relation between student attitudes toward

- graphs and performance in economics. *The American Economist*, 48(2), 41-52.
- Friedman, M. (1968): The Role of Monetary Policy. *American Economic Review*, 58(1), 1-17.
- Fuhrer, J. & Moore, G. (1995). Inflation persistence. *The Quarterly Journal of Economics*, 110 (1), 127-159.
- Josifidis, K., Pucar, E. B., Srdić, S., Ivan, G. (2014). Inflation targeting in advanced vs. emerging economies before and after the crisis. *Panoeconomicus*, 61(1), 79-106.
- Lucas, R. E., & Sargent, T. J. (1981). *Rational Expectations and Econometric Practice*. Minneapolis, MN: The University of Minnesota Press.
- Maas, H. (2005). *William Stanley Jevons and the making of modern economics*. Cambridge, UK: Cambridge University Press.
- Mirowski, P. (1991). The when, the how and the why of mathematical expression in the history of economics analysis. *The Journal of Economic Perspectives*, 5(1), 145-157.
- Pencavel, J. (2011). Real wage index numbers. *The American Economic Review*, 101(3), 565-570.
- Phillips, A. W. (1958). The relation between unemployment and the rate of change of money wage rates in the United Kingdom, 1861-1957. *Economica*, 25(100), 283-299.
- Playfair, W. H. (2005). *Commercial and political atlas and statistical breviary*. Cambridge, UK: Cambridge University Press.
- Ruiz Estrada, M. A. (2011a). Multi-dimensional coordinate spaces. *International Journal of Physical Sciences*, 6(3), 340-357.
- Ruiz Estrada, M. A. (2011b). Policy modeling: Definition, classification, and evaluation. *Journal of Policy Modeling*, 33(4), 523-536.
- Ruiz Estrada, M. A. (2014). An introduction to the mega-dynamic disks coordinate space in vertical and horizontal position. *Malaysian Journal of Sciences*, 33(2), 105-109.
- Wise, M. N. (2011). What (good) is historical epistemology? *Erkenntnis*, 75(3), 349-376.