

Biewen, Martin; Tapalaga, Madalina

Working Paper

Early Tracking, Academic vs. Vocational Training and the Value of 'Second Chance' Options

IZA Discussion Papers, No. 11080

Provided in Cooperation with:

IZA – Institute of Labor Economics

Suggested Citation: Biewen, Martin; Tapalaga, Madalina (2017) : Early Tracking, Academic vs. Vocational Training and the Value of 'Second Chance' Options, IZA Discussion Papers, No. 11080, Institute of Labor Economics (IZA), Bonn

This Version is available at:

<https://hdl.handle.net/10419/173990>

Standard-Nutzungsbedingungen:

Die Dokumente auf EconStor dürfen zu eigenen wissenschaftlichen Zwecken und zum Privatgebrauch gespeichert und kopiert werden.

Sie dürfen die Dokumente nicht für öffentliche oder kommerzielle Zwecke vervielfältigen, öffentlich ausstellen, öffentlich zugänglich machen, vertreiben oder anderweitig nutzen.

Sofern die Verfasser die Dokumente unter Open-Content-Lizenzen (insbesondere CC-Lizenzen) zur Verfügung gestellt haben sollten, gelten abweichend von diesen Nutzungsbedingungen die in der dort genannten Lizenz gewährten Nutzungsrechte.

Terms of use:

Documents in EconStor may be saved and copied for your personal and scholarly purposes.

You are not to copy documents for public or commercial purposes, to exhibit the documents publicly, to make them publicly available on the internet, or to distribute or otherwise use the documents in public.

If the documents have been made available under an Open Content Licence (especially Creative Commons Licences), you may exercise further usage rights as specified in the indicated licence.

DISCUSSION PAPER SERIES

IZA DP No. 11080

**Early Tracking, Academic vs. Vocational
Training and the Value of 'Second Chance'
Options**

Martin Biewen
Madalina Tapalaga

OCTOBER 2017

DISCUSSION PAPER SERIES

IZA DP No. 11080

Early Tracking, Academic vs. Vocational Training and the Value of 'Second Chance' Options

Martin Biewen

University of Tübingen and IZA

Madalina Tapalaga

University of Tübingen

OCTOBER 2017

Any opinions expressed in this paper are those of the author(s) and not those of IZA. Research published in this series may include views on policy, but IZA takes no institutional policy positions. The IZA research network is committed to the IZA Guiding Principles of Research Integrity.

The IZA Institute of Labor Economics is an independent economic research institute that conducts research in labor economics and offers evidence-based policy advice on labor market issues. Supported by the Deutsche Post Foundation, IZA runs the world's largest network of economists, whose research aims to provide answers to the global labor market challenges of our time. Our key objective is to build bridges between academic research, policymakers and society.

IZA Discussion Papers often represent preliminary work and are circulated to encourage discussion. Citation of such a paper should account for its provisional character. A revised version may be available directly from the author.

ABSTRACT

Early Tracking, Academic vs. Vocational Training and the Value of 'Second Chance' Options¹

This paper employs the dynamic treatment effects methodology proposed by Heckman et al. (2016, 2017) to examine educational transitions and expected returns in the German education system which is characterized by rigid early tracking but with options to revise track choices at later stages. We document strong sorting of individuals along observed and unobserved characteristics across the stages of the system. We consider expected wage returns to track choices including the continuation values arising from the options opened up by choosing a certain track. Expected returns to choosing higher tracks are generally positive but highly heterogeneous. We find sorting on gains at many but not all stages of the system. A considerable percentage of the population exercises 'second chance' options to revise earlier track choices. The value of these options strongly depends on parental background as individuals from higher backgrounds are better able to exploit the possibilities opened up by these options at later stages. We present estimates of wage returns to different forms of vocational and academic training free of ability and sorting bias. Returns to academic training are particularly heterogeneous.

JEL Classification: C3, I21, I26, J31

Keywords: heterogeneous returns, vocational training, educational expansion, sorting on gains

Corresponding author:

Martin Biewen
School of Business and Economics
University of Tübingen
Mohlst. 36
72074 Tübingen
Germany
E-mail: martin.biewen@uni-tuebingen.de

¹ We would like to thank Bernhard Boockmann, Joachim Grammig, Steffen Hillmert, Aderonke Osikominu, Gregor Pfeiffer, Winfried Pohlmeier, Nicole Tieben, Ulrich Trautwein, Katharina Weßling as well as participants at ESPE 2017, EEA-ESEM 2017, EALE 2017, the LEAD spring retreat 2017, the IAW Conference 'Education, Skills, and the Economic Challenges of the Future' and the GSDS Doctoral Workshop 2017 at Lake Konstanz for many useful comments and suggestions. This paper uses data from the National Educational Panel Study (NEPS): Starting Cohort 6 – Adults, doi:10.5157/NEPS:SC6:3.0.1. From 2008 to 2013, NEPS data were collected as part of the Framework Programme for the Promotion of Empirical Educational Research funded by the German Federal Ministry of Education and Research (BMBF). As of 2014, the NEPS survey is carried out by the Leibniz Institute for Educational Trajectories (LifBi) at the University of Bamberg in cooperation with a nationwide network.

1 Introduction

A large literature has studied the returns to education and their relationship to educational choices (see Card, 2001, Heckman et al., 2006, and Belzil, 2007, for overviews). In many education systems, educational choices take the form of a decision about whether or not to add another year or another stage of the system to one's educational qualification. This motivates the use of years of education as a measure of educational qualifications. However, there is a large number of education systems that do not exhibit this linear structure but are characterized by multiple tracks, different stages and potentially complex routes to final educational degrees. This is particularly true of systems with a tracking structure which stream individuals into different tracks, often at an early age. Aspects that have been found to be important for education systems with a more linear structure such as dynamic ability sorting (Cameron and Heckman, 1998, 2001) and heterogeneous returns to individual transitions (e.g., Heckman et al., 2006) appear even more important in systems with multiple stages and multiple tracks. Importantly, these aspects are related to a number of features of tracked education systems that have been considered as critical, such as whether these systems are able to efficiently allocate individuals to final educational qualifications, or whether overly rigid tracking structures lock individuals into certain tracks.

The aim of this paper is to study educational transitions and heterogeneous returns to these transitions in the German education system. From an international perspective, the German system is of particular interest. First, it 'is considered today the starkest example of early tracking' (Brunello et al., 2012). The system streams individuals into three different branches of secondary schooling at an extremely early age (typically ten years). While it is clear that this is likely to have long-term consequences for the individuals concerned, it is less known that the system provides the possibility to switch tracks at many points and to take indirect routes to particular educational outcomes. As we show below, a remarkably high proportion of individuals takes such indirect routes through the system. A question that has hitherto been unstudied is what the value of such 'second chance' options is in terms of expected outcomes. Another feature of the German system that has attracted international attention is that it provides strong institutionalized branches of vocational training on the one hand, and varieties of academic training on the other. Its system of vocational training is highly reputed and considered by many as a potential role model for other countries, especially those with high youth unemployment rates. In general, vocational education

training systems (VET) serve to facilitate the labor market entry of young people and to mediate the demand for vocational qualifications required by the economy (OECD, 2010, Eichhorst et al., 2015). In the German system, a vocational training degree is considered as a viable alternative to academic training. It is important to note that the two aspects - early tracking on the one hand and the bifurcation into vocational and academic training on the other - are intimately related as particular secondary tracks in the German school system typically either prepare for vocational or for academic training. It is an interesting question how the existence of 'second chance' options is capable of relaxing the apparently rigid structure of the system.

This paper employs the dynamic treatment effects methodology proposed by Heckman et al. (2016, 2017) in order to model the sequence of all relevant educational transitions in the German education system jointly with the associated wage outcomes at the relevant final degrees. Our paper seems to be one of the first ones to apply this framework to a decision environment that is considerably more complex than the college vs. no college decision often considered in education economics. We consider a richer set of educational transitions and a richer set of final educational qualifications than studied in previous contributions. In particular, we not only model basic track choices but also decisions to upgrade to higher tracks or to add further qualifications after already having completed certain degrees. We also consider degrees that have not or that have rarely been studied before such as the advanced vocational degree of a master craftsman or the choice between different types of academic education (general universities vs. more practically oriented universities of applied sciences). We explicitly allow for heterogeneous returns to individual decisions in the system depending on observed and unobserved characteristics. This allows us to address the question whether individuals sort into particular branches of the system based on their expected gains. We compute counterfactual expected wages of individuals by forcing them to start from tracks from which they in fact did not start, taking account of all the continuation possibilities opened up by choosing a particular track. Finally, we evaluate the value of the 'second chance' options built into the system, i.e. the expected wage return to upgrading decisions including all continuation possibilities opened up by switching to a higher track.

The rest of the paper is structured as follows. Section 2 discusses some related literature. Section 3 describes details of the German education system. Section 4 outlines our econometric methods. Section 5 introduces the data on which our analysis is based. In section 6, we present and discuss our empirical results. Section 7 concludes.

2 Related literature

Our paper connects to at least three different strands of literature. The first literature we relate to is that on tracked education systems (for an overview, see Betts, 2011). Brunello and Checchi (2007) summarize the pros and cons of tracking in education systems. The potential benefits of tracking include gains from specialization, non-linear peer effects, signalling and better targeting of curriculae, leading to a potentially higher average educational output. The disadvantages include the potential missallocation of students to tracks, a loss of versatility, increasing educational inequality, and the reduction of equality of opportunity. A number of theoretical contributions have shown that tracked vs. non-tracked systems do not unambiguously dominate each other with respect to efficiency or equity (Epple et al., 2002, Brunello and Giannini, 2004, Brunello and Checchi, 2007). The performance of tracking systems has also been studied in several cross-country studies (Hanushek and Wössmann, 2006, Brunello and Checchi, 2007, Ammermüller, 2012, Wössmann, 2016). Hanushek and Wössmann (2006) conclude that early tracking increases inequality in achievement scores, while at the same time not increasing mean performance. Brunello and Checchi (2007) examine longer-term outcomes of tracking and find that early tracking increases parental background effects on educational attainment and early labor market outcomes, but reduces them for literacy and participation in further training.

Dustmann (2004) studies long-term outcomes of track choice in the German system in association with parental background. He finds that both parental background and track choice translate into substantial earnings differentials later in life. In an innovative study, Dustmann et al. (2017) examine for a group of marginal students left and right of the birth date cut-off point that determines enrollment into elementary school, whether attending a higher rather than a lower secondary track yields differences in long-term outcomes. They find for this group of individuals that attending a more advanced track does not yield more favourable long-term outcomes. Dustmann et al. (2017) attribute this to the possibility that individuals who were originally misallocated to tracks have later the opportunity to correct their decisions (i.e. switch to a higher secondary track if originally misallocated to a lower track or not to enroll in university later although having graduated from the highest secondary track). Inspired by Dustmann et al. (2017), we will explicitly model these possibilities in our econometric model below.

The focus on built-in flexibilities of apparently rigid tracking systems also connects our analysis

to an emerging literature focussing on 'second chance' educational decisions. For example, the General Educational Development (GED) certificate in the U.S. is considered to offer a 'second chance' to high school dropouts to obtain a proper educational qualification. The potential returns to this 'second chance' education have been studied by Heckman and Lafontaine (2006), Jepsen et al. (2017) and Heckman et al. (2016, 2017), among others. Also see Heckman et al. (2011) for an overview. 'Second chance' decisions and 'non-standard' paths through educational systems have also been the focus of a number of recent studies in sociology (Hillmert and Jacob, 2010, Jacob and Tieben, 2009, Tieben and Wolbers, 2010, Buchholz and Schier, 2015, Schindler, 2017), although these studies usually do not consider long-term outcomes. The study by Dustmann et al. (2017) appears to be one of the first ones to take into account long-term effects of built-in flexibilities in tracking systems. Modeling such flexibilities will be an important part in our analysis.

The second major literature we connect to is that on heterogenous returns to education. It has long been recognized that returns to education may differ between individuals. Previous contributions have considered returns that are heterogenous across observables (e.g. Henderson et al, 2011), and across unobservables (Harmon et al, 2003, Koop and Tobias, 2004, Balestra and Backes-Gellner, 2017). A number of contributions have considered the possibility that returns are correlated with unobservables leading to correlated random coefficient models (Garen, 1984, Blundell et al, 2005). For example, Gebel and Pfeiffer (2010) estimate the wage returns to the years of education in Germany using a random coefficient model based on Garen (1984). Also see Flossmann and Pohlmeier (2006) for a general overview of estimates of returns to education in Germany. Belzil and Hansen (2007) link the correlated random coefficients model to a structural dynamic programming model in order to investigate heterogenous wage returns to years of education.

Most recent contributions on heterogenous returns to education are based on the marginal treatment effects paradigm established by Heckman and Vytlacil (2005, 2007). This framework explicitly connects treatment effects to choice models and provides a more differentiated description of heterogeneity that may potentially be correlated with observables and unobservables. For example, Carneiro et al. (2011) estimate marginal returns to college education in the U.S. and find that individuals with higher expected returns are more likely to select into college education ('selection on gains'). Using a similar framework, Carneiro et al. (2016) examine heterogenous returns to attending upper secondary education in Indonesia. Extending the binary decision case

to more than two choice options, Rodriguez et al. (2016) model heterogeneous returns to four different educational alternatives after secondary education in Chile. Aakvik et al. (2010) consider heterogeneous returns to eight ordered educational alternatives in Sweden.

Considering a larger number of educational alternatives in a parallel fashion ignores the fact that educational decisions are often taken sequentially. This is particularly the case in education systems with tracking and multiple stages. There is only a small number of studies that explicitly deal with dynamic treatment effects that arise in such multi-stage decision environments. Selection problems are much more complicated in such environments due to the selection of individuals across multiple stages. Heckman and Navarro (2007) work out a detailed theory of such dynamic treatment effects. Related selection and evaluation problems have also been considered in other contexts with a more temporal structure, see e.g. Abbring and van den Berg (2003), Fredriksson and Johansson (2008), Lechner (2009), Osikominu (2013) or Biewen et al. (2014). Zamarro (2010) is one of the few papers that considers heterogeneous returns to educational decisions over more than one stage. She models heterogeneous returns to educational choices over two stages in the Spanish education system. Heckman et al. (2016) develop a framework for evaluating dynamic treatment effects over arbitrarily many stages using different sources of identification and apply it to estimate heterogeneous wage returns to different sequential decisions in the U.S. education system. Heckman et al. (2017) extend this work to various non-economic outcomes. We use the dynamic framework introduced by Heckman et al. (2016, 2017) in order to address a number of relevant aspects of the tracked, multiple-stage German education system.

The third and last strand of the literature we contribute to is that on the returns to vocational training. Institutionalized vocational training is not available in many countries so that evidence from a country with a strong vocational training track may be of some interest. A limited number of papers have examined the economic returns to vocational training, often in comparison with academic training, see e.g. Dearden et al. (2002), McIntosh (2006), Riphahn and Zibrowius (2016) and Balestra and Backes-Gellner (2017). Few contributions have tried to rule out endogenous selection effects into vocational training, e.g. by considering reforms or other sources of exogenous variation (Oosterbeek and Webbink, 2007, Fersterer et al., 2008, Malmud and Pop-Eleches, 2010, Albanese et al., 2017). Comparing academic vs. vocational training, Hanushek et al. (2017) and Brunello and Rocco (2017) have made the general point that, while vocational training may make initial labor market entry easier, its economic returns may depreciate over time due to its lower degree of adaptability (a point which we will not be able to address due

to data limitations). As one of the main branches of the higher education system in Germany is the vocational education track, our study contributes to the understanding of the selection into vocational vs. academic training and its potentially heterogenous long-term effects.

3 Overview of the German education system

The general structure of the German education system is as follows (see figure 1). State-provided education generally starts with non-compulsory pre-school education (*Kindergarten*) at age three (not shown in the figure). At around six years, all individuals enroll in the compulsory elementary school (*ES, Grundschule*) which typically lasts until the age of 10. After elementary school, individuals have to choose between three different secondary school tracks. The lowest track (*LS, Hauptschule*) lasting 5 years, as well as the middle track (*MS, Realschule*), lasting 6 years, typically prepare for subsequent vocational training. The upper secondary track (*US, Gymnasium*), taking 9 years, is academically oriented and aims at preparing students for tertiary education. The upper secondary track is similar to high school in the US system. Its final degree, the university entry certificate (*Abitur*), is the pre-condition for enrolling in tertiary education at universities (*U*) or universities of applied sciences (*UAS*), although there are some exceptions (in particular, individuals with vocational training may enroll in tertiary education without upper secondary degree if they are highly qualified). The tracking into the three secondary school types is generally by ability, although there are differences between federal states as to what extent parents may override teachers' recommendations.

— Figure 1 around here —

The pronounced tracking structure of the system has been subject to criticism because individuals are streamed into vocational and academic tracks at a very young age. Partly addressing this concern, there are a number of possibilities to revise earlier track choices at later stages when more information on the abilities of the individuals are available. In particular, individuals who graduate from the lower secondary track (*LS*) may continue their education at a middle secondary school (*MS*) or at another institution granting the middle secondary degree. Similarly, although harder, students who graduate from the middle track (*MS*) may upgrade to the upper secondary track (*US*), and obtain the upper secondary degree at an upper secondary school or another institution

that grants this degree. Such upgrading to higher degrees may take place years after having completed the lower track, and it has increased over time (for more details, see Schindler, 2017). Students may also downgrade to lower tracks at any time, but such transitions are relatively rare (see Biewen and Tapalaga, 2016).

After secondary school, individuals either start to work, continue their education in a vocational training program (*Voc*), or they enroll in tertiary education at universities (*U*) or universities of applied sciences (*UAS*). Vocational training generally includes classes at state-provided vocational schools along with training received from an employer. For more information on vocational education and training (VET) in Germany, see Brockmann et al. (2008), OECD (2010) and Eichhorst et al. (2015). Individuals who have completed vocational training and who have some minimum amount of work experience may obtain the degree of a master craftsman (*MC*) by taking additional examinations. The degree of a master craftsman enjoys a high reputation and typically qualifies the person to start their own business or to work as a team leader in industry or commerce. Tertiary education in Germany consists of two main branches: the general universities (*U*) and the more practically oriented universities of applied sciences (*UAS*). Studies at universities typically take longer and have a stronger academic orientation. Importantly, individuals graduating from the upper secondary track (*US*) not only have the option to start tertiary education, but they can also opt for vocational training. Although not a 'standard' route through the system, they may also first complete vocational training and then start tertiary education.

It is important to note that education in Germany is generally state-provided and free at all stages. Neither schools nor tertiary education institutions charged fees during the periods analyzed by us. Vocational training is generally provided by firms in combination with classes at state-financed vocational schools which also do not charge tuition fees. Training at firms is also free. Apprentices may earn a wage or a salary which is, however, lower than that of regular employees.

4 Econometric model

The aim of our econometric model is to model all possible routes through the education system shown in figure 1 jointly with the wage outcome equations for the different terminal educational degrees. Our model is very similar to the one used by Heckman et al. (2016, 2017) and Rodriguez

et al. (2016), although the education system studied here has more stages and a more non-linear structure than the ones studied in previous contributions.

4.1 Educational choices

The first ingredient of our model is a connected sequence of multinomial choice models for each of the decision nodes shown in figure 1. Denote J the set of all nodes at which an individual can make an educational transition. At node $j \in J$, the individual may choose an option $c \in C_j$, where C_j is the set of all options at j (the branches originating at a particular node in figure 1). A model for the probability that the individual chooses option $c \in C_j$ conditional on observed characteristics Z_j at node j , and conditional on an unobserved heterogeneity term θ , is given by

$$Pr(D_{j,c} = 1 | Z_j, \theta) = \frac{\exp(Z'_{j,c} \gamma_{j,c} + \alpha_{j,c} \theta)}{\sum_{c' \in C_j} \exp(Z'_{j,c'} \gamma_{j,c'} + \alpha_{j,c'} \theta)}, \quad (1)$$

where $D_{j,c}$ is a dummy indicating the choice of option c at node j (i.e. $\sum_{c' \in C_j} D_{j,c'} = 1$). The individual's characteristics Z_j at node j are assumed to also include the choices made at previous nodes. The parameters $\alpha_{j,c}$ capture the influence of unobserved heterogeneity θ on the decision for option c at node j .

The latent variable θ stands for unobserved characteristics such as unobserved aspirations, preferences or abilities which influence the choice at node j in addition to the observed characteristics. The introduction of unobserved heterogeneity θ not only controls for dynamic selection bias but also relaxes the assumption of independence of irrelevant alternatives if C_j contains more than two alternatives. Although θ is assumed to be uncorrelated with observed characteristics at the start of the tree, selection on unobservables may induce correlation of θ and observed characteristics for individuals who are left at later stages of the system (Cameron and Heckman, 1998, 2001). This will be the case if individuals with poor background characteristics only progress to higher stages if they have good unobserved characteristics. For example, it is plausible that individuals from poor backgrounds who progress 'against the odds' to higher stages have above average levels of motivation, ambition or ability. As in other econometric selection models, this may generate a correlation of observed explanatory variables with unobserved characteristics at higher stages, rendering these explanatory variables endogenous for the individuals who get to

these higher stages. In order to identify all $\alpha_{j,c}$, the variance of θ has to be normalized. We assume θ to be normally distributed conditional on observed covariates with mean zero and variance one. As common in multinomial logit models, the coefficients $\gamma_{j,c}$ of one $c \in C_j$ are set to zero.

A possible interpretation of model (1) is that the option c_j^* chosen by the individual at node j is the optimal choice for the individual given the situation at j , i.e.

$$c_j^* = \arg \max_{c \in C_j} V_{j,c}, \quad (2)$$

where $V_{j,c} = Z'_{j,c} \gamma_{j,c} + \eta_{j,c}$ with $\eta_{j,c} = \alpha_{j,c} \theta + \nu_{j,c}$ is the value of option $c \in C_j$, and the $\nu_{j,c}$ come from an extreme value distribution independently across $c \in C_j$ and conditional on observed covariates (Cameron and Heckman, 2001). In an alternative interpretation, equation (1) simply describes other behavioral mechanisms that link the choice at j to observed and unobserved characteristics Z_j and θ .

Each individual runs through the system until she reaches one of the terminal points $s \in \{LS \text{ terminal}, MS \text{ terminal}, US \text{ terminal}, Voc \text{ terminal}, MC, UAS, U\} = \mathcal{S}$ (see figure 1). The sequence of individual decisions $D = \{D_{j,c}, j \in J, c \in C_j\}$ will lead to a particular terminal state for the individual which we denote by $S \in \mathcal{S}$. Define indicator variables $I_s, s \in \mathcal{S}$ for whether the terminal state of the individual was a particular state s or not, i.e. $I_s = 1$ if $S = s$ and $I_s = 0$ otherwise (e.g., $I_{Voc \text{ terminal}} = 1$ if the individual ended at the *Voc terminal* node, and $I_{Voc \text{ terminal}} = 0$ otherwise).

4.2 Potential wage outcomes

The second component of our model are potential outcome equations for each of the possible final education degrees $s \in \mathcal{S}$, i.e.

$$Y_s = X'_s \beta_s + U_s = X'_s \beta_s + [\alpha_s \theta + u_s], \quad (3)$$

where X_s are observed covariates that matter for the potential wage at terminal state s and u_s is an error term. The X_s may also contain information on the path via which the terminal state s was reached. The parameter α_s represents the effect of the unobserved heterogeneity term θ on the potential wage outcome at s . As an example, $Y_{Voc \text{ terminal}}$ is the wage an individual with observed

characteristics X_s and unobserved characteristics θ *would* earn if she ended her educational career at the *Voc terminal* node. Using the Quandt switching regression representation, and in the spirit of the Roy model, the factually observed wage outcome of the individual is then given by

$$Y = \sum_{s \in \mathcal{S}} I_s Y_s. \quad (4)$$

4.3 Adjoined measurement equations

As in Heckman et al. (2016, 2017), we adjoin a system of indicators for the unobserved heterogeneity term θ in order to aid identification of the equations system and in order to facilitate the substantive interpretation of θ . As described in more detail below, we have access to three standardized competency measures (mathematical, verbal, reading speed) which we relate in three measurement equations to observed covariates and the unobserved heterogeneity term, i.e.

$$M_m = X'_m \Phi_m + \alpha^m \theta + \epsilon_m \quad (5)$$

$$M_v = X'_v \Phi_v + \alpha^v \theta + \epsilon_v \quad (6)$$

$$M_r = X'_r \Phi_r + \alpha^r \theta + \epsilon_r. \quad (7)$$

In these equations, M_m, M_v, M_r denote the competency measurements, while $\epsilon_m, \epsilon_v, \epsilon_r$ are error terms. The parameters $\alpha^m, \alpha^v, \alpha^r$ express how closely the unobserved heterogeneity term is related to measured competencies, controlling for other determinants X_m, X_v, X_r of these competencies. As our competency measures are taken at the time of our retrospective survey, it is important to also include in X_m, X_v, X_r the finally achieved educational qualifications of the individual, so that $\alpha^m, \alpha^v, \alpha^r$ measure the relationship between the unobserved heterogeneity term θ and the observed competencies *net of* the influence of the final educational degree on these competencies (in other words, we determine the relationship between competencies and the unobserved heterogeneity term for individuals with the same educational qualification, see below).

As a further ability measure, we use the individual's grade point average at the final schooling degree (LS, MS, US), which we relate in a similar way to observables and the unobservable heterogeneity term. As final grade point averages are not comparable across secondary school types, we do this separately by the highest secondary school type *LS, MS, US* attended, i.e.

$$GPA_{LS,MS,US} = X'_{LS,MS,US} \Phi_{LS,MS,US} + \alpha^{LS,MS,US} \cdot \theta + \epsilon_{LS,MS,US}. \quad (8)$$

4.4 Sources of identification

As described in detail in Heckman et al. (2016, 2017), the above model exploits multiple sources of identification. The first source of identification originates from the sequential choice models. As shown in Cameron and Heckman (1998), Heckman and Navarro (2007) and Heckman et al. (2016), the choice models (1) are non-parametrically identified if there is sufficient independent variation in the arguments of the different decision nodes. This independent variation may come from node-specific information (i.e. variables whose values change across nodes), or from exclusion restrictions (i.e. ‘node instruments’, variables that are included in some nodes but not in others). As described in more detail below, we include in our decision nodes a wide range of node-specific variables along with individual background variables whose values do not change across nodes. As discussed in Cameron and Heckman (1998) and Heckman et al. (2016), even time-invariant variables contribute to identification unless the coefficients $\gamma_{j,c}$ are collinear across nodes. Further note that we use a rich set of choice situations some of which are very indicative of the unobserved heterogeneity term (especially the upgrading decisions). We argue that the richness of the choice situations and the nature of the system considered by us contribute a lot of identifying information on the selection of individuals into final educational degrees. Heckman and Navarro (2007) and Heckman et al. (2016) show that all of these sources of information will also identify the potential outcome equations (3). Identification is non-parametric in the sense that model parameters are identified even if unobservables $\eta_{j,c}$ and U_s follow an arbitrary joint distribution. Identification is further facilitated by imposing the factor structure on unobservables, i.e. $\eta_{j,c} = \alpha_{j,c}\theta + \nu_{j,c}$ and $U_s = \alpha_s\theta + u_s$, which we do.

As discussed in more detail in Heckman et al. (2016, 2017), adjoining a measurement system for the unobserved heterogeneity term θ provides an additional, independent source of identification.² If the unobserved heterogeneity term θ was known one could condition on it, fully identifying model parameters and distributions of treatment effects under the conditional independence assumptions described above. The measurement system serves to proxy θ , identifying the joint distribution of potential outcomes via the factor structure $U_s = \alpha_s\theta + u_s$. An intuition for this result is

²One may wonder whether our decision tree in which branches join together at later stages fits exactly into the scenario studied in Heckman et al. (2016, 2017). To see that this is the case, redraw the tree so that terminal outcomes are uniquely defined by the exact path by which they were reached. This is equivalent to including into the potential outcome equations information on the path by which the terminal state was reached. We do this in our empirical implementation, see below.

that, given sufficiently many measurements for the unobserved heterogeneity term θ , one can in principle back out estimates for the factor scores θ and use these as explanatory variables in the outcome equations (this has been explicitly done in Heckman et al., 2013). A minimum number of three measurements for θ will secure the identification of the measurement system (Heckman et al., 2013, Rodriguez et al., 2016). Although model (1) to (8) as outlined above is non-parametrically identified under the assumptions just stated, we feel the need to make parametric distributional assumptions in order to facilitate the empirical implementation of our model (which contains an extensive number of equations and parameters, see below) and in order to obtain reasonably informative estimates given the limited number of observations in certain components of our model.

4.5 Estimation

Let $Z = \{Z_j, j \in J\}$ denote all the covariates used in the choice equations, and $X = \{X_1, \dots, X_s, X_m, X_v, X_r, X_{LS}, X_{MS}, X_{US}\}$ all covariates used in the outcome and measurement equations. Similarly, collect the potential wage outcomes in a vector $Y = \{Y_s, s \in \mathcal{S}\}$ and the competency measurements in $M = \{M_m, M_v, M_r, GPA_{LS}, GPA_{MS}, GPA_{US}\}$. As in Heckman et al. (2016, 2017), we assume that the error terms $\nu_{j,c}, u_s, \epsilon_m, \epsilon_v, \epsilon_r, \epsilon_{LS}, \epsilon_{MS}, \epsilon_{US}$ are independent from each other and across choices, measures and potential outcomes, conditional on observed covariates Z, X , and conditional on unobserved heterogeneity θ .

In order to estimate the model by maximum likelihood, we assume in addition that the $\nu_{j,c}$ follow the extreme value distribution, and $u_s, \epsilon_m, \epsilon_v, \epsilon_r, \epsilon_{LS}, \epsilon_{MS}, \epsilon_{US}$ normal distributions with zero mean and arbitrary variances conditional on Z, X . The likelihood contribution of a particular individual is then given by

$$\begin{aligned}
L &= \int_{\theta} f(Y, D, M|Z, X, \theta)\phi(\theta)d\theta & (9) \\
&= \int_{\theta} f(Y|D, M, Z, X, \theta)f(D, M|Z, X, \theta)\phi(\theta)d\theta \\
&= \int_{\theta} f(Y|D, M, Z, X, \theta)f(D|Z, X, \theta)f(M|Z, X, \theta)\phi(\theta)d\theta,
\end{aligned}$$

where the last line follows from our assumption that, conditional on observed variables, errors in

the choice and the measurement equations are independent, and $\phi(\cdot)$ is the density function of the standard normal distribution. Assuming independent sampling across individuals, the overall likelihood is the product of all individual likelihoods.

4.6 Treatment effects

The main goal of our study is to use our model estimates to estimate a number of treatment effects that correspond to the expected wage returns to taking particular educational decisions.

4.6.1 Differences across final educational levels

As a first basic step, we measure the expected differentials in potential outcomes between neighboring final educational levels. For example, we ask how much higher the expected potential wage outcome is at the *Voc terminal* node when compared to already ending at the end of the lower secondary track *LS terminal* (see figure 1). This question is particularly relevant for the population that was in the situation to decide between these two options, i.e. individuals who ended at the lower secondary track *LS terminal*, and those who reached vocational training via the secondary track to end at *Voc terminal*.

The associated treatment effect is

$$ATE_{s',s} = \int \int \int E(Y_{s'} - Y_s | x, z, \theta) dF_{X,Z,\theta}(x, z, \theta | S \in \{s', s\} \ \& \ \text{restr}(D)), \quad (10)$$

where s' and s are the final educational levels to be compared (in the example $s' = \textit{Voc terminal}$ and $s = \textit{LS terminal}$), and $\text{restr}(D)$ represents the restriction that one only considers individuals who have reached s', s via certain routes (in the example, we only consider individuals who reach *Voc terminal* via the lower secondary track). The expected value in (10) is taken with respect to the idiosyncratic error terms u_s . In our empirical section, we will also consider the distribution of expected differentials $E(Y_{s'} - Y_s | x, z, \theta)$ for individuals $S \in \{s', s\} \ \& \ \text{restr}(D)$, as well as the average treatment effect on the treated (*ATT*, i.e. for those individuals who actually preferred s' to s) and on the untreated (*ATU*, i.e. for those individuals who preferred s to s').

4.6.2 Expected wages when forcing individuals to start from particular points

Of particular interest in a tracking system are the expected wages for an individual with characteristics (z, x, θ) when forced to take a particular decision at a given decision node, or when forced to start at a particular point in the system. The expected wage in this case is given by

$$\begin{aligned} E(Y|z, x, \theta, \text{fix } D_{j,c} = 1) & \quad (11) \\ &= \sum_{s \in \mathcal{S}} P(s|z, x, \theta, \text{fix } D_{j,c} = 1) \times E(Y_s|z, x, \theta, \text{fix } D_{j,c} = 1), \end{aligned}$$

where $\text{fix } D_{j,c} = 1$ means that the individual is forced at decision node j to take decision c .³ For example, at decision node *MS* an individual might be forced to choose *MS-US* although she factually opted for *MS-Voc*. The expected wage when forcing the individual to take decision $D_{j,c} = 1$ is the result of weighting her expected wage at each possible terminal node with her probability of reaching this node when starting with $D_{j,c} = 1$. These probabilities can be computed using the estimated choice models in the decision tree (for more details, see below). Given that we include in the choice models also information on previous decisions, this fully accounts for the dynamics associated with taking particular routes through the system.⁴ The expected wage from taking a particular decision at a particular point in the decision tree thus includes all the continuation options implied by taking this decision.

4.6.3 Differentials in expected wages for forced alternatives

Using expected wages for forced decisions, one can define expected wage differentials between alternatives forced onto the individual. For example, one might want to compare the expected wage gain from taking decision *MS-US* vs. *MS-Voc* (an upgrading decision). For a given individual, this expected wage differential is defined as

$$T_{j,c',c}(Y|z, x, \theta) = E(Y|z, x, \theta, \text{fix } D_{j,c'} = 1) - E(Y|z, x, \theta, \text{fix } D_{j,c} = 1). \quad (12)$$

³For a more detailed discussion of the fixing operation, see Heckman et al. (2017).

⁴In Biewen and Tapalaga (2017), we show that such dynamics are important. For example, having previously taken an upgrading decision is relevant for many decisions at later stages in the tree. Also see the results for the estimated decision models in table A2.

The average treatment effect for individuals who were in the position to decide between the two options considered is given by

$$ATE_{j,c',c} = \int \int \int T_{j,c',c}(Y|z, x, \theta) dF_{X,Z,\theta}(x, z, \theta | \text{those who factually chose } c' \text{ or } c). \quad (13)$$

Again, in our empirical analysis we will also consider the distribution of $T_{j,c',c}(Y|z, x, \theta)$ among individuals who factually chose one of the two options, as well as the treatment effect on the treated (*ATT*, i.e. those who in fact chose c' and not c) and on the untreated (*ATU*, i.e. those who chose c instead of c').

We also compute the average marginal treatment effect, i.e. the treatment effect for those who factually chose between c' and c , and who in addition were at the margin of indifference between these two alternatives (i.e. the utility difference between the two alternatives was sufficiently small, see Heckman et al., 2017). This treatment effect is defined as

$$\begin{aligned} AMTE_{j,c',c} &= \int \int \int T_{j,c',c}(Y|z, x, \theta) \\ &\times dF_{X,Z,\theta}(x, z, \theta | \text{those who factually chose } c' \text{ or } c \text{ and } |V_{j,c'} - V_{j,c}| < \epsilon). \end{aligned} \quad (14)$$

The average marginal treatment effect is particularly relevant because it is the treatment effect for individuals who are close to being indifferent and whose decisions could thus easily be changed by policy measures (Carneiro et al., 2010). The average marginal treatment effect is the treatment effect for *all* individuals at the margin of indifference between the alternatives considered, while the marginal treatment effect *MTE* is the treatment effect for individuals at a *particular* margin (i.e. individuals close to indifference with a particular value of 'distaste' against the decision considered). The local average treatment effect *LATE* is the average treatment effect for individuals close to indifference whose decisions are monotonically changed by a particular instrumental variable (Heckman and Vytlačil, 2005, 2007).

Finally, we calculate policy relevant treatment effects which represent treatment effects for a well-defined population whose final outcomes were changed by a particular policy (Heckman and Vytlačil, 2005, 2007, Heckman et al., 2016, 2017). These are defined as

$$PRTE_{p',p} = \int \int \int E(Y' - Y|z, x, \theta) dF_{X,Z,\theta}(x, z, \theta | \text{those for whom } S(p') \neq S(p)). \quad (15)$$

Here, Y', Y denote the realized outcomes under policies p' and p , while $S(p'), S(p)$ are the terminal nodes reached under policies p' and p , respectively. In our empirical application, we will

use this definition to evaluate effects for individuals whose educational choices were affected by the so-called educational expansion.

All the above integrals and other quantities can be computed by simulation methods using our estimated choice models and outcome equations. Our simulations are based on around 6 million observations. Our empirical model includes hundreds of parameters and uses extensive numerical convergence and simulation procedures. This renders the use of the non-parametric bootstrap impractical. We therefore resort to a parametric bootstrap procedure for the calculation of standard errors and test statistics (see Cameron and Heckman, 2001). For the parametric bootstrap, we resample from the full joint (normal) distribution of estimated coefficients and repeat all of our computations for the resampled set of estimated coefficients. Our bootstrap estimates are based on 1000 resamples.

5 Data and specification choices

Our analysis uses data from the National Educational Panel Study (NEPS, starting cohort adults, SC6).⁵ The survey was conducted over the years 2007/2008 to 2011 and contains rich information on the biographies and the current situation of individuals born between 1944 and 1986. In this study, we use information on the current hourly wage of a person along with extensive information on the educational career of the person. An important difference between the data set used here and other data sets is that not only final educational degrees were recorded but detailed histories of sequential educational decisions, without which the present analysis would not be possible. Another virtue of the data is the availability of rich information on parental backgrounds, which are known to strongly influence education choices. We include in our final sample only individuals born between 1950 and 1979 because schooling histories immediately after the war were often irregular, and because individuals born after 1980 were often too young to have entered the labor market at survey time. Moreover, in view of the differences between the East and West German school systems before reunification, we impose the restriction that individuals had at least one secondary school spell in West Germany.

An overview of the percentages of individuals who passed through the different nodes of the

⁵See Blossfeld et al. (2011) and Skopek (2013).

system along with the absolute number of observations at each node is given in figure 1.⁶ The overall number of observations is 6,433 (all individuals starting at elementary school *ES*). The figure shows that most individuals followed the tracking structure through the system, but that a considerable percentage also took 'second-chance' decisions. In particular, 11.8 percent of the population upgraded from the lower secondary to the middle secondary level at some point, 17.1 percent from the middle secondary to the upper secondary level, and 12.3 percent added tertiary education after already having completed vocational training (note that some individuals may have taken more than one of these transitions).

5.1 Educational transitions

The variables included in our analysis are listed in table A1 in the appendix. In our equations describing educational choices, we consider a wide range of variables that determine individual transitions including node-specific information and detailed information on background characteristics. As background characteristics we consider maximal parental educational and occupational status, the number of siblings of the person, a broken family variable indicating whether the person grew up with only one parent up to the age of 15, gender and a dummy indicating migration background (one of the following holds: not born in Germany, at least one parent not born in Germany, no German citizenship, mother tongue not German, there exists a second mother tongue). As to parents' maximal educational level, we distinguish between the four categories *ED1*, *ED2*, *ED3*, *ED4* shown in table A1, where the reference category *ED1* represents parents with lower than a vocational training degree (this could be a lower or middle secondary degree or no school degree at all). For parents' maximal occupational status, we form three categories: high/*OCC3* (managers, high ranking civil servants and military personnel, doctors, highly qualified white collar workers, self-employed with at least ten employees), medium/*OCC2* (qualified white collar workers, master craftsmen, middle ranking civil servants and military personnel, self-employed with less than ten employees), and low/*OCC1*, all others. Our parental background variables turn out to be important determinants at practically all decision nodes (see Biewen and

⁶As an additional secondary school type, so-called comprehensive schools (*Gesamtschulen*) were introduced from the 1960s onwards. These schools either have an internal tracking system or relax the tracking structure altogether. We group these observations into the respective track if the school had an internal tracking system, and into the middle track if this is not the case. Only a small percentage of individuals in our sample attended a comprehensive school (3 to 4 percent).

Tapalaga, 2016, 2017, for a more detailed analysis).

In addition, we include the following node-specific covariates into our decision nodes.⁷ First, we consider information on previous transitions, e.g. whether the person attended Kindergarten, whether she previously upgraded to a higher school track, information on the secondary track via which she arrived at certain decision nodes, and information on whether she completed a vocational training degree before deciding to take up studies at a university or a university of applied sciences. As further control variables, we add regional dummies indicating North, West, Middle, and South Germany. These regions exhibit a high degree of homogeneity with respect to their school regulations (including, e.g., to what extent parents may override teacher recommendations).⁸ For the schooling nodes, we assume a quadratic time-trend for the time a given node decision was taken in order to control for changes across cohorts. For the vocational and tertiary decision we include a quadratic term of the individual's age when the survey was started 2007/2008 (which is equivalent to including birth year as a cohort control).

As described above, we make use of a number of 'node instruments' which shift decisions at some nodes but not at others. In particular, motivated by Mühlenweg and Puhani (2010) and Dustmann et al. (2017), we include at the end of elementary school a dummy indicating whether the person was born before the school year cutoff date. The idea is that individuals who were born before the school year cutoff date are comparatively young when enrolling in elementary school and that this age disadvantage may make them marginally less likely to choose the more advanced secondary school tracks after grade four (this effect is confirmed in our estimations, see table A2). Next, we include at the elementary school node the population share of students at the level of the federal state who attended the lower, middle or the upper track at the time at which the person was in the situation to choose between the different tracks. This will represent secular changes in the supply of places in secondary school tracks which are exogenous to the individual and which will influence track choices. Similarly, we consider the federal ratio of students to population aged 20 to 22 years to represent secular trends in tertiary education participation. As a second measure of tertiary education expansion, we use the academic institutions density (number of universities and universities of applied sciences per 1 million population at the federal state level).

⁷The exact way in which these variables enter the choice models at different nodes can be inferred from the table of estimated coefficients, table A2.

⁸We initially included a full set of federal state dummies but these mostly turned out statistically insignificant while consuming a large number of degrees of freedom.

Some of these variables were used in a similar form as instruments in previous studies, see e.g., Jürges et al. (2011) and Kamhöfer and Schmitz (2016). They mainly represent sequential policy reforms increasing the supply of educational institutions ('educational expansion'), staggered over time and differential across regions. See the more detailed discussion in section 6.6, where we consider the isolated influence of these developments on individual wages. Finally, we include as an additional node instrument a regional labor market indicator (the contemporaneous deviation of the unemployment rate from a local polynomial trend at the federal state level) which is known to potentially influence the decisions at various schooling and further education nodes, see e.g. Micklewright et al. (1990).⁹

5.2 Wage equations

Our wage measure are hourly wages which we compute by dividing the most recently observed gross monthly wage by the number of hours worked per month. Given the limited numbers of observations at a number of terminal states in the decision tree (see figure 1), we combine the wages at the terminal states *LS terminal*, *MS terminal* and *LS terminal* into a wage equation 'School degree', the terminal states *Voc terminal* and *MC* into a wage equation 'Vocational training', and the outcomes *UAS* and *U* into a wage equation 'Tertiary education'. Note that we include in the terminal branches in figure 1 also a small number of individuals who ended in the respective branch but did not necessarily complete the respective degree. The wages in the terminal branches therefore include the possibility of not completely finishing the respective degree (when thinking in terms of expected wages, this makes more sense than excluding these observations).

Our specification of the wage equations is as follows (the exact specifications can be inferred from our tables of estimated coefficients, see table 3). First, we include gender and a quadratic term in work experience. Second, we fully differentiate within the three wage equations between the actual terminal branches reached. For example, in the the 'School degree' wage equation, we

⁹Originally, we also considered using information at a finer regional level (i.e. districts, see Kamhöfer and Westphal, 2017). In the end, we did not pursue this possibility for the following reasons: a) missing values in local identifiers especially for earlier cohorts which would have significantly reduced our sample size, b) aggregate statistical data at finer regional levels is often unavailable for times before 1970, c) the regional level might better reflect educational and labor market possibilities than the district level.

include dummies indicating whether the final state was middle secondary *MS* or upper secondary *US*, rather than the reference category *LS*. In the ‘Vocational training’ equation, we include a dummy indicating whether the final degree was that of a master craftsman *MC* (rather than mere vocational training *VOC*). In the ‘Tertiary education’ equation, we differentiate between university *U* and university of applied sciences *UAS*. Similarly, we fully interact in each equation the unobserved heterogeneity term with the final degree reached. Apart from dummies for the terminal states reached, we include in the ‘Vocational training’ and the ‘Tertiary education’ wage equations information on the route via which the respective terminal state was reached, in particular through which of the three secondary tracks and whether tertiary education was reached via prior vocational training (see table 3).

5.3 Adjoined equations for competencies

Our data set contains three standardized test scores on mathematical competency, reading competency and reading speed of the person (for more information, see NEPS, 2011). As control variables in these measurement equations, we include all the background variables described above as well as a quadratic term in age (for details, see table 1). The competency measures were obtained at survey time. This means we have to control in these equations in addition for the final educational degree reached by the individual in order to measure the relationship between the unobserved heterogeneity term and the personal competencies holding fixed the educational degree of the person. In addition, we relate the unobserved heterogeneity term to the grade point average of the person at the end of secondary school. As control variables, we include in these equations the same background variables included in the competency measurement equations (but no final degrees, for details see table 3).

6 Empirical Results

6.1 Model estimates

The estimated coefficients of our joint model of educational transitions, wage outcomes and auxiliary competency equations are shown in tables 1 to 3 and table A2 in the appendix. The

large set of estimates for the coefficients of the choice models at the six decision nodes are given in table A2. In Biewen and Tapalaga (2017), we have estimated and analyzed a similar set of choice equations without adjoined outcome and auxiliary measurement equations, so that we keep the discussion of these effects brief.¹⁰ The main features of the transitions at the different nodes can be summarized as follows. As discussed in more detail in Biewen and Tapalaga (2017), there are strong effects of parental background variables (parental education and parental occupation) at most decision nodes, especially at the original track choice at the end of elementary school (*ES*, see first panel of table A2). The higher the parental background, the higher the likelihood of choosing a higher secondary track. Moreover, parental background effects are particularly strong for the upgrading decisions *LS-MS*, *MS-US* and *Voc-Study*, where higher backgrounds make it considerably more likely to exploit 'second chances'. Parental backgrounds also matter for later choices, e.g. individuals with higher parental backgrounds are more likely to study at a general university rather than at a more practically oriented university of applied sciences. Apart from some further effects of background characteristics such as gender and migration status, there are a number of dynamic effects that connect choices to previous choices, in particular whether there was previous upward mobility (see Biewen and Tapalaga, 2016, 2017).

Important for our study of heterogeneous wage returns, we observe dynamic selection along the stages of the system in the sense of Cameron and Heckman (1998, 2001). Selection with respect to unobserved heterogeneity is already present at the original track choice, where individuals with lower values of the unobserved heterogeneity term were more likely to select into the lower secondary track, while those with higher values were more likely to choose the upper track. This can be inferred from the coefficients for the unobserved heterogeneity term in table A2 and the resulting distribution of the unobserved heterogeneity term at the *LS*, *MS* and *US* decision nodes shown in figure 2. We also measure strong selection with respect to the unobserved heterogeneity term for all the upgrading decisions, *LS-MS*, *MS-US*, and, in particular, *Voc-Study*. The latter decision is particularly selective, implying that only individuals with very high values of the unobserved heterogeneity term make this transition (see the high coefficient in table A2). Positive selection on unobservables is also present in the decision to obtain the degree of a master craftsman and in the one between a university and a university of applied sciences.

¹⁰The results in Biewen and Tapalaga (2017) also include estimated average partial effects which facilitate the interpretation of the otherwise not directly interpretable coefficients of the multinomial choice models shown in table A2.

The distribution of the unobserved heterogeneity term at our six decision nodes is summarized in figure 2.

— Figure 2 around here —

Table 1 presents the estimated coefficients for our three competency equations whose purpose is to aid identification and interpretation of the unobserved heterogeneity term. The equations measure the relationship of the three standardized competency measures with the unobserved heterogeneity term and other personal characteristics, net of their association with final educational degrees. Given highly significant net correlations of .6, .68 and .46, we find a strong relationship between measured competencies and the unobserved heterogeneity term even for individuals with the same final degree, suggesting a clear relation of the unobserved heterogeneity term with unobserved abilities. Similarly, table 2 shows the measurement equations relating the unobserved heterogeneity term to grade point averages at secondary school. Note that grades in Germany range from 1 (= best) to 5 (= worst) so that the interpretation is reversed. Again, the results confirm a significant partial correlation of good grades with high values of the unobserved heterogeneity term.

— Tables 1 and 2 here —

Our estimated wage equations are shown in table 3. All estimated effects are in line with theoretical predictions. Holding other things constant, women earn significantly less than men, there is a concave experience pattern, and there are significant effects from the various sub-degrees. For example, among individuals whose final educational qualification was just a school degree without vocational or academic training, those with the middle secondary degree *MS* earn 32.3 percent more than those in the base group of the lower secondary degree *LS*. Those with an upper secondary degree *US* earn 44.6 percent more. For individuals with a vocational training degree (second panel of table 1), there is a wage premium of 14.8 percent if they came from the middle secondary track *MS* rather than from the lower secondary track *LS*, and a premium of 23.2 percent if they came via the upper secondary track *US*. On top of this, individuals earn an average premium of 11.1 percent if they obtained in addition the degree of a master craftsman. The difference between the constant of the school degree and the vocational training degree

shows that wages after vocational training degrees are on average 33 percent ($2.15-1.82=.33$) higher than those for mere school degrees. In the group of individuals with tertiary education, those who obtained a university degree earn around 5 percent more than those with a degree from a university of applied sciences. Moreover, there is a huge difference of 47 percent between the average wages after academic training when compared to vocational training (see the estimates for the intercepts in panels two and three of table 1, $2.62-2.15=.47$).

— Table 3 here —

There are generally positive gradients in unobserved ability in all three wage equations, although these are often imprecisely estimated. Interestingly, the unobserved ability gradient is also slightly higher for the vocational degree than for the tertiary degrees, suggesting that individuals with very high levels of unobserved heterogeneity may fare well even without an academic degree, although it will be hard to overcome the overall difference between vocational and academic degrees of 47 percent. Finally, we observe that wage dispersion is significantly higher for tertiary education (.21) than for vocational training (.17) or mere school degrees (.16).

6.2 Wage differences between final educational degrees

We start with an analysis of heterogeneous wage differences between the terminal states in our decision tree which represent the set of potential final educational degrees: lower secondary *LS*, middle secondary *MS*, upper secondary *US*, vocational training *Voc*, master craftsman *MC*, university of applied sciences *UAS*, and general university *U*. We present these comparisons for neighboring terminal states and the groups of individuals who were in the situation to choose between them (see section 4.6.1). For example, figure 3a shows the difference between the expected log wage at *LS terminal* and at *Voc terminal* for individuals who factually ended up at either of these two final degrees. We observe selection on expected wage gains, i.e. the individuals who finally chose to obtain a vocational degree after completing lower secondary school expected higher wage gains from this decision than those who did not take this step (stopping at the level of the lower secondary degree instead). The sorting on expected gains holds for many but not all of the pairwise comparisons, although in many cases, differences between the treated and the untreated group are probably not statistically significant.

In general, we find significant and positive expected gains of choosing the next higher final educational degree for all pairwise comparisons. In most cases, we see that expected gains of obtaining the next higher degree are uniformly higher for *all* individuals irrespective of their value of the unobserved heterogeneity term. The only exceptions are the choice of vocational training after upper secondary schooling (figure 3e) and the decision between a master craftsman degree and a tertiary degree for individuals who completed vocational training (figures 4e and 4f). In these cases, a significant fraction of individuals face negative expected returns conditional on knowing their unobserved heterogeneity term. This means that for these comparatively low ability individuals, the expected wage at the higher degree will also be relatively low due to the positive ability gradients in the wage outcome equations. For these individuals, obtaining the higher degree might imply a negative return.

6.3 Expected wages from secondary track choices including continuation values

Next, we focus on the main crossroads of the system, the choice between the three different secondary schooling tracks *LS*, *MS* and *US* (see figure 1). We let certain groups of individuals start from a particular track and consider their expected wages. We consider both the case in which individuals in fact started from a particular track (e.g. *LS*), and the case in which an individual who actually started from another track (e.g. *MS*), is forced to start from a neighboring track (e.g. *LS*). We take account of the fact that different individuals face different probabilities of taking certain routes through the system, according to the dependence of individual transitions on observed and unobserved characteristics as estimated in our transitions equations. We compute for each individual the likelihood of reaching a particular terminal node when starting from a particular secondary track. For example, there are three different routes for someone who started at the lower secondary track *LS* to reach the terminal node *Voc terminal*. The routes via which this can be accomplished are *LS-Voc terminal*, *LS-MS-Voc terminal*, and *LS-MS-US-Voc terminal*, (see figure 1). In order to compute the expected wage of someone who starts at a particular secondary track, we compute the likelihood of reaching each of the possible terminal states *LS terminal*, *MS terminal*, *US terminal*, *Voc terminal*, *MC*, *UAS* and *U*, and use this probability to

weight the expected wage of this individual at this particular terminal node (see section 4.6.2).

— Table 4 here —

Table 4 already reveals interesting patterns of reaching certain terminal nodes across different groups of individuals. The first column computes these probabilities for the group of individuals who *in fact* started from the lower secondary track, i.e. individuals who factually took the decision *ES-LS*. The next two columns show these probabilities for individuals who in fact started from *MS* or *US* (i.e. individuals who choose *ES-MS* or *ES-US*). As explained above, individuals who started from the different secondary tracks differed significantly with respect to their parental backgrounds and unobserved heterogeneity terms. In particular, those who started from the lower secondary track *LS*, or the middle secondary track *MS*, were much less favorably selected in terms of parental background and unobserved characteristics than those who directly started at the upper secondary track *US* after finishing elementary school. Given the dependence of further transitions on characteristics, these differences in observed and unobserved characteristics strongly influence the prospects of reaching different terminal degrees. In particular, when counterfactually forced to start from the lower secondary track *LS*, individuals from the *ES-US* group are much more likely to reach higher terminal nodes than those from the less favorably selected *ES-LS* and *ES-MS* groups. At closer inspection, the main reason for this is that it is much more likely for more favorably selected individuals to take the upgrading decisions *LS-MS*, *MS-US* and *Voc-Study* (see table 4). For example, the average likelihood for someone from the *ES-LS* group who started from the lower secondary track to proceed to the upper secondary track and eventually enroll at a university was just .015 compared to .041 for someone from the *ES-MS* group and .103 for someone from the *ES-US* group (see row *LS-MS-US-Uni* in table 4).

Column 5 of table 4 shows the expected mean log wages conditional on having taken a particular route through the system, averaged over the whole population. For example, if forced to start from the lower secondary track *LS*, a randomly drawn individual from the population who went on to vocational training and ended up at the *Voc terminal* node, faced an expected wage of 2.625 (see row *LS-Voc terminal* of table 4). As another example, when forced to start at the middle secondary track *MS*, a randomly drawn individual from the population who proceeded to the upper secondary track, went on to vocational training from there, and added after vocational training a degree at an university of applied sciences, faced an expected wage of 3.014 (row

MS-US-Voc-UAS). Differences between the expected log wages for different routes represent the expected wage returns to taking the one route compared to the other. To the extent that our transition and outcome equations are correctly specified, these expected returns are *free of ability and sorting bias* because they are computed for a fixed and representative distribution of observed and unobserved characteristics.

6.3.1 Starting from the lower vs. from the middle secondary track

Given probabilities of reaching certain nodes and given expected wages at all possible terminal nodes, we can compute the expected wages of individuals who are forced to start at a particular secondary track. We start with a comparison of the expected wages of starting from the lower secondary track *LS* compared to starting from the middle track *MS*. We show this comparison for individuals who *factually* started either from *LS* or *MS*, because these individuals were in the natural situation of deciding between the two tracks. Hence, figure 5a shows the distribution of expected wages when starting from the lower track *LS* for individuals who factually started at *LS* or *MS* (i.e. individuals who took transitions *ES-LS* or *ES-MS*). It can be seen that the expected log wages from starting from *LS* range between about 2 and 3.3 and that the more favorably selected individuals from the *ES-MS* group expect slightly higher wages. One reason for this is that these individuals were more likely to choose higher rather than lower tracks at subsequent stages (including upgrading decisions), driving up their expected wages. The other reason is that these individuals were more positively selected in terms of unobserved heterogeneity so that their expected wages were higher at the different terminal nodes. Expected wages for the two groups when forced to start from the middle track *MS* are shown in figure 5b. The picture looks slightly different as well as shifted to the right, reflecting the higher expected wages when starting from the middle rather than from the lower secondary track.

— Figure 5 here —

Figure 5c presents the expected wage differential, i.e. the difference of the expected wage when forced to start from the middle track *MS* rather than from the lower track *LS* (see section 4.6.3). For both groups, individuals who *factually* started from *LS* and individuals who *factually* started at *MS*, the expected wage return from starting from *MS* vs. from *LS* was positive and around 9

percent. The expected return was slightly lower for the *treated* group (individuals who factually started from *MS* and not from *LS*) than for the *untreated* group (individuals who factually started from *LS* rather than from *MS*). At first sight, this may be surprising. It makes perfect sense however, because the *ES-MS* group of individuals had better observed and unobserved characteristics making them more likely to take the ‘second chance’ decision *LS-MS* after having been forced to start from the lower track *LS*. For these individuals, the expected gains from starting from *LS* vs. from *MS* are diminished because they were more likely to come back to the middle track when forced to start from the lower track (to a certain extent, this indicates that the original track allocation carried out by the tracking system was right).

— Table 5 here —

The average expected gains from starting from *MS* rather than from *LS* are summarized in table 5. The table presents the average treatment effect on the treated (*ATT*, i.e. for individuals who factually chose *MS* rather than *LS*), on the untreated (*ATU*, i.e. for individuals who factually chose *LS* rather than *MS*), for the two groups together (average treatment effect, *ATE*), and for individuals at the margin of choosing between *LS* and *MS* (average marginal treatment effect, *AMTE*, see section 4.6.3). As a remarkable finding, the table also shows that the expected gain of starting from the middle rather than from the lower track was steeply decreasing in parental education. This is the consequence of the fact that individuals with more favorable backgrounds were more likely to upgrade to the middle track when forced to start from the lower track, reducing the difference between being placed at the lower rather than the middle track. As in Heckman et al. (2016, 2017), the *AMTE* differ somewhat from the *ATT*, *ATU* and *ATE*.¹¹

6.3.2 Starting from the middle vs. from the upper secondary track

Figure 6 presents the corresponding comparison between starting from the middle vs. from the upper secondary track for individuals who in fact chose one of these two tracks. When forced to start from the middle track *MS*, individuals who actually started from the upper track face somewhat higher expected wages (figure 6a). As evident from the second panel of table 4, this is

¹¹In our empirical implementation, ϵ in $|V_{j,c'} - V_{j,c}| < \epsilon$ was set to 0.01 times the empirical standard deviation of $|V_{j,c'} - V_{j,c}|$ for individuals choosing c' or c , i.e. for whom $V_{j,c'}, V_{j,c} \geq V_{j,c''}$ for all $c'' \in C_j$.

mainly due to the fact that these individuals had better observed and unobserved characteristics making them more likely to choose higher tracks at later stages. In particular, they were much more likely to upgrade to the upper secondary track and go to university or university of applied sciences from there. Even if they first chose vocational training after having upgraded to the upper secondary track, they were much more likely to go on to university or university of applied sciences from there (third panel of table 4). In addition, individuals who in fact started from the upper track had better unobserved characteristics (figure 2) which also drives up their expected wages. When forced to start from the upper secondary track, the difference between the two groups is still there, but it is less pronounced (figure 6b).

— Figure 6 here —

Figure 6c presents the expected wage gain from choosing *US* rather than *MS* for both groups of individuals. The expected gain from choosing the upper secondary track *US* rather than the middle track *MS* is considerable and amounts to some 17 percent on average. It is much higher than that from choosing between *MS* and *LS* because the upper secondary track *US* is the principle pathway to academic education which is associated with much higher wages on average. Again, the expected gains for the more favorably endowed *ES-US* group are lower because their expected wages are already higher when being counterfactually forced to start from the lower ranking middle track (figure 6a). The reason for this is that these individuals would be more likely to 'correct' their initial placement and switch to the higher track later. Also note that the expected wage differential between choosing *US* rather than *MS* is extremely dispersed, i.e. there are many individuals for whom this track choice would not make much difference in terms of expected wages. However, there are also many individuals for whom the difference in expected wages is huge (up to 40 percent). Consistent with the explanation above, the expected difference between starting from the middle rather than from the upper track is lower and more concentrated for individuals who in fact started from the upper track.

Table 5 summarizes the different treatment effects, i.e. on the *treated* (the ones who actually started from the upper track *US*), and on the *untreated* (the ones who actually started from the middle track *MS*). These treatment effects also vary by parental background, but this time the relationship is more of an inverted-U shape, i.e. expected wage differentials are highest for the two middle levels of parental education *ED2* and *ED3*.

6.4 The value of ‘second chance’ options

Despite its pronounced tracking structure, the system studied here has a number of built-in flexibility features which allow individuals to revise their initial track choices at later stages. As explained above, a considerable number of individuals exercised these ‘second chance’ options. In this section, we evaluate the value of these options to different kinds of individuals.

6.4.1 Upgrading from the lower to the middle secondary track

The first opportunity to revise earlier track decisions is available to individuals who have successfully completed the lower secondary track. These individuals may either directly start working, continue with vocational training, or seize the ‘second chance’ to graduate from the middle secondary track. When evaluating the value of the option to upgrade to the middle track after having finished the lower track, the main competitor is to start vocational training. We therefore compare the expected wage for individuals opting for vocational training after finishing the lower secondary track (i.e. *LS-Voc*), with the expected wage associated with instead upgrading to the middle secondary track (i.e. *LS-MS*). In both cases, the expected wages include all the continuation possibilities implied by choosing the respective alternative. Again, we carry out this comparison for individuals who were most likely to choose between the two alternatives, i.e. individuals who in fact chose either *LS-Voc* or *LS-MS* (see section 4.6.3).

— Figure 7 here —

Figure 7a and the third panel of table 5 show that the expected gains from choosing the upgrading option *LS-MS* rather than the vocational option *LS-Voc* were considerable, around 16.6 percent on average. They were slightly higher for those who took the upgrading decision ($ATT=17.2$ percent) than for those who in fact did not choose this option ($ATU=16.4$ percent). Differentiating with respect to parental background, we find strong dependence of the value of these second chance options on parental characteristics. Individuals with high levels of parental education benefitted much more in expected terms from upgrading than those from lower backgrounds. The reason is that these individuals were much more likely to choose higher tracks at later stages, i.e. they were better able to exploit the options opened up to them by upgrading to the middle secondary track.

6.4.2 Upgrading from the middle to the upper secondary track

Figure 7b and the fourth panel of table 5 show the corresponding return to upgrading from the middle to the upper secondary track when compared to continuing with vocational training after finishing the middle track (i.e. *MS-US* vs. *MS-Voc*). The average value of this second chance option was similarly high, around 14 percent. It was slightly higher for the individuals who did not take this upgrading decision ($ATU=14.8$ percent), and slightly lower for those who took it ($ATT=12.8$ percent), although these differences were not statistically significant (see table A3 in the appendix). Again, the value of this upgrading decision was much higher for individuals from better backgrounds. For example, the value of the option to upgrade from the middle to the upper secondary track was associated with an expected wage gain of 11.8 percent for individuals from the lowest parental background *ED1* compared to 17 percent for individuals from the highest background *ED4*. Again, the reason for this is that individuals from higher parental backgrounds were better able to exploit the future options opened up from graduating from the upper secondary track (in particular the option to start tertiary education).

6.4.3 Tertiary education vs. master craftsman after vocational training

In figure 7c, we analyze the value of the option to enroll in tertiary education after having successfully completed a vocational training degree. For the individuals concerned, the main competitor to this option is to add the advanced vocational degree, the master craftsman certificate. As figure 7c shows, the average expected wage difference between these two alternatives was around 8 percent. It was slightly higher (8.9 percent) for those who in fact chose to go on to tertiary education, and lower for those who in fact opted for the master craftsman degree (5.2 percent, see table 5). Remarkably, there was also a considerable fraction of people for whom the expected difference was negative. For these individuals, obtaining a master craftsman degree was more advantageous in expected terms than pursuing tertiary education. This shows that obtaining tertiary education is not necessarily the best option for everybody in the population.

6.5 Choosing the vocational vs. the academic track after upper secondary schooling

We finally evaluate the differences in expected wages from choosing the academic rather than the vocational training track for graduates of the upper secondary track. This relatively homogenous group of individuals has the direct choice between these two alternatives. Again, this choice incorporates all potential continuation possibilities implied by the respective alternative, including the possibility to upgrade to academic training after having completed vocational training. We carry out the comparison between these two alternatives for all individuals who in fact chose one of the two options, i.e. individuals who factually either chose *US-Voc* or *US-Study*. For these individuals, figure 8 and panel five of table 5 present the expected wage gains from choosing the academic rather than the vocational track. At 18.5 percent the expected wage advantage of the academic track was large. It was equally large for individuals who factually chose either of the two tracks. In contrast to previous cases, the expected benefit of the academic vs. the vocational track was largely independent of parental background. Finally, note the huge dispersion in expected gains ranging from about 5 to around 40 percent (figure 8). This is an important finding showing that academic training does not benefit all individuals equally. Some individuals gain little in expected terms from starting academic training, while for others the expected gain is huge.

6.6 Policy relevant treatment effects: individuals affected by the ‘educational expansion’

In this section, we consider wage effects for the group of individuals whose educational decisions were changed as a result of the general expansion of the German education system starting in the 1960s and the 1970s (see Jürges et al. 2011, Schindler, 2017, and the references therein). As in many other countries, a number of policies were implemented in order to encourage participation at different stages of the education system. These policies included increasing initial placement of students to higher secondary tracks, increasing supply of institutions providing ‘second chance’ degrees, and increasing supply of tertiary education (Schindler, 2017).

In our estimations, these developments are visible as node-specific time trends and the effects

of particular instrumental variables at the different decision nodes (the regional share of pupils attending the different secondary tracks, the ratio of students to individuals aged 20-22 years, and the regional academic institutions density). As evident from table A2, these effects were highly significant in many cases. For example, the individual's decision to transit to one of the higher secondary tracks after elementary school was strongly increasing in the regional share of students who did this. On top of this, there are significant time trends, see first panel of table A2. We also observe highly significant and increasing time trends in the 'second chance' decisions to upgrade to higher secondary tracks (second and third panel of table A2). In order to isolate the effect of these developments, we carry out a counterfactual simulation, in which we fix instruments and time trends for the elementary school decision node *at the year 1960* (i.e. the time trend in the elementary school decision node and the local shares of individuals attending the different secondary tracks), and the instruments and time trends for later educational decisions *at the year 1970*. This will simulate a scenario in which the 'educational expansion' is artificially stopped. We then note for each individual whether her educational decisions and therefore her terminal wage outcome were different in the counterfactual scenario.

Table 6 shows the results of this exercise. In order to differentiate between reforms at different stages of the system, we also present results for the case in which we only change the instruments and time trends for the initial secondary track placement (*Policy 1*), for the secondary track upgrading decisions (*Policy 2*), and for the enrollment into tertiary education (*Policy 3*). We also consider all changes together (*Policy 4*). The results suggest that the policy reforms aiming at initial secondary track placement alone boosted the wages of those affected by 20.3 percentage points (*Policy 1*). By contrast, the reforms facilitating the upgrading to higher secondary tracks did not lead to significant wage increases if considered in isolation (*Policy 2*). The same is true for the isolated effect of changes in tertiary education enrollment (*Policy 3*). At first sight the latter may appear surprising, but closer inspection of this effects shows that this was the result of two countervailing tendencies. On the one hand, the rising general participation in tertiary education (represented by the ratio of students/individuals aged 20-22 years) was positively associated with individual decisions at the upper secondary node *US* to go on to studies at universities or universities of applied sciences. On the other hand, it became much more likely for graduates of the upper secondary track to choose vocational training rather than tertiary education (see time trend at the *US* node, fourth panel of table A2). This is also the reason why the effect of implementing *all* of the policy changes together was reduced when compared to the effect

of changing only the initial track placement (14.8 percent vs. 20.3 percent, compare first and last row of table 6). It turns out that increasing placement to higher secondary tracks led to higher graduation rates from these tracks but that individuals graduating from these tracks less often went on to tertiary education. This is very much consistent with the evidence in Schindler (2017) which shows the same effects (increasing graduation from higher secondary tracks but lower propensities to enroll in tertiary education from there).

— Table 6 here —

Note that these simulations ignore potential general equilibrium effects resulting from the increased supply of higher educational qualifications. However, such effects might be small if the additional supply is matched by additional demand (skill biased technical change). Also note that there is an important second round effect not modeled here. As explained above, the educational decisions considered by us are strongly dependent on parental background. This means that, as individuals obtain higher educational qualifications, their children will be increasingly pushed towards higher qualifications as well. As a consequence, the total wage effects of educational expansion will be higher than described by the simulation in this section.

7 Discussion and conclusion

This paper has studied educational transitions and heterogenous returns in the highly tracked German education system. Our model for educational transitions suggests strong sorting of individuals along observed and unobserved characteristics across the different tracks and stages of the system. This has severe consequences for expected wages from track choices as the continuation values of different tracks will strongly depend on what transitions individuals are likely to make at later stages. When comparing wage differences across neighboring nodes of the system, we find that in a large number of cases individuals have sorted on expected gains, i.e. the expected wage gains from making a particular transition were higher for those who took the transition than for those who did not.

We find however, that expected gains were in many cases also positive for those who did not make the particular transition. This is not necessarily evidence for irrational behavior because

the expected wage gains measured by us represent gross returns excluding monetary and non-monetary costs associated with a particular decision. Although there are no direct costs related to enrolling in the different stages of the system studied by us, there are indirect monetary costs (subsistence costs, foregone earnings) if an individual chooses to continue education as opposed to start working. Moreover, there are hard to measure psychic costs making the unobservable net return of educational choices low for individuals who find it hard or excessively time-consuming to complete certain educational degrees. It may also be the case that individuals do not really act on economic returns of educational choices but are influenced by factors such as family tradition or sociological concerns of status preservation (for a discussion of such aspects, see Biewen and Tapalaga, 2016).

When we compare expected wages implied by starting from the branches of the main crossroads of the system, the choice between the three secondary school tracks, we find that the expected wages of starting from a higher track were higher than those of starting from a lower track, even when controlling for the differential composition of the individuals sorting into the different tracks. However, we observe the interesting phenomenon that the difference in expected wages between higher and lower tracks was *smaller* for individuals who in fact chose the higher tracks because these more positively selected individuals would have been more likely to 'correct' their placement and upgrade to the higher track when counterfactually being forced to start from a lower track. This is a direct consequence of the flexibility of 'second chance' options to revise earlier choices and demonstrates the importance of modeling such options.

We directly evaluate the value of these options in terms of expected wages and find that it may be large. However, these options turn out to be much more valuable for individuals from privileged parental backgrounds as these are more likely to fully exploit the future possibilities opened up by switching to a higher track. Consistent with this finding, such individuals were also much more likely to exercise these options. This indicates that one of the original goals of introducing these flexibilities, i.e. to encourage less privileged population groups to upgrade to higher tracks, was not necessarily accomplished. In general, our results suggest that the returns to vocational training after secondary school degrees are large. The returns to academic vs. vocational training are also large on average but very dispersed. This demonstrates that academic training does not benefit all individuals equally. In some cases, especially when comparing academic training to an advanced vocational degree, a substantial part of the population faces negative expected returns to choosing the academic vs. the advanced vocational degree.

We make the following observations with respect to the tracking structure of the system studied by us. We do find sorting of individuals according to their unobserved abilities across the different tracks and stages as intended by the tracking system. We also find that when forcing individuals to start from other tracks than the ones they actually chose, they have the tendency to 'undo' this placement if a second chance option permits them to do so. However, we also observe that the expected returns to choosing higher tracks are positive for many individuals who in fact did not choose these tracks. Even when taking into account aspects such as monetary and psychic costs of educational decisions, the experience of the educational expansion seems to suggest that it was indeed possible to change the allocation of students to tracks in order to improve long-term educational and economic outcomes. Similarly, our results show that the increasing availability of second chance options increased the flexibility of the system. However, consistent with Schindler (2017), our analysis indicates that changes in the initial placement of students to secondary tracks had a bigger impact than the added flexibility of the system at later stages (although the latter may have amplified the effect of the former). Although the educational expansion was successful in increasing the number of graduates from the highest secondary track, part of this effect was undone by the fact that graduates of this track increasingly opted for vocational rather than academic training, leading to a less pronounced re-allocation of individuals than originally intended.

8 References

Aakvik, A., K.G. Salvanes, K. Vaage (2010). Measuring heterogeneity in the returns to education using an education reform. *European Economic Review*, Vol. 54, pp. 483-500.

Abbring, J., G. Van den Berg (2003). The Nonparametric Identification of Treatment Effects in Duration Models. *Econometrica*, Vol. 71, pp. 1491-1517.

Albanese, A., L. Cappellari, M. Leonardi (2017). The Effects of Youth Labor Market Reforms: Evidence from Italian Apprenticeships. *IZA Discussion Paper No. 10766*, IZA Institute of Labor Economics, Bonn.

Ammermüller, A. (2012): Institutional Features of Schooling Systems and Educational Inequality: Cross-Country Evidence from PIRLS and PISA. *German Economic Review*, Vol. 14, pp. 190-213.

- Balestra, S., U. Backes-Gellner (2017). Heterogeneous returns to education over the wage distribution: Who profits the most? *Labour Economics*, Vol. 44, pp. 89-105.
- Belzil, C. (2007). The return to schooling in structural dynamic models: a survey. *European Economic Review*, Volume 51, pp. 1059-1105.
- Belzil, C., J. Hansen (2007). A structural analysis of the correlated random coefficient wage regression model. *Journal of Econometrics*, Vol. 140, pp. 827-848.
- Betts, J.R. (2011): The Economics of Tracking in Education, in: Hanushek, E.A., S. Machin, and L. Wössmann (Eds.): *Handbook of the Economics of Education*, Vol. 3, Ch. 7. North Holland: Elsevier.
- Biewen, M., B. Fitzenberger, A. Osikominu, M. Paul (2014). The Effectiveness of Public-Sponsored Training Revisited: The Importance of Data and Methodological Choices. *Journal of Labor Economics*, Vol. 32, pp. 837-897.
- Biewen, M., M. Tapalaga (2016). Life-Cycle Educational Choices: Evidence for Two German Cohorts, *IZA Discussion Paper No. 9699*, Institute for the Study of Labor (IZA), Bonn.
- Biewen, M., M. Tapalaga (2017). Life-cycle educational choices in a system with early tracking and 'second chance' options. *Economics of Education Review*, Vol. 56, pp. 80-94.
- Blossfeld, H.-P., Roßbach, H.-G., von Maurice, J. (Eds.) (2011). Education as a lifelong process: The German National Educational Panel Study (NEPS). [Special Issue] *Zeitschrift für Erziehungswissenschaft*, Vol 14.
- Blundell, R., D. Dearden, B. Sianesi (2005). Evaluating the effect of education on earnings: models, methods and results from the National Child Development Survey. *Journal of the Royal Statistical Society, Series A*, Vol. 168, pp. 473-512.
- Brockmann, M. L. Clarke, C. Winch (2008). Knowledge, skills, competence: European divergences in vocational education and training (VET) - the English, German and Dutch cases, *Oxford Review of Education*, Vol. 34, pp. 547-567.
- Brunello, G. M. Giannini (2004): Stratified or Comprehensive? The Economic Efficiency of School Design, *Scottish Journal of Political Economy*, Vol. 51, pp. 173-193.

Brunello, G., D. Checchi (2007): Does school tracking affect equality of opportunity? New international evidence, *Economic Policy*, Vol. 22, pp. 781-861.

Brunello, G., L. Rocco, K. Ariga, R. Iwahashi (2012): On the efficiency costs of de-tracking secondary schools in Europe, *Education Economics*, Vol. 20, pp. 117-138.

Brunello, G., L. Rocco (2017). The Labor Market Effects of Academic and Vocational Education over the Life Cycle: Evidence Based on a British Cohort. *Journal of Human Capital*, Vol. 11, pp. 106-166.

Buchholz, S., A. Schier (2015): New Game, New Chance? Social Inequalities and Upgrading Secondary School Qualifications in West Germany, *European Sociological Review*, Vol. 31, pp. 591-602.

Cameron, S.V., J. Heckman (1998). Life Cycle Schooling and Dynamic Selection Bias: Models and Evidence for Five Cohorts of American Males. *Journal of Political Economy*, Vol. 106, pp. 262-333.

Cameron, S.V., J. Heckman (2001). The Dynamics of Educational Attainment for Black, Hispanic, and White Males. *Journal of Political Economy*, Vol. 109, pp. 455-499.

Card, D. (2001). Estimating the returns to schooling: progress on some persistent econometric problems. *Econometrica*, Vol. 69, pp. 1127-1160.

Carneiro, P., J.J. Heckman, E. Vytlačil (2010). Evaluating Marginal Policy Changes and the Average Effect of Treatment for Individuals at the Margin. *Econometrica*, Vol. 78, pp. 377-394.

Carneiro, P., J.J. Heckman, E. Vytlačil (2011). Estimating Marginal Returns to Education. *American Economic Review*, Vol. 101, pp. 2754-2781.

Carneiro, P., M. Lokshin, N. Umapathi (2016). Average and Marginal Returns to Upper Secondary Schooling in Indonesia. *Journal of Applied Econometrics*, Vol. 32, pp. 16-36.

Dearden, L., S. McIntosh, M. Myck, A. Vignoles (2002). The Returns to Academic and Vocational Qualifications in Britain. *Bulletin of Economic Research*, Vol. 54, pp. 249-274.

Dustmann, C. (2004): Parental background, secondary school choice, and wages. *Oxford Eco-*

conomic Papers, Vol. 56, pp. 209-230.

Dustmann, C., P. Puhani, U. Schönberg (2017). The Long-Term Effects of Early Track Choice. *Economic Journal*, Vol. 127, pp. 1348-1380.

Eichhorst, W., Rodriguez-Planas, N., Schmidl, R., Zimmermann, K.F. (2015). A roadmap to vocational education and training systems around the world. *Industrial and Labor Relations Review*, Vol. 68, pp. 314-337.

Fersterer, J., J.S. Pischke, R. Winter-Ebmer (2008). Returns to Apprenticeship Training in Austria: Evidence from Failed Firms. *Scandinavian Journal of Economics*, Vol. 110, pp. 733-753.

Flossmann, A.L., W. Pohlmeier (2006). Causal Returns to Education: A Survey on Empirical Evidence for Germany. *Journal of Economics and Statistics*, Vol. 226, pp. 6-23.

Fredriksson, P., P. Johansson (2008). Dynamic Treatment Assignment: The Consequences of Evaluations Using Observational Data. *Journal of Business and Economic Statistics*, Vol. 26, pp. 435-445.

Garen, J. (1984). The Returns to Schooling: A Selectivity Bias Approach with a Continuous Choice Variable. *Econometrica*, Vol. 52, pp. 1199-1218.

Gebel, M., F. Pfeiffer (2010). Educational Expansion and Its Heterogenous Returns for Wage Workers. *Journal of Applied Social Science Studies*, Vol. 130, pp. 19-42.

Hanushek, E.A., L. Wössmann (2006): Does Educational Tracking Affect Performance and Inequality? Differences-in-Differences Evidence Across Countries. *Economic Journal*, Vol. 116, pp. C363 - C376.

Hanushek, E.A., G. Schwerdt, L. Wössmann, L. Zhang (2017). General Education, Vocational Education, and Labor Market Outcomes over the Lifecycle. *Journal of Human Resources*, Vol. 52, pp. 48-87.

Harmon, C., V. Hogan, I. Walker (2003). Dispersion in the economic return to schooling. *Labour Economics*, Vol. 10, pp. 205-214.

Heckman, J.J., E. Vytlacil (2005). Structural Equations, Treatment Effects, and Econometric Policy Evaluation. *Econometrica*, Vol. 73, pp. 669-738.

Heckman, J.J., P.A. Lafontaine (2006). Bias-Corrected Estimates of GED Returns. *Journal of Labor Economics*, Vol. 24, pp. 661-700.

Heckman, J.J., S. Navarro (2007). Dynamic discrete choice and dynamic treatment effects. *Journal of Econometrics*, Vol. 136, pp. 341-396.

Heckman, J.J., E. Vytlacil (2007). Econometric Evaluation of Social Programs, Part II: Using the Marginal Treatment Effect to Organize Alternative Econometric Estimators to Evaluate Social Programs, and to Forecast their Effects in New Environments. In: Heckman, J.J., E.E. Leamer (eds.), *Handbook of Econometrics*, Vol. 6B, Ch. 71. Elsevier, North-Holland.

Heckman, J.J., L.J. Lochner, P.E. Todd (2006). Earnings functions, rates of return and treatment effects: The Mincer equation and beyond. In: Hanushek, E.A., F. Welch (eds.), *Handbook of the Economics of Education*, Volume 1, Chapter 7. Elsevier, North-Holland.

Heckman, J.J., J.E. Humphries, N.S. Mader (2011): The GED. In: Hanushek, E.A., S. Machin, and L. Wössmann (eds.): *Handbook of the Economics of Education*, Vol. 3, Ch. 9. Elsevier, North-Holland.

Heckman, J.J., R. Pinto, P. Savelyev (2013). Understanding the Mechanisms Through Which an Influential Early Childhood Program Boosted Adult Outcomes. *American Economic Review*, Vol. 103, pp. 2052-2086.

Heckman, J.J., J.E. Humphries, G. Veramendi (2016). Dynamic treatment effects. *Journal of Econometrics*, Vol. 191, pp. 276-292.

Heckman, J.J., J.E. Humphries, G. Veramendi (2017). Returns to Education: The Causal Effects of Education on Earnings, Health, and Smoking. Forthcoming in *Journal of Political Economy*

Henderson, D.J., S.W. Polachek, L. Wang (2011). Heterogeneity in schooling rates of return. *Economics of Education Review*, Vol. 30, pp. 1202-1214.

Hillmert, S., M. Jacob (2010): Selections and social selectivity on the academic track: A life-course analysis of educational attainment in Germany, *Research in Social Stratification and Mo-*

bility, Vol. 28, pp. 59-76.

Jacob, M., N. Tieben (2009). Social Selectivity of Track Mobility in Secondary Schools. *European Societies*, Vol. 11, pp. 747-773.

Jepsen, C., P. Mueser, K. Troske (2017). Second Chance for High School Dropouts? A Regression Discontinuity Analysis of Postsecondary Educational Returns to the GED. *Journal of Labor Economics*, Vol. 35., pp. S273-S304.

Jürges, H., S. Reinhold, M. Salm (2011). Does Schooling affect Health Behavior? Evidence from the Educational Expansion in Western Germany. *Economics of Education Review*, Vol. 30, pp. 862-872.

Kamhöfer, D.A., H. Schmitz (2016). Reanalyzing Zero Returns to Education in Germany. *Journal of Applied Econometrics*, Vol. 31, pp. 865-872.

Kamhöfer, D.A., M. Westphal (2017). Fertility Effects of College Education: Evidence from the German Educational Expansion. Paper presented at the Annual Conference of the Society of Population Economics (ESPE 2017), Glasgow.

Koop, G., J.L. Tobias (2004). Learning about Heterogeneity in Returns to Schooling. *Journal of Applied Econometrics*, Vol. 19, pp. 827-849.

Lechner, M. (2009). Sequential Causal Models for the Evaluation of Labor Market Programs. *Journal of Business and Economic Statistics*, Vol. 27, pp. 71-83.

Malamud, O., C. Pop-Eleches (2010). General Education versus Vocational Training: Evidence from an Economy in Transition. *Review of Economics and Statistics*, Vol. 92, pp. 43-60.

McIntosh, S. (2006). Further Analysis of the Returns to Academic and Vocational Qualifications. *Oxford Bulletin of Economics and Statistics*, Vol. 68, pp. 225-251.

Micklewright, J., M. Pearson, S. Smith (1990). Unemployment and Early School Leaving. *Economic Journal*, Vol. 100, pp. 163-169.

Mühlenweg, A.M., P. Puhani (2010): The Evolution of the School-Entry Age Effect in a School Tracking System. *Journal of Human Resources*, Vol. 45, pp. 407 - 438.

NEPS (2011). *Starting Cohort 6, Main Study 2010/11 (B67) Adults, Information on the Competence Test*. National Educational Panel Study, Bamberg.

OECD (2010). *Learning for Jobs*, OECD Publishing.

Oosterbeek, H., D. Webbing (2007). Wage effects of an extra year of basic vocational education. *Economics of Education Review*, Vol. 26, pp. 408-419.

Osikominu, A. (2013). Quick Job Entry or Long-Term Human Capital Development? The Dynamic Effects of Alternative Training Schemes. *Review of Economic Studies*, Vol. 80, pp. 313-342.

Riphahn, R., M. Zibrowius (2015). Apprenticeship, Vocational Training and Early Labor Market Outcomes - Evidence from East and West Germany. *Education Economics*, Vol. 24, pp. 33-57.

Rodriguez, J., S. Urzua, L. Reyes (2016). Heterogenous Economic Returns to Post-Secondary Degrees, Evidence from Chile. *Journal of Human Resources*, Vol. 51, pp. 416-460.

Schindler, S. (2017). School tracking, educational mobility and inequality in Germany secondary education: developments across cohorts. *European Societies*, Vol. 19, pp. 28-48.

Skopek, J. (2013). *Data Manual, Starting Cohort 6, Release 3.0.1*, National Educational Panel Study (NEPS), Bamberg.

Tieben, N., M.H.J. Wolbers (2010): Transitions to post-secondary and tertiary education in the Netherlands: a trend analysis of unconditional and conditional socio-economic background effects, *Higher Education*, Vol. 60, pp. 85-100.

Wössmann, L. (2016): The Importance of School Systems: Evidence from International Differences in Student Achievement, *Journal of Economic Perspectives*, Vol. 30, pp. 3-32.

Zamarro, G. (2010). Accounting for heterogenous returns in sequential schooling decisions. *Journal of Econometrics*, Vol. 156, pp. 260-276.

9 Figures

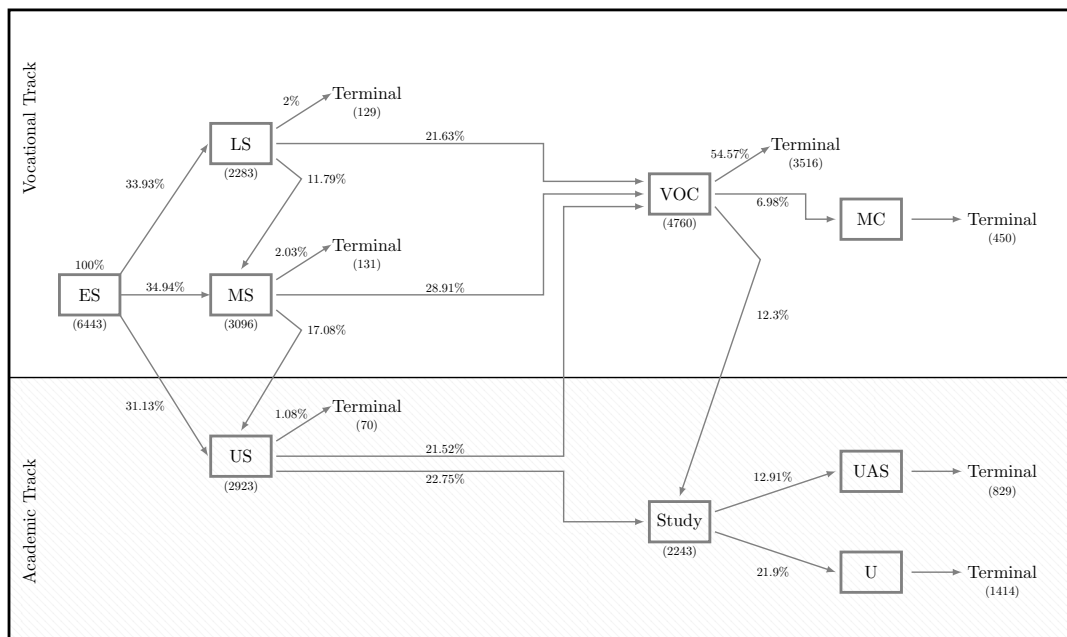
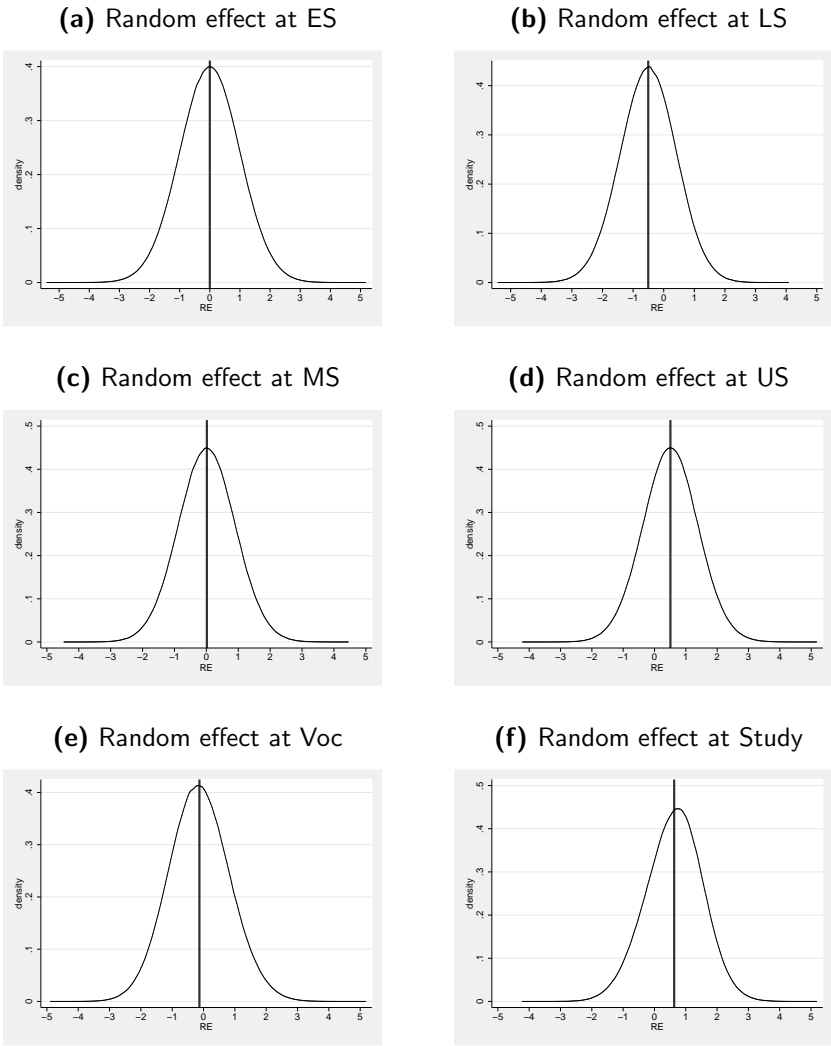

Figure 1 – German education system: percentages of population (sample observations in brackets). ES=Elementary school, LS=Lower secondary, MS=Middle secondary, US=Upper secondary, VOC=Vocational training, MC=Master craftsman, UAS=Univ. of applied sciences, U=University.

Source: NEPS, own calculations.

Figure 2 – Distribution of unobserved heterogeneity at decision nodes



Source: NEPS SC6 and own calculations. Vertical bars show means.

Figure 3 – Differences between final education levels for individuals choosing between them

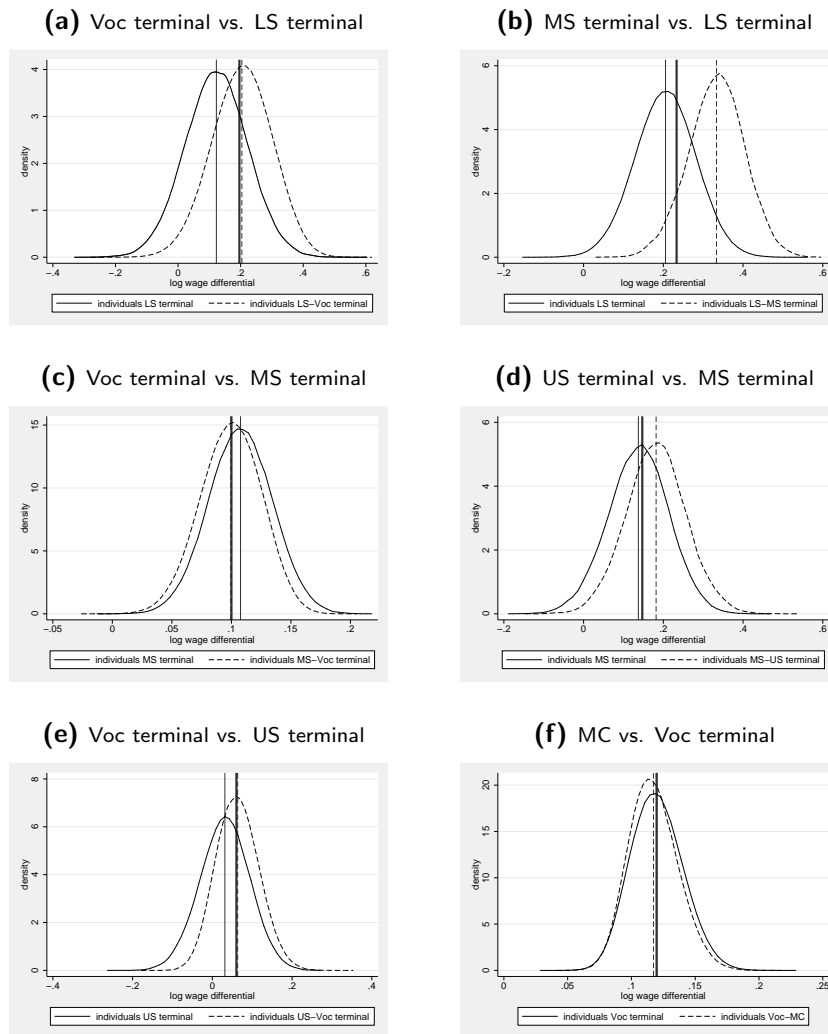

Source: NEPS SC6 and own calculations. Vertical bars show means, thick bars overall means.

Figure 4 – Differences between final education levels

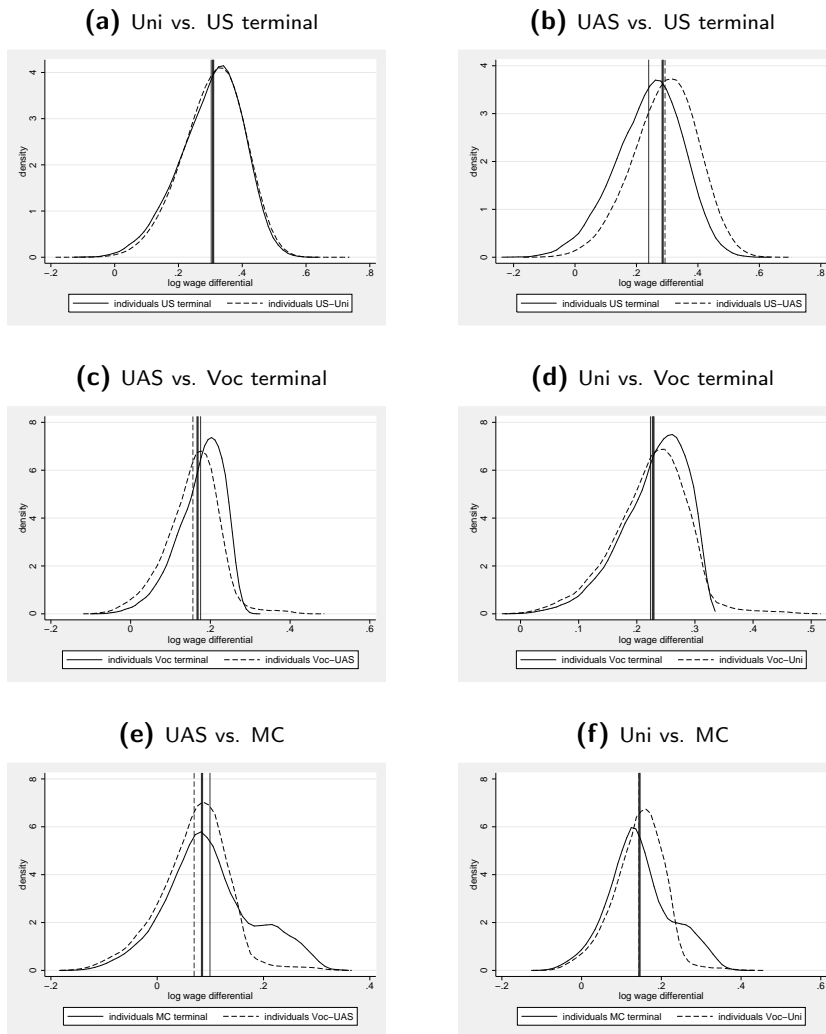

Source: NEPS SC6 and own calculations. Vertical bars show means, thick bars overall means.

Figure 5 – Letting individuals start from LS vs. from MS

(a) Expected wages from LS

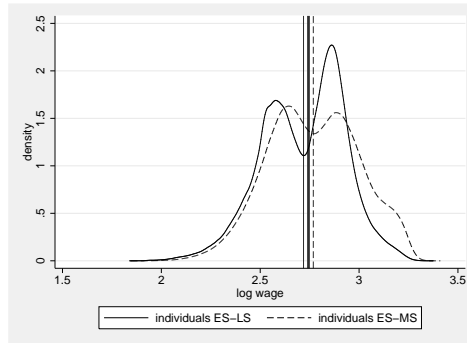

(b) Expected wages from MS

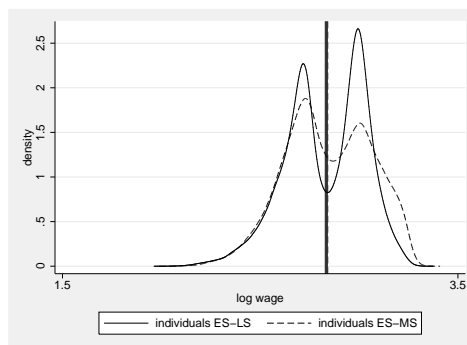

(c) Expected differential

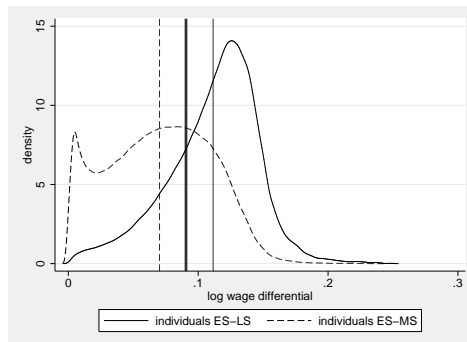

Source: NEPS SC6 and own calculations. Vertical bars show means, thick bars overall means.

Figure 6 – Letting individuals start from MS vs. from US

(a) Expected wages from MS

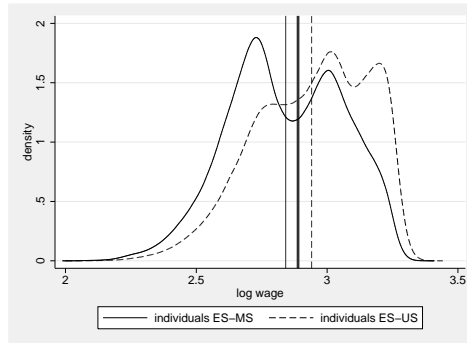

(b) Expected wages from US

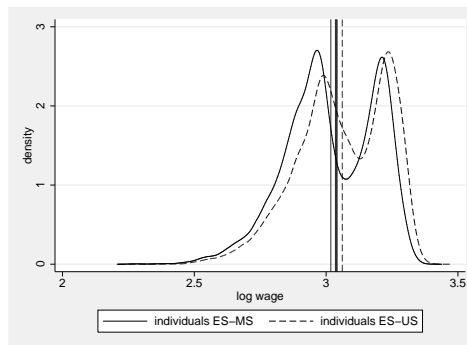

(c) Expected differential

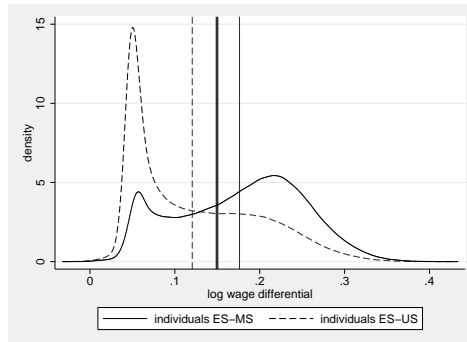

Source: NEPS SC6 and own calculations. Vertical bars show means, thick bars overall means.

Figure 7 – Expected returns to ‘second chance’ decisions

(a) LS-Voc vs. LS-MS

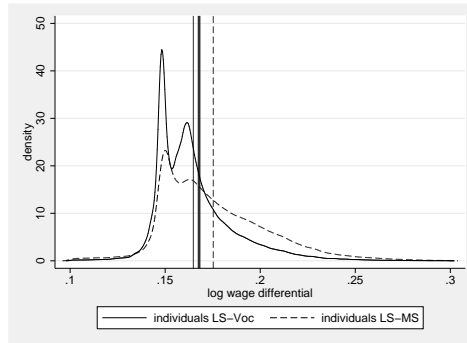

(b) MS-Voc vs. MS-US

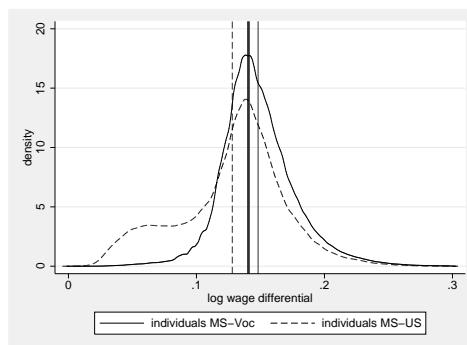

(c) Voc-MC vs. Voc-Study

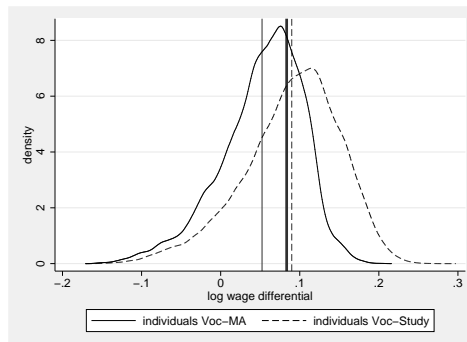

Source: NEPS SC6 and own calculations. Vertical bars show means, thick bars overall means.

Figure 8 – Expected returns to tertiary vs. vocational track choice for upper secondary graduates

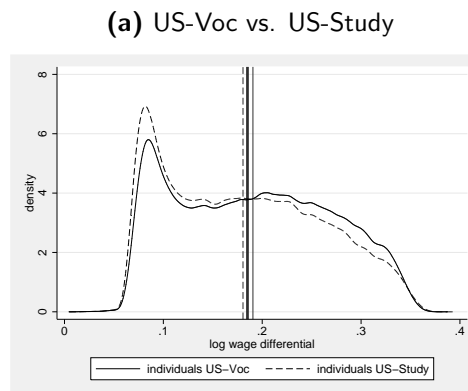

Source: NEPS SC6 and own calculations. Vertical bars show means, thick bars overall means.

10 Tables

Table 1 – Equations for competencies

Variable	Mathematical competency		Reading competency		Reading speed	
	coeff.	s.e.	coeff.	s.e.	coeff.	s.e.
Female	-.673653***	.0323998	.0047813	.0331654	.2334604***	.0304832
Age in 2008	.0942389***	.0237743	.1519021***	.0246052	.1306962***	.0224966
Age in 2008 squared	-.0013174***	.000268	-.0019433***	.0002746	-.0016876***	.0002544
Parental education: ED2	-.0297845	.0677358	.0748844	.0670016	.0193058	.0663767
Parental education: ED3	.1718337*	.0926093	.3540981***	.0942977	.2198087**	.0866332
Parental education: ED4	.3000048***	.0895534	.5331374***	.0898572	.2585579***	.0823968
Parental occupation: medium (OCC2)	.1534976***	.0394577	.2382802***	.0409001	.1583724***	.0377607
Parental occupation: high (OCC3)	.1716529***	.0526602	.2850193***	.0538719	.2628156***	.0487778
Broken family	-.1175203**	.0594729	-.1276097 **	.0552697	-.2249613***	.056524
Number of siblings	-.0466868***	.0106672	-.0821299***	.010851	-.0523491***	.0106781
Migration background	-.140318**	.0697674	-.192389***	.0672932	-.2251369***	.0649403
Final LS degree	.1945228	.2428506	.0089925	.2489814	-.0498868	.203798
Final MS degree	-.2652234	.315302	-.1543806	.340116	-.2806153	.2526668
Final US degree	-.5412095**	.2666345	-.1621324	.3115772	-.1875702	.228185
Final Voc ^a degree coming from LS	-.1252263**	.0542369	-.0977404*	.0556005	-.2279324***	.0529967
Final Voc ^a degree coming from US	.0409643	.0563307	-.0148061	.059498	-.0473438	.0531573
Final Voc degree going to Study	-.533563***	.081367	-.6861891***	.0885195	-.3843237***	.0674084
Final UAS degree	.2125846***	.0771295	.2104163***	.0794961	-.0491694	.0656842
Final Uni degree	.1392891*	.0770604	.1760343**	.0787382	-.048075	.0646855
Unobserved heterogeneity term	.6065411***	.0341003	.6802406***	.0335835	.463613***	.0288244
Constant	-1.16583**	.5270216	-2.917696***	.5461459	-2.430518***	.4970859
Error variance	.4592068	.0224755	.403302	.0236113	.6873745	.018427

Source: NEPS SC6 and own calculations. ^a = includes final MC.

Estimates from joint model of transitions, outcomes and competencies.

*** / ** / * significant at 1% / 5% / 10%-level.

Table 2 – Equations for grade point average

Variable	GPA at LS		GPA at MS		GPA at US	
	coeff.	s.e.	coeff.	s.e.	coeff.	s.e.
Female	-.116264**	.0510155	-.0809362**	.0347982	.0232011	.0278935
Age in 2008	-.0357005	.0536743	-.0381381	.0361715	-.0513204*	.029041
Age in 2008 squared	.0005936	.0006333	.000565	.0004332	.0006696*	.0003482
Parental education: ED2	-.1214083	.084247	.0016972	.0708809	-.0322145	.0892761
Parental education: ED3	-.3948323**	.165926	.1123034	.1030697	-.0724535	.1018458
Parental education: ED4	-.40876**	.1786127	-.1667818	.1093035	-.2528923***	.0957038
Parental occupation: medium (OCC2)	-.1691464***	.0579467	-.0031901	.0371817	.0342926	.0397105
Parental occupation: high (OCC3)	-.1785723*	.103045	-.0465739	.0562668	-.0582992	.0459669
Broken family	.1393029	.0914569	.0964936	.0635458	.0261534	.0510648
Number of siblings	.0382901***	.0134199	.0137524	.0114781	-.0147055	.0122806
Migration background	-.0214966	.1571084	.0752603	.0788693	-.0764869	.0759207
Unobserved heterogeneity term	-.3055958***	.0473741	-.1360437***	.0341626	-.2203625***	.0297493
Constant	3.001922***	1.130788	3.115015***	.7483525	3.646886***	.6005986
Error variance	.2788748	.0243835	.2757829	.0130189	.2967681	.0119203

Source: NEPS SC6 and own calculations.

Estimates from joint model of transitions, outcomes and competencies.

*** / ** / * significant at 1%/5%/10%-level.

Table 3 – Wage equations

Variable	coeff.	s.e.
	School degree	
Female	-.2186071***	.0600465
Experience	.038003***	.0147528
Experience squared	-.0004711*	.0002801
Final MS degree	.322856**	.1399986
Final US degree	.4458536**	.1941964
Unobserved heterogeneity term for LS degree	-.0720775	.1037451
Unobserved heterogeneity term for MS degree	.0161441	.069126
Unobserved heterogeneity term for US degree	.1107236	.1102211
Constant	1.81738***	.246171
Error variance	.1623742	.017466
Vocational training		
Female	-.2497661***	.0173714
Experience	.0378321***	.0050254
Experience squared	-.0004968***	.0000956
Final MC degree	.1106488***	.025617
Coming from middle secondary	.1475871***	.018241
Coming from upper secondary	.2318341***	.0255515
Unobserved heterogeneity term for Voc degree	.0441634**	.0175171
Unobserved heterogeneity term for MC degree	.0196982	.0399295
Constant	2.144849***	.0661768
Error variance	.1721121	.0071098

	Tertiary education	
Final University degree (vs. UAS)	.0512706	.0313546
Female	-.2127863***	.0223326
Experience	.0386728***	.0065466
Experience squared	-.0006527***	.0001379
Coming from upper secondary	.0416652	.0493151
Previous vocational training degree	-.0558542*	.0310953
Unobserved heterogeneity term for UAS degree	.0238147	.0260827
Unobserved heterogeneity term for Uni degree	.0410182*	.0225667
Constant	2.618494***	.0910835
Error variance	.2126807	.0129327

Source: NEPS SC6 and own calculations.

Estimates from joint model of transitions, outcomes and competencies.

***/**/* significant at 1%/5%/10%-level.

Table 4 – Mean probabilities of reaching terminal nodes and expected wages by trajectory

Trajectory	ES-LS ^a	ES-MS ^b	ES-US ^c	all	mean logwage	s.e.
LS-LS terminal	.058	.013	.003	.025	2.335	.134
LS-Voc terminal	.551	.344	.179	.377	2.625	.019
LS-Voc-MC	.062	.040	.024	.044	2.735	.026
LS-Voc-UAS	.008	.017	.024	.015	2.971	.042
LS-Voc-Uni	.006	.013	.022	.013	3.023	.046
LS-MS terminal	.017	.021	.019	.019	2.658	.041
LS-MS-Voc terminal	.172	.214	.132	.174	2.772	.013
LS-MS-MC	.027	.029	.019	.025	2.883	.024
LS-MS-Voc-UAS	.011	.033	.043	.029	2.971	.042
LS-MS-Voc-Uni	.003	.008	.014	.008	3.023	.046
LS-MS-US terminal	.002	.008	.016	.009	2.781	.123
LS-MS-US-Voc terminal	.029	.079	.089	.065	2.856	.019
LS-MS-US-Voc-MC	.007	.015	.017	.013	2.967	.026
LS-MS-US-Voc-UAS	.012	.070	.171	.081	3.013	.030
LS-MS-US-Voc-Uni	.004	.026	.093	.039	3.064	.037
LS-MS-US-UAS	.011	.027	.043	.027	3.069	.022
LS-MS-US-Uni	.014	.041	.103	.051	3.120	.020
MS-MS terminal	.054	.038	.027	.040	2.658	.041
MS-Voc terminal	.698	.501	.256	.493	2.772	.013
MS-Voc-MC	.068	.046	.026	.048	2.883	.024
MS-Voc-UAS	.008	.018	.024	.016	2.971	.042
MS-Voc-Uni	.005	.013	.021	.013	3.023	.046
MS-US terminal	.005	.012	.019	.012	2.781	.123
MS-US-Voc terminal	.062	.121	.118	.100	2.856	.019
MS-US-MC	.016	.026	.025	.022	2.967	.026
MS-US-Voc-UAS	.019	.088	.196	.098	3.013	.030
MS-US-Voc-Uni	.006	.032	.103	.045	3.064	.037
MS-US-UAS	.027	.042	.056	.041	3.069	.022
MS-US-Uni	.027	.057	.123	.067	3.120	.020
US-US terminal	.014	.018	.018	.016	2.781	.123

US-Voc terminal	.214	.243	.161	.208	2.856	.019
US-Voc-MC	.020	.023	.017	.020	2.967	.026
US-Voc-UAS	.006	.028	.056	.029	3.013	.030
US-Voc-Uni	.004	.026	.074	.033	3.064	.037
US-UAS	.319	.214	.138	.226	3.069	.022
US-Uni	.420	.446	.532	.464	3.120	.020

Source: NEPS SC6 and own calculations. Bootstrapped standard errors.

^a = individuals who factually chose ES-LS

^b = individuals who factually chose ES-MS

^c = individuals who factually chose ES-US

Table 5 – Average treatment effects incl. continuation values

Wage differentials	ATT	s.e.	ATU	s.e.	ATE	s.e.	AMTE	s.e.
LS vs. MS ^a	.069	.009	.111	.013	.090	.011	.098	.011
<i>Parental education ED1</i>	.089	.015	.129	.018	.117	.017	.109	.016
<i>Parental education ED2</i>	.072	.009	.110	.013	.091	.011	.098	.011
<i>Parental education ED3</i>	.051	.012	.087	.016	.062	.012	.083	.015
<i>Parental education ED4</i>	.045	.014	.080	.018	.054	.015	.079	.019
MS vs. US ^b	.120	.013	.176	.015	.149	.013	.140	.012
<i>Parental education ED1</i>	.121	.017	.161	.020	.148	.019	.124	.018
<i>Parental education ED2</i>	.130	.013	.178	.015	.161	.014	.141	.012
<i>Parental education ED3</i>	.118	.015	.169	.018	.137	.015	.144	.016
<i>Parental education ED4</i>	.104	.017	.162	.018	.116	.017	.139	.017
LS-Voc vs. LS-MS ^c	.172	.016	.164	.018	.166	.017	.169	.016
<i>Parental education ED1</i>	.155	.016	.156	.018	.156	.017	.156	.016
<i>Parental education ED2</i>	.171	.016	.164	.018	.166	.017	.169	.016
<i>Parental education ED3</i>	.181	.017	.171	.020	.176	.018	.177	.018
<i>Parental education ED4</i>	.206	.018	.192	.021	.199	.019	.199	.019
MS-Voc vs. MS-US ^d	.128	.020	.148	.021	.140	.019	.143	.018
<i>Parental education ED1</i>	.104	.023	.124	.022	.118	.021	.118	.021
<i>Parental education ED2</i>	.125	.020	.146	.021	.139	.019	.140	.018
<i>Parental education ED3</i>	.130	.021	.155	.023	.144	.020	.148	.019
<i>Parental education ED4</i>	.152	.023	.193	.024	.170	.022	.184	.021
Voc-MC vs. Voc-Study ^e	.089	.061	.052	.039	.083	.055	.058	.045
<i>Parental education ED1</i>	.069	.073	.041	.043	.065	.068	.054	.055
<i>Parental education ED2</i>	.082	.065	.049	.039	.075	.058	.054	.047
<i>Parental education ED3</i>	.096	.056	.059	.040	.090	.050	.063	.040
<i>Parental education ED4</i>	.119	.049	.073	.047	.115	.046	.087	.038
US-Voc vs. US-Study ^f	.180	.020	.190	.019	.185	.019	.185	.019
<i>Parental education ED1</i>	.170	.023	.180	.022	.176	.022	.176	.022
<i>Parental education ED2</i>	.183	.021	.194	.020	.189	.020	.188	.020
<i>Parental education ED3</i>	.180	.021	.189	.020	.184	.020	.184	.020
<i>Parental education ED4</i>	.175	.022	.179	.020	.176	.021	.177	.020

Source: NEPS SC6 and own calculations. Bootstrapped standard errors.

ATT/ATU=Average treatment effect on treated/untreated, ATE=Average treatment effect

AMTE=Average marginal treatment effect

^a = for individuals who factually chose ES-LS or ES-MS

^b = for individuals who factually chose ES-MS or ES-US

^c = for individuals who factually chose LS-Voc or LS-MS

^d = for individuals who factually chose MS-Voc or MS-US

^e = for individuals who factually chose Voc-MC or Voc-Study

^f = for individuals who factually chose US-Voc or US-Study

Table 6 – Policy relevant treatment effects

Label	Description	Percentage affected	PRTE	s.e.
<i>Policy 1</i>	Initial secondary track placement (Fix in <i>ES</i> node time trends and share of individuals going to <i>LS/MS/US</i> to level of 1960)	16.9	.203***	.014
<i>Policy 2</i>	Secondary track upgrading possibilities (Fix in <i>LS</i> and <i>MS</i> node time trends to level of 1970)	6.4	-.015	.033
<i>Policy 3</i>	Enrollment in tertiary education (Fix in <i>US</i> node time trends, and in <i>MS</i> , <i>US</i> and <i>Voc</i> node ratio students/individuals 20-22 years and tertiary institutions density to level of 1970)	16.1	.012	.033
<i>Policy 4</i>	All of the changes above	32.8	.148***	.022

Source: NEPS SC6 and own calculations.

***/**/* significant at 1%/5%/10%-level.

11 Appendix

Table A1 – Descriptive statistics

<i>Background variables</i>		
Maximal education of parents	mean	s.d.
Lower than vocational training: ED1 (<i>reference category</i>)	.065	.247
Vocational training, no upper secondary degree: ED2	.726	.445
Upper secondary degree (and possibly vocational training): ED3	.071	.257
Tertiary education degree: ED4	.137	.343
Maximal occupational status of parents	mean	s.d.
Low: OCC1 (<i>reference category</i>)	.392	.488
Medium: OCC2	.414	.492
High: OCC3	.193	.394
Further background variables	mean	s.d.
Female	.513	.499
Broken family	.090	.286
Number of siblings	1.889	1.566
Migration status	.064	.245
<i>Node-specific variables</i>		
Information on previous transitions	mean	s.d.
Kindergarten	.658	.474
School upward mobility	.262	.440
Coming from middle secondary	.305	.460
Coming from upper secondary	.466	.498
Previous vocational training degree	.341	.474
Control variables for transitions (not shown: quadratic time trends)	mean	s.d.
Region: North	.226	.418
Region: West	.288	.452
Region: Middle (<i>reference category</i>)	.178	.382
Region: South	.307	.461
Age in 2008	45.198	7.470
Node instruments	mean	s.d.
Born before cutoff date	.400	.489
Share of pupils by federal state going to LS (%)	48.973	12.780
Share of pupils by federal state going to MS (%)	24.260	7.348
Share of pupils by federal state going to US (%)	26.765	6.652
Ratio students/individuals 20-22y (%)	44.875	17.402
Academic institutions density (per 1 mio people at federal state level)	4.648	1.430
Deviation unemployment rate	.018	1.280
<i>Wage equation</i>		
Hourly wage (euros)	mean	s.d.
Only school degree	15.399	6.865
Vocational training or master craftsman degree	17.841	12.675
Tertiary education degree	25.684	21.671
Experience	25.467	8.354
<i>Equations for competencies</i>		
Grade point average	mean	s.d.
Grade point average at LS	2.713	.594
Grade point average at MS	2.564	.538
Grade point average at US	2.474	.580
Standardized competencies	mean	s.d.
Mathematical	-.0002	1.000
Reading	.0003	1.000
Reading speed	-.0008	.999
Additional control variables competencies	mean	s.d.
Final LS degree	.020	.140

Final MS degree	.020	.141
Final US degree	.010	.103
Final Voc ^a degree coming from LS	.213	.409
Final Voc ^a degree coming from MS (<i>reference category</i>)	.272	.445
Final Voc ^a after US degree	.115	.319
Final Voc degree going to Study	.123	.328
Final UAS degree	.128	.334
Final Uni degree	.219	.413
Observations	6,442	

Source: NEPS SC6 and own calculations. ^a = includes final MC.

Table A2 – Equations for educational transitions

Variable	ES-LS (base cat.)	ES-MS		ES-US	
		coeff.	s.e.	coeff.	s.e.
Female		.3814803***	.0833979	.1767633*	.1062211
Broken family		-.5514625***	.1434031	-.9356326***	.1934537
Number of siblings		-.2459077***	.0287489	-.4133738***	.0419699
Migration background		.013164	.1793766	-.0581336	.2200433
Parental education: ED2		.4534817***	.1648056	.3181295	.245467
Parental education: ED3		1.465704***	.261334	2.458918***	.3356647
Parental education: ED4		1.677371***	.2692221	3.530343***	.3440416
Parental occupation: medium (OCC2)		.9633301***	.0983624	1.78297***	.1375667
Parental occupation: high (OCC3)		.9998745***	.1436269	2.011324***	.1840875
Born before cutoff date		-.22593***	.0842135	-.2668785***	.1039123
Share pupils going to MS		.0325033**	.0129649	-.0029483	.0156979
Share pupils going to US		.0389759***	.0117721	.0516066***	.0136819
Kindergarten		.1010071	.0895478	.2500636**	.112775
Region: North		.1317159	.1633813	.3290221	.197244
Region: West		-.0238965	.1229475	.1194885	.1523805
Region: South		-.2730232**	.1307385	-.3179231**	.160951
Time		.2828089***	.0334557	.3839499***	.0424263
Time squared		-.004988***	.0006032	-.0067939***	.0007583
Unobserved heterogeneity term		1.1412***	.093497	1.976569***	.1457266
Constant		-5.592157***	.3733579	-7.405066***	.5374407
	LS-term (base cat.)	LS-Voc		LS-MS	
Female		-1.588765***	.3010337	-1.172795***	.3251985
Broken family		-1.121321***	.3282701	-1.797249***	.384922
Number of siblings		-.2307044***	.0666432	-.4174871***	.0768955
Migration background		-1.220591***	.3628531	-.9791022**	.4183685
Parental education: ED2		.7291115**	.316421	1.058632***	.375823
Parental education: ED3		1.473912	.964663	2.654594***	1.03305
Parental education: ED4		1.685816	1.096761	3.435057***	1.139424
Parental occupation: medium (OCC2)		.7650118**	.3135831	1.530227***	.3441646
Parental occupation: high (OCC3)		.4211893	.4959375	1.337589**	.5364126
Unemployment rate deviation		-.0791358	.1027021	-.1114863	.1110878
Region: North		.1262397	.3699958	.0362297	.406436
Region: West		.0779843	.3403983	.1265166	.3716712
Region: South		-.2277611	.372561	-.8088722**	.4063376
Time		.1597618**	.0766161	.3184146***	.0887844
Time squared		-.0023275*	.0013143	-.0044271***	.0015088
Unobserved heterogeneity term		1.303027**	.6196755	2.378357***	.653447
Constant		2.384264*	1.301092	-.6700812	1.422436

	MS-term (base cat.)	MS-Voc		MS-US	
Female		-.6809035***	.243958	-1.70785***	.2669188
Broken family		-.2535158	.3692764	-.1955458	.3930883
Number of siblings		-.0451301	.0873115	-.2473454**	.0977703
Migration background		.1311615	.470989	.3841759	.5051889
Parental education: ED2		-.3841551	.4557659	-.0469312	.4973949
Parental education: ED3		-.792708	.7392884	.5210371	.7757775
Parental education: ED4		-1.210497	.9734397	1.172098	1.01032
Parental occupation: medium (OCC2)		.2074584	.3550373	.9689929**	.3955232
Parental occupation: high (OCC3)		.5443364	.5673595	1.626984***	.6141649
Ratio students/individuals 20-22y (%)		-.0125506	.0103157	.0396429***	.0128397
Academic institutions density		.0035796	.0918803	.0915846	.1005417
Unemployment rate deviation		.0723487	.0925589	.1004974	.0978876
Region: North		.6427268*	.3718865	.52362	.3951306
Region: West		.1493658	.3751484	.6483414	.405071
Region: South		-.2800177	.3252772	-.8849133**	.352236
Time		.2500601***	.0936263	.4161234***	.1132254
Time squared		-.003089**	.0013767	-.0071196***	.0017473
Unobserved heterogeneity term		-.6178982	.9619942	1.267029	.9901926
Constant		-.4699656	1.898124	-5.301034**	2.279464
	US-term (base cat.)	US-Voc		US-Study	
Female		-.0563255	.2765682	-.650402**	.2793234
Broken family		-.697259*	.3968112	-.4969245	.4045024
Number of siblings		.1022919	.1320579	.1965513	.1340663
Migration background		-.8627462**	.4349819	-.684052	.4455514
Parental education: ED2		.3808581	.7366768	.8067554	.7930979
Parental education: ED3		.725562	.8912276	1.006976	.9373816
Parental education: ED4		.9932749	.9003853	1.820141*	.9476076
Parental occupation: medium (OCC2)		-.3718018	.4272087	-.0061106	.4402568
Parental occupation: high (OCC3)		-.6989082	.4671633	-.3180044	.4769735
Ratio students/individuals 20-22y (%)		-.0261772*	.0140031	.0238606	.0147713
Academic institutions density		-.0427381	.1010209	-.0978499	.1020026
Previous school upward mobility		.3685359	.378448	-1.486173***	.3834544
Unemployment rate deviation		.1890771**	.0924475	.175108*	.0928883
Region: North		-.3324743	.4023592	-.6570276	.4083165
Region: West		.4577944	.4602907	-.1214993	.463053
Region: South		.4659668	.4377589	.5350819	.4440824
Time		.2283884**	.1122737	.1471593	.1175106
Time squared		-.0022393	.0014206	-.0034129**	.0015591
Unobserved heterogeneity term		-.0972454	.5951111	-.3377056	.6238725
Constant		-.9823946	2.278082	1.579616	2.375529
	Voc-term (base cat.)	Voc-MC		Voc-Study	
Female		-2.879963***	.1885826	-2.044174***	.2493053
Broken family		-.7122605***	.2382202	-.8496297**	.3490391
Number of siblings		.014125	.0348264	-.3004666***	.072539
Migration background		-.1032596	.2750694	-.0518747	.4022804
Parental education: ED2		.2486443	.2400715	-.3306709	.3869132
Parental education: ED3		.329151	.347998	.9252421*	.5234817
Parental education: ED3		.3177208	.34815	2.409212***	.5273747
Parental occupation: medium (OCC2)		.102164	.1327507	1.273245***	.248227
Parental occupation: high (OCC3)		.243057	.1889214	1.832161***	.3315378
Ratio students/individuals 20-22y (%)		-.0174719	.0120809	-.0090521	.0163335
Academic institutions density		.014885	.0521815	.1024965	.077989
Previous school upward mobility		.5801257***	.1306532	1.170355***	.210401
Unemployment rate deviation		-.036457	.0452659	-.0086918	.0594373

Region: North		-.064165	.1992449	.2416521	.2957971
Region: West		.1499878	.2012222	.1723705	.2968728
Region: South		.0978343	.1749011	-.5741789**	.2717709
Age in 2008		.1179312	.1295996	.0561051	.1755647
Age in 2008 squared		-.001814	.0012685	-.0011276	.0017417
Unobserved heterogeneity term		.3326692***	.1134712	3.627758***	.4033796
Constant		-2.426481	3.711887	-3.177253	5.012553
	Study-UAS (base cat.)		Study-Uni		
Female				.0148652	.1165822
Broken family				.0380377	.218052
Number of siblings				.0094044	.047421
Migration background				.4659578*	.2427819
Parental education: ED2				-.345253	.3091244
Parental education: ED3				-.0012845	.3633189
Parental education: ED4				.5694896	.3521519
Parental occupation: medium (OCC2)				.3313677**	.1666272
Parental occupation: high (OCC3)				.6140924***	.198684
Previous school upward mobility				-.9925618***	.1243182
Previous vocational training degree				-1.880963***	.1849318
Unemployment rate deviation				.0304453	.0408055
Region: North				.2471124	.1723552
Region: West				-.0214807	.1628148
Region: South				-.5684757***	.1646015
Age in 2008				.0659768	.0784576
Age in 2008 squared				-.0004562	.0008885
Unobserved heterogeneity term				.8080661***	.1774381
Constant				-1.141123	1.745111

Source: NEPS SC6 and own calculations.

Estimates from joint model of transitions, outcomes and competencies.

***/**/* significant on 1%/5%/10%

Table A3 – Differences between treatment effects and average treatment effects

Wage differentials	ATT-ATE	ATU-ATE	AMTE-ATE
LS vs. MS ^a	-.020***	.020***	.007***
<i>Parental education ED1</i>	-.028***	.011***	-.007*
<i>Parental education ED2</i>	-.019***	.019***	.006***
<i>Parental education ED3</i>	-.010***	.024***	.020***
<i>Parental education ED4</i>	-.009***	.025***	.024***
MS vs. US ^b	-.029***	.026***	-.009***
<i>Parental education ED1</i>	-.027***	.012***	-.024***
<i>Parental education ED2</i>	-.030***	.017***	-.020***
<i>Parental education ED3</i>	-.018***	.032***	.007***
<i>Parental education ED4</i>	-.012***	.045***	.022***
LS-Voc vs. LS-MS ^c	.005	-.002	.003
<i>Parental education ED1</i>	-.0003	.0001	.000
<i>Parental education ED2</i>	.004	-.002	.002
<i>Parental education ED3</i>	.004	-.004	.001
<i>Parental education ED4</i>	.006	-.007*	-.0000
MS-Voc vs. MS-US ^d	-.012	.007	.002
<i>Parental education ED1</i>	-.014	.005	-.0004
<i>Parental education ED2</i>	-.013	.007	.0009
<i>Parental education ED3</i>	-.014	.011	.003
<i>Parental education ED4</i>	-.017**	.023**	.014**
Voc-MC vs. Voc-Study ^e	.006	-.031	-.024
<i>Parental education ED1</i>	.003	-.024	-.011
<i>Parental education ED2</i>	.006	-.026	-.021
<i>Parental education ED3</i>	.005	-.030	-.026
<i>Parental education ED4</i>	.003	-.041	-.027
US-Voc vs. US-Study ^f	-.004	.005	.0002
<i>Parental education ED1</i>	-.006	.003	.0000
<i>Parental education ED2</i>	-.005*	.005*	-.0001
<i>Parental education ED3</i>	-.003	.004	-.0000
<i>Parental education ED4</i>	-.001	.002	.0007

Source: NEPS SC6 and own calculations.

ATT/ATU=Average treatment effect on treated/untreated, ATE=Average treatment effect

AMTE=Average marginal treatment effect

^a = for individuals who factually chose ES-LS or ES-MS

^b = for individuals who factually chose ES-MS or ES-US

^c = for individuals who factually chose LS-Voc or LS-MS

^d = for individuals who factually chose MS-Voc or MS-US

^e = for individuals who factually chose Voc-MC or Voc-Study

^f = for individuals who factually chose US-Voc or US-Study

Bootstrapped standard errors, ***/**/* significant at 1%/5%/10%-level.