

Estévez-Fernández, Arantza; Hamers, Herbert

Working Paper

Chinese postman games with repeated players

Tinbergen Institute Discussion Paper, No. TI 2018-081/II

Provided in Cooperation with:

Tinbergen Institute, Amsterdam and Rotterdam

Suggested Citation: Estévez-Fernández, Arantza; Hamers, Herbert (2018) : Chinese postman games with repeated players, Tinbergen Institute Discussion Paper, No. TI 2018-081/II, Tinbergen Institute, Amsterdam and Rotterdam

This Version is available at:

<https://hdl.handle.net/10419/185600>

Standard-Nutzungsbedingungen:

Die Dokumente auf EconStor dürfen zu eigenen wissenschaftlichen Zwecken und zum Privatgebrauch gespeichert und kopiert werden.

Sie dürfen die Dokumente nicht für öffentliche oder kommerzielle Zwecke vervielfältigen, öffentlich ausstellen, öffentlich zugänglich machen, vertreiben oder anderweitig nutzen.

Sofern die Verfasser die Dokumente unter Open-Content-Lizenzen (insbesondere CC-Lizenzen) zur Verfügung gestellt haben sollten, gelten abweichend von diesen Nutzungsbedingungen die in der dort genannten Lizenz gewährten Nutzungsrechte.

Terms of use:

Documents in EconStor may be saved and copied for your personal and scholarly purposes.

You are not to copy documents for public or commercial purposes, to exhibit the documents publicly, to make them publicly available on the internet, or to distribute or otherwise use the documents in public.

If the documents have been made available under an Open Content Licence (especially Creative Commons Licences), you may exercise further usage rights as specified in the indicated licence.

TI 2018-081/II
Tinbergen Institute Discussion Paper



Chinese postman games with repeated players

Arantza (M.A.) Estevez-Fernandez¹

Herbert Hamers²

¹ VU Amsterdam, The Netherlands

² Tilburg University, The Netherlands

Tinbergen Institute is the graduate school and research institute in economics of Erasmus University Rotterdam, the University of Amsterdam and VU University Amsterdam.

Contact: discussionpapers@tinbergen.nl

More TI discussion papers can be downloaded at <http://www.tinbergen.nl>

Tinbergen Institute has two locations:

Tinbergen Institute Amsterdam
Gustav Mahlerplein 117
1082 MS Amsterdam
The Netherlands
Tel.: +31(0)20 598 4580

Tinbergen Institute Rotterdam
Burg. Oudlaan 50
3062 PA Rotterdam
The Netherlands
Tel.: +31(0)10 408 8900

Chinese postman games with repeated players

Arantza Estévez-Fernández^{a, c}

Herbert Hamers^b

October 26, 2018

Abstract

This paper analyses Chinese postman games with repeated players, which generalize Chinese postman games by dropping the one-to-one relation between edges and players. In our model, we allow players to own more than one edge, but each edge belongs to at most one player. The one-to-one relation between edges and players is essential for the equivalence between Chinese postman-totally balanced and Chinese postman-submodular graphs shown in Granot et al. (1999). We illustrate the invalidity of this result in our model. Besides, the location of the post office has a relevant role in the submodularity and totally balancedness of Chinese postman games with repeated players. Therefore, we focus on sufficient conditions on the assignment of players to edges to ensure submodularity of Chinese postman games with repeated players, independently of the associated travel costs. Moreover, we provide some insights on the difficulty of finding necessary conditions on assignment functions to this end.

Keywords: Chinese postman games with repeated players, balanced game, totally balanced game, submodular game, assignment function.

JEL Classification Number: C71

1 Introduction

In this paper, we analyse Chinese postman games with repeated players (cprp games), which generalize Chinese postman games. In a Chinese postman problem, a postman has to visit a group of customers starting and ending in the post office. One can see it as a service provider that has to visit a group of clients. Usually, there are travelling costs associated with the visit. The relevant question is, then, how

^aTinbergen Institute and Department of Econometrics & OR, VU University Amsterdam, De Boelelaan 1105, 1081 HV Amsterdam, The Netherlands.

^bCentER and Department of Econometrics & OR, Tilburg University, P.O. Box 90153, 5000 LE Tilburg, The Netherlands.

^cCorresponding author. *E-mail address:* arantza.estevezfernandez@vu.nl

to reduce the travel costs of visiting all customers. When the customers have to pay for these costs, a second question arises: how to divide the travel costs among all customers. The analysis of the operational research problem dates back to Mei-Ko Kwan (1960), Mei-Ko Kwan (1962), and Edmonds and Johnson (1973), while the allocation problem was first addressed in a game-theoretical framework in Hamers, Borm, van de Leensel and Tijs (1999). In their work, they represent the city by a graph and assume a one-to-one relation between the set of customers and the set of edges of the graph. They introduce Chinese postman games by defining the value of a group of customers (or coalition) as the minimum cost over all possible walks for the coalition. Here, a walk is a tour that starts at the post office, visits each customer, and goes back to the post office at the end. Moreover, they illustrate that Chinese postman games need not be balanced in general, although they are always balanced when the underlying graph is a bridge-connected Euler graph. Following the work of Hamers et al. (1999), Hamers (1997) shows that Chinese postman games are always submodular when the underlying graph is a bridge-connected cycle. Granot, Hamers and Tijs (1999) further investigate Chinese postman games in the same framework as Hamers et al. (1999). They define Chinese postman-submodular, Chinese postman-totally balanced, and Chinese postman-balanced graphs. A graph G is postman-submodular if any associated Chinese postman game with underlying graph G is submodular, independently of the post office location and of the travel costs. Similarly, they define Chinese postman-totally balanced and Chinese postman-balanced graphs. They show the equivalence between undirected weak cyclic graphs, Chinese postman-submodular graphs, and Chinese postman-totally balanced graphs. Further, they show that the class of undirected Chinese postman-balanced graphs is the class of weakly Euler graphs. Following Granot et al. (1999), Granot and Hamers (2004) analyse the equivalence between Chinese postman-submodular (as well as balanced and totally balanced) graphs and traveling salesman-submodular (respectively, balanced and totally balanced) graphs. Granot, Hamers, Kuipers and Maschler (2011) allow for edges not to be assigned to players. They investigate the class of graphs for which the associated Chinese postman game is balanced and the players on a road always pay exactly the cost of the road at each core point, independently of the location of the post office and the travelling costs.

In the literature, there is a broad stream of papers on relations between properties of games arising from an OR setting, and the structures of underlying graphs. On Chinese postman games, we further mention Albizuri and Hamers (2014), Platz and Hamers (2015), Granot and Granot (2012); on minimum coloring games, we refer to Deng, Ibaraki, Nagamochi and Zang (2000), Okamoto (2003), and Hamers, Miguel and Norde (2014); and on Steiner-traveling salesman games, we mention Herer and Penn (1995).

In this paper, we drop the one-to-one relation between the set of customers (from now on players) and the set of edges. The one-to-one relation between players and some relevant feature of an underlying operational-research problem is common to the literature of OR-games (cf. Borm, Hamers and Hendrickx

2001). Lately, this one-to-one relation has been dropped as in Calleja, Estévez-Fernández, Borm and Hamers (2006) and Estévez-Fernández, Borm, Calleja and Hamers (2008) in the context of sequencing games, Miquel, van Velzen, Hamers and Norde (2006) in the context of fixed tree games, and Miquel, van Velzen, Hamers and Norde (2009) in the context of assignment games.

In our cprp games model, a player can be present in more than one edge, but no edge can have more than one player. Moreover, we also allow for an edge to have no players, in which case we call it a public edge. As an example of this generalization, we can consider a courier company that needs to deliver packages to several companies and private customers. A company may have several locations where the delivery can take place and, afterwards, the company will internally redistribute the packages to the correct destination. We show, contrary to the results in Granot et al. (1999), that cprp games with underlying undirected weak cyclic graphs do not need to be submodular. Moreover, we show that submodularity and totally balancedness are not equivalent concepts any longer. Furthermore, the location of the post office in the graph plays a relevant role in total balancedness and submodularity of the associated cprp games. This shortcoming leads us to focus on conditions on the assignment of players to edges that ensure submodularity of the associated cprp game. Given an undirected rooted graph G , an assignment of players to edges is submodular if the associated cprp game is always submodular, independently of the travel costs. Here, we restrict our analysis to weak cycles since Chinese postman games in the framework of Granot et al. (1999) are a special case of cprp games. We give sufficient conditions for an assignment of players to edges to be submodular for trees. Moreover, using these conditions, we also provide sufficient conditions for an assignment of players to edges to be submodular for cycles and for weak cycles. Unfortunately, these requirements are not necessary as well. We give insightful examples that outline the complexity of finding necessary conditions for submodular assignments of players to edges.

The structure of the paper is as follows. Section 2 gives the preliminary definitions and results used in the remaining of the paper. Section 3 introduces Chinese postman games with repeated players and motivates the analysis of submodular assignment of players to edges. Section 4 is devoted to submodular assignments of players to edges for trees, while Section 5 follows suit for cycles, and Section 6 for weak cycles. Section 7 concludes.

2 Preliminaries

A **cooperative (cost) game** in characteristic function form is a pair (N, c) where N is a finite set of players and $c : 2^N \rightarrow \mathbb{R}$ satisfies $c(\emptyset) = 0$. In general, $c(S)$ represents the value of coalition S , that is, the joint costs that are incurred by the coalition when its members decide to cooperate. A cooperative game

is a tool used to solve an allocation problem: how to share the total costs arising from the cooperation of all players. One highly accepted solution concept within game theory is the core of a game. The **core** of a game (N, c) , $\mathbf{Core}(c)$, is the set of efficient allocations of $c(N)$ to which no coalition can reasonably object (c.f. Gillies 1953). Formally,¹

$$\mathbf{Core}(c) = \{x \in \mathbb{R}^N \mid x(N) = c(N), x(S) \leq c(S) \text{ for all } S \subset N\}.$$

A game (N, c) is **balanced** (see Bondareva 1963, Shapley 1967) if, and only if, it has a nonempty core. A game (N, c) is **totally balanced** if for each coalition $S \subset N$, the subgame (S, c_S) is balanced, where c_S is the restriction of c to S . A game (N, c) is **monotonic** if for every $S, T \subset N$ with $S \subset T$, $c(S) \leq c(T)$. A game (N, c) is **subadditive** if for every $S, T \subset N$ with $S \cap T = \emptyset$, $c(S \cup T) \leq c(S) + c(T)$. An important class of (totally) balanced games is the class of submodular (or concave) games. A game (N, c) is **submodular** (or **concave**) if for every $i \in N$ and every $S \subset T \subset N \setminus \{i\}$, $c(S \cup \{i\}) - c(S) \geq c(T \cup \{i\}) - c(T)$.

An (undirected) **graph** \mathbf{G} is a pair (V, E) in which V is the finite set of nodes and $E \subset \{\{v, w\} \subset V : v \neq w\}$ is the set of edges. In general, given a graph \mathbf{G} , $\mathbf{V}(\mathbf{G})$ and $\mathbf{E}(\mathbf{G})$ denote the set of nodes and the set of edges of \mathbf{G} , respectively. For $v \in V$ and $e \in E$, we say that v and e are **incident** if $v \in e$, and $\mathbf{edges}(v)$ denotes the set of edges that are incident with v .

A **walk**, ω , from node v to w is an alternating sequence of nodes and edges, $w_0, e_1, w_1, \dots, w_{q-1}, e_q, w_q$, where $w_0 = v$, $w_q = w$, and $e_l = \{w_{l-1}, w_l\}$ for every $l \in \{1, \dots, q\}$. For notational convenience, we sometimes describe a walk ω as a sequence of nodes $w_0, w_1, \dots, w_{q-1}, w_q$, with $\{w_{l-1}, w_l\} \in E$ for every $l \in \{1, \dots, q\}$. $\mathbf{G}(\omega)$ denotes the associated graph with set of nodes $\{w_0, w_1, \dots, w_q\}$ and set of edges $\{e_1, \dots, e_q\}$, which we denote by $\mathbf{V}(\omega)$ and $\mathbf{E}(\omega)$, respectively. $\mathbf{Walks}(v, w)$ denotes the set of walks from v to w . A **closed walk** is a walk with $w_0 = w_q$.

A **path**, π , from node v to w is a walk in which no node is repeated. $\mathbf{G}(\pi)$ denotes the corresponding graph with set of nodes $V(\pi)$ and set of edges $E(\pi)$. $\mathbf{Paths}(v, w)$ denotes the set of paths from v to w . It is well known that from any walk between two distinct nodes, we can always construct a path between those nodes.

A **cycle**, C , is a walk $w_0, e_1, w_1, \dots, w_{q-1}, e_q, w_q$, with $w_0 = w_q$ and where w_1, \dots, w_q are distinct. With minor abuse of language, we refer to a cycle C as the graph with nodes $V(C)$ and edges $E(C)$. In a cycle, every node has exactly two incident edges and every pair of distinct nodes can be connected by exactly two paths. A **rooted cycle** C with root $v_0 \in V(C)$ is a cycle where node v_0 is singled out.

¹Here and further, for any vector $x \in \mathbb{R}^N$, we denote $x(S) := \sum_{i \in S} x_i$.

Given a graph G , a subset V' of $V(G)$ is called **connected** if for every $v, w \in V'$, there is a path from v to w using only nodes of V' . A subset V' of $V(G)$ is called **maximally connected** or **component** if V' is connected and for any $w \in V(G) \setminus V'$, $V' \cup \{w\}$ is not connected.

A graph $G = (V, E)$ is a **forest** if it has no cycles and a **tree** if it is a connected forest. In a tree, two distinct nodes are connected by exactly one path. Given $u, v \in V$, we denote by $\pi(u, v)$ the unique path connecting both nodes. A **rooted tree** $G = (V, E)$ with root $v_0 \in V$ is a tree where node $v_0 \in V$ is singled out.

A graph $G = (V, E)$ is a **weak cycle** if it is a connected graph and each edge belongs to at most one cycle. A **cycle** belonging to a weak cycle is called a **leaf** if it has at most one node with more than two incident edges (C_2 is a leaf cycle in Figure 1). A rooted weak cycle $G = (V, E)$ with root $v_0 \in V$ is a weak cycle where node $v_0 \in V$ is singled out. The rooted weak cycle G can be decomposed into a union of rooted trees and rooted cycles which set of edges are pairwise disjoint. Formally, given G a weak cycle, let C_1, \dots, C_r be the cycles contained in G and let V_1, \dots, V_s be the components of $\left(V(G), E(G) \setminus \left(\bigcup_{l=1}^r E(C_l)\right)\right)$ that are not singletons, that is, $|V_l| \geq 2$ for $l \in \{1, \dots, s\}$. For $l \in \{1, \dots, s\}$, let T_l be the tree with node set V_l and edge set $E_l = \{\{v, w\} \in E \mid v, w \in V_l\}$ and let v_l^* be the node that is always visited in any walk from v_0 to any node in V_l . Then, T_l is a rooted tree with root v_l^* , $l \in \{1, \dots, s\}$. Moreover, for any $l \in \{1, \dots, r\}$, let $w_l^* \in V(C_l)$ be the node that is always visited in any walk from v_0 to any node in C_l . Then, C_l is a rooted cycle with root w_l^* , $l \in \{1, \dots, r\}$. Therefore, G can be seen as a union of rooted cycles (C_l, w_l^*) , $l = 1, \dots, r$, and rooted trees (T_l, v_l^*) , $l = 1, \dots, s$, with $E(C_1), \dots, E(C_r), E(T_1), \dots, E(T_s)$ pairwise disjoint (see Figure 1).

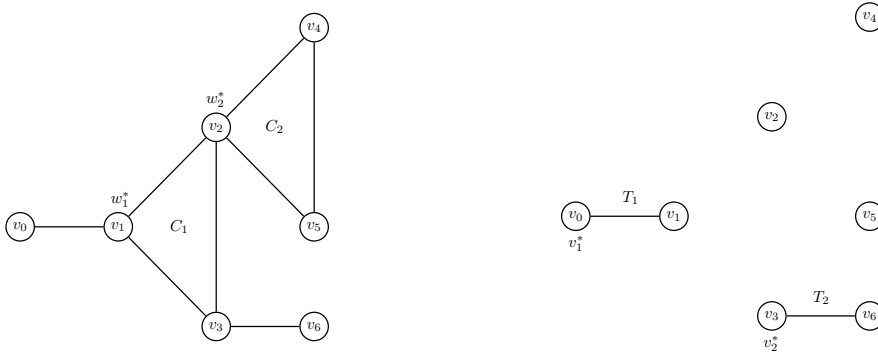

Figure 1: Decomposition of a weak cycle into trees and cycles.

Let G be a weak cycle and let ω be a closed walk in G . The associated graph $G(\omega)$ is also a weak cycle. Moreover, we can always construct another closed walk $\bar{\omega}$ that have the same nodes and edges than ω and such that each edge belonging to a cycle of $G(\omega)$ appears exactly once in $\bar{\omega}$, while all other edges appear exactly twice. In this case, $G(\omega) = G(\bar{\omega})$. We say that $\bar{\omega}$ is an **essential walk**. Conversely,

associated with each connected subset $V' \subset V(G)$, we can always construct a closed essential walk ω satisfying: (i) $V(\omega) = V'$ and (ii) $E(\omega) = \{\{u, v\} \in E(G) \mid u, v \in V'\}$. We say that a closed essential walk ω satisfying these two conditions is a **walk associated with V'** . Obviously, there might be more than one walk associated with V' .

3 Chinese postman games with repeated players

In this section, we introduce Chinese postman games with repeated players. For this, we first need to formally introduce Chinese postman problems with repeated players.

In a Chinese postman problem with repeated players (cprp problem), a postman, starting from the post office, has to visit a (finite) set N of customers (or players) in a city and return to the post office at the end. The map of the city is represented by a graph G and the players are located in the edges of the graph. Here, a player may be located in more than one edge, but each edge may only be assigned to one player. Associated with each edge there is a non-negative cost. The cprp problem consists of finding a walk that visits all players at minimal cost. Formally, a cprp problem is a 5-tuple (G, v_0, t, N, p) where G is the graph representing the map of the city; v_0 is the node where the post office is located; $t : E(G) \rightarrow \mathbb{R}_+$ is the cost function on the edges of G ; N is the set of players; and $p : E(G) \rightarrow N \cup \{0\}$ is a function assigning edges to players, where $p(e) = i$, $i \in N$, means that edge $e \in E(G)$ is occupied by player i , and $p(e) = 0$ means that edge $e \in E(G)$ is not occupied by a player. If $p(e) = 0$ for $e \in E(G)$, we say that **edge e is public**.

Next to the optimization problem, we consider an allocation problem: how to divide the minimal cost of visiting all players among them. To solve this problem, we consider Chinese postman games with repeated players (cprp games). Before the formal introduction, we give some new concepts. Let $S \subset N$ be a coalition of players and assume that the postman only has to visit the players in S . We define an **S -walk** as a closed walk that visits all players in S at least once. An S -walk starts and finishes in v_0 , may visit the same edge more than once, and may visit edges not assigned to members of S . We denote the set of all S -walks by $\mathbf{W}(S)$.

The **cprp game**, (N, c) , corresponding to the cprp problem (G, v_0, t, N, p) is defined by

$$c(S) = \min \left\{ \sum_{l=1}^q t(e_l) \mid v_0, e_1, w_1, \dots, w_{q-1}, e_q, v_0 \in \mathbf{W}(S) \right\}$$

for every $S \subset N$. It is readily verified that (N, c) is monotonic and subadditive.

Given a cprp problem (G, v_0, t, N, p) and a player $i \in S$, some edges assigned to i may be always visited after visiting other edges assigned to i as well. In such case, these edges are redundant for the definition of the game and can be considered public. Formally, given a cprp problem (G, v_0, t, N, p) , we

associate the **reduced cprp problem**, $(\mathbf{G}, \mathbf{v}_0, t, N, \mathbf{p}^r)$, where \mathbf{p}^r is defined as follows: $\mathbf{p}^r(e) = i$ with $i \in N$ if $p(e) = i$ and there exist at least one walk $\omega \in W(\{i\})$ such that $e \in E(\omega)$ and $p(\bar{e}) \neq i$ for every $\bar{e} \in E(\omega) \setminus \{e\}$; otherwise, $\mathbf{p}^r(e) = 0$. We denote by $M(\mathbf{G}, \mathbf{v}_0, t, N, \mathbf{p}^r)$ the set of players that own multiple edges according to \mathbf{p}^r . Formally,

$$M(\mathbf{G}, \mathbf{v}_0, t, N, \mathbf{p}^r) = \{i \in N \mid |(p^r)^{-1}(i)| > 1\}.$$

If no confusion is to be expected, we denote M instead of $M(\mathbf{G}, \mathbf{v}_0, t, N, \mathbf{p}^r)$. We denote by (N, \mathbf{c}^r) the cprp game associated to $(\mathbf{G}, \mathbf{v}_0, t, N, \mathbf{p}^r)$. Figure 2 illustrates how to obtain a reduced cprp problem. There, and in the remaining, the numbers in boldface represent the players assigned to the edge (or 0 if the edge is public) and the non-boldface numbers represent the cost of the edges.

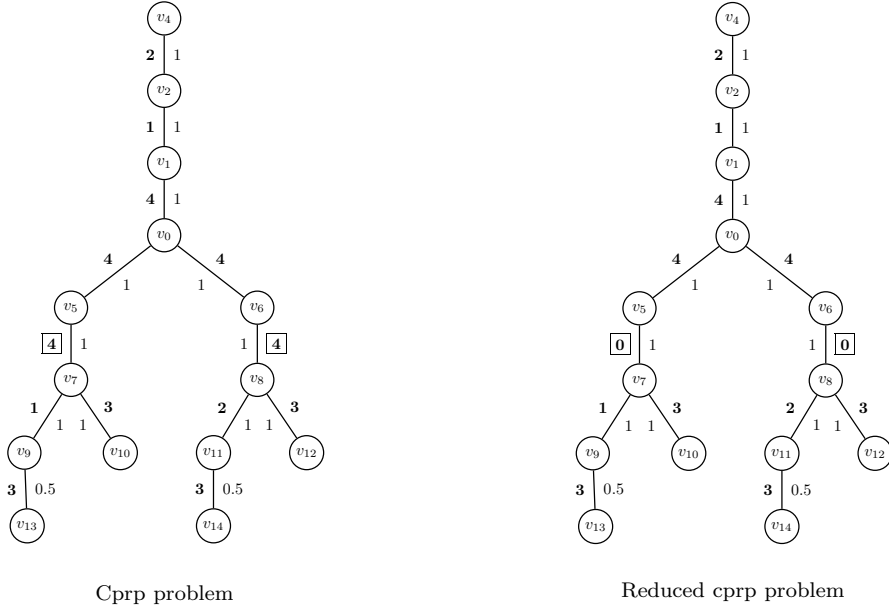

Figure 2: Cprp problem and reduced cprp problem.

The following result is straightforward and, therefore, the proof is omitted.

Theorem 3.1. Let (G, v_0, t, N, p) be a cprp problem, let $(\mathbf{G}, \mathbf{v}_0, t, N, \mathbf{p}^r)$ be the reduced cprp problem, and let (N, c) and (N, c^r) be the corresponding cprp games. Then, $c = c^r$.

If p is a one-to-one relation with N , that is, $p^{-1}(0) = \emptyset$ and $|p^{-1}(i)| = 1$ for every $i \in N$, then, both the cprp problem and corresponding game coincide with the Chinese postman problem and the corresponding game introduced in Hamers et al. (1999). Granot et al. (1999) study Chinese postman-balanced, Chinese postman-totally balanced, and Chinese postman-submodular (cp-balanced, cp-totally balanced, and cp-submodular) graphs for Chinese postman games. A graph is cp-submodular if the

corresponding Chinese postman game is always submodular, independently of the edge costs and the post office location. Similarly, they define cp-balanced and cp-totally balanced graphs. In Granot et al. (1999), each edge belongs to one player and each player has exactly one edge. They obtain the following result.

Theorem 3.2. (Granot et al. 1999) Let G be a connected undirected graph. Then, the three following statements are equivalent:

- (i) G is weakly cyclic,
- (ii) G is cp-submodular,
- (iii) G is cp-totally balanced.

The following examples illustrate that Theorem 3.2 does not hold if the one-to-one relation between the set of edges and the set of players is violated. First, we give an example of a cprp game associated to a cprp problem with a weak cycle that is not balanced.

Example 3.1. Let (G, v_0, t, N, p) be the cprp problem described in Figure 3. Here, $p^r = p$.

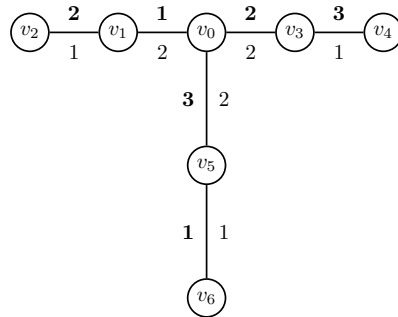

Figure 3: Cprp problem in Example 3.1.

The associated cprp game has values:

$$c(\{1\}) = c(\{2\}) = c(\{3\}) = 4, c(\{1, 2\}) = c(\{1, 3\}) = c(\{2, 3\}) = 6 \text{ and } c(N) = 10.$$

The game is not balanced. To see this, suppose that $x \in \text{Core}(c)$. Then, $x_1 + x_2 + x_3 = 10$ and $x_1 + x_2 \leq 6$, $x_1 + x_3 \leq 6$, $x_2 + x_3 \leq 6$. Adding all inequalities together, we have

$$20 = 2(x_1 + x_2 + x_3) = x_1 + x_2 + x_1 + x_3 + x_2 + x_3 \leq 6 + 6 + 6 = 18$$

which establishes a contradiction to our premise $x \in \text{Core}(c)$. Thus, (N, c) is not balanced and, therefore, neither totally balanced, nor submodular. However, if the post office is situated at any other node, then, the associated cprp-game is submodular. \diamond

Second, we give an example of a cprp game associated to a cprp problem with a weak cycle that is totally balanced, but not submodular.

Example 3.2. Let (G, v_0, t, N, p) be the cprp problem described in Figure 4. Here, $p^r = p$.

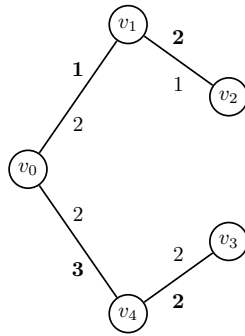

Figure 4: Cprp problem in Example 3.2.

The associated cprp game has values:

$$c(\{1\}) = c(\{3\}) = 4, c(\{2\}) = c(\{1, 2\}) = 6, c(\{1, 3\}) = c(\{2, 3\}) = 8 \text{ and } c(N) = 10.$$

The game is totally balanced since it has a nonempty core (for example, $(4, 2, 4) \in \text{Core}(c)$) and all sub-games have a nonempty core, too. However, it is not submodular. Take $i = 1$, $S = \{2\}$, and $T = \{2, 3\}$. Then, $c(\{1, 2\}) - c(\{2\}) = 0 \not\geq 2 = c(\{1, 2, 3\}) - c(\{2, 3\})$. In fact, the game is not submodular since player 2 is visited on his edge $\{v_1, v_2\}$ for coalitions $\{2\}$, $\{1, 2\}$, and $\{1, 2, 3\}$, while he is visited on his edge $\{v_3, v_4\}$ for coalition $\{2, 3\}$. However, if the post office is situated at any other node, the associated cprp-game is submodular. \diamond

As illustrated in the examples above, as soon as we drop the one-to-one relation between the set of edges of the underlying graph and the set of players, Theorem 3.2 does not hold and the position of the post office plays a relevant role. In the remaining, we study sufficient conditions on the assignment of players to edges in order to ensure submodularity of the corresponding cprp game, independently of the cost function at hand. One of the admissibility conditions will be that all assignment functions that are a one to one function between the set of edges and the set of players are admissible. Due to this, it follows that the only graphs that combined with an admissible assignment function provide submodular cprp games are weakly cyclic (as seen in Granot et al. 1999).

Let G be a rooted graph with root v_0 and let N be a finite set. The **assignment function** $p : E(G) \rightarrow N \cup \{0\}$ is **submodular** if for every cost function $t : E(G) \rightarrow \mathbb{R}_+$, the cprp game (N, c)

associated to the cprp problem (G, v_0, t, N, p) is submodular.

4 Submodular assignment functions for trees

In this section, we analyse restrictions on the assignments of players in trees to obtain submodularity of cprp games. Let (G, v_0, t, N, p) be a cprp problem where G is a tree (tree-cprp problem). Given a coalition $S \subset N$ and a walk $\omega \in W(S)$, it is readily seen that the associated graph, $G(\omega)$, is a tree. Since we are interested in walks that visit all players in S at minimum cost, we can restrict our analysis to essential closed walks. Then, we can write the value of coalition $S \subset N$ as

$$c(S) = \min_{\omega \in W(S)} 2 \sum_{e \in E(\omega)} t(e).$$

As illustrated in Examples 3.1 and 3.2, we encounter problems with submodularity of tree-cprp games when a player can be visited in different edges depending on the coalition at hand. Next, we define pairwise tree-admissibility with respect to the post office of an assignment function, which will be a sufficient condition to obtain submodularity of tree-cprp games. First, we need to introduce some preliminary notation.

Let G be a rooted tree with root v_0 and let $v \in V(G)$. We denote by $\mathbf{Pr}(v)$ the set of predecessors of v , that is, the set of nodes that precede v in the path from v_0 to v . Formally,

$$\mathbf{Pr}(v) = \{u \in V \mid u \neq v, u \in V(\pi(v_0, v))\}.$$

We denote $\overline{\mathbf{Pr}}(v) = \mathbf{Pr}(v) \cup \{v\}$. This induces a partial order \leq_G defined by

$$v \leq_G w \text{ if } v \in \overline{\mathbf{Pr}}(w).$$

Besides, we write $v <_G w$ if $v \leq_G w$ and $v \neq w$. It follows that $\mathbf{Pr}(v_0) = \emptyset$ and $v_0 \in \mathbf{Pr}(v)$ for every $v \in V(G) \setminus \{v_0\}$. We denote by $\mathbf{Fol}(v)$ the set of nodes that have v as a predecessor. Formally,

$$\mathbf{Fol}(v) = \{u \in V \mid v <_G u\}.$$

We denote $\overline{\mathbf{Fol}}(v) = \mathbf{Fol}(v) \cup \{v\}$. Certainly, $\mathbf{Fol}(v)$ may be empty. Let $v \in V$ and $e = \{v_1, v_2\} \in E$ be such that $v_1 <_G v_2$, $v_1, v_2 \in \overline{\mathbf{Fol}}(v)$. Then, there exists a unique $\tilde{e} = \{v, \tilde{v}\} \in \text{edges}(v)$, $v <_G \tilde{v}$, such that $\tilde{e} \in E(\pi(v, v_2))$. Clearly, \tilde{e} may be e . We define **the rooted tree $G(v, e) = (V(v, e), E(v, e))$ with root v** by

$$V(v, e) = \{v\} \cup \overline{\mathbf{Fol}}(\tilde{v}) \text{ and } E(v, e) = \{\{u, w\} \in E \mid u, w \in V(v, e)\}.$$

Surely, $G(v, e) = G(v, \tilde{e})$.

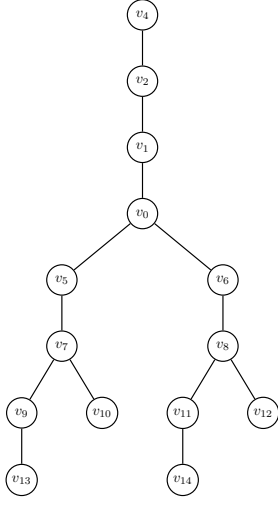

$$\begin{aligned} \text{Pr}(v_7) &= \{v_0, v_5\} \\ \text{Fol}(v_7) &= \{v_9, v_{10}, v_{13}\} \\ G(v_7, \{v_9, v_{13}\}) &= G(v_7, \{v_7, v_9\}) \\ V(v_7, \{v_9, v_{13}\}) &= \{v_7, v_9, v_{13}\} \\ E(v_7, \{v_9, v_{13}\}) &= \{\{v_7, v_9\}, \{v_9, v_{13}\}\} \end{aligned}$$

Figure 5: Notions of predecessors and followers in a rooted tree.

Let (G, v_0, t, N, p) be a tree-cprp problem. We say that p is **pairwise tree-admissible with respect to v_0** if for every $v, w \in V(G)$, every $e \in \text{edges}(v)$ with $e \subset \overline{\text{Fol}}(v)$, and every $f \in \text{edges}(w)$ with $f \subset \overline{\text{Fol}}(w)$ such that $E(v, e) \cap E(w, f) = \emptyset$, one of the following conditions is satisfied:

- (i) $\min\{|p^r(E(v, e))|, |p^r(E(w, f))|\} \leq 1$,
- (ii) $p^r(E(v, e)) = p^r(E(w, f))$ with $|p^r(E(v, e))| = 2$,
- (iii) $p^r(E(v, e)) \cap p^r(E(w, f)) = \emptyset$.

Clearly, if p is a one-to-one relation with N , condition (iii) is always satisfied.

Before stating the main result of this section, we need to provide a preliminary result.

Lemma 4.1. Let (G, v_0, t, N, p) be a tree-cprp problem with p pairwise tree-admissible with respect to v_0 . Then, for every $S \subset N$, there exists an optimal S -walk $\hat{\omega} \in W(S)$ such that $|\{e \in E(\hat{\omega}) \mid p^r(e) = i\}| = 1$ for every $i \in S$.

Proof: Let $\omega \in W(S)$ be an optimal S -walk and assume that there exist $e_1, e_2 \in E(\omega)$ such that $p^r(e_1) = p^r(e_2) = i$, $i \in S$. We may assume that every edge in ω appears exactly twice. We construct optimal walks $\omega^1, \omega^2, \dots, \omega^m \in W(S)$ such that ω^m is in the conditions of the lemma.

Let $i_1 \in S$ with $|\{e \in E(\omega) \mid p^r(e) = i_1\}| = k_1 \geq 2$. We construct another optimal walk ω^1 such that $|\{e \in E(\omega^1) \mid p^r(e) = i_1\}| = 1$. Let $e_1, \dots, e_{k_1} \in E(\omega)$ be the edges in ω that belong to i_1 according to p^r and let $e_l = \{u_l, v_l\}$ with $u_l <_G v_l$. Assume, without loss of generality, that $e_1 \notin \bigcup_{l=2}^{k_1} E(u_l, e_l)$.

Define $V^1 = V(\omega) \setminus (\bigcup_{l=2}^{k_1} (V(u_l, e_l) \setminus \{u_l\}))$ and let ω^1 be a closed walk associated with V^1 that starts

and finishes in v_0 . We now consider two cases: (i) $|p^r(E(u_l, e_l))| = 1$ for every $l \in \{2, \dots, k_1\}$ and (ii) $|p^r(E(u_l, e_l))| > 1$ for $l \in \{1, \dots, k'\}$ with $1 < k' \leq k_1$.

(i) $|p^r(E(u_l, e_l))| = 1$ for every $l \in \{2, \dots, k_1\}$.

In this case, it readily follows that ω^1 is feasible for S since i_1 is still visited in edge e_1 and we only delete either public edges, or edges that are owned by i_1 . Moreover, by optimality of ω and construction of ω^1 , we have that ω^1 is also optimal.

(ii) $|p^r(E(u_l, e_l))| > 1$ for $l \in \{1, \dots, k'\}$ with $1 < k' \leq k_1$.

In this case, $|p^r(E(u_l, e_l))| = 1$ for $l \in \{k'+1, \dots, k_1\}$. By condition (ii) of pairwise tree-admissibility with respect to v_0 , it follows that $p^r(E(u_l, e_l)) = \{i_1, j\}$ with $j \in N$ for every $l \in \{1, \dots, k'\}$. If $j \in p^r(E(u_l, e_l)) \cap p^r(E(\omega))$ for some $l \in \{1, \dots, k'\}$, assume, without loss of generality, that $j \in p^r(E(u_1, e_1)) \cap p^r(E(\omega))$. Then, it readily follows that ω^1 is feasible for S since i_1 and j are still visited in edge e_1 and in $E(u_1, e_1) \cap E(\omega^1)$, respectively, and we only delete either public edges, or edges that are owned by i_1 or by j . Moreover, by optimality of ω and construction of ω^1 , we have that ω^1 is also optimal.

If $|\{e \in E(\omega^1) \mid p^r(e) = i\}| = 1$ for every $i \in S$, then, we are done. Otherwise, we repeat the above procedure for $i_2 \in S$ with $|\{e \in E(\omega) \mid p^r(e) = i_2\}| > 1$. In this way, we construct ω^2 such that $\omega^2 \in W(S)$, ω^2 optimal, and $|\{e \in E(\omega) \mid p^r(e) = i_l\}| = 1$, $l = 1, 2$. Successively, we construct ω^m satisfying $\omega^m \in W(S)$, ω^m optimal, and $|\{e \in E(\omega) \mid p^r(e) = i\}| = 1$ for every $i \in S$. Clearly, the procedure ends in a finite number of steps since S is finite. \square

The following example illustrates the necessity of pairwise tree-admissibility in Lemma 4.1.

Example 4.1. Let (G, v_0, t, N, p) be the cprp problem described in Figure 6. Here, $p^r = p$.

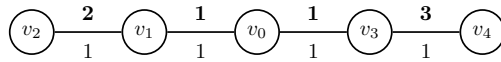

Figure 6: Cprp problem in Example 4.1.

The assignment function is not pairwise tree-admissible since $p^r(v_0, \{v_0, v_1\}) = \{1, 2\}$ and $p^r(v_0, \{v_0, v_3\}) = \{1, 3\}$ and, therefore, neither of the three conditions is satisfied. Moreover, the graph associated to any optimal N -walk is G and, therefore, 1 is always visited twice (otherwise either player 2, or player 3 would not be visited). \diamond

Theorem 4.2. Let G be a rooted tree with root v_0 and let N be a finite set. If $p : E(G) \rightarrow N \cup \{0\}$ is pairwise tree-admissible with respect to v_0 , then, p is submodular.

Proof: Let $t : E(G) \rightarrow \mathbb{R}_+$ be a cost function. We show that the cprp game (N, c) associated to the cprp problem (G, v_0, t, N, p) is submodular. Namely, we show that for every $i \in N$ and every $S \subset T \subset N \setminus \{i\}$,

$$c(S \cup \{i\}) + c(T) \geq c(T \cup \{i\}) + c(S). \quad (4.1)$$

Notice that if either $c(S \cup \{i\}) = c(T \cup \{i\})$, or $c(T) = c(T \cup \{i\})$, then, the above inequality is satisfied by monotonicity of (N, c) . Therefore, we only need to verify the inequality when both $c(S \cup \{i\}) < c(T \cup \{i\})$ and $c(T) < c(T \cup \{i\})$. We distinguish between two cases: $i \in N \setminus M$ and $i \in M$.

Case 1: $i \in N \setminus M$.

Before showing this case, we need to fix some notation. Let $i \in N \setminus M$ and $R \subset N$ (notice that i may, or may not, belong to R). We denote by $e(i) = \{u(i), v(i)\}$, with $u(i) <_G v(i)$, the unique edge assigned to i according to p^r . We denote by $\hat{\omega}_R \in \mathbf{W}(R)$ an optimal walk for R under the conditions of Lemma 4.1, that is, every edge in $\hat{\omega}_R$ appears exactly twice and $|\{e \in E(\hat{\omega}) \mid p^r(e) = j\}| = 1$ for every $j \in R$. For $j \in R \setminus \{i\}$, we denote $e(j, R) = \{u(j, R), v(j, R)\}$, with $u(j, R) <_G v(j, R)$, the unique edge in $\hat{\omega}_R$ assigned to j by p^r . We denote by $v(i, j, R)$ the “last common node” in the paths $\pi(v_0, u(i))$ and $\pi(v_0, u(j, R))$. Formally, $v(i, j, R) \in V(\pi(v_0, u(i))) \cap V(\pi(v_0, u(j, R)))$ with $v \leq_G v(i, j, R)$ for every $v \in V(\pi(v_0, u(i))) \cap V(\pi(v_0, u(j, R)))$. Clearly, $v(i, j, R)$ is well defined since $v_0 \in V(\pi(v_0, u(i))) \cap V(\pi(v_0, u(j, R)))$. Moreover, $v(i, j, R) \in V(\hat{\omega}_R)$. Finally, we denote $v(i, R)$ the “last node” among all $v(i, j, R)$. Formally, $v(i, R) \in \{v(i, j, R) \mid j \in R \setminus \{i\}\}$ with $v(i, j, R) \leq_G v(i, R)$ for every $j \in R \setminus \{i\}$.

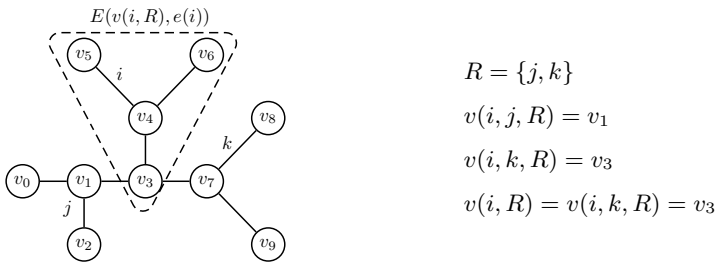

Figure 7: Notions of special nodes in the proof of Theorem 4.2.

Fix $\hat{\omega}_{S \cup \{i\}}$ and $\hat{\omega}_T$. We construct feasible walks $\omega_S \in \mathbf{W}(S)$ and $\omega_{T \cup \{i\}} \in \mathbf{W}(T \cup \{i\})$ such that

$$\sum_{e \in E(\hat{\omega}_{S \cup \{i\}})} t(e) + \sum_{e \in E(\hat{\omega}_T)} t(e) = \sum_{e \in E(\omega_{T \cup \{i\}})} t(e) + \sum_{e \in E(\omega_S)} t(e),$$

in which case,

$$c(S \cup \{i\}) + c(T) = 2 \left(\sum_{e \in E(\hat{\omega}_{S \cup \{i\}})} t(e) + \sum_{e \in E(\hat{\omega}_T)} t(e) \right) = 2 \left(\sum_{e \in E(\omega_{T \cup \{i\}})} t(e) + \sum_{e \in E(\omega_S)} t(e) \right) \geq c(T \cup \{i\}) + c(S)$$

where the inequality follows by feasibility of both ω_S and $\omega_{T \cup \{i\}}$. To do this, we distinguish between two situations: (1.1) $v(i, S \cup \{i\}) \leq_G v(i, T)$, (1.2) $v(i, T) <_G v(i, S \cup \{i\})$.

(1.1) $v(i, S \cup \{i\}) \leq_G v(i, T)$.

Clearly, $v(i, T) \in V(\hat{\omega}_{S \cup \{i\}})$ since $v(i, T) \in \pi(v_0, v(i))$. Besides, $E(v(i, T), e(i)) \cap E(\hat{\omega}_T) = \emptyset$ by definition of $v(i, T)$. By definition of $v(i, S \cup \{i\})$, the edges in $E(v(i, T), e(i)) \cap E(\hat{\omega}_{S \cup \{i\}})$ are only used to visit i . Then, $p^r \left(E(v(i, T), e(i)) \cap E(\hat{\omega}_{S \cup \{i\}}) \right) \cap (S \cup \{i\}) = \{i\}$. Define

$$V^S = \{v(i, T)\} \cup (V(\hat{\omega}_{S \cup \{i\}}) \setminus V(v(i, T), e(i))) \quad \text{and} \quad V^{T \cup \{i\}} = V(\hat{\omega}_T) \cup V(v(i, T), e(i))$$

and let ω_R be a closed walk associated with V^R that starts and finishes in v_0 , and visits each edge exactly twice, for $R \in \{S, T \cup \{i\}\}$. It follows that $\omega_S \in W(S)$, $\omega_{T \cup \{i\}} \in W(T \cup \{i\})$, and

$$\sum_{e \in E(\hat{\omega}_{S \cup \{i\}})} t(e) + \sum_{e \in E(\hat{\omega}_T)} t(e) = \sum_{e \in E(\omega_{T \cup \{i\}})} t(e) + \sum_{e \in E(\omega_S)} t(e).$$

(1.2) $v(i, T) <_G v(i, S \cup \{i\})$.

By definition of $v(i, S \cup \{i\})$, the edges in $E(v(i, T), e(i)) \cap E(\hat{\omega}_{S \cup \{i\}})$ are also used to visit players in S . Let U be the set of players in S that are visited in $E(v(i, T), e(i))$ according to $\hat{\omega}_{S \cup \{i\}}$, that is, $U = p^r \left(E(v(i, T), e(i)) \cap E(\hat{\omega}_{S \cup \{i\}}) \right) \cap S \neq \emptyset$. Clearly, $U \subset S \subset T$ and $v(i, j, T) \leq_G v(i, T)$ for every $j \in U$ by definition of $v(i, T)$. Recall that $\{e \in E(\hat{\omega}_R) \mid p^r(e) = j\} = \{e(j, R)\}$ for every $j \in R$ by selection of $\hat{\omega}_R$, with $R \in \{S \cup \{i\}, T\}$. Notice that $|p^r \left(E(v(i, T), e(i)) \right)| \geq 2$ since $i \in p^r \left(E(v(i, T), e(i)) \right)$ and $U \neq \emptyset$. Since $i \in N \setminus M$, we have that $p^r \left(E(v(i, j, T), e(j, T)) \right) = \{j\}$ for every $j \in U$ by pairwise tree-admissibility of p with respect to v_0 . Therefore, the edges in $E(v(i, j, T), e(j, T)) \cap E(\hat{\omega}_T)$ are only used to visit j for every $j \in U$. Define

$$V^S = \left(\{v(i, T)\} \cup (V(\hat{\omega}_{S \cup \{i\}}) \setminus V(v(i, T), e(i))) \right) \cup \left(\bigcup_{j \in U} (V(v(i, j, T), e(j, T)) \cap V(\hat{\omega}_T)) \right)$$

and

$$V^{T \cup \{i\}} = \left(\{v(i, j, T) \mid j \in U\} \cup (V(\hat{\omega}_T) \setminus \bigcup_{j \in U} V(v(i, j, T), e(j, T))) \right) \cup \left(V(v(i, T), e(i)) \cap V(\hat{\omega}_{S \cup \{i\}}) \right).$$

Let ω_R be a closed walk associated with V^R that starts and finishes in v_0 and visits each edge exactly twice, for $R \in \{S, T \cup \{i\}\}$. It follows that $\omega_S \in W(S)$, $\omega_{T \cup \{i\}} \in W(T \cup \{i\})$, and

$$\sum_{e \in E(\hat{\omega}_{S \cup \{i\}})} t(e) + \sum_{e \in E(\hat{\omega}_T)} t(e) = \sum_{e \in E(\omega_{T \cup \{i\}})} t(e) + \sum_{e \in E(\omega_S)} t(e).$$

Case 2: $i \in M$.

Fix $\hat{\omega}_{S \cup \{i\}}$ and $\hat{\omega}_T$. Let $e(i, S \cup \{i\})$ be the unique edge owned by i that is visited in $\hat{\omega}_{S \cup \{i\}}$. Consider the tree-cprp problem (G, v_0, t, N, \bar{p}) with \bar{p} defined as

$$\bar{p}(e) = \begin{cases} p(e) & \text{if } p(e) \neq i, \\ p(e)(= i) & \text{if } e = e(i, S \cup \{i\}), \\ 0 & \text{otherwise,} \end{cases}$$

and let (N, \bar{c}) be the corresponding tree-cprp game. By definition of \bar{p} , it follows that \bar{p} is pairwise tree-admissible with respect to v_0 , $i \in N \setminus M(G, v_0, t, N, \bar{p})$, $\bar{c}(S \cup \{i\}) = c(S \cup \{i\})$, $\bar{c}(T) = c(T)$, $\bar{c}(S) = c(S)$, and $\bar{c}(T \cup \{i\}) \geq c(T \cup \{i\})$. Then,

$$c(S \cup \{i\}) + c(T) = \bar{c}(S \cup \{i\}) + \bar{c}(T) \geq \bar{c}(S) + \bar{c}(T \cup \{i\}) \geq c(S) + c(T \cup \{i\})$$

where the first inequality is a direct consequence of Case 1 of this proof. \square

Pairwise tree-admissibility is a sufficient, but not necessary condition for submodularity of an assignment function for tree-cprp games. When considering a “linear city” with clients situated to the right and left of the post office as in Figure 8, the associated cprp game is always submodular, as shown in Theorem 4.3.

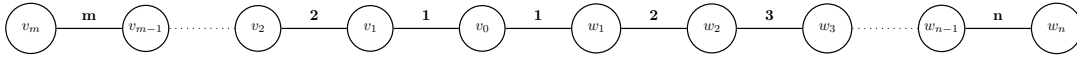

Figure 8: Cprp problem in Theorem 4.3.

Theorem 4.3. Let $N = \{1, \dots, n\}$ be a finite set of players. Let G be the rooted tree with root v_0 and p be the assignment function given in Figure 8. Then, p is submodular.

Proof: Let $n \geq m$. If $m = 1$, then, p is pairwise tree-admissible and, by Theorem 4.2, submodular. Therefore, we can assume $m \geq 2$. If $n = m = 2$, then, p is also pairwise tree-admissible and, by Theorem 4.2, submodular. Therefore, we can assume $m \geq 2$ and $n \geq 3$. Then, p is not pairwise tree-admissible since $|p^r(E(v_0, \{v_0, v_1\}))| = m \geq 2$, $|p^r(E(v_0, \{v_0, w_1\}))| = n \geq 3$, and $p^r(E(v_0, \{v_0, v_1\})) \cap p^r(E(v_0, \{v_0, w_1\})) \neq \emptyset$.

Let $i \in N$ and $R \subset N \setminus \{i\}$. Then,

$$c(R \cup \{i\}) = \begin{cases} c(\{1, \dots, i\}) & \text{if } R \cap \{i+1, \dots, n\} = \emptyset, \\ c(R) & \text{if } R \cap \{i+1, \dots, n\} \neq \emptyset. \end{cases}$$

Let $S \subset T \subset N \setminus \{i\}$. If $T \cap \{i+1, \dots, n\} = \emptyset$,

$$c(S \cup \{i\}) - c(S) = c(\{1, \dots, i\}) - c(S) \geq c(\{1, \dots, i\}) - c(T) = c(T \cup \{i\}) - c(T),$$

and if $T \cap \{i+1, \dots, n\} \neq \emptyset$,

$$c(S \cup \{i\}) - c(S) \geq 0 = c(T \cup \{i\}) - c(T),$$

where both inequalities follow by monotonicity of (N, c) . □

Theorem 4.3 also holds if players are allowed to own more than one edge at each side of the post office. However, the proof heavily relies on each player having the same “set of followers” at each side of the post office. This makes relevant that necessary and sufficient conditions for submodularity of assignment functions need to include the relative order of the players in the edges. Therefore, looking at the set of players in edges of the type $E(v, e)$ is not enough and aiming for necessary and sufficient conditions becomes too cumbersome. In any case, the relative order of players in the graph is not the only important element to find necessary and sufficient conditions for submodularity of assignment functions. We illustrate this in the following example.

Example 4.2. Let (G, v_0, t, N, p) be the cprp problem described in Figure 9. Here, $p^r = p$.

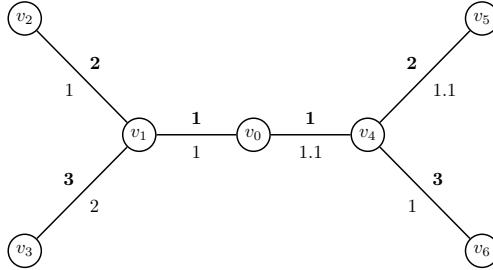

Figure 9: Cprp problem in Example 4.2.

The assignment function is not pairwise tree-admissible since $p^r(v_0, \{v_0, v_1\}) = \{1, 2, 3\}$ and $p^r(v_0, \{v_0, v_4\}) = \{1, 2, 3\}$ and, therefore, neither of the three conditions is satisfied. Here, the “set of followers” of player $i \in N$ are the same to the right and to the left of the post office. However, (N, c) is not concave since for $i = 2$, $S = \{1\}$, and $T = \{1, 3\}$, we have $c(\{1, 2\}) - c(\{1\}) = 4 - 2 \not\geq 6.4 - 4.2 = c(\{1, 2, 3\}) - c(\{1, 3\})$. ◇

5 Submodular assignment functions for cycles

In this section, we analyze cprp games where the underlying graph is a cycle (cycle-cprp games). We extend the concept of pairwise tree-admissibility to cycles. Just as in Section 4, our conditions on assignment functions are sufficient for submodularity on cycles. The following example points out a fundamental reason for a cycle-cprp game not to be submodular.

Example 5.1. Let (G, v_0, t, N, p) be the cprp problem described in Figure 10.



Figure 10: Cprp problem and reduced cprp problem in Example 5.2.

The edge $\{v_2, v_3\}$ is never visited by any coalition. Therefore, the associated cprp game coincides with the game in Example 3.2, which is not submodular. \diamond

Let (G, v_0, t, N, p) be a cprp problem where G is a cycle (cycle-cprp problem). By deleting an edge of G , we obtain a rooted tree (a line). Formally, given $e \in E(G)$, let $\mathbf{G}_{\{e\}}$ be the rooted tree, with root v_0 , defined by $V(\mathbf{G}_{\{e\}}) = V(G)$ and $E(\mathbf{G}_{\{e\}}) = E(G) \setminus \{e\}$. Let $\mathbf{p}_{\{e\}}$ and $\mathbf{t}_{\{e\}}$ denote the restriction of p and t to $E(\mathbf{G}_{\{e\}})$, respectively. Hence, $(\mathbf{G}_{\{e\}}, v_0, \mathbf{t}_{\{e\}}, N, \mathbf{p}_{\{e\}})$ is a tree-cprp problem.

We can now define admissibility with respect to the post office. Let (G, v_0, t, N, p) be a weak cycle-cprp problem. An assignment function p is **admissible with respect to v_0** if $p_{\{e\}}$ is pairwise tree-admissible with respect to v_0 for every $e \in E(G)$. For a rooted cycle (G, v_0) , $\mathbf{adm}(G, v_0)$ denotes the set of admissible assignment functions with respect to v_0 .

The assignment function p in Example 5.2 is, clearly, not admissible with respect to v_0 since for $e = \{v_2, v_3\}$, $p_{\{e\}}^r(E(v_0, \{v_0, v_1\})) = \{1, 2\}$ and $p_{\{e\}}^r(E(v_0, \{v_0, v_4\})) = \{2, 3\}$, which violates pairwise tree-admissibility with respect to v_0 for $\mathbf{G}_{\{e\}}$.

Theorem 5.1. Let G be a rooted cycle with root v_0 and let N be a finite set. If $p \in \mathbf{adm}(G, v_0)$, then, p is submodular.

Proof: Let $t : E(G) \rightarrow \mathbb{R}_+$ be a cost function. We show that the cycle-cprp game (N, c) associated to the cycle-cprp problem (G, v_0, N, t, p) is submodular. Namely, we show that for every $i \in N$ and every $S \subset T \subset N \setminus \{i\}$,

$$c(S \cup \{i\}) + c(T) \geq c(T \cup \{i\}) + c(S).$$

If either $c(S \cup \{i\}) = c(T \cup \{i\})$, or $c(T) = c(T \cup \{i\})$, then, the above inequality is satisfied by monotonicity of (N, c) . Therefore, we only need to verify the inequality when both $c(S \cup \{i\}) < c(T \cup \{i\})$ and $c(T) < c(T \cup \{i\})$.

Let $\hat{\omega}_{S \cup \{i\}} \in W(S \cup \{i\})$ be an optimal $S \cup \{i\}$ -walk and let $\hat{\omega}_T \in W(T)$ be an optimal T -walk. Since $c(S \cup \{i\}) < c(T \cup \{i\})$, we have

- (i) $E(\hat{\omega}_{S \cup \{i\}}) \neq E(G)$;
- (ii) each edge in $E(\hat{\omega}_{S \cup \{i\}})$ is visited exactly twice in the walk $\hat{\omega}_{S \cup \{i\}}$.

Moreover, $c(T) < c(T \cup \{i\})$ implies

- (iii) $E(\hat{\omega}_T) \neq E(G)$;
- (iv) each edge in $E(T)$ is visited exactly twice in the walk $\hat{\omega}_T$;
- (v) $e(i) \notin E(\hat{\omega}_T)$.

We distinguish between two cases: $i \in N \setminus M$ and $i \in M$.

Case 1: $i \in N \setminus M$.

Let $e(i)$ be the unique edge assigned to i according to p^r .

If $E(\hat{\omega}_{S \cup \{i\}}) \cup E(\hat{\omega}_T) = E(G)$,

$$c(S \cup \{i\}) + c(T) \geq 2 \sum_{e \in E(G)} t(e) \geq c(S) + c(T \cup \{i\})$$

where the last inequality follows because going all around the cycle is both an S -walk and a $T \cup \{i\}$ -walk.

If $E(\hat{\omega}_{S \cup \{i\}}) \cup E(\hat{\omega}_T) \neq E(G)$, then, we can fix $\bar{e} \in E(G) \setminus (E(\hat{\omega}_{S \cup \{i\}}) \cup E(\hat{\omega}_T))$. Let $\bar{N} = p_{\bar{e}}(E \setminus \{\bar{e}\})$. Then, $(G_{\bar{e}}, v_0, t_{\bar{e}}, \bar{N}, p_{\bar{e}})$ is a tree-cprp problem and $p_{\bar{e}}$ is pairwise tree-admissible. Let (\bar{N}, \bar{c}) be the associated tree-cprp game. Then, by selection of \bar{e} , $\bar{c}(S \cup \{i\}) = c(S \cup \{i\})$, $\bar{c}(T) = c(T)$, $\bar{c}(S) \geq c(S)$ and $\bar{c}(T \cup \{i\}) \geq c(T \cup \{i\})$. Therefore,

$$c(S \cup \{i\}) + c(T) = \bar{c}(S \cup \{i\}) + \bar{c}(T) \geq \bar{c}(S) + \bar{c}(T \cup \{i\}) \geq c(S) + c(T \cup \{i\})$$

where the first inequality follows by Theorem 4.2.

Case 2: $i \in M$.

Proof: Let $t : E(G) \rightarrow \mathbb{R}_+$ be a cost function. We show that the cycle-cprp game (N, c) associated to the cycle-cprp problem (G, v_0, t, N, p) is submodular. Namely, we show that for every $i \in N$ and every $S \subset T \subset N \setminus \{i\}$,

$$c(S \cup \{i\}) + c(T) \geq c(T \cup \{i\}) + c(S).$$

If either $c(S \cup \{i\}) = c(T \cup \{i\})$, or $c(T) = c(T \cup \{i\})$, then, the above inequality is satisfied by monotonicity of (N, c) . Therefore, we only need to verify the inequality when both $c(S \cup \{i\}) < c(T \cup \{i\})$ and $c(T) < c(T \cup \{i\})$. Let $\hat{\omega}_{S \cup \{i\}} \in \mathbf{W}(S \cup \{i\})$ be an optimal $S \cup \{i\}$ -walk and let $\hat{\omega}_T \in \mathbf{W}(T)$ be an optimal T -walk. Since $c(S \cup \{i\}) < c(T \cup \{i\})$, we have

- (i) $E(\hat{\omega}_{S \cup \{i\}}) \neq E(G)$;
- (ii) each edge in $E(\hat{\omega}_{S \cup \{i\}})$ is visited exactly twice in the walk $\hat{\omega}_{S \cup \{i\}}$.

Moreover, $c(T) < c(T \cup \{i\})$ implies

- (iii) $E(\hat{\omega}_T) \neq E(G)$;
- (iv) each edge in $E(T)$ is visited exactly twice in the walk $\hat{\omega}_T$;
- (v) $e(i) \notin E(\hat{\omega}_T)$.

If $E(\hat{\omega}_{S \cup \{i\}}) \cup E(\hat{\omega}_T) = E(G)$,

$$c(S \cup \{i\}) + c(T) \geq 2 \sum_{e \in E(G)} t(e) \geq c(S) + c(T \cup \{i\})$$

where the last inequality follows because going all around the cycle is both an S -walk and a $T \cup \{i\}$ -walk.

If $E(\hat{\omega}_{S \cup \{i\}}) \cup E(\hat{\omega}_T) \neq E(G)$, then, we can fix $\bar{e} \in E(G) \setminus (E(\hat{\omega}_{S \cup \{i\}}) \cup E(\hat{\omega}_T))$. Let $\bar{N} = p_{\bar{e}}(E \setminus \{\bar{e}\})$ and let (\bar{N}, \bar{c}) be the corresponding tree-cprp game. By definition of \bar{p} , it follows that $\bar{c}(S \cup \{i\}) = c(S \cup \{i\})$, $\bar{c}(T) = c(T)$, $\bar{c}(S) \geq c(S)$, and $\bar{c}(T \cup \{i\}) \geq c(T \cup \{i\})$. Then, $(G_{\bar{e}}, v_0, t_{\bar{e}}, \bar{N}, p_{\bar{e}}^r)$ is a “linear city” as in Theorem 4.3 and

$$c(S \cup \{i\}) - c(S) = \bar{c}(S \cup \{i\}) - \bar{c}(S) \geq \bar{c}(T \cup \{i\}) - \bar{c}(T) \geq c(T \cup \{i\}) - c(T)$$

where the first inequality follows by Theorem 4.3. □

6 Submodular assignment functions for weak cycles

In this section, we analyze cprp games where the underlying graph is a weak cycle (weak cycle-cprp games). We extend the concept of pairwise tree-admissibility to weak cycles. Just as in Section 4, our conditions on assignment functions are sufficient for submodularity on weak cycles. The following two examples point out fundamental reasons for a weak cycle-cprp game not to be submodular.

Example 6.1. Let (G, v_0, t, N, p) be the cprp problem described in Figure 12.

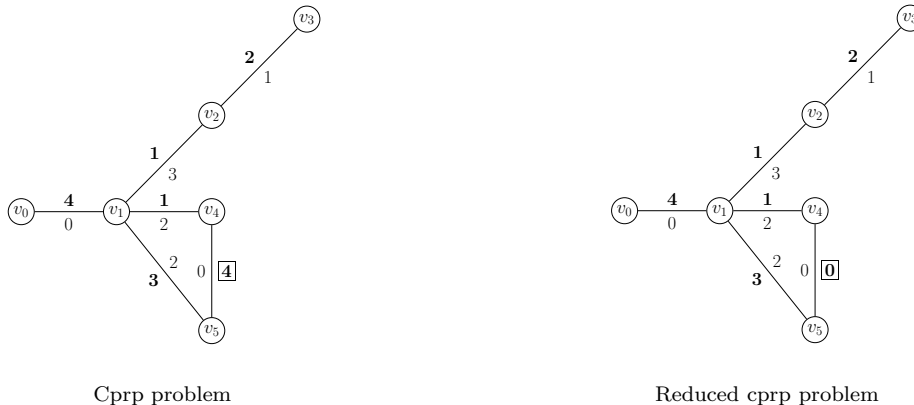

Figure 12: Cprp problem and reduced cprp problem in Example 6.1.

The associated cprp game is given in Table 1.

S	$\{1\}$	$\{2\}$	$\{3\}$	$\{4\}$	$\{1, 2\}$	$\{1, 3\}$	$\{1, 4\}$	$\{2, 3\}$	$\{2, 4\}$	$\{3, 4\}$	$\{1, 2, 3\}$	$\{1, 2, 4\}$	$\{1, 3, 4\}$	$\{2, 3, 4\}$	N
$c(S)$	4	8	4	0	8	4	4	12	8	4	12	8	4	12	12

Table 1: Coalitional values of the cprp game in Example 6.1.

This game has a nonempty core $((0, 8, 4, 0) \in \text{Core}(c))$, but is not submodular since for $i = 2$, $S = \{1\}$, and $T = \{1, 3\}$, $c(\{1, 2\}) - c(\{1\}) = 4 \not\geq 8 = c(\{1, 2, 3\}) - c(\{1, 3\})$. The game is not submodular since player 1 is visited on his edge $\{v_1, v_2\}$ for coalitions $\{1, 2\}$ and $\{1, 2, 3\}$, while he is visited on his edge $\{v_1, v_4\}$ for coalitions $\{1\}$, $\{1, 3\}$, and $\{1, 2, 3\}$. \diamond

To define admissibility of an assignment function in a cycle-cprp problem, we delete an edge of the cycle and check pairwise tree admissibility in the corresponding reduced tree-cprp problem. We see that this is not possible anymore for weak cycle-cprp problems in Example 6.1. The reason is that the cycle in Figure 12 has only two players according to the reduced cprp problem. If instead of only two players, the cycle had at least three, we could find an edge which deletion would violate pairwise tree admissibility in the corresponding reduced tree-cprp problem. A similar problem arises in Example 6.2

Example 6.2. Let (G, v_0, t, N, p) be the cprp problem described in Figure 13.

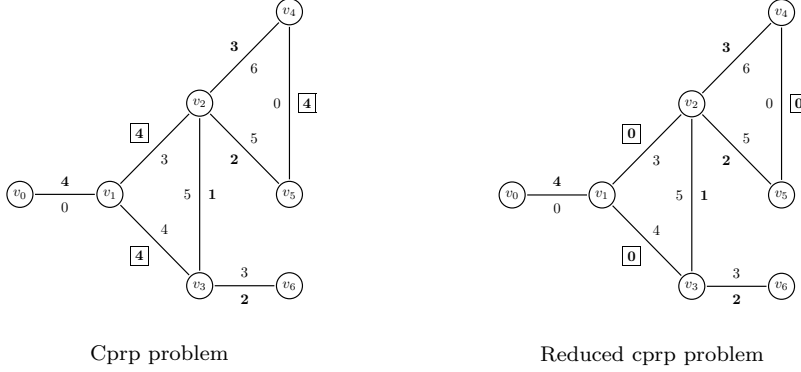

Figure 13: Cprp problem and reduced cprp problem in Example 6.2.

The associated cprp game is given in Table 2.

S	$\{1\}$	$\{2\}$	$\{3\}$	$\{4\}$	$\{1, 2\}$	$\{1, 3\}$	$\{1, 4\}$	$\{2, 3\}$	$\{2, 4\}$	$\{3, 4\}$	$\{1, 2, 3\}$	$\{1, 2, 4\}$	$\{1, 3, 4\}$	$\{2, 3, 4\}$	N
$c(S)$	12	14	17	0	18	23	12	17	14	17	23	18	23	17	23

Table 2: Coalitional values of the cprp game in Example 6.2.

This game has a nonempty core $((12, 0, 11, 0) \in \text{Core}(c))$, but is not submodular since for $i = 1$, $S = \{2\}$, and $T = \{2, 3\}$, $c(\{1, 2\}) - c(\{2\}) = 4 \not\geq 6 = c(\{1, 2, 3\}) - c(\{2, 3\})$. Notice that the game is not submodular since player 2 is visited on his edge $\{v_3, v_6\}$ for coalitions $\{2\}$ and $\{1, 2\}$, while he is visited on his edge $\{v_2, v_5\}$ for coalitions $\{2, 3\}$ and $\{1, 2, 3\}$. \diamond

To define admissibility of an assignment function for a weak cycle-cprp, we transform the weak cycle-cprp problem into a tree-cprp problem and check whether the corresponding assignment function satisfies pair wise admissibility. For this, we consider two types of operations: deleting an edge (as in Section 5) and splitting of a node. Let (G, v_0, t, N, p) be a weak cycle-cprp problem and let C be a cycle in G . Let $v \in V(C)$ and $e = \{v, w\} \in E(C) \cap \text{edges}(v)$. The **splitting of v through edge e** is done by duplicating v by \bar{v} and exchanging v by \bar{v} in e . Let $\bar{e} = \{\bar{v}, w\}$ and $\bar{E} = (E \setminus \{e\}) \cup \{\bar{e}\}$. We can adapt p and t to $p_{\{v,e\}}$ and $t_{\{v,e\}}$ by defining

$$p_{\{v,e\}}(\tilde{e}) = \begin{cases} p(\tilde{e}) & \text{if } \tilde{e} \in \bar{E} \setminus \{\bar{e}\}, \\ p(e) & \text{if } \tilde{e} = \bar{e} \end{cases} \quad \text{and} \quad t_{\{v,e\}}(\tilde{e}) = \begin{cases} t(\tilde{e}) & \text{if } \tilde{e} \in \bar{E} \setminus \{\bar{e}\}, \\ t(e) & \text{if } \tilde{e} = \bar{e} \end{cases}$$

(see Figure 14).

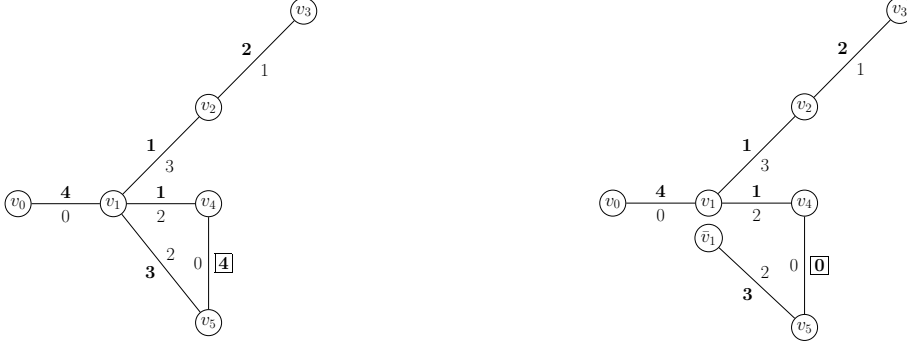

Figure 14: Splitting of v_1 through $\{v_1, v_5\}$ and adaptation of t and p .

We can now define admissibility with respect to the post office. First, we transform a weak cycle into several trees to which the assignment function is adapted. Second, we check pairwise tree-admissibility of the adapted assignment functions.

Let (G, v_0, t, N, p) be a weak cycle-cprp problem. Let $(T_1^*, v_1^*), \dots, (T_s^*, v_s^*)$ and $(C_1^*, w_1^*), \dots, (C_r^*, w_r^*)$ be the rooted trees and rooted cycles, respectively, in the decomposition of G . Assume that C_1, \dots, C_u are the leaves with $|p^r(E(C_1))| \geq 3, \dots, |p^r(E(C_u))| \geq 3$. For every $l \in \{1, \dots, u\}$, fix $e_l \in E(C_l)$ and for every $l \in \{u+1, \dots, r\}$, fix $v_l \in V(C_l)$ and $e_l \in E(C_l) \cap \text{edges}(v_l)$. Let $\mathbf{G}_{\{e_l\}_{l=1}^u, \{v_l, e_l\}_{l=u+1}^r}$ be the tree obtained by first deleting the edges e_1, \dots, e_u and, subsequently, splitting v_{u+1} through e_{u+1}, \dots, v_r through e_r . Let $\mathbf{p}_{\{e_l\}_{l=1}^u, \{v_l, e_l\}_{l=u+1}^r}$ and $\mathbf{t}_{\{e_l\}_{l=1}^u, \{v_l, e_l\}_{l=u+1}^r}$ denote the adaptation of p and t to $E(\mathbf{G}_{\{e_l\}_{l=1}^u, \{v_l, e_l\}_{l=u+1}^r})$, respectively. Hence, $(\mathbf{G}_{\{e_l\}_{l=1}^u, \{v_l, e_l\}_{l=u+1}^r}, v_0, \mathbf{t}_{\{e_l\}_{l=1}^u, \{v_l, e_l\}_{l=u+1}^r}, N, \mathbf{p}_{\{e_l\}_{l=1}^u, \{v_l, e_l\}_{l=u+1}^r})$ is a tree-cprp problem. The assignment function p is **admissible with respect to v_0** if $\mathbf{p}_{\{e_l\}_{l=1}^u, \{v_l, e_l\}_{l=u+1}^r}$ is pairwise tree-admissible with respect to v_0 for every selection $e_l \in E(C_l)$, $l \in \{1, \dots, u\}$, $v_l \in V(C_l)$ and $e_l \in E(C_l) \cap \text{edges}(v_l)$, $l \in \{u+1, \dots, r\}$. For a rooted weak cycle (G, v_0) , $\mathbf{adm}(G, v_0)$ denotes the set of admissible assignment functions with respect to v_0 .

Example 6.3. Let (G, v_0, t, N, p) be the cprp problem described in Example 6.2. Clearly, p is not admissible with respect to v_0 . Let C_1 be the cycle with nodes $\{v_1, v_2, v_3\}$ and C_2 be the cycle with nodes $\{v_2, v_4, v_5\}$. C_1 is no leaf and C_2 is a leaf with $|p^r(E(C_2))| = 2$. For C_1 , we fix v_2 and $\{v_2, v_3\} = e_1$, and for C_2 , we fix v_2 and $\{v_2, v_5\} = e_2$. The cprp problems $(\mathbf{G}_{\{v_2, e_1\}, \{v_2, e_2\}}, v_0, \mathbf{t}_{\{v_2, e_1\}, \{v_2, e_2\}}, N, \mathbf{p}_{\{v_2, e_1\}, \{v_2, e_2\}})$ and $(\mathbf{G}_{\{v_2, e_1\}, \{v_2, e_2\}}, v_0, \mathbf{t}_{\{v_2, e_1\}, \{v_2, e_2\}}, N, \mathbf{p}_{\{v_2, e_1\}, \{v_2, e_2\}}^r)$ are represented in Figure 15.

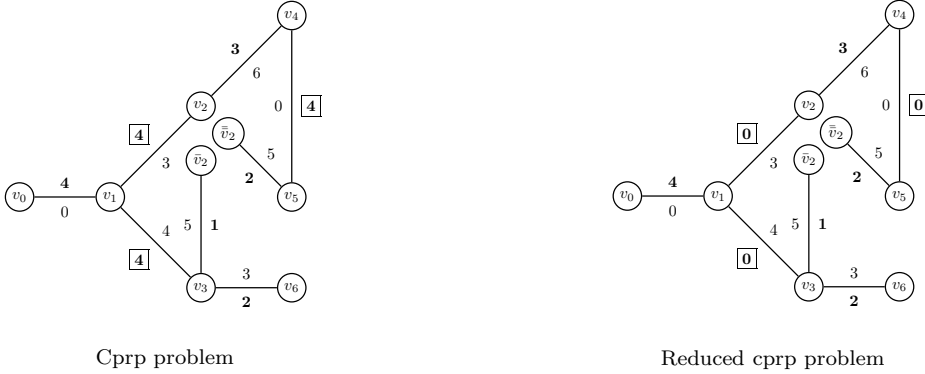

Figure 15: Cprp problem and reduced cprp problem in Example 6.3.

We have $p_{\{v_2, e_1\}, \{v_2, e_2\}}^r(E(v_1, e_1)) = \{2, 3\}$ and $p_{\{v_2, e_1\}, \{v_2, e_2\}}^r(E(v_1, e_1)) = \{1, 2\}$, which violates pairwise tree-admissibility with respect to v_0 . \diamond

Lemma 4.1 and Theorem 4.2 can be extended to weak cycle-cprp problems and admissible assignment functions with respect to the post office. Lemma 6.1 states that if p is an admissible assignment function with respect to the post office and a player i in a coalition S is not located at any cycle, then, we can find an optimal walk for S such that i is visited in exactly one edge. The proof follows the same lines as the proof of Lemma 4.1, but the technicalities increase considerably. For this reason, we omit the proof.

Lemma 6.1. Let (G, v_0, t, N, p) be a weak cycle-cprp problem with $p \in \text{adm}(G, v_0)$. Then, for every $S \subset N$, there exists an optimal walk $\hat{\omega} \in W(S)$ such that $|\{e \in E(\hat{\omega}) \mid p^r(e) = i\}| = 1$ for every $i \in S$ with $(p^r)^{-1}(i) \cap (\cup_{l=1}^r E(C_l)) = \emptyset$.

Next, we generalize Theorem 4.2 to weak cycle-cprp problems and admissible assignment functions with respect to the post office. Again, the proof of Theorem 6.2 follows the same lines as the proof of Theorem 4.2, but the technicalities increase enormously. For this reason, we omit the proof.

Theorem 6.2. Let G be a rooted weak cycle with root v_0 and let N be a finite set. If $p \in \text{adm}(G, v_0)$, then, p is submodular.

7 Concluding remarks

In this paper, we have introduced Chinese postman games with repeated players (cprp games) as a generalization of Chinese postman games. We have shown that, when the one-to-one relation between players and edges of the underlying graph is dropped, the equivalence between submodularity and totally

balancedness is lost. Moreover, it does not hold any longer that weak cycle graphs induce submodular cprp games. We define submodularity of assignments of players to edges. Given an undirected rooted graph G , an assignment of players to edges is submodular if the associated cprp game is always submodular, independently of the travel costs. We give sufficient conditions for an assignment of players to edges to be submodular for trees, cycles, and weak cycles. Unfortunately, finding also necessary conditions is highly challenging, since the relative order among the players seems to play a crucial role.

Chinese postman games with a tree as underlying graph are related to fixed tree games. Given a rooted weighted undirected tree, we can consider both an associated Chinese postman game and an associated fixed tree game. In a Chinese postman game, the players are located in the edges while in a fixed tree game, the players are located in the nodes. Reallocating a player in a node to the incident edge that is used in the path going from the root to the node, the value of a coalition in the Chinese postman game is twice the value of that same coalition in the fixed tree game. Therefore, both games share the same properties. Miquel et al. (2006) analyse fixed tree games with multilocalized players as a generalization of fixed tree games. They allow players to be located in more than one node except for players located in leaf nodes (nodes with no followers). Moreover, each leaf is occupied by a player, that is, it cannot be left empty. By imposing these restrictions, they ensure that the whole tree will be used by the grand coalition. They show that fixed tree games with multilocalized players are always submodular. Therefore, given a rooted tree, every assignment function that assigns every edge incident with a leaf to players owning only one edge are submodular. Reversely, if we drop the restriction in Miquel et al. (2006) about leaves being owned by players that do not have multiple locations, we can translate the condition on pairwise tree-admissibility with respect to the post office to fixed tree games with multilocalized players.

References

- Albizuri, J. and Hamers, H. (2014), ‘Graphs inducing totally balanced and submodular chinese postman games’, *Discrete Applied Mathematics* **172**, 98–103.
- Bondareva, O. N. (1963), ‘Some applications of linear programming methods to the theory of cooperative games’, *Problemy Kibernetiki* **10**, 119–139 (in Russian).
- Borm, P., Hamers, H. and Hendrickx, R. (2001), ‘Operations research games: A survey’, *Sociedad de Estadística e Investigación Operativa Top* **9**(2), 139–216.
- Calleja, P., Estévez-Fernández, A., Borm, P. and Hamers, H. (2006), ‘Job scheduling, cooperation and control’, *Operations Research Letters* **34**, 22–28.

- Deng, X., Ibaraki, T., Nagamochi, H. and Zang, W. (2000), ‘Totally balanced combinatorial optimization games’, *Mathematical Programming* **87**, 441–452.
- Edmonds, J. and Johnson, E. (1973), ‘Matching, euler tours and the chinese postman’, *Mathematical Programming* **5**, 88–124.
- Estévez-Fernández, A., Borm, P., Calleja, P. and Hamers, H. (2008), ‘Sequencing games with repeated players’, *Annals of Operations Research* **158**, 189–203.
- Gillies, D. (1953), Some theorems on n-person games, PhD thesis, Princeton, University Press Princeton, New Jersey.
- Granot, D. and Granot, F. (2012), ‘On graphs which can or cannot induce chinese postman games with a non-empty core’, *Discrete Applied Mathematics* **160**, 2054–2059.
- Granot, D. and Hamers, H. (2004), ‘On the equivalence between some local and global chinese postman and traveling salesman graphs’, *Discrete Applied Mathematics* **134**, 67–76.
- Granot, D., Hamers, H., Kuipers, J. and Maschler, M. B. (2011), ‘On chinese postman games where residents of each road pay the cost of their road’, *Games and Economic Behavior* **72**, 427–438.
- Granot, D., Hamers, H. and Tijs, S. (1999), ‘On some balanced, totally balanced and submodular delivery games’, *Mathematical Programming* **86**, 355–366.
- Hamers, H. (1997), ‘On the concavity of delivery games’, *European Journal of Operational Research* **99**, 445–458.
- Hamers, H., Borm, P., van de Leensel, R. and Tijs, S. (1999), ‘Cost allocation in the chinese postman problem’, *European Journal of Operational Research* **118**, 153–163.
- Hamers, H., Miguel, S. and Norde, H. (2014), ‘Monotonic stable solutions for minimum coloring games’, *Mathematical Programming* **145**, 509–529.
- Herer, Y. and Penn, M. (1995), ‘Characterization of naturally submodular graphs: A polynomial solvable class of the tsp’, *Proceedings of the American Mathematical Society* **123**, 613–619.
- Mei-Ko Kwan (1960), ‘Programming method using odd or even points’, *Acta Mathematica Sinica* **10**, 263–266. (In Chinese).
- Mei-Ko Kwan (1962), ‘Graphic programming using odd or even points’, *Chinese Mathematics* **1**, 273–277.

- Miquel, S., van Velzen, B., Hamers, H. and Norde, H. (2006), ‘Fixed tree games with multilocated players’, *Networks* **47**, 93–101.
- Miquel, S., van Velzen, B., Hamers, H. and Norde, H. (2009), ‘Assignment situations with multiple ownership and their games’, *International Game Theory Review* **11**, 1–13.
- Okamoto, Y. (2003), ‘Submodularity of some classes of the combinatorial optimization games’, *Mathematical Methods of Operations Research* **58**, 131–139.
- Platz, T. T. and Hamers, H. (2015), ‘On games arising from multi-depot chinese postman problems’, *Annals of Operations Research* **235**, 675–692.
- Shapley, L. S. (1967), ‘On balanced sets and cores’, *Naval Research Logistics Quarterly* **14**, 453–460.