

Tsai, Wen-hsien (Ed.)

**Book — Published Version**

## Modelling and analysis of sustainability related issues in new era

**Provided in Cooperation with:**

MDPI – Multidisciplinary Digital Publishing Institute, Basel

*Suggested Citation:* Tsai, Wen-hsien (Ed.) (2019) : Modelling and analysis of sustainability related issues in new era, ISBN 978-3-03921-025-1, MDPI, Basel, <https://doi.org/10.3390/books978-3-03921-025-1>

This Version is available at:

<https://hdl.handle.net/10419/203852>

**Standard-Nutzungsbedingungen:**

Die Dokumente auf EconStor dürfen zu eigenen wissenschaftlichen Zwecken und zum Privatgebrauch gespeichert und kopiert werden.

Sie dürfen die Dokumente nicht für öffentliche oder kommerzielle Zwecke vervielfältigen, öffentlich ausstellen, öffentlich zugänglich machen, vertreiben oder anderweitig nutzen.

Sofern die Verfasser die Dokumente unter Open-Content-Lizenzen (insbesondere CC-Lizenzen) zur Verfügung gestellt haben sollten, gelten abweichend von diesen Nutzungsbedingungen die in der dort genannten Lizenz gewährten Nutzungsrechte.

**Terms of use:**

*Documents in EconStor may be saved and copied for your personal and scholarly purposes.*

*You are not to copy documents for public or commercial purposes, to exhibit the documents publicly, to make them publicly available on the internet, or to distribute or otherwise use the documents in public.*

*If the documents have been made available under an Open Content Licence (especially Creative Commons Licences), you may exercise further usage rights as specified in the indicated licence.*



<https://creativecommons.org/licenses/by-nc-nd/4.0/>



*sustainability*

# Modelling and Analysis of Sustainability Related Issues in New Era

---

Edited by

Wen-Hsien Tsai

Printed Edition of the Special Issue Published in *Sustainability*

# **Modelling and Analysis of Sustainability Related Issues in New Era**





# Modelling and Analysis of Sustainability Related Issues in New Era

Special Issue Editor

**Wen-Hsien Tsai**

MDPI • Basel • Beijing • Wuhan • Barcelona • Belgrade



*Special Issue Editor*  
Wen-Hsien Tsai  
National Central University  
Taiwan

*Editorial Office*  
MDPI  
St. Alban-Anlage 66  
4052 Basel, Switzerland

This is a reprint of articles from the Special Issue published online in the open access journal *Sustainability* (ISSN 2071-1050) from 2018 to 2019 (available at: [https://www.mdpi.com/journal/sustainability/special-issues/New\\_Era](https://www.mdpi.com/journal/sustainability/special-issues/New_Era))

For citation purposes, cite each article independently as indicated on the article page online and as indicated below:

LastName, A.A.; LastName, B.B.; LastName, C.C. Article Title. <i>Journal Name</i> <b>Year</b> , Article Number, Page Range.
---

**ISBN 978-3-03921-024-4 (Pbk)**

**ISBN 978-3-03921-025-1 (PDF)**

© 2019 by the authors. Articles in this book are Open Access and distributed under the Creative Commons Attribution (CC BY) license, which allows users to download, copy and build upon published articles, as long as the author and publisher are properly credited, which ensures maximum dissemination and a wider impact of our publications.

The book as a whole is distributed by MDPI under the terms and conditions of the Creative Commons license CC BY-NC-ND.

# Contents

About the Special Issue Editor . . . . .	vii
Preface to "Modelling and Analysis of Sustainability Related Issues in New Era" . . . . .	ix
<b>Wen-Hsien Tsai</b>	
Modelling and Analysis of Sustainability Related Issues in New Era Reprinted from: <i>Sustainability</i> 2019, 11, 2134, doi:10.3390/su11072134 . . . . .	1
<b>Jindamas Sutthichaimethee and Kuskana Kubaha</b>	
Forecasting Energy-Related Carbon Dioxide Emissions in Thailand's Construction Sector by Enriching the LS-ARIMAXi-ECM Model Reprinted from: <i>Sustainability</i> 2018, 10, 3593, doi:10.3390/su10103593 . . . . .	6
<b>Jia Wang and Xijia Huang</b>	
The Optimal Carbon Reduction and Return Strategies under Carbon Tax Policy Reprinted from: <i>Sustainability</i> 2018, 10, 2471, doi:10.3390/su10072471 . . . . .	25
<b>Aydin Azizi</b>	
Computer-Based Analysis of the Stochastic Stability of Mechanical Structures Driven by White and Colored Noise Reprinted from: <i>Sustainability</i> 2018, 10, 3419, doi:10.3390/su10103419 . . . . .	39
<b>Wen-Hsien Tsai and Shang-Yu Lai</b>	
Green Production Planning and Control Model with ABC under Industry 4.0 for the Paper Industry Reprinted from: <i>Sustainability</i> 2018, 10, 2932, doi:10.3390/su10082932 . . . . .	58
<b>Wen-Hsien Tsai and Yin-Hwa Lu</b>	
A Framework of Production Planning and Control with Carbon Tax under Industry 4.0 Reprinted from: <i>Sustainability</i> 2018, 10, 3221, doi:10.3390/su10093221 . . . . .	87
<b>Wen-Hsien Tsai, Po-Yuan Chu and Hsiu-Li Lee</b>	
Green Activity-Based Costing Production Planning and Scenario Analysis for the Aluminum-Alloy Wheel Industry under Industry 4.0 Reprinted from: <i>Sustainability</i> 2019, 11, 756, doi:10.3390/su11030756 . . . . .	111
<b>Wen-Hsien Tsai, Shu-Hui Lan and Cheng-Tsu Huang</b>	
Activity-Based Standard Costing Product-Mix Decision in the Future Digital Era: Green Recycling Steel-Scrap Material for Steel Industry Reprinted from: <i>Sustainability</i> 2019, 11, 899, doi:10.3390/su11030899 . . . . .	131
<b>Wen-Hsien Tsai and Shi-Yin Jhong</b>	
Carbon Emissions Cost Analysis with Activity-Based Costing Reprinted from: <i>Sustainability</i> 2018, 10, 2872, doi:10.3390/su10082872 . . . . .	161
<b>Poorya Ghafoorpoor Yazdi, Aydin Azizi and Majid Hashemipour</b>	
An Empirical Investigation of the Relationship between Overall Equipment Efficiency (OEE) and Manufacturing Sustainability in Industry 4.0 with Time Study Approach Reprinted from: <i>Sustainability</i> 2018, 10, 3031, doi:10.3390/su10093031 . . . . .	187

**Julian Marius Müller**

Antecedents to Digital Platform Usage in Industry 4.0 by Established Manufacturers  
Reprinted from: *Sustainability* **2019**, *11*, 1121, doi:10.3390/su11041121 . . . . . **215**

**João Carlos de Oliveira Matias, Ricardo Santos and Antonio Abreu**

A Decision Support Approach to Provide Sustainable Solutions to the Consumer, by Using  
Electrical Appliances  
Reprinted from: *Sustainability* **2019**, *11*, 1143, doi:10.3390/su11041143 . . . . . **238**

**Shaio Yan Huang, An An Chiu, Po Chi Chao and Ni Wang**

The Application of Material Flow Cost Accounting in Waste Reduction  
Reprinted from: *Sustainability* **2019**, *11*, 1270, doi:10.3390/su11051270 . . . . . **254**

**Jau-Yang Liu**

An Internal Control System that Includes Corporate Social Responsibility for Social  
Sustainability in the New Era  
Reprinted from: *Sustainability* **2018**, *10*, 3382, doi:10.3390/su10103382 . . . . . **280**

**Jau Yang Liu**

An Integrative Conceptual Framework for Sustainable Successions in Family Businesses:  
The Case of Taiwan  
Reprinted from: *Sustainability* **2018**, *10*, 3656, doi:10.3390/su10103656 . . . . . **307**

**Kuang-Hua Hu, Sin-Jin Lin, Jau-Yang Liu, Fu-Hsiang Chen and Shih-Han Chen**

The Influences of CSR's Multi-Dimensional Characteristics on Firm Value Determination by a  
Fusion Approach  
Reprinted from: *Sustainability* **2018**, *10*, 3872, doi:10.3390/su10113872 . . . . . **328**

## About the Special Issue Editor

**Wen-Hsien Tsai** is a distinguished professor of accounting and information systems in the Department of Business Administration at National Central University, Taiwan. He has served as a Guest Editor of Special Issues in the journals *Sustainability* and *Energies* and an Associate Editor of the journal *Decision Support Systems*. He is also a certified consultant of SAP financial modules. He received his Ph.D. degree in industrial management from the National Taiwan Science and Technology University. He received his MBA degree and his M.Sc. degree in industrial engineering from the National Taiwan University and National Tsing-Hwa University, respectively. His research interests include Industry 4.0, carbon emissions, carbon tax, activity-based costing (ABC), ERP implementation and auditing, green production and optimization decision, and the International Financial Reporting Standards (IFRS). He has published several papers in high-quality international journals, such as *Sustainability*, *Energies*, *Decision Support Systems*, *European Journal of Operational Research*, *Omega*, *Transportation Science*, *Industrial Marketing Management*, *Journal of the Operational Research Society*, *Computers and Operations Research*, *Journal of Cleaner Production*, *International Journal of Production Economics*, *Computers and Industrial Engineering*, *International Journal of Production Research*, etc.





# Preface to “Modelling and Analysis of Sustainability Related Issues in New Era”

The purpose of this Special Issue is to investigate topics related to sustainability issues in the new era, especially in Industry 4.0 or other new manufacturing environments. Under Industry 4.0, there have been great changes with respect to production processes, production planning and control, quality assurance, internal control, cost determination, and other management issues. Moreover, it is expected that Industry 4.0 can create positive sustainability impacts along the whole value chain. There are three pillars of sustainability, including environmental sustainability, economic sustainability, and social sustainability. This Special Issue collects 15 sustainability-related papers from various industries that use various methods or models, such as mathematical programming, activity-based costing (ABC), material flow cost accounting, fuel consumption model, artificial intelligence (AI)-based fusion model, multi-attribute decision model (MADM), and so on. These papers are related to carbon emissions, carbon tax, Industry 4.0, economic sustainability, corporate social responsibility (CSR), etc. The research objects come from China, Taiwan, Thailand, Oman, Cyprus, Germany, Austria, and Portugal. Although the research presented in this Special Issue is not exhaustive, this Special Issue provides abundant, significant research related to environmental, economic, and social sustainability. Nevertheless, there still are many research topics that require our attention to solve problems of sustainability. Finally, I am grateful to MDPI for the invitation to act as the guest editor of this Special Issue, and I am indebted to the editorial office of *Sustainability* for the kind cooperation, patience, and committed engagement. I would like to thank the authors for submitting their excellent contributions to this Special Issue. Thanks are extended to the reviewers for evaluating the manuscripts and providing helpful suggestions. Sincere thanks also go to the editorial team of MDPI and *Sustainability* for providing the opportunity to publish this book and helping in all possible ways.

**Wen-Hsien Tsai**  
*Special Issue Editor*



Editorial

# Modelling and Analysis of Sustainability Related Issues in New Era

Wen-Hsien Tsai

Department of Business Administration, National Central University, Zhongli, Taoyuan 32001, Taiwan; whtsai@mgt.ncu.edu.tw; Tel.: +886-3-426-7247

Received: 28 March 2019; Accepted: 8 April 2019; Published: 10 April 2019

## 1. Introduction

Smart Manufacturing of Industry 4.0 was first proposed in Hanover Fair, Germany in 2011, which received great attentions from various nations [1]. Industry 4.0 utilizes new technologies such as 3D printing, robot, and autonomous vehicle, and links all the components in the manufacturing systems by using Cyber-Physical Systems (CPS) [2] and Internet of Things (IoT) [3,4]. Then, the system will real-time collect and monitor the activity data of all the components and give intelligent responses to various problems that may arise in the factory by the real-time analysis results of Cloud computing [5] and Big Data [6]. Finally, the manufacturing process can be fine-tuned, adjusted, or set up differently with the customer needs in order to achieve the goal of mass customization and customer satisfaction. Under Industry 4.0, Manufacturing Execution System (MES) [7,8] is an online information system and a feedback and control system for production. Under Industry 4.0, there are great changes on production processes, production planning and control, quality assurance, internal control, cost determination, and other management issues. However, it is expected that it can create positive sustainability impacts along the whole value chain.

The 2005 World Summit on Social Development identified sustainable development goals, such as economic development, social development, and environmental protection [9], which are called the three pillars of sustainability. Sustainable development goals are expected to provide the following potential benefits: (1) Environmental benefits: “*Environmental sustainability* is the ability of the environment to support a defined level of environmental quality and natural resource extraction rates indefinitely [10].” It can enhance and protect ecosystems, improve air and water quality, decrease waste streams to air and land, and preserve and restore natural and renewable resources; (2) Economic benefits: “*Economic sustainability* is the ability of an economy to support a defined level of economic production indefinitely.” [10]. It can decrease operating costs; create, expand, and shape markets for green products and services; improve occupant productivity and optimize life-cycle economic performance; (3) Social benefits: “*Social sustainability* is the ability of a social system, such as a country, family, or organization, to function at a defined level of social well-being and harmony indefinitely. Problems like war, endemic poverty, widespread injustice, and low education rates are symptoms that a system is socially unsustainable.” [10]. It can enhance occupant comfort and health; heighten aesthetic qualities; minimize strain on local infrastructure; and improve overall quality of life [11].

The purpose of this special issue is to explore the topics related to sustainability issues in the new era, especially in Industry 4.0 or other new manufacturing environments.

## 2. Summary of 15 Papers in this Special Issue

Table 1 shows the summary information of 15 papers in this special issue, including Research Topic, Paper/Author, Method/Model, Research Object, and Industry/Field. From this table, we can find that these papers are related to carbon emissions, carbon tax, Industry 4.0, economic sustainability, and Corporate Social Responsibility (CSR). These 15 papers also can be classified as the papers of environmental, economic, and social sustainability.

Table 1. Summary information of 15 papers in this special issue.

	Topic	Paper/Author	Method/Model	Research Object	Industry/Field
Carbon Emissions/Carbon Tax (Environmental Sustainability)	1. Carbon Emissions Forecasting	Suthichaimethee and Kubaha (Contribution 1)	LS-ARIMAX-ECM Model *	Thailand	Construction Industry
	2. Optimal Carbon Reduction and Return Strategies under Carbon Tax Policy	Wang and Huang (Contribution 2)	Utility Function; Mathematical Formulation	China	Not Specific
	3. Design for Fuel Consumption Reduction of Cars	Azizi (Contribution 3)	Fuel Consumption Model	Oman	Automobile Industry
Carbon Emissions/Carbon Tax/Industry 4.0 (Environmental & Economic Sustainability)	4. Green Production Decision Model under Industry 4.0	Tsai and Lai (Contribution 4)	Mathematical Programming; Activity-Based Costing	A Case Company in Taiwan	Paper Industry
	5. Green Production Decision Model under Industry 4.0	Tai and Lu (Contribution 5)	Mathematical Programming; Activity-Based Costing	A Case Company in Taiwan	Tire Industry
	6. Green Production Decision Model under Industry 4.0	Tsai, Chu, and Lee (Contribution 6)	Mathematical Programming; Activity-Based Costing	A Case Company in Taiwan	Aluminum-Alloy Wheel Industry
	7. Green Production Decision Model under Industry 4.0	Tsai, Lan, and Huang (Contribution 7)	Mathematical Programming; Activity-Based Costing	A Case Company in Taiwan	Steel Industry
	8. Carbon Emissions Cost Analysis	Tsai and Jhong (Contribution 8)	Mathematical Programming; Activity-Based Costing	A Case Company in Taiwan	Knitted Footwear Industry
Industry 4.0 (Economic Sustainability)	9. Relationship between Overall Equipment Efficiency (OEE) and Manufacturing Sustainability in Industry 4.0	Yazdi, Azizi, and Hashempour (Contribution 9)	Time Study Approach; Agent-based Algorithm	Northern Cyprus	Small and Medium Sized Enterprises (SMEs)
Economic Sustainability	10. Antecedents to Digital Platform Usage in Industry 4.0	Müller (Contribution 10)	In-depth expert Interviews	102 German and Austrian Industrial Enterprises	Various Industries
	11. Sustainable Solutions to Consumers for Electrical Appliances	de Oliveira Matias, Santos, and Abreu (Contribution 11)	Multi-Attribute Value Theory (MAVT); Multi-objective Optimization; Evolutionary Algorithm (EA)	Portugal	Electrical Appliances Industry
	12. Material Flow Cost Accounting for Waste Reduction	Huang, Chiu, Chao, and Wang (Contribution 12)	ISO 14051-based Material Flow Cost Accounting	A Case Company in Taiwan	A Flat-panel Parts Supplier
Corporate Social Responsibility (CSR) (Social Sustainability)	13. Corporate Social Responsibility for Social Sustainability	Liu (Contribution 13)	Multi-Attribute Decision Model (MADM); DEMATEL **; VIKOR ***	Taiwan	Not Specific
	14. Sustainable Successions in Family Business	Liu (Contribution 14)	Multi-attribute Decision Model (MADM)	A Case Company in Taiwan	Not Specific
	15. Influences of CSR on Firm Value	Hu, Liu, Liu, Chen, and Chen (Contribution 15)	Artificial Intelligence (AI)-based Fusion Model	Top 100 Companies in China	Not Specific

Note: \* LS-ARIMAX-ECM: Long and Short-term Auto-Regressive Integrated Moving Average with Exogenous Variables and the Error Correction Mechanism. \*\* DEMATEL: Decision Making Trial and Evaluation Laboratory. \*\*\* VIKOR: ViseKriterijumska Optimizacija I Kompromisno Resenje.

### **3. Review of the Special Issue**

#### *3.1. Carbon Emissions/Carbon Tax*

Sutthichaimethee and Kubaha (Contribution 1) use LS-ARIMAXi-ECM Model to forecast energy-related carbon emissions for the construction sector in Thailand. The results indicate that determining future national sustainable development policies requires an appropriate forecasting model, which is built upon causal and contextual factors according to relevant sectors, to serve as an important tool for future sustainable planning.

Wang and Huang (Contribution 2) present a proposal to determine an optimal carbon reduction level and online return strategies under carbon tax policy when a firm produces and sells its green products via an e-commerce platform. They find that if the residual value of the returned product is relatively small, the firm should not offer an online return service; and the platform should reduce its referral fee as the unit carbon tax increases.

Azizi (Contribution 3) applies a fuel consumption model to design an effective Proportional Integral Derivative (PID) controller for controlling the active suspension system of a car in order to eliminate the imposed vibration to the car from pavement and to reduce the fuel consumption and contributes to environment sustainability.

#### *3.2. Carbon Emissions/Carbon Tax/Industry 4.0*

Contributions 4-8 are a series of papers presenting the green production decision models in Paper (Contribution 4), Tire (Contribution 5), Aluminum-Alloy Wheel (Contribution 6), Steel (Contribution 7), and Knitted Footwear Industry (Contribution 8) by using the methods of Activity-Based Costing (ABC) and Mathematical Programming. In these papers, ABC is used to more accurately measure the costs of activities in the manufacturing processes. Mathematical Programming is used to find the optimal product-mix maximizing the company's profit under the various resource, sale, and production related constraints with the carbon tax costs. Among them, Contributions 4-7 explore the production decision models under Industry 4.0. Industry 4.0 can utilize, collect, and monitor the activity data of all the components in real-time by using various sensor systems, Cyber-Physical Systems (CPS), and Internet of Things (IoT), to give intelligent responses to various problems that may arise in the factory by the real-time analysis results of cloud computing and big data and to attain the various benefits of Industry 4.0 implementation. The parameters of the mathematical programming model will be updated periodically from the new big data set. For example, ABC cost parameters can be updated from more real data (see Contributions 5).

Besides this, Contribution 8 incorporates the concept of cap-and-trade in the production decision model and considers the carbon emission cost, including carbon tax and carbon right costs. This paper assumes that the company has the upper limit of carbon emission allocated from the government and that the company can buy the carbon emission right from the market if the company have the opportunity of the additional sales.

#### *3.3. Industry 4.0*

There are two papers related to Industry 4.0 with economic sustainability (Contributions 9 and 10). Yazdi et al. (Contribution 9) explore the relationship between Overall Equipment Efficiency (OEE) and manufacturing sustainability for small and medium sized enterprises (SMEs) under Industry 4.0 by using time study approach and agent-based algorithm. Müller (Contribution 10) investigates the potentials and challenges of digital platforms for the purpose of generating an understanding of the antecedents to the use of digital platforms under Industry 4.0 by established manufacturers. This research uses a qualitative empirical research approach of the in-depth expert interviews with managers of 102 German and Austrian industrial enterprises from several industrial sectors. Its results indicate that the main potentials of digital platforms are reducing transaction costs, combining strengths of enterprises, and realizing economies of scale as well as economies of scope.

### 3.4. Economic Sustainability

De Oliveira Matias et al. (Contribution 11) propose a decision support approach to provide a set of sustainable solutions from the market to the consumer for electrical appliances by adopting a Multi-Attribute Value Theory (MAVT), combined with an optimization technique based on Evolutionary Algorithms (EA).

Huang et al. (Contribution 12) utilize ISO14051-based material flow cost accounting as an analytical evaluation tool to conduct a case study on a flat-panel parts supplier to determine whether the efficient use of recycled glass could reduce company costs. The primary finding is that the film layer on recycled washed glass tends to be stripped during the production process, causing increased reprocessing costs and thus rendering the cost of renewable cleaning higher than that of reworking.

### 3.5. Corporate Social Responsibility (CSR)

There are three papers investigate the issues of Corporate Social Responsibility (CSR), which is belong to the issues of social sustainability. Liu (Contribution 13) uses Multi-attribute Decision Model (MADM), DEMATEL, and VIKOR to assess the impact of Corporate Social Responsibility for the implementation of internal control that includes Corporate Social Responsibility. The empirical results indicate that a social responsibility-oriented internal control system may be a better strategy than maintaining the original internal control objectives.

Liu (Contribution 14) utilizes Multi-Attribute Decision Model (MADM) to construct an analytical framework containing the key decision-making factors for family business succession. The results indicate that corporate characteristics, family capital, and niche inheritance are the most important without consideration of whether the continuation of the business after succession will be doomed to failure.

Hu et al. (Contribution 15) construct an artificial intelligence (AI)-based fusion model to examine the relationship between CSR's multidimensional characteristics and firm value by using the top 100 companies in China as a research sample. This research breaks down CSR into numerous dimensions used to examine each dimension's impact on firm value. The results indicate that "Environmental responsibility" is the most essential element on firm value determination since the Chinese government has placed much more emphasis on environmental protection in recent years.

## 4. Concluding Remarks

The purpose of this special issue is to investigate the topics related to sustainability issues in the new era, especially in Industry 4.0 or other new manufacturing environments. There are three pillars of sustainability, including environmental sustainability, economic sustainability, and social sustainability. This special issue collects 15 sustainability-related papers in various industries by using various methods or models. Although this special issue does not fully satisfy our needs, it still provides abundant related material for environmental, economic, and social sustainability. However, there still are many research topics waiting our efforts to study to solve the problems of sustainability.

### List of Contributions:

1. Sutthichaimethee, J.; Kubaha, K. Forecasting Energy-Related Carbon Dioxide Emissions in Thailand's Construction Sector by Enriching the LS-ARIMAXi-ECM Model.
2. Wang, J.; Huang, X. The Optimal Carbon Reduction and Return Strategies under Carbon Tax Policy.
3. Azizi, A. Computer-Based Analysis of the Stochastic Stability of Mechanical Structures Driven by White and Colored Noise.
4. Tsai, W.-H.; Lai, S.-Y. Green Production Planning and Control Model with ABC under Industry 4.0 for the Paper Industry.
5. Tsai, W.-H.; Lu, Y.-H. A Framework of Production Planning and Control with Carbon Tax under Industry 4.0.
6. Tsai, W.-H.; Chu, P.-Y.; Lee, H.-L. Green Activity-Based Costing Production Planning and Scenario Analysis for the Aluminum-Alloy Wheel Industry under Industry 4.0.



7. Tsai, W.-H.; Lan, S.-H.; Huang, C.-T. Activity-Based Standard Costing Product-Mix Decision in the Future Digital Era: Green Recycling Steel-Scrap Material for Steel Industry.
8. Tsai, W.-H.; Jhong, S.Y. Carbon Emissions Cost Analysis with Activity-Based Costing.
9. Yazdi, P.G.; Azizi, A.; Hashemipour, M. An Empirical Investigation of the Relationship between Overall Equipment Efficiency (OEE) and Manufacturing Sustainability in Industry 4.0 with Time Study Approach.
10. Müller, J.M. Antecedents to Digital Platform Usage in Industry 4.0 by Established Manufacturers.
11. de Oliveira Matias, J.C.; Santos, R.; Abreu, A. A Decision Support Approach to Provide Sustainable Solutions to the Consumer, by Using Electrical Appliances.
12. Huang, S.Y.; Chiu, A.A.; Chao, P.C.; Wang, N. The Application of Material Flow Cost Accounting in Waste Reduction.
13. Liu, J.Y. An Internal Control System that Includes Corporate Social Responsibility for Social Sustainability in the New Era.
14. Liu, J.Y. An Integrative Conceptual Framework for Sustainable Successions in Family Businesses: The Case of Taiwan.
15. Hu, K.-H.; Lin, S.-J.; Liu, J.-Y.; Chen, F.-H.; Chen, S.-H. The Influences of CSR's Multi-Dimensional Characteristics on Firm Value Determination by a Fusion Approach.

**Acknowledgments:** Wen-Hsien Tsai is grateful to the MDPI Publisher for the invitation to act as guest editor of this special issue and is indebted to the editorial office of “Sustainability” for the kind cooperation, patience and committed engagement. The guest editor would also like to thank the authors for submitting their excellent contributions to this special issue. Thanks are also extended to the reviewers for evaluating the manuscripts and providing helpful suggestions.

**Conflicts of Interest:** The authors declare no conflict of interest.

## References

1. Tupa, J.; Simota, J.; Steiner, F. Aspects of Risk Management Implementation for Industry 4.0. *Procedia Manuf.* **2017**, *11*, 1223–1230. [CrossRef]
2. Mosterman, P.J.; Zander, J. Industry 4.0 as a Cyber-Physical System Study. *Softw. Syst. Modeling* **2016**, *15*, 17–29. [CrossRef]
3. Wan, J.; Tang, S.; Shu, Z.; Li, D.; Wang, S.; Imran, M.; Vasilakos, A.V. Software-Defined Industrial Internet of Things in the Context of Industry 4.0. *IEEE Sens. J.* **2016**, *16*, 7373–7380. [CrossRef]
4. Dujin, A.; Blanchet, M.; Rinn, T.; Von Thaden, G.; De Thieulloy, G. *INDUSTRY 4.0 The New Industrial Revolution: How Europe Will Succeed*; Roland Berger Strategy Consultants: Munich, Germany, 2014.
5. Chauhan, S.S.; Pilli, E.S.; Joshi, R.C.; Singh, G.; Govil, M.C. Brokering in Interconnected Cloud Computing Environments: A Survey. *J. Parallel Distrib. Comput.* **2018**, in press. [CrossRef]
6. Johnson, S.L.; Gray, P.; Sarker, S. Revisiting IS Research Practice in the Era of Big Data. *Comput. Ind.* **2019**, *105*, 204–212. [CrossRef]
7. Kletti, J. (Ed.) *Manufacturing Execution System-MES*; Springer: Berlin/Heidelberg, Germany, 2007.
8. Helo, P.; Suorsa, M.; Hao, Y.; Anussornnitisarn, P. Toward a Cloud-based Manufacturing Execution System for Distributed Manufacturing. *Comput. Ind.* **2014**, *65*, 646–656. [CrossRef]
9. United Nations General Assembly. *World Summit Outcome, Resolutio/Adopted by the General Assembly*; A/RES/60/1; United Nations General Assembly: New York, NY, USA, 2005; Available online: <https://www.refworld.org/docid/44168a910.html> (accessed on 20 March 2019).
10. Thwink.org. The Three Pillars of Sustainability. Available online: <http://www.thwink.org/sustain/glossary/ThreePillarsOfSustainability.htm> (accessed on 20 March 2019).
11. Khoshnava, S.M.; Rostami, R.; Valipour, A.; Ismail, M.; Rahmat, A.R. Rank of Green Building Material Criteria Based on the Three Pillars of Sustainability Using the Hybrid Multi-Criteria Decision Making Method. *J. Clean. Prod.* **2018**, *173*, 82–99. [CrossRef]



© 2019 by the author. Licensee MDPI, Basel, Switzerland. This article is an open access article distributed under the terms and conditions of the Creative Commons Attribution (CC BY) license (<http://creativecommons.org/licenses/by/4.0/>).

Article

# Forecasting Energy-Related Carbon Dioxide Emissions in Thailand's Construction Sector by Enriching the LS-ARIMAXi-ECM Model

Jindamas Sutthichaimethee \* and Kuskana Kubaha

Division of Energy Management Technology, School of Energy, Environment and Materials, King Mongkut's University of Technology Thonburi, 126 Pracha Uthit Road, Bang Mod, Thung Khru, Bangkok 10140, Thailand; kuskana.kub@kmutt.ac.th

\* Correspondence: jsutthichaimethee@gmail.com; Tel.: +66-897-884-145

Received: 28 September 2018; Accepted: 8 October 2018; Published: 9 October 2018

**Abstract:** The Thailand Development Policy focuses on the simultaneous growth of the economy, society, and environment. Long-term goals have been set to improve economic and social well-being. At the same time, these aim to reduce the emission of CO<sub>2</sub> in the future, especially in the construction sector, which is deemed important in terms of national development and is a high generator of greenhouse gas. In order to achieve national sustainable development, policy formulation and planning is becoming necessary and requires a tool to undertake such a formulation. The tool is none other than the forecasting of CO<sub>2</sub> emissions in long-term energy consumption to produce a complete and accurate formulation. This research aims to study and forecast energy-related carbon dioxide emissions in Thailand's construction sector by applying a model incorporating the long- and short-term auto-regressive (AR), integrated (I), moving average (MA) with exogenous variables (Xi) and the error correction mechanism (LS-ARIMAXi-ECM) model. This model is established and attempts to fill the gaps left by the old models. In fact, the model is constructed based on factors that are causal and influential for changes in CO<sub>2</sub> emissions. Both independent variables and dependent variables must be stationary at the same level. In addition, the LS-ARIMAXi-ECM model deploys a co-integration analysis and error correction mechanism (ECM) in its modeling. The study's findings reveal that the LS-ARIMAXi (2, 1, 1, X<sub>t-1</sub>)-ECM model is a forecasting model with an appropriate time period ( $t - j$ ), as justified by the Q-test statistic and is not a spurious model. Therefore, it is used to forecast CO<sub>2</sub> emissions for the next 20 years (2019 to 2038). From the study, the results show that CO<sub>2</sub> emissions in the construction sector will increase by 37.88% or 61.09 Mt CO<sub>2</sub> Eq. in 2038. Also, the LS-ARIMAXi (2, 1, 1, X<sub>t-1</sub>)-ECM model has been evaluated regarding its performance, and it produces a mean absolute percentage error (MAPE) of 1.01% and root mean square error (RMSE) of 0.93% as compared to the old models. Overall, the results indicate that determining future national sustainable development policies requires an appropriate forecasting model, which is built upon causal and contextual factors according to relevant sectors, to serve as an important tool for future sustainable planning.

**Keywords:** long- and short-term; greenhouse gas; LS-ARIMAXi-ECM model; sustainability; economic growth; exogenous variables; CO<sub>2</sub> emissions

## 1. Introduction

Over the past few years and up to the present, Thailand has continuously made a firm effort to enhance its economic development. As a result, the national economy has continued to grow. The gross domestic product (GDP) has also grown at the same time [1]. In fact, Thailand has been seriously engaging with exports to gain for them a bigger global market share, particularly penetrating

the Chinese market. Also, the country is improving its tourism industry in order to generate more national revenue. Among other major actions taken, it has set a clear goal and objective to promote foreign investments in local industries by offering low tax rates and subsidies in some sectors in order to attract more investment and create better revenues for its people. According to the Office of the National Economic and Social Development Board (NESDB), Thailand's economy has increased its growth rate, resulting in the social growth rate increasing in a positive relationship with this. However, energy consumption has also been found to be climbing steadily [2,3]. The increments in energy consumption have influenced a continuing rise in greenhouse gas emissions. In particular, greenhouse gas emissions in the industrial sector are projected to grow at a very high rate of 27% with a growth rate of 4.3% (comparing 2017 to 2016). Besides this, the construction sector has been found to be continuously emitting CO<sub>2</sub> at a higher emission rate.

The CO<sub>2</sub> emission in the construction sector has a 1.6% growth rate (2017/2016) [4]. The construction sector consumes a large amount of energy, causing massive greenhouse gas emissions. In general, it releases 90% of the carbon dioxide and 75% of other greenhouse emissions out of all the greenhouse gases in Thailand [3,4].

Thailand pursues its policy objectives by setting a sustainable development plan as the key to achieve sustainability. This plan aims to develop three main areas simultaneously, ensuring economic, social and environmental growth. In such development, the environmental aspect is very important and challenging as it requires highly effective action plans and positive long-term effects.

Therefore, it is necessary to create an effective tool for its implementation and possible application in the future. Engaging in future long-term planning is always challenging and complex as it requires extreme care in all planning phases. If the planning fails, damage later is hard to resolve. Hence, the most important tool for such long-term policy planning is a long-term forecasting model. This paper has addressed research gaps by reviewing other relevant literature, and it is determined to fill them. Some special causal factors are carefully selected in the modelling process so as to make use of both the endogenous variables and exogenous variables, which are characterized as stationary at the same level. The paper conducts an analysis of the co-integration test at the same level, examines the appropriateness of the period of time ( $t - i$ ) with respect to both types of variables, and investigates the model falseness or model spuriousness. Additionally, it attempts to extend its forecasting capacity to a long-term prediction of 20 years (2019–2038), and it can be extended to apply in other sectors and various contexts. The structure of this paper is as follows:

1. We analyze stationary causal variables and those which are influential over the change of CO<sub>2</sub> emissions based on the augmented Dickey and Fuller theory [5]. We select stationary variables at the same level under the Sustainable Development Framework along with the use of data from 1990 to 2017.
2. We bring those stationary causal variables to the same level to analyze a long-term relationship through a concept from Johansen and Juselius [6].
3. We apply co-integrated variables at the same level to construct the the long- and short-term auto-regressive (AR), integrated (I), moving average (MA) with exogenous variables (Xi) and the error correction mechanism (LS-ARIMAXi-ECM) model comprising endogenous variables and exogeneous variables.
4. We examine the period of time ( $t - i$ ) for the appropriateness of the LS-ARIMAXi ( $p, d, q, X_{t-i}$ )-ECM model with Q-testing, as well as checking on spurious issues, consisting of heteroscedasticity, multicollinearity and autocorrelation.
5. We compare the efficiency of the LS-ARIMAXi ( $p, d, q, X_{t-i}$ )-ECM model with other existing models, including multiple regression, the grey model (GM (1,1)), grey model-autoregressive integrated moving average (GM-ARIMA) model, artificial neural network (ANN) model, autoregressive moving average (ARMA) model, and autoregressive integrated moving average (ARIMA) model, through the performance measurement of MAPE and RMSE.

6. We forecast future CO<sub>2</sub> emissions from the LS-ARIMAXi (p, d, q, X<sub>t-i</sub>)-ECM model during the years 2019 to 2038, totaling 20 years of forecasting. The flowchart of the LS-ARIMAXi (p, d, q, X<sub>t-i</sub>)-ECM model is shown in Figure 1.

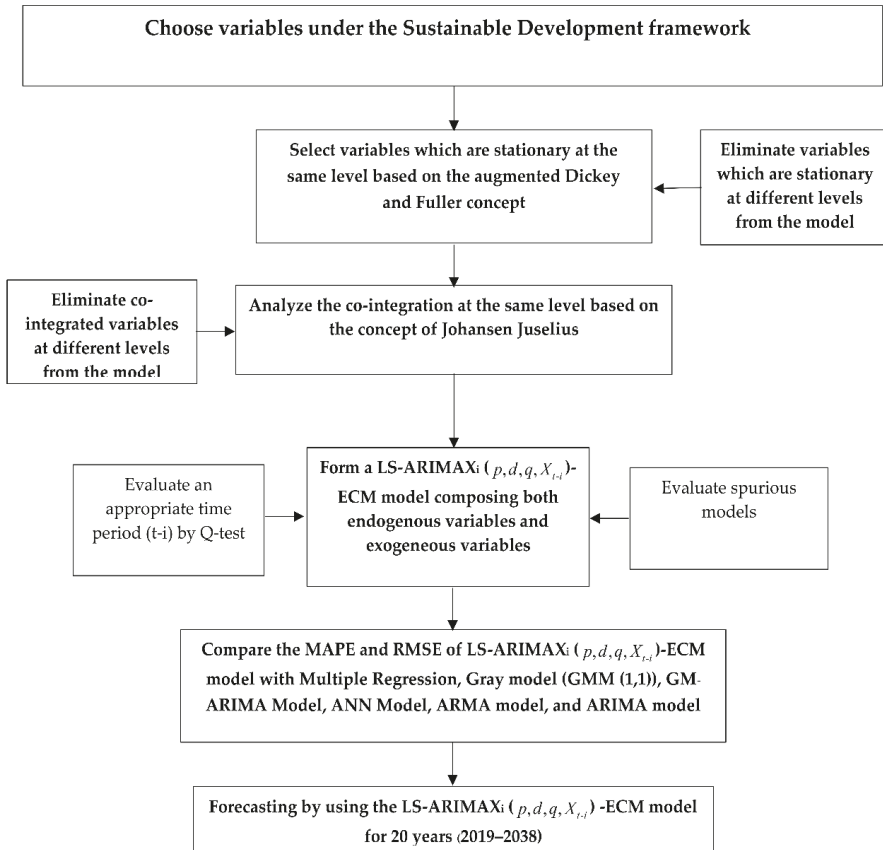

**Figure 1.** The flowchart of the long- and short-term auto-regressive (AR), integrated (I), moving average (MA) with exogenous variables (Xi) and error correction mechanism (LS-ARIMAXi (p, d, q, X<sub>t-i</sub>)-ECM) model.

The remainder of this paper is as follows: Section 2 is a literature review. Section 3 discusses the materials and methods. Section 4 shows the results. Section 5 summarizes the discussion. Section 6 is the conclusion.

## 2. Literature Review

Developing an energy-forecasting model is a key step to promoting a supportive national policy of an individual country. Having an efficient and effective model would allow all policy makers to make better decisions. Many studies have highlighted the significance of forecasting the energy consumption or other related areas. Ardakani and Ardehali [7] developed an optimized regression and ANN models for a long-term forecasting for the years 2010 to 2030 on the electrical energy consumption (EEC) of both developing and developed economies based on different optimized models and historical data types. By using such an approach, they obtained the result of which usage of historical data of socio-economic indicators produce more accurate EEC forecasting. Azadeh, Ghaderi, Sheikhalishahi

and Nokhandan [8] applied two different seasonal ANNs in order to predict a short load in Iran's electricity market. As regards their prediction result, it reflected a significant correlation between actual data and ANN outcomes. Hence, the ANN models outperform the regression models in terms of MAPE in most cases. Zhao, Zhao and Guo [9] carried out a study to estimate the electricity consumption in Inner Mongolia by using an integrated Grey model enriched by a Moth-flame optimization (MFO) algorithm along with rolling mechanism (Rolling-MFO-GM (1,1)). From their study, it can be seen that such a hybrid model can greatly enhance a forecasting performance for annual electricity consumption. In China, monthly electric energy was also estimated with the implementation of a feature extraction, and this study was investigated by Meng, Niu and Sun [10]. They found that the above method performed better than traditional approaches in terms of expected risk and forecasting precision. Hasanov, Hunt and Mikayilov [11] attempted to establish a model to forecast Azerbaijan's electricity demand in 2025 by applying co-integration and error correction approaches. In their study, Azerbaijan's electricity demand in 2025 was forecast between 19.50 and 21 TWh. Khairalla, Ning, AL-Jallad and El-Faroug [12] investigated the stacking multi-learning ensemble (SMLE) model to forecast energy consumption in the short term. The study's result demonstrated that the mentioned model functioned better and more accurately compared to other methods discussed in this paper.

In other studies, various methods are utilized differently, and their applications vary in context. Chang, Sun and Gu [13] presented a novel quantum harmony search (QHS) algorithm-based discounted mean square forecast error (DMSFE) combination model to forecast energy CO<sub>2</sub> emissions. This study's finding was able to certify the validity of the presented approach, while it also revealed that the forecasting precision can be enhanced to a certain degree. Zeng, Xu, Wang, Chen and Li, [14] examined and forecasted the allocative efficiency of China's carbon emission allowance financial assets at a provincial level for 2020. In their study, they deployed a zero sum gains data envelopment analysis (ZSG-DEA) model. As of their finding, an efficient allocation scheme for all the provinces, based on the mentioned model, was achieved. With that, they therefore provided a suggestion of which particular provinces have to cut off their CO<sub>2</sub> emission. Also, Liang, Niu, Wang and Chen [15] did an evaluation on the security early warning of energy consumption carbon emissions (ECCE) in Hebei Province of China. They constructed an assessment index system according to the pressure-state-response (P-S-R) model, as well as deploying the variance method and linearity weighted method in order to compute such an early warning index of ECCE. Their finding has shown the potential trend of growing improvement from the security index during 2015 to 2020, while the security degree and the corresponding alarm are found to be negative. Prakash, Xu, Rajagopal and Noh [16] presented a forecasting technique according to Gaussian process regression (GPR) to estimate an energy load, and the result reflected that the above method outperformed precisely as compared to other forecasting models. While Mehedintu, Sterpu and Soava [17] embarked on a study to estimate and predict the share of renewable energy consumption in final energy use within the European Union by 2020. This study's analysis utilized three macroeconomic indicators and five regression models (polynomial, ARIMA). Later, the finding showed a growing trend of the share. Liang, Niu, Cao and Hong [18] conducted an analysis and constructed a model to forecast China's electricity demand, in terms of carbon emissions. They began the study with an integration of the Grey relation degree (GRD) and induced ordered weighted harmonic averaging operator (IOWHA) in order to construct the optimal hybrid forecasting model, based on multiple regression and an extreme learning machine. Throughout the study, they drew the conclusion that the proposed model performs better than other forecasting models, especially in boosting overall instability. Furthermore, the study revealed that a low-carbon economy development will increase the demand for electricity, while it impacts the adjustment of the electricity demand structure. In other studies, Zhai and Wang [19] tried to predict the carbon emissions demands in India, under the balanced economic growth path, from 2009 to 2050, using the economy-carbon dynamic model. In this study, they projected that the cumulative energy demand and carbon emissions demand are 44.65 Gtoe and 36.16 Gt C, respectively. Additionally, those two demands will peak in 2045 at 1290.74 Mtoe and 1045.98 Mt C,

respectively, while their demands disclose maximum values of 0.81 toe and 0.65 t C, respectively. On the other hand, in the case of China, Zeng and Chen [20] developed a low-carbon economy index evaluation system, based on the entropy weight method, in order to forecast the allocation ratio of carbon emissions in China for 2020 and 2030. They projected reasonable allocation ratios for carbon emission allowances during the predicted period. Attaining such an allocation ratio can help China in many respects, including economic development, energy conservation and emissions reduction. Zhou, Yu, Guang and Li [21] analyzed and predicted CO<sub>2</sub> emissions in China during the period of 2000 to 2014, by implementing the logarithmic mean division index (LMDI) and genetic algorithm-support vector machine (GA-SVM) model. Their finding reveals that the proposed model performs better than a back propagation neural network (BPNN) model and a single SVM model in terms of forecasting CO<sub>2</sub> emissions. Later, Xu, Gua, Liu and Dai [22] forecasted the final energy consumption of the Guangdong Province of China from 2013 to 2016 using a newly established GM-ARMA model, based on a HP filter. The study shows that this particular model has excellent precision and a higher level of reliability. Additionally, it indicates that the study region will face a serious issue concerning energy conservation and emission reductions in the next few years.

With different developed forecasting approaches, Zhao, Zhao, Liu, Su and An [23] conducted a study to forecast wind speed using the self-adaptive auto-regressive integrated moving average chaotic particle swarm optimization (SA-ARIMA-CPSO) approach. This approach was developed by a SA auto-regressive integrated moving average, with an exogenous variables (ARIMAX) model, through the optimization of the CPSO algorithm. Once the experimental result was revealed, the developed model was shown to outperform the other models. Souza, Christo and Almeida [24] proposed a method using the ARIMA model to locate the faults in power transmission lines. In the study, they analyzed the voltage oscillographic signals. Their study results were found to be satisfactory in a comparison with other used techniques in the literature. In addition, Farias, Puig, Rangel and Flores [25] attempted to forecast the demand of water distribution networks by deploying a multi-model predictor, qualitative multi-model predictor plus (QMMP+). In their study, it was found that such a predictor enhances the forecasting precision. On the other hand, Chen, Xu and Zhou [26] proposed a hybrid approach, combining the variational mode decomposition (VMD) denoising technique and the autoregressive integrated moving average (ARIMA) and GM (1,1) models to predict the lifetime of a battery (RUL). Once the experiment was carried out, a result was produced that indicates the accuracy of the proposed methods for lithium-ion battery on-line RUL prediction. Other than the above studies, Yang, Park, Choi, Kim, Munkhdalai, Musa and Ryu [27] conducted a comparative study on state-of-the-art techniques. They compared four different temporal outbreak detection algorithms, namely, the cumulative SUM (CUSUM), early aberration reporting system (EARS), ARIMA and the Holt-Winters algorithm. Here, the comparison results indicate that the EARS C3 method performs better than any other studied algorithms. However, it can be observed that the Holt-Winters outperforms the others when the baseline frequency and dispersion parameter values are less than 1.5 and 2, respectively. Additionally, Kahsai, Nondo, Schaeffer and Gebremedhin [28] investigated the relationship between energy consumption and economic growth in Sub-Saharan Africa by deploying a panel co-integration approach. Their examination explains the interdependence of energy consumption and economic growth in the study region. The results draw a vital conclusion for formulating sustainable development policies in order to achieve the efficient allocation of resources.

However, Xin, Zhou, Yang, Li and Wang [29] proposed a new method, which integrates the Kalman filter, ARIMA, and generalized autoregressive conditional heteroskedasticity (GARCH) to predict a bridge structure deformation. The study reported the discovery of a new way of predicting structural behavior, based on data processing, laying a basis for a bridge health monitoring system based on sensor data using sensing technology. Li, Yang and Li [30] developed four time-series forecasting techniques, including a metabolism grey model (GM), ARIMA, grey model (GM)-ARIAMA and non-linear metabolism grey model (NMGGM), to forecast China's coal power installed capacity for



the next 10 years (2017–2026). The prediction results present an average annual growth rate of 5.26% for the predicted period. In addition to this, the average annual new added installed capacity for 2017–2026 is found to be 74 gigawatts. Kurecic and Kokotovic [31] examined the relevance of political stability on foreign direct investment (FDI) in three different panels—small, developed, and instability threatened economies—by implementing a Granger causality test, a vector autoregressive (VAR) framework and an ARDL model. As a result, the study presents a conclusion that there is a long-term relationship between political stability and FDI in the panel of small economies, while such a relationship is not found in other panels of larger and more developed economies. Meanwhile, Li and Su [32] adopted the VAR model to study the dynamic effect of renewable energy consumption on carbon dioxide emissions in the US, from 1990 to 2015. They found that the use of renewable energy would greatly help to reduce carbon emissions, yet natural gas consumption would have a negative impact on CO<sub>2</sub> emissions in the early stages. This could guide policy makers to develop energy-saving and emission-reduction policies. Consequently, Dai, Niu and Han [33] proposed to adapt the MSFLA-LSSVM model for CO<sub>2</sub> emissions prediction in China from 2018 to 2025. They concluded that China’s CO<sub>2</sub> emissions would exhibit slow growth trend for the next few years. With this in mind, China’s CO<sub>2</sub> emissions could be effectively controlled in the future, which could start to reduce the greenhouse effect. In another approach.

Last but not least, Jiang, Yang and Li [34] carried out a comparative study of forecasting an energy demand in India by deploying various methods, namely MGM, ARIMA, MGM-ARIMA, and back propagation neural network (BP). Based on their predicted result, India’s energy demand will potentially increase by 4.75% from 2017 to 2030.

Based on a review of previous research, many works have presented metrologies, research methodologies, and various analytical results differently. Thus, this research is grounded in unique features which other existing research has not undertaken before in terms of its modeling, validation, spurious check testing, and the efficiency and effectiveness of its modeling regarding decision-making. In addition, a key feature of this study is the possible application of the model to other sectors according to their particular contexts.

### 3. Materials and Methods

#### 3.1. Co-Integration Testing and Error Correction Mechanism Model Based on Johansen and Juselius

A co-integration test based on the concept of Johansen and Juselius [35] is developed to serve as the relationship model of at least two variables. If the model comes with large sample properties, the result generated may not be accurate as a reference. In practice, we will find that a regression indicates that a modelling variable is co-integrated. If we perform a regression in the form of an order or reverse order, this shows the variable as non-co-integrated. Hence, the second condition is taken out of interest, as the co-integration test should not vary over the change of the variables [5,6,35]:

$$\lambda_{trace}(r) = -T \sum_{i=r+1}^n \ln(1 - \hat{\lambda}_i) \quad (1)$$

Equation (1) sets a hypothesis as follows:

$$H_0 : r \leq k$$

$$H_a : r > k, k = 0, \dots, n$$

$$\lambda_{max}(r, r + 1) = -T(1 - \hat{\lambda}_{r+1}) \quad (2)$$

Equation (2) presents a hypothesis as below:

$$H_0 : r = k$$

$$H_a : r = k + 1, k = 0, \dots, n$$

where  $\hat{\lambda}_i$  is an estimated value of the characteristic roots or eigenvalues derived from estimated matrix  $\pi$ , and T is a number of observations for an estimation of the characteristic roots, retrieved from the equation below:

$$\begin{vmatrix} \lambda S_{pp} & -S_{po} & S_{oo}^{-1} & S_{op} \end{vmatrix} = 0 \tag{3}$$

where  $S_{ij} = T^{-1} \sum_{t=1}^T R_{it}R'_{jt}$ ,  $i, j = o, p$

As for the residuals  $R_{ot}$  and  $R_{pt}$ , they can be derived from a regression of  $\Delta u_t$  and  $\Delta u_{t-p}$  with  $\Delta u_{t-1}, \dots, \Delta u_{t-p+1}$ , where  $x_t$  and  $y_t$  are the time series which are stationary at first differences I (1); A is a constant where  $u_i$  is I (0).

A likelihood ratio test statistic of the null hypothesis is shown below:

$H_0$ : A rank of  $\pi$  that is less or equal to k, or written as  $H_0 : r \leq k$

Hence,

$$-2 \ln(Q) = -T \sum_{i=r+1}^n 1 - \hat{\lambda}_i \tag{4}$$

Equation (4) tells us that  $\alpha = (n \times r)$  matrix,  $\beta = (n \times r)$  matrix,  $r = a$  rank of matrix  $\pi$  where a characteristic of matrix  $\alpha$  and  $\beta$  is as follows:

$$\pi = \alpha\beta' \tag{5}$$

where matrix  $\beta$  is a parameter matrix of co-integrating vectors, and matrix  $\alpha$  is a parameter matrix of speed of adjustment parameters.

In estimating a parameter of the ECM for a co-integrated series, the multi-learning (ML) process that we consider is determined by a sequence, wherein a dimension n can be written as NID (0,  $\Lambda$ ).

The process of cointegration testing according to Johansen can be seen as follows:

Step 1: the procedure to evaluate the order of integration by testing and evaluating the order of integration of all the variables is done by plotting the data to see whether the data-generating process is a linear time trend or otherwise; the variables must be at the same level.

The lag length can be found through a test in VAR with undifferenced data, and later we can estimate a vector autoregression. The process starts from the longest lag length which is deemed reasonable, and we can check whether we can shorten the lag length or not. For instance, if we want to test a significance of lag 2 to lag 5, we have to estimate the VARs as follows [36]:

$$y_1 = A_0 + A_1y_{t-1} + A_2y_{t-2} + A_3y_{t-3} + A_4y_{t-4} + A_5y_{t-5} + u_{1t} \tag{6}$$

$$y_1 = A_0 + A_1y_{t-1} + u_{2t} \tag{7}$$

where

- $y_t = n \times 1$  vector of variables;
- $A_0 = n \times 1$  matrix of intercept terms;
- $A_i = n \times n$  matrix of coefficient;
- $u_{1i}$  and  $u_{2i} = n \times n$  vector of error terms.

In practice, we take an estimation of Equation (6) with a lag equal to 5 for each variable in each equation, and let  $\Sigma_5$  be a variance-covariance matrix of the residuals of Equation (6). Later, we estimate Equation (7) with only one lag for all variables in each equation, and let  $\Sigma_1$  be a variance-covariance matrix of residuals of Equation (7).

As for testing, we use a likelihood ratio test statistic as proposed by Sims [37], although the studied variables taken into account are non-stationary variables. The likelihood ratio test can be demonstrated as below:

$$(T - c)(\ln|\Sigma_1| - \ln|\Sigma_5|) \tag{8}$$

where:

$T$  = a number of observations;

$c$  = a number of parameters in unrestricted system;

$\ln|\Sigma_1|$  = natural logarithm of determinant of  $\Sigma_1$ ;

$\ln|\Sigma_5|$  = natural logarithm of determinant of  $\Sigma_5$ .

A statistical test has a distribution as  $X^2$  with a degree of freedom equivalent to the number of limited coefficients. However, we have found that  $A_i$  has  $n^2$  coefficient. In Equation (7), we have a limitation of  $A_2 = A_3 = A_4 = A_5 = 0$ , and that means that the limitation is equal to  $4n^2$ . Nonetheless, Enders (2010) suggested that we can choose a lag length  $p$  by using AIC or SBC.

Step 2 estimates the modeling and value of rank of  $\pi$ . In this case, the use of ordinary least square (OLS) is not appropriate for the estimation, because the restrictions must be inserted across the equation in matrix  $\pi$ . Here, we may choose to estimate in three different forms: (a) a form that gives a set of  $A_0$  equivalent to zero, (b) a form with a drift or (c) a constant term in a co-integrating vector as shown below:

$$\Delta y_t = A_0 + \pi_1 \Delta y_{t-1} + \pi y_{t-2} + \varepsilon_t \quad (9)$$

where the drift term  $A_0$  is given with restrictions to monitor an intercept appearing in the co-integrating vector in the case of the intercept existing in the co-integrating vector. However, we have to analyze the residuals of the model. If the errors are found not to be white noise, this means that the lag lengths are too short. In terms of the residuals' criteria, the first condition lies upon the residuals of a long-run equilibrium, which must be stationary, and the second condition is that the estimation of short-term deviation (that is  $\varepsilon_t$  in Equation (9)) must be white noise.

Thereafter, the characteristic roots of matrix  $\pi$  have to be estimated, and we compute the value of  $\lambda_{\max}$  and  $\lambda_{\text{trace}}$ .

However, to justify the hypothesis in which the variables are not co-integrated (rank  $\pi = 0$ ), we have two possible statistical tests based on an alternative hypothesis. This is to say that if we want to test the hypothesis saying that the variables are not co-integrated ( $r = 0$ ) where the alternative hypothesis is a co-integrating vector equivalent to or greater than 1 ( $r > 0$ ), we need to do a statistical test of  $\lambda_{\text{trace}}(0)$  as explained below. In the case of Equation (7), the value of the characteristic roots of matrix  $\pi$  (assume  $n = 3$ ) is  $\lambda_1, \lambda_2, \lambda_3$  as shown in the following:

$$\begin{aligned} \lambda_{\text{trace}}(0) &= -T[\ln(1 - \lambda_1) + \ln(1 - \lambda_2) + \ln(1 - \lambda_3)], \\ \lambda_{\text{trace}}(1) &= -T[\ln(1 - \lambda_2) + \ln(1 - \lambda_3)] \end{aligned} \quad (10)$$

where  $\lambda_i$  = an estimated value of the characteristic roots (or known as eigenvalues) derived from matrix  $\pi$  estimated by  $\lambda_1 > \lambda_2 > \lambda_3 > \dots > \lambda_n$ , and  $T$  = a number of observations we can use and compare with a critical value of  $\lambda_{\text{trace}}$ .

Step 3 is a process of the coefficient analysis of co-integrating vectors, which have been normalized, as well as the coefficients of speed of adjustment, as demonstrated below:

1. When we consider whether  $\beta_0 = 0$  or otherwise, we must impose one restriction into the co-integrating vector with the use of the likelihood ratio test. This distributes  $X^2$  with a degree of freedom equivalent to 1, and we assume that we cannot reject  $H_0$  where  $\beta_0 = 0$ . Here, we may need to reapply the model where the constants are absent in the co-integrating vector;
2. In limiting a normalized co-integrating vector at  $\beta_2 = -1$  and  $\beta_3 = 1$ , we are imposing two restrictions into the co-integrating vector. When the likelihood ratio test is used here, in this case it is distributed as  $X^2$  with degrees of freedom equivalent to 2 due to two restrictions;
3. In testing whether  $\beta = (0, -1, -1, 1)$ , we impose three restrictions including  $\beta_0 = 0$ ,  $\beta_2 = -1$ ,  $\beta_3 = 1$  ( $\beta_1$  is equal to  $-1$ ). In this case, the statistical test is the likelihood ratio test, which is distributed as  $X^2$  with a degree of freedom of 3. This type of testing is known as a joint restriction.

4. For a test that is  $\beta = (0, -1, -1, 1)$ , then the constraint 3 is for  $-1$ . In this case, the test statistic is the likelihood ratio test, which is a line of degrees of freedom equal to 3 tests (the joint restriction test).

Step 4 is a stage called “innovation accounting” (which falls under an analysis of impulse response and variance decompositions) designed as a useful tool to evaluate a relationship. If the relationship among other innovations is very low, it indicates that an identification problem will no longer occur. If the order is set differently, the impulse responses and variance decomposition would become similar. In testing the innovation accounting and casual factors toward an error-correction model, this helps to identify a structural model and answer the question of whether an estimating model is reasonable or otherwise.

3.2. Long- and Short-Term Auto-Regressive Integrated Moving Average with Exogenous Variables and the Error Correction Mechanism (LS-ARIMAXi-ECM) Model

The LS-ARIMAXi-ECM model is a newly developed model built upon a concept of the ARIMA model with the following conditions: (1) factors used in modelling are both endogenous variables and exogenous variables, and they must be stationary only at the same level; (2) when the first condition is fulfilled, the above factors have to undergo a co-integration test to investigate the long-term relationship of all factors at the same level only; (3) the next step is to build a forecasting model of LS-ARIMAXi-ECM whose construction is structured based on autoregressive (AR), integrated (I), moving average (MA), ECM ( $t - i$ ) and exogenous variables ( $X_i$ ), as explained in the next paragraph.

3.2.1. Autoregressive Moving Average (ARMA) Model

The ARMA ( $p, q$ ) model is written as [38,39]:

$$X_t = \alpha_0 + \alpha_1 X_{t-1} + \alpha_2 X_{t-2} + \dots + \alpha_p X_{t-p} + \varepsilon_t - \beta_1 \varepsilon_{t-1} - \beta_2 \varepsilon_{t-2} - \dots - \beta_q \varepsilon_{t-q} \tag{11}$$

where  $t = 1, 2, \dots, T$ . If we consider at time  $T$ , the ARMA model becomes:

$$X_T = \alpha_0 + \alpha_1 X_{T-1} + \alpha_2 X_{T-2} + \dots + \alpha_p X_{T-p} + \varepsilon_T - \beta_1 \varepsilon_{T-1} - \beta_2 \varepsilon_{T-2} - \dots - \beta_q \varepsilon_{T-q} \tag{12}$$

or it can be written in another form as:

$$\alpha(L)X_T = \alpha_0 + \beta(L)\varepsilon_T \tag{13}$$

where  $\alpha(L) = 1 - \alpha_1 L - \alpha_2 L^2 - \dots - \alpha_p L^p$  and  $\beta(L) = 1 - \beta_1 L - \beta_2 L^2 - \dots - \beta_q L^q$  while the information at time  $T$  can be replaced by  $I_T = \{X_1, \dots, X_T, \varepsilon_1, \dots, \varepsilon_T\}$ . Equation (12) produces  $X_{T-1}$  and  $X_{T-2}$  as the equation below:

$$X_{T-1} = \alpha_0 + \alpha_1 X_T + \alpha_2 X_{T-1} + \dots + \alpha_p X_{T+(1-p)} + \varepsilon_{T+1} - \beta_1 \varepsilon_T - \beta_2 \varepsilon_{T-1} - \dots - \beta_q \varepsilon_{T+(1-q)} \tag{14}$$

$$X_{T-2} = \alpha_0 + \alpha_1 X_{T+1} + \alpha_2 X_T + \dots + \alpha_p X_{T+(2-p)} + \varepsilon_{T+2} - \beta_1 \varepsilon_{T+1} - \beta_2 \varepsilon_T - \dots - \beta_q \varepsilon_{T+(2-q)} \tag{15}$$

A forecasting of time series 1 and 2 from ARMA( $p, q$ ) can be made below:

$$\hat{X}_T(1) = E(X_{T+1}|I_T) = \alpha_0 + \alpha_1 X_T + \alpha_2 X_{T-1} + \dots + \alpha_p X_{T+(1-p)} - \beta_1 \varepsilon_T - \dots - \beta_q \varepsilon_{T+(1-q)} \tag{16}$$

$$\hat{X}_T(2) = E(X_{T+2}|I_T) = \alpha_0 + \alpha_1 \hat{X}_T(1) + \alpha_2 X_T + \dots + \alpha_p X_{T-(p-2)} - \beta_2 \varepsilon_T - \dots - \beta_q \varepsilon_{T+(2-q)} \tag{17}$$

While we can formulate  $X_{T+j}$  in a general form as:

$$\hat{X}_T(j) = E(X_{T+j}|I_T) \tag{18}$$

$$\hat{X}_T(j) = \alpha_0 + \sum_{i=1}^p \alpha_i \hat{X}_T(j-i) - \sum_{i=1}^q \beta_i \varepsilon_T(j-i) \tag{19}$$

where:

$$\begin{aligned} \hat{X}_T(j-1) &= X_{T+(j-i)} \text{ when } j-i \leq 0 \\ \varepsilon_T(j-i) &= \begin{cases} \varepsilon_{T+(j-i)} & , \text{if } j-i \leq 0 \\ 0 & , \text{if } j-i > 0 \end{cases} \end{aligned}$$

Besides, we can also check ARMA(1, 1) as the above explanation when  $j \rightarrow \infty$ , and the forecasting can be executed from:

$$\hat{X}_T(j) = \frac{\alpha_0}{1 - \alpha_1 - \dots - \alpha_p} \tag{20}$$

Equation (20) tells us when to forecast further where the forecasting result will approach  $\frac{\alpha_0}{1 - \alpha_1 - \dots - \alpha_p} = E(X_t)$ , and this is the average of time series  $X_t$  in the ARMA(p, q) model. In addition, the j-step ahead forecast error and its variance can be easily executed when altering the ARMA(p, q) model into MA(∞) as explained below.

Since the time series  $X_t$  is stationary, it can be rewritten as:

$$X_T = \frac{\alpha_0}{\alpha(L)} + \frac{\beta_0}{\alpha(L)} \varepsilon_T \tag{21}$$

when considering  $\frac{\alpha_0}{\alpha(L)} = \frac{\alpha_0}{1 - \alpha_1 - \dots - \alpha_p} = E(X_t)$ , which is the average. When  $\frac{\beta_0}{\alpha(L)} \varepsilon_T$  is considered, it shows a relativeness to  $\varepsilon_T$ , and that  $\frac{\beta_0}{\alpha(L)} \varepsilon_T = \frac{1 - \beta_1 L - \dots - \beta_q L}{1 - \alpha_1 L - \dots - \alpha_p L} \varepsilon_T$  with inconstancy in value.

$$\frac{\alpha_0}{\alpha(L)} = \mu \tag{22}$$

$$\frac{\beta(L)}{\alpha(L)} = \phi(L) = 1 + \phi_1 L + \phi_1^2 L^2 + \dots \tag{23}$$

Thus, Equation (21) with ARMA(p, q) can be formulated into the MA(∞) form as:

$$X_T = \mu + \phi(L) \varepsilon_T \tag{24}$$

We call this  $\phi_i (i = 1, 2, \dots)$  the impulse response function of the ARMA model. When the time series  $X_T$  is stationary,  $\phi_1, \phi_2, \phi_3, \dots$  will rapidly decrease exponentially. However, Equation (24) can be used to compute the j-step ahead forecast error and its variance through the following description.

From Equation (24), the time series  $X_{T+1}, X_{T+2}$ , and  $X_{T+3}$  can be written as follows:

$$X_{T+1} = \mu + \varepsilon_{T+1} + \phi_1 \varepsilon_T + \phi_2 \varepsilon_{T-1} + \dots \tag{25}$$

$$X_{T+2} = \mu + \varepsilon_{T+2} + \phi_1 \varepsilon_{T+1} + \phi_2 \varepsilon_T + \phi_3 \varepsilon_{T-1} + \dots \tag{26}$$

$$X_{T+3} = \mu + \varepsilon_{T+3} + \phi_1 \varepsilon_{T+2} + \phi_2 \varepsilon_{T+1} + \phi_3 \varepsilon_T + \phi_4 \varepsilon_{T-1} + \dots \tag{27}$$

Then, the forecasting value of 1, 2, and 3 ahead is derived from the following:

$$\hat{X}_T(1) = E(X_{T+1}|I_T) = \mu + \phi_1 \varepsilon_T + \phi_2 \varepsilon_{T-1} + \dots \tag{28}$$

$$\hat{X}_T(2) = E(X_{T+2}|I_T) = \mu + \phi_2 \varepsilon_T + \phi_3 \varepsilon_{T-1} + \dots \tag{29}$$

$$\hat{X}_T(3) = E(X_{T+3}|I_T) = \mu + \phi_3 \varepsilon_T + \phi_4 \varepsilon_{T-1} + \dots \tag{30}$$

While its error at 1, 2, and 3 ahead is as follows:

$$e_T(1) = X_{T+1} - \hat{X}_T(1) = \varepsilon_{T+1} \tag{31}$$

$$e_T(2) = X_{T+2} - \hat{X}_T(2) = \varepsilon_{T+2} + \phi_1 \varepsilon_{T+1} \tag{32}$$

$$e_T(3) = X_{T+3} - \hat{X}_T(3) = \varepsilon_{T+3} + \phi_1 \varepsilon_{T+2} + \phi_2 \varepsilon_{T+1} \tag{33}$$

Moreover, its variance at 1, 2, and 3 ahead is as below:

$$\text{Var}(e_T(1)) = \sigma^2 \tag{34}$$

$$\text{Var}(e_T(2)) = (1 + \phi_1^2)\sigma^2 \tag{35}$$

$$\text{Var}(e_T(3)) = (1 + \phi_1^2 + \phi_2^2)\sigma^2 \tag{36}$$

However, the  $j$ -step ahead forecast error and its variance can be drawn in an equation as follows:

$$e_T(j) = \varepsilon_{T+j} + \phi_1 \varepsilon_{T+(j-1)} + \phi_2 \varepsilon_{T+(j-2)} + \dots + \phi_{j-1} \varepsilon_{T+1} \tag{37}$$

$$\text{Var}(e_T(j)) = (1 + \phi_1^2 + \phi_2^2 + \dots + \phi_{j-1}^2)\sigma^2 \tag{38}$$

### 3.2.2. Autoregressive Integrated Moving Average (ARIMA( $p, d, q$ )) Model

The non-stationary variables used in the modeling must be converted into a stationary variable before being deployed into the modeling by differentiating. This is called  $ARIMA(p, d, q)$  and can be explained through the equation below [38,39]:

$$\Delta X_t = \alpha_0 + \alpha_1 \Delta X_{t-1} + \varepsilon_t \tag{39}$$

where  $t = 1, 2, \dots, T$ .

When the value  $X_1, X_2, \dots, X_T$  (otherwise denoted as  $I_T$ ) is known, Equation (39) can be illustrated as follows:

$$\left. \begin{aligned} \hat{X}_{T+1} &= \alpha_0 + \alpha_1 \Delta \hat{X}_T \\ \hat{X}_{T+2} &= \alpha_0 + \alpha_1 \Delta \hat{X}_{T+1} \\ \hat{X}_{T+3} &= \alpha_0 + \alpha_1 \Delta \hat{X}_{T+2} \\ &\vdots \\ \hat{X}_{T+j} &= \alpha_0 + \alpha_1 \Delta \hat{X}_{T+(j-1)} \end{aligned} \right\} \tag{40}$$

Another explanation of  $ARIMA(1, 1, 0)$  can be seen as below:

$$X_t - X_{t-1} = \alpha_0 + \alpha_1 (X_{t-1} - X_{t-2}) + \varepsilon_t \tag{41}$$

$$X_t = \alpha_0 + (\alpha_1 + 1)X_{t-1} - \alpha_1 X_{t-2} + \varepsilon_t \tag{42}$$

where  $t = 1, 2, \dots, T$

As for forecasting with  $ARIMA(p, 1, q)$ , this can be applied as demonstrated below.

Assuming the  $ARIMA(p, 1, q)$  model is written as below:

$$\Delta X_t = \alpha_0 + \alpha_1 \Delta X_{t-1} + \alpha_2 \Delta X_{t-2} + \dots + \alpha_p \Delta X_{t-p} + \varepsilon_t - \beta_1 \varepsilon_{t-1} - \beta_2 \varepsilon_{t-2} - \dots - \beta_1 \varepsilon_{t-q} \tag{43}$$

$$X_t - X_{t-1} = \alpha_0 + \alpha_1 (X_{t-1} - X_{t-2}) + \alpha_2 (X_{t-2} - X_{t-3}) + \dots + \alpha_p (X_{t-p} - X_{t-p-1}) + \varepsilon_t - \beta_1 \varepsilon_{t-1} - \beta_2 \varepsilon_{t-2} - \dots - \beta_1 \varepsilon_{t-q} \tag{44}$$

when the ARIMA model is retrieved, we will apply it to establish a model called the LS-ARIMAXi-ECM Model. This can be seen in the following.



### 3.2.3. LS-ARIMAXi-ECM Model

The LS-ARIMAXi-ECM model can be written as below:

$$\begin{aligned} \Delta X_t &= \alpha_0 + \alpha_1 \Delta X_{t-1} + \alpha_2 \Delta X_{t-2} + \dots + \alpha_p \Delta X_{t-p} + \\ \varepsilon_t - \beta_1 \varepsilon_{t-1} - \beta_2 \varepsilon_{t-2} - \dots - \beta_q \varepsilon_{t-q} &+ \sum_{i=1}^p Y_{t-i} + \sum_{i=1}^p ECM_{t-i} \end{aligned} \tag{45}$$

where  $\sum_{i=1}^p Y_{t-i}$  = exogenous variables, which are stationary at a level and  $\sum_{i=1}^p ECM_{t-i}$  = the error correction mechanism test.

The LS-ARIMAXi-ECM model is a model that requires the testing of the appropriateness of the time-period through Q-test statistics. Also, it needs to undergo an assessment of its heteroskedasticity, multicollinearity, and autocorrelation. This is to ensure that the model will not be a spurious model. Once we derive the best model, we must test the model performance for both MAPE and RMSE values. Consequently, we can compare the above values of the model with other studied models to monitor the effectiveness of the model for future use.

### 3.3. Measurement of the Forecasting Performance

There are many methods we can choose; we decided to utilize the MAPE and RMSE to compare the forecasting accuracy of each model. The calculation equations are shown as follows [38,39]:

$$MAPE = \frac{1}{n} \sum_{i=1}^n \left| \frac{\hat{y}_i - y_i}{y_i} \right| \tag{46}$$

$$RMSE = \sqrt{\frac{1}{n} \sum_{i=1}^n (\hat{y}_i - y_i)^2} \tag{47}$$

## 4. Results

### 4.1. Screening of Influencing Factors for Model Input

In this paper, we bring the causal factors to bear on the stationary status under the Sustainable Development policy of Thailand. The time series data used ranges from 1990 to 2017 along with 8 factors, including carbon dioxide emissions (CO<sub>2</sub>), per capita GDP (GDP), population growth (Population), urbanization rate (URT), industrial structure (IST), total coal consumption (CCT), oil price (OP), and total exports and imports (X – E).

The test was conducted based on the augmented Dickey and Fuller theory at Level I (0) and the First Difference I (1), as illustrated in Table 1.

**Table 1.** Unit root test at one level and first difference I (1).

Tau Test at Level I (0)		Tau Test at First Difference I (1)		MacKinnon Critical Value		
Variables	Value	Variables	Value	1%	5%	10%
ln(CO <sub>2</sub> )	-2.21	Δ ln(CO <sub>2</sub> )	-4.69 ***	-4.37	-3.05	-2.95
ln(GDP)	-2.74	Δ ln(GDP)	-5.95 ***	-4.37	-3.05	-2.95
ln(Population)	-2.13	Δ ln(Population)	-4.44 ***	-4.37	-3.05	-2.95
ln(URT)	-2.59	Δ ln(URT)	-5.61 ***	-4.37	-3.05	-2.95
ln(IST)	-2.77	Δ ln(IST)	-5.74 ***	-4.37	-3.05	-2.95
ln(CCT)	-2.40	Δ ln(CCT)	-5.45 ***	-4.37	-3.05	-2.95
ln(X – E)	-2.90	Δ ln(X – E)	-5.59 ***	-4.37	-3.05	-2.95
ln(OP)	-2.83	Δ ln(OP)	-5.61 ***	-4.37	-3.05	-2.95

Note: \*\*\* denotes a significance, α = 0.01, compared to the Tau test with the MacKinnon Critical Value, Δ is the first difference, and ln is the natural logarithm.

Table 1 clarifies which of all the factors are analyzed in the unit root test and found to be non-stationary at Level I (0) or insignificant at 1%, 5% and 10%. Therefore, it requires a first difference analysis. This results in the fact that all the factors are stationary at Level I (1) or significant at 1%, 5% and 10%. Next, we bring the factors for co-integration testing using a concept of Johansen and Juselius in Table 2.

**Table 2.** Co-integration testing using a concept of Johansen and Juselius.

		1%	5%	
$\Delta \ln(\text{CO}_2)$ , $\Delta \ln(\text{GDP})$ , $\Delta \ln(\text{Population})$ , $\Delta \ln(\text{URT})$ , $\Delta \ln(\text{IST})$ , $\Delta \ln(\text{CCT})$ , $\Delta \ln(\text{X} - \text{E})$ , $\Delta \ln(\text{OP})$	None ***	275.41	141.25	20.15 15.05 I (1)
	At Most 1 ***	82.45	96.05	5.25 3.40 I (1)

\*\*\* denotes significance  $\alpha = 0.01$ .

The test results of co-integration are shown in Table 2. The test presents a trace test score of 275.41 and 82.45. At the same time, the results of the maximum eigenvalue test are 141.25 and 96.05, which are higher than the MacKinnon critical values at the same significance levels. This signifies a long-term relationship of all variables as well as a feasible use of variables in structuring the LS-ARIMAX<sub>i</sub>-ECM model.

4.2. Formation of Analysis Modeling with the LS-ARIMAX<sub>i</sub> (p, d, q, X<sub>t-1</sub>)-ECM Model

As for the LS-ARIMAX<sub>i</sub> (p, d, q, X<sub>t-1</sub>)-ECM model, it is built with the aim of being applicable in different contexts in various sectors. Hence, we seek to test an appropriate time period by using Q-testing. This produces a conclusion in which the right time is a period (t - i) of p, d, q, X<sub>t-i</sub>, and the best fit is the period (t - i). They are embedded in the LS-ARIMAX<sub>i</sub> (2, 1, 1, X<sub>t-1</sub>)-ECM model as shown in Figure 2.

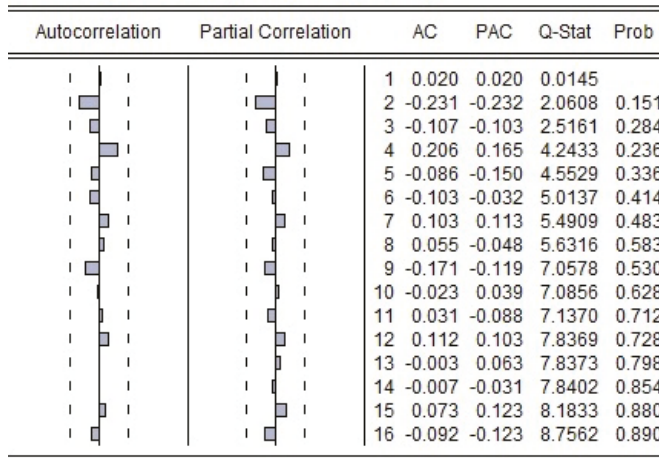

Note: AC means the value of the autocorrelation coefficient. PAC means the value of the partial correlation coefficient.

**Figure 2.** The correlogram of the residual error of the LS-ARIMAX<sub>i</sub> (2, 1, 1, X<sub>t-1</sub>)-ECM model.

Figure 2 reflects the fact that the LS-ARIMAX<sub>i</sub> (2, 1, 1, X<sub>t-1</sub>)-ECM model becomes the best forecasting model because all values of the Q test statistic at time (t - i) are in the criteria and meet all conditions, or the insignificance falls as follows;  $\alpha = 0.01$ ,  $\alpha = 0.05$  and  $\alpha = 0.1$ . Therefore, this model can be used to forecast CO<sub>2</sub> emissions. However, the authors have discovered the best model currently to be the LS-ARIMAX<sub>i</sub> (2, 1, 1, X<sub>t-1</sub>)-ECM model, and this allows us to know about the

influence of the changes or elasticity of all independent variables causing changes in the CO<sub>2</sub> emission at time ( $t - i$ ), as illustrated in Table 3.

**Table 3.** The result of the LS-ARIMAX<sub>i</sub> (2, 1, 1, X<sub>t-i</sub>)

Independent Variables	Dependent Variable
	$\Delta \ln(\text{CO}_2)_t$
$\Delta \ln(\text{CO}_2)_{t-1}$	2.01 **
$\Delta \ln(\text{CO}_2)_{t-2}$	3.75 ***
MA(1)	2.72 ***
$\Delta \ln(\text{GDP})_{t-2}$	6.78 ***
$\Delta \ln(\text{Population})_{t-1}$	2.33 **
$\Delta \ln(\text{URT})_{t-1}$	5.45 ***
$\Delta \ln(\text{IST})_{t-1}$	4.62 ***
$\Delta \ln(\text{CCT})_{t-2}$	3.15 ***
$\Delta \ln(X - E)_{t-2}$	6.40 ***
$\Delta \ln(\text{OP})_{t-3}$	6.55 ***
ECM <sub>t-1</sub>	-3.87 ***

Note: In the above,  $\Delta \ln(\text{CO}_2)_{t-1}$  and  $\Delta \ln(\text{CO}_2)_{t-2}$  are the autoregressive model, MA is the moving average model, \*\*\* denotes significance  $\alpha = 0.01$ , \*\* denotes significance  $\alpha = 0.05$ , R-squared is 0.94, adjusted R-squared is 0.93, the Durbin–Watson statistic is 2.02, the F-statistic is 245.05 (probability is 0.00), the ARCH test is 31.05 (probability is 0.1), the LM test is 1.45 (probability is 0.11), and the chi-square test represents the significance.

Table 3 illustrates the parameters of the LS-ARIMAX<sub>i</sub> (2, 1, 1, X<sub>t-1</sub>)-ECM model at a statistically significant level of 1% and 5%. Regarding the examination of the goodness of fit of the LS-ARIMAX<sub>i</sub> (2, 1, 1, X<sub>t-1</sub>)-ECM model, it has been found that R-squared is 0.93, and this indicates that the independent variables can explain or predict the dependent variables by up to 93%. By investigating the autocorrelation at the Durbin–Watson statistic of 2.02 and the LM test, of 1.45, the model was found to be free from the autocorrelation issue. The F-statistic is 245.05 (probability is 0.00), and this shows that the LS-ARIMAX<sub>i</sub> (2, 1, 1, X<sub>t-1</sub>)-ECM model maintains a confidence interval of 99% and 95% and eliminates the issue of multicollinearity. The value of the ARCH test is 31.05, and this guarantees that the model is free from the issue of heteroscedasticity.

The findings have illustrated that when the per capita GDP ( $\Delta \ln(\text{GDP})_{t-2}$  at time ( $t-2$ ) changes about 1%, it affects CO<sub>2</sub> emissions ( $\Delta \ln(\text{CO}_2)_t$ ) changing in the same direction equivalent to 6.78% at a confidence interval of 99%. While the population growth ( $\Delta \ln(\text{Population})_{t-1}$  changes by about 1%, it influences CO<sub>2</sub> emissions ( $\Delta \ln(\text{CO}_2)_t$ ), changing in the same direction, equivalent to 2.33% at a confidence interval of 95%. When the urbanization rate ( $\Delta \ln(\text{URT})_{t-1}$ ) changes by about 1%, it changes CO<sub>2</sub> emissions ( $\Delta \ln(\text{CO}_2)_t$ ) in the same direction, equivalent to 5.45% at a confidence interval of 99%. When the industrial structure  $\Delta \ln(\text{IST})_{t-1}$  changes by about 1%, it affects CO<sub>2</sub> emissions ( $\Delta \ln(\text{CO}_2)_t$ ) changing in the same direction, equivalent to 4.62% at a confidence interval of 99%. When the total coal consumption ( $\Delta \ln(\text{CCT})_{t-2}$ ) changes by about 1%, it changes CO<sub>2</sub> emissions ( $\Delta \ln(\text{CO}_2)_t$ ) in the same direction, equivalent to 3.15% at a confidence interval of 99%. Also, when the total exports and imports  $\Delta \ln(X - E)_{t-2}$  change by about 1%, they influence CO<sub>2</sub> emissions ( $\Delta \ln(\text{CO}_2)_t$ ) changing in the same direction, equivalent to 6.40% at a confidence interval of 99%. With the same effect, when the oil price ( $\Delta \ln(\text{OP})_{t-3}$ ) changes by about 1%, it affects CO<sub>2</sub> emissions ( $\Delta \ln(\text{CO}_2)_t$ ) changing in the same direction, equivalent to 6.55% at a confidence interval of 99%. In the case of oil prices, although the oil price has climbed, energy consumption is also increasing, which results in increased CO<sub>2</sub> emissions. This is because oil price is not a product based on the law of demand.

In case of ECM<sub>t-1</sub> at a coefficient value of -3.87, the adjustment of the LS-ARIMAX<sub>i</sub> (2, 1, 1, X<sub>t-i</sub>)-ECM model toward the equilibrium is at a rate of 3.87%.

As far as the LS-ARIMAX<sub>i</sub> (2, 1, 1, X<sub>t-i</sub>)-ECM model is concerned, we have compared it in terms of its model efficiency with other old models by deploying MAPE and RMSE. The comparison

between the new model with the old ones—multiple regression, GM (1,1), ANN, ARMA, ARIMA, and GM-ARIMA—is undertaken as follows.

Table 4 shows that the LS-ARIMAX<sub>i</sub> (2, 1, 1, X<sub>t-i</sub>)-ECM model comprises the lowest value of MAPE and RMSE, equivalent to 1.01% and 0.93%, respectively. The GM-ARIMA model shows an MAPE and RMSE at 4.27% and 3.45%, respectively. The ARIMA model shows an MAPE and RMSE of 5.38% and 5.85%, respectively, while the ARMA model has an MAPE and RMSE equivalent to 10.18% and 11.36%, respectively. The ANN model produces MAPE and RMSE of 12.55% and 13.65%, respectively, whereas the GM (1,1) has MAPE and RMSE of 12.94% and 17.39%, respectively. Lastly, the multiple regression model generates an MAPE and RMSE equivalent to 20.05% and 19.49%, respectively. When comparing the studied model's values with other models, it is found that the LS-ARIMAX<sub>i</sub> (2, 1, 1, X<sub>t-i</sub>)-ECM model is an efficient model and is suitable for future long-term forecasting.

**Table 4.** The performance monitoring of the forecasting model. MAPE: mean absolute percentage error.

Forecasting Model	MAPE (%)	RMSE (%)
Multiple Regression model	20.05	19.49
Grey model (GM (1,1))	12.94	17.39
Artificial Neural Natural (ANN) model	12.55	13.65
Autoregressive Moving Average (ARMA) model	10.18	11.36
Autoregressive Integrated Moving Average (ARIMA) model	5.38	5.85
GM-ARIMA Model	4.27	3.45
LS-ARIMAX <sub>i</sub> (2, 1, 1, X <sub>t-i</sub> )-ECM	1.01	0.93

#### 4.3. CO<sub>2</sub> Emission Forecasting Based on the LS-ARIMAX<sub>i</sub> (2, 1, 1, X<sub>t-1</sub>)-ECM Model

When the most suitable forecasting model of LS-ARIMAX<sub>i</sub> (2, 1, 1, X<sub>t-1</sub>)-ECM is retrieved, we can then use it to predict and estimate the carbon dioxide emissions in Thailand's construction sector for a duration of 20 years (2019–2038), as shown in Figure 3.

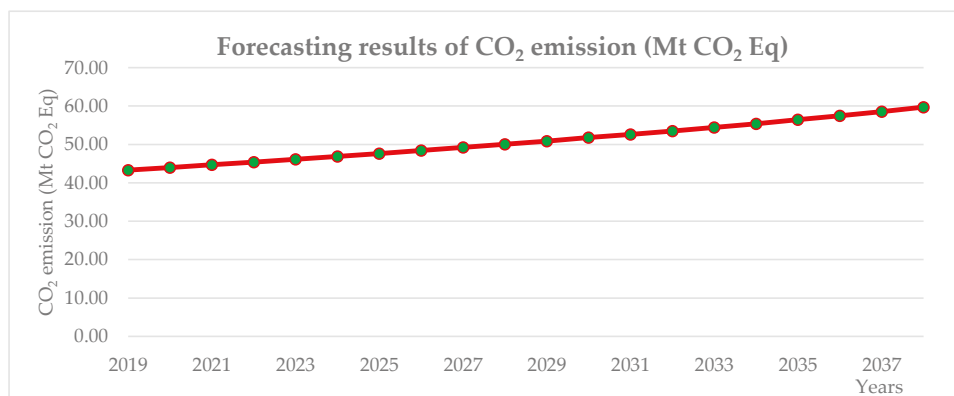

**Figure 3.** The forecasting results of CO<sub>2</sub> emission from 2019 to 2038 in Thailand's construction sector.

Figure 3 shows that the CO<sub>2</sub> emissions for the next 20 years from 2019 to 2038 in Thailand's construction sector will increase along with a growth rate of 37.88%. In 2019, the CO<sub>2</sub> emissions are projected to be 43.31 (Mt CO<sub>2</sub> Eq) with a continuous increase. By 2038, the CO<sub>2</sub> emissions are forecast to be 59.72 (Mt CO<sub>2</sub> Eq). The above results reflect that the construction sector is a sector with continuous emissions of CO<sub>2</sub>, resulting in a continuous rise in greenhouse gas emissions.

## 5. Discussion

The result of this study is the establishment of the LS-ARIMAX<sub>i</sub> (2, 1, 1, X<sub>t-i</sub>)-ECM model. This model is built and used to forecast CO<sub>2</sub> emissions in the construction sector in Thailand for 20 years in total (2019–2038). As for this model, only causal factors which are stationary at the same level are selected, and the model is free from being a spurious model. In this study, the model efficiency is evaluated by comparing the model performance with other old models, consisting of the multiple regression, grey model (GM (1,1)), ANN, ARMA model, ARIMA model, and GM-ARIMA model. The evaluation outcome reaffirms that the LS-ARIMAX<sub>i</sub> (2, 1, 1, X<sub>t-i</sub>)-ECM model has better efficiency and is more appropriate for long-term prediction than the other existing models. In its prediction, the established model projects that there will be a continuous increase of CO<sub>2</sub> emissions at a growth rate of 43.31 (Mt CO<sub>2</sub> Eq) (2019–2038). This suggests that Thailand has to take serious action in policy planning as well as in following up evaluations in the construction sector. In the meantime, Thailand has to develop other sustainability policies in line with existing policies. This study differs from other previous studies as it builds a new LS-ARIMAX<sub>i</sub>-ECM model based on the concept of the ARIMA model coupled with co-integration testing. In modelling, the LS-ARIMAX<sub>i</sub>-ECM model is deployed with advanced statistics. Only the causal yet exogeneous factors are integrated, while an error correction mechanism has been incorporated to clearly determine the magnitude of equilibrium adjustment in both the short and long term. The unique feature of the LS-ARIMAX<sub>i</sub> (2, 1, 1, X<sub>t-i</sub>)-ECM model is that it can be applied to other sectors and areas. The model is not a spurious model as it is free from heteroskedasticity, multicollinearity, and autocorrelation. As such, this allows the model to accurately determine a magnitude of change of CO<sub>2</sub> emissions better than other existing models. Hence, it becomes supportive in the decision-making and long-term planning of Thailand in the future.

From the review of the literature, this kind of study has been shown to be relevant to other past research in terms of model applications in CO<sub>2</sub> emission forecasting. Zhao, Zhao, and Guo [9] used GM (1,1) optimized by MFO with a rolling mechanism to forecast the electricity consumption of Inner Mongolia; Chang, Sun, and Gu [13] forecast energy CO<sub>2</sub> emissions using a quantum harmony search algorithm-based DMSFE combination model; Zeng, Xu, Wang, Chen, and Li [14] forecasted the allocative efficiency of carbon emission allowance financial assets in China at the provincial level in 2020; Liang, Niu, Wang, and Chen [15] did an assessment analysis and forecast for the secure early warning of energy consumption carbon emissions in Hebei Province, China; Li, Yang, and Li [30] forecast China's coal power installed capacity using a comparison of MGM, ARIMA, GM-ARIMA, and NMGGM Models.

However, the entirety of the literature is distinguished this paper in terms of its modeling process, application capability, appropriateness assessment of the time period, prediction quality and usage. In fact, this research aims to forecast energy-related carbon dioxide emissions in Thailand's construction sector for 20 years (2019–2038), which is constructed based on advanced research methodologies, high-quality statistics and a detailed research process. In the past, many studies have focused on research findings, not the research process. Therefore, some errors and potential risks occurred. Nonetheless, our particular study is seen as better and more efficient than any other previous studies in the field. Also, this study responds to a long-term need to have a model whose capacity is improved for future application in different contexts.

In the selection of software for use in this research, we decided to use the EVIEWS 9.2 software as a research tool to optimize the advanced statistics effectively. As for those who are interested in the software, EVIEWS can be downloaded in a student version at no cost or license fee, or you may choose other software as you see fit.

Regarding the limitations of this study, some factors of the sustainable development policy are not taken into account, including oil prices. This is because the Thai government has a policy to ensure diesel prices, and that is a major factor affecting energy consumption in Thailand. With government interference, the price of diesel fuel does not fluctuate in line with market mechanisms. Due to this

phenomenon, this study is not able to include that factor, as it does not determine the real magnitude of the change in diesel prices on CO<sub>2</sub> emissions.

## 6. Conclusions

This paper has developed and established the LS-ARIMAX<sub>i</sub> (2, 1, 1, X<sub>t-i</sub>) model for a useful application in forecasting the future trends of CO<sub>2</sub> emissions in the construction sector of Thailand for the next 20 years (2019–2038). This model is able to effectively and efficiently support sustainable development policy planning in Thailand. Most importantly, it can reduce errors in the planning so as to avoid mistakes of the past. In addition, the model is undertaken through careful research methods, with a highly statistical use of data. Additionally, we have chosen 8 variables from the casual factors. The variables are carbon dioxide emissions (CO<sub>2</sub>), per capita GDP (GDP), population growth (Population), urbanization rate (URT), industrial structure (IST), total coal consumption (CCT), oil price (OP), and total exports and imports (X – E). All of the variables used are assessed by the unit root test, at the first level, and analyzed using the co-integration test, resulting in the LS-ARIMAX<sub>i</sub> (2, 1, 1, X<sub>t-i</sub>) model. Additionally, they are tested for a proper time period ( $t - i$ ). In fact, the model is found to be free from the issue of heteroskedasticity, multicollinearity, and autocorrelation and therefore, it becomes a most suitable model for forecasting CO<sub>2</sub> emissions in Thailand's construction sector, while it is available for future applications in other sectors and contexts both in Thailand and other countries.

One remaining aspect to reflect upon is that the LS-ARIMAX<sub>i</sub> (2, 1, 1, X<sub>t-i</sub>) model has considered not only the stationary causal factors on the same level, but also proportion and relationship analysis. In addition to this, each factor of the model is analyzed based on rationality and the structure equation model (SEM) so as to increase its utilization and optimization for future research and policy planning.

As a recommendation for applying this research, the model should be adapted for the context of each sector and area. In particular, factors have to be stationary and influential over dependent variables. At the same time, they must have a co-integration at the same level to avoid the model being spurious and to decrease errors. Also, they must undergo an assessment of the appropriateness of their time period in order to produce the most accurate prediction result.

**Author Contributions:** J.S. and K.K. were involved in the data collection and preprocessing phase, model constructing, empirical research, results analysis and discussion, and manuscript preparation. All authors have approved the submitted manuscript.

**Funding:** This research received no external funding.

**Acknowledgments:** This work was performed with the approval of King Mongkut's University of Technology Thonburi.

**Conflicts of Interest:** The authors declare no conflict of interest.

## References

1. Office of the National Economic and Social Development Board (NESDB). Available online: [http://www.nesdb.go.th/nesdb\\_en/more\\_news.php?cid=154&filename=index](http://www.nesdb.go.th/nesdb_en/more_news.php?cid=154&filename=index) (accessed on 1 August 2018).
2. National Statistic Office Ministry of Information and Communication Technology. Available online: <http://web.nso.go.th/index.htm> (accessed on 2 August 2018).
3. Department of Alternative Energy Development and Efficiency. Available online: [http://www.dede.go.th/ewtadmin/ewt/dede\\_web/ewt\\_news.php?nid=47140](http://www.dede.go.th/ewtadmin/ewt/dede_web/ewt_news.php?nid=47140) (accessed on 3 August 2018).
4. Thailand Greenhouse Gas Management Organization (Public Organization). Available online: <http://www.tgo.or.th/2015/thai/content.php?s1=7&s2=16&sub3=sub3> (accessed on 3 August 2018).
5. Dickey, D.A.; Fuller, W.A. Likelihood ratio statistics for autoregressive time series with a unit root. *Econometrica* **1981**, *49*, 1057–1072. [[CrossRef](#)]
6. Johansen, S.; Juselius, K. Maximum likelihood estimation and inference on cointegration with applications to the demand for money. *Oxford Bull. Econ. Stat.* **1990**, *52*, 169–210. [[CrossRef](#)]

7. Ardakani, F.J.; Ardehali, M.M. Long-term electrical energy consumption forecasting for developing and developed economies based on different optimized models and historical data types. *Energy* **2014**, *65*, 452–461. [[CrossRef](#)]
8. Azadeh, A.; Ghaderi, S.F.; Sheikhalishahi, M.; Nokhandan, B.P. Optimization of short load forecasting in electricity market of Iran using artificial neural networks. *Opt. Eng.* **2014**, *15*, 485–508. [[CrossRef](#)]
9. Zhao, H.; Zhao, H.; Guo, S. Using GM (1,1) Optimized by MFO with rolling mechanism to forecast the electricity consumption of Inner Mongolia. *Appl. Sci.* **2016**, *6*, 20. [[CrossRef](#)]
10. Meng, M.; Niu, D.; Sun, W. Forecasting monthly electric energy consumption using feature extraction. *Energies* **2011**, *4*, 1495–1507. [[CrossRef](#)]
11. Hasanov, F.J.; Hunt, L.C.; Mikayilov, C.I. Modeling and forecasting electricity demand in Azerbaijan using cointegration techniques. *Energies* **2016**, *9*, 1045. [[CrossRef](#)]
12. Khairalla, M.A.; Ning, X.; AL-Jallad, N.T.; El-Faroug, M.O. short-term forecasting for energy consumption through stacking heterogeneous ensemble learning model. *Energies* **2018**, *11*, 1605. [[CrossRef](#)]
13. Chang, H.; Sun, W.; Gu, X. Forecasting energy CO<sub>2</sub> emissions using a quantum harmony search algorithm-based DMSFE combination model. *Energies* **2013**, *6*, 1456–1477. [[CrossRef](#)]
14. Zeng, S.; Xu, Y.; Wang, L.; Chen, J.; Li, Q. Forecasting the allocative efficiency of carbon emission allowance financial assets in China at the provincial level in 2020. *Energies* **2016**, *9*, 329. [[CrossRef](#)]
15. Liang, Y.; Niu, D.; Wang, H.; Chen, H. Assessment analysis and forecasting for security early warning of energy consumption carbon emissions in Hebei Province, China. *Energies* **2017**, *10*, 391. [[CrossRef](#)]
16. Prakash, A.K.; Xu, S.; Rajagopal, R.; Noh, H.Y. Robust Building energy load forecasting using physically-based kernel models. *Energies* **2018**, *11*, 862. [[CrossRef](#)]
17. Mehedintu, A.; Sterpu, M.; Soava, G. Estimation and forecasts for the share of renewable energy consumption in final energy consumption by 2020 in the European Union. *Sustainability* **2018**, *10*, 1515. [[CrossRef](#)]
18. Liang, Y.; Niu, D.; Cao, Y.; Hong, W.C. Analysis and modeling for China's electricity demand forecasting using a hybrid method based on multiple regression and extreme learning machine: A view from carbon emission. *Energies* **2016**, *9*, 941. [[CrossRef](#)]
19. Zhai, S.; Wang, Z. The prediction of carbon emissions demands in India under the balance economic growth path. *Smart Grid Renew. Energy* **2012**, *3*, 186–193. [[CrossRef](#)]
20. Zeng, S.; Chen, J. Forecasting the allocation ratio of carbon emission allowance currency for 2020 and 2030 in China. *Sustainability* **2016**, *8*, 650. [[CrossRef](#)]
21. Zhou, J.; Yu, X.; Guang, F.; Li, W. Analyzing and predicting CO<sub>2</sub> emissions in China based on the LMDI and GA-SVM model. *Pol. J. Environ. Stud.* **2018**, *27*, 927–938. [[CrossRef](#)]
22. Xu, W.; Gu, R.; Liu, Y.; Dai, Y. Forecasting energy consumption using a new GM-ARMA model based on HP filter: The case of Guangdong Province of China. *Econ. Modell.* **2015**, *45*, 127–135. [[CrossRef](#)]
23. Zhao, E.; Zhao, J.; Liu, L.; Su, Z.; An, N. Hybrid wind speed prediction sased on a self-adaptive ARIMAX model with an exogenous WRF simulation. *Energies* **2016**, *9*, 7. [[CrossRef](#)]
24. Souza, D.; Christo, E.; Almeida, A. Location of faults in power transmission lines using the ARIMA method. *Energies* **2017**, *10*, 1596. [[CrossRef](#)]
25. Farias, R.L.; Puig, V.; Rangel, H.R.; Flores, J.J. Multi-model prediction for demand forecast in water distribution networks. *Energies* **2018**, *11*, 660. [[CrossRef](#)]
26. Chen, L.; Xu, L.; Zhou, Y. Novel approach for lithium-ion battery on-line remaining useful life prediction based on permutation entropy. *Energies* **2018**, *11*, 820. [[CrossRef](#)]
27. Yang, E.; Park, H.W.; Choi, Y.H.; Kim, J.; Munkhdalai, L.; Musa, I.; Ryu, K.H. A simulation-based study on the comparison of statistical and time series forecasting methods for early detection of infectious disease outbreaks. *Int. J. Environ. Res. Public Health* **2018**, *15*, 2178. [[CrossRef](#)] [[PubMed](#)]
28. Kahsai, M.S.; Nondo, C.; Schaeffer, P.V.; Gebremedhin, T.G. Does level of income matter in the energy consumption and GDP Nexus: Evidence from Sub-Saharan African countries. *Energy Econ.* **2012**, *34*, 739–746. [[CrossRef](#)]
29. Xin, J.; Zhou, J.; Yang, S.X.; Li, X.; Wang, Y. Bridge structure deformation prediction based on GNSS data using Kalman-ARIMA-GARCH model. *Sensors* **2018**, *18*, 298. [[CrossRef](#)] [[PubMed](#)]
30. Li, S.; Yang, X.; Li, R. Forecasting China's coal power installed capacity: A comparison of MGM, ARIMA, GM-ARIMA, and NMGM models. *Sustainability* **2018**, *10*, 506. [[CrossRef](#)]



31. Kurecic, P.; Kokotovic, F. The relevance of political stability on FDI: A VAR analysis and ARDL models for selected small, developed, and instability threatened economies. *Economies* **2017**, *5*, 22. [[CrossRef](#)]
32. Li, R.; Su, M. The role of natural gas and renewable energy in curbing carbon emission: Case study of the United States. *Sustainability* **2017**, *9*, 600. [[CrossRef](#)]
33. Dai, S.; Niu, D.; Han, Y. Forecasting of Energy-Related CO<sub>2</sub> emission in China based on GM (1,1) and Least Squared Support Leaping Vector Machine Optimized by Modified Shuffled Frog Leaping Algorithm for Sustainability. *Sustainability* **2018**, *10*, 958. [[CrossRef](#)]
34. Jiang, F.; Yang, X.; Li, S. Comparison of Forecasting India's energy demand using an MGM, ARIMA model, MGM-ARIMA model, and BP Neural Network model. *Sustainability* **2018**, *10*, 2225. [[CrossRef](#)]
35. Johansen, S. *Likelihood-Based Inference in Cointegrated Vector Autoregressive Models*; Oxford University Press: New York, NY, USA, 1995.
36. MacKinnon, J. *Critical Values for Cointegration Test in Long-Run Economic Relationships*; Engle, R., Granger, C., Eds.; Oxford University Press: Oxford, UK, 1991.
37. Sims, C.A. Macroeconomics and Reality. *Econ. J. Econ. Soc.* **1980**, *48*, 1–48. [[CrossRef](#)]
38. Enders, W. *Applied Econometrics Time Series*; Wiley Series in Probability and Statistics; University of Alabama: Tuscaloosa, AL, USA, 2010.
39. Harvey, A.C. *Forecasting, Structural Time Series Models and the Kalman Filter*; Cambridge University Press: Cambridge, UK, 1989.



© 2018 by the authors. Licensee MDPI, Basel, Switzerland. This article is an open access article distributed under the terms and conditions of the Creative Commons Attribution (CC BY) license (<http://creativecommons.org/licenses/by/4.0/>).



Article

# The Optimal Carbon Reduction and Return Strategies under Carbon Tax Policy

Jia Wang <sup>1</sup> and Xijia Huang <sup>2,\*</sup>

<sup>1</sup> School of Tourism, Tourism Research Institute, Nanchang University, 999 Xuefu Avenue, Nanchang 330031, China; wangjia2014@ncu.edu.cn

<sup>2</sup> Jiangxi Development Research Institute, School of Tourism, Nanchang University, 999 Xuefu Avenue, Nanchang 330031, China

\* Correspondence: Jua.Wange@nau.edu; Tel.: +86-0791-83969108

Received: 21 June 2018; Accepted: 13 July 2018; Published: 14 July 2018

**Abstract:** Recently, consumers have been increasingly shopping due to the development of e-commerce; thus, many traditional firms producing green products are entering e-commerce platforms to sell products for their survival. In the contexts of online sales and carbon tax policy, firms need to determine an optimal carbon reduction level and online return strategies. To address firms' decision-making challenges, we consider a firm producing and selling its green products via an e-commerce platform. For optimal online return strategies, we find that if the residual value of the returned product is relatively small, the firm should not offer an online return service; otherwise, the firm should offer this service. Moreover, the results show that carbon tax policy is detrimental to the firm and consumers, while increasing the average customer satisfaction rate of the product benefits the firm and consumers. Interestingly, we find that the platform should reduce its referral fee as the unit carbon tax increases.

**Keywords:** carbon tax policy; return policy; carbon reduction; e-commerce platform

## 1. Introduction

In recent years, environmental pollution has attracted increasing attention from governments, firms and consumers. For instance, to curb carbon emissions, many countries such as Finland, Norway, Sweden, Denmark, the Netherlands, Germany, United Kingdom and Australia have enacted carbon tax policy [1]. In the context of a carbon tax policy, firms need to adopt green production technology to improve product carbon reduction levels [2–4]. Moreover, with the development of e-commerce, consumers are increasingly shopping online rather than shopping offline. A report shows that online sales in the USA in 2017 reached \$453.46 billion, which is an increase of 16% compared with that in 2016 [5]. In addition, some e-commerce giants such as Amazon.com and Tmall.com dominate the e-commerce market, and some firms, as third-party sellers, therefore sell their products on e-commerce platforms [6,7]. Compared with the case in the absence of online sales, a carbon tax policy taking online sales into account may have different effects on the competition between e-commerce platforms and third-party sellers and the optimal decisions of these members. Compared with the case in the absence of carbon tax policy, the competition between platforms and third-party sellers in the presence of a carbon tax policy may be stiff, and the optimal decisions of these members in the presence of a carbon tax policy may be changed. Thus, considering the case of a carbon tax policy and the fact that consumers are increasingly shopping online, firms producing green products and selling products via e-commerce platforms need to determine an optimal product price and product carbon reduction levels, and e-commerce platforms need to decide an optimal referral fee for firms per unit product sold. How does carbon tax policy affect the optimal product price, carbon reduction level and referral fee? These questions are worth studying.

Firms who sell their products online need to consider the online return problem. Many scholars have presented the fact that the online product return rate is much larger than the offline product return rate [8]. In this context, firms face the challenge of whether or not to offer online return services. Moreover, the psychological cost of consumers' waiting times for online shopping and shipping costs should be taken into account when addressing the problems of online strategies. It is important to note that our paper focuses on firms who produce and sell green products. If firms do not offer online return services, the firms offer free shipping services to consumers for online shopping, and consumers who buy products need to wait for the arrival of products. After buying products, some consumers find that the products are unfit for their use, but they cannot return these products, which certainly will reduce consumer utility. In the context of firms without online return services, the firms do not need to bear losses from returned products, but product demand may decline due to decreased consumer utility. In addition, if firms offer online return services, consumers can return their products but need to undertake the shipping cost of returned products. Considering that the product price is larger than the shipping cost, increased consumer utility improves product demand. However, the firms need to undertake losses from returned products. Thus, should firms offer online return services? How does carbon tax policy affect the optimal online return strategy? There is no previous research studying these questions; we are therefore addressing them here.

In our paper, we consider a firm producing and selling green products via an e-commerce platform. The government enacts a carbon tax policy in which the government taxes the firm for their per unit carbon emission. The firm is a third-party seller of the platform, and there is a Stackelberg game between the platform and the firm. According to the firm with and without an online return service, we develop two theoretical models: i.e., model NR (the firm without online return service) and model YR (the firm with online return service). The paper investigates the optimal product retail price, carbon reduction level, referral fee, the firm's profit and consumer surplus under the models NR and YR, respectively, and explores the optimal online return strategy for the firm. Some managerial insights are obtained, which serve firms to determine their optimal carbon reduction and return strategies and platforms to set an optimal referral fee.

The rest of our paper is arranged as follows. Section 2 presents related literature and the contributions of this paper. In Section 3, the problems of determining the optimal carbon reduction and return strategies under carbon tax policy have been described, and consumer utility functions, product demand functions and cost structures have been proposed. Two theoretical models (i.e., models NR and YR) are developed in Section 4, and we also present optimal solutions for the firm and the platform. Section 5 analyzes the optimal return strategy and presents some other results. In Section 6, managerial insights are concluded. Finally, the Appendix presents the proofs.

## **2. Literature Review**

The paper investigates optimal carbon reduction and online return strategies of a firm selling on an e-commerce platform under a carbon tax policy. Thus, the related literature can be divided into two streams, i.e., the research on carbon tax policy and the research on return strategies.

The first stream investigates operational and optimization problems considering carbon tax policy. Some scholars have examined optimal carbon tax policy. In the last century, Poterba [9] investigated the design and implementation of a carbon tax policy which can be used to curb carbon emissions. Then, Roughgarden and Schneider [10] have taken the uncertainties of climatic effects into account to get an optimal carbon tax via developing a dynamic integrated climate-economy model and show that the optimal carbon tax policy considering most of these alternate damage estimates is more aggressive than that considering a single damage function. Metcalf [11] designed a carbon tax policy to reduce U.S. greenhouse gas emissions and provides a distributional analysis of a neutral approach. Zhou et al. [12] explored an optimal carbon tax policy via maximizing the social welfare function and also take consumer environmental awareness into account. Besides optimal carbon tax policy, many scholars have studied the impacts of carbon tax policy on the optimal solutions of firms. Nordhaus [13]

developed a “DICE” model to investigate the optimal greenhouse-gas reductions under carbon tax policy. Goulder and Mathai [14] further studied carbon abatement considering induced technological change and found that the effect on the timing of abatement is analytically ambiguous when knowledge is generated via learning-by-doing. Chen and Hao [15] studied the impacts of carbon tax policy on the sustainable pricing and production policies of two competing firms and showed that a firm obtains a larger carbon emissions reduction percentage if they undertake a higher carbon tax. Yu and Han [16] investigated the impacts of carbon tax policy on product retail price and total carbon emission in a supply chain with a manufacturer and a retailer and designed two contracts to coordinate the supply chain. Wang et al. [17] studied the optimal production decisions of new and remanufactured products under carbon tax policy and found that manufacturers can offset the cannibalization and curb carbon emissions via adopting low-carbon emission technology.

The first stream mainly focuses on optimal carbon tax policy for governments and optimal decisions under carbon tax policy for firms. Although our paper takes carbon tax policy into account, our paper analyzes the impacts of carbon tax policy on firm’s optimal product price and carbon reduction level strategies and platforms’ optimal referral fees, which have not been studied before.

The second stream investigates return strategies. Return strategies analysis has sustained the interest of many scholars [18–20]. For instance, Lau and Lau [21] studied the optimal product price and return strategies of a manufacturer and showed that a shrewd manufacturer can use a return-credits agreement to earn more profits. Mukhopadhyay and Setoputro [22] designed a profit maximization model to investigate optimal return policy, and the results can serve firms to determine optimal decisions. In contrast to the traditional offline return policies, online return policies with the advent of e-commerce are increasingly receiving attention from firms and scholars. Mukhopadhyay and Setoputro [23] developed a theoretical model to investigate optimal product price and online return strategies. Li et al. [24] examined the relationships between return policy, product quality and pricing strategy in the context of online sales. Bower and Maxham [25] used two surveys and actual customer spending dates to indicate normative assumptions and the long-term consequences of fee and free returns and presented the idea that online retailers should offer either a free online return policy or a minimum fee return policy if they can determine consumers’ reactions to fee returns. Altug and Aydinliyim [26] studied how consumers’ discount-seeking purchase deferrals affect the return policy of online retailers and found that retailers in some conditions can gain a competitive advantage when selling to strategic consumers. Sahoo et al. [27] explored the impact of online product reviews on the optimal online return strategy and showed that unbiased online reviews benefit consumers and that biasing reviews upwards results in more returns.

The second stream studies offline return and online return policies from multiple backgrounds and perspectives. However, the online return policies of e-commerce platforms’ third-party sellers have not been studied, which is our contribution to the research. Moreover, the impacts of carbon tax policy and online return policy on carbon reduction level have also not been studied before, and these have been considered in our paper.

### **3. Problem Description**

We consider a firm who produces green products. The government enacts carbon tax policy, which means that the government charges the firm for their per unit carbon emission. Under this policy, the firm will improve its carbon emission reduction level to curb total emissions. Considering the online shopping habits of consumers, the firm sells its products via an e-commerce platform. The firm is a third-party seller of the platform and determines its product retail price and pays the referral fee to the platform per unit product sold. Moreover, the firm needs to choose whether or not to offer a return service, considering the relatively high online return rate. Based on a firm with and without online return services, our paper develops two corresponding models. To clarify our model, some notations are introduced in Table 1.

Table 1. Notations.

Notation	Description
$p$	Product retail price
$e$	Carbon emission reduction level
$f$	Referral fee
$e_l$	Initial unit carbon emission
$\alpha$	Average customer satisfaction rate of the product
$b$	Consumer's sensitivity to carbon emission reduction level
$c$	Unit production cost
$h_s$	Unit shipping cost
$h_w$	Psychological cost of consumer waiting times for online shopping
$v$	Unit residual value of returned product
$t$	Unit carbon tax
$\Pi_i$	The profit of the firm ( $i = F$ ) or the platform ( $i = P$ )

According to the firm's return strategies, there are two scenarios: one is a firm without an online return service (NR) and the other is a firm with an online return service (YR). Moreover, we use the superscripts NR and YR to represent the two scenarios in our paper. Note that if the average customer satisfaction rate is equal to 1, there are no consumer returns, which means that YR is identical with NR.

Cao et al. [28] investigated the optimal trade-in strategies of a retailer with online and offline sales channels and assumed that consumers are heterogeneous with respect to their valuation for a new product. Similar to them, we assume that consumers are heterogeneous with respect to their willingness-to-pay for the green product  $\phi$  which is a random variable with cumulative distribution function  $F(\phi)$ . To simplify our model, we assume that  $\phi$  is uniformly distributed on  $[0, 1]$ , and the market size is normalized to 1. Moreover, the psychological cost of consumer waiting for online shopping  $h_w$  is considered in our model.

Under the case of NR, the firm does not offer an online return service. The average customer satisfaction rate of the product is  $\alpha$ , which means that consumers with  $1 - \alpha$  percent will not be satisfied by the products which are purchased by them. We assume that if products are unfit for consumers, consumers under NR cannot obtain utility from these products. Thus, the utility function of consumers from online shopping is given as follows:

$$u^{NR} = \alpha(\phi - p + be - h_w) + (1 - \alpha)(-p - h_w) \quad (1)$$

If  $u^{NR} \geq 0$ , consumers will purchase green products from the firm. If setting  $u^{NR} = 0$ , we have  $\phi^{NR} = (p + h_w)/\alpha - be$ , which means that, for a consumer at point  $\phi^{NR}$ , there is no difference between purchasing a green product and not purchasing it. Thus, the product demand function under NR is

$$D^{NR} = \int_{\phi^{NR}}^1 dF(\phi) = [1 + be - (p + h_w)/\alpha] \quad (2)$$

Under the case of YR, the firm offers an online return service. If the products are unfit for consumers, consumers can return these products to obtain their paid prices but need to undertake the shipping costs of returned products. Thus, the utility function of consumers under YR from purchasing green products is

$$u^{YR} = \alpha(\phi - p + be - h_w) + (1 - \alpha)(-h_w - h_s) \quad (3)$$

if  $u^{YR} \geq 0$ , consumers will purchase green products from the firm. If we set  $u^{YR} = 0$ , we have  $\phi^{YR} = p - be + (h_w + h_s - \alpha h_s)/\alpha$ , which means that, for a consumer at point  $\phi^{YR}$ , there is no

difference between purchasing a green product and not purchasing it. Thus, the product demand function under YR is

$$D^{YR} = \int_{\phi^{YR}}^1 dF(\phi) = 1 - p + be - (h_w + h_s - \alpha h_s) / \alpha \tag{4}$$

Moreover, we assume that the total carbon emission is equal to  $(e_l - e)q$ , which can be supported by Cao et al. [29]. Thus, the firms should pay  $t(e_l - e)q$  to the government for its total carbon emission. Similar to Ji et al. [2], we assume that the carbon reduction cost is  $e^2/2$ . Besides this, we assume that the firm offers a free shipping service to consumers who purchase products.

E-commerce giants such as Amazon.com, JD.com, Tmall.com are dominating e-commerce markets; thus, there is a Stackelberg game between the firm and the platform, where the firm is the follower and the platform is the leader. We assume that the platform will not charge the firm the referral fee if the sold products are returned, which is in accordance with return policies of Amazon.com, JD.com etc.

**4. Theoretical Models**

In this section, there are two models: model NR (a firm without a return service) and model YR (a firm with a return service). The platform who is the leader needs to determine the referral fee  $f$ . The firm who is the follower needs to determine its product retail price  $p$  and carbon reduction level  $e$ .

**4.1. Model NR**

Under model NR, the firm does not offer an online return service. Thus, the problem of the firm under NR is described as follows:

$$\max \prod_F^{NR}(p, e) = D^{NR}[p - f - c - h_s - t(\bar{e} - e)] - e^2/2 \tag{5}$$

and the problem of the platform under NR is

$$\max \prod_P^{NR}(f) = D^{NR}f \tag{6}$$

The consumer surplus under NR is given as follows:

$$CS^{NR} = \int_{\phi^{NR}}^1 [\alpha(\phi - p + be - h_w) + (1 - \alpha)(-\phi - h_w)]dF(\phi) \tag{7}$$

By solving Equations (5) and (6) via backward induction, the optimal solutions under NR are easily obtained, which are presented in Table 2.

**Table 2.** The optimal solutions.

Models	The Optimal Solutions
NR	$p^{NR*} = \alpha[1 - (1 - bt - \alpha b^2)(\alpha - c - h_s - h_w - e_1t) / (2A)] - h_w;$ $e^{NR*} = (t + \alpha b)(\alpha - c - h_s - h_w - e_1t) / (2A);$ $f^{NR*} = (\alpha - c - h_s - h_w - e_1t) / 2;$ where $A = 2\alpha - \alpha^2 b^2 - 2\alpha bt - t^2.$
YR	$p^{YR*} = 1 - (1 - bt - \alpha b^2)(\alpha + v + \alpha h_s - c - 2h_s - h_w - \alpha v - e_1t) / (2A) - (h_w + h_s - \alpha h_s) / \alpha;$ $e^{YR*} = (t + \alpha b)(\alpha + v + \alpha h_s - c - 2h_s - h_w - \alpha v - e_1t) / (2A);$ $f^{YR*} = (\alpha + v + \alpha h_s - c - 2h_s - h_w - \alpha v - e_1t) / (2\alpha).$

**4.2. Model YR**

Under YR, the firm offers an online return service. Thus, the problem of the firm under YR is

$$\max \prod_F^{YR}(p, e) = D^{YR}[\alpha(p - f) + (1 - \alpha)v - c - h_s - t(\bar{e} - e)] - e^2/2 \tag{8}$$

and the problem of the platform is

$$\max \prod_P^{YR}(f) = \alpha Df \tag{9}$$

The consumer surplus under YR is given as follows:

$$CS^{YR} = \int_{\phi^{YR}}^1 [\alpha(\phi - p + be - h_w) + (1 - \alpha)(-h_w - h_s)]dF(\phi) \tag{10}$$

By solving Equations (8) and (9) via backward induction, the optimal solutions under NR are easily obtained, which are also presented in Table 2 above.

### 5. The Results and Analyses

In this section, we present the optimal return strategy of the firm and analyze the optimal product retail price, carbon reduction level, referral fee, the optimal profits of the firm and the platform and optimal consumer surplus.

In the contexts of carbon tax policy and online sales, how does the firm determine its online return strategy? The following Theorem answers this question.

**Theorem 1.** *The optimal return strategy depends on the magnitudes of the unit shipping cost and residual value of returned product, i.e.,*

- (a) if  $0 \leq v < h_s$ , we have  $\prod_F^{NR*} > \prod_F^{YR*}$ ;
- (b) and if  $v \geq h_s$ , we have  $\prod_F^{NR*} \leq \prod_F^{YR*}$ .

Theorem 1 shows that, if the residual value of the returned product is less (larger) than a threshold, the firm under NR has a larger (lower) profit than that under YR. A relatively small residual value of returned product means that the firm would undertake a huge loss from returned products. Although offering an online return service can entice more consumers to purchase products, the firm will not choose to offer an online return service considering the possible huge losses from returned products. However, if the residual value of returned product is relatively large, the firm only needs to bear a small loss from returned products. A firm which offers an online return service can thereby entice more consumers to purchase green products. Thus, in this context, the firm will choose to offer return service to pursue maximal profits.

Additionally, the conditions  $0 \leq v < h_s$  and  $v \geq h_s$  also mean that the unit shipping cost is larger and less than a threshold value. If the unit shipping cost is larger than the threshold, consumers who want to return their products need to undertake a huge cost, which reduces consumer utility from purchasing products. Thus, in the context of a relatively large unit shipping cost, if the firm offers an online return service, product demand increases slightly, but the firm will bear losses from returned products. Thus, the firm will not choose to offer an online service and vice versa.

Theorem 1 implies that, if the residual value of the returned product is relatively small, the firm should not offer an online return service; otherwise, the firm should offer an online return service. In other words, if the unit shipping cost is relatively large, the firm should not offer an online return service; otherwise, the firm should offer it.

Besides the impact of the return service on the firm’s profit, the impact of the return service on consumer surplus is also necessary to investigate, and is given in the following Theorem.

**Theorem 2.** *The impact of the online return service on consumer surplus is presented as follows:*

- (a) if  $0 \leq v < h_s$ , we have  $CS^{NR*} > CS^{YR*}$ ;
- (b) and if  $v \geq h_s$ , we have  $CS^{NR*} \leq CS^{YR*}$ .

Theorem 2 shows that, if the residual value of the returned product is less (larger) than a threshold, consumer surplus under model NR is larger (less) than that under model YR. In the context of a

relatively small residual value, a firm with an online return service has no motivation to entice consumers to buy green products, thus consumers under model YR obtain less utility than that under model NR. Otherwise, if the residual value of the returned product is relatively large, a firm with an online return service has motivation to entice more consumers, and thus consumers under model YR obtains more utility than that under model NR.

Theorem 2 implies that, if the residual value of the returned product is relatively small (large), the online return service harms (benefits) consumers. Moreover, combining Theorem 1 and Theorem 2, we find that a firm's optimal return strategy harms consumers.

The firm's online return strategy may affect the optimal product price, the optimal carbon reduction level and the optimal referral fee. To investigate the impacts, we present the following propositions.

**Proposition 1.** *The impacts of an online return strategy on the optimal product retail price is given as follows: if  $0 \leq v < \bar{v}$ , we have  $p^{NR*} < p^{YR*}$ ; otherwise, we have  $p^{NR*} \geq p^{YR*}$ , where  $\bar{v} = 3\alpha + c + e_1t - 3h_w + [2(t^2 - \alpha^2b^2)(\alpha - h_s - h_w) + 2\alpha h_s(1 - \alpha b^2 - bt)] / (\alpha^2b^2 + tab - \alpha)$ .*

Proposition 1 shows that, if the residual value of the returned product is less (larger) than a threshold, the firm under model NR should set a lower (higher) product retail price than that under model YR. If the residual value of the returned product is relatively small, the firm will undertake a huge loss from returned products, and thus a firm with an online return service will set a higher product retail price than that without an online return service to make up for the loss from returned products. Otherwise, the firm only bears a little loss from returned products, and thus a firm with an online return service will set a lower product retail price than that without an online return service to entice more consumers.

Proposition 1 implies that, if the residual value of the returned product is relatively small (large), a firm with an online return service compared to that without a return service should set a higher (lower) product retail price.

**Proposition 2.** *The impacts of an online return strategy on the optimal carbon reduction level is given as follows: if  $0 \leq v < h_s$ , we have  $e^{NR*} > e^{YR*}$ ; otherwise, we have  $e^{NR*} \leq e^{YR*}$ .*

Proposition 2 shows that, if the residual value of the returned product is less (larger) than the unit shipping cost, the optimal carbon reduction level under NR is larger (less) than that under YR. In the context of a relatively small residual value, a firm with an online return service compared with that without an online return service has no motivation to improve carbon reduction levels considering the huge loss from returned products. Otherwise, a relatively large residual value entices a firm with an online return service to improve its carbon reduction level to entice more consumers.

Proposition 2 implies that, if the residual value of the returned product is relatively small (large), a firm with a return service compared with that without a return service should reduce (improve) its carbon reduction level.

**Proposition 3.** *The impacts of online return strategy on the optimal referral is given as follows: if  $0 \leq v < 2h_s + c + h_w + e_1t - \alpha$ , we have  $f^{NR*} > f^{YR*}$ ; otherwise, we have  $f^{NR*} \leq f^{YR*}$ .*

Proposition 3 shows that, if the residual value of the returned product is less (larger) than a threshold, the optimal referral fee under model NR is larger (less) than that under model YR. In the context of a relatively small residual value of returned product, a firm with an online return service undertakes huge losses from these returned products, and thus the platform should reduce the referral fee to entice the firm to adjust its product retail price, which affects consumers choices. Otherwise, a firm offering a return service can obtain more profits from increased demands, and thus the platform should improve its referral fee to obtain more profit.

Proposition 3 implies that, if the residual value is relatively small (large), the platform under model YR compared with that under model NR should reduce (increase) its referral fee.

From Table 2, it is easy to find that the unit carbon tax and average customer satisfaction rate of the product affect the optimal solutions, profits and consumer surplus. To investigate these impacts, we develop two numerical examples.

In the first numerical example, we set  $\alpha = 0.8$ ,  $b = 0.1$ ,  $c = 0.2$ ,  $h_s = 0.05$ ,  $v = 0.1$ ,  $e_I = 0.3$ ,  $h_w = 0.05$ , and vary  $t$  from 0 to 0.1. The impacts of unit carbon tax on the optimal solutions, profits and consumer surplus are depicted in following figures.

From Figures 1–5, we find that the optimal product retail price and carbon reduction level increase with unit carbon tax. As unit carbon tax increases, the firm should improve carbon reduction levels to reduce carbon emission costs and also should increase their product retail price to earn profit. Moreover, it is demonstrated that with the optimal referral fee, the firm’s profit and consumer surplus decrease with unit carbon tax. As unit carbon tax increases, the firm will increase their product retail price, which will reduce consumers’ willingness-to-pay. Thus, the platform will reduce its referral fee to entice more consumers to buy products indirectly. Furthermore, it is intuitive that increased carbon tax has negative effects on the firm’s profit and consumer surplus.

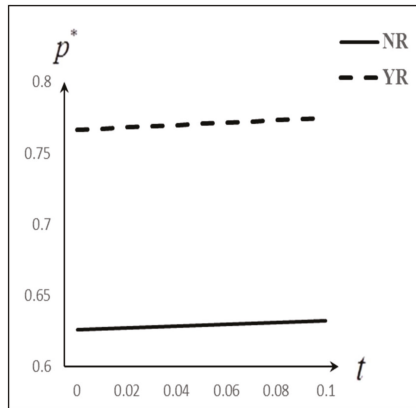

Figure 1. The optimal  $p^*$  with respect to  $t$ .

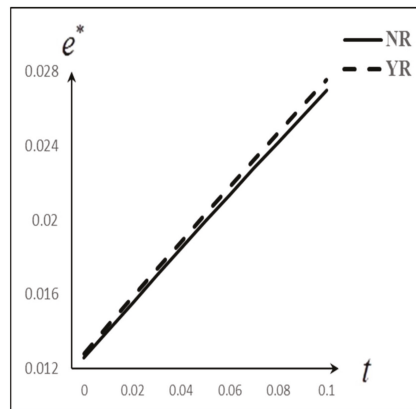

Figure 2. The optimal  $e^*$  with respect to  $t$ .



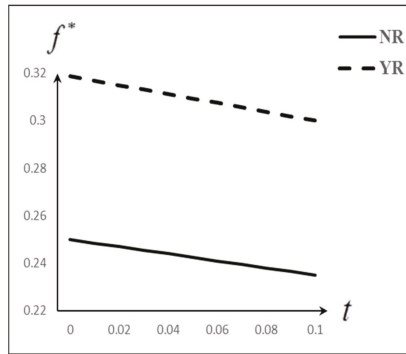

Figure 3. The optimal  $f^*$  with respect to  $t$ .

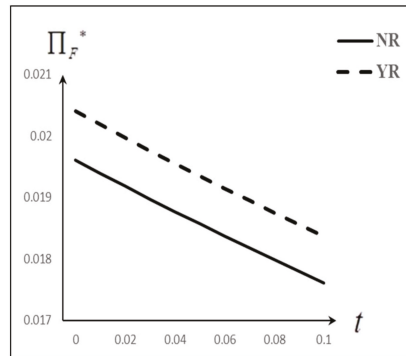

Figure 4. The optimal  $\Pi_F^*$  with respect to  $t$ .

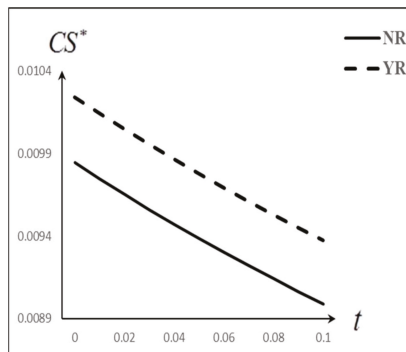

Figure 5. The optimal  $CS^*$  with respect to  $t$ .

Figures 1–5 imply that carbon tax policy harms the firm and consumers, and that the platform should reduce its referral fee as the unit carbon tax increases.

In the second numerical example, we set  $t = 0.05$ ,  $b = 0.1$ ,  $c = 0.2$ ,  $h_s = 0.05$ ,  $v = 0.1$ ,  $e_I = 0.3$ ,  $h_w = 0.05$ , and vary  $\alpha$  from 0.6 to 1. The impacts of the average customer satisfaction rate of the product on the optimal solutions, profits and consumer surplus are depicted in following figures.

From Figures 6–10, we can observe that the optimal product retail price, carbon reduction level, referral fee, the firm’s profit and consumer surplus increase with the average customer satisfaction rate of the product. As the average customer satisfaction rate of the product increases, a consumer’s utility from purchasing a product increases, which increases product demand. In this context, a firm can increase their product retail price to earn more unit profit, and the platform can increase their referral fee to earn more transaction profit from the firm. Moreover, the firm has more motivation to improve carbon reduction levels to entice more consumers to buy products.

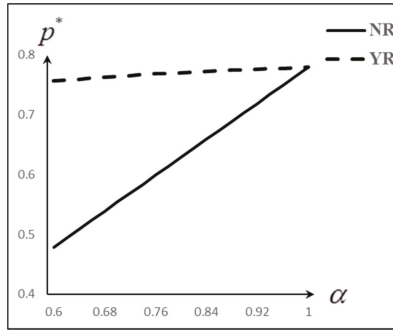

Figure 6. The optimal  $p^*$  with respect to  $\alpha$ .

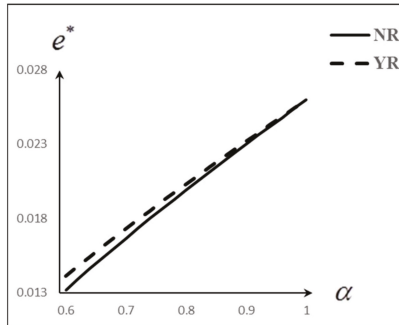

Figure 7. The optimal  $e^*$  with respect to  $\alpha$ .

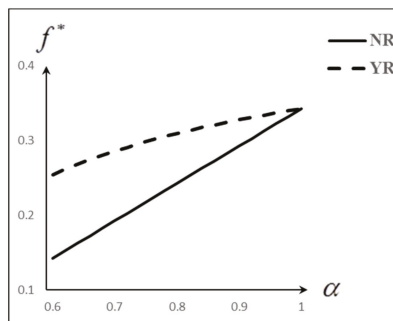

Figure 8. The optimal  $f^*$  with respect to  $\alpha$ .

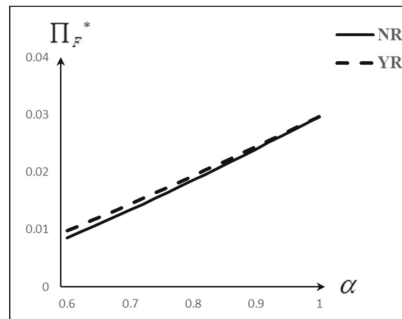

Figure 9. The optimal  $\Pi_F^*$  with respect to  $\alpha$ .

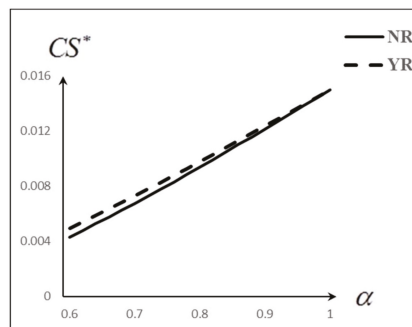

Figure 10. The optimal  $CS^*$  with respect to  $\alpha$ .

Figures 6–10 imply that the increased average customer satisfaction rate of the product benefits the firm, consumers and the environment.

## 6. Conclusions

With the development of e-commerce, consumers' consumption habits have changed from offline shopping to online shopping. Some e-commerce giants such as Amazon.com, Tmall.com, JD.com dominate the e-commerce market. In these contexts, a few firms who produce green products under carbon tax policy sell their products on e-commerce platforms. Considering the relatively high online return rate, third-party sellers face the choices of whether or not to offer online return services. To help these third-party sellers to determine optimal strategies, this paper considers a firm producing and selling its product via an e-commerce platform. According to a firm with and without an online return service, we develop two theoretical models: i.e., model NR (a firm without a return service) and model YR (a firm with a return service). The paper investigates the optimal product retail prices, carbon reduction levels, referral fees, the firm's profits and consumer surpluses under models NR and YR, respectively; some managerial insights are presented as follows.

**The optimal return strategy:** a firm should not offer an online return service if the residual value of the returned product is relatively small; otherwise, the firm should offer it. Moreover, the optimal return strategy of the firm harms consumers.

**The impacts of online return service:** if the residual value of the returned product is relatively small (large), a firm will offer an online return service which harms (benefits) consumers. Moreover, if the residual value is relatively small (large), a firm with an online return service compared with

that without a return service should increase (reduce) its product retail price and reduce (increase) its carbon reduction level while the platform should reduce (increase) its referral fee.

**The impacts of carbon tax policy:** Carbon tax policy harms the firm and consumers. Moreover, carbon tax policy has positive effects on the optimal product retail price and carbon reduction level while it has a negative effect on the optimal referral fee.

**The impacts of the average customer satisfaction rate of the product:** Improved average customer satisfaction rate of the product benefits the firm and consumers. Moreover, as the satisfaction rate increases, the firm should increase its product retail price and carbon reduction level and the platform should increase its referral fee.

There is still much space for future research. In our paper, we only consider a firm in the context of non-competition; thus, considering carbon reduction and return strategies in the context of competition is a future research direction. In addition, we assume that consumers need to undertake the shipping cost of returned products. Thus, it is interesting to investigate our problems if the firm undertakes the shipping cost of returned products. The paper hypothesizes that the unit carbon tax is an exogenous variable; thus, exploring the optimal carbon tax for the government via maximizing social welfare will be an extension of this study.

**Author Contributions:** J.W. analyzed the problems of determining optimal reduction and return strategies for firms by developing theoretical models, and she also wrote the draft of this paper. X.H. revised the written draft and provided theoretical and technical guidance for this paper.

**Acknowledgments:** This research is partly supported by the National Social Science Foundation of China (Grant No. 16CGL024) and the College of Humanities and Social Science Research Base Project of Jiangxi Province (2016) (Grant No. JD16150).

**Conflicts of Interest:** The authors declare no conflicts of interest.

## Appendix A

**The Proof of Theorem 1.** Based on Table 2 and Equations (5) and (8), we can figure out the optimal profit of the firm under models NR and YR, which are given as follows:

$$\prod_F^{NR*} = (a - c - h_s - h_w - e_{1t})^2 / (8A) \tag{A1}$$

$$\prod_F^{YR*} = (a + v + \alpha h_s - c - 2h_s - h_w - \alpha v - e_{1t})^2 / (8A) \tag{A2}$$

Comparing the size relationship between the two profits, we have

$$\prod_F^{YR*} - \prod_F^{NR*} = (v - h_s)(1 - \alpha)(2a + v + \alpha h_s - 2c - 3h_s - 2h_w - \alpha v - 2e_{1t}) / (8A) \tag{A3}$$

It is easy to verify that, if  $0 \leq v < h_s$ , we have  $\prod_F^{YR*} - \prod_F^{NR*} < 0$ ; otherwise,  $\prod_F^{YR*} - \prod_F^{NR*} \geq 0$ . □

**The Proof of Theorem 2.** Based on Table 2 and Equations (7) and (10), we can figure out the optimal consumer surplus under models NR and YR, which can be presented as follows:

$$CS^{NR*} = \alpha(a - c - h_s - h_w - e_{1t})^2 / (8A^2) \tag{A4}$$

$$CS^{YR*} = \alpha(a + v + \alpha h_s - c - 2h_s - h_w - \alpha v - e_{1t})^2 / (8A^2) \tag{A5}$$

Comparing the size relationship between the two optimal consumer surplus, we have

$$CS^{YR*} - CS^{NR*} = \alpha(v - h_s)(1 - \alpha)(2a + v + \alpha h_s - 2c - 3h_s - 2h_w - \alpha v - 2e_{1t}) / (8A^2) \tag{A6}$$

It is easy to verify that, if  $0 \leq v < h_s$ , we have  $CS^{YR*} - CS^{NR*} < 0$ ; otherwise,  $CS^{YR*} - CS^{NR*} \geq 0$ . □

## References

1. Gale, W.; Brown, S.; Saltiel, F.; Center, U.B.T.P. *Carbon Taxes as Part of the Fiscal Solution*; Brookings Institution: Washington, DC, USA, 2013.
2. Ji, J.; Zhang, Z.; Yang, L. Carbon emission reduction decisions in the retail-/dual-channel supply chain with consumers' preference. *J. Clean. Prod.* **2017**, *141*, 852–867. [[CrossRef](#)]
3. Ji, S.; Zhao, D.; Peng, X. Joint Decisions on Emission Reduction and Inventory Replenishment with Overconfidence and Low-Carbon Preference. *Sustainability* **2018**, *10*, 1119.
4. Yi, Y.; Li, J. Cost-sharing contracts for energy saving and emissions reduction of a supply chain under the conditions of government subsidies and a carbon tax. *Sustainability* **2018**, *10*, 895.
5. U.S. Census Bureau. Quarterly Retail E-Commerce Sales 4th Quarter 2017. Available online: [https://www.census.gov/retail/mrts/www/data/pdf/ec\\_current.pdf](https://www.census.gov/retail/mrts/www/data/pdf/ec_current.pdf) (accessed on 20 January 2018).
6. Cao, K.; He, P. The competition between B2C platform and third-party seller considering sales effort. *Kybernetes* **2016**, *45*, 1084–1108. [[CrossRef](#)]
7. Cao, K.; Xu, X.; Bian, Y.; Sun, Y. Optimal trade-in strategy of business-to-consumer platform with dual-format retailing model. *Omega-Int. J. Manag. Sci.* **2018**. [[CrossRef](#)]
8. Vlachos, D.; Dekker, R. Return handling options and order quantities for single period products. *Eur. J. Oper. Res.* **2003**, *151*, 38–52. [[CrossRef](#)]
9. Poterba, J.M. Tax policy to combat global warming: On designing a carbon tax (No. w3649). *Natl. Bur. Econ. Res.* **1991**. [[CrossRef](#)]
10. Roughgarden, T.; Schneider, S.H. Climate change policy: Quantifying uncertainties for damages and optimal carbon taxes. *Energy Policy* **1999**, *27*, 415–429. [[CrossRef](#)]
11. Metcalf, G.E. Designing a carbon tax to reduce US greenhouse gas emissions. *Rev. Environ. Econ. Policy* **2009**, *3*, 63–83. [[CrossRef](#)]
12. Zhou, Y.; Hu, F.; Zhou, Z. Pricing decisions and social welfare in a supply chain with multiple competing retailers and carbon tax policy. *J. Clean. Prod.* **2018**, *190*, 752–777. [[CrossRef](#)]
13. Nordhaus, W.D. Optimal greenhouse-gas reductions and tax policy in the “DICE” model. *Am. Econ. Rev.* **1993**, *83*, 313–317.
14. Goulder, L.H.; Mathai, K. Optimal CO<sub>2</sub> abatement in the presence of induced technological change. *J. Environ. Econ. Manag.* **2000**, *39*, 1–38. [[CrossRef](#)]
15. Chen, X.; Hao, G. Sustainable pricing and production policies for two competing firms with carbon emissions tax. *Int. J. Prod. Res.* **2015**, *53*, 6408–6420. [[CrossRef](#)]
16. Yu, W.; Han, R. Coordinating a two-echelon supply chain under carbon tax. *Sustainability* **2017**, *9*, 2360. [[CrossRef](#)]
17. Wang, X.; Zhu, Y.; Sun, H.; Jia, F. Production decisions of new and remanufactured products: Implications for low carbon emission economy. *J. Clean. Prod.* **2018**, *171*, 1225–1243. [[CrossRef](#)]
18. Bettis, R.A.; Hall, W.K. Diversification strategy, accounting determined risk, and accounting determined return. *Acad. Manag. J.* **1982**, *25*, 254–264.
19. Rust, R.T.; Lemon, K.N.; Zeithaml, V.A. Return on marketing: Using customer equity to focus marketing strategy. *J. Mark.* **2004**, *68*, 109–127. [[CrossRef](#)]
20. Hsieh, C.C.; Lu, Y.T. Manufacturer's return policy in a two-stage supply chain with two risk-averse retailers and random demand. *Eur. J. Oper. Res.* **2010**, *207*, 514–523. [[CrossRef](#)]
21. Lau, H.S.; Lau, A.H.L. Manufacturer's pricing strategy and return policy for a single-period commodity. *Eur. J. Oper. Res.* **1999**, *116*, 291–304. [[CrossRef](#)]
22. Mukhopadhyay, S.K.; Setoputro, R. Optimal return policy and modular design for build-to-order products. *J. Oper. Manag.* **2005**, *23*, 496–506. [[CrossRef](#)]
23. Mukhopadhyay, S.K.; Setoputro, R. Reverse logistics in e-business: Optimal price and return policy. *Int. J. Phys. Distrib. Logist. Manag.* **2004**, *34*, 70–89. [[CrossRef](#)]
24. Li, Y.; Xu, L.; Li, D. Examining relationships between the return policy, product quality, and pricing strategy in online direct selling. *Int. J. Prod. Econ.* **2013**, *144*, 451–460. [[CrossRef](#)]
25. Bower, A.B.; Maxham, J.G., III. Return shipping policies of online retailers: Normative assumptions and the long-term consequences of fee and free returns. *J. Mark.* **2012**, *76*, 110–124. [[CrossRef](#)]

26. Altug, M.S.; Aydinliyim, T. Counteracting strategic purchase deferrals: The impact of online retailers' return policy decisions. *Manuf. Serv. Oper. Manag.* **2016**, *18*, 376–392. [[CrossRef](#)]
27. Sahoo, N.; Dellarocas, C.; Srinivasan, S. The impact of online product reviews on product returns. *Inf. Syst. Res.* **2018**. [[CrossRef](#)]
28. Cao, K.; Wang, J.; Dou, G.; Zhang, Q. Optimal trade-in strategy of retailers with online and offline sales channels. *Comput. Ind. Eng.* **2018**. [[CrossRef](#)]
29. Cao, K.; Xu, X.; Wu, Q.; Zhang, Q. Optimal production and carbon emission reduction level under cap-and-trade and low carbon subsidy policies. *J. Clean. Prod.* **2017**, *167*, 505–513. [[CrossRef](#)]



© 2018 by the authors. Licensee MDPI, Basel, Switzerland. This article is an open access article distributed under the terms and conditions of the Creative Commons Attribution (CC BY) license (<http://creativecommons.org/licenses/by/4.0/>).

Article

# Computer-Based Analysis of the Stochastic Stability of Mechanical Structures Driven by White and Colored Noise

Aydin Azizi

Department of Engineering, German University of Technology in Oman, Muscat, PC 130, Oman; aydin.azizi@gutech.edu.om

Received: 4 August 2018; Accepted: 22 September 2018; Published: 25 September 2018

**Abstract:** The goal of this paper is to design an effective Proportional Integral Derivative (PID) controller, which will control the active suspension system of a car, in order to eliminate the imposed vibration to the car from pavement. In this research, Gaussian white noise has been adopted to model the pavement condition, and MATLAB/Simulink software has been used to design a PID controller, as well as to model the effect of the white noise on active suspension system. The results show that the designed controller is effective in eliminating the effect of road conditions. This has a significant effect on reducing the fuel consumption and contributes to environment sustainability.

**Keywords:** fuel consumption; sustainability; active suspension; PID controller; white noise; colored noise

---

## 1. Introduction

### 1.1. Background

Efforts to optimize fuel consumption have driven and inspired various industries, including the automobile industry, to create a wealth of new inventions and technologies. Since the issue of global warming was brought into the spotlight, the mechanics of the automobile industry have evolved rapidly, due to the greenhouse gas emissions produced by internal combustion engines. The advancement of technology within the power industry have helped in reducing fuel consumption, as well as in the reduction of greenhouse gas emissions [1].

Greenhouse gases released by vehicles include carbon dioxide, carbon monoxide, nitrogen dioxide, ozone and methane, among others. The repercussions of burning fossil fuels amount to more than just a foul smell; the aftermath of these greenhouse gases impacts the health of humans, animals and plants alike, thus disturbing the environment and its inhabitants [2]. Within the environment, greenhouse gases disrupt the biogeochemical cycles that exist in nature resulting in problems, such as temperature rise, erosion, and droughts. One problem is the melting ice caps; even a minute temperature rise can result in rising water levels, which also increases the number of natural disasters occurring in various areas. A rise in water levels also promises depletion in land mass, due to water levels overflowing, and swallowing coastal areas. Furthermore, car emissions, along with many by-products of plants, cause the radiation from the sun to be trapped inside the Earth's atmosphere, resulting in the overall raising of the temperature. The aforementioned consequences develop into bigger problems, such as those which can already be observed in the La Nina and El Nino phenomena, and events in the Atlantic, as well as increased cyclone activity in the Indian Ocean [3].

Regarding the impact on humans, these greenhouse gases play an important role in the climate change that is affecting the entire globe (global warming), and may threaten the welfare of humans—physically and economically. For example, when ozone levels increase in lower elevations,

it can have a direct impact on human health, including harming the respiratory system. The economy can also be affected, because of individuals who suffer from health problems caused by these issues. Furthermore, as the automobile industry grows, the use of fossil fuels will grow exponentially, bringing closer the possibility of a future with no fossil fuels, which will result in the economic downfall of bigger entities such as countries. Other greenhouse gases, such as fluorinated gases, do not interfere directly with human health, but do hurt the environment greatly, and on different levels [4].

Due to the rate at which fossil fuels are used annually (11 billion tons of oil and four billion tons of crude oil, per annum), oil deposits on Earth are predicted to run out by 2052. Furthermore, compensating the energy deficit of the oil deposits through using natural gas will only extend the lifetime of fossil fuel energy by an additional eight years. After this, the only remaining form of fossil fuel energy left would be coal. To fill in the energy gap of both the oil and natural gas deposits, coal would be so extensive we run out of fossil fuels by the year of 2088 [5]. Fossil fuels have, thus far, been the main source of energy, but with the passing of time, different sources of energy alternatives have been developed to prevent the consequences that arise from using just fossil fuels. For instance, instead of having only internal combustion engine vehicles, there are a variety of eco-friendly vehicles available, which are being used instead. Some of these eco-friendly energy sources include electronically powered vehicles, hybrid vehicles (using more than one source of energy), compressed air, etc. [6]. There are many of problems that come with the use of fossil fuels, out of which the issues with the greatest impact are its scarcity and the cost it imposes on the planet. Fossil fuels are the only plausible option for many vital functions and processes; the most important of these is transportation. Therefore, using this source of energy wisely and as efficiently as possible is a must [7].

## *1.2. Factors Effecting Fuel Efficiency*

Fuel efficiency can be described as how well the chemical energy of the fuel in question is converted into kinetic energy, in terms of powertrains. Fuel efficiency varies according to several factors, including the application, the size of the vehicle, the vehicles design, power, engine parameters, and many others. Factors that affect fuel consumption are design-related, environment-related, and motorist driving strategy-related factors. Together, and individually, these factors determine how much energy needs to move the vehicle [8,9].

### *1.2.1. Vehicle Design Factors*

To design a vehicle with the lowest fuel consumption rate (irrespective of the energy source) is one of the main goals of modern car manufacturers. Car manufacturers have expended great effort on developing, and successfully applying, different approaches to a vehicle's design (especially the vehicle's size) in order to reduce its fuel consumption, as well as the harmful gases emitted. There are several parameters falling under this design category, including the aerodynamic drag, engine parameters, rolling resistance, load, and fuel type. The size of the engine refers to how much fuel can be pumped into the engine, in order to be burned and converted into energy. Meaning, the larger the capacity of the engine, the more power the car has (although that over simplifies the concept). When a car has an engine with a capacity of two liters for instance, this means that the total amount of fuel that can fit into the cylinders is two liters, regardless of the number of cylinders. That power is measured in horse power, or brake horse power [10,11].

In terms of fuel efficiency, a bigger engine does not always mean worse fuel economy. For instance, a car with a larger engine running at a high speed for a long time will use less fuel than a car with a smaller engine running at the same speed for the same length of time. Furthermore, considering recent technology, it is now made possible for a large engine, of for example six cylinders, to use only three cylinders when that is all that is needed, therefore greatly boosting fuel efficiency [12].

The aerodynamic aspect of design is concerned with improving the cars exterior to better tackle drag, and to cause lower resistance at higher speeds. At a speed of 50 km/h, the power needed from



the engine to overcome air friction is not more than 40% of the engine's power, yet when it comes to speeds greater than 80–90 km/h, the power needed increases to 60%, and more of the engine's power. This is due to drag increasing proportionally to the square of the speed, and the power needed is proportional to the cube of the speed [13].

Rolling resistance, or rolling friction, is the resistance against the motion of a tire when rolling on a certain surface. Three forms of rolling resistance are in question, namely; permanent deformation, hysteresis losses, and slippage between the surface and the tire. Interestingly, a worn-out tire gives lower rolling resistance than a new one, due to the depth of the tread on the tire and its friction inducing properties—which in turn, leads to lower fuel consumption. Hysteresis losses are the main reason for rolling friction. Because tires are made of a deformable material, the tire is subject to repeated cycles of deformation and recovery, there is energy dissipated as heat. The energy is lost basically when the energy of healing/recovery is less than that of the deformation. Because of rubber's properties, it does not recover or heal over a short period of time—it needs a longer time. Some manufacturers include silicone in the tread of the tires to cut down on the time needed for the tire to recover, and hopefully cut down on the lost energy rates [14,15].

Fuel type also influences fuel consumption. A diesel engine delivers better fuel economy for several reasons—the main reason being that diesel contains higher energy content than gasoline. However, that does not mean it affects performance in terms of speed—it instead delivers more power and torque, which is why most trucks have diesel engines. When comparing a diesel engine to a gasoline engine, the difference in fuel economy shows the diesel engines to be 25–30% more fuel economic, and in some cases, up to 40% more economic. The obvious cut back to using a diesel engine is speed in terms of performance, on the other hand, when compared to a gasoline engine of the same size; more economic [16]. A diesel-powered engine is a very sophisticated one and, in a sense, more delicate than a gasoline powered engine. For example, if water somehow gets into the fuel tank (whether it is the suppliers fault or a combination of heavy rain and bad luck), it could lead to many problems, including the most obvious one—severe damage to the engine [17,18].

The load on the vehicle is another factor that affects fuel economy of car. When a vehicle is overloaded, the power it requires increases. This is because the engine will need to produce more power to move the vehicle at any given speed, in addition to the increased load on the tires, which in return, increases rolling resistance (which also increases fuel consumption) [19].

### 1.2.2. Environmental Factors

The weather and climate influence the fuel economy of cars—although not drastically. In the winter for example, the air is heavier and denser, therefore the air drag coefficient is larger. The tires experience a decrease in pressure which decreases fuel economy. Lubricants, wherever they may be, become cold and harder, and interfere with fuel economy, as well due to the increase in friction. In the summer however, the air is lighter and less dense, making it easier to navigate in contrast [20].

The terrain in which a car travels can influence its fuel consumption in a positive or negative manner. Rough terrain, ascents, slippery surfaces, sandy/muddy surfaces, and other types of terrain affect fuel consumption negatively. The opposite of these terrains can either not affect the fuel consumption or even affect it positively. For instance, climbing up a hill requires a significantly more power (which means burning more fuel), while descending a hill requires little or no fuel to be used [21].

Driving within a city uses much more petrol per km when compared to driving on a highway or in the country side. The reason for this that there are limitations and conditions that exist in the city, but not outside it or on the highway; such as traffic, speed bumps, more turns, pedestrians, etc. When driving in the city, the driver must use their brakes a greater number of times, decreasing fuel economy. Another active factor is the fact that in the city, the driver is forced to drive at lower speeds. Speeds lower than the optimum speed also affect fuel consumption, and significantly more when combined with the reasons mentioned. When driving on the highway or the countryside, the

limitations faced in the city are either not faced, or significantly lower. The vehicle is much more likely to be driven at optimum speeds, leading to a better fuel consumption rate [22–24].

### 1.3. Formulation of the Problem

One of the important factors which has a great influence on fuel consumption of transportation vehicles is pavement condition [25]. It is a fact that, due to the interaction between tire and the pavement, the tires of a vehicle partially deform; this deformation results in the stored potential energy of the tires being converted to heat, which is partly absorbed by the rest of tire, with the remainder being dissipated into the atmosphere [26]. Therefore, it is important to know that higher pavement texture results in more fuel consumption [27]. In past decade, due the problem of global warming and drawbacks of high consumption rate, modelling and simulating the effect of different type of pavement conditions on fuel consumption rate, and its effect on environment, has been a topic of interest for many researchers [28–32]. Interestingly, the results have continuously shown that pavement smoothness has the highest impact on the rate of fuel consumption: The smoother the road, the less fuel consumption [33–36].

There is also energy loss during vehicle transportation on the road. Energy is absorbed and converted to a thermal energy form, by the suspension system and tires, meaning energy loss will be reduced if the suspension system can eliminate the effect of the pavement condition, and make vehicle bounces less [37]. Therefore, designing an effective suspension system to compensate the effects of pavement conditions on vehicle is a way to reduce fuel consumption.

#### 1.3.1. Methods of Improving the Fuel Efficiency

One of the ways to decrease the load/mass of the car is through choosing high-tech materials, as to increase fuel efficiency without jeopardizing the safety of the passenger. Some automakers are trying to use plastic fuel tanks and carbon fiber instead of steel. Alas, carbon fiber, a lightweight and reliable material, is unlikely to be used, due to its hefty price in the market. A record by the EPA (Environmental Protection Agency), shows that for every 45 kg of mass reduced, fuel efficiency can increase by one to two percent (1–2%) [38,39].

Modifying the engine appropriately (e.g., adding/improving a turbo charger) can improve efficiency of fuel consumption by up to 4%, and fixing a serious problem (such as a broken oxygen sensor) can improve efficiency by a staggering 40%. Keeping the pressure of the tires in check (at the adequate pressure accordingly) improves fuel consumption by up to 3.3%. Old cars that use a carbureted engine are still in use and by keeping their air filters unclogged could help with fuel economy and acceleration. In more modern cars however, it usually aids with acceleration only [40–42].

One crucial step in optimizing fuel efficiency involves developing analytical models to predict the vehicle's fuel consumption and to achieve the desired results. There have been models that compute fuel consumption estimates in cars, with respect to their fuel consumption, characteristics and the surrounding environment. However, these models only represent approximations to these estimates. By adding more variables to the models, the outcomes will become more accurate—but this will result in a less efficient model. This is because mathematical models represent approximations to the real result, while having errors in each of the parameters used. Therefore, the more parameters one uses, the more errors are involved, thus making the model less efficient [43].

There have been many attempts to enable mathematical models to predict fuel consumption, with different variables in each. The first time metrics mathematical models were utilized to predict vehicle fuel consumption and emissions was by Ahn et al. [44]. The proposed model is a function of speed and acceleration, with constant parameters, and can predict fuel consumption or CO emission rates for an assumed vehicle. According to Ross et al. [45] there are two factors that affect vehicle fuel consumption: The efficiency of the powertrain, and the power required in working the vehicle. He evaluated fuel consumption by finding the product of optimal specific fuel consumption into the sum of the powers of the rolling resistance, air resistance, and inertial acceleration resistance, and then

dividing it by the product of the efficiency of transmission with the average speed of the vehicle and the fuel density. In another research, on analytic modelling of vehicle fuel consumption, it has been shown that the fuel consumption can be found by using the calorific value of fuel per 100 km [43]. This was done by finding the sum of energies of the forces required to overcome resistance and the kinetic energy required for episodic accelerations, and then dividing it by the calorific value of the fuel used. In 2008, Smit et al. [46] conduct a study which examined how, and to what extent, models used to predict emissions and fuel consumption from road traffic, including the effects of congestion. In 2011, Rakha et al. [47] developed a fuel consumption model which can be easily integrated within a traffic simulation framework. In 2015, Tang et al. [48] proposed a model to investigate the impacts of the driver's bounded rationality and the effect of signal lights on the fuel consumption. In 2017, a fuel consumption model for heavy duty trucks has been proposed by Wang et al. [49].

### 1.3.2. Methods of Improving the Vehicle Suspension

From the point of view of ride safety, the most important element of the vehicle (which has a direct impact on passengers comfort) is the suspension system [50]. Nowadays, with advancements in the car manufacturing industry, companies attempt to provide a smooth ride for passengers through the development and manufacture of more advanced vehicle suspension systems. These systems are able to minimize the effects of uneven pavement conditions of roads on the passengers [51]. In 2016, Kognati et al. [52] proposed a unified approach to model complex multibody mechanical systems, and design controls for them. Pappalardo et al. [53], in 2017, proposed a novel methodology to address the problems of suppressing structural vibrations, and attenuating contact forces, in nonlinear mechanical systems; and in 2018 they developed an adjoint method—which can be effectively used for solving the optimal control problem, associated with a large class of nonlinear mechanical systems [54]. Nowadays, to optimize the quality of travel by cars, various types of controllers (such as adaptive control [55], Linear Quadratic Gaussian (LQG) control [56], H-infinity [57], Proportional (P) controller [58], Proportional Integral (PI) controller [59], and Proportional Integral Derivative (PID) controller [60]) have been utilized, in order to control the car suspension system and to eliminate the vibration coming from the pavement. In 2014, Li et al. [61] proposed an output-feedback  $H_\infty$  control for a class of active quarter-car suspension systems with control delay. In 2015, AENS et al. [62] performed a Comparison between passive and active suspensions systems. In 2016, Buscarino et al. [63] investigated the role of passive and active vibrations, for the control of nonlinear large-scale electromechanical systems, which have also been investigated by Zhao et al. [64], in 2016, who utilized adaptive neural network control for an active suspension system with actuator saturation. Taskin et al. [65], in 2017, investigated the effect of utilizing fuzzy logic controller on an active suspension system based on a quarter car test rig; and in 2018 a control scheme, utilizing Hybrid ANFIS PID, was proposed by Singh et al. [66], in order to improve the passenger ride comfort and safety in an active quarter car model. Furthermore, Fauzi et al. [67], in 2018, developed a state feedback controller to reduce body deflection caused by road disturbance, to achieve the ride comfort of driver and passengers.

### 1.4. Scope and Contribution

The goal of this paper is to design an effective PID controller, to control the active suspension system of a car, in order to eliminate the imposed vibration to the car from pavement, which has a major role in the fuel consumption rate. In this research, the Ahn mathematical model has been utilized to model the fuel consumption rate, and Gaussian white noise has been adopted to model the pavement condition. The logic behind selection of this type of noise is the randomness property of it. Generally, the term noise or random fluctuations characterize all physical systems in nature. The apparently irregular or chaotic fluctuations were considered as noise in all fields, except in a few, such as astronomy [68].

The term “white” refers to the frequency domain characteristic of noise. Ideal white noise has equal power per unit bandwidth, which results in a flat power spectral density across the frequency

range of interest. Therefore, the power in the frequency range from 100 Hz to 110 Hz is the same as the power in the frequency range from 1000 Hz to 1010 Hz. The term “Gaussian” refer to the probability density function (pdf) of the amplitude values of a noise signal. The color of the noise refers to the frequency domain distribution of the noise signal power. Since the white noise contain all frequencies, it can be considered as random input, which simulates the any type of pavement condition. In this case instead of simulating the road conditions with different color noises simply the Gaussian White Noise can be utilized [69].

In this research, MATLAB/Simulink software has been utilized to model the fuel consumption rate, to design a PID controller and to model the effect of the white noise on the quarter car suspension system. The results show that the PID controller has an effective performance to eliminate the effect of road conditions and reducing the fuel consumption rate which has a significant effect on environment sustainability.

### *1.5. Organization of the Paper*

After the brief introduction the rest of the manuscript has been organized in following manner. First, in Section 2 (Methodology), the fuel consumption mathematical model, steps of simulation set up and data collection have been described in detail. Then in Section 3 (Results), the proposed methodology has been verified by analyzing the results. Finally, in Section 4 (Conclusions and Future Work) the summary of the manuscript has been provided, and possible future works have been suggested.

## **2. Methodology**

Vehicle handling performance and fuel consumption rate are two important factors which are directly affected by vehicle suspension system [70]. Conventionally, in order to decrease the vehicle vibration a combination set up of springs and dampers has been used. This set up is generally known as passive suspension system. The input disturbance to the car from pavement condition cannot be eliminated by passive suspension system, since the damping ratio is constant and not adjustable. To eliminate the effect of the road condition, the best solution is to utilize an autonomous control system, known as active suspension system, which can compensate for the noise input to the system by exerting force to the system [71].

In this paper, the problem has been defined as how an effective controller can be designed to control an active suspension system, to eliminate the pavement condition effects to reduce the fuel consumption. To fulfil the task first in next section, the Ahn fuel consumption mathematical model has been introduced, to model the fuel consumption rate before and after utilizing the PID controller. Next, an active suspension system has been introduced, and later, with respect to the control engineering concept, the introduced active suspension system mathematically has been modelled. In this third stage, the effect of the pavement condition on the vehicle, introducing the white noise concept, has been modelled, and in the next step, a PID controller (to control the proposed active suspension system) has been designed. In fifth step, the proposed system has been simulated, utilizing MATLAB-Simulink. This is followed by a performance analysis of the controller, and finalized by investigating the stability of the proposed controller.

### *2.1. Fuel Consumption Model*

As discussed previously, there have been several different approaches taken to model the fuel consumption in a vehicle. Some of these approaches could be similar in terms of using the same variables but might have a different mathematical representation of the data, while others would have different variables all together with or without the same mathematical model. Most of the researches led in this field do not include every variable affecting the outcome of a vehicle’s fuel consumption. This is due to a reason mentioned previously, regarding the decrease in the efficiency of the model. Because of this specific reason, the research conducted usually involves a limited number of variables.

In this article, the Ahn mathematical model has been utilized to calculate the fuel consumption rate. As shown in Equation (1), the model uses a vehicle’s speed and acceleration alongside constants to find a vehicle’s fuel consumption [72]:

$$F(x, y) = e^{a+bx+cx^2+dx^3+ey+fy^2+gy^3+hxy+ixy^2+jxy^3+kx^2y+lx^2y^2+mx^2y^3+nx^3y+ox^3y^2+px^3y^3}, \quad (1)$$

where  $F$  is the rate of fuel consumption measured in (lit/h) as a function of a vehicle’s speed and acceleration;  $y$  being the vehicle’s speed measured in m/s; and  $x$  the acceleration measured in  $m/s^2$ . The letters  $a$  to  $p$  are constants with the following values:  $a = -0.67944$ ;  $b = 0.135273$ ;  $c = 0.015946$ ;  $d = -0.00119$ ;  $e = 0.029665$ ;  $f = -0.00028$ ;  $g = 1.49 \times 10^{-6}$ ;  $h = 0.004808$ ;  $i = -2.1 \times 10^{-5}$ ;  $j = 5.54 \times 10^{-8}$ ;  $k = 8.33 \times 10^{-5}$ ;  $l = 9.37 \times 10^{-7}$ ;  $m = -2.5 \times 10^{-8}$ ;  $n = -6.1 \times 10^{-5}$ ;  $o = 3.04 \times 10^{-7}$ ;  $p = -4.5 \times 10^{-9}$ .

### 2.2. Active Suspension Model

In this paper, the quarter car dynamic vibration model has been chosen to represent the active suspension model (see Figure 1). While this model has limitations, such as eliminating vehicle’s pitching and roll angle vibrations, it also includes the most essential features for this research, such as the change of the load and suspension system’s stress information, which has been utilized by many researchers, to investigate the effect of pavement conditions on body vibration of a vehicle [73–77].

As shown in Figure 1, the vehicle body mass (known as the sprung mass) has been shown with  $M_1$ , and the mass of the axel and wheel, which has been shown with  $M_2$ , represents the unsprung mass. The tire is assured to maintain contact with the surface of the road when the vehicle is traveling, and is modelled as a linear spring with stiffness  $K_2$ . The linear damper, which average damping coefficient is  $D$ , and the linear spring, which average stiffness coefficient is  $K_1$ , consist of the passive component of the suspension system. The vertical displacements of the  $M_1$  and  $M_2$  respectively have been represented by the state variables  $X_0(t)$  and  $X_2(t)$ , since vertical pavement condition has been shown by  $X_1(t)$ . The active control force which has been created by the active suspension actuator is shown by  $U$ .

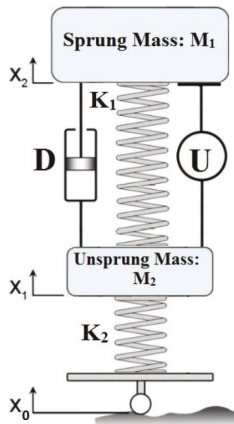

**Figure 1.** Active quarter car suspension model.  $M_1$ , vehicle body mass;  $M_2$ , unsprung mass;  $K_1$ , stiffness coefficient of the suspension;  $K_2$ , Vertical stiffness of the tire;  $D$ , damping coefficient of the suspension;  $U$ , active control force;  $X_0$ , road excitation;  $X_1$ , vertical displacement of unsprung mass;  $X_2$ , vertical displacement of sprung mass.

Generating a mathematical model is the first step of modelling a system, followed by calculating the design parameters. In an control engineering field, a system can be modelled mathematically

in three different ways: (1) State space description; (2) transfer function description; and (3) weight function description [78].

In this paper, the active quarter car suspension model (which has been presented in Figure 1) has been modelled mathematically by the Transfer Function method. To fulfil the task, two degrees of freedom motion differential equations have been generated (Equations (2) and (3), as follows), by analyzing the vehicle suspension system dynamics (Figure 1):

$$M_1\ddot{x}_0(t) + D[\dot{x}_0(t) - \dot{x}_2(t)] + k_1[x_0(t) - x_2(t)] = u, \tag{2}$$

$$M_2\ddot{x}_2(t) - D[\dot{x}_0(t) - \dot{x}_2(t)] + k_1[x_2(t) - x_0(t)] + k_2[x_2(t) - x_1(t)] = -u. \tag{3}$$

One must assume that all of the initial conditions are zero, so these equations represent a situation when the wheel of a car goes over a bump. The dynamics of Equations (2) and (3) assume that all initial conditions are zero, and there can be expressed in the form of transfer functions by taking Laplace Transform of the equations. This is to represent the condition of when vehicle goes over a bump. It is important to know that the system will have two transfer functions, as represented in Equations (4) and (5):

$$G_1(s) = \frac{x_0(s) - x_2(s)}{U(s)} = \frac{(M_1 + M_2)s^2 + k_2}{\Delta}, \tag{4}$$

$$G_2(s) = \frac{x_0(s) - x_2(s)}{x_0(s)} = \frac{-M_1k_2 + s^2}{\Delta}, \tag{5}$$

where

$$\Delta = \det \begin{bmatrix} (m_1s^2 + Ds + k_1) & -(Ds + k_1) \\ -(Ds + k_1) & (m_2s^2 + Ds + (k_1 + k_2)) \end{bmatrix}. \tag{6}$$

$G_1(s)$  represents the effect of exerted force, on the vertical displacement of the car, which has been produced by active suspension system; and  $G_2(s)$  represents the effects of the pavement condition on the vertical displacement of the car.

This means that vertical displacement of the vehicle is superposition of the effects of both active suspension force and pavement displacement. As mentioned in previous section, the goal of this research is to eliminate the effect of pavement condition on the system by utilizing a controller (in other words, this article proposes that, by adjusting the produced force by active suspension, the effect of the road condition can be eliminated). To achieve this goal, a PID controller, proposed and explored in next section, in order to control the amount of the produced force.

### 2.3. PID Controller

A PID controller is a closed loop controller type, which controls the plant output variable by minimizing the error between real plant output, and desired output. A PID controller consists of three controller modes: P as proportional controller, I as integral controller; and D as derivative controller (see Figure 2) [79].

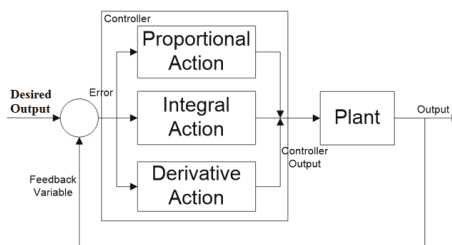

Figure 2. Proportional Integral Derivative (PID) controller.

In industrial control systems, the main mode of the PID controller, are mostly known as the proportional control mode—which determines the controller response to the plant error by multiplying the error to the P controller’s gain ( $K_p$ ), so that a higher  $K_p$  will result in higher P action to the plant error (see Equation (7)) [80].

$$P = K_p \times e(t) \quad (7)$$

The effect of the integral controller mode can be defined as decreasing, or increasing, the response time of the controller to the plant error, by calculating the integral of the error, and multiplying it to the I controller’s gain ( $K_I$ ), so that a higher  $K_I$  will result in higher I action to the plant error (see Equation (8)) [81].

$$I = K_I \times \int e(t)dt \quad (8)$$

The last mode of a PID controller, which regulates the plant’s output by calculating the derivative of the error and multiply it to the P controller’s gain ( $K_D$ ), is derivative controller mode (see Equation (9)). The D mode controllers are widely used in motion control systems, since they are very sensitive against of noise and disturbances [82].

$$D = K_D \times \frac{de(t)}{dt} \quad (9)$$

It is important to know that a PID controller is the weighted sum of these three modes of control, and based on the plant requirements, one or two modes can be eliminated. The response of the PID controller, control signal  $u(t)$ , to the plant error can be determined, as shown in Equation (10) [83].

$$u(t) = (K_p \times e(t)) + (K_I \times \int e(t)dt) + (K_D \times \frac{de(t)}{dt}) \quad (10)$$

It is highly important to mention that knowing effect of the each of these three modes on the response of the controller is an essential criteria in control theory; and any change in PID controller’s coefficients can result in changing the status of the system from stable to unstable (see Table 1) [83].

**Table 1.** Response of PID controller.

Parameter	Stability	Steady State Error	Settling Time	Overshoot	Rise Time
↑ $K_p$	Degrade	Decrease	Small Change	Increase	Decrease
↑ $K_I$	Degrade	Eliminate	Increase	Increase	Decrease
↑ $K_D$	Improve For small $K_D$	No effect in theory	Decrease	Decrease	Minor Change

As seen in Table 1, if the  $K_p$  is increased too much, the control loop will begin oscillating, and become unstable. Furthermore, the system will not receive desired control response if  $K_p$  is set too low. The similar rules exist for integral and derivative controller modes.

The controller response will be very slow if the integral time is set too long, and system will be unstable the control loop will oscillate if  $K_I$  is set too low. However, if  $K_D$  increases too much, then oscillations will occur, and the control loop will turn to unstable.

By knowing the active suspension model and PID controller concept, the next step is design an effective PID controller for the quarter car model.

The goal of this paper is to design an effective controller by eliminating the effect of the pavement on the vehicle passengers. The controller should be designed to make its system stable, by eliminating the disturbance of the road, which shows itself as an oscillation of the vehicle; and, at the same time, has a smooth and fast control signal to ensure that passengers comfort and safety are not compromised. PID controllers are one of the best controllers that can be utilized for this purpose, since they are capable to reach the steady state error by having a short rise time, and they can give stability to a system by eliminating oscillations and overshoot of the system.

The proposed PID controller in this paper consists of all three controller modes: Proportional, integral and derivative. The proposed controller is capable of eliminate the noise of the pavement by adjusting the force of proposed active suspension system (see Figure 3).

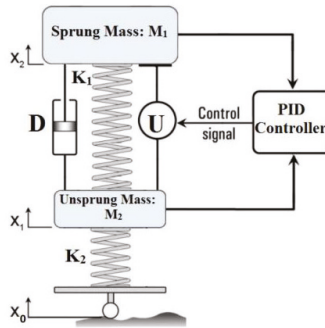

Figure 3. Proposed PID controller for active suspension system.

It is important to know that how the proposed PID controller works.

As mentioned previously, in this research, the effect of the exerted force on the vertical displacement of the car, produced by active suspension system, has been mathematically modelled as  $G_1(s)$ . The input of this mathematical model is the PID controller output, which results in the displacement of body of the vehicle (sprung mass), with respect to the unsprung part. However, there is one more element which affects this displacement, such as the pavement condition. The road condition shows its effect as disturbance on the system, and, in this paper, it has been modelled mathematically as  $G_2(s)$ .

Since the reference input should be equal to zero, so it can be concluded that the difference between the reference input and total displacement, which is known as error function  $E(s)$ , is the superposition of the effects of the control signal and noise signal on vehicle. In this case, the PID controller adjusts the active suspension force by calculating each mode signal, based on the error function  $E(s)$  (see Figure 4).

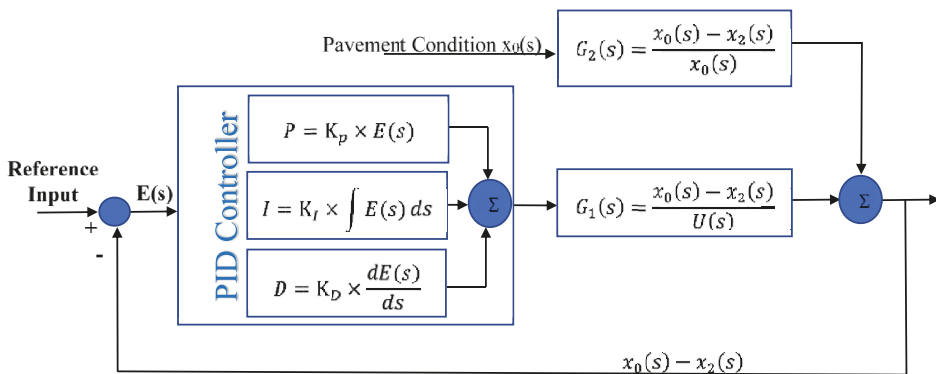

Figure 4. Proposed quarter car model with PID controller.

The proposed PID controller for the modelled quarter car’s active suspension system has been simulated in a MATLAB-Simulink environment. The simulation’s performance is based on the parameters found in Table 2.



Table 2. Simulation parameters.

Vehicle Model Parameters	Symbol	Numerical Value	Unit
Sprung Mass	$M_1$	300	kg
Unsprung Mass	$M_2$	40	kg
Suspension Stiffness	$K_1$	15,000	N/m
Tire Stiffness	$K_2$	150,000	N/m
Suspension Damping Coefficient	$D$	1000	Ns/m

### 3. Results

As seen in Figure 5, the proposed methodology has been implemented and modelled in a MATLAB-Simulink environment. The model can be divided into two main parts: (1) Controlled parts; and (2) uncontrolled parts. The controlled part consists of the proposed PID controller, to reduce the effect of the imposed fluctuations by the pavement condition on the vehicle, and the effect of the controller on reduction of the fuel consumption rate. The uncontrolled parts consist of the effects of the pavement conditions on a vehicle’s vertical displacement, and the effect of these vibrations on the fuel consumption rate. The pavement condition  $x_0(s)$  has been modelled by Gaussian white noise. The reason is that the road unevenness is kind of noise, which should be compensated—therefore, any kind of colored noise such as pink, red, green, etc., can be utilized for this purpose [84]. Since white noise contains all frequencies of colored noises, so it is a good approximation to simulate the randomness of pavement roughness [85].

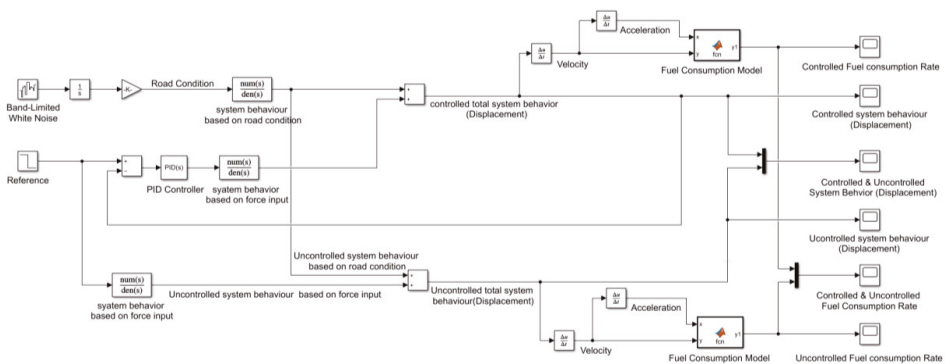

Figure 5. MATLAB-Simulink model of the proposed fuel consumption and noise cancellation system for the active suspension system.

As seen in Figure 5, the reference input (which here is the desired output) has been simulated by the step function. The reason is that the reducing and even elimination of the vehicle oscillations is desirable, and the oscillations are the result of displacements of the sprung mass with respect to the unsprung mass. The displacement has been calculated as the plant’s output ( $x_0(s) - x_2(s)$ ). Since the target is to eliminate it, the desired output should be considered as zero, and a step function (generating zero value at  $t > 0$ ) is a good model to generate the required data.

The effect of the random road pavement, which has been modelled by a Gaussian white noise generator, has been illustrated in Figure 6. It can be observed that the vehicle follows the road condition, with fluctuations due to road fluctuations (which can be considered as unstable behavior). This will result in increasing fuel consumption, decreasing the effective life of the vehicle’s parts, and compromising passengers’ safety.

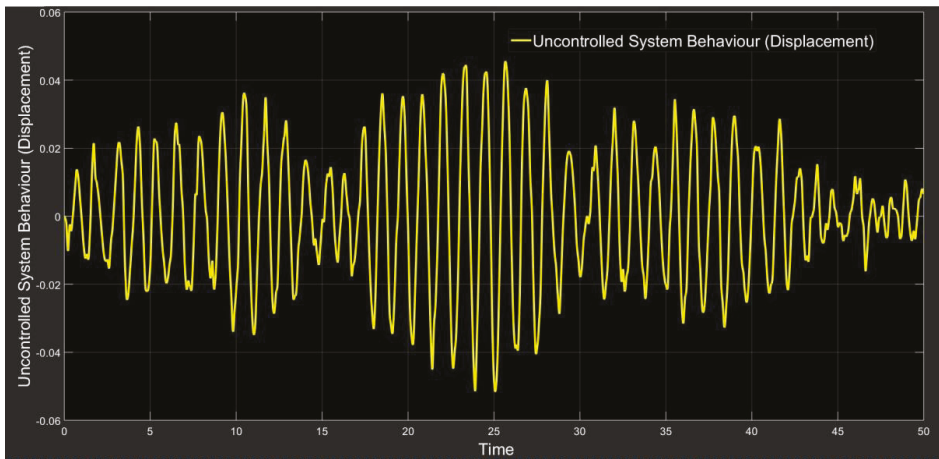

Figure 6. Uncontrolled total system response, based on the random input.

As seen in Figure 6, this uncontrolled response is not convenient for the passengers. Therefore, in order to reduce and eliminate the effect of the road pavement on the car, which shows itself as car fluctuation (as described before), a PID controller has been designed.

By utilizing the PID controller, as it can be observed from Figure 7, the car does not follow the road condition, and the active suspension controller cancels out the unpleasant pavement condition's effect on the car.

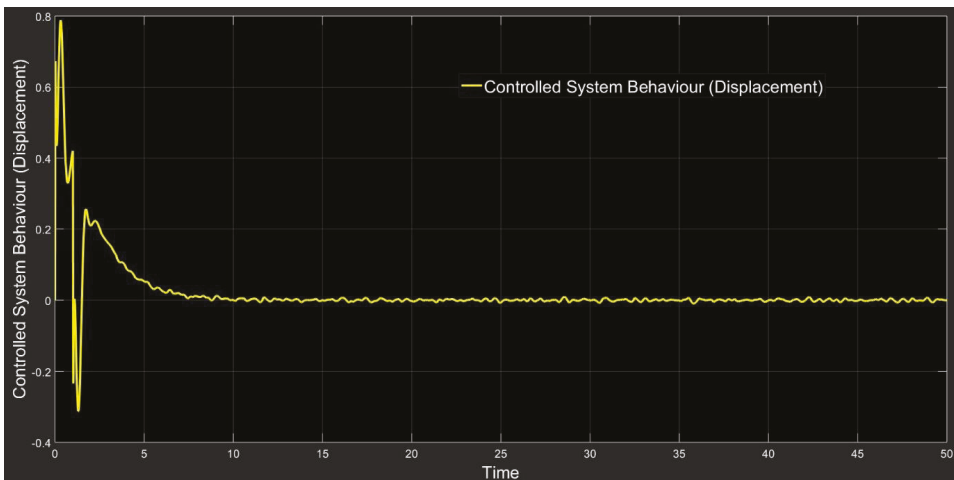

Figure 7. Controlled total system response, based on the random input.

To have a better understanding of how the proposed PID controller compensate for the effect of the pavement, controlled and uncontrolled total system behaviors have been shown in Figure 8. As can be observed, the first system shows an aggressive controlled response to the input noise, but after three seconds it starts to cancel the noise, and prepares a convenient and safe ride for passengers.

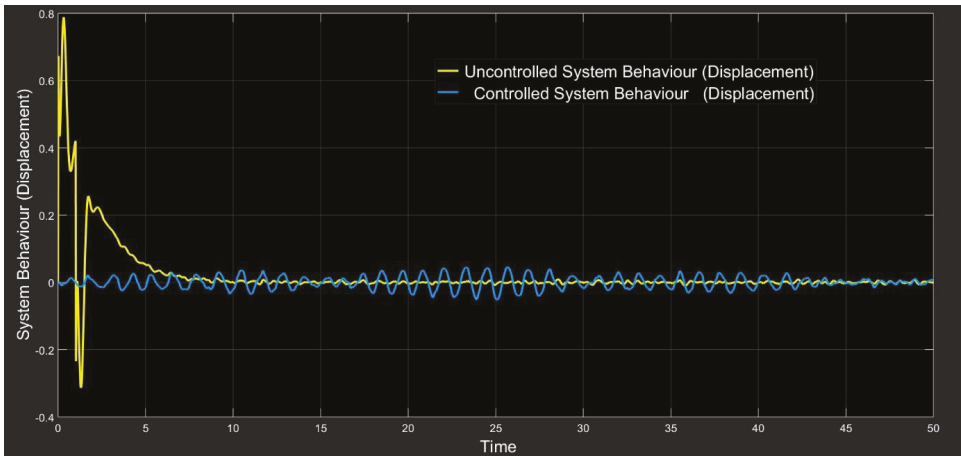

Figure 8. Controlled and uncontrolled total system behaviors.

As seen in Figure 5, in the proposed model, two fuel consumption blocks have been created to calculate the changing of the fuel consumption rate. It is important to mention that the mathematical model, inside both blocks, is the Ahn model, which has been discussed previously. The fuel consumption model, in the lower part of the model, has the role of calculating the change of the fuel consumption rate, based on the imposed vibration by the road conditions on the vehicle. It is essential to remember that here the proposed model is not capable of calculating the fuel consumption rate, since it should be calculated via horizontal displacement of the vehicle, but the vertical fluctuations act as a resistant in front of the engine acceleration. This means that the function of the block is simulating the uncontrolled change in fuel consumption rate.

The results, as shown in Figure 9, indicate that since speed and velocity of the vehicle are changing, during the simulation time, and the fuel consumption’s model depends on these two variables, the fuel consumption rate changes under the random pavement conditions, which results in more CO emissions.

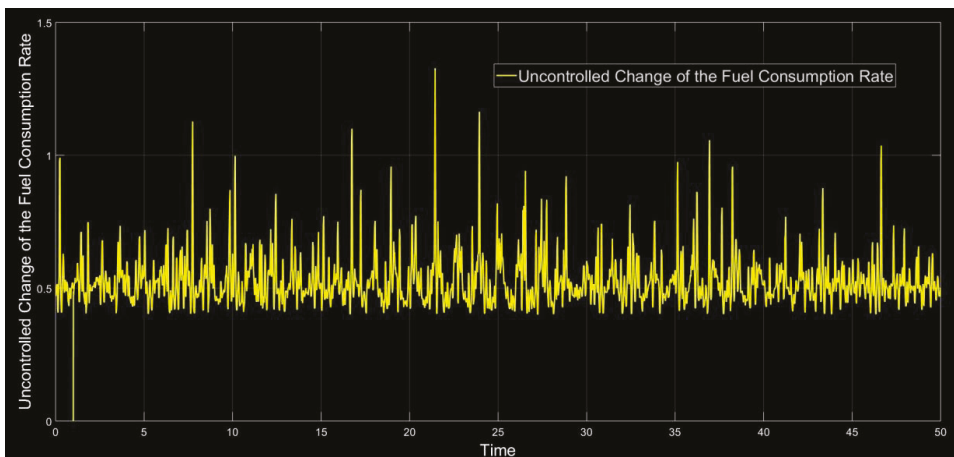

Figure 9. Uncontrolled fuel consumption rate changes.

As it is shown in Figure 10, after adding the proposed PID controller to the system, the fuel consumption rate at the beginning of the simulation, and at the first control signal, has a change—but it remains without any changes during the rest of the simulation period.

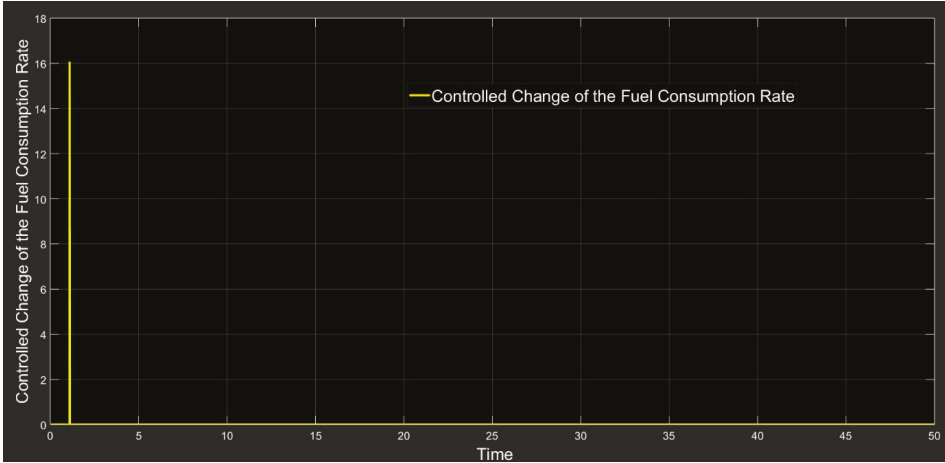

Figure 10. Controlled change of the fuel consumption rate.

To explore the stability status of the designed controller in this research, as it can be seen in Figure 11, the compensator editor tool of the MATLAB software has been adopted. The system, without considering the forced step function input, has only one negative pole at  $-100$ , and two complex zeroes at  $-0.405 \pm 1.19i$ . If the forced input effect is desired for consideration, another pole in zero has to be added to the system. Since the system only has a one negative pole, it can be concluded that the designed PID controller (based on the location of the poles) is a stable system, and (based on the location of the zeros) it has a damping ratio of 0.3, and a natural frequency of 1.25 Hz.

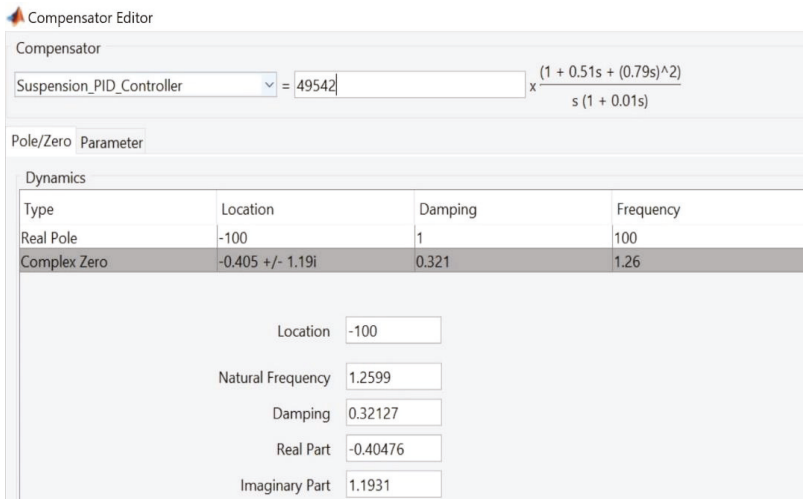

Figure 11. Pole and zero information of the design PID controller.

Now, by knowing the locations of the pole and zeros of the system, the Root Locus diagram can be plot. As seen in Figure 12, it can be concluded that by moving to the left side of the real axis, the system shows more stable behavior.

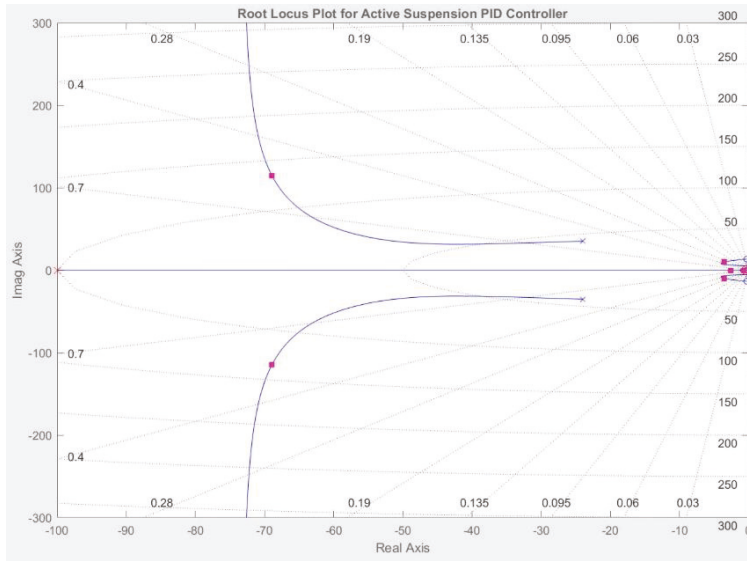

Figure 12. Root locus diagram.

#### 4. Conclusions and Future Work

The main role of a suspension systems is to reduce fuel consumption, and to ensure passenger safety. Road roughness yields fluctuations of the vehicle wheels, which is transmitted to the all parts of the vehicle, as well as the passengers. It becomes clear that the role of the suspension system is to reduce as many of these vibrations and shocks, which occur while driving, as possible. An effective suspension system should result in a smooth driving, with less vehicle vibrations, and a degree of comfort, based on the interaction with bumpy road surface. The vehicle behavior should not consist of large oscillations in presence of a good suspension system. To achieve this goal, in this paper, an active car suspension has been modelled, and an effective PID controller has been proposed and designed, to cancel the negative effects of the pavement conditions. Since the Gaussian white noise produces random outputs, it has been adopted to simulate the pavement effects on the vehicle. The Ahn mathematical model was utilized to simulate the change of the fuel consumption rate—both in controlled, and uncontrolled conditions. Proposed plant and control architecture has been modelled by using the MATLAB-Simulink software package, and the stability of controller has been investigated. The results show that the proposed PID controller works, and has is effective, which in turn results in the decrease of fuel consumption, and prevents premature damage to the vehicle. For future studies, rather than the proposed linear model, nonlinear elements can be considered for the quarter car model, and the PID controller's coefficients can be optimized by Ring Probabilistic Logic Neural Networks (RPLNN) Hybrid Algorithms, Genetic Algorithm, and other artificial intelligent techniques.

**Funding:** This research was funded by [The Research Council of Oman (TRC)] grant number [ORG/CBS/14/008].

**Conflicts of Interest:** The author declares no conflict of interest.

## References

- Hoffert, M.I.; Caldeira, K.; Benford, G.; Criswell, D.R.; Green, C.; Herzog, H.; Jain, A.K.; Kheshgi, H.S.; Lackner, K.S.; Lewis, J.S.; et al. Advanced technology paths to global climate stability: Energy for a greenhouse planet. *Science* **2002**, *298*, 981–987. [[CrossRef](#)] [[PubMed](#)]
- Vitousek, P.M.; Mooney, H.A.; Lubchenco, J.; Melillo, J.M. Human domination of Earth's ecosystems. *Science* **1997**, *277*, 494–499. [[CrossRef](#)]
- Dong, B.; Sutton, R.T.; Scaife, A.A. Multidecadal modulation of El Niño–Southern Oscillation (ENSO) variance by Atlantic Ocean sea surface temperatures. *Geophys. Res. Lett.* **2006**, *33*. [[CrossRef](#)]
- Younger, M.; Morrow-Almeida, H.R.; Vindigni, S.M.; Dannenberg, A.L. The built environment, climate change, and health: Opportunities for co-benefits. *Am. J. Prev. Med.* **2008**, *35*, 517–526. [[CrossRef](#)] [[PubMed](#)]
- Pacala, S.; Socolow, R. Stabilization wedges: Solving the climate problem for the next 50 years with current technologies. *Science* **2004**, *305*, 968–972. [[CrossRef](#)] [[PubMed](#)]
- Shafiee, S.; Topal, E. When will fossil fuel reserves be diminished? *Energy Policy* **2009**, *37*, 181–189. [[CrossRef](#)]
- Dincer, I. Renewable energy and sustainable development: A crucial review. *Renew. Sustain. Energy Rev.* **2000**, *4*, 157–175. [[CrossRef](#)]
- Small, K.A.; Van Dender, K. Fuel efficiency and motor vehicle travel: The declining rebound effect. *Energy J.* **2007**, *28*, 25–51. [[CrossRef](#)]
- Goldberg, P.K. The effects of the corporate average fuel efficiency standards in the US. *J. Ind. Econ.* **1998**, *46*, 1–33. [[CrossRef](#)]
- Stone, R. *Motor Vehicle Fuel Economy*; Macmillan International Higher Education: London, UK, 2017.
- Mock, P.; Gorman, J.; Bandivadekar, A.; Riemersma, I. *Discrepancies between Type-Approval and Real-World Fuel-Consumption and CO<sub>2</sub>*; The International Council on Clean Transportation: Washington, DC, USA, 2012; Volume 13.
- Kågeson, P. *Reducing CO<sub>2</sub> Emissions from New Cars*; European Federation for Transport and Environment: Brussels, Belgium, 2005.
- McBeath, S. *Competition Car Aerodynamics*, 3rd ed.; Veloce Publishing Ltd.: Poundbury, UK, 2017.
- Holmberg, K.; Andersson, P.; Nylund, N.-O.; Mäkelä, K.; Erdemir, A. Global energy consumption due to friction in trucks and buses. *Tribol. Int.* **2014**, *78*, 94–114. [[CrossRef](#)]
- Liu, J.; Zheng, Z.; Li, F.; Lei, W.; Gao, Y.; Wu, Y.; Zhang, L.; Wang, Z.L. Nanoparticle chemically end-linking elastomer network with super-low hysteresis loss for fuel-saving automobile. *Nano Energy* **2016**, *28*, 87–96. [[CrossRef](#)]
- Kakaee, A.-H.; Rahnama, P.; Paykani, A. Influence of fuel composition on combustion and emissions characteristics of natural gas/diesel RCCI engine. *J. Nat. Gas Sci. Eng.* **2015**, *25*, 58–65. [[CrossRef](#)]
- Dicks, A.; Rand, D.A.J. *Fuel Cell Systems Explained*; Wiley Online Library: Hoboken, NJ, USA, 2018.
- Khalife, E.; Tabatabaei, M.; Demirbas, A.; Aghbashlo, M. Impacts of additives on performance and emission characteristics of diesel engines during steady state operation. *Prog. Energy Combust. Sci.* **2017**, *59*, 32–78. [[CrossRef](#)]
- Zhou, M.; Jin, H.; Wang, W. A review of vehicle fuel consumption models to evaluate eco-driving and eco-routing. *Transp. Res. Part D Transp. Environ.* **2016**, *49*, 203–218. [[CrossRef](#)]
- Flannigan, M.D.; Wotton, B.M.; Marshall, G.A.; De Groot, W.J.; Johnston, J.; Jurko, N.; Cantin, A.S. Fuel moisture sensitivity to temperature and precipitation: Climate change implications. *Clim. Chang.* **2016**, *134*, 59–71. [[CrossRef](#)]
- Xu, Y.; Gbologah, F.E.; Lee, D.-Y.; Liu, H.; Rodgers, M.O.; Guensler, R.L. Assessment of alternative fuel and powertrain transit bus options using real-world operations data: Life-cycle fuel and emissions modeling. *Appl. Energy* **2015**, *154*, 143–159. [[CrossRef](#)]
- Li, L.; You, S.; Yang, C.; Yan, B.; Song, J.; Chen, Z. Driving-behavior-aware stochastic model predictive control for plug-in hybrid electric buses. *Appl. Energy* **2016**, *162*, 868–879. [[CrossRef](#)]
- Wang, H.; Zhang, X.; Ouyang, M. Energy consumption of electric vehicles based on real-world driving patterns: A case study of Beijing. *Appl. Energy* **2015**, *157*, 710–719. [[CrossRef](#)]
- Li, S.E.; Peng, H. Strategies to minimize the fuel consumption of passenger cars during car-following scenarios. *Proc. Inst. Mech. Eng. Part D J. Automob. Eng.* **2012**, *226*, 419–429. [[CrossRef](#)]

25. DeRaad, L. *The Influence of Road Surface Texture on Tire Rolling Resistance*; SAE Technical Paper 780257; SAE International: Warrendale, PA, USA, 1978.
26. Descornet, G. Road-surface influence on tire rolling resistance. In *Surface Characteristics of Roadways: International Research and Technologies*; ASTM International: West Conshohocken, PA, USA, 1990.
27. Sandberg, U.; Bergiers, A.; Ejsmont, J.A.; Goubert, L.; Karlsson, R.; Zöller, M. *Road Surface Influence on Tyre/Road Rolling Resistance*; Swedish Road and Transport Research Institute (VTI): Linköping, Sweden, 2011.
28. Zaabar, I.; Chatti, K. A Field Investigation of the Effect of Pavement Surface Conditions on Fuel Consumption. In Proceedings of the Transportation Research Board 90th Annual Meeting, Washington, DC, USA, 23–27 January 2011.
29. Perrotta, F.; Trupia, L.; Parry, T.; Neves, L.C. Route level analysis of road pavement surface condition and truck fleet fuel consumption. In *Pavement Life-Cycle Assessment*; CRC Press: Boca Raton, FL, USA, 2017; pp. 61–68.
30. Dhakal, N.; Elseifi, M.A. Effects of Asphalt-Mixture Characteristics and Vehicle Speed on Fuel-Consumption Excess Using Finite-Element Modeling. *J. Transp. Eng. Part A Syst.* **2017**, *143*, 04017047. [CrossRef]
31. Ziyadi, M.; Ozer, H.; Kang, S.; Al-Qadi, I.L. Vehicle energy consumption and an environmental impact calculation model for the transportation infrastructure systems. *J. Clean. Prod.* **2018**, *174*, 424–436. [CrossRef]
32. Loulizi, A.; Rakha, H.; Bichiou, Y. Quantifying grade effects on vehicle fuel consumption for use in sustainable highway design. *Int. J. Sustain. Transp.* **2018**, *12*, 441–451. [CrossRef]
33. Huang, Y.; Ng, E.C.; Zhou, J.L.; Surawski, N.C.; Chan, E.F.; Hong, G. Eco-driving technology for sustainable road transport: A review. *Renew. Sustain. Energy Rev.* **2018**, *93*, 596–609. [CrossRef]
34. Speckert, M.; Lübke, M.; Wagner, B.; Anstötz, T.; Haupt, C. Representative Road Selection and Route Planning for Commercial Vehicle Development. In *Commercial Vehicle Technology 2018*; Springer: Berlin, Germany, 2018; pp. 117–128.
35. Pérez-Zuriaga, A.M.; Llopis-Castelló, D.; Camacho-Torregrosa, F.J.; Belkacem, I.; García, A. Impact of Horizontal Geometric Design of Two-Lane Rural Roads on Vehicle CO<sub>2</sub> Emissions. In Proceedings of the Transportation Research Board 96th Annual Meeting, Washington, DC, USA, 8–12 January 2017.
36. Liu, L.; Li, C.; Hua, X.; Li, Y. Multi-factor integration based eco-driving optimization of vehicles with same driving characteristics. In Proceedings of the Chinese Automation Congress (CAC), Jinan, China, 20–22 October 2017; pp. 6871–6876.
37. Palmer, J.; Sljivar, S. Vehicle Fuel Consumption Monitor and Feedback Systems. U.S. Patent 9,610,955, 4 April 2017. Available online: <https://patentimages.storage.googleapis.com/c6/b7/c5/3871b4cea3e583/EP2878509A3.pdf> (accessed on 25 September 2018).
38. Alvarado, P.J. Steel vs. Plastics: The competition for light-vehicle fuel tanks. *JOM* **1996**, *48*, 22–25. [CrossRef]
39. Kurihara, Y.; Nakazawa, K.; Ohashi, K.; Momoo, S.; Numazaki, K. Development of multi-layer plastic fuel tanks for Nissan research vehicle-II. *SAE Trans.* **1987**, *96*, 1239–1245.
40. Bahng, G.; Jang, D.; Kim, Y.; Shin, M. A new technology to overcome the limits of HCCI engine through fuel modification. *Appl. Therm. Eng.* **2016**, *98*, 810–815. [CrossRef]
41. Erkuş, B.; Karamangil, M.I.; Sürmen, A. Enhancing the heavy load performance of a gasoline engine converted for LPG use by modifying the ignition timings. *Appl. Therm. Eng.* **2015**, *85*, 188–194. [CrossRef]
42. Tangöz, S.; Akansu, S.O.; Kahraman, N.; Malkoc, Y. Effects of compression ratio on performance and emissions of a modified diesel engine fueled by HCNG. *Int. J. Hydrog. Energy* **2015**, *40*, 15374–15380. [CrossRef]
43. Ben-Chaim, M.; Shmerling, E.; Kuperman, A. Analytic modeling of vehicle fuel consumption. *Energies* **2013**, *6*, 117–127. [CrossRef]
44. Ahn, K. Microscopic Fuel Consumption and Emission Modeling. Ph.D. Thesis, Virginia Tech, Blacksburg, VA, USA, 1998.
45. Ross, M. Automobile fuel consumption and emissions: Effects of vehicle and driving characteristics. *Annu. Rev. Energy Environ.* **1994**, *19*, 75–112. [CrossRef]
46. Smit, R.; Brown, A.; Chan, Y. Do air pollution emissions and fuel consumption models for roadways include the effects of congestion in the roadway traffic flow? *Environ. Model. Softw.* **2008**, *23*, 1262–1270. [CrossRef]
47. Rakha, H.A.; Ahn, K.; Moran, K.; Saerens, B.; van den Bulck, E. Virginia tech comprehensive power-based fuel consumption model: Model development and testing. *Transp. Res. Part D Transp. Environ.* **2011**, *16*, 492–503. [CrossRef]



48. Tang, T.-Q.; Huang, H.-J.; Shang, H.-Y. Influences of the driver's bounded rationality on micro driving behavior, fuel consumption and emissions. *Transp. Res. Part D Transp. Environ.* **2015**, *41*, 423–432. [[CrossRef](#)]
49. Wang, J.; Rakha, H.A. Fuel consumption model for heavy duty diesel trucks: Model development and testing. *Transp. Res. Part D Transp. Environ.* **2017**, *55*, 127–141. [[CrossRef](#)]
50. Wang, Y.; Zhao, W.; Zhou, G.; Gao, Q.; Wang, C. Suspension mechanical performance and vehicle ride comfort applying a novel jounce bumper based on negative Poisson's ratio structure. *Adv. Eng. Softw.* **2018**, *122*, 1–12. [[CrossRef](#)]
51. Ren, W.; Peng, B.; Shen, J.; Li, Y.; Yu, Y. Study on Vibration Characteristics and Human Riding Comfort of a Special Equipment Cab. *J. Sens.* **2018**, *2018*, 7140610. [[CrossRef](#)]
52. Koganti, P.B.; Udwadia, F.E. Unified approach to modeling and control of rigid multibody systems. *J. Guid. Control Dyn.* **2016**, *39*, 2683–2698. [[CrossRef](#)]
53. Pappalardo, C.M.; Guida, D. Control of nonlinear vibrations using the adjoint method. *Meccanica* **2017**, *52*, 2503–2526. [[CrossRef](#)]
54. Pappalardo, C.M.; Guida, D. Use of the Adjoint Method for Controlling the Mechanical Vibrations of Nonlinear Systems. *Machines* **2018**, *6*, 19. [[CrossRef](#)]
55. Huang, Y.; Na, J.; Wu, X.; Liu, X.; Guo, Y. Adaptive control of nonlinear uncertain active suspension systems with prescribed performance. *ISA Trans.* **2015**, *54*, 145–155. [[CrossRef](#)] [[PubMed](#)]
56. Zhu, Q.; Ding, J.-J.; Yang, M.-L. LQG control based lateral active secondary and primary suspensions of high-speed train for ride quality and hunting stability. *IET Control Theory Appl.* **2018**, *12*, 1497–1504. [[CrossRef](#)]
57. Marzbanrad, J.; Zahabi, N.  $H_{\infty}$  active control of a vehicle suspension system excited by harmonic and random roads. *Mech. Mech. Eng.* **2017**, *21*, 171–180.
58. Elmadany, M.M. Optimal linear active suspensions with multivariable integral control. *Veh. Syst. Dyn.* **1990**, *19*, 313–329. [[CrossRef](#)]
59. Siswoyo, H.; Mir-Nasiri, N.; Ali, M.H. Design and development of a semi-active suspension system for a quarter car model using PI controller. *J. Autom. Mob. Robot. Intell. Syst.* **2017**, *11*, 26–33. [[CrossRef](#)]
60. Metered, H.; Abbas, W.; Emam, A. *Optimized Proportional Integral Derivative Controller of Vehicle Active Suspension System Using Genetic Algorithm*; SAE Technical Paper 2018-01-1399; SAE International: Warrendale, PA, USA, 2018.
61. Li, H.; Jing, X.; Karimi, H.R. Output-feedback-based  $H_{\infty}$  control for vehicle suspension systems with control delay. *IEEE Trans. Ind. Electron.* **2014**, *61*, 436–446. [[CrossRef](#)]
62. Ahmed, A.E.-N.S.; Ali, A.S.; Ghazaly, N.M.; El-Jaber, G.A. PID controller of active suspension system for a quarter car model. *Int. J. Adv. Eng. Technol.* **2015**, *8*, 899.
63. Buscarino, A.; Fortuna, C.F.L.; Frasca, M. Passive and active vibrations allow self-organization in large-scale electromechanical systems. *Int. J. Bifurc. Chaos* **2016**, *26*, 1650123. [[CrossRef](#)]
64. Zhao, F.; Ge, S.S.; Tu, F.; Qin, Y.; Dong, M. Adaptive neural network control for active suspension system with actuator saturation. *IET Control Theory Appl.* **2016**, *10*, 1696–1705. [[CrossRef](#)]
65. Taskin, Y.; Hacioglu, Y.; Yagiz, N. Experimental evaluation of a fuzzy logic controller on a quarter car test rig. *J. Braz. Soc. Mech. Sci. Eng.* **2017**, *39*, 2433–2445. [[CrossRef](#)]
66. Singh, D. Modeling and control of passenger body vibrations in active quarter car system: A hybrid ANFIS PID approach. *Int. J. Dyn. Control* **2018**. [[CrossRef](#)]
67. Fauzi, M.A.Z.I.M.; Yakub, F.; Salim, S.A.Z.S.; Yahaya, H.; Muhamad, P.; Rasid, Z.A.; Toh, H.T.; Talip, M.S.A. *Enhancing Ride Comfort of Quarter Car Semi-Active Suspension System through State-Feedback Controller*; Springer: Singapore, 2018; pp. 827–837.
68. Marmarelis, V. *Analysis of Physiological Systems: The White-Noise Approach*; Springer Science & Business Media: Berlin, Germany, 2012.
69. Hawkins, J., Jr.; Stevens, S. The masking of pure tones and of speech by white noise. *J. Acoust. Soc. Am.* **1950**, *22*, 6–13. [[CrossRef](#)]
70. Zhang, Y.; Guo, K.; Wang, D.; Chen, C.; Li, X. Energy conversion mechanism and regenerative potential of vehicle suspensions. *Energy* **2017**, *119*, 961–970. [[CrossRef](#)]
71. Maciejewski, I.; Krzyzynski, T.; Meyer, H. Modeling and vibration control of an active horizontal seat suspension with pneumatic muscles. *J. Vib. Control* **2018**. [[CrossRef](#)]



72. Ahn, K.; Rakha, H.; Trani, A.; van Aerde, M. Estimating vehicle fuel consumption and emissions based on instantaneous speed and acceleration levels. *J. Transp. Eng.* **2002**, *128*, 182–190. [CrossRef]
73. Nagamani, M.S.; Rao, S.S.; Adinarayana, S. Minimization of human body responses due to automobile vibrations in quarter car and half car models using PID controller. *SSRG Int. J. Mech. Eng.* **2017**. Available online: <https://pdfs.semanticscholar.org/d1b7/8336c6fd72341157b56f79006d539d7d441c.pdf> (accessed on 25 September 2018).
74. Wang, S.; Hua, L.; Yang, C.; Tan, X. Nonlinear vibrations of a piecewise-linear quarter-car truck model by incremental harmonic balance method. *Nonlinear Dyn.* **2018**, *92*, 1719–1732. [CrossRef]
75. Mohan, P.; Poornachandran, K.V.; Pravinkumar, P.; Magudewan, M.; Mohanraj, M. Analysis of Vehicle Suspension System Subjected to forced Vibration using MAT LAB/Simulink. In Proceedings of the National Conference on Recent Advancements in Mechanical Engineering (RAME'17), 2017. Available online: <http://www.ijirst.org/articles/RAMEP011.pdf> (accessed on 25 September 2018).
76. Barethiye, V.; Pohit, G.; Mitra, A. A combined nonlinear and hysteresis model of shock absorber for quarter car simulation on the basis of experimental data. *Eng. Sci. Technol. Int. J.* **2017**, *20*, 1610–1622. [CrossRef]
77. Guo, R.; Gao, J.; Wei, X.-K.; Wu, Z.-M.; Zhang, S.-K. *Full Vehicle Dynamic Modeling for Engine Shake with Hydraulic Engine Mount*; SAE Technical Paper 2017-01-1908; SAE International: Warrendale, PA, USA, 2017.
78. Inman, D.J. *Vibration with Control*; John Wiley & Sons: Hoboken, NJ, USA, 2017.
79. Sahu, A.; Hota, S.K. Performance comparison of 2-DOF PID controller based on Moth-flame optimization technique for load frequency control of diverse energy source interconnected power system. In Proceedings of the Technologies for Smart-City Energy Security and Power (ICSESP), Bhubaneswar, India, 28–30 March 2018; pp. 1–6.
80. Senberber, H.; Bagis, A. Fractional PID controller design for fractional order systems using ABC algorithm. In Proceedings of the 2017 Electronics, Palanga, Lithuania, 19–21 June 2017; pp. 1–7.
81. Jagatheesan, K.; Anand, B.; Dey, K.N.; Ashour, A.S.; Satapathy, S.C. Performance evaluation of objective functions in automatic generation control of thermal power system using ant colony optimization technique-designed proportional–integral–derivative controller. *Electr. Eng.* **2018**, *100*, 895–911. [CrossRef]
82. Yaghooti, B.; Salarieh, H. Robust adaptive fractional order proportional integral derivative controller design for uncertain fractional order nonlinear systems using sliding mode control. *Proc. Inst. Mech. Eng. Part I J. Syst. Control Eng.* **2018**, *232*, 550–557. [CrossRef]
83. Liao, W.; Liu, Z.; Wen, S.; Bi, S.; Wang, D. Fractional PID based stability control for a single link rotary inverted pendulum. In Proceedings of the 2015 International Conference on Advanced Mechatronic Systems (ICAMechS), Beijing, China, 22–24 August 2015; pp. 562–566.
84. Häunggi, P.; Jung, P. Colored noise in dynamical systems. *Adv. Chem. Phys.* **1994**, *89*, 239–326.
85. Ouma, Y.O.; Hahn, M. Wavelet-morphology based detection of incipient linear cracks in asphalt pavements from RGB camera imagery and classification using circular Radon transform. *Adv. Eng. Inform.* **2016**, *30*, 481–499. [CrossRef]



© 2018 by the author. Licensee MDPI, Basel, Switzerland. This article is an open access article distributed under the terms and conditions of the Creative Commons Attribution (CC BY) license (<http://creativecommons.org/licenses/by/4.0/>).

Article

# Green Production Planning and Control Model with ABC under Industry 4.0 for the Paper Industry

Wen-Hsien Tsai \* and Shang-Yu Lai

Department of Business Administration, National Central University, Jhongli, Taoyuan 32001, Taiwan; sy530168@gmail.com

\* Correspondence: whtsai@mgt.ncu.edu.tw; Tel.: +886-3-426-7247; Fax: +886-3-422-2891

Received: 4 July 2018; Accepted: 10 August 2018; Published: 17 August 2018

**Abstract:** In the last 20 years, with the liberalization of the economy, and the trend of industrial globalization, people have gradually paid more attention to environmental protection. With the tremendous advances in information technology, enterprises facing such a severe impact on the business operations, business administrative models must be innovative and adaptable in order to survive and flourish. The paper industry is not only a highly polluting industry, but in the case of long-term overcapacity, the price of paper products is often suppressed, which lowers profitability. The purpose of this study, which is based on the production data of a paper company, is to pose a mathematical programming decision model which integrates green manufacturing technologies, activity-based costing (ABC), and the theory of constraint (TOC); this model should assist in preparing the best production plans, and achieve the optimal profitable product mix. In addition, this study also proposes that the most popular related technologies developed by Industry 4.0 be applied to production control in recent years in order to enhance production efficiency and quality. The findings of this study should contribute to the improvement of the competitiveness of the paper industry, and provide insights into the value of an integrated mathematical programming model applied for product-mix decision. At the same time, we have also applied the related technologies developed by Industry 4.0 to machine maintenance and quality control in manufacturing workshops. With its tremendous benefits, we can actively arouse the industry's understanding of, and attention to, Industry 4.0, thereby increasing the interest in industrial 4.0-related technology investments.

**Keywords:** activity-based costing (ABC); industry 4.0; integrated mathematical programming; product-mix decision; theory of constraints (TOC); carbon tax

**PACS:** J0101

---

## 1. Introduction

The development of the Internet of Things (IoT) and the Cyber-Physical System (CPS) technologies, after the new program of Industry 4.0 was launched in Germany at the Hannover Trade Fair in 2011, signified the opening of the fourth industrial revolution [1]. Since then, many manufacturing research institutes and companies around the world have studied this topic and are now emphasizing that Industry 4.0 manufacturing will involve the automated and intelligent interoperation of the exchange of information to control the production operation of the machine. With the characteristics of the Internet of Things (IoT) and the Cyber-Physical System (CPS), the related items of materials, sensors, machines, products, supply chain and customers can be interconnected to each other. Each machine can independently and autonomously exchange information and control behavior during the production process, making it possible for the product to control its own manufacturing process [2]. New IT technology has made the development of manufacturing technology undergo a new paradigm shift to the so-called Industry 4.0. Since then, the terminology of Industry 4.0 is one of the hottest

manufacturing topics among the academia and industry globally. Taiwan is facing the same situation. In addition to research already started in the academia, the industry is actively involved in the use of related technologies developed by Industry 4.0 to enhance the competitiveness of enterprises.

Facing a highly competitive global market, the accuracy of product costs has become one of the major strategic issues for modern companies. Since the conventional cost accounting in product cost calculation mainly allocates the overhead cost by using the volume-related assignment basis (such as direct labor hours, machine hours, direct material cost, etc.). When the overhead comprises only a fraction of the product costs, this method has little effect on the accuracy of the product cost. However, in the present manufacturing environment, with the increasing automation and computerization of manufacturers, the overhead will increase rapidly (especially in the Industry 4.0 production environment). If conventional cost accounting is used, the product cost will be seriously distorted. In 1988, Cooper and Kaplan [3] recommended using ABC to increase the accuracy of product costs. On the other hand, product-mix design analysis is an important part of the cost allocation view of ABC. In the early days, ABC researchers seldom illustrated how to use ABC costing in the optimal product-mix. The ABC costing system had also been criticized because it did not apply to production-related decisions [4,5]. Therefore, this paper suggests a mathematical programming model to analyze product mix decisions under ABC that maximizes a firm's profit with various constraints.

Furthermore, taking into account the increasing environmental protection awareness today, environmental protection issues will become an important key factor in supporting the sustainable development of enterprises. Some stakeholders have also begun to notice the companies' environmental activities. For a long time, global climate warming has been worsening due to the concentration of CO<sub>2</sub> in the atmosphere increasing by about 30% [6]. In response to this situation, the government has formulated a series of carbon reduction strategies [7–9]. Companies are also now treating environmental protection as an indicator of Corporate Social Responsibility (CSR) [10], emphasizing that business operations should consider not only their own operating and financial conditions, but also their impact on the natural environment and society. A major issue facing all countries in the world today is how to deal with the probable impact of carbon dioxide emission reduction on economic development [11]. Many countries have tried to adopt a “carbon tax” approach to increase the operating costs of high-energy-consuming companies to reduce carbon dioxide emissions. Sathre and Gustavsson [12] believe that environmental taxation can prove to be an innovative method that enables companies to both reduce their environmental impact and increase their economic efficiency. Therefore, this article considers the cost of carbon dioxide emissions to help the paper industry maximize their profits under the concept of environmental protection.

In light of this, the purpose of this paper is to use mathematical programming to incorporate carbon tax costs and TOC into the ABC product-mix decision model. Simultaneously, this paper plans to discuss the use of related technologies developed by Industry 4.0 in the production process control (shop floor control) to contribute to the profitability and market competitiveness of the paper industry. That is, the research question explored in this paper is how to determine product-mix to achieve the maximal profit under the various resource and carbon emission constraints by using the mathematical programming model in the production planning stage, and how to control the production and achieve the planning targets by using Industry 4.0 technologies in the production control stage. The remaining sections of this paper are as follows: the research background is described in Section 2; a green production planning decision model under ABC for the paper company is presented in Section 3; a numerical example is used to illustrate the application of the model is presented in Section 4; the shop floor control under Industry 4.0 in the paper industry is described in Section 5; the discussions and conclusions are presented in Sections 6 and 7, respectively.

## **2. Research Background**

### *2.1. Brief of Industry 4.0*

In recent years, the European countries' industries have been facing competition from developing countries and the threat of population aging. According to the Economic Policy Committee and the European Commission, the working-age population (24–60 years old) will be reduced by 16% to about 48 million [13]. In 2011, the share of industrial value in Western European countries fell by 25%. In contrast, the share of industrial value in developing countries (such as India, China, and Brazil) increased by 179% compared to 1990. Due to labor shortages and the need to shorten product development time and improve the effective use of resources, these issues have already driven the development of industrial technologies, including the Internet of Things (IoT) and the Cyber-Physical System (CPS). These are the two state-of-the-art technologies developed in the past few years. In the current factory, CPS is supported by information technology such as Manufacturing Execution System (MES), Programmable Logic Controller (PLC) and Remote Maintenance concepts. It combines various self-abilities to connect the virtual with the physical world. Therefore, the operation, monitoring, diagnosis, and troubleshooting functions of the automated production system are realized, which not only improves the level of automation, but also optimizes industrial and network efficiency and achieves the goal of smart factories.

### *2.2. The Application of Related Technologies Developed by Industry 4.0*

Application of related technologies developed by Industry 4.0 mainly includes the following four aspects:

#### (1) Manufacturing aspects

In the production environment of Industry 4.0, the future factories will not only automatically connect and exchange information with manufacturing resources (such as sensors, machines, conveyors, robots, actuators, etc.), but the factories will also become conscious and smart enough to predict the current status of machines. On the other hand, the functions such as product design, production engineering, production planning, and control will be modeled as modular aspects and closely linked, which means that these functions are not only commanded by the decentralized system, but also controlled interdependently. Future factories with this mechanism are called Smart Factories [14].

#### (2) Business aspects

Industry 4.0 means a complete communication network, which exists among the production value chains of suppliers, companies, factories, logistics, customers, etc. It will optimize their configuration in real time according to the needs and status of relevant network departments. In addition, the reduction of costs, pollution, raw materials, and carbon dioxide emissions will bring maximum profits to the cooperative departments of all value chains [15].

#### (3) Products aspects

Because Industry 4.0 is embedded with sensors, identifiable components, and processors, these smart products can hold information and knowledge to measure product status and track products based on information analysis results. Moreover, a complete log of production information can be embedded into the products to help product developers achieve the optimal design, prediction, and maintenance [16].

#### (4) Customers aspects

Industry 4.0 allows customers to order any function and any number of products. Additionally, customers can not only change their orders at any time during the production free of charge, but also understand the product's production information [17].

The Cyber-Physical System (CPS) is a key technology underlying Industry 4.0. It uses sensors, network technology, and computers to connect various devices, machines, and digital systems, enabling various machines to communicate and interact with each other, thereby realizing the seamless integration of the virtual and physical worlds. Many CPS-based researchers have deconstructed Industry 4.0 into five levels: Connection, Conversion, Cyber, Cognition, and configuration [18].

(1) Connection Level

The first stage in developing a CPS appliance is to acquire accurate and reliable data from the machine or its elements. Data can be directly acquired from the enterprise's IT systems, such as ERP, MES, SCM, etc., or be measured by sensors.

(2) Conversion Level

Data analysis techniques must be used to transform raw data into useful information that brings self-awareness to the machines for use in prognostics and health management.

(3) Cyber Level

The cyber level plays the role of the Central Information hub in the CPS architecture; in order to better understand the status of each machine in the fleet, it uses specific analyses to extract additional information from the massive amount of information collected. These analyses provide the machine with the ability of self-comparison, to predict the future behavior of the machine.

(4) Cognition Level

At this level, you can gain insight into the systems being monitored and provide the right knowledge to make decisions, as you can get the available comparison information and the status of individual machines. Therefore, an expert user can make the right decision on the task priority of optimizing the maintenance process.

(5) Configuration Level

At the configuration level, due to its supervisory control function, the machine can be self-configured and self-adaptive. Therefore, the configuration level plays the role of an artificial intelligence in the network, which is considered as a future attribute of manufacturing.

This study applied the related technologies developed by Industry 4.0 to the field of production control, such as mechanical condition detection and process quality control. At the same time, various types of sensors are installed in the machine so that more accurate and reliable production data can be collected, which enhances the accuracy and immediacy of the ABC cost calculation.

### *2.3. Green Production and Environmental Protection in the Paper Industry*

#### *2.3.1. Green production*

The deterioration of the environment is a serious threat to social development. Highly polluting products are the main source of environmental pollution in the manufacturing industry. Therefore, minimizing the impact on the environment stemming from production has become an important issue for all manufacturers [19,20]. The pursuit of green product manufacturing can reduce the burden on the environment. Green products are products that have little or no impact on human health. In general, green products may be made from recycled waste, manufactured in a more energy-efficient manner or supplied to the market with less packaging. Green products have become an important focus of environmental policy planning. The common criticism of green environmental protection is that environmental practices will increase costs and reduce the net income. However, the larger question is: How does the manufacturing industry implement green production? Boons [21] proposed the following six options for green production chain management:

- (1) *Reduce the quantity of material used*: Reduce the quantity of material needed to produce the product.
- (2) *Search for alternative materials*: Replace the original materials with alternative materials that have a less environmental impact.
- (3) *Recycling of materials*: Recycling of the materials that make up the product.
- (4) *Search for alternative products*: Replace the original product with another product that performs the same function.
- (5) *Product Recycling*: Recycling and reuse of the product after its use.
- (6) *Eliminating excessive functions*: Stop production of unused or less used product features.

### 2.3.2. The Paris Agreement

The Paris Agreement is a climate agreement signed by the UN's 195 member countries on 12 December 2015 at the UN Climate Summit in 2015; hopefully, it can jointly deter global warming. Article 2 of the Paris Agreement states that, in the future, efforts will be made to control the increase in the temperature of the earth within the range of up to 2 °C in comparison with the pre-industrial age, and efforts must be made to pursue the above-mentioned harder target of increasing the warming rate to within 1.5 °C, in understanding that this will highly decrease the risk and impact of climate change [22].

Due to the growing global competition and changing consumer needs in recent years [23], increasing environmental considerations and energy shortages have made green issues a topical subject in many industries [24]. Enterprises attempt to recover renewable raw materials in order to obtain profits while simultaneously protecting the environment [25], and are devoted to the sustainable development of the environment [26]. In the production processes, energy, resource consumption, and virgin material consumption are actively reduced, thus, reducing waste output in the production processes.

The essence of environmental management is to solve ecological environmental problems during the process of business growth [27], as well as to provide enterprises with production efficiency and the efficient use of raw materials, including using smaller quantities of raw materials, recycling, reusing raw materials, and reducing the cost of waste, thereby enhancing the efficient use of raw materials and reducing wasted resources [28].

The government has considerable authority to dominate or push the industry, including making regulations and industrial plans and assisting enterprises with adequate funds and resources when implementing environmental strategies for continuous proceedings, and planning [29]. However, as various governments are stressed by limited natural resources and waste disposal, they have actively established resource recovery policies [25], and as the public continues to increase pressure on governments regarding environmental pollution, it compels governments to establish strict environmental legislation and substantial fines for environmental pollution, with the intention of reducing enterprise-induced pollution through proper environmental management [30].

### 2.3.3. Environmental Protection Measures in Typical Paper Industry

Some environmental protection measures in the paper industry are described as follows:

- (1) Purchasing various waste papers as raw material to make paper products in order to reduce environmental pollution and because it is more economical than using pulpwood.
- (2) Using cogeneration equipment (also known as electrothermal co-production), where the energy released from the combustion of fuel simultaneously generates electric and thermal energy, and surplus electricity and heat can be sold in order to use energy more efficiently.
- (3) Using contamination control equipment for pollution treatment, such as electrostatic precipitators (ESP) and flue gas desulfurization (FDG), in order to reduce solid suspended particles and SO<sub>x</sub>.

- (4) After coagulating the sedimentation of wastewater treatment, the resulting sludge, which contains high contents of organic substances and fertilizing ingredients, can be supplied to farmers for use as a soil amendment or for composting (high magnesium fertilizer).
- (5) The ash from the bottom of the boiler can be supplied for use in construction landfill, brick-making, artificial aggregate, and building materials.

#### 2.4. Brief of the ABC (Activity-Based Costing) Method

As mentioned before, since the traditional cost accounting system allocates overhead to the product cost through the use of volume-related allocation criteria (such as direct labor hours, machine hours, direct material costs, etc.), its main disadvantage is that in the modern manufacturing environment as manufacturing processes become more automated and computerized, overhead cost will increase rapidly. If traditional cost accounting is also used, product costs will be seriously distorted. In addition, in the market environment with a low product demand and diversified products, there are many volume-unrelated production activities, such as product design, mold replacement, and handling; these differ from the volume-related measures. In other words, mass production may consume more machine hours than small production, but mass production does not necessarily spend a higher batch activity cost than small production. Therefore, in the higher overhead industries, using traditional cost accounting will overestimate or underestimate product costs. In view of this, Cooper and Kaplan [3] suggest using activity-based costing (ABC) to improve the accuracy of product costs. Research on implementing ABC exists in various industries, such as manufacturing, logistics, hotels, libraries and construction, airlines, etc., [31–35]. In addition, the ABC method is also applied to various fields, such as quality improvement, project management, software development, product outsourcing, environmental management, and so on [32,35–41].

The cost assignment of the ABC two-phase model is shown in Figure 1 [42–44]. ABC regards markets, channels, customers, processes, product lines, and products as the cost objects. The cost calculation of a cost object requires identifying the various activities required to complete the cost object first, and then to trace the various resources consumed by each activity. Therefore, ABC uses two-phase assignments to calculate the costs of cost objects. In the first phase, various resource costs are allocated to activity cost pools through resource drivers. Resources used by manufacturing companies may include raw materials, machinery, personnel, utilities, and energy, whose costs will be allocated to activities by using the appropriate resource drivers. Resource drivers represent the resource consumption in production activities, such as machine hours, kilowatt-hours, and square feet. In the second phase, each activity cost pool is allocated to cost objects by using appropriate different types of activity drivers, for example, the number of machine hours for machining, and time for setting up machines [31]. An activity driver is used to measure the activity consumption of the cost objects [45]. Manufacturing activities can be divided into the following categories [46]:

- Unit-level activities: performed once for each unit of product, such as processing and 100% inspection.
- Batch-level activities: performed once for each batch of products, such as installation, handling, and sampling inspection.
- Product-level activities: performed to benefit all units of a specific product, such as product design changes.
- Facility-level activities: performed to sustain manufacturing facilities, such as a factory guard.

The cost information obtained from the cost object can be used for strategic decisions related to quoting, purchasing, outsourcing, profit analysis, product-mix, and so on. In the process of product-mix decision-making, this paper considers the cost of facility activities as a fixed cost.



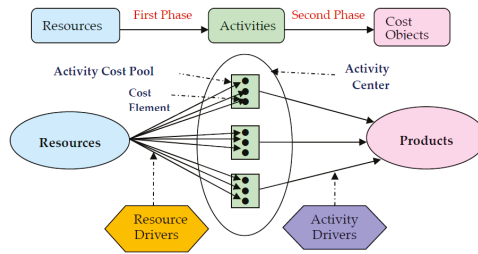

Figure 1. The cost assignment of the ABC two-phase model.

### 2.5. The Theory of Constraints (TOC)

The theory of constraints, as proposed by Dr. Eliyahu M. Goldratt in *The Goal* in 1984, was created as a method of continuous improvement. He believed that each enterprise body is an organic system with its own goals, and there are bound to be constraints in the system that affect the goals. The constraint theory starts from bottleneck management, and moves through the continuous removal of bottlenecks and constraints, thus improving the overall operations and achieving maximum benefits. Since TOC's goal is achieving maximum throughput through short-term optimization procedures for managing resources and eliminating bottlenecks under given overheads and operating expenses [47], some researchers have proposed that TOC can be used for product mix decisions in short-term production [48]. Plenert [49] also believed that if TOC is used for multiple resource constraints, the resulting product mix may not be the optimal product-mix, as the determination of the product mix may lead to a bottleneck shiftiness; however, this limitation can be overcome through integer linear programming (ILP) [50].

This study constructs a mathematical programming model that establishes the optimal product mix in the short term through the flexibility of using restricted resources. The use of such restricted resources will affect the results of the ABC costing, which in turn affects the optimal product mix. For example, exceeding the limit of carbon dioxide emissions will increase the carbon tax cost; if it exceeds normal working hours, it will use overtime, which increases the direct labor time with a higher wage rate.

### 2.6. The Relationships between ABC, TOC, and Industry 4.0

ABC can calculate product costs more accurately, while TOC is a step-by-step improvement for bottlenecks to increase profits. In terms of product costing, as TOC is short-term, it uses restricted resources in the production process (for example, total carbon emissions limits, available labor hours and machine hours, restrictions on raw material supply, etc.), which will affect the results of ABC costing, which in turn affects the best product mix. For example, exceeding the limit of carbon dioxide emissions will increase the carbon tax cost. When production takes longer than normal working hours, it is necessary to use overtime, which increases direct labor costs due to the higher wage rate. In the case of Industry 4.0, various types of sensors can be installed in a machine, thus, more accurate and reliable Resource and Activity driver data can be collected, which improves the accuracy and immediacy of the ABC cost calculation. On the other hand, the related technologies developed by Industry 4.0 can be applied to the production control of actual production. Under the functional structure of MES, it can respond to the changes in production-related parameters and production resource constraints caused by actual production conditions, and give back information to managers to respond effectively, and adjust the production plan in time. At the same time, it can timely detect the actual situation of production, quality and machine operation, and give back to the manager to take effective improvement measures in time to achieve the planned production target [51]. For the



above description, a mathematical programming model of ABC production planning and control under Industry 4.0 is shown in Figure 2.

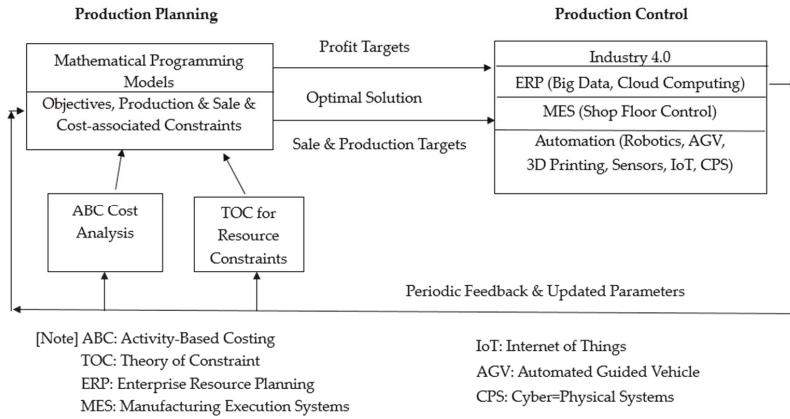

Figure 2. The relationship between the mathematical programming model and Industry 4.0 in this research.

### 3. Green Production Planning Decision Model under ABC for a Paper Company

#### 3.1. A Production Process for a Typical Paper Company

The production process for a typical paper company is shown in Figure 3. The processes of paper-making are briefly described as follows:

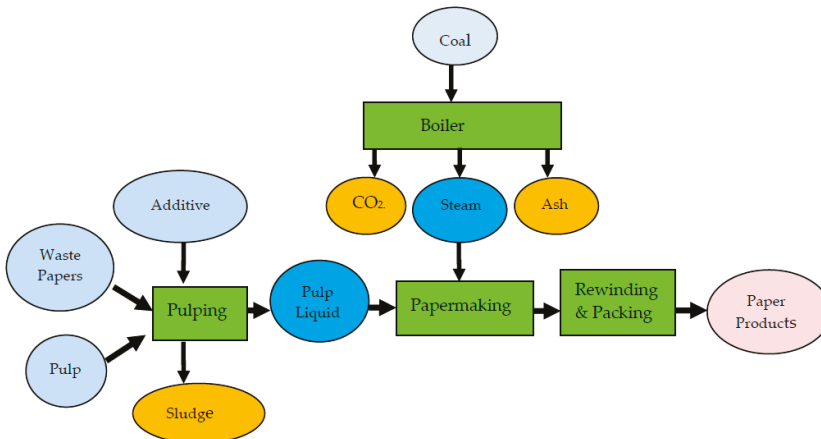

Figure 3. The production process of paper-making.

#### Pulping:

The fundamental purpose of pulping is to stir the pulp, waste paper, and additives in the pulper into a mud or porridge. The pulp, waste paper, and additives are uniformly mixed in a pulp chest in appropriate mix proportions; there are different mix proportions for different product specifications.

### Papermaking:

The pulp prepared in the pulping process enters the paper machine system, and the pulp fibers are hydrated with water. By water flow, the fibers are dispersed over a metal mesh, and form into longitudinal and transverse fibers to enter the paper machine, where the fibers adhere to the papermakers' felt; most of the moisture in the fibers is removed by a water press.

### Rewinding and packing:

Finally, after drying and calendering, the fibers are made into usable paper. The final step is to pack the paper products in boxes and deliver them to customers.

### 3.2. Assumptions

In this paper, we take the papermaking industry as an example. The product-mix decision model of the Green ABC Optimal Production Plan presents the following five assumptions:

- (1) The activities in the paper mill process have been classified into four level activities (unit, batch, product, and facility). The company's ABC study team selected the appropriate resource drivers and activity drivers for the current production process.
- (2) The unit sales price of the product and the unit purchase price of the direct material do not change with the increase or decrease of the purchase quantity.
- (3) Machine capacity expansion is not considered.
- (4) With two shifts, the normal working time for each shift is 8 h, and can be extended by 4 h overtime with a higher wage rate to extend the direct working hours.
- (5) Carbon tax at different tax rates according to the level of CO<sub>2</sub> emissions and the cost of carbon dioxide emissions are regarded as a piecewise variable cost.

### 3.3. Notations

This paper uses the following variables and parameters notations:

#### Decision variables:

$X_i$  is the production quantity of product  $i$ ,  $i = 1, 2, 3, \dots, n$ ;

$(\delta_1, \delta_2)$  is an SOS1 set of 0–1 variables, where only one variable is 1;

$(\gamma_0, \gamma_1, \gamma_2)$  is an SOS2 set of non-negative variables, where at most two adjacent variables can be non-zero;

$N_{ij}$  is the number of batches of batch-level activity  $j$  ( $j \in B$ ) of product  $i$ ;

$(\lambda_1, \lambda_2, \lambda_3)$  is an SOS1 set of 0–1 variables, where only one variable must be non-zero;

$(\Phi_0, \Phi_1, \Phi_2, \Phi_3)$  is an SOS2 set of non-negative variables, where at most two adjacent variables can be non-zero;

#### Parameters:

$P_i$  is the unit sales price of product  $i$ ;

$C_m$  is the unit cost of the  $m$ th material,  $m = 1, 2, 3, \dots, s$ ;

$A_{im}$  is the demand for the  $m$ th material of product  $i$

$E_i$  is the process yield rate of product  $i$ ;

$Q_m$  is the available quantity of the  $m$ th material;

$HC_1$  is the total direct labor cost of HQ<sub>1</sub>;

$HC_2$  is the total direct labor cost of HQ<sub>2</sub>;

$HC_3$  is the total direct labor cost of HQ<sub>3</sub>;

TLH is the total hours required for direct labor;

HQ<sub>1</sub> is the total normal available hours of direct labor;

HQ<sub>2</sub> is the total direct labor hours after 2 h of overtime;

- HQ<sub>3</sub> is the total direct labor hours after 4 h of overtime;
- LH<sub>i</sub> is the required labor hours per unit of product i;
- TMC is the total costs of the machine;
- H<sub>ip</sub> is the machine hours required per unit of product i in the pth process, p = 1, 2, 3, . . . , k;
- U<sub>p</sub> is the hourly cost of the machine for the pth process;
- M<sub>p</sub> is the available machine hours of the pth process;
- d<sub>j</sub> is the activity cost of each active driver for activity j;
- K<sub>ij</sub> is the units number of each batch for batch-level activity j (j ∈ B) of product i;
- N<sub>ij</sub> is the number of batches of batch-level activity j (j ∈ B) of product i;
- R<sub>ij</sub> is the time required of the activity driver of batch-level activity j (j ∈ B) of product i;
- T<sub>j</sub> is the time restriction of the activity driver of batch-level activity j (j ∈ B);
- TVOC is the total CO<sub>2</sub> emissions;
- COV<sub>1</sub> is the carbon tax cost at COQ<sub>1</sub>;
- COV<sub>2</sub> is the carbon tax cost at COQ<sub>2</sub>;
- COV<sub>3</sub> is the carbon tax cost at COQ<sub>3</sub>;
- COQ<sub>1</sub> is the upper limit of total CO<sub>2</sub> emissions of the first carbon tax range;
- COQ<sub>2</sub> is the upper limit of total CO<sub>2</sub> emissions of the second carbon tax range;
- COQ<sub>3</sub> is the upper limit of total CO<sub>2</sub> emissions of the third carbon tax range;
- V<sub>i</sub> is the CO<sub>2</sub> emissions per unit of product i;

### 3.4. A Mathematical Programming for the Decision-Making Model

In this section, the general model proposed in this paper will be described, and a numerical example for illustration of how to apply this model to a real case company is presented in Section 4. A numerical example for illustration.

The optimal green product-mix decision model under ABC is depicted as follows:

Maximize Z = Total Revenue

- Total Unit Activity Cost (Direct Material Cost, Direct Labor Cost, Machine Cost)
- Total Batch Activity Cost (Inventory Handling Cost, Set-up Cost)
- Carbon Tax Cost
- Environment Regulatory Cost

$$\begin{aligned}
 &= \sum_{i=1}^n P_i X_i - \sum_{i=1}^n \sum_{m=1}^s C_m A_{im} (1 \div E_i) X_i - [HC_1 + (HC_2 - HC_1)\gamma_1 + (HC_3 - HC_1)\gamma_2] \\
 &\quad - \sum_{i=1}^n \sum_{p=1}^r U_p H_{ip} X_i - \sum_{i=1}^n \sum_{j \in B} d_j R_{ij} N_{ij} - (COV_1 \Phi_1 + COV_2 \Phi_2 + COV_3 \Phi_3) - F \tag{1}
 \end{aligned}$$

#### 3.4.1. Total Revenue

The total revenue is represented by  $\sum_{i=1}^n P_i X_i$ , where P<sub>i</sub> is the unit sales prices of products i; X<sub>i</sub> is the number of sales of the ith product.

#### 3.4.2. Total Direct Material Cost: Unit-Level Cost

In this paper, we assume that direct materials are purchased at a fixed price. Therefore, the direct material cost function is a linear function. A<sub>im</sub> represents the mth material requirement of the ith product; there are 1 to n products and 1 to s raw materials. E<sub>i</sub> represents the process yield rate of product i. The decision-maker decides the maximum resource (Q<sub>m</sub>) available for each raw material according to the actual cost information previously provided by the accounting department. The total material costs are represented by  $[\sum_{i=1}^n \sum_{m=1}^s C_m A_{im} (1 \div E_i) X_i]$ , which is associated with the constraints expressed in Equation (2). The function of material cost is shown in Figure 4.

Direct material constraints:

$$\sum_{i=1}^n \sum_{m=1}^s A_{im}(1 \div E_i)X_i \leq Q_m \quad m = 1, 2, 3, \dots, s \tag{2}$$

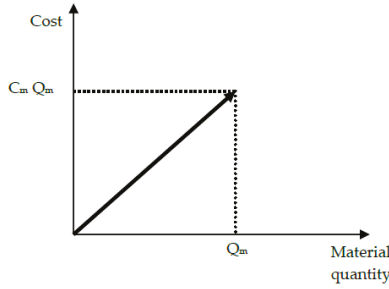

Figure 4. The direct material cost function.

3.4.3. Total Direct Labor Costs: Unit-Level Cost

According to the government’s labor law, the direct labor time and direct labor cost of paper mills can be expanded at a higher wage rate through overtime or night shifts in the short term. Figure 5 shows the detailed total labor cost conditions. The normal direct working hours available are given as HQ<sub>1</sub> and the corresponding direct labor costs are a fixed amount of HC<sub>1</sub>. Next, direct labor hours can be extended to HQ<sub>2</sub> and HQ<sub>3</sub> through overtime or night shifts, and the total labor costs are presented as HC<sub>2</sub> and HC<sub>3</sub>, respectively. The total direct labor costs are expressed as [HC<sub>1</sub> + (HC<sub>2</sub> – HC<sub>1</sub>) γ<sub>1</sub> + (HC<sub>3</sub> – HC<sub>1</sub>) γ<sub>2</sub>] as in Equation (1).

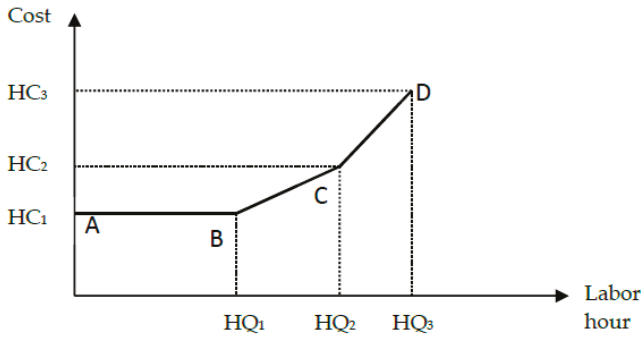

Figure 5. The piecewise direct labor cost function.

Equations (3)–(8) represent the total labor hours required under the relevant constraints. The TLH indicates the total labor hours required for a papermaking mill, as shown in Equation (3). In Equations (4)–(8), (δ<sub>1</sub>, δ<sub>2</sub>) is an SOS1 set of 0–1 variables, where only one variable will be 1; δ<sub>1</sub> = 1 and δ<sub>2</sub> = 1 indicate that the total labor hour falls within the second range [HQ<sub>1</sub>, HQ<sub>2</sub>] and the third range [HQ<sub>2</sub>, HQ<sub>3</sub>] of labor hour, respectively, in Figure 5. (γ<sub>0</sub>, γ<sub>1</sub>, γ<sub>2</sub>) is an SOS2 set of non-negative variables, where at most two adjacent variables can be non-zero [52]. When γ<sub>0</sub> and γ<sub>1</sub> are non-zero, it means that the total labor hour falls within the second range [HQ<sub>1</sub>, HQ<sub>2</sub>]; when γ<sub>1</sub> and γ<sub>2</sub> are non-zero, it means that the total labor hour falls within the third [HQ<sub>2</sub>, HQ<sub>3</sub>]. Besides, when γ<sub>0</sub> = 1, γ<sub>1</sub> = 1, and γ<sub>2</sub> = 1, it means that the data point will be B, C, and D, respectively. When δ<sub>1</sub> = 1, δ<sub>2</sub> = 0,

$\gamma_0 = 1$ , and  $\gamma_1 = \gamma_2 = 0$ , the data point will fall within the first segment AB, where  $TLH \leq HQ_1$ , and the total direct labor cost is  $HC_1$ .

For instance, if  $\delta_1 = 1$ , then  $\delta_2 = 0$  from Equation (8);  $\gamma_0 \leq 1$ ,  $\gamma_1 \leq 1$ ,  $\gamma_2 = 0$ ,  $\gamma_0 + \gamma_1 = 1$  from Equations (4)–(7), which means that the paper mills will need to work overtime. However, if  $\gamma_0 = 1$ , then  $\gamma_1 = \gamma_2 = 0$ ; this means that overtime work is not required. Furthermore, if  $\delta_1 = 0$ , then  $\delta_2 = 1$  from Equation (8),  $\gamma_0 = 0$ ,  $\gamma_1 \leq 1$ ,  $\gamma_2 \leq 1$ , and  $\gamma_1 + \gamma_2 = 1$  from Equations (3)–(7), then the total required labor hour is  $HQ_1 + (HQ_2 - HQ_1) \gamma_1 + (HQ_3 - HQ_1) \gamma_2$ , indicating that the paper mills need production overtime. The total direct labor costs are represented by  $[HC_1 + (HC_2 - HC_1) \gamma_1 + (HC_3 - HC_1) \gamma_2]$ .

Unit-level direct labor hour constraints:

$$TLH = HQ_1 + (HQ_2 - HQ_1)\gamma_1 + (HQ_3 - HQ_1)\gamma_2 \tag{3}$$

$$\gamma_0 - \delta_1 \leq 0 \tag{4}$$

$$\gamma_1 - \delta_1 - \delta_2 \leq 0 \tag{5}$$

$$\gamma_2 - \delta_2 \leq 0 \tag{6}$$

$$\gamma_0 + \gamma_1 + \gamma_2 = 1 \tag{7}$$

$$\delta_1 + \delta_2 = 1 \tag{8}$$

### 3.4.4. Total Machine Cost: Unit-Level Cost

In this paper, we assume that the machine cost function is a linear function,  $H_{ip}$  represents the machine hours required per unit of product  $i$  in the  $p$ th process and there are  $n$  products and  $r$  machines. The maximum machine hours available for each machine per month are 528 h (24 h/day  $\times$  22 days/month), and regarding machine depreciation hourly as machine cost per hour for each machine.  $U_p$  represents the hourly cost of the machine for the  $p$ th process. The total machine costs are represented by  $(\sum_{i=1}^n \sum_{p=1}^r U_p H_{ip} X_i)$ , where the associated constraints are shown in Equation (9).

Machine hour constraints:

$$\sum_{i=1}^n \sum_{p=1}^r H_{ip} X_i \leq M_p \quad p = 1, 2, \dots, r \tag{9}$$

### 3.4.5. Batch Activity Cost Function for Inventory Handling and Setup Activities

The total batch activity costs are represented by  $(\sum_{i=1}^n \sum_{j \in B} d_j R_{ij} N_{ij})$ , where the associated constraints are shown in Equations (10) and (11).

Batch activity constraints:

$$X_i \leq K_{ij} N_{ij} \quad i = 1, 2, \dots, n; j \in B \tag{10}$$

$$\sum_{i=1}^n R_{ij} N_{ij} \leq T_j, \quad i = 1, 2, \dots, n; j \in B \tag{11}$$

### 3.4.6. Carbon Tax Function

Although new green production technologies can reduce carbon dioxide emissions, there are still carbon dioxide emissions from the steam supply device of the paper-making machine. Equation (12) is used to quantify  $CO_2$  emissions during the production process. It also assumes that taxation is taxed at different tax rates based on the quantity of  $CO_2$  emissions, so as to support the government’s carbon tax policy and fulfill the company’s social responsibility. In other words, as carbon dioxide emissions increase, the carbon tax will also increase. Therefore, the total cost of carbon dioxide emissions will be a piecewise linear function consisting of three different tax rates as shown in Figure 6. Carbon dioxide

emissions could increase from COQ<sub>1</sub> to COQ<sub>2</sub> and COQ<sub>3</sub>. Therefore, the total carbon tax costs are COV<sub>1</sub>, COV<sub>2</sub>, and COV<sub>3</sub> at COQ<sub>1</sub>, COQ<sub>2</sub>, and COQ<sub>3</sub>, respectively [53].

In Equations (13)–(18), (λ<sub>1</sub>, λ<sub>2</sub>, λ<sub>3</sub>) is an SOS1 set of 0–1 variables, where only one variable must be non-zero; (Φ<sub>0</sub>, Φ<sub>1</sub>, Φ<sub>2</sub>, Φ<sub>3</sub>) is an SOS2 set of non-negative variables, where at most two adjacent variables can be non-zero [51].

The first segment: if λ<sub>1</sub> = 1 (λ<sub>2</sub>, λ<sub>3</sub> = 0, from Equation (18)), then Φ<sub>0</sub> ≤ 1; Φ<sub>1</sub> ≤ 1; Φ<sub>2</sub> ≤ 0; Φ<sub>3</sub> ≤ 0; and Φ<sub>0</sub> + Φ<sub>1</sub> = 1 from Equations (13)–(17). Then the total CO<sub>2</sub> emission and the total carbon tax costs of the paper-making mill are COQ<sub>1</sub>Φ<sub>1</sub> and COV<sub>1</sub>Φ<sub>1</sub>, respectively. This expresses that (COQ<sub>1</sub>Φ<sub>1</sub>, COV<sub>1</sub>Φ<sub>1</sub>) is the linear combination of (0, 0) and (COQ<sub>1</sub>, COV<sub>1</sub>).

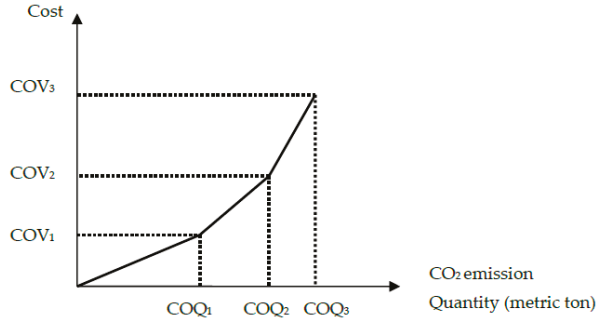

Figure 6. The carbon tax cost function.

The second segment: if λ<sub>2</sub> = 1 (λ<sub>1</sub>, λ<sub>3</sub> = 0, from Equation (18)), then Φ<sub>0</sub> ≤ 0; Φ<sub>1</sub> ≤ 1; Φ<sub>2</sub> ≤ 1; Φ<sub>3</sub> ≤ 0; and Φ<sub>1</sub> + Φ<sub>2</sub> = 1 from Equations (13)–(17). Then the total CO<sub>2</sub> emission and the total carbon tax costs of the paper-making mill are COQ<sub>1</sub>Φ<sub>1</sub> + COQ<sub>2</sub>Φ<sub>2</sub> and COV<sub>1</sub>Φ<sub>1</sub> + COV<sub>2</sub>Φ<sub>2</sub>, respectively. This expresses that (COQ<sub>1</sub>Φ<sub>1</sub> + COQ<sub>2</sub>Φ<sub>2</sub>, COV<sub>1</sub>Φ<sub>1</sub> + COV<sub>2</sub>Φ<sub>2</sub>) is the linear combination of (COQ<sub>1</sub>, COV<sub>1</sub>) and (COQ<sub>2</sub>, COV<sub>2</sub>).

The third segment: if λ<sub>3</sub> = 1 (λ<sub>1</sub>, λ<sub>2</sub> = 0, from Equation (18)), then Φ<sub>0</sub> ≤ 0; Φ<sub>1</sub> ≤ 0; Φ<sub>2</sub> ≤ 1; Φ<sub>3</sub> ≤ 1; and Φ<sub>2</sub> + Φ<sub>3</sub> = 1 from Equations (13)–(17). Then the total CO<sub>2</sub> emission and the total carbon tax costs of the paper-making mill are COQ<sub>2</sub>Φ<sub>2</sub> + COQ<sub>3</sub>Φ<sub>3</sub> and COV<sub>2</sub>Φ<sub>2</sub> + COV<sub>3</sub>Φ<sub>3</sub>, respectively. This expresses that (COQ<sub>2</sub>Φ<sub>2</sub> + COQ<sub>3</sub>Φ<sub>3</sub>, COV<sub>2</sub>Φ<sub>2</sub> + COV<sub>3</sub>Φ<sub>3</sub>) is the linear combination of (COQ<sub>2</sub>, COV<sub>2</sub>) and (COQ<sub>3</sub>, COV<sub>3</sub>). In short, if the paper-making mill generates excessive carbon dioxide emissions, this will lead to an increase in the carbon tax rate. The total costs of carbon dioxide emissions are expressed as (COV<sub>1</sub>Φ<sub>1</sub> + COV<sub>2</sub>Φ<sub>2</sub> + COV<sub>3</sub>Φ<sub>3</sub>), whose associated constraints are shown as follows:

CO<sub>2</sub> emission constraints:

$$TVOC = COQ_1\Phi_1 + COQ_2\Phi_2 + COQ_3\Phi_3 \tag{12}$$

$$\Phi_0 - \lambda_1 \leq 0 \tag{13}$$

$$\Phi_1 - \lambda_1 - \lambda_2 \leq 0 \tag{14}$$

$$\Phi_2 - \lambda_2 - \lambda_3 \leq 0 \tag{15}$$

$$\Phi_3 - \lambda_3 \leq 0 \tag{16}$$

$$\Phi_0 + \Phi_1 + \Phi_2 + \Phi_3 = 1 \tag{17}$$

$$\lambda_1 + \lambda_2 + \lambda_3 = 1 \tag{18}$$

### 3.5. Energy Recycling

In reducing environmental pollution, the use of recycled waste paper as raw material is more economical than using pulpwood [54]. In this paper, Company P used recycled paper as a part of raw materials; to decrease costs and reduce the environmental impact, the quantity of recycled paper used will increase in the future. In addition, by using cogeneration equipment (also known as electrothermal co-production), the energy released from the combustion of fuel simultaneously generates electric and thermal energy, and surplus electricity and heat can be sold in order to use energy more efficiently.

After coagulating the sedimentation of wastewater treatment, the resulting sludge contains fibers from pulp dishing and filler from the white water dishing of paper mills. Its principal components include calcium carbonate, magnesium carbonate, and fiber, which can be used as a soil amendment after drying, and is mainly sold to farmers for composting (high magnesium fertilizer). When coal is combusted in a boiler to generate power, heavier dust particles are discharged from the bottom of the boiler, called bottom ash; it can be used for construction landfill, brick making, artificial aggregate, and building materials.

### 3.6. Other Sale and Production Constraints

The use of paper is very extensive and is mainly divided into the following six purposes:

- (1) *Culture Paper*: As the information transmission and cultural heritage used, it is closely related with the printing industry, for common cultural paper such as coated paper, Dowling paper, newsprint, etc.
- (2) *Industrial paper*: Used to manufacture paper boxes, cartons, paper cups that need to be processed by the operation; it is called industrial paper, common industrial paper such as Liner board, corrugating medium, Coated whiteboard, Chipboard, etc.
- (3) *Packaging paper*: Manufacturing paper bags, shopping bags of paper, such as wrapping paper, Kraft paper, etc.
- (4) *Household paper*: Paper used related to health care or home life, such as toilet paper, facial tissues, napkins, etc.
- (5) *Information paper*: In response to the rise of office automation and computer list machines, the rapid development of paper in recent years, such as plain copy paper, inkjet printing paper, thermal paper, no carbon required paper, etc.
- (6) *Other paper*: Paper made for other uses, such as rice paper, banknote paper, rust-proof paper, etc.

The case company (Company P) in this paper is a small and medium-sized company with a monthly output of about 3000 tons. Its products are mainly for the packaging market. For example, product 3 is used for the fruit protection of fruit trees to prevent sunburn and insect or bird bites. Product 2 is used for the packaging of fried foods to prevent oil leakage. In particular, product 3 is used for the packaging of department store boutiques. As the monthly demand in Taiwan is limited to 500 tons per month, there are fewer mills producing product 3, but the prices are relatively higher.

Thus, the model proposed in this paper is used to find the optimal product mix to achieve the maximum profit under the constraints of production resources, market demand, and carbon emission quota. Therefore, when these limit variables change, the optimal product mix will change accordingly. If there are market demand limits of products, we can add the constraints for the product demand's upper limits. Similarly, if there is a minimum efficient scale of production, we can add the constraints for the products' lower limits. This means that the model should be built based on the real situations; then we can use the model to find the useful solutions.

## 4. A Numerical Example for Illustration

### 4.1. Example Data and Optimal Decision Analysis

This article provides a numerical example to illustrate how the ABC (Activity-based Costing) is applied in a mathematical programming model to decide the optimal product-mix. The illustrative data are shown in Table 1.

Assume that Company P (case company) uses three kinds of direct materials ( $m = 1, 2, 3$ ) to produce three kinds of products 1, 2 and 3 ( $i = 1, 2, 3$ ). When Company P uses the ABC cost system to determine the optimal product-mix, it is required to compute the following basic activity costs: (1) unit-level activity cost: These costs include material, labor and machine costs; (2) Batch-level activity costs such as, the costs of inventory handling and machine set-up; (3) Facility-level activity costs, including plant management costs and compliance with environmental regulatory costs. Table 1 lists the relevant data for this example. The cost of compliance with environmental regulation refers to the cost of dealing with routine inspections, waste discharge and disposal, and ensuring that the production process complies with local government laws and environmental regulations. This study assumes that the cost of compliance with environmental regulatory is a fixed cost, represented as a constant \$30,000 per month.

Company P has to determine the optimal quantity of products for each product based on its current capabilities. Equations (1)–(18) are the equations for the green production planning decision model in this model, which are specifically expressed as follows:

Maximize  $Z = \text{Total Revenue}$

- Total Unit Level Activity Cost (direct material cost, direct labor cost, machine cost)
- Total Batch Level Activity Cost (inventory handling cost, set-up cost)
- Carbon Tax Cost
- Facility Level Activity Cost (plant management and environment regulatory cost)

$$= \sum_{i=1}^n P_i X_i - \sum_{i=1}^n \sum_{m=1}^s C_m A_{im} (1 \div E_i) X_i - [HC_1 + (HC_2 - HC_1)\gamma_1 + (HC_3 - HC_1)\gamma_2] \\ - \sum_{i=1}^n \sum_{p=1}^r U_p H_{ip} X_i - \sum_{i=1}^n \sum_{j \in B} d_j R_{ij} N_{ij} - (COV_1 \Phi_1 + COV_2 \Phi_2 + COV_3 \Phi_3) - 30,000 \quad (19)$$

$$= (1700 \times X_1 + 1400 \times X_2 + 1200 \times X_3) - [(670 \times 0.80 + 200 \times 0.15 + 2500 \times 0.05)/0.89 \times X_1 + \\ (670 \times 0.70 + 200 \times 0.20 + 2500 \times 0.10)/0.9 \times X_2 + (670 \times 0.65 + 200 \times 0.30 + 2500 \times 0.05)/0.91 \times \\ X_3] - [190,080 + (253,440 - 190,080) \times \gamma_1 + (332,640 - 190,080) \times \gamma_2] - [(50 \times 0.12 + 250 \times 0.22 \\ + 12 \times 0.13) \times X_1 + (50 \times 0.12 + 250 \times 0.18 + 12 \times 0.12) \times X_2 + (50 \times 0.12 + 250 \times 0.17 + 12 \times \\ 0.11) \times X_3] - [(18 \times 1) \times N_{11} + (18 \times 1) \times N_{21} + (18 \times 1) \times N_{31}] - [(100 \times 5) \times N_{12} + (100 \times 4) \\ \times N_{22} + (100 \times 4) \times N_{32}] - (10,000 \times \Phi_1 + 19,000 \times \Phi_2 + 31,000 \times \Phi_3) - 30,000$$

Subject to sales quantity:

$$X_1 \leq 500$$

Subject to direct material:

$$0.80/0.89 \times X_1 + 0.70/0.90 \times X_2 + 0.65/0.91 \times X_3 \leq 2200$$

$$0.15/0.89 \times X_1 + 0.20/0.90 \times X_2 + 0.30/0.91 \times X_3 \leq 700$$

$$0.05/0.89 \times X_1 + 0.10/0.90 \times X_2 + 0.05/0.91 \times X_3 \leq 300$$



Table 1. The example data.

	j	i	Product 1	Product 2	Product 3	Available Capacity
Maximum Demand (Ton)		$P_i$	1700	1400	1200	$X_1 \leq 500$
Selling price (USD/ton)		$A_{i1}$	0.80	0.70	0.65	$Q_1 \leq 2000$
Direct material	m = 1	$C_1 = \$670/\text{ton}$	0.15	0.20	0.30	$Q_2 \leq 700$
	m = 2	$C_2 = \$200/\text{ton}$				$Q_3 \leq 300$
	m = 3	$C_3 = \$2500/\text{ton}$	0.05	0.10	0.05	
$E_i$			89%	90%	91%	
Direct labor constraint	$HC_1 = 190,080$	$HC_2 = 253,440$	$HC_3 = 332,640$			
Cost	$HQ_1 = 31,680$	$HQ_2 = 39,600$	$HQ_3 = 47,520$			
Labor hours (hr)	$WR1 = 6$	$WR2 = 8$	$WR3 = 10$			
Wage rate (USD/ hr)						
Labor hours (hr/ton)		$LH_i$	18	16	15	
Pulping (hr/ton)	Machine hours	$U_1 = \$50/\text{hr}$	$H_{i1}$	0.12	0.12	$MH_1 = 528$
paper making (hr/ton)	Machine hours	$U_2 = \$250/\text{hr}$	$H_2$	0.22	0.18	$MH_2 = 528$
Rewinding (hr/ton)	Machine hours	$U_2 = \$12/\text{hr}$	$H_{i3}$	0.13	0.12	$MH_3 = 352$
Batch-level activity	Handling hours	$d_1 = \$18/\text{hr}$	$R_{i1}$	1	1	$T_1 = 528$
Inventory handling	hours		$K_{i1}$	100	100	
Set-up	Set-up hours	$d_2 = \$100/\text{hr}$	$R_{i2}$	5	4	$T_2 = 528$
			$K_{i2}$	400	600	
CO <sub>2</sub> emission constraint	$COV_1 = 60,000$	$COV_2 = 114,000$	$COV_3 = 195,000$			
Cost (USD)	$COQ_1 = 2500$	$COQ_2 = 4000$	$COQ_3 = 5500$	$V_1$	1.2	1
Emission quantities	$TR1 = 24$	$TR2 = 36$	$TR3 = 54$			0.9
Tax rate (USD/ton)						
Environmental regulatory costs.	Total fix cost	\$30,000				

Subject to direct labor hour:

$$\begin{aligned}
 18 \times X_1 + 16 \times X_2 + 15 \times X_3 - 31680 - (39600 - 31680) \times \gamma_1 - (47520 - 31680) \times \gamma_2 &\leq 0 \\
 \gamma_0 - \delta_1 &\leq 0 \\
 \gamma_1 - \delta_1 - \delta_2 &\leq 0 \\
 \gamma_2 - \delta_2 &\leq 0 \\
 \gamma_0 + \gamma_1 + \gamma_2 &= 1 \\
 \delta_1 + \delta_2 &= 1
 \end{aligned}$$

Subject to machine hour:

$$\begin{aligned}
 0.12 \times X_1 + 0.12 \times X_2 + 0.12 \times X_3 &\leq 528 \\
 0.22 \times X_1 + 0.18 \times X_2 + 0.17 \times X_3 &\leq 528 \\
 0.13 \times X_1 + 0.12 \times X_2 + 0.11 \times X_3 &\leq 352
 \end{aligned}$$

Subject to batch-level inventory handling:

$$\begin{aligned}
 X_1 - 100 \times N_{11} &\leq 0 \\
 X_2 - 100 \times N_{21} &\leq 0 \\
 X_3 - 100 \times N_{31} &\leq 0 \\
 1 \times N_{11} + 1 \times N_{21} + 1 \times N_{31} &\leq 528
 \end{aligned}$$

Subject to batch-level setup:

$$\begin{aligned}
 X_1 - 400 \times N_{12} &\leq 0 \\
 X_2 - 600 \times N_{22} &\leq 0 \\
 X_3 - 600 \times N_{32} &\leq 0 \\
 5 \times N_{12} + 4 \times N_{22} + 4 \times N_{32} &\leq 528
 \end{aligned}$$

Subject to VOC emission:

$$\begin{aligned}
 1.2 \times X_1 + 1 \times X_2 + 0.9 \times X_3 - 2500 \times \Phi_1 - 4000 \times \Phi_2 - 5500 \times \Phi_3 &\leq 0 \\
 \Phi_0 - \lambda_1 &\leq 0 \\
 \Phi_1 - \lambda_1 - \lambda_2 &\leq 0 \\
 \Phi_2 - \lambda_2 - \lambda_3 &\leq 0 \\
 \Phi_3 - \lambda_3 &\leq 0 \\
 \Phi_0 + \Phi_1 + \Phi_2 + \Phi_3 &= 1 \\
 \lambda_1 + \lambda_2 + \lambda_3 &= 1
 \end{aligned}$$

We use the mathematical programming decision model and LINGO 16.0 software to examine the sample data and derive an optimal solution as shown in Table 2.

**Table 2.** The optimal solution for example data.

$X_1 = 500$	$X_2 = 1415$	$X_3 = 910$
$\delta_1 = 0$	$\delta_2 = 1$	
$\gamma_0 = 0$	$\gamma_1 = 0.2815657$	$\gamma_2 = 0.7184343$
$N_{11} = 5$	$N_{21} = 15$	$N_{31} = 10$
$N_{12} = 2$	$N_{22} = 3$	$N_{32} = 2$
$\lambda_1 = 0$	$\lambda_2 = 1$	$\lambda_3 = 0$
$\Phi_0 = 0$	$\Phi_1 = 0.7773333$	$\Phi_2 = 0.2226667$
$\Phi_3 = 0$		

According to the results of the above-mentioned production plan decision model solution, the monthly optimal product-mix of the green production plan decision is  $(X_1, X_2, X_3) = (500, 1415, 910)$ , which requires 2200 tons ( $= 0.8 \div 0.89 \times 500 + 0.7 \div 0.90 \times 1415 + 0.65 \div 0.91 \times 910$ ) of the first kind of material; 698 tons ( $= 0.15 \div 0.89 \times 500 + 0.20 \div 0.90 \times 1415 + 0.30 \div 0.91 \times 910$ ) of the second kind of material; 235 tons ( $= 0.05 \div 0.89 \times 500 + 0.10 \div 0.90 \times 1415 + 0.05 \div 0.91 \times 910$ ) of the third kind of material; 45,290 ( $= 18 \times 500 + 16 \times 1415 + 15 \times 910$ ) direct labor hours; 339 machine hours ( $= 0.12 \times 500 + 0.12 \times 1415 + 0.12 \times 910$ ) of the first process of machinery; 520 machine hours ( $= 0.22 \times 500 + 0.18 \times 1415 + 0.17 \times 910$ ) of the second process of machinery; 335 machine hours ( $= 0.13 \times 500 + 0.12 \times 1415 + 0.11 \times 910$ ) of the third process of machinery, and 2834 tons ( $= 1.2 \times 500 + 1 \times 1415 + 0.9 \times 910$ ) of CO<sub>2</sub> emissions. The maximum profit (Z) is \$1,154,258. This entails that the total direct labor hours are expanded to 45,290 h by adding 13,610 overtime hours, and CO<sub>2</sub> emissions are expanded to 2834 tons; there are 343 extra CO<sub>2</sub> emissions requiring a higher carbon tax.

#### 4.2. Sensitivity Analysis

In recent years, the world has been suffering from PM2.5, and Taiwan is no exception. PM2.5 often reaches the red alert level in Central and Southern Taiwan in the winter. According to reports by Taiwan's Environmental Protection Agency, one-third of Taiwan's PM2.5 is mainly derived from industrial development. The government is planning to double the carbon tax rate in order to effectively guide Company P to reduce air pollution emissions. If so, the CO<sub>2</sub> emission costs of Company P will increase by \$72,024 ( $= 24 \times 2500 + 36 \times 334$ ) and the maximum profit will be reduced to \$1,082,234. The details are shown in Table 3. Therefore, this year, Company P will blend RDF-5 with coal as a fuel for boilers to effectively reduce CO<sub>2</sub> emissions.

**Table 3.** The increase in carbon emission costs by doubling the carbon tax rate.

CO <sub>2</sub> Emissions (Ton)	Tax Rate (USD/Ton)	CO <sub>2</sub> EmissionCosts	Tax Rate (USD/Ton)	CO <sub>2</sub> EmissionCosts	Difference
( $\lambda_1 = 1$ ) 2500	24	60,000	48	120,000	60,000
( $\lambda_2 = 1$ ) 334	36	12,024	72	24,048	12,024
Total 2834		72,024		144,048	72,024

In addition, Green purchase refers to purchasing products that fully consider reducing the environmental burden [55], and express a preference for the environment by purchasing products or services that can improve environmental protection [56]. Company P also attaches great importance to the use of recycled paper as a raw material. Although recycled paper with a higher quality is usually costs about 30% higher than the average purchase price, the case company is still actively developing pulping technology and plans to increase the proportion of recycled paper usage to 50% to fulfill its social responsibilities and reduce production costs. If this goal can be achieved, the monthly optimal product-mix of the green production planning decision will be changed into  $(X_1, X_2, X_3) = (500, 1141, 1250)$ , with the maximum profit increased to \$ 1,519,473.

## 5. Shop Floor Control under Industry 4.0 in Paper Industry

### 5.1. Status Monitoring

Due to the innovation of production technology, the pattern of our industrial production has been transformed from labor-intensive into capital-intensive and technology-intensive. The original hand-made products have been replaced by automated production equipment. To be able to maintain a high competitiveness in the international market, it is necessary to improve the product quality and production efficiency. Toyota's Toyota Production System (TPS), developed in the 1970s, is also

synonymous with Lean Production. The TPS integrates a set of methods and tools with management concepts to completely eliminate seven forms of waste (Muda), including overproduction, excessive inventory, poor quality, unnecessary conveyance, over processing, unnecessary motion, waiting for work, and to produce profit through cost reduction. [57]. Lean Production (TPS) defines everything that does not create value as waste [58], and is widely recognized and accepted in industrial environments. It involves a rigorous integration of human manufacturing processes, continuous improvement, and a focus on value-added activities by avoiding waste [59]. However, to achieve the goal of lean production, the reliability of production equipment is an important determinant. That is, the production efficiency and product quality depend on the effective maintenance of the equipment. There is a famous statement in the factory: “maintenance is more important than repair, and repair is more important than purchase”; it fully expresses the importance of maintenance in equipment management.

To ensure the safe and stable operation of equipment, while taking into account the reliability and availability of the equipment, the early diagnosis, control, and prevention of equipment failures provide an important guarantee for the safe operation and smooth production in the factory. The implementation of equipment monitoring is based on the past usage of the equipment and the current operating conditions combined with maintenance records. It is thus possible to determine whether the equipment is abnormal, and to predict the useful life of the equipment without stopping the equipment and disassembling the selected components; therefore, equipment monitoring can maximize the economic benefits under a fully safe environment.

Under Industry 4.0, experts are establishing a machine-specific model to track the changes, regimes and health status of each machine, such as by building cyber-twins to manage various components of bearings and gearboxes. The cyber-twins can offer self-awareness and self-prediction to machines and their components. The self-awareness can provide machines with the ability to assess the operational status of individual machines, while self-prediction can help to predict the future behavior of each machine and provide proper alerts and maintenance instructions [60]. The diagram of the data and information flow in a cyber-physical system-enabled plant is shown in Figure 7.

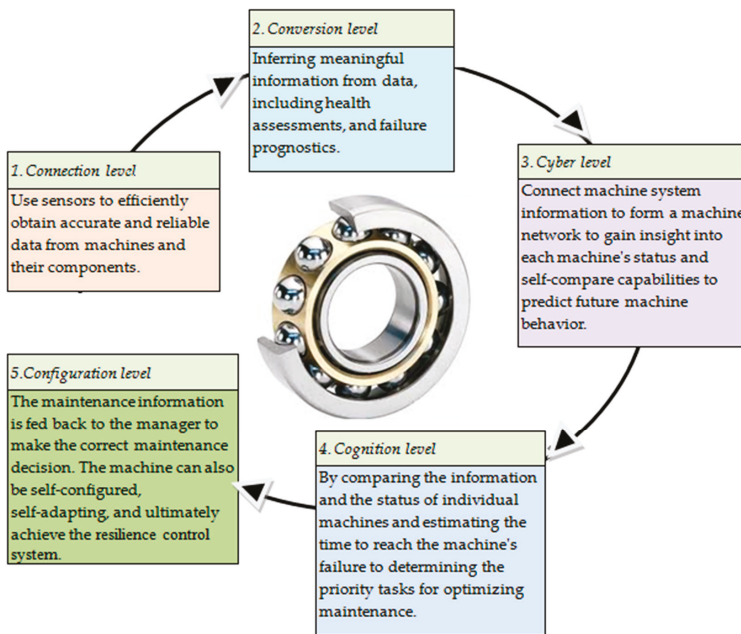

Figure 7. The diagram of the data and information flow in a Cyber-physical system-enabled plant.

Company P, in this paper, is using vibration diagnosis to detect paper machine bearing fault conditions. A general paper machine is 25 m in length and 8 m high; the vibration measurement process uses a dual-channel spectrum analyzer and accelerometer on the roller bearing position to select 9 measurement points for horizontal, vertical and axial vibration measurements in three directions, and the measured vibration signal transmitted to the laboratory through the 8 channel signal recorder to do a detailed analysis, in order to determine the deterioration of the bearings for preventive maintenance. Implementation results in the machine operating rate increasing by 15%, and the product non-performing rate decreasing by 20%.

## 5.2. Quality Control

IoT and smart manufacturing comprise the basic core of Industry 4.0. In the production process, machines and related detection components can collect and share production data in real time as the ultimate result of the production process. Produce quality can supply insights into machine status through reverse reasoning algorithms. It can also supply feedback for system management to adjust the production schedules [61]. SPC (Statistical Process Control) mainly refers to the statistical method applied to real-time quality monitoring in the production process. The product quality information in the production process is divided scientifically into random fluctuations and abnormal fluctuations. When the quality abnormality trend is significant in the production process, it will alert managers in real time to take appropriate measures to eliminate anomalies and recover the machine to its normal state of stability in order to achieve quality control [62]. The basic principles and methods of SPC were proposed by Dr. Shewhart in the 1930s. The purpose of SPC is to effectively monitor and control the quality of the products in the production process. After World War II, Japan was the first to widely promote and apply SPC in the industrial field during the period 1950–1980. As a result, Japan's products are among the best in the world in terms of quality and productivity.

In the past, Company P used manual data collection and statistical analysis when applying the SPC method; the main shortcoming was that the processing time was too long and difficult to implement. Sensors are now used to collect data (Product quality data: Thickness, Dryness; Production parameters: Pulp concentration, Production speed, Pressure roller clearance, Vapor supply; Input data: Raw materials, working hours, machine hours, carbon emissions, overhead) and use PLC, MES and IoT for data statistics, analysis, transmission and monitoring. When the thickness of the product exceeds the control boundary, the monitoring system will transmit the abnormal information to the manager. The manager immediately adjusts the production parameters to restore the product quality to normal and avoids a large number of defective products due to delayed processing. At the same time, through the quality abnormality correction mechanism (cause analysis, propose improvement measures, implement improvement, improve quality performance: improve yield rate/reduce quality cost), we eliminate the cause of poor quality, prevent abnormal recurrences, and improve the quality performance. The schematic diagram of SPC joint correction improvement is shown in Figure 8.

In addition, in terms of the cost of the product, when the actual product cost calculated by the ABC cost system is higher than the standard cost, the ABC traceability function can be used to find the over-consumed resources, and the improvement mechanism is implemented according to the above-mentioned correction and improvement mechanism, and various improvement methods are used to improve or break through the limitations of resource bottlenecks to improve production efficiency and effectively reduce product costs.

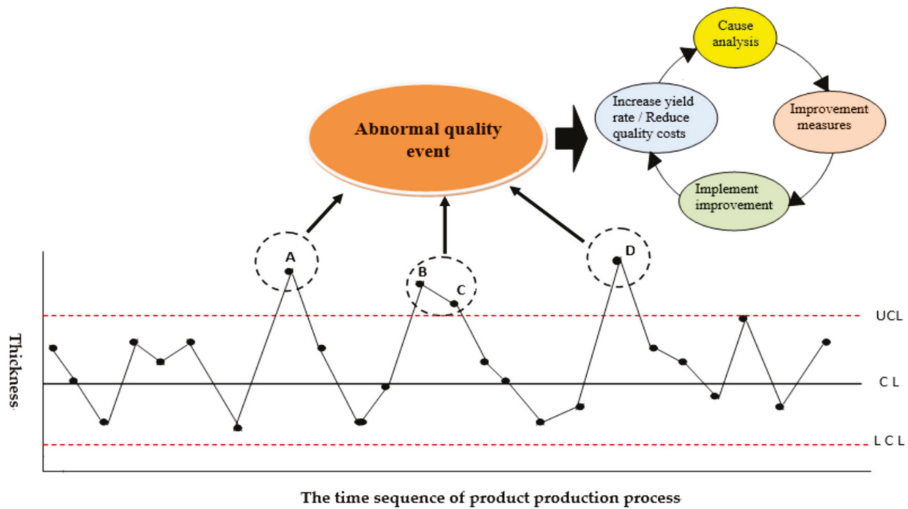

Figure 8. The schematic diagram of SPC joint correction improvement.

## 6. Discussion

### 6.1. Managerial Insights for Industrial Practitioners

In addition to the accurate and complete product cost estimation, the ABC cost method can provide company managers with a clearer understanding of the resource consumption of different products and processes [63], in order that cost management and product mix can be improved, which enables optimal pricing and production decisions. In addition, timely and reliable acquisition of production-related data is an important factor in order to obtain accurate product cost estimates. Currently, due to the development of related technologies in Industry 4.0, various Sensor devices can be installed on machines, and production data can be obtained in a more timely and accurate manner [64], which improves the use efficiency of ABC and greatly reduces the cost of manually collecting production data, as conducted in the past.

However, in the process of pursuing the most profitable product mix, enterprises are often limited by their limited resources in the short-term, which affects the company's profit target. Therefore, in the long run, enterprises must use various improvement technologies to enable the internal resources of the company to be effectively used, which can simultaneously break through the limitations of bottleneck resources and achieve the effect of improving business performance [65].

The lack of laborers and rising labor costs are the current operational difficulties faced by enterprises all over the world, which forces companies to work hard to gain production automation, as IT technology has promoted the boom of Industry 4.0 in recent years [66]. Enterprises can use industry 4.0 related technology to integrate software and hardware in production control, in order that the replenishment, manufacturing, monitoring, adjustment, and timely improvements of the production process can be automatically completed in the production environment of Industry 4.0, which significantly improves the efficiency of business operations [67].

In summary, a company manager can fully integrate the methods and technologies of ABC, TOC, and Industry 4.0 in business management. With the use of timely and accurate production cost information, a company can break through the limitations of the internal bottlenecked resources of the company through the improvement of related technologies developed by Industry 4.0. Business managers can make the right business decisions and help their company become a world-class company.

## 6.2. Related Issues & Future Research Directions

There are some related issues not involved in this research. These could be possible future research directions.

### 6.2.1. Multiple-Objective Problem

This paper only considers the production resources and carbon dioxide emission costs invested in the current production process of the paper industry and uses the product mix decision model to obtain the best product mix to achieve the single goal of maximum profit. Future research may attempt to extend these technologies to a variety of industries and different activities. This is because volume discounts, including product sales prices and material procurement costs, are placed in product mix decision models to reflect changes in real-world economic operating environments. In addition, in the face of the diversified needs of consumers, business operators need to exert their creativity to pursue current trends, but also take measures to foster product diversity and fast supplying in order to win the competitive advantage. Therefore, while planning their own profit targets, companies must also consider the multi-objective considerations of customer service levels and supplier profits [68]. This is also the direction of future research.

### 6.2.2. Efficiency Using DEA (Data Envelopment Analysis)

In 1978, Charnes, Cooper, and Rhodes proposed “Data Envelopment Analysis (DEA)” as a tool to measure the efficiency and productivity of decision-making units [69]. DEA is considered a relatively new “data-oriented” approach for evaluating the performance of peer decision-making units (DMUs) with multiple performance measures that convert multiple inputs into multiple outputs [70]. The single objective of this paper is to determine the product mix for the maximum profit through ABC’s accurate cost calculation according to the cost structure, price, and resource constraints of each product. Therefore, it is slightly different from the purpose of using DEA and can be listed as a direction for future research.

### 6.2.3. Cap-and-Trade Issue

With the rapid development of human economic activities, carbon emissions have been further aggravated. In recent decades, the global temperature has risen much faster than in previous periods; therefore, reducing carbon emissions is an important issue for the world’s governments. Many governments have developed policies to regulate carbon emissions. The European Union Emissions Trading Scheme (EU ETS), as established in 2005, actively promotes cap-and-trade regulations. Therefore, companies must make a tradeoff between spending in the carbon market and reducing carbon emissions. At the same time, the Eurobarometer survey found that nearly 50% of consumers have a preference for low-carbon products and are willing to pay higher prices to buy low-priced products [71]. Based on the above background, the impacts of cap-and-trade regulations and consumers’ preference for low-carbon products during business decision-making is the direction of future research.

In addition, governments in various countries have been seeking many policies to reduce carbon emissions, and integrated carbon taxes and carbon trading are considered to be the most effective regulatory mechanisms. The government determines the mechanism of carbon taxes and the quota allocation for carbon emissions and pursues social welfare as its biggest goal. Enterprises, on the other hand, consider the cost of carbon emissions between carbon taxes and carbon trading, and determine their output and sales volume under the goal of maximizing profits [72]. Therefore, how to use the carbon tax and carbon trading model structure to strike a balance between environmental protection and enterprise development, in order that both parties are satisfied, is also a direction for future studies.

#### 6.2.4. The Cost of Stopping Due to Problems in Machines

The tangible losses caused by machine failure and shutdown roughly include reduced production losses and losses due to poor quality, such as remanufacturing, scrapping, customer complaints, etc. While intangible losses include credit losses, reduced safety, low employee sentiment, etc.

This shows the importance of preventive diagnosis and maintenance of machines. Therefore, this study specifically proposes the use of related technologies developed by Industry 4.0 to implement status monitoring [60] in Section 5.1, in order to reduce the machine failure rate and improve production performance. However, since the relevant sensors for production data collection have not yet been fully installed in Company P, it is difficult to calculate the cost of these actual losses in detail, which is a limitation of this study. The impact of machine downtime on production costs can be incorporated into future research models.

#### 6.2.5. The Cost of the Periodic Maintenance of the Machines

Regarding the periodic maintenance of machines; in the past, general mechanical maintenance was performed on a regular basis through the estimated lifetime of the components according to intuitive experience. However, the service life of components, as estimated by intuition experience, is often inaccurate, and the data of the actual use time of parts is difficult to collect, which makes it difficult to conduct regular maintenance on machinery. Therefore, companies usually wait until a machine has a problem or fails to repair a fault, thus, in addition to the original maintenance costs (mainly including parts costs, labor costs, and downtime production loss), losses may also include huge quality failure costs. Now, through the development of Industry 4.0, companies can collect mechanical operating parameters through sensors, and diagnose production line equipment through the Internet of Things and big data analysis technology to reduce the chance of sudden equipment failure [73]. Generally, the estimated benefit can reduce Maintenance costs by 20–25%, eliminate unexpected downtime by 70–75%, and increase productivity by 20–25%, thus, it can be seen that the stability and normality of the production line equipment of the factory has deeply affected the competitiveness of the manufacturing industry. Therefore, this study specifically proposes the use of Industry 4.0 technology to implement status monitoring [74] in Section 5.1 to arouse the attention and interest of industry in promoting Industry 4.0. However, since the relevant sensors for mechanical operating parameters collection have not yet been fully installed in Company P, it is difficult to calculate the maintenance costs in detail, which is a limitation of this study. The cost-benefit analysis of using related technologies of Industry 4.0 for the periodic maintenance of machines is listed as the direction for future research.

#### 6.2.6. The Application of Related Technologies Developed by Industry 4.0 in Environmental Pollution Prevention and Control

It is well known that carbon dioxide emissions and sewage discharge are the main causes of environmental pollution [75]. In the past, the Taiwan Environmental Protection Agency did not regularly assign auditors to factories to conduct the monitoring of carbon dioxide emissions and sewage discharge. However, due to insufficient manpower, the results were not significant. Now we can use sensors to sample in the environment of Industry 4.0, and then analyze and monitor the issues through the Internet of Things, big data, and cloud technology, and display the results for relevant management units in a timely manner to achieve the effects of saving manpower and real-time automatic monitoring. “The application of related technologies developed by Industry 4.0 in environmental pollution prevention and control” can be incorporated into future research.

#### 6.2.7. The Model Validated against Real Data

Since Taiwan’s current carbon tax system is still under review by the Legislative Yuan, the case proposed by this study is based on the pre-determined carbon tax rate in its draft to try to calculate the possible impact. This is a limitation of this study. Other data, such as product prices, material prices,



labor costs, and mechanical depreciation, are the actual average data from the past six months. Due to the formal implementation of the carbon tax system in Taiwan, the impacts of carbon emission costs in this research model are included in the direction of future research.

6.2.8. The Detail Diagram of Circular Economy in Paper Industry

In recent years, the circular economy (CE) has received more and more attention around the world. CE promotes the use of closed-loop production models within the economy. Its purpose is to improve resource utilization efficiency, especially focussing on the recycling of industrial waste, to achieve a better balance and harmony between the economy, the environment and society [76]. Figure 3 presented in this study is the main process of the ABC cost calculation in the paper industry. In the future, the concept of a circular economy will be used to incorporate the cost-benefit analysis of energy improvement and waste recycling into the future research scope. Figure 9 shows a detailed diagram of the circular economy in the paper industry.

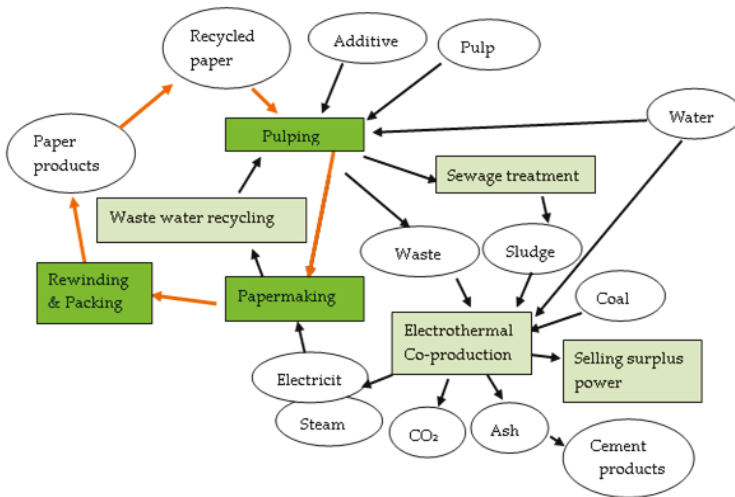

Figure 9. A schematic diagram of the interaction of the circular economy in the paper industry.

6.2.9. The Application of Related Technologies Developed by Industry 4.0

Industry 4.0 has become a hot topic in recent years, as it can be applied to various industries [66]. This study briefly introduces the role that Industry 4.0 can play in data collection and production control, thereby arousing the attention of Taiwanese industries to understand and apply related technologies developed by Industry 4.0, which is in its infancy in the paper industry. This study, adds “What Industry 4.0 can do for the paper industry” as a topic for future research.

7. Conclusions

As economic environments are changing rapidly, the prices of products and raw materials are volatile. In addition, as the government’s environmental laws and regulations have become more rigorous, the awareness of social responsibility has gradually increased, and these factors affect company costs and profits. Therefore, from the point of view of the enterprise, how to establish a suitable mathematical programming model for a production planning mechanism to deal with changes in business environments, and provide timely access to the optimal product-mix to obtain the highest profit are the most anticipated issues for managers.

The purpose of this paper is mainly to integrate the TOC constraints (such as direct labor constraints, available machine constraints, and direct material supply constraints) under the ABC costing system, and integrate piecewise linear functions to estimate direct labor costs and carbon dioxide emission costs. A mathematical programming model was developed and used to prepare a production plan with the optimal green product mix. An illustrative numerical example was used to illustrate the application of the model. This model allows companies to make timely production decisions for the optimal production mix, as based on the changes in the production environment and constraints (e.g., fluctuations in supply and price of production resources, changes in product market demand, adjustments to environmental regulations, etc.). This is the primary contribution of this research. In addition, this paper proposes the use of Industry 4.0-related technologies for the paper industry; for example, Industry 4.0 can be used in shop floor processes to monitor machine status and quality control. Its benefits actively cause the business community to understand and consider Industry 4.0, which promotes interest in Industry 4.0-related technology investments.

In the literature, there are some related research articles. For example, Tsai et al. (2012) used the mathematical programming model to make the best decisions for green production capacity expansion in for food industry [77], and Tsai et al. (2013) used the ABC method to accurately calculate environmental costs and proposed the production decision model math by using mathematical programming for the automotive industry [78]. Recher et al. [79] also used the ABC method to develop the Activity-based Emission (ABE) Analysis approach for measuring the carbon footprint of business processes. This research extended these research articles and Industry 4.0 to propose a green production and planning approach for the paper industry.

The research model of this study fully demonstrates the relationship between ABC, TOC, and Industry 4.0 in Section 2.6; while Section 6.1 details its management implications, which can be used as an important reference model for companies to improve their cost structure. This is the most important value of this research. Therefore, when enterprises use this model to measure their resource costs, carbon emission costs, and related resource constraints currently used, if the enterprise cannot obtain the profit it deserves, it means that their manufacturing costs are too high. At this time, the function of ABC's resources tracing can be used to identify costly resources and inefficient processes or activities (including CO<sub>2</sub> emissions), and then, improve them by various improvement methods (including Industry 4.0 related technologies), thus, gradually optimizing the optimal product mix, and finally, achieving the goal of obtaining the most profit.

**Author Contributions:** W.-H.T. provided the research idea, the research purpose, and designed the research; S.-Y.L. collected and analyzed the data and wrote the paper; W.-H.T. provided the research method, supervised, corrected, and revised this paper. All authors have read and approved the final manuscript.

**Funding:** This research was funded by the Ministry of Science and Technology of Taiwan under Grant No. MOST106-2410-H-008-020-MY3.

**Acknowledgments:** The authors are extremely grateful to the *sustainability* journal editorial team and reviewers who provided valuable comments for improving the quality of this article. The authors also would like to thank the Ministry of Science and Technology of Taiwan for financial support of this research under Grant No. MOST106-2410-H-008-020-MY3.

**Conflicts of Interest:** The authors declare no conflict of interest.

## References

1. Lee, J. Industry 4.0 in Big Data Environment. *German Harting Magazine*, January 2014; 8–10.
2. Lasi, H.; Fettke, P.; Kemper, H.G.; Feld, T.; Hoffmann, M. Industry 4.0. *Bus. Inf. Syst. Eng.* **2014**, *6*, 239–242. [[CrossRef](#)]
3. Cooper, R.; Kaplan, R.S. Measure costs right: Make the right decision. *Harv. Bus. Rev.* **1988**, *66*, 96–103.
4. Kee, R.; Schmidt, C. A comparative analysis of utilizing activity-based costing and the theory of constraints for making product-mix decisions. *Int. J. Prod. Econ.* **2000**, *63*, 1–17. [[CrossRef](#)]

5. Spoede, C.; Henke, E.; Umble, M. Using activity analysis to locate profitability drivers: ABC can support a theory of constraints management process. *Manag. Account.* **1994**, *75*, 43–48.
6. Kugele, A.; Jelinek, F.; Gaffal, R. *Aircraft Particulate Matter Emission Estimation through All Phases of Flight*; EEC/SEE/2005/0014; Eurocontrol Experimental Centre: Les Bordes, France, 2005.
7. Mayor, K.; Tol, R.S.J. The impact of the EU-US Open Skies agreement on international travel and carbon dioxide emissions. *J. Air Transp. Manag.* **2008**, *14*, 1–7. [[CrossRef](#)]
8. Upham, P. A comparison of sustainability theory with UK and European airports policy and practice. *J. Environ. Manag.* **2001**, *63*, 237–248. [[CrossRef](#)] [[PubMed](#)]
9. Upham, P.; Raper, D.; Thomas, C.; McLellan, M.; Lever, M.; Lieuwen, A. Environmental capacity and European air transport: Stakeholder opinion and implications for modeling. *J. Air Transp. Manag.* **2004**, *10*, 199–205. [[CrossRef](#)]
10. Tsai, W.-H.; Shen, Y.-S.; Lee, P.-L.; Chen, H.-C.; Kuo, L.; Huang, C.-C. Integrating information about the cost of carbon through activity-based costing. *J. Clean. Prod.* **2012**, *36*, 102–111. [[CrossRef](#)]
11. Tonn, B. An equity first, risk-based framework for managing global climate change. *Glob. Environ. Chang.* **2003**, *13*, 295–306. [[CrossRef](#)]
12. Sathre, R.; Gustavsson, L. Effects of energy and carbon taxes on building material competitiveness. *Energy Build.* **2007**, *39*, 488–494. [[CrossRef](#)]
13. Hewitt, P.S. Depopulation and ageing in Europe and Japan the hazardous transition to a labor shortage economy. *Int. Polit. Ges.* **2002**, *1*, 111–120.
14. Lucke, D.; Constantinescu, C.; Westkämper, E. Smart Factory—A Step towards the Next Generation of Manufacturing. In *Manufacturing Systems and Technologies for the New Frontier*; Mitsubishi, M., Ueda, K., Kimura, F., Eds.; Springer: London, UK, 2008; pp. 115–118.
15. Kagermann, H.; Helbig, J.; Hellinger, A.; Wahlster, W. *Recommendations for Implementing the Strategic Initiative INDUSTRIE 4.0: Securing the Future of German Manufacturing Industry*; Final Report of the Industrie 4.0 Working Group; Forschungsunion: Frankfurt, Germany, 2013.
16. Abramovici, M.; Stark, R. (Eds.) Smart Product Engineering. In Proceedings of the 23rd CIRP Design Conference, Bochum, Germany, 11–13 March 2013.
17. Schlechtendahl, J.; Keinert, M.; Kretschmer, F.; Lechler, A.; Verl, A. Making existing production systems Industry 4.0-ready. *Prod. Eng. Res. Dev.* **2015**, *9*, 143–148. [[CrossRef](#)]
18. Lee, J.; Bagheri, B.; Kao, H.A. A Cyber-Physical Systems architecture for Industry 4.0-based manufacturing systems. *Manuf. Lett.* **2015**, *3*, 18–23. [[CrossRef](#)]
19. Sheng, P.; Srinivasan, M.; Kobayashi, S. Multi-objective process planning in environmentally conscious manufacturing: A feature-based approach. *CIRP Ann. Manuf. Technol.* **1995**, *44*, 433–437. [[CrossRef](#)]
20. Zust, R.; Caduff, G. Live-cycle modeling as an instrument for life-cycle engineering. *CIRP Ann. Manuf. Technol.* **1997**, *46*, 351–354. [[CrossRef](#)]
21. Boons, F. Greening products: A framework for product chain management. *J. Clean. Prod.* **2002**, *10*, 495–505. [[CrossRef](#)]
22. UNFCCC (United Nations Framework on Climate Change). Adoption of the Paris Agreement. In the Report of the Conference of the Parties on its twenty-first session (held in Paris from 30 November to 13 December 2015), Addendum, Report No. FCCC/CP/2015/10/Add.1. United Nations, 29 January 2016. Available online: <http://unfccc.int/resource/docs/2015/cop21/eng/10a01.pdf> (accessed on 19 August 2016).
23. Lee, C.H.; Huang, S.Y.; Barnes, F.B.; Kao, L. Business performance and customer relationship management: The effect of IT. Organisational contingency and business process on Taiwanese manufacturers. *Total Qual. Manag. Bus. Excell.* **2010**, *21*, 43–65. [[CrossRef](#)]
24. Tsai, W.-H.; Yang, C.-H.; Chang, J.-C.; Lee, H.-L. An activity-based costing decision model for life cycle assessment in green building projects. *Eur. J. Oper. Res.* **2014**, *238*, 607–619. [[CrossRef](#)]
25. Georgiadis, P.; Vlachos, D. The effect of environmental parameters on product recovery. *Eur. J. Oper. Res.* **2004**, *157*, 449–464. [[CrossRef](#)]
26. Chen, W.Y.; Jim, C.Y. Resident valuation and expectation of the urban greening project in Zhuhai, China. *J. Environ. Plan. Manag.* **2011**, *54*, 851–869. [[CrossRef](#)]
27. Bansal, P.; Roth, K. Why companies go green: A model of ecological responsiveness. *Acad. Manag. J.* **2000**, *43*, 717–736.

28. Majumdar, S.K.; Marcus, A.A. Rules versus discretion: The productivity consequences of flexible regulation. *Acad. Manag. J.* **2001**, *44*, 170–179.
29. Liu, L.; Ma, X. Technology-based industrial environmental management: A case study of electroplating in Shenzhen, China. *J. Clean. Prod.* **2010**, *18*, 1731–1739. [[CrossRef](#)]
30. Christmann, P. Effects of “best practices” of environmental management on cost advantage: The role of complementary assets. *Acad. Manag. J.* **2000**, *43*, 663–680.
31. Tsai, W.-H. Activity-based costing model for joint products. *Comput. Ind. Eng.* **1996**, *31*, 725–729. [[CrossRef](#)]
32. Tsai, W.-H.; Hsu, J.-L.; Chen, C.-H. Integrating activity-based costing and revenue management approaches to analyse the remanufacturing outsourcing decision with qualitative factors. *Int. J. Revenue Manag.* **2007**, *1*, 367–387. [[CrossRef](#)]
33. Tsai, W.-H.; Kuo, L. Operating costs and capacity in the airline industry. *J. Air Transp. Manag.* **2004**, *10*, 269–275. [[CrossRef](#)]
34. Tsai, W.-H.; Hsu, J.-L. Corporation social responsibility programs choice and costs assessment in the airline industry: A hybrid model. *J. Air Transp. Manag.* **2008**, *14*, 188–196. [[CrossRef](#)]
35. Kim, Y.-W.; Ballard, G. Activity-based costing and its application to lean construction. In Proceedings of the 9th Annual Conference of the International Group for Lean Construction, Singapore, 6–8 August 2001.
36. Tsai, W.-H. Quality cost measurement under activity based costing. *Int. J. Qual. Reliab. Manag.* **1998**, *15*, 719–752. [[CrossRef](#)]
37. Roztocki, N. Using the integrated activity-based costing and economic value added information system for project management. In Proceedings of the Seventh Americas Conference on Information Systems, Boston, MA, USA, 2–5 August 2001; pp. 1454–1460.
38. Fichman, R.G.; Kemerer, C.F. Activity-based costing for component-based software development. *Inf. Technol. Manag.* **2002**, *3*, 137–160. [[CrossRef](#)]
39. Tsai, W.-H.; Lai, C.-W. Outsourcing or capacity expansions: Application of activity-based costing model on joint product decisions. *Comput. Oper. Res.* **2007**, *34*, 3666–3681. [[CrossRef](#)]
40. Tsai, W.-H.; Hung, S.-J. Treatment and recycling system optimisation with activity based costing in WEEE reverse logistics management: An environmental supply chain perspective. *Int. J. Prod. Res.* **2009**, *47*, 5391–5420. [[CrossRef](#)]
41. Tsai, W.-H.; Hung, S.-J. A fuzzy goal programming approach for green supply chain optimisation under activity-based costing and performance evaluation with a value chain structure. *Int. J. Prod. Res.* **2009**, *47*, 4991–5017. [[CrossRef](#)]
42. Tsai, W.-H. A technical note on using work sampling to estimate the effort on activities under activity-based costing. *Int. J. Prod. Econ.* **1996**, *43*, 11–16. [[CrossRef](#)]
43. Turney, P.B.B. *Common Cents—The ABC Performance Breakthrough, How to Succeed with Activity-Based Costing*; Cost Technology: Hillsboro, OR, USA, 1992.
44. Turney, P.B.B. What an activity-based cost model looks like. *J. Cost Manag.* **1992**, *5*, 54–60.
45. Turney, P.B.B. *Common Cents: How to Succeed with Activity-Based Costing and Activity-Based Management*, 2nd ed.; McGraw-Hill: New York, NY, USA, 2005.
46. Cooper, R. Cost classification in unit-based and activity-based manufacturing cost systems. *J. Cost Manag.* **1990**, *4*, 4–14.
47. Holmen, J.S. ABC vs. TOC: It’s a Matter of Time. *Manag. Account. Montvale* **1995**, *76*, 37–40.
48. Noreen, E.; Smith, D.; Mackey, J.T. *The Theory of Constraints and Its Implications for Management Accounting*; North River Press: Great Barrington, MA, USA, 1995.
49. Plenert, G. Optimizing theory of constraints when multiple constrained resources exist. *Eur. J. Oper. Res.* **1993**, *70*, 126–133. [[CrossRef](#)]
50. Luebbe, R.; Finch, B. Theory of constraints and linear programming. *Int. J. Prod. Res.* **1992**, *30*, 1471–1478. [[CrossRef](#)]
51. Kletti, J. (Ed.) *Manufacturing Execution System-MES*; Springer: New York, NY, USA, 2007.
52. Williams, H.P. *Model Building in Mathematical Programming*, 2nd ed.; Wiley: New York, NY, USA, 1985; pp. 173–177.
53. Tsai, W.-H.; Lin, S.-J.; Liu, J.-Y.; Lin, W.-R.; Lee, K.-C. Incorporating life cycle assessments into building project decision making: An energy consumption and CO<sub>2</sub> emission perspective. *Energy* **2011**, *36*, 3022–3029. [[CrossRef](#)]

54. Pati, R.K.; Vrat, P.; Kumar, P. Economic analysis of paper recycling vis-à-vis wood as raw material. *Int. J. Prod. Econ.* **2006**, *103*, 489–508. [[CrossRef](#)]
55. Da Cunha Lemos, Â.D.; Giacomucci, A. Green procurement activities: So environmental indicators and practical actions taken by industry and tourism. *Int. J. Environ. Sustain. Dev.* **2002**, *1*, 59–72. [[CrossRef](#)]
56. Faith-Ell, C.; Balfors, B.; Folkesson, L. The application of environmental requirements in Swedish road maintenance contracts. *J. Clean. Prod.* **2006**, *14*, 163–171. [[CrossRef](#)]
57. Wagner, T.; Herrmann, C.; Thiede, S. Industry 4.0 impacts on lean production systems. *Procedia CIRP* **2017**, *63*, 125–131. [[CrossRef](#)]
58. Shah, R.; Ward, P.T. Defining and developing measures of lean production. *J. Oper. Manag.* **2007**, *25*, 785–805. [[CrossRef](#)]
59. Mrugalska, B.; Wyrwicka, M.K. Towards Lean Production in Industry 4.0. *Procedia Eng.* **2017**, *182*, 466–473. [[CrossRef](#)]
60. Bagheri, B.; Yang, S.; Kao, H.-A.; Lee, J. Cyber-Physical Systems architecture for self-aware machines in Industry 4.0-based environment. *IFAC-PapersOnLine* **2015**, *48*, 1622–1627. [[CrossRef](#)]
61. Lee, J.; Bagheri, B.; Kao, H.A. Recent Advances and Trends of Cyber-Physical Systems and Big Data Analytics in Industrial Informatics. In Proceedings of the 2014 12th International Conference on Industrial Informatics (INDIN), Porto Alegre, Brazil, 27–30 July 2014.
62. Woodall, W.H.; Montgomery, D.C. Research Issues and Ideas in Statistical Process Control. *J. Qual. Technol.* **1999**, *31*, 376–386. [[CrossRef](#)]
63. Tsai, W.H.; Hsu, J.L.; Chen, C.H.; Chou, Y.W.; Lin, S.J.; Lin, W.R. Application of ABC in hot spring country inn. *Int. J. Manag. Enterp. Dev.* **2010**, *8*, 152–174. [[CrossRef](#)]
64. Sauer, O. Information Technology for the Factory of the Future—State of the Art and Need for Action. *Procedia CIRP* **2014**, *25*, 293–296. [[CrossRef](#)]
65. Glock, C.H.; Jaber, M.Y. Learning effects and the phenomenon of moving bottlenecks in a two-stage production system. *Appl. Math. Model.* **2013**, *37*, 8617–8628. [[CrossRef](#)]
66. Qin, J.; Liu, Y.; Grosvenor, R. A Categorical Framework of Manufacturing for Industry 4.0 and Beyond. *Procedia CIRP* **2016**, *52*, 173–178. [[CrossRef](#)]
67. Lee, J.; Kao, H.A.; Yang, S. Service innovation and smart analytics for Industry 4.0 and big data Environment. *Procedia CIRP* **2014**, *16*, 3–8. [[CrossRef](#)]
68. Tzeng, G.H.; Tang, T.I.; Hung, Y.M.; Chang, M.L. Multiple-objective planning for a production and distribution model of the supply chain: Case of a bicycle manufacturer. *J. Sci. Ind. Res.* **2006**, *65*, 309–320.
69. Charnes, A.; Cooper, W.W.; Rhodes, E. Measuring the efficiency of decision-making units. *Eur. J. Oper. Res.* **1978**, *2*, 429–444. [[CrossRef](#)]
70. Zhou, H.; Yang, Y.; Chen, Y.; Zhu, J. Data envelopment analysis application in sustainability: The origins, development and future directions. *Eur. J. Oper. Res.* **2018**, *264*, 1–16. [[CrossRef](#)]
71. Wang, X.; Xue, M.; Xing, L. Analysis of Carbon Emission Reduction in a Dual-Channel Supply Chain with Cap-And-Trade Regulation and Low-Carbon Preference. *Sustainability* **2018**, *10*, 580. [[CrossRef](#)]
72. Zhang, L.; Yang, W.; Yuan, Y.; Zhou, R. An Integrated Carbon Policy-Based Interactive Strategy for Carbon Reduction and Economic Development in a Construction Material Supply Chain. *Sustainability* **2017**, *9*, 2107. [[CrossRef](#)]
73. Chesworth, D. *Industry 4.0 Techniques as a Maintenance Strategy (A Review Paper)*; Research Project: Maintenance Strategies in Industry, Glyndwr University: Wrexham, UK, January 2018.
74. Fleischmann, H.; Kohl, J.; Franke, J. A Modular Architecture for the Design of Condition Monitoring Processes. *Procedia CIRP* **2016**, *57*, 410–415. [[CrossRef](#)]
75. Wang, S.; Hao, J. Air quality management in China: Issues, challenges, and options. *J. Environ. Sci.* **2012**, *24*, 2–13. [[CrossRef](#)]
76. Ghisellini, P.; Cialani, C.; Ulgiati, S. A review on circular economy: The expected transition to a balanced interplay of environmental and economic systems. *J. Clean. Prod.* **2016**, *114*, 11–32. [[CrossRef](#)]
77. Tsai, W.-H.; Lin, W.-R.; Fan, Y.-W.; Lee, P.-L.; Lin, S.-J.; Hsu, J.-L. Applying a mathematical programming approach for a green product mix decision. *Int. J. Prod. Res.* **2012**, *50*, 1171–1184. [[CrossRef](#)]

78. Tsai, W.-H.; Chen, H.-C.; Leu, J.-D.; Chang, Y.-C.; Lin, T.W. A product-mix decision model using green manufacturing technologies under activity-based costing. *J. Clean. Prod.* **2013**, *57*, 178–187. [[CrossRef](#)]
79. Recker, J.; Rosemann, M.; Gohar, E.R. Measuring the carbon footprint of business processes. In Proceedings of the International Conference on Business Process Management in Lecture Notes in Business Information Processing, Hoboken, NJ, USA, 13–16 September 2010; Volume 66, pp. 511–520.



© 2018 by the authors. Licensee MDPI, Basel, Switzerland. This article is an open access article distributed under the terms and conditions of the Creative Commons Attribution (CC BY) license (<http://creativecommons.org/licenses/by/4.0/>).

Article

# A Framework of Production Planning and Control with Carbon Tax under Industry 4.0

Wen-Hsien Tsai \* and Yin-Hwa Lu

Department of Business Administration, National Central University, 300, Zhongda Rd., Jhongli, Taoyuan 32001, Taiwan; anglalu@yahoo.com.tw

\* Correspondence: whtsai@mgt.ncu.edu.tw; Tel.: +886-3-4267247; Fax: +886-3-4222891

Received: 23 August 2018; Accepted: 5 September 2018; Published: 8 September 2018

**Abstract:** In recent years, the international community has placed great emphasis on environmental protection issues. The United Nations has also successively enacted relevant laws and regulations to restrain international greenhouse gas emissions and some countries implemented carbon tax levies to reduce air pollution. The tire industry is a manufacturing industry with high pollution and high carbon emissions; therefore, the purpose of this paper is to propose a framework of production planning and control with carbon tax under Industry 4.0 and use the tire industry as the illustrative example. In this framework, the mathematical programming model, with Activity-Based Costing (ABC) and Theory of Constraints (TOC) for production planning, is used to achieve the optimal solution under various production and sale constraints in order to find the optimal product-mix maximizing the profit. On the other hand, Industry 4.0 utilizes new technologies such as 3D printing, robot and automated guided vehicle (AGV) and links all the components in the manufacturing systems by using various sensor systems, Cyber-Physical Systems (CPS) and Internet of Things (IoT) to collect and monitor the activity data of all the components in real-time, to give intelligent responses to various problems that may arise in the factory by the real-time analysis results of cloud computing and big data and to attain the various benefits of Industry 4.0 implementation. The parameters of the mathematical programming model will be updated periodically from the new big data set. In this paper, an illustrative example is used to demonstrate the application of the model. From the optimal solution and sensitivity analyses on increasing the raw material's prices and carbon taxes will affect the profits. This framework can provide a general approach to help companies execute production management in the way of more efficiency, less cost, lower carbon emission and higher quality across the value chain for the tire industry and other industries.

**Keywords:** Activity-Based Costing (ABC); Industry 4.0; tire industry; carbon emission; carbon tax; mathematical programming; sustainability

---

## 1. Introduction

While Industry 4.0 has emerged in the manufacturing industry in recent years, the introduction of Industry 4.0 in the manufacturing industry is still rare [1]. In recent years, consolidating the real economy has been emphasized by governments at all levels as one of the important components of the economy, thus, modern manufacturing industries are receiving great attention by related industries and governments at all levels. Hermann et al. [2] pointed out that interoperability and modularity result in the processing of huge amounts of data, as produced by these heterogeneous devices; data processing and integration with other systems for industrial processes, including the core context of Industry 4.0, remain research challenges.

In recent years, the international community has placed considerable emphasis on environmental protection issues and the United Nations has also successively enacted relevant laws and regulations



such as international greenhouse gas emissions and the 2015 Paris Accord (UNFCCC, 2016), in the hope that the environment we live in will not continue to deteriorate. Due to the developments of science and technology and the result of high industrialization, anthropocentric greenhouse gases are continually generated and accumulated, leading to increased global warming with deteriorating climate and environmental ecology. In the past decade, it has been well recognized that environmental and economic performance are mutually reinforcing, such as improved environmental performance leading to lower costs, increased sales and raising economic efficiency. Different perspectives and empirical studies suggest that more attention should be paid to the causal relationship between eco-efficiency and different environmental management approaches [3,4], as well as their economic consequences. For example, the implementation of the carbon tax will help to improve the environment.

The purpose of this paper is to propose a framework of production planning and control with carbon tax under Industry 4.0 and use the tire industry as the illustrative example. This framework is shown in Figure 1. In this framework, the mathematical programming model is used to imitate the real situation of business to achieve the optimal solution under various production and sale constraints, where Activity-Based Costing (ABC) [5] is used to calculate the accurate costs of activities and products for the tire industry and Theory of Constraints (TOC) [6,7] is used to formulate the constraints related to production and sale or cost-associated. This is the “production planning” part of the framework, which will give the optimal production and sale target and the profit target in the manufacturing operation for the management, that is, it uses the mathematical programming model to find the optimal product-mix maximizing the profit under various constraints.

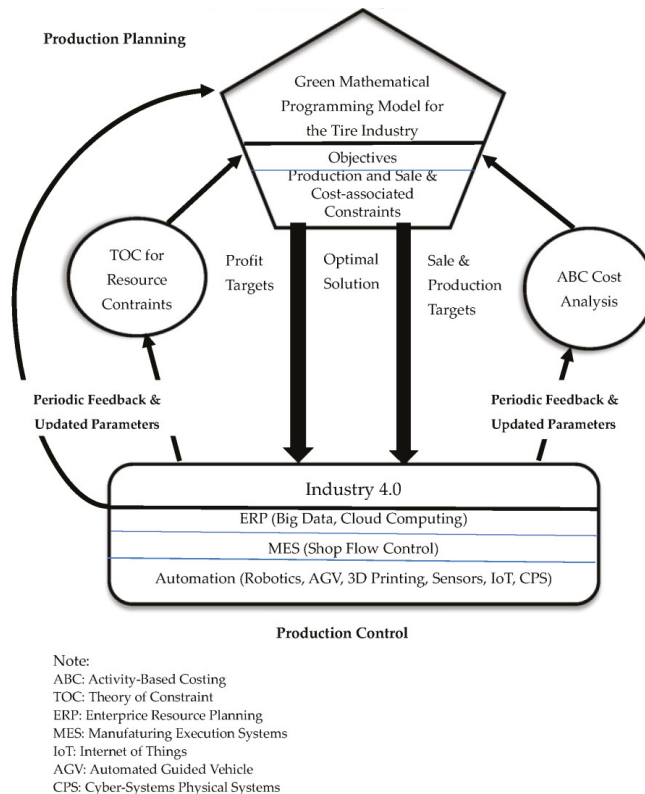

**Figure 1.** Framework of this Research—The Linkage of Mathematical Programming Model and Industry 4.0.



On the other hand, the related technologies of Industry 4.0 are used to control the manufacturing activities to achieve the profit and sale targets. Industry 4.0 is composed of three tiers of technologies including the automation technologies for manufacturing activities, the Manufacturing Execution Systems (MES) for shop floor control [8–11] and the Enterprise Resource Planning Systems (ERP) [12] for big data analysis [13–15] and cloud computing [16]. That is, Industry 4.0 utilizes new technologies such as 3D printing, robot and automated guided vehicle (AGV) [17,18] and links all the components in the manufacturing systems by using various sensors systems, Cyber-Physical Systems (CPS) [19,20] and Internet of Things (IoT) [15,21,22]. Then, the system will real-timely collect and monitor the activity data of all the components and give intelligent responses to various problems that may arise in the factory by the real-time analysis results of cloud computing and big data [22]. The parameters of the mathematical programming model will be updated periodically from the new big data set. For example, ABC cost parameters can be updated from more real data.

Based on the framework mentioned above, the remainder of this paper is organized into five sections. Section 2 describes the research background of this research. Section 3 develops the green production planning model for the tire industry with ABC and TOC. An illustrative example is presented in Section 4 to demonstrate how to apply the model proposed in this paper and to conduct the sensitivity analysis. Shop floor control under Industry 4.0 in Tire industry is explained in Section 5. Finally, conclusions are presented in Section 6.

## **2. Research Background**

### *2.1. Brief of Industry 4.0*

The Industrial Internet of Things (IIoT) addresses the economic, ecological and social aspects of sustainable value creation for manufacturers. The core of technology is more important than its technical foundation and economic discussions are still in infancy. Using exploratory multi-case research methods and semi-structured interviews with experts from manufacturing companies in three major German industries, Kiel et al. [23] found that achieving sustainable industrial value creation can be achieved through expanding technology integration of data and information. The rise of the third industrial revolution was mainly driven by the computerization of manufacturing and manufacturing processes supported by business processes and information technology, beginning with the development of smart goods, three-dimensional printers and substantive core links [15]. The development of the Internet of Things (IoT) and big data is the key concept and core of Industry 4.0. The implementation of Industry 4.0 has had profound impact on industrial value creation. Therefore, the relevance of the relevant opportunities and challenges in Industry 4.0 is studied. As a driving factor for the implementation of Industry 4.0 in the context of sustainable development, different perspectives are adopted from different company scales and industry sectors. It was found that strategy, operations, environmental and social opportunities were positive drivers of Industry 4.0 implementation, while competitiveness and future viability, as well as organizational and production challenges, hampered its progress [24]. The system is continuously developed for a variety of industries, including big data, personnel, animal or atmospheric phenomena and so forth it can instantly collect these constantly updated data for analysis.

The world is currently facing the challenge of growing capital and consumer demand, while ensuring sustainable human survival and environmental and economic development. In order to cope with this challenge, industrial value creation must be sustainable and the development of Industry 4.0 offers tremendous opportunities for sustainable manufacturing. Recent research and practice developments have outlined the different opportunities for sustainable manufacturing that showcase Industry 4.0, which use cases of retrofitting manufacturing equipment as a specific opportunity for sustainability [25]. The growth of Industry 4.0 requires more sustainable production plans to continue producing high quality products. The intelligent production systems of the future will be able to automatically configure the production of a variety of products and use it as the driver for

the implementation of Industry 4.0 in terms of sustainable development [26,27]. Information needs analysis can help reduce big data to smart data and identify possible contextual key elements. A demonstration application has been developed for the provision of context-related information [28].

## *2.2. Green Production and Environmental Protection in the Tire Industry*

In recent years, due to environmental concerns, new green manufacturing technologies have been widely explored and applied to improve operation technology and have also been used in the manufacturing investments [29–32]. In recent years, the issue of global warming has drawn ever-greater attention and carbon taxes have been adopted by various countries, such as Denmark, Norway, Sweden and the Netherlands, to reduce their carbon dioxide emissions. Economists and international organizations demand the introduction of carbon taxes as a cost-effective way to decrease greenhouse gas emissions [32,33]. Moreover, carbon duty guidelines can also promote the growth and application of renewable power sources, lay a solid foundation for implementing environmental measures and assist in the growth of the global economy [33–35]. With rapid technological progress, the tire industry has been pushed to recognize the need for environmental protection for the sustainable development of enterprises in regard to indispensable factors, such as raw materials. By embracing the concept of environmental protection, processes and products must support care of the environment and cherish resources, as well as improved product designs, equipment and surrounding operations. In addition, with the increase in corporate social responsibility awareness, the tire industry must consider the cost of carbon emissions, in order to accurately predict tire production costs and reduce the impact on environmental pollution.

## *2.3. The Current Application of Industry 4.0 in Tire Industry*

In recent years, the consolidation of the economy has been emphasized by governments at all levels and this industrial production is classified as the Industrial Internet of Things (IIoT) or Industry 4.0 [36]; the modern manufacturing industry receives great attention by related industry and governments at all levels. Various industries are working hard to improve manufacturing efficiency [37]. Beier et al. [38] proposed a way to support manufacturing execution systems to provide support for developers and practitioners. As the tire production process is complex [39], the Manufacturing Execution System (MES) in the tire production process becomes more complex. Due to the complexity of the tire process, as compared with common process industries, the design of the system architecture and the realization of an information network are much more complex; with the influence of many types of uncertain factors in the production process, the difficulty of implementing MES is increased. Thus, we must improve the traditional MES [8,9], as based on the actual situation of tire production processes, in order to meet the requirements of tire production processes.

Since 2014, with the rise of German Industry 4.0, which proposed and implemented the big data analytics architecture [40] and agenda, the data analysis of literature points out the existing deficiencies and potential research directions as the foundation for future Industry 4.0 research and related topics [41]. The tire manufacturing industry has had to abandon traditional manufacturing to achieve intelligent chemical plants; the former labor-intensive production methods oriented throughout the factory production process now sees workers replaced by smart robots. Workers only need to confirm the key activities and adjustments and press a few buttons; intelligent robots can complete the vast majority of work. Previous manual preparations of very heavy materials required a lot of labor; now, the AGV car [17,18] will automatically carry the material to its destination. After the tires are formed, the robot will automatically take the tire and move it directly to the next manufacturing process. The entire process of things, people, tooling, equipment and location information intelligent matching can truly achieve quality tracking and traceability, which enables the global tire industry to achieve the whole process of an intelligent enterprise. Through Industry 4.0 intelligent plants, the future tire industry can significantly reduce the labor intensity of employees, thus, enabling the product to achieve high-end, high value-added, high quality and energy efficiency to reach the advanced global

level. In the era of intelligent manufacturing [42], the tire industry has to seize the opportunity to transition from a traditional manufacturing enterprise to an internet platform business.

#### *2.4. Sustainability and Industry 4.0*

Kamble et al. [43] proposed a sustainability Industry 4.0 framework which included three tiers: (1) Industry 4.0 related technologies (IoT, Big data, Cloud computing, Simulation & prototype, 3D printing, Augmented reality and Robotic systems), (2) Process integration (Human-machine collaboration, Shop floor-equipment) and (3) Sustainable outcomes (Economic, Process automation and safety and Environmental protection). This framework means that companies can use the related technologies of Industry 4.0 to achieve the process integration which interconnect all the elements (machines, equipment, people, work-in-process and products) of the manufacturing systems in order to efficiently execute the manufacturing tasks using the least resources, time and energy and generating least waste and emissions. This will result in three pillars of sustainability [25,44,45]: (1) economic sustainability through using least resources, time and energy, (2) social sustainability through placing importance on the right or health of employees, community and other stakeholders, (3) environmental sustainability through using least energy, generating least waste and emission and recycling the resources [46–50]. Sustainable Industry 4.0 concept was applied in supply chains [51,52] and industrial value creation [23–25,45]; it also was investigated in different countries [38].

### **3. Production Planning Model with ABC and TOC**

ABC was developed in mid-1980 and had been a general costing method since then. In the model proposed in this paper, ABC is used to measure the costs of activities. ABC cost system can be applied to solve the shortcomings of the traditional cost system. While traditional cost system allocates factory (indirect) overhead to products by using the volume-related allocation bases (such as direct labor, direct material and machine hour), ABC allocates factory (indirect) overhead to products by using volume-related or volume-unrelated allocation bases which consider the causal relationship between overhead and products [53,54]. Especially, two-stage ABC assignment method first assigns the overhead (or resource) cost to activities by using resource drivers and then assigns activity costs to products (or cost objects) by using activity drivers [55]. That is, activities is the intermediate of ABC cost assignment and there are four levels of activities in the factory: (1) unit-level activities (performed one time when a unit is produced such as machining, 100% inspection, etc.), (2) batch-level activities (performed one time for a batch such as material handling, set-up, scheduling, sampling inspection, etc.), (3) product-level activities (performed one time for each kind of product such as product design, advertising, etc.) and (4) facility-level activities (performed for maintaining the factory operation) [56].

The ABC method can be customized to analyze different types of board decision making, which includes price and product-mix [56,57], environmental management [58], green building project, strategy and construction method selection [59–62], green supply chain management [63,64], green airline fleet planning [11], outsourcing solutions [65] and green airline fleet planning [66]. This article applies mathematical programming models and analyzes the most profitable tire product mix using the ABC approach. The ABC system has four benefits: (1) accurately identifying product costs and expenses; (2) identifying activity drivers and obtaining accurate information on value-added and non-value-added activity costs; (3) assigning costs to products or activities that consume resources by a causal way; (4) determining of non-value-added activity costs to find the opportunities and priorities of cost reduction [55,67]. These benefits can be applied to the ABC mathematical programming model of the tire industry.

In addition, systematic analysis of overhead cost can be used to find the optimal product mix decisions through linear programming and TOC [56]. Patterson [68] focused on the concept of throughput accounting, which directly links product mix solution to the TOC theory. Plenert's (1993) [53] economic planning includes using an integer linear programming method and TOC to find the optimal product mix with various restricted capital. Tsai et al. [60] employed TOC-based arithmetic to obtain the best

product mix solution. This study also uses the TOC approach to determine production priorities, as this approach can be applied to a variety of study themes for deriving the best product mix [56–58,69].

When Germany introduced Industry 4.0 in 2011, it symbolized the beginning of the fourth industrial revolution. While previous linear programming models were widely used to solve production planning problems [70–75], another important feature combined with today’s Industry 4.0 [35] is the capability to gather and make use of large amounts of data. An important driver behind Industry 4.0 is the internet and related connectivity elements, as used on the shop floor, enable machines to communicate and collaborate for production control. Therefore, this paper considers that these concepts can be used to solve the complex processes of producing tires and collect a large amount of follow-up production and control data by means of the real-time interconnection, which can propel the future research of the tire industry into the Industry 4.0 structure [25].

3.1. A Production Process for a Typical Tire Company

In the tire industry, the production process can be divided into six major activities: kneading, pressing out, cutting off, forming, vulcanizing and inspecting: (1) Kneading ( $j = 1$ ): All the rubber materials, such as soot and so forth, are sent to a kneading machine, in order to change the strength of the rubber, plastic, elasticity, durability and conduct mixed rubber manufacturing of tire products. (2) Pressing out ( $j = 2$ ): The pressing out activity applies glue and friction to produce heat to cook the rubber. (3) Cutting off ( $j = 3$ ): In the cutting-off activity, the product is sent to the cutting machine to cut the tire size and add other different elements using the cutting machine. (4) Forming ( $j = 4$ ): It is then sent to the molding assembly to carry out the forming activity, with all the materials, strips and steel rings, a prototype of the tire will be formed. (5) Vulcanizing ( $j = 5$ ): The fifth activity is to carry out the vulcanizing activity, which is to rearrange the rubber molecules; the heating and molding works will be carried out by means of steam. (6) Inspecting ( $j = 6$ ): The next inspecting activity is carried out and the finished goods are transported to the warehouse. The tire manufacturing flow chart is shown in Figure 2. In this model, assume that (1) these six activities are unit-level activities which use the resources of direct material, direct labor and machine hour, (2) there is only one batch-level activity considered in the model, that is, material handling and (3) it does not consider the product-level and facility-level activities since their costs are included in the other fixed cost.

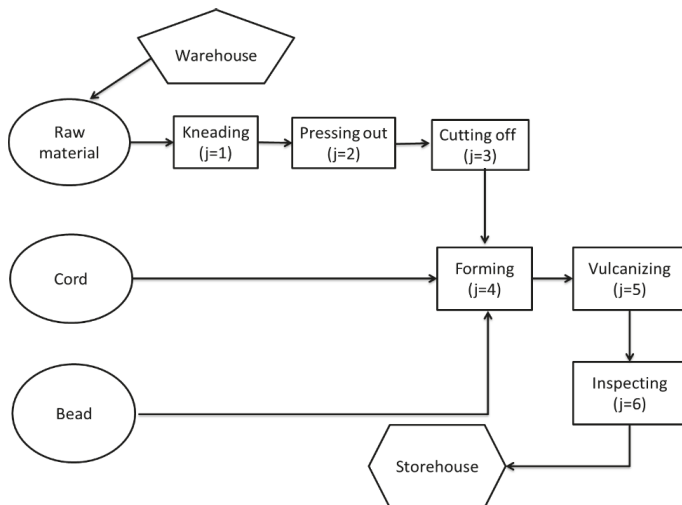

Figure 2. Tire manufacturing flow chart.

### 3.2. Assumptions

In the production planning model proposed in this paper, there are the following assumptions:

1. The unit price of products remains unchanged within the relevant range of planning.
2. The unit direct material costs are constant within the relevant range of planning.
3. By working overtime with higher wage rates, direct labor resources can be expanded.
4. The activities required for the tire production process and their activity drivers and the resources required for each activity and their resource drivers has been determined through ABC analyses.
5. There are hundreds of materials for producing tires. This paper assumes that the five materials (natural rubber, soot, synthetic rubber, cord and bead) with the highest proportion in the manufacturing process are used as the direct material inputs. Other materials are not included in the research of this mathematical programming model.
6. Carbon tax cost is considered as a variable cost, which is dependent on the quantity of carbon emissions and different carbon tax rates are used for different carbon tax ranges. Assume that all kinds of emissions have been calculated to the carbon equivalent.
7. The data assumed in this study are in metric tons for carbon emission and U.S. dollars for amounts, as shown in Table 1.

### 3.3. Green Production Planning Model

#### 3.3.1. Notations

The following notations for variables and parameters were used in this paper:

#### Variables:

$Q_i$	the production quantity of product $i$ for Company $T$ ;
$\varnothing_1, \varnothing_2$	a set of 0–1 variables of SOS1 (special ordered set of type 1), where only one variable will be non-zero [76,77];
$\varepsilon_1, \varepsilon_2, \varepsilon_3$	a set of 0–1 variables of SOS1 (special ordered set of type 1), where only one variable will be non-zero [76,77];
$\delta_0, \delta_1, \delta_2, \delta_3$	a set of non-negative variables of SOS2 (special ordered set of type 2), where at most two adjacent variables may be non-zero in the order of a given set [76,77];
$\phi_0, \phi_1, \phi_2$	a set of non-negative variables of SOS2 (special ordered set of type 2), where at most two adjacent variables may be non-zero in the order of a given set [76,77];
$b_i$	the number of batches for material handling of product $i$ ;

#### Parameters:

$S_i$	the unit sales price of product $i$ ;
$C_k$	the unit cost of the material $k$ ;
$\alpha_{ik}$	the requirements of material $k$ for producing a unit of product $i$ ;
$W_k$	the quantity of material $k$ available for use;
$LH_0$	the normal direct labor hours available;
$LH_1$	the maximal working hours at the first overtime rate plus the normal direct labor hours available;
$LH_2$	the maximal working hours at the first and second overtime rate plus the normal direct labor hours available;
$LC_0$	total direct labor costs at the normal direct labor hours available ( $LH_0$ );
$LC_1$	total direct labor costs at the maximal working hours at the first overtime rate plus the normal direct labor hours available ( $LH_1$ );
$LC_2$	total direct labor costs at the maximal working hours at the first and second overtime rate plus the normal direct labor hours available ( $LH_2$ );
$e_j$	the actual operating activity costs for each activity driver in activity $j$ ;
$a_{ij}$	the number of machine hours required to produce one unit of product $i$ in activity $j = 1-6$ ;

$u_{ij}$	the number of machine hours required to transport one batch of product $i$ in activity $j = 7$ ;
$n_{ij}$	the quantity of product $i$ for a batch in activity $j$ ;
$l_i$	the requirement of direct labor hours for one unit of product $i$ ;
TDL	total direct labor hours used from Equation (3);
$MH_j$	the number of machine hours available for activity $j$ ;
$CEC_1$	the total carbon tax cost at the upper limit of total carbon emission quantity of the first carbon tax range ( $CE_1$ );
$CEC_2$	the total carbon tax cost at the upper limit of total carbon emission quantity of the first carbon tax range ( $CE_2$ );
$CEC_3$	the total carbon tax cost at the upper limit of total carbon emission quantity of the third carbon tax range ( $CE_3$ );
TCEQ	the total quantity of carbon emission from Equation (15);
$CE_1$	the upper limit of total carbon emission quantity of the first carbon tax range;
$CE_2$	the upper limit of total carbon emission quantity of the second carbon tax range;
$CE_3$	the upper limit of total carbon emission quantity of the third carbon tax range;
$q_i$	the cost of material handling for one batch of product $i$ ;
$v_i$	the quantity of carbon emission for producing one unit of product $i$ .

### 3.3.2. The Objective Function

The objective function of the green production planning model under ABC and Industry 4.0 is to maximize profit ( $\pi$ ), as follows:

$$\begin{aligned}
 \text{Maximize } \pi &= (\text{Total revenue}) - (\text{Direct material cost}) - (\text{Direct labor cost}) \\
 &\quad - (\text{Material handling cost}) - (\text{carbon tax cost}) - (\text{Other fixed cost}) \\
 \text{Maximize } \pi &= \sum_{i=1}^n S_i Q_i - \sum_{k=1}^s \left\{ C_k \sum_{i=1}^n (\alpha_{ik} Q_i) \right\} - \{ [LC_0 + \phi_1(LC_1 - LC_0) + \phi_2(LC_2 - LC_0)] \} \\
 &\quad - \sum_{i=1}^n u_{ij} b_i - (CEC_1 \delta_1 + CEC_2 \delta_2 + CEC_3 \delta_3) - F
 \end{aligned} \tag{1}$$

The profit function  $\pi$  in the model is shown in Equation (1).  $\sum_{i=1}^n S_i Q_i$ , the first term of Equation (1) is total revenue.  $\sum_{k=1}^s \{C_k \sum_{i=1}^n (\alpha_{ik} Q_i)\}$ , the second term of Equation (1), is total direct material cost. Direct labor cost is  $[LC_0 + \phi_1(LC_1 - LC_0) + (\phi_2 LC_2 - LC_0)]$  of Equation (1) in the third term.  $\sum_{i=1}^n u_{ij} b_i$  of Equation (1) in the fourth term is the material handling cost, where the activity of material handling is the batch-level activity. Carbon emission cost is  $(CEC_1 \delta_1 + CEC_2 \delta_2 + CEC_3 \delta_3)$  of Equation (1) in the fifth term. Other fixed cost is  $F$  of Equation (1) in the sixth term. Tire environmental regulatory costs, including the handling of regular inspections, the relevant costs and environmental standards value specifications, in accordance with local government laws and regulations, are fixed costs, thus, they can be expressed as a constant (USD \$20,000 in the example data). Company T will make the green product-mix decision based on the current capacity.

### 3.3.3. Direct Material Quantity Constraints

Total direct material cost is  $\sum_{k=1}^s \{C_k \sum_{i=1}^n (\alpha_{ik} Q_i)\}$ , the second term of Equation (1) and the associated constraint is shown in Equation (2):

Direct material quantity constraints:

$$\sum_{i=1}^n (\alpha_{ik} Q_i) \leq W_k \quad k = 1, 2, \dots, s \tag{2}$$

where,  $\alpha_{ik}$  is the requirements of material  $k$  for producing a unit of product  $i$  and  $W_k$  is the quantity of material  $k$  available for use.

3.3.4. Direct Labor Cost Function

Suppose that direct labor hours can be extended by overtime work at higher pay rates. The direct labor cost function is shown in Figure 3. The normal labor hours available is  $LH_0$  and it can be extended to  $LH_1$  and  $LH_2$ ; the total direct labor costs are  $LC_0$ ,  $LC_1$  and  $LC_2$  at  $LH_0$ ,  $LH_1$  and  $LH_2$ , respectively. The third term in Equation (1), that is,  $[LC_0 + \phi_1(LC_1 - LC_0) + \phi_2(LC_2 - LC_0)]$  is the total direct labor cost.  $LC_0$  is the cost of non-discretionary labor hours and  $\phi_1(LC_1 - LC_0) + \phi_2(LC_2 - LC_0)$  is the cost of total overtime work at two different higher pay rates. The constraints associated with direct labor are shown in Equations (3)–(11):

Direct labor hour constraints:

$$TDL = i_1Q_1 + i_2Q_2 + i_3Q_3 = LH_0 + \phi_1(LH_1 - LH_0) + \phi_2(LH_2 - LH_0) \tag{3}$$

$$\phi_0 - \varnothing_1 \leq 0 \tag{4}$$

$$\phi_1 - \varnothing_1 - \varnothing_2 \leq 0 \tag{5}$$

$$\phi_2 - \varnothing_2 \leq 0 \tag{6}$$

$$\phi_0 + \phi_1 + \phi_2 = 1 \tag{7}$$

$$\varnothing_1 + \varnothing_2 = 1 \tag{8}$$

$$0 \leq \phi_0 \leq 1 \tag{9}$$

$$0 \leq \phi_1 \leq 1 \tag{10}$$

$$0 \leq \phi_2 \leq 1 \tag{11}$$

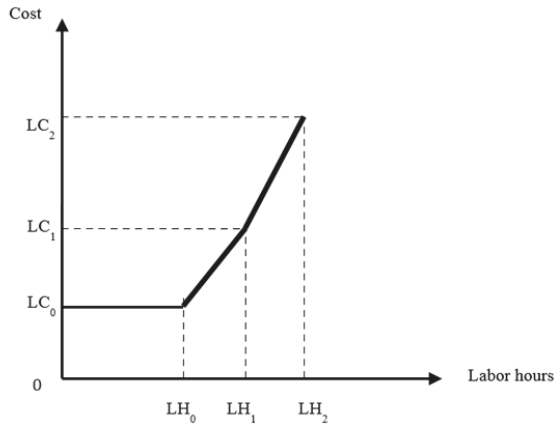

Figure 3. Direct labor cost.

The total direct labor constraint in Equation (3) is the TDL.  $\varnothing_1$  and  $\varnothing_2$  is a SOS1 set of 0–1 variables, where only one of these variables will be non-zero;  $\phi_0$ ,  $\phi_1$  and  $\phi_2$  is a SOS2 set of non-negative variables, where there may be up to two adjacent variables in the order given to the group, which are non-zero. If  $\varnothing_1 = 1$ , then  $\varnothing_2 = 0$  from Equation (8),  $\phi_2 = 0$  from Equation (6).  $\phi_0$ ,  $\phi_1 \leq 1$  from Equations (4) and (5) and  $\phi_0 + \phi_1 = 1$  from Equation (7). Therefore, total direct labor hours and total labor costs are  $LH_0 + \phi_1(LH_1 - LH_0)$  and  $LC_0 + \phi_1(LC_1 - LC_0)$ , respectively. It means that the company works overtime at the first overtime rate. On the other hand, if  $\varnothing_2 = 1$ , then  $\varnothing_1 = 0$  from Equation (8),  $\phi_0 = 0$  from Equation (4),  $\phi_1, \phi_2 \leq 1$  from Equations (5) and (6) and  $\phi_1 + \phi_2 = 1$  from Equation (7). Thus, the total direct labor hours required is  $LH_0 + \phi_1(LH_1 - LH_0) + \phi_2(LH_2 - LH_0)$  from Equations (3) and

total labor cost is  $LC_0 + \phi_1(LC_1 - LC_0) + \phi_2(LC_2 - LC_0)$ , respectively. It means there will be overtime work at the second overtime rate.

### 3.3.5. Machine Hour Constraints

In the tire manufacturing process, each activity has a different machine for operation. Due to the complexity of the tire manufacturing process, in this study, the mathematical programming model assumes that the related cost of a machine for an activity is included in the fixed costs,  $F$ , meaning the last term of Equation (1). Let  $a_{ij}$  be the number of machine hours required to produce one unit of product  $i$  in activity  $j = 1, 2, 3, 4, 5, 6$ ; Therefore, the associated machine hour constraints are shown in Equation (12):

Machine hour constraints:

$$\sum_{i=1}^n a_{ij}Q_i \leq MH_j, j = 1, 2, 3, 4, 5, 6 \tag{12}$$

### 3.3.6. Batch-Level Activity Cost Function for Material Handling

In the tire manufacturing process, we must first obtain the relevant materials from the warehouse for mixing operations and the finished goods are moved to the warehouse. In this study, we assume the material from the warehouse is to be carried out at a specific number for a batch. Therefore, the total material handling cost is  $\sum_{i=1}^n q_i b_i$  and the constraints associated with material handling are shown in Equations (13) and (14):

Material handling constraints:

$$Q_i \leq n_{ij}b_i, i = 1, 2, 3, \dots, n, j = 7 \tag{13}$$

$$\sum_{i=1}^n u_{ij}b_i \leq MH_j, j = 7 \tag{14}$$

where,  $n_{ij}$  is the quantity of product  $i$  for a batch in activity  $j$ ;  $b_i$  is the number of batches for material handling of product  $i$ ;  $q_i$  is the cost of material handling for one batch of product  $i$ ;  $u_{ij}$  is the number of machine hours required to transport one batch of product  $i$  in activity  $j = 7$ . Note that the material required for each batch is transported in one time. Thus, Equation (13) is the constraint for the production quantity for product  $i$  and Equation (14) is the constraint for the resource hours of material handling. The total material handling cost is  $\sum_{i=1}^n u_{ij}b_i$ , the fourth term of Equation (1).

### 3.3.7. Carbon Tax Function

Wang et al. [78] showed that levying taxes can slightly increase the GDP. Energy taxes have impact on the cost of the energy industry due to rising energy costs. Shrinking production scale, capital and labor may require transfer to low-energy, low-emission industries. Energy taxes can reduce the concentration of air pollutants, thereby, improving air quality. In addition, the calculation of capital and operating expenses is based on a simulation of carbon emissions and economic performance under efficiency taxes, as based on the quality and energy balances obtained; the results show that all of the assessed environmental impact indicators are performing well [79]. Therefore, such economic, environmental and health improvement will have positive impact on the country’s energy tax. According to Tsai et al. [31], the new green manufacturing technology (GMT) can reduce carbon emissions and the cost of carbon emissions should be measured using the life cycle assessment (LCA) method. LCA is a method to compare the impact on the environment from the fluoroscopy of the entire life cycle of a technology, product, or service. Based on previous research, we consider all the environmental impacts of carbon emissions in the tire manufacturing process. According to the method of Ward and Chapman [80], Equation (15) is used to quantify carbon emissions. Since carbon emissions are also considered taxable at different rates, the total carbon tax cost function is a piecewise linear function, as shown in Figure 4. As carbon emissions increase, taxes will increase. Carbon emissions



can be increased from  $CE_1$  to  $CE_2$  and  $CE_3$ . Therefore, the total carbon tax costs are  $CEC_1$ ,  $CEC_2$  and  $CEC_3$  at the quantities of  $CE_1$ ,  $CE_2$  and  $CE_3$ , respectively. Total carbon tax cost is the fifth term in Equation (1), as follows:

$$\text{The total cost of carbon emission} = CEC_1 \delta_1 + CEC_2 \delta_2 + CEC_3 \delta_3$$

The constraints associated with carbon emissions are shown in Equations (15)–(21):  
Carbon emission constraints:

$$TCEQ = v_1Q_1 + v_2Q_2 + v_3Q_3 = CE_1\delta_1 + CE_2\delta_2 + CE_3\delta_3 \tag{15}$$

$$\delta_0 - \varepsilon_1 \leq 0 \tag{16}$$

$$\delta_1 - \varepsilon_1 - \varepsilon_2 \leq 0 \tag{17}$$

$$\delta_2 - \varepsilon_2 - \varepsilon_3 \leq 0 \tag{18}$$

$$\delta_3 - \varepsilon_3 \leq 0 \tag{19}$$

$$\delta_0 + \delta_1 + \delta_2 + \delta_3 = 1 \tag{20}$$

$$\varepsilon_1 + \varepsilon_2 + \varepsilon_3 = 1 \tag{21}$$

Total carbon emission quantity is  $TCEQ = v_1Q_1 + v_2Q_2 + v_3Q_3 = CEQ_1$  from Equation (15). In Equations (16)–(21),  $(\varepsilon_1, \varepsilon_2, \varepsilon_3)$  is a SOS1 set of 0–1 variables, where only one of these variables will be non-zero from Equation (21).  $(\delta_0, \delta_1, \delta_2, \delta_3)$  is a SOS2 set of non-negative variables, where there may be up to two adjacent variables in the order given to the group, which are non-zero. If  $\varepsilon_1 = 1$ , then  $\varepsilon_2, \varepsilon_3 = 0$  from Equation (21);  $\delta_2, \delta_3 = 0$  from Equations (18) and (19);  $\delta_0, \delta_1 \leq 1$  from Equations (16) and (17); and  $\delta_0 + \delta_1 = 1$  from Equation (20). Thus, the total quantity of carbon emissions and the total carbon tax cost are  $(CE_1\delta_1)$  and  $(CEC_1\delta_1)$ , from Equation (15) and Equation (1), respectively. It means that the quantity of carbon emission falls within the first range of carbon tax, that is,  $[0, CE_1\delta_1]$ . If  $\varepsilon_2 = 1$ , then  $\varepsilon_1, \varepsilon_3 = 0$  from Equation (21);  $\delta_0, \delta_3 = 0$  from Equations (16) and (19);  $\delta_1, \delta_2 \leq 1$  from Equations (17) and (18); and  $\delta_1 + \delta_2 = 1$  from Equation (20). Thus, the total quantity of carbon emissions and the total carbon tax cost are  $(CE_1\delta_1 + CE_2\delta_2)$  and  $(CEC_1\delta_1 + CEC_2\delta_2)$ , respectively. It means that the quantity of carbon emission falls within the second range of carbon tax, that is,  $[CE_1\delta_1, CE_2\delta_2]$ . If  $\varepsilon_3 = 1$ , similarly, it means that the quantity of carbon emissions falls within the third range of carbon tax, that is,  $[CE_2\delta_2, CE_3\delta_3]$ .

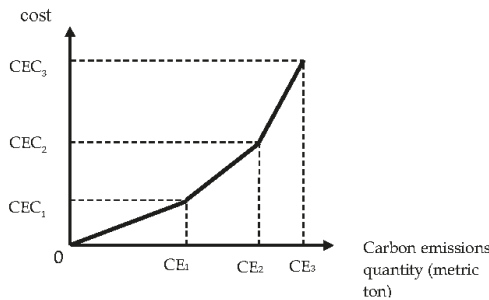

Figure 4. Carbon tax costs.

#### 4. Illustration

As an illustration, company T in the tire industry has been established in Taiwan for more than 50 years. There are 11 tire manufacturing companies in the world, with more than 24,000 worldwide employees and paid-in capital exceeding 30 billion yuan. The main products are various kinds of tires

and rubber products. Company T is used to illustrate how to apply the green decision-making model proposed in this paper.

To implement air pollution control, tire companies have changed all heavy oil boilers to natural gas boilers; however, this equipment exhausts gas for production process combustion and cannot effectively reduce carbon emissions. As a result, carbon emissions have seriously affected air pollution and have to be controlled.

4.1. Example Data and Optimal Decision Analysis

Assume that the following costs for producing the products of Company T have been calculated: (1) direct material cost; (2) kneading activity cost; (3) squeeze out activity cost; (4) cut activity cost; (5) forming activity cost; (6) vulcanization activity cost; (7) inspection activity cost; (8) material handing activity cost; (9) carbon tax cost; (10) direct labor cost. Assume also that Company T has three main products: PCR (Passenger Car Radial) (i = 1), TBR (Truck & Bus Radial) (i = 2) and MC (Motorcycle) (i = 3) and that these products consume the same direct materials. In this illustration, the quantity of each product is in the thousands and the cost and input costs are in U.S. dollars. The data for this illustration are shown in Table 1. Total fixed cost is USD \$20,000; the green product-mix decision model is presented according to Equations (1)–(21), as follows:

$$\begin{aligned} \text{Maximize } \pi &= \sum_{i=1}^n S_i Q_i - \sum_{k=1}^s \left\{ C_k \sum_{i=1}^n (\alpha_{ik} Q_i) \right\} - [LC_0 + \phi_1(LC_1 - LC_0) + \phi_2(LC_2 - LC_0)] \\ &- (q_1 b_1 + q_2 b_2 + q_3 b_3) - (CEC_1 \delta_1 + CEC_2 \delta_2 + CEC_3 \delta_3) - F \\ &= (300Q_1 + 1000Q_2 + Q_3) - (20 \times 4 + 10 \times 2 + 5 \times 5 + 37 \times 2 + 21 \times 2)Q_1 - (20 \times \\ &6 + 10 \times 10 + 5 \times 15 + 37 \times 6 + 21 \times 15)Q_2 - (20 \times 2 + 10 \times 1 + 5 \times 2 + 37 \times 1 + 21 \times \\ &1)Q_3 - 7040 - 3960\phi_1 - 8800\phi_2 - 50b_1 - 150b_2 - 10b_3 - 7000\delta_1 - \\ &10,000\delta_2 - 13,000\delta_3 - 20,000 \end{aligned}$$

Subject to:

Direct material quantity constraints:

$$4Q_1 + 6Q_2 + 2Q_3 \leq 10,500,000$$

$$2Q_1 + 10Q_2 + 1Q_3 \leq 8,000,000$$

$$5Q_1 + 15Q_2 + 2Q_3 \leq 8,600,000$$

$$2Q_1 + 6Q_2 + 1Q_3 \leq 7,000,000$$

$$2Q_1 + 15Q_2 + 1Q_3 \leq 7,800,000$$

Direct labor hour constraints:

$$1Q_1 + 1.5Q_2 + 0.5Q_3 - 1760 - 2200\phi_1 - 2640\phi_2 = 0$$

$$\phi_0 - \phi_1 \leq 0$$

$$\phi_1 - \phi_1 - \phi_2 \leq 0$$

$$\phi_2 - \phi_2 \leq 0$$

$$\phi_0 + \phi_1 + \phi_2 = 1$$

$$\phi_1 + \phi_2 = 1$$

$$0 \leq \phi_0 \leq 1$$

$$0 \leq \phi_1 \leq 1$$

$$0 \leq \phi_2 \leq 1$$

$$\phi_1, \phi_2 = 0, 1$$

Machine hour constraints:

$$5Q_1 + 10Q_2 + 1Q_3 \leq 13,200,000$$

$$2Q_1 + 4Q_2 + 1Q_3 \leq 22,000,000$$

$$2Q_1 + 3Q_2 + 1Q_3 \leq 22,000,000$$

$$3Q_1 + 5Q_2 + 1Q_3 \leq 26,400,000$$

$$2Q_1 + 3Q_2 + 1Q_3 \leq 13,200,000$$

$$3Q_1 + 6Q_2 + 1Q_3 \leq 6,600,000$$

Table 1. Data for Illustrative Example.

Product				PCR (i = 1)	TBR (i = 2)	MC (i = 3)	Available Capacity (thousand)
Maximum demand: (thousand)	$e_j$	j	$Q_i$	1000	100	1500	
Selling price: (USD)			$S_i$	300	1000	150	
Direct material: (USD/ton)	k = 1	20	$\alpha_{i1}$	4	6	2	$W_1 = 10,500$
	k = 2	10	$\alpha_{i2}$	2	10	1	$W_2 = 8000$
	k = 3	5	$\alpha_{i3}$	5	15	2	$W_3 = 8600$
	k = 4	37	$\alpha_{i4}$	2	6	1	$W_4 = 7000$
	k = 5	21	$\alpha_{i5}$	2	15	1	$W_5 = 7800$
<b>Machine hour constraint:</b>							
Kneading	Machine hours	1	$a_{i1}$	5	10	1	$MH_1 = 13,200$
Pressing out	Machine hours	2	$a_{i2}$	2	4	1	$MH_2 = 22,000$
Cutting off	hoursMachine	3	$a_{i3}$	2	3	1	$MH_3 = 22,000$
Forming	hours	4	$a_{i4}$	3	5	1	$MH_4 = 26,400$
Vulcanizing	Machine hours	5	$a_{i5}$	2	3	1	$MH_5 = 13,200$
Inspecting	Machine hours	6	$a_{i6}$	3	6	1	$MH_6 = 6600$
<b>Material handling constraint:</b>							
Machine hours (hr)	$q_1 = 50; q_2 = 150;$		$u_{i7}$	2	3	1	
Cost (USD)	$q_3 = 10$	7	$n_{i7}$	5	10	1	$MH_7 = 1760$
<b>Direct labor constraint:</b>							
Cost:	$LC_0 = 7040$	$LC_1 = 11,000$	$LC_2 = 15,840$				
Labor hours (hr)	$LH_0 = 1760$	$LH_1 = 2200$	$LH_2 = 2640$	$l_i$	1	1.5	0.5
Wage rate (USD/hr)	$r_0 = 4$	$r_1 = 9$	$r_2 = 11$				
<b>Carbon emission constraint:</b>							
Cost (USD)	$CEC_1 = 7000$	$CEC_2 = 10,000$	$CEC_3 = 13,000$				
Emission quantities	$CE_1 = 700$	$CE_2 = 850$	$CE_3 = 950$	$v_i$	0.2	0.1	0.1
Tax rate (USD/ton)	$T_1 = 10$	$T_2 = 20$	$T_3 = 30$				
Total fixed cost: (USD)	20,000						

Material handing constraints:

$$Q_1 - 5b_1 \leq 0$$

$$Q_2 - 10b_2 \leq 0$$

$$Q_3 - 1b_3 \leq 0$$

$$2b_1 + 3b_2 + 1b_3 \leq 1,760,000$$

Carbon emission constraints:

$$0.2Q_1 + 0.1Q_2 + 0.1Q_3 - 700\delta_1 - 850\delta_2 - 950\delta_3 = 0$$

$$\delta_0 - \varepsilon_1 \leq 0$$

$$\delta_1 - \varepsilon_1 - \varepsilon_2 \leq 0$$

$$\delta_2 - \varepsilon_2 - \varepsilon_3 \leq 0$$

$$\delta_3 - \varepsilon_3 \leq 0$$

$$\delta_0 + \delta_1 + \delta_2 + \delta_3 = 1$$

$$\varepsilon_1 + \varepsilon_2 + \varepsilon_3 = 1$$

We solved this mathematical programming model with LINGO 16.0 software and obtained the optimal solution with product-mix, resource consumption, carbon emission and tax and total profit as shown in Table 2.

**Table 2.** Optimal solutions, Resource consumption, Carbon emission and tax and Total profit.

$Q_1$	=1,020,000	$Q_2$	=60,000	$Q_3$	=1,300,000
$\phi_0$	=1	$\phi_1$	=0	$\phi_2$	=0
$b_1$	=204,000	$b_2$	=6000	$b_3$	=1,300,000
$\delta_1$	=0.49	$\delta_2$	=0	$\delta_3$	=0
$\delta_0$	=0.51	$\varnothing_1$	=1	$\varnothing_2$	=0
$\varepsilon_1$	=1	$\varepsilon_2$	=0	$\varepsilon_3$	=0
	Machine hours		Direct material quantity	Direct labor hour = 1,760,000	
1	7,000,000	1	7,040,000	Carbon emission quantity = 340,000	
2	3,580,000	2	3,940,000	Carbon tax = \$3,400,000 (USD)	
3	3,520,000	3	8,600,000	Total profit $\pi$ = \$57,320,000 (USD)	
4	4,660,000	4	3,700,000		
5	3,520,000	5	4,240,000		
6	4,720,000				
7	1,726,000				

According to Table 2, the optimal solution is  $(Q_1, Q_2, Q_3) = (1,020,000, 60,000, 1,300,000)$ , which requires 7,040,000 units  $(= 4 \times 1,020,000 + 6 \times 60,000 + 2 \times 1,300,000)$  of the first kind of material, 3,940,000 units  $(= 2 \times 1,020,000 + 10 \times 60,000 + 1 \times 1,300,000)$  of the second kind of material, 8,600,000 units  $(= 5 \times 1,020,000 + 15 \times 60,000 + 2 \times 1,300,000)$  of the third kind of material, 3,700,000 units  $(= 2 \times 1,020,000 + 6 \times 60,000 + 1 \times 1,300,000)$  of the fourth kind of material, 4,240,000 units  $(= 2 \times 1,020,000 + 15 \times 60,000 + 1 \times 1,300,000)$  of the fifth kind of material, 7,000,000  $(= 5 \times 1,020,000 + 10 \times 60,000 + 1 \times 1,300,000)$  of the first kind of machine hours, 3,580,000  $(= 2 \times 1,020,000 + 4 \times 60,000 + 1 \times 1,300,000)$  of the second kind of machine hours, 3,520,000  $(= 2 \times 1,020,000 + 3 \times 60,000 + 1 \times 1,300,000)$  of the third kind of machine hours, 4,660,000  $(= 3 \times 1,020,000 + 5 \times 60,000 + 1 \times 1,300,000)$  of the fourth kind of machine hours, 3,520,000  $(= 2 \times 1,020,000 + 3 \times 60,000 + 1 \times 1,300,000)$  of the fifth kind of machine hours, 4,720,000  $(= 3 \times 1,020,000 + 6 \times 60,000 + 1 \times 1,300,000)$  of the sixth kind of machine hours and 1,726,000  $(= 2 \times 204,000 + 3 \times 6000 + 1 \times 1,300,000)$  material handling machine hours. In addition, it will consume 1,760,000 direct labor hours  $(= 1 \times 1,020,000 + 1.5 \times 60,000 + 0.5 \times 1,300,000)$ ; and the carbon emission quantity is 340,000  $(= 0.2 \times 1,020,000 + 0.1 \times 60,000 + 0.1 \times 1,300,000)$  tons, which is just within the first carbon tax range. The total profit  $\pi$  is USD \$57,320,000.

Company T obtains the optimal solution through the above green ABC mathematical programming model. In the future, Company T will engage in green production and introduce the related technology of Industry 4.0 step-by-step. Then, its relevant ABC data can be acquired directly from the relevant departments (e.g., accounting, research and development, procurement and production departments) with direct access to materials, sales price and other related costs. Regarding carbon tax costs, information on carbon emission regulations and carbon costs can be obtained from government agencies and the company's management. However, the TOC program used in this study provides the tire industry with the opportunity to identify and use the most restrictive new green manufacturing technologies in the future, which enables the tire industry to find the best combination of various products. While investing in new green manufacturing technologies can be prohibitively expensive, good environmental investments in the tire industry can maximize profits by adopting the TOC process.

#### 4.2. Sensitivity Analysis

The green tire manufacturing ABC decision model of this study does not consider the significance of capacity expansion. The possibility or profit of expanding capacity must be evaluated by sensitivity analysis, which conducts successful assessment of the resources invested to expand capacity. Tire managers may end up with suboptimal solutions when the level of expansion of various tire resources is determined in the wrong way. In addition, with the ABC decision model for green tire manufacturing, it is difficult to simultaneously consider two or more capacity expansions. Suppose the tire company plans to maximize profits by conducting sensitivity analyses to change the costs of carbon emissions

and material prices, in order to explore their effects on product-mix and profit. In this study, the above assumptions are applied to ABC mathematical programming model and sensitivity analysis is conducted. Tire material prices and carbon taxes increase and decrease by 10%, 20%, 30% and so forth (as shown in Table 3).

The finding show that the material price and carbon tax cost increased from 10% to 30%, while the total profit decline rate increased from 78% to 226%, indicating that, under these three circumstances, the original total profit of USD \$57,320 of the tire industry will take place (as shown in Figure 5), thus, turning profit to loss and total profit declines. On the contrary, if the material price and carbon tax cost are reduced from 10% to 30%, the increase in total profit would increase from 78% to 235%, indicating that the tire industry would have a total original profit of USD \$57,320 in these three cases; increase total profit and exceed 2.35 times the original total profit (as shown in Figure 6).

Sensitivity analysis of the above six conditions found that the change in the total profit of the tire industry was mainly due to the increase and decrease of the material price and the carbon tax cost. Therefore, the tire industry should strictly increase the total profit in the case of Control costs, in order to avoid any loss of profit.

Table 3. Sensitivity Analysis on direct material and carbon cost.

Direct Material and Carbon Cost Decrease/Increase Ratio (%)	Original Profit (A)	Profit after Change (B)	Decrease/Increase Profit (C) = (B - A)	Decrease/Increase (Compared with the Initial Value) (%) (D = C/A)
-30%	57,320	192,062	134,742	235%
-20%	57,320	147,148	89,828	156%
-10%	57,320	102,234	44,914	78%
-0%	57,320	57,320	0	0%
30%	57,320	-72,268	-129,588	-226%
20%	57,320	-29,952	-87,272	-152%
10%	57,320	12,406	-44,914	-78%

Unit: Thousands of USD.

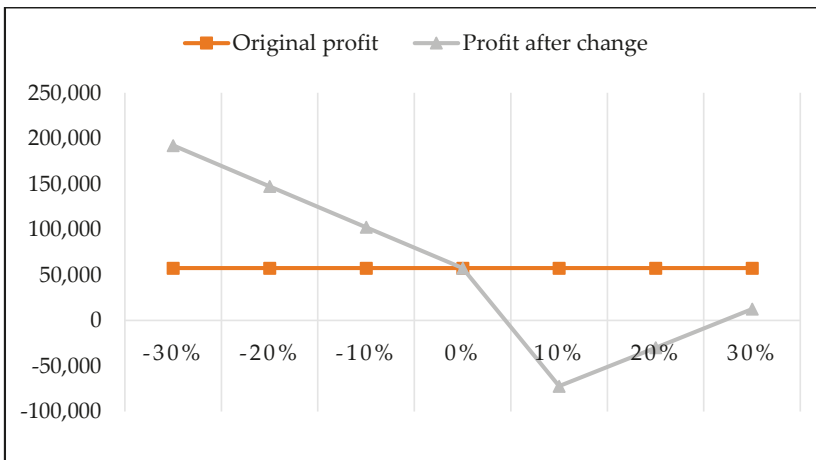

Figure 5. Sensitivity analysis of changes in gross profit.

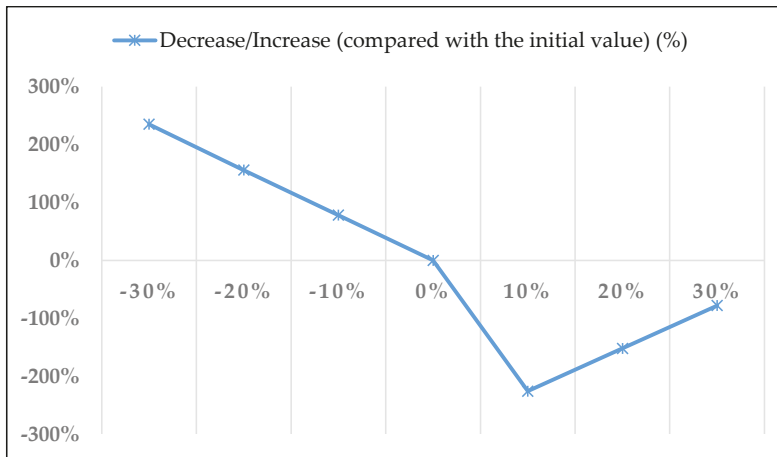

Figure 6. Sensitivity analysis of changes in total profit increase and decrease.

### 5. Shop Floor Control under Industry 4.0 in the Tire Industry

Shop floor control (SFC) mainly comprises a collection of production process-related information [81], meaning it is a method to parameterize the real-time shop floor data for control [11], as collected by the Manufacture Execution System (MES); however, MES focuses on the control of field-related equipment. Due to the complicated manufacturing process of tires and the development of related control technologies, the cost of manufacturing equipment for tires is high. Compared with other traditional industries, the tire industry MES should integrate Enterprise Resource Planning (ERP), including measurement, analyzing and improving the consumption of resources for sustainable development in manufacturing, the standards for environmental performance assessment and optimization and real-time energy indicators for production systems to gather relevant data in a real-time manner [82]. SFC may include the following functions to control the production to achieve the production/sale and profit target under various constraints.

- (1) *Status Monitoring*: Analysis of huge data sets (Big Data) could allow quick and accurate decision-making. For example, productivity improvements can be achieved by analyzing device performance and degradation for real-time feedback on configuration and optimization. Herman et al. [2] proposed a cloud-based IoT application architecture that will improve the deployment of intelligent industrial systems for remote monitoring and scrolling. Additionally, this can generate huge amounts of data during operation time due to the potential presence of hundreds or even thousands of sensors, considered as Big Data [83]. While cloud computing employed in industrial environments can bring benefits, it also poses challenges for the storage of Big Data, which describes cloud computing as a cloud-manufacturing counterpart to industrial environments [84], with the focus on increasing agility in the industrial environment and enabling the supply chain to capture the largest data sets [16,85,86].
- (2) *Work-in-process tracking*: With the development of ERP, more and more manufacturing enterprises are interested in the integration of ERP and MES systems [87,88]. The MES system architecture is designed for short-term production support. Simulation testing can be used to support the decision-making process; the real-time dynamics of MES and WIP can be performed more accurately [89]; RFID and wireless information networks can capture real-time field data from manufacturing plants to monitor and reduce WIP inventory [90,91]. The correct use of materials according to the actual needs can reduce the investment in production material and the integration of ERP and MES can achieve the purpose of sharing resource and integrating the related information in management decision-making. MES uses RFID technology to improve the

- efficiency of data collection [92,93]. Another data collection approaches under Industry 4.0 were proposed such as the multi-mode data acquisition method [94] and the Sophos-MS's practical solution design and development [95].
- (3) *Throughput tracking*: We can track the tire manufacturing process-related information; however, in order to understand whether the production quantity of tire manufacturing can be completed as scheduled, we can integrate ERP with the MES to truly track the progress of tire production; we can also immediately review the reasons for handling backward production and then find the possible solutions [96,97].
  - (4) *Capacity feedback*: In the Industry 4.0 environment, the right application of big data management is one of the most important factors. The "Product Planning Software" concept and structure is a new process planning, operation sequencing and scheduling method, as presented by [97]. In order to track the utilization of capacity, sensors are added to each machine to track its utilization. By knowing the utilization of capacity, the tire manufacturing process can be controlled without increasing idle costs or inventory costs. In addition, bottleneck detection with the sensors systems and IoT in production can improve production efficiency and stability in order to increase capacity utilization [98,99]. This capacity utilization tracking can assist in the application of Theory of Constraints in the production planning stage.
  - (5) *Quality control*: The MES and ERP systems collect information for production process control through automated equipment and the management software system mode of operation, tire quality is detected [100]. The production control system of smart manufacturing under Industry 4.0 should be able to real-timely respond to various production problems and to effectively coordinate different resources of different departments to solve the problems encountered [96]. Beyond this, Industry 4.0 can focus on predictive maintenance for machines before the production problems occur through the big data analyses of troubling sounds or images [101–103]. Besides, Rødseth et al. [104] developed an integrated planning (IPL) approach which simultaneously executed production and maintenance planning in production scheduling.
  - (6) *Real-time interconnection*: Delima and Balaunzarán [105] claim that smart manufacturing under Industry 4.0 has four characteristics: (1) self-awareness of current state of the production process, (2) real-time predictive capabilities for possible production problems arise such as products' bad quality and machine breakdown, (3) a high level of real-time automation of activities across the production process, (4) real-time interconnection. The characteristic of real-time interconnection is to connect all the system components of machines, equipment, persons, materials and products at the factory level through Cyber-Physical Systems (CPS) [106,107] and Industrial Internet of Things (IIoT) [108–112]. It also can connect with suppliers and customers at the external supply chain level [105,106]. Under these circumstances, companies can do the works from product development to after-sale services with more efficiency, lower cost, lower carbon emission and higher quality [113].

## 6. Discussion

In the mathematical programming model, this research considers the carbon tax cost in addition to the related costs of the tire industry. This model is used to get the optimal product-mix maximizing the profits of the tire company under various constraints at the stage of production planning. As the costs of the tire industry are mainly affected by the fluctuations of the raw materials and increasing of carbon tax, profits will be seriously affected; therefore, this study further tests sensitivity by using the proposed mathematical programming model. If the cost of materials and the cost of carbon taxes increase or decrease by 10% to 30%, the six situations are analyzed and tested. When material and carbon costs are increased by 10% to 30%, the results show that the total profit will be substantially reduced from USD \$72,268,000 to USD \$57,320,000 and the percentage of the total profit reduction will be up to negative 226%. Conversely, if the material and carbon costs are reduced by 10% to 30%, the results show that the total profit will increase substantially from USD \$57,320,000 to USD \$192,062,000

and the gross profit percentage will be increased up to 235%. The mathematical programming model of this study shows that the fluctuation of raw materials and the increased carbon tax are the factors affecting the maximum profit of the tire industry. As a result, the tire industry should carefully consider the costs of raw materials and carbon emissions to successfully obtain the appropriate profits.

One of the main features of Industry 4.0 is mass customization through integrating all components in the manufacturing system [113]. However, this feature is not suitable for the tire industry. Industry 4.0 can provide tire companies the following benefits: (1) improved efficiency and productivity through process automation, visualization and control (2) reduced costs through improved efficiency and productivity and efficient resource utilization, recycling and reuse, (3) increased and quick innovation through computer-aided design (CAD) or 3D design capabilities and reduced product launch time, (4) improved product quality through predictive maintenance and quality monitoring by using big data analysis, (5) improved sustainability through monitoring and control of carbon and other emissions, (6) increased customer satisfaction through better customer services of the rapid responsiveness and deep information availability and then (7) achieving higher revenues and profits [114,115].

This paper claims that the related technologies and techniques of Industry 4.0 can be used to efficiently control the production to achieve the targets of sales and profits set at the production planning stage and to attain the benefits mentioned above through status monitoring, work-in-process tracking, throughput tracking, capacity feedback, quality control with predictive maintenance and real-time interconnection across the value chain [116]. In addition, the activity cost calculation and activity improvement of Activity-Based Costing (ABC) will be easily achieved since all the components in the manufacturing systems can be connected and monitored under Industry 4.0. In the literature, seldom research explored the combination of the mathematical programming model and Industry 4.0 except the applications in the textile [117] and paper [118] industries, which have different production processes and activities.

## **7. Conclusions**

This paper aims to propose a linkage of the mathematical programming model for production control and Industry 4.0 for production control. At the stage of production control, ABC is used to measure the costs of activities and TOC is used to identify the constraints of production or sales, which form the mathematical programming model for production planning. The outputs of production planning model will be the targets of business operation, including production/sale and profit targets. Industry 4.0 is used to control the production to attain the production/sale and profit targets by using three tiers of technologies including the automation technologies, the Manufacturing Execution Systems (MES) and the Enterprise Resource Planning Systems (ERP). Sections 3 and 4 proposed a production planning model with ABC and TOC and presented an illustration for demonstrating the application of the model; Section 5 discusses the shop floor control techniques for production control with status monitoring, work-in-process tracking, throughput tracking, capacity feedback, quality control with predictive maintenance and real-time interconnection across the value chain in order to achieve the planning targets and various Industry 4.0 benefits. The main contribution of this paper is to provide a framework for production planning and control with carbon tax through mathematical programming model and Industry 4.0 related technologies.

At present, there are few studies in the literature combining the mathematical programming model and Industry 4.0 related technologies in production planning and control with carbon tax. The managerial implication of this framework is that it can provide a general approach to help companies execute production management in the way of more efficiency, less cost, lower carbon emission and higher quality across the value chain for the tire industry. Besides, this framework also can be applied to other industries.

However, there are some research limitations in this research which can derive the future research directions. First, the model assumes that the unit prices of products and the unit costs of direct materials are constant within the relevant range of planning. It may be extended to consider the relationship



between the product prices and the market demands and to consider the purchase quantity discounts of materials within the relevant range of planning. Second, the model uses a continuous piecewise linear carbon tax function of three carbon tax ranges with the increasing carbon tax rates, called “Carbon tax function with extra progressive tax rates.” It can consider the discontinuous carbon tax function with full progressive tax rates which uses the increasing carbon tax rates for all carbon emission quantity at the different carbon tax ranges. It also can consider the free carbon tax quantity for the carbon tax function mentioned above. Third, the model only considers a batch-level activity, that is, material handling, in order to simplify the model. It can consider other batch-level activities such set-up and scheduling and consider the product-level activities such as product design and product advertising. Fourth, the framework in Figure 1 provides the periodic feedback and updated parameters to next period’s production planning. However, the next ideal approach is providing various decision models in the model base of Industry 4.0 for Cloud Computing and Big Data analysis in order for frequent adjustment to the situation at that time.

**Author Contributions:** W.-H.T. provided the research idea, the research purpose and designed the research; Y.-H.L. collected and analyzed the data and wrote the paper; W.-H.T. provided the research method, supervised, corrected and revised this paper. All authors have read and approved the final manuscript.

**Funding:** This research was funded by the Ministry of Science and Technology of Taiwan under Grant No. MOST106-2410-H-008-020-MY3.

**Acknowledgments:** The authors are extremely grateful to the *sustainability* journal editorial team and reviewers who provided valuable comments for improving the quality of this article. The authors also would like to thank the Ministry of Science and Technology of Taiwan for financial support of this research under Grant No. MOST106-2410-H-008-020-MY3.

**Conflicts of Interest:** The authors declare no conflict of interest.

## References

1. Lasi, H.; Fettke, P.; Kemper, H.G.; Feld, T.; Hoffmann, M. Industry 4.0. *Bus. Inf. Syst. Eng.* **2014**, *6*, 239–242. [[CrossRef](#)]
2. Hermann, M.; Pentek, T.; Otto, B. Design principles for Industrie 4.0 scenarios: A literature review. In Proceedings of the 2016 49th Hawaii International Conference on System Sciences, Koloa, HI, USA, 5–8 January 2016; pp. 3928–3939.
3. Schaltegger, S.; Synnøstvedt, T. The link between ‘green’ and economic success: Environmental management as the crucial trigger between environmental and economic performance. *J. Environ. Manag.* **2002**, *65*, 339–346.
4. Menoni, M.; Morgavi, H. Is eco-efficiency enough for sustainability? *Int. J. Perform. Eng.* **2014**, *10*, 337–346.
5. Yahya-Zadeh, M. Product-mix decisions under activity-based costing with resource constraints and non-proportional activity costs. *J. Appl. Bus. Res.* **1998**, *14*, 39–46. [[CrossRef](#)]
6. Lockhart, J.; Taylor, A. Environmental Considerations in Product Mix Decisions Using ABC and TOC. *Manag. Account. Q.* **2007**, *9*, 13–31.
7. Onwubolu, G.C.; Mutingi, M. Optimizing the multiple constrained resources product mix problem using genetic algorithms. *Int. J. Prod. Res.* **2001**, *39*, 1897–1910. [[CrossRef](#)]
8. Kletti, J. *Manufacturing Execution System—MES*; Springer: Berlin, Germany, 2007.
9. De Ugarte, B.S.; Artiba, A.; Pellerin, R. Manufacturing execution system—A literature review. *Prod. Plan. Control* **2009**, *20*, 525–539. [[CrossRef](#)]
10. Almada-Lobo, F. The Industry 4.0 revolution and the future of manufacturing execution systems (MES). *J. Innov. Manag.* **2016**, *3*, 16–21.
11. Timo, I.F.; Mónica, R.L.; Christian, B.; Friedrich, M.; Bernd, K.; Ulrich, B.; Waldemar, S. Agent-based communication to map and exchange shop floor data between MES and material flow simulation based on the open standard CMSD. *IFAC-PapersOnLine* **2016**, *49*, 1526–1531. [[CrossRef](#)]
12. Liu, W.; Chua, T.J.; Larn, J.; Wang, F.-Y.; Yin, X. APS, ERP and MES systems integration for semiconductor backend assembly. In Proceedings of the 7th International Conference on Control, Automation, Robotics and Vision, Singapore, 2–5 December 2002; pp. 1403–1408.

13. Lee, J.; Kao, H.-A.; Yang, S. Service innovation and smart analytics for industry 4.0 and big data environment. *Procedia CIRP* **2014**, *16*, 3–8. [[CrossRef](#)]
14. Wang, S.; Wan, J.; Zhang, D.; Li, D.; Zhang, C. Towards smart factory for industry 4.0: A self-organized multi-agent system with big data based feedback and coordination. *Comput. Netw.* **2016**, *101*, 158–168. [[CrossRef](#)]
15. Krzysztof, W. Internet of Things, Big Data, Industry 4.0—Innovative Solutions in Logistics and Supply Chains Management. *Procedia Eng.* **2017**, *182*, 763–769.
16. Xu, X. From cloud computing to cloud manufacturing. *Robot. Comput.-Integr. Manuf.* **2012**, *28*, 75–86. [[CrossRef](#)]
17. Bechtsis, D.; Tsolakis, N.; Vouzas, M.; Vlachos, D. Industry 4.0: Sustainable material handling processes in industrial environments. *Comput. Aided Chem. Eng.* **2017**, *40*, 2281–2286.
18. Wan, J.; Tang, S.; Hua, Q.; Li, D.; Liu, C.; Lloret, J. Context-aware cloud robotics for material handling in cognitive industrial internet of things. *IEEE Internet Things J.* **2018**, *5*, 2272–2281. [[CrossRef](#)]
19. Jazdi, N. Cyber physical systems in the context of Industry 4.0. In Proceedings of the 2014 IEEE International Conference on Automation, Quality and Testing, Robotics, Cluj-Napoca, Romania, 22–24 May 2014; pp. 1–4.
20. Lee, J.; Bagheri, B.; Kao, H.-A. A cyber-physical systems architecture for industry 4.0-based manufacturing systems. *Manuf. Lett.* **2015**, *3*, 18–23. [[CrossRef](#)]
21. Wan, J.; Tang, S.; Shu, Z.; Li, D.; Wang, S.; Imran, M.; Vasilakos, A.V. Software-Defined Industrial Internet of Things in the Context of Industry 4.0. *IEEE Sens. J.* **2016**, *16*, 7373–7380. [[CrossRef](#)]
22. Dujin, A.; Blanchet, M.; Rinn, T.; Von Thaden, G.; De Thieullo, G. *Industry 4.0—The New Industrial Revolution: How Europe Will Succeed*; Roland Berger Strategy Consultants: Munich, Germany, 2014.
23. Kiel, D.; Müller, J.M.; Arnold, C.; Voigt, K.I. Sustainable Industrial Value Creation: Benefits and Challenges of Industry 4.0. *Int. J. Innov. Manag.* **2017**, *21*. [[CrossRef](#)]
24. Müller, J.M.; Kiel, D.; Voigt, K.I. What Drives the Implementation of Industry 4.0? The Role of Opportunities and Challenges in the Context of Sustainability. *Sustainability* **2018**, *10*, 247. [[CrossRef](#)]
25. Stock, T.; Seliger, G. Opportunities of sustainable manufacturing in industry 4.0. *Procedia CIRP* **2016**, *40*, 536–541. [[CrossRef](#)]
26. Biljana, L.R.S.; Kire, V.T. A review of Internet of Things for smart home: Challenges and solutions. *J. Clean. Prod.* **2017**, *140*, 1454–1464.
27. Berawi, M.A. Utilizing big data in industry 4.0: Managing competitive advantages and business ethics. *Int. J. Technol.* **2018**, *9*, 430–433. [[CrossRef](#)]
28. Hendrik, U.; FrankBörner, E. Context Related Information Provision in Industry 4.0 Environments. *Procedia Manuf.* **2017**, *11*, 796–805.
29. Kong, G.; White, R. Toward cleaner production of hot dip galvanizing industry in China. *J. Clean. Prod.* **2010**, *18*, 1092–1099. [[CrossRef](#)]
30. Puurunen, K.; Vasara, P. Opportunities for utilising nanotechnology in reaching near-zero emissions in the paper industry. *J. Clean. Prod.* **2007**, *15*, 1287–1294. [[CrossRef](#)]
31. Tsai, W.H.; Chen, H.C.; Liu, J.Y.; Chen, S.P.; Shen, Y.S. Using activity-based costing to evaluate capital investments for green manufacturing technologies. *Int. J. Prod. Res.* **2011**, *49*, 7275–7292. [[CrossRef](#)]
32. European Environment Agency. *Environmental Taxes, Implementation and Environmental Effectiveness*; European Environment Agency: Copenhagen, Denmark, 1996.
33. Lin, B.; Li, X. The effect of carbon tax on per capita CO<sub>2</sub> emission. *Energy Policy* **2011**, *39*, 5137–5146. [[CrossRef](#)]
34. Kunsch, P.; Springael, J. Simulation with system dynamics and fuzzy reasoning of a tax policy to reduce CO<sub>2</sub> emission in the residential sector. *Eur. J. Oper. Res.* **2008**, *185*, 1285–1299. [[CrossRef](#)]
35. Liao, Y.; Deschamps, F.; Loures, E.D.F.R.; Ramos, L.F.P. Past, present and future of Industry 4.0—a systematic literature review and research agenda proposal. *Int. J. Prod. Res.* **2017**, *55*, 3609–3629. [[CrossRef](#)]
36. Conegrey, T.; Gerald, J.D.F.; Valeri, L.M.; Tol, R.S.J. The impact of a carbon tax on economic growth and carbon dioxide emission in Ireland. *J. Environ. Plan. Manag.* **2013**, *56*, 934–952. [[CrossRef](#)]
37. Gianluca, D.; Joel, S.B.; Paolo, C. A Novel Methodology to Integrate Manufacturing Execution Systems with the Lean Manufacturing Approach. *Procedia Manuf.* **2017**, *11*, 2243–2251.
38. Beier, G.; Niehoff, S.; Ziemis, T.; Xue, B. Sustainability aspects of a digitalized industry—A comparative study from China and Germany. *Int. J. Precis. Eng. Manuf.-Green Technol.* **2017**, *4*, 227–234. [[CrossRef](#)]

39. Giti Tire. The Tire Production Process is a Very Meticulous and Complex. Available online: [http://www.corp.giti.com/images/newsdetailattach\\_20128194115667.pdf](http://www.corp.giti.com/images/newsdetailattach_20128194115667.pdf) (accessed on 18 August 2018).
40. Maribel, Y.S.; Jorge, O.E.S.; Carina, A.; Francisca, V.L.; Eduarda, C.; Carlos, C.; Bruno, M.; João, G. A Big Data system supporting Bosch Braga Industry 4.0 strategy. *Int. J. Inf. Manag.* **2017**, *37*, 750–760.
41. Dekker, R.; Bloemhof, J.; Mallidis, I. Operations research for greenlogistics—An overview of aspects, issues, contributions and challenges. *Eur. J. Oper. Res.* **2012**, *219*, 671–679. [[CrossRef](#)]
42. Liu, C.; Jiang, P. A Cyber-physical System Architecture in Shop Floor for Intelligent Manufacturing. *Procedia CIRP* **2016**, *56*, 372–377. [[CrossRef](#)]
43. Kamble, S.S.; Gunasekaran, A.; Gawankar, S.A. Sustainable industry 4.0 framework: A systematic literature review identifying the current trends and future perspectives. *Process Saf. Environ. Prot.* **2018**, *117*, 408–425. [[CrossRef](#)]
44. Basiago, A.D. Economic, social and environmental sustainability in development theory and urban planning practice. *Environmentalist* **1999**, *19*, 145–161. [[CrossRef](#)]
45. Stock, T.; Obenaus, M.; Kunz, S.; Kohl, H. Industry 4.0 as enabler for a sustainable development: A qualitative assessment of its ecological and social potential. *Process Saf. Environ. Prot.* **2018**, *118*, 254–267. [[CrossRef](#)]
46. Carvalho, N.; Chaim, O.; Cazarini, E.; Gerolamo, M. Manufacturing in the fourth industrial revolution: A positive prospect in sustainable manufacturing. *Procedia Manuf.* **2018**, *21*, 671–678. [[CrossRef](#)]
47. Blunck, E.; Werthmann, H. Industry 4.0—An opportunity to realize sustainable manufacturing and its potential for a circular economy. In Proceedings of the DIEM: Dubrovnik International Economic Meeting, Dubrovnik, Croatia, 12–14 October 2017. Available online: <https://hrcak.srce.hr/187419> (accessed on 23 August 2018).
48. De Man, J.C.; Strandhagen, J.O. An Industry 4.0 research agenda for sustainable business models. *Procedia CIRP* **2017**, *63*, 721–726. [[CrossRef](#)]
49. De Sousa Jabbour, A.B.L.; Jabbour, C.J.C.; Foropon, C.; Filho, M.G. When titans meet—Can industry 4.0 revolutionise the environmentally-sustainable manufacturing wave? the role of critical success factors. *Technol. Forecast. Soc. Chang.* **2018**, *132*, 18–25. [[CrossRef](#)]
50. Waibel, M.W.; Steenkamp, L.P.; Moloko, N.; Oosthuizen, G.A. Investigating the effects of Smart Production Systems on sustainability elements. *Procedia Manuf.* **2017**, *8*, 731–737. [[CrossRef](#)]
51. Ding, B. Pharma industry 4.0: Literature review and research opportunities in sustainable pharmaceutical supply chains. *Process Saf. Environ. Prot.* **2018**, *119*, 115–130. [[CrossRef](#)]
52. Luthra, S.; Mangla, S.K. Evaluating challenges to industry 4.0 initiatives for supply chain sustainability in emerging economies. *Process Saf. Environ. Prot.* **2018**, *117*, 168–179. [[CrossRef](#)]
53. Plenert, G. Optimizing theory of constraints when multiple constrained resources exist. *Eur. J. Oper. Res.* **1993**, *70*, 126–133. [[CrossRef](#)]
54. Tsai, W.H.; Kuo, L. Operating Costs and Capacity in the Airline Industry. *J. Air Transp. Manag.* **2004**, *10*, 269–275. [[CrossRef](#)]
55. Tsai, W.H. Quality cost measurement under activity-based costing. *Int. J. Q. Reliab. Manag.* **1998**, *15*, 719–752. [[CrossRef](#)]
56. Tsai, W.H.; Lai, C.W.; Tseng, L.J.; Chou, W.C. Embedding Management Discretionary Power into An ABC Model for A Joint Products Mix Decision. *Int. J. Prod. Econ.* **2008**, *115*, 210–220. [[CrossRef](#)]
57. Tsai, W.H.; Kuo, L.; Lin, T.W.; Kuo, Y.C.; Shen, Y.S. Price elasticity of demand and capacity expansion features in an enhanced ABC product-mix Decision Model. *Int. J. Prod. Res.* **2010**, *48*, 6387–6416. [[CrossRef](#)]
58. Tsai, W.H.; Lin, W.R.; Fan, Y.W.; Lee, P.L.; Lin, S.J.; Hsu, J.L. Applying A Mathematical Programming Approach for A Green Product Mix Decision. *Int. J. Prod. Res.* **2012**, *50*, 1171–1184. [[CrossRef](#)]
59. Tsai, W.H.; Lin, S.J.; Liu, J.Y.; Lin, W.R.; Lee, K.C. Incorporating life cycle assessments into building project decision-making: An energy consumption and CO<sub>2</sub> emission perspective. *Energy* **2011**, *36*, 3022–3029. [[CrossRef](#)]
60. Tsai, W.H.; Shen, Y.S.; Lee, P.L.; Chen, H.C.; Kuo, L.; Huang, C.C. Integrating information about the cost of carbon through activity-based costing. *J. Clean. Prod.* **2012**, *36*, 102–111. [[CrossRef](#)]
61. Tsai, W.H.; Lin, S.J.; Lee, Y.F.; Chang, Y.C.; Hsu, J.L. Construction method selection for green building projects to improve environmental sustainability by using an MCDM approach. *J. Environ. Plan. Manag.* **2013**, *56*, 1487–1510. [[CrossRef](#)]

62. Tsai, W.H.; Yang, C.H.; Huang, C.T.; Wu, Y.Y. The Impact of the Carbon Tax Policy on Green Building Strategy. *J. Environ. Plan. Manag.* **2017**, *60*, 1412–1438. [[CrossRef](#)]
63. Tsai, W.H.; Hung, S.J. A fuzzy goal programming approach for green supply chain optimisation under activity-based costing and performance evaluation with a value-chain structure. *Int. J. Prod. Res.* **2009**, *47*, 4991–5017. [[CrossRef](#)]
64. Tsai, W.H.; Hung, S.J. Treatment and recycling system optimisation with activity based costing in WEEE reverse logistics management: An environmental supply chain perspective. *Int. J. Prod. Res.* **2009**, *47*, 5391–5420. [[CrossRef](#)]
65. Tsai, W.H.; Lai, C.W. Outsourcing or capacity expansions: Application of activity based costing model on joint product decisions. *Comput. Oper. Res.* **2007**, *34*, 3666–3681. [[CrossRef](#)]
66. Tsai, W.H.; Lee, K.C.; Lin, H.L.; Liu, J.Y.; Chou, Y.W.; Lin, S.J. A mixed activity based costing decision model for green airline fleet planning under the constraints of the European Union Emissions Trading Scheme. *Energy* **2012**, *39*, 218–226. [[CrossRef](#)]
67. Kaplan, R.S. Management accounting for advanced technological environments. *Science* **1989**, *245*, 819–823. [[CrossRef](#)] [[PubMed](#)]
68. Patterson, M.C. The product-mix decision: A comparison of theory of constraints and labor-based management accounting. *Prod. Invent. Manag. J.* **1992**, *33*, 80–85.
69. Kaplan, R.S.; Cooper, R. *Cost & Effect: Using Integrated Cost Systems to Drive Profitability and Performance*; Harvard Business School Press: Boston, MA, USA, 1998.
70. Srinivassan, A.; Carey, M.; Morton, T. *Resource Pricing and Aggregate Scheduling in Manufacturing Systems*; Graduate School of Industrial Administration, Carnegie-Mellon University: Pittsburgh, PA, USA, 1988.
71. Karmarkar, U. Capacity loading and release planning with work-in-process and lead times. *J. Manuf. Oper. Manag.* **1989**, *2*, 105–123.
72. Chu, S.C.K. Optimal master production scheduling in a flexible manufacturing system: The case of total aggregation. In Proceedings of the First Conference on the Operational Research Society of Hong Kong, Hong Kong, China, 21–22 June 1991; pp. 103–108.
73. Asmundsson, J.; Rardin, R.; Turkseven, C.; Uzsoy, R. Production Planning with Resources Subject to Congestion. *Nav. Res. Logist.* **2009**, *56*, 142–157. [[CrossRef](#)]
74. Kefeli, A.; Uzsoy, R.; Fathi, Y.; Kay, M. Using a mathematical programming model to examine the marginal price of capacity resources. *Int. J. Prod. Econ.* **2011**, *131*, 383–391. [[CrossRef](#)]
75. Kacar, N.B.; Uzsoy, R. Estimating clearing functions for production resources using simulation optimization. *IEEE Trans. Autom. Sci. Eng.* **2015**, *12*, 539–552. [[CrossRef](#)]
76. Beale, E.M.L.; Tomlin, J.A. Special facilities in a general mathematical programming system for non-convex problems using ordered sets of variables. *Oper. Res.* **1969**, *69*, 447–454.
77. Williams, H.P. *Model Building in Mathematical Programming*, 2nd ed.; Wiley: New York, NY, USA, 1985; pp. 173–177.
78. Wang, B.; Liu, B.; Niu, H.; Liu, J.; Yao, S. Impact of energy taxation on economy, environmental and public health quality. *J. Environ. Manag.* **2017**, *206*, 85–92. [[CrossRef](#)] [[PubMed](#)]
79. Igor, L.W.; George, V.B.; Jose, L.D.M.; Ofelia, D.Q.F.A. Carbon dioxide utilization in a microalga-based biorefinery: Efficiency of carbon removal and economic performance under carbon taxation. *J. Environ. Manag.* **2017**, *203*, 988–998.
80. Ward, S.C.; Chapman, C.B. Risk-management perspective on the project lifecycle. *Int. J. Proj. Manag.* **1995**, *13*, 145–149. [[CrossRef](#)]
81. Zhong, R.Y. Analysis of RFID datasets for smart manufacturing shop floors. In Proceedings of the 15th IEEE International Conference on Networking, Sensing and Control, ICNSC 2018, Zhuhai, China, 27–29 March 2018.
82. Gontarz, A.; Hampl, D.; Weiss, L.; Wegener, K. Resource Consumption Monitoring in Manufacturing Environments. *CIRP Ann.-Manuf. Technol.* **2015**, *26*, 264–269. [[CrossRef](#)]
83. Manyika, J.; Chui, M.; Brown, B.; Bughin, J.; Dobbs, R.; Roxburgh, C.; Byers, A.H. Big Data: The Next Frontier for Innovation, Competition and Productivity. McKinsey Global Institute Report. 2011. Available online: <https://www.mckinsey.com/business-functions/digital-mckinsey/our-insights/big-data-the-next-frontier-for-innovation> (accessed on 18 August 2018).
84. Zhong, R.Y.; Wang, L.; Xu, X. An IoT-enabled real-time machine status monitoring approach for cloud manufacturing. *Procedia CIRP* **2017**, *63*, 709–714. [[CrossRef](#)]

85. Da Silva, P.R.S.; Amaral, F.G. An integrated methodology for environmental impacts and costs evaluation in industrial processes. *J. Clean. Prod.* **2009**, *17*, 1339–1350. [[CrossRef](#)]
86. Jestratjew, A.; Kwiecień, A. Using Cloud Storage in Production Monitoring Systems. In *Communications in Computer and Information Science*; Kwiecień, A., Gaj, P., Stera, P., Eds.; CN 2010: Computer Networks; Springer: Berlin/Heidelberg, Germany, 2010; pp. 226–235.
87. Ahmed, E.; Moutaz, H. The Future of ERP Systems: Look backward before moving forward. *Procedia Technol.* **2012**, *5*, 21–30.
88. Telukdarie, A. MES to ERP integration: Rapid deployment toolset. In Proceedings of the IEEE International Conference on Industrial Engineering and Engineering Management, Bali, Indonesia, 4–7 December 2016; pp. 1030–1035.
89. Rafal, C.; Adam, Z.; Lukasz, H.; Huseyin, E. Agent-based manufacturing execution systems for short-series production scheduling. *Comput. Ind.* **2016**, *82*, 245–258.
90. Zhong, R.Y.; Dai, Q.Y.; Qu, T.; Hu, G.J.; Huang, G.Q. RFID-enabled real-time manufacturing execution system for mass-customization production. *Robot. Comput.-Integr. Manuf.* **2013**, *29*, 283–292. [[CrossRef](#)]
91. Huang, G.Q.; Zhang, Y.F.; Jiang, P.Y. RFID-based wireless manufacturing for walking-worker assembly islands with fixed-position layouts. *Robot. Comput.-Integr. Manuf.* **2007**, *23*, 469–477. [[CrossRef](#)]
92. Zhixin, Y.; Pengbo, Z.; Lei, C. RFID-enabled indoor positioning method for a real-time manufacturing execution system using OS-ELM. *Neurocomputing* **2016**, *174*, 121–133.
93. Wang, C.; Jiang, P.; Lu, T. Production events graphical deduction model enabled real-time production control system for smart job shop. *Proc. Inst. Mech. Eng. Part C* **2018**, *232*, 2803–2820. [[CrossRef](#)]
94. Uhlemann, T.H.J.; Lehmann, C.; Steinhilper, R. The Digital Twin: Realizing the Cyber-Physical Production System for Industry 4.0. *Procedia CIRP* **2017**, *61*, 335–340. [[CrossRef](#)]
95. Longo, F.; Nicoletti, L.; Padovano, A. Smart operators in industry 4.0: A human-centered approach to enhance operators' capabilities and competencies within the new smart factory context. *Comput. Ind. Eng.* **2017**, *113*, 144–159. [[CrossRef](#)]
96. Bauza, M.B.; Tenboer, J.; Li, M.; Lisovich, A.; Zhou, J.; Pratt, D.; Ewards, J.; Zhang, H.; Turch, C.; Knebel, R. Realization of industry 4.0 with high speed CT in high volume production. *CIRP J. Manuf. Sci. Technol.* **2018**, *22*, 121–125. [[CrossRef](#)]
97. Trstenjak, M.; Cosic, P. Process Planning in Industry 4.0 Environment. *Procedia Manuf.* **2017**, *11*, 1744–1750. [[CrossRef](#)]
98. Roser, C.; Lorentzen, K.; Deuse, J. Reliable shop floor Bottleneck detection for flow lines through process and inventory observations. *Procedia CIRP* **2014**, *19*, 63–68. [[CrossRef](#)]
99. Jia, Z.; Zhang, L.; Arinez, J.; Xiao, G. Performance analysis for serial production lines with Bernoulli Machines and Real-time WIP-based Machine switch-on/off control. *Int. J. Prod. Res.* **2016**, *54*, 6285–6301. [[CrossRef](#)]
100. Teittinen, H.; Pellinen, J.; Järvenpää, M. ERP in action—Challenges and benefits for management control in SME context. *Int. J. Account. Inf. Syst.* **2013**, *14*, 278–296. [[CrossRef](#)]
101. Peres, R.S.; Dionisio Rocha, A.; Leitao, P.; Barata, J. IDARTS—Towards intelligent data analysis and real-time supervision for industry 4.0. *Comput. Ind.* **2018**, *101*, 138–146. [[CrossRef](#)]
102. Yan, J.; Meng, Y.; Lu, L.; Li, L. Industrial big data in an Industry 4.0 environment: Challenges, schemes and applications for predictive maintenance. *IEEE Access* **2017**, *5*, 23484–23491. [[CrossRef](#)]
103. Kiangala, K.S.; Wang, Z. Initiating predictive maintenance for a conveyor motor in a bottling plant using industry 4.0 concepts. *Int. J. Adv. Manuf. Technol.* **2018**, *97*, 3251–3271. [[CrossRef](#)]
104. Rødseth, H.; Schjølberg, P.; Wabner, M.; Frieß, U. Predictive Maintenance for Synchronizing Maintenance Planning with Production. *Lect. Notes Electr. Eng.* **2018**, *451*, 439–446.
105. Delima, A.; Balaunzarán, M. Industry 4.0: The Fourth Industrial Revolution. 10 April 2018. Available online: <http://insights.neoris.com/blogneoris/industry-4.0> (accessed on 20 August 2018).
106. Sokolov, B.; Ivanov, D. Integrated scheduling of material flows and information services in industry 4.0 supply networks. *IFAC-PapersOnLine* **2015**, *28*, 1533–1538. [[CrossRef](#)]
107. Bagheri, B.; Yang, S.; Kao, H.-A.; Lee, J. Cyber-physical systems architecture for self-aware machines in industry 4.0 environment. *IFAC-PapersOnLine* **2015**, *28*, 1622–1627. [[CrossRef](#)]
108. Faul, A.; Jazdi, N.; Weyrich, M. Approach to interconnect existing industrial automation systems with the industrial internet. In Proceedings of the 2016 IEEE 21st International Conference on Emerging Technologies and Factory Automation (ETFA), Berlin, Germany, 6–9 September 2016.

109. Jun, C.; Lee, J.Y.; Yoon, J.-S.; Kim, B.H. Applications' integration and operation platform to support smart manufacturing by small and medium-sized enterprises. *Procedia Manuf.* **2017**, *11*, 1950–1957. [CrossRef]
110. Åkerman, M.; Fast-Berglund, Å.; Halvordsson, E.; Stahre, J. Modularized assembly system: A digital innovation hub for the Swedish smart industry. *Manuf. Lett.* **2018**, *15*, 143–146. [CrossRef]
111. Weber, K.M.; Gudowsky, N.; Aichholzer, G. Foresight and Technology Assessment for the Austrian Parliament—Finding New Ways of Debating the Future of Industry 4.0. *Futures* **2018**. Available online: [https://www.terkko.helsinki.fi/article/19090791\\_foresight-and-technology-assessment-for-the-austrian-parliament-finding-new-ways-of-debating-the-future-of-industry-40](https://www.terkko.helsinki.fi/article/19090791_foresight-and-technology-assessment-for-the-austrian-parliament-finding-new-ways-of-debating-the-future-of-industry-40) (accessed on 20 August 2018). [CrossRef]
112. Gravina, R.; Palau, C.E.; Manso, M.; Liotta, A.; Fortino, G. *Integration, Interconnection and Interoperability of IoT Systems*; Springer: Berlin, Germany, 2018.
113. Mourtzis, D.; Fotia, S.; Boli, N.; Pittaro, P. Product-service system (PSS) complexity metrics within mass customization and Industry 4.0 environment. *Int. J. Adv. Manuf. Technol.* **2018**, *97*, 91–103. [CrossRef]
114. Dalenogarea, L.S.; Benitez, G.B.; Ayalab, N.F.; Frank, A.G. The expected contribution of Industry 4.0 technologies for industrial performance. *Int. J. Prod. Econ.* **2018**, *204*, 383–394. [CrossRef]
115. Almada-Lobo, F. Six Benefits of Industrie 4.0 for Businesses. *Control Engineering*. 25 May 2017. Available online: <https://www.controleng.com/single-article/six-benefits-of-industrie-40-for-businesses/5c57cc3925c0ff323553da64108d5c0c> (accessed on 4 September 2018).
116. Moktadir, M.A.; Ali, S.M.; Kusi-Sarpong, S.; Shaikh, M.A.A. Assessing challenges for implementing Industry 4.0: Implications for process safety and environmental protection. *Process Saf. Environ. Prot.* **2018**, *117*, 730–741. [CrossRef]
117. Tsai, W.-H. Green production planning and control for the textile industry by using mathematical programming and Industry 4.0 techniques. *Energies* **2018**, *11*, 2072. [CrossRef]
118. Tsai, W.-H.; Lai, S.-Y. Green Production Planning and Control Model with ABC under Industry 4.0 for the Paper Industry. *Sustainability* **2018**, *10*, 2932. [CrossRef]



© 2018 by the authors. Licensee MDPI, Basel, Switzerland. This article is an open access article distributed under the terms and conditions of the Creative Commons Attribution (CC BY) license (<http://creativecommons.org/licenses/by/4.0/>).



Article

# Green Activity-Based Costing Production Planning and Scenario Analysis for the Aluminum-Alloy Wheel Industry under Industry 4.0

Wen-Hsien Tsai <sup>1,\*</sup>, Po-Yuan Chu <sup>1</sup> and Hsiu-Li Lee <sup>2</sup>

<sup>1</sup> Department of Business Administration, National Central University, Jhongli, Taoyuan 32001, Taiwan; photoshop83@gmail.com

<sup>2</sup> Department of Accounting Information, Chihlee University of Technology, Banciao, New Taipei 22050, Taiwan; lee05301@yahoo.com.tw

\* Correspondence: whtsai@mgt.ncu.edu.tw; Tel.: +886-3-4227151; Fax: +886-3-4222891

Received: 18 December 2018; Accepted: 25 January 2019; Published: 1 February 2019

**Abstract:** The industrial revolution has grown to the fourth generation, or so-called Industry 4.0. The literature on Industry 4.0 is quite extensive and involves many different dimensions; however, production costs under Industry 4.0 have seldom been discussed. On the other hand, environmental problems are increasingly serious nowadays. Activity-Based Costing is a mature accounting method that can easily trace direct and indirect product costs, based on activities, as well as trace the carbon tax to products, which may lead to different product combinations, in order to reduce environment problems. Thus, the purpose of this paper is to propose a green activity-based costing production planning model under Industry 4.0. In order to make the paper more realistic, we suggest three models with five possible scenarios: normal and material cost fluctuation, material cost discount, and carbon tax with the related cost function. The Aluminum-Alloy Wheel industry was chosen as the illustrative industry to present the results. The model provides managers with a way to deal with the cost problem under Industry 4.0 and to be able to handle the environmental issues in making production decisions. This paper also provides suggestions for governments that have not considered carbon taxation.

**Keywords:** Activity-Based Costing (ABC); Industry 4.0; aluminum-alloy wheel industry; mathematical programming

---

## 1. Introduction

With maturing information, improved communication, and industrial technology, the industrial revolution has grown to the fourth generation, so-called Industry 4.0 [1]. In order to meet the trend, corporations around the world are now facing the huge changes from the traditional factory to the intelligent factory [2]. On the other hand, people around the world are now facing environment problems, such as the ozone hole [3], global warming with its attendant melting arctic ice [4], the emergence of extreme weather [5], etc.; all of these are the result of human destruction of the environment. The green issues have been of concern for many years; governments, corporates, and scholars around the world have also spent much time in exploring different types of green issues.

The current studies on Industry 4.0 have been growing rapidly since the Hannover Fair in Germany (April 2011). The related papers on these issues involve many different dimensions. In engineering, the issues of concern include how to implement, apply or re-engineer [6–13]. In computer science, scholars are not only concerned about the application of the technology of Industry 4.0 [14–16], but also the Internet of Things (IoT), Internet of Services (IoS), Cyber-Physical Systems (CPS), and so on. They are also interested in adding various Information Technology (IT)

elements to improve communication between humans and machines, as well as data utilization [17–25]. In business, management and accounting, the topics include management, control and business strategies [26–30], such as supply chain management, life cycle management, shop floor control, and production control.

The discussions on green issues have continued for more than two decades, from the Kyoto Protocol announced in 1997 to the Paris Agreement announced in 2015, and beyond; the literature also covers various fields. Some of which investigate the relation between society factors and carbon emissions, for example, Begum et al. [31] used econometric approaches to investigate the dynamic impacts on CO<sub>2</sub> emissions with GDP growth, energy consumption, and population growth in Malaysia. They found that both per capita energy consumption and per capita GDP has a positive impact with per capita carbon emissions. Friedlingstein et al. [32] and Meinshausen et al. [33] investigated the 2 °C limitation of global warming, they both point out that the current emission of greenhouse gas may exceed the limit and provide a suggestion or a comprehensive probabilistic analysis for further help. There also exist technological ways to reduce the emission quantity of greenhouse gases [34,35].

There are also researchers using mathematical programming to calculate the emission costs in different fields, such as, airlines [36,37], green buildings [38–41], the electrical and electronic industry [42–44], the pulp and paper industry [45], the pharmaceutical industry [46], and the automotive industry [47]. These papers use the Activity-Based Costing method to collect the carbon cost based on activities, they also combine different ways to make the data more realistic, such as stepwise linear function, fuzzy method, and multiple criteria decision making (MCDM).

Both Industry 4.0 and green issue studies have developed to a certain degree; however, cost calculations of green issues under Industry 4.0 have not yet emerged. Moreover, cost issues are always the mainly concern of the entire enterprise, and these concerns differ for each company. Thus, this paper aims to fill this gap by using the Activity Based Costing (ABC) method to collect data, which could increase the accuracy of cost-related data to control the costs of projects [44,48–50] after the implementation of Industry 4.0, as well as the taxation of carbon tax on each product to address green issues. This paper also tries to provide different models and possible scenarios to deal with complicated real world business situations, such as material cost fluctuations, price discounts with high quantity purchases, etc.

As illustrated above, this paper selects the Aluminum-Alloy Wheel industry as the example industry, and designs three kinds of models with five possible business scenarios, which include normal, material cost fluctuation, material cost discount, and the carbon tax scenario for further scenario analysis. Considering the cost issues in Industry 4.0, we use labor cost as the linkage. The results show different optimal solutions, based on each scenario. Further explanations for each model and scenario are also proposed.

The remaining sections of this paper are organized, as follows: Section 2 discusses the research background; the literature on Industry 4.0, the green production approach, and environmental protection in the Aluminum-Alloy Wheel industry will be introduced. Section 3 presents a green production-planning model under ABC and Industry 4.0; in this section, the cost of each activity can be calculated, as based on the proposed model and assumed scenarios. Section 4 deals with the example data, which show the results based on Section 3. A brief discussion and conclusions are given in Section 5.

## **2. Literature Review**

### *2.1. Brief Introduction to Industry 4.0*

The term “Industry 4.0” was revealed for the first time at the Hannover Fair in April 2011 [1]. According to the dream car report [51], the origin of this term can be traced back to the vision of the industry of the future by the Communication Promoters Group of the Industry Science Research Alliance. With the promotion of this group, the federal government adopted the project



“Industry 4.0” in November 2011 as part of its High-Tech Strategy action plan. At the same time, the Communication Promoters Group initiated the Working Group Industry 4.0, and the first implementation recommendations on Industry 4.0 were developed from January to October 2012; they also accomplished the final report, which included eight fields of action, and proposed it to German Chancellor Angela Merkel at the Hannover Fair in 2013.

The term “Industry 4.0” is a collective concept which contains technologies and concepts of value chain organization [9], such as CPS, IoT, IoS, Smart Factory, and so on. With CPS, the real world and virtual world can be connected together, for example, the refrigerator, washing machine, or other physical objects with a sensor, storage or other intelligent components can deliver the data through the internet to communicate with each other. CPS is also a key factor as a technological enabler of Industry 4.0 [51]. With IoT, objects with internet components, such as Wi-Fi devices, can be easily connected together [52]. The IoT is also a key component in Industry 4.0; it not only can help CPS communicate with each other, but also provide information to humans in real time [9].

The cost issues related to Industry 4.0 already exist in the literature. Ślusarczyk [53] offered an overview on Industry 4.0 and illustrated the expected level of cost reduction, which included weighted average with 3.6% decrease, transportation and logistics with 3.2% decrease, metals with 3.2% decrease, industrial manufacturing with 3.6% decrease, forest, paper, and packaging with 4.2% decrease, engineering and construction with 3.4% decrease, electronics with 3.7% decrease, automotive with 3.9% decrease, and aerospace, defense, and security with 3.7% decrease. Lee et al. [54] illustrated the trends of manufacturing service transformation in big data environments. The author made some conclusions and mentioned that “labor costs will reduce due to the new trend of industry” and “costs will be reduced by energy-saving, optimized maintenance scheduling, and supply chain management”.

## 2.2. Industry 4.0 and Aluminum-Alloy Wheel Industry

Although literature regarding the impact of the introduction of Industry 4.0 on the aluminum-alloy wheel industry is scarce, current application has already been shown in exhibitions around the world. In the 2018 Taipei Intelligent Machinery & Manufacturing Technology Show (iMTduo), the Aluminum-Alloy Wheel industry first presented their applications of Industry 4.0. These applications included Automatic Virtual Metrology (AVM), Augmented and Virtual Reality (AVR), and Intelligent Predictive Maintenance (IPM). With AVM, real time data is sent to the cloud, where anyone can monitor the production process in real time; it also can reduce waste and defect loss during the production process. With AVR and IPM, engineers can obtain the current status and remaining life of each machine part, as well as the ability to conduct remote maintenance.

## 2.3. Green Production and Environmental Protection in the Aluminum-Alloy Wheel Industry

Green issues have led to many entities trying to reduce carbon emissions. In the aluminum-alloy industry, reducing the material weight is a popular method; for example, Yilmaz et al. [55] used three kinds of aluminum alloy to reduce the weight of vehicle doors. Other scholars also employed a lightweight approach to reduce fuel consumption in order to reduce emission quantities [56–59]. Another relevant way, but still related to weight, employed by the aluminum alloy wheel industry involves structural changes or using different casting methods. Deschamps et al. [60] examined the interplay between improving the alloys and the part’s geometry in seeking to reduce the weight; Peng et al. [61] added other materials in the casting process to reduce the weight.

## 3. Green Production Planning Model under ABC and Industry 4.0

### 3.1. A Production Process for a Typical Aluminum-Alloy Wheel Company

The traditional aluminum alloy wheel companies’ production process is simplified, as shown in Figure 1. In this figure, the oval signifies the input/output of an aluminum alloy wheel, where the input will be aluminum ingot or aluminum alloy and the output will be saleable products; the square

means the production process of the aluminum alloy wheel. The overall process can be divided into four parts: Casting, Heat Treatment, Computer Numerical Control (CNC) Processing, and Painting. The CNC Processing can be broken down into first time and second time processing, the use of second time processing will depend on different product types. For example, the typical car wheel may only need the first time CNC process, but the customized vehicle wheel may need both the first time and second time of CNC processing.

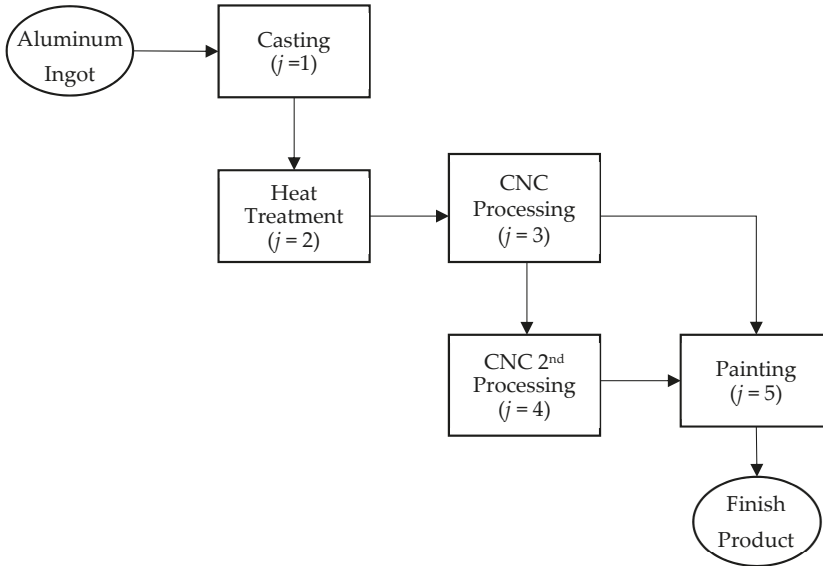

CNC: Computer Numerical Control

**Figure 1.** Aluminum alloy wheel production process.

This section is divided into subheadings, which provide concise and precise descriptions of the experimental results, as well as their interpretations and the experimental conclusions that can be drawn.

### 3.2. Assumptions

In this paper, as assumed, the example of company's profit comes from three types of green products: Car rims ( $i = 1$ ), Truck rims ( $i = 2$ ), and Customized car rims ( $i = 3$ ). In order to be more realistic, this paper proposes three models with five different business scenarios. Where Model A includes the normal scenario and the material fluctuation scenario, which includes rising and falling material costs; Model B is a material discount scenario; and Model C is an environment scenario. Other assumptions used in this green production-planning model are listed below:

1. All activities in this green ABC model are divided into unit-level and batch-level.
2. The related resources driven and activity driver have been chosen by the example company.
3. The unit-selling prices of all products remain the same in the relevant period.
4. The material cost remains the same in the relevant period during the normal and fluctuation scenarios, but when the total purchasing material quantity exceeds that of the first segment, the purchase receives a 1.4% discount for all material, and a 4.2% discount for all material when the purchase quantity exceeds that of the second segment.
5. The direct labor hours according to government policy can be extended by using first overtime work and second overtime work.

6. The carbon tax is taxed at different rates of different emission quantities.
7. The direct labor resources and machine hour resources cannot use outsourcing to expand.

The remainder of this section is, as follows. In Section 3.3, Model A, the ABC model without other business scenarios is introduced. It includes objective function, unit-level labor cost function, batch-level activity cost function, and other sales and production constraints. In Section 3.4, Model B, the material discount scenario is introduced. The objective function and other functions and constraints are based on the Model A mentioned in Section 3.3; a discount function and constraint are added in this scenario. Lastly, Model C considers the carbon tax scenario. The objective function and another constraint are based on Model B, as mentioned in Section 3.4, and the added carbon tax function and constraint are illustrated in Section 3.5.

### 3.3. Model A: ABC Model without Other Business Scenarios

Model A considers the basic business situation, and contains the objective function with Equation (1<sub>A</sub>), the constraints of unit-level direct labor cost function with Equations (2) to (7), the constraints of batch-level activity cost functions for material handling and setup activities with Equations (8) to (11), and other sale and production constraints with Equation (12) and Equation (13). The following subsection introduces the objective function in detail, as well as the associated constraints.

#### 3.3.1. Objective Function

The objective function of the green production-planning model under ABC and Industry 4.0 is as follows:

The company’s maximized profit  $\pi$  = the sales revenue of each product – total direct material consumption cost – labor hour cost – unit-level activity cost – batch-level activity cost – carbon tax – other fixed cost

$$\pi = \sum_{i=1}^n P_i X_i - \sum_{i=1}^n \sum_{k=1}^2 C_k q_{ik} X_i - [LC_1 + \sigma_1(LC_2 - LC_1) + \sigma_2(LC_3 - LC_1)] - d_j \eta_j B_j - \sum_{i=1}^n d_i \gamma_{ij} B_{ij} - F \tag{1A}$$

where

- $\pi$  The company’s profit
- $P_i$  Unit prices when selling one unit of product  $i$
- $X_i$  Total produced quantity of product  $i$
- $C_k$  Costs of material  $k$  when each unit consumed
- $q_{ik}$  The consumption quantity of material  $k$  when producing one unit of product  $i$
- $LC_1, LC_2, LC_3$  Total direct labor cost for normal labor hours ( $LC_1$ ), first overtime ( $LC_2$ ) and second overtime ( $LC_3$ ) work
- $\sigma_0, \sigma_1, \sigma_2$  A special ordered set of type 2 (SOS2) variable, which must be a set of positive variables; at most two variables in ordering can be non-zero [62]
- $d_j$  The activity cost when executing one unit of activity  $j$
- $\eta_j$  The batch-level activity ( $j \in B$ ) driven requirement for material handling activity
- $\gamma_{ij}$  The batch-level activity ( $j \in B$ ) driven requirement for product  $i$  at a setup activity
- $B_j$  The quantity of batch-level activity ( $j \in B$ ) at material handling activity
- $B_{ij}$  The quantity of batch-level activity ( $j \in B$ ) for product  $i$  at setup activity
- $F$  The company’s remaining fixed costs

The detailed description of the above model will be introduced in the subsection below; however, the direct material cost is simpler than the others so we included it here instead of in an independent subsection. The term  $\sum_{i=1}^n \sum_{k=1}^2 C_k q_{ik} X_i$  in the second set of Equation (1<sub>A</sub>) represents total direct material cost. Based on the assumption proposed in Section 3.2, this model’s material cost under normal scenario will be the fixed direct material costs at any quantity. Other cost functions and

constraints: the detailed description of other functions and constraints, such as labor cost function, batch-level activity function, etc., are described in the following sections.

### 3.3.2. Unit-Level Direct Labor Cost Function

The term  $[LC_1 + \sigma_1(LC_2 - LC_1) + \sigma_2(LC_3 - LC_1)]$  in the third set Equation (1<sub>A</sub>) represents the unit-level direct labor cost. Equations (2) to (7) represent the constraints of the direct labor resources. The direct labor resources and their costs are separated into normal, first overtime, and second overtime work hours. The relevant work hours and wage rates can be composed into three segments of piecewise linear function, as shown in Figure 2. In Equations (2) to (7),  $(\beta_1, \beta_2)$  is a special ordered set of type 1 (SOS1) variable, so, when one of the variables is set to one, another variable must be exactly zero;  $(\sigma_0, \sigma_1, \sigma_2)$  is an SOS2 variable, which must be a set of positive variables; at most, two variables in the ordering can be non-zero [62]. If  $\beta_1 = 1$ , then  $\beta_2 = 0$  (Equation (7)),  $\sigma_0, \sigma_1 \leq 1$  (Equations (3), (4)),  $\sigma_2 = 0$  (Equation (5)), and  $\sigma_0 + \sigma_1 = 1$  (Equation (6)). This means the direct labor hours and cost are  $\sigma_0LH_1 + \sigma_1LH_2$  and  $\sigma_0LC_1 + \sigma_1LC_2$ , respectively. It also means that the point  $(\sigma_0LH_1 + \sigma_1LH_2, \sigma_0LC_1 + \sigma_1LC_2)$  is located at the second part of the unit-level direct labor cost function with the first overtime work; this point is also a combination of  $(LH_1, LC_1)$  and  $(LH_2, LC_2)$ . On the other hand, if  $\beta_2 = 1$ , then  $\beta_1 = 0$  (Equation (7)),  $\sigma_1, \sigma_2 \leq 1$  (Equations (4), (5)),  $\sigma_0 = 0$  (Equation (3)), and  $\sigma_1 + \sigma_2 = 1$  (Equation (6)). This means the direct labor hours and cost are  $\sigma_1LH_2 + \sigma_2LH_3$  and  $\sigma_1LC_2 + \sigma_2LC_3$ , respectively. It also means that the point  $(\sigma_1LH_2 + \sigma_2LH_3, \sigma_1LC_2 + \sigma_2LC_3)$  is located at the third part of the unit-level direct labor cost function with the second overtime work, and this point is also a combination of  $(LH_2, LC_2)$  and  $(LH_3, LC_3)$ . The first segment of the unit-level direct labor cost function was set to a fixed cost, which means: (1) no matter how many labor hours were used, the cost remains the same; and (2) no matter whether  $\beta_1 = 1$  or  $\beta_2 = 1$ , the cost will always be added.

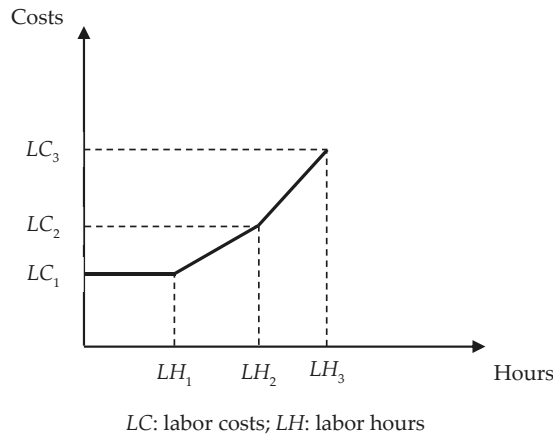

Figure 2. Direct labor cost function.

#### Constraints

$$\sum_{i=1}^n (l_{i1} + l_{i2} + l_{i3} + \theta_i l_{i4} + l_{i5}) X_i \leq LH_1 + \sigma_1(LH_2 - LH_1) + \sigma_2(LH_3 - LH_1) \tag{2}$$

$$\sigma_0 - \beta_1 \leq 0 \tag{3}$$

$$\sigma_1 - \beta_1 - \beta_2 \leq 0 \tag{4}$$

$$\sigma_2 - \beta_2 \leq 0 \tag{5}$$

$$\sigma_0 + \sigma_1 + \sigma_2 = 1 \tag{6}$$

$$\beta_1 + \beta_2 = 1 \tag{7}$$

where

- $li_1, li_2, li_3, li_5$  The usage of labor hours at the first to third and fifth activity when producing one unit of product  $i$
- $\theta_i li_4$  The usage of labor hours at the fourth activity when producing one unit of product  $i$ , and multiplying a coefficient use to determine how much work should be done in the fourth activity
- $LH_1, LH_2, LH_3$  Maximum capacity of direct labor hours at normal ( $LH_1$ ), first overtime ( $LH_2$ ) and second overtime ( $LH_3$ ) work hours
- $\beta_1, \beta_2$  An SOS1 variable, when one of the variables is set to one, another variable must be exactly zero [62].

### 3.3.3. Batch-Level Activity Cost Function for Material Handling and Setup Activities

The terms  $d_j \eta_j B_j$  and  $\sum_{i=1}^n d_i \gamma_{ij} B_{ij}$  in the fourth and fifth set of Equation (1<sub>A</sub>) represent batch-level activity cost functions for material handling and setup activities. Equations (8) and (9) are the constraints of material handling, and Equation (10) and (11) are the constraints of setup activities. We assumed that the material handling stage only considers the procedure from raw material storage location to factory, but the setup activities were considered at each activity. For example, the setup hours are used to measure the setup activity, where  $T_j$  represents the setup hours that can be used,  $\gamma_{ij}$  represents the setup hours needed for  $j$  activity for product  $i$ ;  $M_{ij}$  represents  $i$  product's setup unit in each setup batch.

$$\sum_{i=1}^n q_{i1} X_i \leq \varnothing_j B_j \quad (j = 6) \tag{8}$$

$$\eta_j B_j \leq T_j \quad (j = 6) \tag{9}$$

where

- $\varnothing_j$  The quantity per batch of batch-level activity ( $j \in B$ ) at material handling activity
- $T_j$  The capacity of batch-level activity ( $j \in B$ )

$$X_i \leq M_{ij} B_{ij} \quad (j = 7, i = 1 \dots 3) \tag{10}$$

$$\sum_{i=1}^n \gamma_{ij} B_{ij} \leq T_j \quad (j = 7) \tag{11}$$

where

- $M_{ij}$  The quantity per batch of batch-level activity ( $j \in B$ ) for product  $i$  at setup activity

### 3.3.4. Other Sale and Production Constraints

The constraints in this part do not influence the profit directly, but will indirectly influence the profit because of the limitation of the resources. Equations (12) and (13) represent the machine hour constraints for activities 1, 2, and 5 and for activities 3 and 4 so-called CNC, respectively. In Equation (12), when the factory produces one unit of product  $i$ , it will need  $h_i$  hours at activity  $j$ . Each activity has its own capacity  $MH_j$ . In Equation (13), when the factory produces one unit of product  $i$ , it will need  $h_{i3}$  hours and additional reprocessing hours with coefficient  $\theta_i h_{i4}$  at activity CNC; Activity 3 and 4 shared the capacity  $MH_{CNC}$ .

$$\sum_{i=1}^n h_{ij} X_i \leq MH_j \quad (j = 1, 2, 5) \tag{12}$$

$$\sum_{i=1}^n (h_{i3} X_i + \theta_i h_{i4}) \leq MH_{CNC} \tag{13}$$

where

- $h_{ij}$  The requirement hours when producing a single unit of product  $i$  at activity  $j$
- $MH_j$  The total available machine hours of activity  $j$
- $h_{i3}$  The requirement hours when producing a single unit of product  $i$  at the third activity
- $\theta_i/h_{i4}$  The requirement hours when producing a single unit of product  $i$  at the fourth activity, and multiplying a coefficient use to determine how much work should be done in the fourth activity
- $MH_{CNC}$  The total capacity of machine hours of the third and fourth activities

### 3.4. Model B: ABC Model with Material Discount

Model B considers material discount from the basic business situation of Model A. Model B includes the objective function with Equation (1<sub>B</sub>), which was changed based on Model A. The related constraints associated with material discount are Equations (14) to (18). The constraints associated with other cost functions from Equations (2) to (13) remain the same. That is, Model B includes the objective function with Equation (1<sub>B</sub>) and the related constraints with Equations (2) to (18). The following subsection introduces the objective function and material discount function in detail.

#### 3.4.1. Objective Function

In this subsection, the material discount business scenario is considered and the objective function which was changed based on Equation (1<sub>A</sub>), is also proposed. In Model B, assume that only the first material has the material quantity discount.

$$\pi = \sum_{i=1}^n P_i X_i - (DC_1 Q_1 + DC_2 Q_2 + DC_3 Q_3 + \sum_{i=1}^n C_2 q_{i2} X_i) - [LC_1 + \sigma_1(LC_2 - LC_1) + \sigma_2(LC_3 - LC_1)] - d_j \eta_j B_j - \sum_{i=1}^n d_j \gamma_{ij} B_{ij} - F \tag{1<sub>B</sub>}$$

where

- $C_2$  Unit costs of the second material
- $q_{i2}$  The consumption quantity of the second material when producing a single unit of product  $i$
- $DC_1, DC_2, DC_3$  Unit costs of the first material at normal ( $DC_1$ ), first ( $DC_2$ ) and second ( $DC_3$ ) discount situations
- $Q_1, Q_2, Q_3$  The consumption quantity of first material at normal ( $Q_1$ ), first ( $Q_2$ ) and second ( $Q_3$ ) discount situations

#### 3.4.2. Material Discount Function

The material discount is a very common business scenario in the real world. This study uses three segments of piecewise linear function, as shown in Figure 3. In Equations (14) to (18), ( $\varphi_0, \varphi_1, \varphi_2$ ) is an SOS1 variable; when one of the variables is set to one, another variable must be exactly zero. If  $\varphi_1 = 1$ , then  $\varphi_2, \varphi_3 = 0$  (Equation 18),  $Q_2, Q_3 = 0$  (Equations (15) and (17)),  $Q_1 \geq 0, Q_1 \leq \varphi_1 R_1$  (Equation (16)). This means that the material quantity and cost are  $Q_1$  and  $DC_1 Q_1$ , respectively, and are on the first segment of the material cost function. On the other hand, if  $\varphi_2 = 1$ , then  $\varphi_1, \varphi_3 = 0$  (Equation (18)),  $Q_1, Q_3 = 0$  (Equations (16) and (17)),  $Q_2 \geq \varphi_2 R_1, Q_2 \leq \varphi_2 R_2$  (Equation (15)). This means that the material quantity and cost are  $Q_2$  and  $DC_2 Q_2$ , respectively, and are on the second segment of the material cost function. The third segment of the material cost function does not set the bundle, which means the quantity more than  $R_2$  will be at the same cost  $DC_3 Q_3$ .

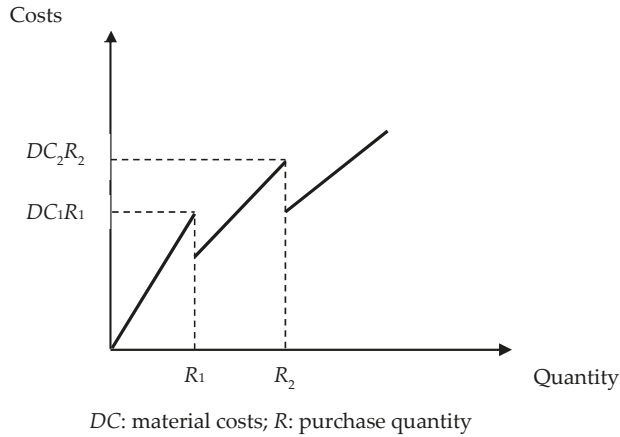

Figure 3. Direct material cost function.

Constraints

$$\sum_{i=1}^n q_{i1}X_i = Q_1 + Q_2 + Q_3 \tag{14}$$

$$0 \leq Q_1 \leq \varphi_1R_1 \tag{15}$$

$$\varphi_2R_1 < Q_2 \leq \varphi_2R_2 \tag{16}$$

$$\varphi_3R_2 < Q_3 \tag{17}$$

$$\varphi_1 + \varphi_2 + \varphi_3 = 1 \tag{18}$$

where

- $R_1, R_2$  Maximum purchase quantity of material at normal ( $R_1$ ) and first discount ( $R_2$ ) situation
- $\varphi_1, \varphi_2, \varphi_3$  An SOS1 variable; when one of the variables is set to one, another variable must be exactly zero [62].

### 3.5. Model C: ABC Model with Material Discount and Carbon Tax

Model C considers carbon tax with a material discount and the basic business situation. Model C contains the objective function with Equation (1<sub>C</sub>), which was changed based on Model B. The related constraints with the carbon tax function are Equations (19) to (24). Other cost functions from Equation (2) to Equation (18) remain the same. That is, Model C includes the objective function with Equation (1<sub>C</sub>) and the related constraints with Equation (2) to (24). The following subsection introduces the objective function and carbon tax function in detail.

#### 3.5.1. Objective Function

In this subsection, the material discount and carbon tax business scenario is considered, and the objective function which was changed based on Equation (1<sub>B</sub>), is also proposed.

$$\begin{aligned} \pi = & \sum_{i=1}^n P_iX_i - (DC_1Q_1 + DC_2Q_2 + DC_3Q_3 + \sum_{i=1}^n C_2q_{i2}X_i) \\ & - [LC_1 + \sigma_1(LC_2 - LC_1) + \sigma_2(LC_3 - LC_1)] - d_j\eta_jB_j - \sum_{i=1}^n d_j\gamma_{ij}B_{ij} \\ & - (\delta_1CCE_1 + \delta_2CCE_2) - F \end{aligned} \tag{1C}$$

where

- $CCE_1, CCE_2$  The CO<sub>2</sub> emission cost at the first extended ( $CCE_1$ ) situation and second extended ( $CCE_2$ ) situation
- $\delta_0, \delta_1, \delta_2$  An SOS2 variable, which must be a set of positive variables; at most two variables in the ordering can be non-zero [62]

### 3.5.2. Carbon Tax Function

The carbon tax is considered in this paper. This study also uses three segments of piecewise linear function shown in Figure 4. In Equations (19) to (24),  $(\lambda_1, \lambda_2)$  is an SOS1 variable; when one of the variables is set to one, another variable must be exactly zero. If  $\lambda_1 = 1$ , then  $\lambda_2 = 0$  (Equation 24),  $\delta_0, \delta_1 \leq 1$  (Equations (20), (21)),  $\delta_2 = 0$  (Equation (22)), and  $\delta_0 + \delta_1 = 1$  (Equation (23)). This means that the emission quantity and cost are  $\delta_1 CE_1$  and  $\delta_1 CCE_1$ , respectively. It also means that the point  $(\delta_1 CE_1, \delta_1 CCE_1)$  is on the second segment of the carbon tax function. On the other hand, if  $\lambda_2 = 1$ , then  $\lambda_1 = 0$  (Equation (24)),  $\delta_1, \delta_2 \leq 1$  (Equations (21), (22)),  $\delta_0 = 0$  (Equation (20)), and  $\delta_1 + \delta_2 = 1$  (Equation (23)). This means that the emission quantity and cost are  $\delta_1 CE_1 + \delta_2 CE_2$  and  $\delta_1 CCE_1 + \delta_2 CCE_2$ , respectively. It also means that the point  $(\delta_1 CE_1 + \delta_2 CE_2, \delta_1 CCE_1 + \delta_2 CCE_2)$  is on the of carbon tax function. The first segment of the carbon tax function was set to a free cost, which means: (1) no matter how much carbon was emitted, the cost remains the same; and (2) no matter  $\lambda_1 = 1$  or  $\lambda_2 = 1$ , the cost will always be free.

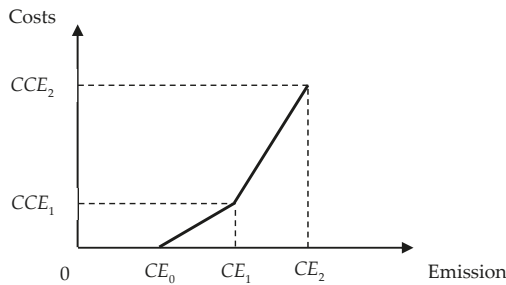

CCE: CO<sub>2</sub> emission costs; CE: CO<sub>2</sub> emission quantity

Figure 4. Carbon tax function.

#### Constraints

$$\sum_{i=1}^n e_i X_i \leq CE_0 + \delta_1(CE_1 - CE_0) + \delta_2(CE_2 - CE_0) \tag{19}$$

$$\delta_0 - \lambda_1 \leq 0 \tag{20}$$

$$\delta_1 - \lambda_1 - \lambda_2 \leq 0 \tag{21}$$

$$\delta_2 - \lambda_2 \leq 0 \tag{22}$$

$$\delta_0 + \delta_1 + \delta_2 = 1 \tag{23}$$

$$\lambda_1 + \lambda_2 = 1 \tag{24}$$

where

- $e_i$  The CO<sub>2</sub> emission quantity when producing one unit of product  $i$
- $CE_0, CE_1, CE_2$  The CO<sub>2</sub> emission quantity at normal ( $CE_0$ ), first extended ( $CCE_1$ ) situation and second extended ( $CCE_2$ ) situation
- $\lambda_1, \lambda_2$  An SOS1 variable; when one of the variable is set to one, another variable must be exactly zero [62]



4. Illustration

In this section, a numerical example is proposed to find the optimal production combination in each model proposed. Company L was chosen as our example company, as an international company that not only sells basic aluminum alloy wheels, but also customized ones.

Following the global trend, Company L decided to implement Industry 4.0; however, this entails changing the production line process and entailing costs. Thus, this paper presents mathematical decision models to help Company L find the best product combination based on Industry 4.0 under an ABC model. LINGO is the best software to solve such complex mathematical decision models.

4.1. Example Data and Optimal Decision Analysis

Company L mainly produces three kinds of products: Car Rims, Truck Rims, and customized Car Rims. Due to the basic product, car rims and truck rims are set with the minimal requirements. Each product consumes two kinds of material: aluminum ingots ( $m = 1$ ) and pigment ( $m = 2$ ), where aluminum ingots encounter material discounts and material fluctuation. Each product requires eight kinds of primary activity, six for the unit-level activity, and two for the batch-level activity. Because of Industry 4.0, the labor hours can be efficaciously reduced. The example data are presented in Table 1, the normal labor hours  $LH_1$  total 44,000 with a wage rate of \$133 per hour and costs of 5,852,000 ( $LC_1$ ). It is possible to increase labor hours by using overtime work. Labor hours  $LH_2$  and  $LH_3$  represent the first and second time overtime work, the additional labor hours are 11,000 and 55,000 with wage rates \$177 and \$200 per hour and costs of 9,735,000 ( $LC_2$ ) and 19,800,000 ( $LC_3$ ), respectively. Each activity has its own capacity: 46,200 hours for casting ( $MH_1$ ), 50,400 for heat treatment ( $MH_2$ ), CNC 1<sup>st</sup> and 2<sup>nd</sup> processing shared same machine hours, 18,900 hours ( $MH_{CNC}$ ), 2,070 hours for painting ( $MH_5$ ), 17,600 batches for material handling ( $T_6$ ) and 17,600 batches for setup ( $T_7$ ).

Table 1. Example data.

		$j$	Products			Available Capacity	
			Car Rims	Truck Rims	Customized Car Rims		
Minimize Requirement		$X_j$	3000	3000	-		
Selling Price		$P_j$	4000	6000	8000		
Unit-level Direct Material							
aluminum ingots ( $m = 1$ )	normal situation	$C_1 = \$70/\text{unit}$	$q_{i1}$	10	20	10	
	material fluctuation with higher cost	$C_1 = \$100/\text{unit}$					
	material fluctuation with lower cost	$C_1 = \$50/\text{unit}$					
pigment ( $m = 2$ )		$C_2 = \$50/\text{unit}$	$q_{i2}$	2	3	4	
	Unit-level activity						
Machine hours	Casting	1	$h_{i1}$	2	3	2	$MH_1 = 46,200$
	Heat Treatment	2	$h_{i2}$	3	4	3	$MH_2 = 50,400$
	CNC Processing	3	$h_{i3}$	1	1	1	$MH_{CNC} = 18,900$
	CNC 2 <sup>nd</sup> Processing	4	$\theta_i h_{i4}$	0	0	0.9	
	Painting	5	$h_{i5}$	0.1	0.1	0.2	$MH_5 = 2070$
Labor hours	Casting	1	$l_{i1}$	1.2	1.7	1.2	
	Heat Treatment	2	$l_{i2}$	1.5	2	1.5	
	CNC Processing	3	$l_{i3}$	1	1	1.6	
	CNC 2 <sup>nd</sup> Processing	4	$\theta_i l_{i4}$	0	0	1	
	Painting	5	$l_{i5}$	0.3	0.3	0.7	
Batch-level activity	Handling	$d_6 = \$2,500/\text{batch}$	6	$\eta_j$ $\phi_j$	1 100		$T_6 = 17,600$
	Setup	$d_7 = \$200/\text{batch}$	7	$\gamma_i$ $M_i$	1 2	1 2	2.5 1

Table 1. Cont.

				Products		
				Car Rims	Truck Rims	Customized Car Rims
Carbon tax	$CCE_1 = \$10,000,000$	$CCE_2 = \$50,000,000$	$e_i$	1	1.5	2.5
Emission quantity	$CE_1 = 25,000$	$CE_2 = 50,000$				
Rate	400/m.t.	1000/m.t.				
Direct labor constraint-Cost	$LC_1 = \$5,852,000$	$LC_2 = \$9,735,000$	$LC_3 = \$19,800,000$			
Labor hours	$LH_1 = 44,000$	$LH_2 = 55,000$	$LH_3 = 99,000$			
Wage rate	\$133/h	\$177/h	\$200/h			
Material cost with discount	\$14,000,000	\$34,500,000	>500,000			
Quantity	$R_1 = 200,000$	$R_2 = 500,000$				
Cost	$DC_1 = \$70$	$DC_2 = \$69$	$DC_3 = \$67$			

4.2. Data Analysis with Different Business Scenarios

In this subsection, the maximum profit was derived by using LINGO; the data are presented in Table 1. The material aluminum ingots contain three kinds of prices, the  $C_1 = \$70$ /unit was used in the Model A (normal scenario), Model B, and Model C; the  $C_1 = \$100$ /unit was used in Model A material fluctuation with increasing price; and the  $C_1 = \$50$ /unit was used in Model A material fluctuation with decreasing price. Each business scenario with its objective function and the related constraints of various cost functions is presented in Tables A1–A5. Tables 2–4 show the optimal solution for each scenario.

Table 2. Optimal solution for Model A.

<i>Scenario 1: ABC Model without other business scenario</i>
$\pi = 38,471,730; X_1 = 3000; X_2 = 6730; X_3 = 4826; \beta_1 = 0; \beta_2 = 1; \sigma_0 = 0; \sigma_1 = 0.5544091; \sigma_2 = 0.4455909; B_6 = 2129; B_{17} = 1500; B_{27} = 3365; B_{37} = 4826$
<i>Scenario 2a: ABC Model with material fluctuation (material cost increase)</i>
$\pi = 32,159,560; X_1 = 3000; X_2 = 5910; X_3 = 5257; \beta_1 = 0; \beta_2 = 1; \sigma_0 = 0; \sigma_1 = 0.5888182; \sigma_2 = 0.4111818; B_6 = 2008; B_{17} = 1500; B_{27} = 2955; B_{37} = 5257$
<i>Scenario 2b: ABC Model with material fluctuation (material cost decrease)</i>
$\pi = 42,728,930; X_1 = 3000; X_2 = 6730; X_3 = 4826; \beta_1 = 0; \beta_2 = 1; \sigma_0 = 0; \sigma_1 = 0.5544091; \sigma_2 = 0.4455909; B_6 = 2129; B_{17} = 1500; B_{27} = 3365; B_{37} = 4826$

[Note] The models for Scenario 1, 2a, and 2b are shown in Tables A1–A3 of Appendix A, respectively.

Table 3. Optimal solution for Model B.

<i>Scenario 3: ABC Model with material discount</i>
$\pi = 38,684,590; X_1 = 3000; X_2 = 6730; X_3 = 4826; \varphi_1 = 0; \varphi_2 = 1; \varphi_3 = 0; Q_1 = 0; Q_2 = 212,860; Q_3 = 0; \beta_1 = 0; \beta_2 = 1; \sigma_0 = 0; \sigma_1 = 0.5544091; \sigma_2 = 0.4455909; B_6 = 2129; B_{17} = 1500; B_{27} = 3365; B_{37} = 4826$

[Note] The models for Scenario 3 is shown in Table A4 of Appendix A.

Table 4. Optimal solution for Model C.

<i>Scenario 4: ABC model with material discount and carbon tax</i>
$\pi = 31,001,270; X_1 = 3014; X_2 = 5894; X_3 = 5258; \varphi_1 = 0; \varphi_2 = 1; \varphi_3 = 0; Q_1 = 0; Q_2 = 200,600; Q_3 = 0; \beta_1 = 0; \beta_2 = 1; \sigma_0 = 0; \sigma_1 = 0.5892273; \sigma_2 = 0.4107727; B_6 = 2006; B_{17} = 1507; B_{27} = 2947; B_{37} = 5258; \lambda_1 = 0; \lambda_2 = 1; \delta_0 = 0; \delta_1 = 1; \delta_2 = 0$

[Note] The models for Scenario 4 is shown in Table A5 of Appendix A.

#### 4.2.1. Model A: ABC Model without Other Business Scenarios and ABC Model with Material Fluctuation Scenario

The optimal solution of the ABC Model without other business scenarios is shown in Table 2. The maximum profit  $\pi$  was 38,471,730; three kinds of product with production quantities of 3000, 6730, and 4826, respectively; labor hours at less than half of the third segment ( $\sigma_1 = 0.5544091$ ;  $\sigma_2 = 0.4455909$ ;  $\beta_2 = 1$ ), which means it is at the second overtime work hours. The result indicates that only product 1 involves minimal requirements; although the material and other resources used are smaller than the other two products, the profit provided by product 1 is too little to cover the costs. This scenario provides the basic view and different overtime work situation, which means managers can use this example data to optimize their distribution of human resources.

The ABC Model with material fluctuation scenario is price adjusted based on Model A. This paper divides this scenario into two parts: the ABC Model with material cost increase and the ABC Model with material cost decrease. Here, we assume that the cost of the main material, meaning aluminum ingots, will fluctuate based on the real-world situation; the price was based on the international average price of \$70 per kilogram, \$50 at lowest price and \$100 at highest price. The maximum profit  $\pi$  with the lowest material cost: 42,728,930, and with highest material cost: 32,159,560. The major difference in this scenario is product combination: three kinds of product with production quantities of 3000, 6730, 4826 at lowest price and 3,000, 5,910, 5,257 at highest price. As we can see, the material costs directly affect the production quantity and profit. With the lowest material cost, the product combination is the same as in the normal scenario but with 11% profit increment; with the highest material cost, the product quantity  $X_2$  decreases by 820 units, the product quantity  $X_3$  increases by 431 units, and the profit decreases by 16.4%. This scenario provides a guideline when a corporation has less power to deal with price contracts and faces material fluctuations; it also helps them to adjust their production quantity and other resources when the material cost is moving higher or lower.

#### 4.2.2. Model B: ABC Model with material discount scenario

This scenario is an extension of Model A; assume that the corporation has the power to deal with contract prices. Three kinds of price and quantity combinations were set to \$70 per unit from 1 to 200000 units, \$69 per unit from 200001 to 500000 units, and \$67 per unit after 500001 units. As shown in Table 3, the maximum profit  $\pi$  was 38,684,590, and the first discount segment was activated with quantity 212,860 ( $\varphi_2 = 1$ ); three kinds of materials and other resources, such as labor hours and machine hours are the same as in the normal scenario. Although the only difference is the profit, this scenario provides a guideline to deal with product combinations when managers face such situations.

#### 4.2.3. Model C: ABC Model with Material Discount and Carbon Tax Scenario

This scenario is an extension of Model B where carbon taxes are also considered. According to the results in Table 4, three kinds of product quantity: 3,014, 5,894, and 5,258 units, differ from the other scenarios; maximum profit  $\pi$  was 31,001,270; the material discount level is as same as in the material discount scenario, but the material quantity decreased to 200,600 units; the carbon emission level is exactly at the boundary of the second to third segments ( $\lambda_2 = 1$ ;  $\delta_1 = 1$ ). The results indicate that the emission cost not only affects the profit but also the product combination, since product 1 with 1 unit of emission quantity, 1.5 units for product 2, and 2.5 units for product 3. Although product 3 entails high emissions, the product quantities still rise to the maximum profit. This scenario includes the carbon tax situation, which is facing big challenges as in the real world now. It can also help managers to rearrange their production strategies in order to maximize their profit and minimize the impact on the environment.

### 4.3. Summary

This subsection offers a brief summary of all the assumed scenarios. First, the product combinations are different among each scenario. In Model A, only the material costs are different, while other resources remain the same; Model B is very similar to model A, but adds the material discount cost function. The three scenario material costs in Model A are \$70, \$100, and \$50 respectively, while in Model B, the first discount segment with material cost of \$69 is activated. If costs are below or remain at the average price, the company can continue using such product combinations to make the maximum profit. Model C is more complicated, and may not be suitable for this pattern, as it requires further consideration of the added carbon tax on each product.

Second, the labor hour usage among each model has little difference, each model uses the second overtime rate of 1.66 times the wage rate. Under Industry 4.0, the requirements of labor resources will gradually decrease, and be replaced by machines; although the current human resources are seemingly insufficient, it is not recommended that the company add human resources, but instead select machine capacity.

Third, in these models, the bottle neck occurs at the batch-level setup activity. In this paper, 1, 1, and 2.5 times the setup activity for each product has been assumed. The example company mainly uses laborers for setup activity. As in human resources, the adoption of Industry 4.0 will gradually replace human laborers, thus, at that time, many activities will depend on machines, and bottle necks will shift to machine hours.

Finally, the carbon tax cost function has been added in Model C. In this scenario, the profit is significantly decreased. However, the carbon tax is just a beginning, as governments around the world must consider both carbon tax and carbon rights. The continued development of society will bring more environmental damage, which will lead to increased environmental protection costs.

## 5. Discussion and Conclusions

Industry 4.0 was a hot issue when it was first announced at the Hannover Fair in April 2011; green issues were also recognized as urgent problems that need to be dealt with, and have already lasted for more than two decades.

In this paper, the green activity-based costing production-planning model under Industry 4.0 was proposed. In order to meet the real world situation, this paper proposed three models with five scenarios, which include, Model A: ABC Model without other business scenarios and ABC Model with the material fluctuation scenario; Model B: ABC Model with the material discount scenario; and Model C: ABC model with both the material discount and carbon tax scenario. These models include several kinds of cost functions, such as the direct labor cost function, direct material cost function, batch-level activity cost function, and carbon tax function. LINGO software was chosen, as it is the best software to solve such complex mathematical decision models, in order to deal with the example data based on these scenarios. This paper provides a way for managers to not only be able to deal with the complex cost problem based on Industry 4.0, but also to handle the environmental issues in making production decisions.

Although this paper provides various scenarios to deal with the possible situations in the real world, there are still some limitations. First, in this ABC model, additional labor hours cannot be used when normal labor hours have not been fully used. Second, the carbon emission costs only consider the cost of usage quantity, while carbon rights and carbon tax have already started to be considered in some countries. Due to these limitations, we suggest that future research considers both carbon tax and carbon rights. We also suggest that countries should engage in comprehensive consideration of the carbon tax system, which will not only create additional taxation, but will also have benefit on lowering global warming.

**Author Contributions:** W.-H.T. provided the research idea, the research purpose and designed the research; P.-Y.C. collected and analyzed the data and wrote the paper; H.-L.L. provided the research method and analyzed the data; W.-H.T. provided the research method, supervised, corrected, and revised this paper. All authors read and approved the final manuscript.

**Funding:** This research was funded by the Ministry of Science and Technology of Taiwan under Grant No. MOST106-2410-H-008-020-MY3.

**Acknowledgments:** The authors are extremely grateful to the sustainability journal editorial team and reviewers who provided valuable comments for improving the quality of this article. The authors also would like to thank the Ministry of Science and Technology of Taiwan for financial support of this research under Grant No. MOST106-2410-H-008-020-MY3.

**Conflicts of Interest:** The authors declare no conflict of interest.

**Appendix A**

**Table A1.** Objective function and constraints for Model A: scenario 1.

<b>Objective function</b>	
Maximum $\pi = 4000 \cdot X_1 + 6000 \cdot X_2 + 8000 \cdot X_3 - (700 + 100) \cdot X_1 - (1400 + 150) \cdot X_2 - (700 + 200) \cdot X_3 - 5852000 - 3883000 \cdot \sigma_1 - 7408000 \cdot \sigma_2 - 2500 \cdot B_6 - 200 \cdot B_{17} - 200 \cdot B_{27} - 1000 \cdot B_{37} - F$	
<b>Constraints</b>	
<i>subject to direct labor hour:</i>	<i>subject to machine hour:</i>
$4 \cdot X_1 + 5 \cdot X_2 + 6 \cdot X_3 \leq 44000 + 11000 \cdot \sigma_1 + 55000 \cdot \sigma_2$	$j = 1: 2 \cdot X_1 + 3 \cdot X_2 + 2 \cdot X_3 \leq 46200$
$\sigma_0 - \beta_1 \leq 0$	$j = 2: 3 \cdot X_1 + 4 \cdot X_2 + 3 \cdot X_3 \leq 50400$
$\sigma_1 - \beta_1 - \beta_2 \leq 0$	$j = 3,4: (1+0) \cdot X_1 + (1+0) \cdot X_2 + (1+0.9) \cdot X_3 \leq 18900$
$\sigma_2 - \beta_2 \leq 0$	$j = 5: 0.1 \cdot X_1 + 0.1 \cdot X_2 + 0.2 \cdot X_3 \leq 2070$
$\sigma_0 + \sigma_1 + \sigma_2 = 1$	
$\beta_1 + \beta_2 = 1$	
<i>subject to batch level - material movement:</i>	<i>subject to minimize requirement:</i>
$10 \cdot X_1 + 20 \cdot X_2 + 10 \cdot X_3 \leq 100 \cdot B_6$	$X_1 \geq 3000$
$1 \cdot B_6 \leq 17600$	$X_2 \geq 3000$
<i>subject to batch level - setup hour:</i>	
$X_1 \leq 2 \cdot B_{17}$	
$X_2 \leq 2 \cdot B_{27}$	
$X_3 \leq 1 \cdot B_{37}$	
$1 \cdot B_{17} + 1 \cdot B_{27} + 2.5 \cdot B_{37} \leq 17600$	

**Table A2.** Objective function and constraints for Model A: scenario 2a.

<b>Objective function</b>	
Maximum $\pi = 4000 \cdot X_1 + 6000 \cdot X_2 + 8000 \cdot X_3 - (1000 + 100) \cdot X_1 - (2000 + 150) \cdot X_2 - (100 + 200) \cdot X_3 - 5852000 - 3883000 \cdot \sigma_1 - 7408000 \cdot \sigma_2 - 2500 \cdot B_6 - 200 \cdot B_{17} - 200 \cdot B_{27} - 1000 \cdot B_{37} - F$	
<b>Constraints</b>	
<i>subject to direct labor hour:</i>	<i>subject to machine hour:</i>
$4 \cdot X_1 + 5 \cdot X_2 + 6 \cdot X_3 \leq 44000 + 11000 \cdot \sigma_1 + 55000 \cdot \sigma_2$	$j = 1: 2 \cdot X_1 + 3 \cdot X_2 + 2 \cdot X_3 \leq 46200$
$\sigma_0 - \beta_1 \leq 0$	$j = 2: 3 \cdot X_1 + 4 \cdot X_2 + 3 \cdot X_3 \leq 50400$
$\sigma_1 - \beta_1 - \beta_2 \leq 0$	$j = 3,4: (1+0) \cdot X_1 + (1+0) \cdot X_2 + (1+0.9) \cdot X_3 \leq 18900$
$\sigma_2 - \beta_2 \leq 0$	$j = 5: 0.1 \cdot X_1 + 0.1 \cdot X_2 + 0.2 \cdot X_3 \leq 2070$
$\sigma_0 + \sigma_1 + \sigma_2 = 1$	
$\beta_1 + \beta_2 = 1$	
<i>subject to batch level - material movement:</i>	<i>subject to minimize requirement:</i>
$10 \cdot X_1 + 20 \cdot X_2 + 10 \cdot X_3 \leq 100 \cdot B_6$	$X_1 \geq 3000$
$1 \cdot B_6 \leq 17600$	$X_2 \geq 3000$
<i>subject to batch level - setup hour:</i>	
$X_1 \leq 2 \cdot B_{17}$	
$X_2 \leq 2 \cdot B_{27}$	
$X_3 \leq 1 \cdot B_{37}$	
$1 \cdot B_{17} + 1 \cdot B_{27} + 2.5 \cdot B_{37} \leq 17600$	

**Table A3.** Objective function and constraints for Model A: scenario 2b.

---

**Objective function**  
 Maximum  $\pi = 4000 * X_1 + 6000 * X_2 + 8000 * X_3 - (500 + 100) * X_1 - (1000 + 150) * X_2 - (500 + 200) * X_3 - 5852000 - 3883000 * \sigma_1 - 7408000 * \sigma_2 - 2500 * B_6 - 200 * B_{17} - 200 * B_{27} - 1000 * B_{37} - F$

**Constraints**

<i>subject to direct labor hour:</i>	<i>subject to machine hour:</i>
$4 * X_1 + 5 * X_2 + 6 * X_3 \leq 44000 + 11000 * \sigma_1 + 55000 * \sigma_2$	$j = 1: 2 * X_1 + 3 * X_2 + 2 * X_3 \leq 46200$
$\sigma_0 - \beta_1 \leq 0$	$j = 2: 3 * X_1 + 4 * X_2 + 3 * X_3 \leq 50400$
$\sigma_1 - \beta_1 - \beta_2 \leq 0$	$j = 3,4: (1+0) * X_1 + (1+0) * X_2 + (1+0.9) * X_3 \leq 18900$
$\sigma_2 - \beta_2 \leq 0$	$j = 5: 0.1 * X_1 + 0.1 * X_2 + 0.2 * X_3 \leq 2070$
$\sigma_0 + \sigma_1 + \sigma_2 = 1$	
$\beta_1 + \beta_2 = 1$	
<i>subject to batch level - material movement:</i>	<i>subject to minimize requirement:</i>
$10 * X_1 + 20 * X_2 + 10 * X_3 \leq 100 * B_6$	$X_1 \geq 3000$
$1 * B_6 \leq 17600$	$X_2 \geq 3000$
<i>subject to batch level - setup hour:</i>	
$X_1 \leq 2 * B_{17}$	
$X_2 \leq 2 * B_{27}$	
$X_3 \leq 1 * B_{37}$	
$1 * B_{17} + 1 * B_{27} + 2.5 * B_{37} \leq 17600$	

---

**Table A4.** Objective function and constraints for Model B: scenario 3.

---

**Objective function**  
 Maximum  $\pi = 4000 * X_1 + 6000 * X_2 + 8000 * X_3 - 70 * Q_1 - 69 * Q_2 - 67 * Q_3 - 100 * X_1 - 150 * X_2 - 200 * X_3 - 5852000 - 3883000 * \sigma_1 - 7408000 * \sigma_2 - 2500 * B_6 - 200 * B_{17} - 200 * B_{27} - 1000 * B_{37} - F$

**Constraints**

<i>subject to direct labor hour:</i>	<i>subject to machine hour:</i>
$4 * X_1 + 5 * X_2 + 6 * X_3 \leq 44000 + 11000 * \sigma_1 + 55000 * \sigma_2$	$j = 1: 2 * X_1 + 3 * X_2 + 2 * X_3 \leq 46200$
$\sigma_0 - \beta_1 \leq 0$	$j = 2: 3 * X_1 + 4 * X_2 + 3 * X_3 \leq 50400$
$\sigma_1 - \beta_1 - \beta_2 \leq 0$	$j = 3,4: (1+0) * X_1 + (1+0) * X_2 + (1+0.9) * X_3 \leq 18900$
$\sigma_2 - \beta_2 \leq 0$	$j = 5: 0.1 * X_1 + 0.1 * X_2 + 0.2 * X_3 \leq 2070$
$\sigma_0 + \sigma_1 + \sigma_2 = 1$	
$\beta_1 + \beta_2 = 1$	
<i>subject to batch level - material movement:</i>	<i>subject to minimize requirement:</i>
$10 * X_1 + 20 * X_2 + 10 * X_3 \leq 100 * B_6$	$X_1 \geq 3000$
$1 * B_6 \leq 17600$	$X_2 \geq 3000$
<i>subject to batch level - setup hour:</i>	<i>subject to direct material discount:</i>
$X_1 \leq 2 * B_{17}$	$10 * X_1 + 20 * X_2 + 10 * X_3 = Q_1 + Q_2 + Q_3$
$X_2 \leq 2 * B_{27}$	$0 \leq Q_1 \leq \varphi_1 * 200000$
$X_3 \leq 1 * B_{37}$	$\varphi_2 * 200000 < Q_2 \leq \varphi_2 * 500000$
$1 * B_{17} + 1 * B_{27} + 2.5 * B_{37} \leq 17600$	$\varphi_3 * 500000 < Q_3$
	$\varphi_1 + \varphi_2 + \varphi_3 = 1$

---

**Table A5.** Objective function and constraints for Model C: scenario 4.

<b>Objective function</b>	
Maximum $\pi = 4000 * X_1 + 6000 * X_2 + 8000 * X_3 - 70 * Q_1 - 69 * Q_2 - 67 * Q_3 - 100 * X_1 - 150 * X_2 - 200 * X_3 - 5852000 - 3883000 * \sigma_1 - 7408000 * \sigma_2 - 2500 * B_6 - 200 * B_{17} - 200 * B_{27} - 1000 * B_{37} - 10000000 * \delta_1 - 50000000 * \delta_2 - F$	
<b>Constraints</b>	
<i>subject to direct labor hour:</i>	<i>subject to CO2 emission:</i>
$4 * X_1 + 5 * X_2 + 6 * X_3 \leq 44000 + 11000 * \sigma_1 + 55000 * \sigma_2$	$1 * X_1 + 1.5 * X_2 + 2.5 * X_3 \leq 0 + 25000 * \delta_1 + 25000 * \delta_2$
$\sigma_0 - \beta_1 \leq 0$	$\delta_0 - \lambda_1 \leq 0$
$\sigma_1 - \beta_1 - \beta_2 \leq 0$	$\delta_1 - \lambda_1 - \lambda_2 \leq 0$
$\sigma_2 - \beta_2 \leq 0$	$\delta_2 - \lambda_2 \leq 0$
$\sigma_0 + \sigma_1 + \sigma_2 = 1$	$\delta_0 + \delta_1 + \delta_2 = 1$
$\beta_1 + \beta_2 = 1$	$\lambda_1 + \lambda_2 = 1$
<i>subject to batch level - material movement:</i>	<i>subject to minimize requirement:</i>
$10 * X_1 + 20 * X_2 + 10 * X_3 \leq 100 * B_6$	$X_1 \geq 3000$
$1 * B_6 \leq 17600$	$X_2 \geq 3000$
<i>subject to batch level - setup hour:</i>	<i>subject to direct material discount:</i>
$X_1 \leq 2 * B_{17}$	$10 * X_1 + 20 * X_2 + 10 * X_3 = Q_1 + Q_2 + Q_3$
$X_2 \leq 2 * B_{27}$	$0 \leq Q_1 \leq \varphi_1 * 200000$
$X_3 \leq 1 * B_{37}$	$\varphi_2 * 200000 < Q_2 \leq \varphi_2 * 500000$
$1 * B_{17} + 1 * B_{27} + 2.5 * B_{37} \leq 17600$	$\varphi_3 * 500000 < Q_3$
	$\varphi_1 + \varphi_2 + \varphi_3 = 1$
<i>subject to machine hour:</i>	
$j = 1: 2 * X_1 + 3 * X_2 + 2 * X_3 \leq 46200$	
$j = 2: 3 * X_1 + 4 * X_2 + 3 * X_3 \leq 50400$	
$j = 3, 4: (1+0) * X_1 + (1+0) * X_2 + (1+0.9) * X_3 \leq 18900$	
$j = 5: 0.1 * X_1 + 0.1 * X_2 + 0.2 * X_3 \leq 2070$	

## References

1. Ferber, S. Industry 4.0—Germany Takes First Steps toward the Next Industrial Revolution. 2012. Available online: <https://blog.bosch-si.com/industry40/industry-40-germany-takes-first-steps-toward-next-industrial-revolution/2012> (accessed on 30 Jan. 2019).
2. Advantech. Cross-System Integration of an Intelligent Factory. 2016. Available online: <https://www.advantech.com/success-stories/article/e4363b7e-2e87-4019-83d2-d314038a23f9> (accessed on 30 January 2019).
3. Crutzen, P.J.; Arnold, F. Nitric acid cloud formation in the cold Antarctic stratosphere: A major cause for the springtime ‘ozone hole’. *Nature* **1986**, *324*, 651–655. [CrossRef]
4. Vinnikov, K.Y.; Robock, A.; Stouffer, R.J.; Walsh, J.E.; Parkinson, C.L.; Cavalieri, D.J.; Mitchell, J.F.; Garrett, D.; Zakharov, V.F. Global warming and Northern Hemisphere sea ice extent. *Science* **1999**, *286*, 1934–1937. [CrossRef] [PubMed]
5. Francis, J.A.; Vavrus, S.J. Evidence linking Arctic amplification to extreme weather in mid-latitudes. *Geophys. Res. Lett.* **2012**, *39*, 1–6. [CrossRef]
6. Roy, R.; Stark, R.; Tracht, K.; Takacs, S.; Mori, M. Continuous maintenance and the future—Foundations and technological challenges. *CIRP Ann. Manuf. Technol.* **2016**, *65*, 667–688. [CrossRef]
7. Zhou, K.; Liu, T.; Zhou, L. Industry 4.0: Towards future industrial opportunities and challenges. In Proceedings of the 2015 12th International Conference on Fuzzy Systems and Knowledge Discovery (FSKD), Zhangjiajie, China, 15–17 August 2015; pp. 2147–2152.
8. Kang, H.S.; Lee, J.Y.; Choi, S.; Kim, H.; Park, J.H.; Son, J.Y.; Kim, B.H.; Noh, S.D. Smart manufacturing: Past research, present findings, and future directions. *Int. J. Precis. Eng. Manuf. Green Technol.* **2016**, *3*, 111–128. [CrossRef]
9. Hermann, M.; Pentek, T.; Otto, B. Design principles for industrie 4.0 scenarios. In Proceedings of the 2016 49th Hawaii International Conference on System Sciences (HICSS), Koloa, HI, USA, 5–8 January 2016; pp. 3928–3937.
10. Lee, J.; Bagheri, B.; Kao, H.A. A Cyber-Physical Systems architecture for Industry 4.0-based manufacturing systems. *Manuf. Lett.* **2015**, *3*, 18–23. [CrossRef]

11. Schlechtendahl, J.; Keinert, M.; Kretschmer, F.; Lechler, A.; Verl, A. Making existing production systems Industry 4.0-ready: Holistic approach to the integration of existing production systems in Industry 4.0 environments. *Prod. Eng.* **2014**, *9*, 143–148. [[CrossRef](#)]
12. Monostori, L. Cyber-physical production systems: Roots, expectations and R&D challenges. *Procedia CIRP* **2014**, *17*, 9–13.
13. Shrouf, F.; Ordieres, J.; Miragliotta, G. Smart factories in Industry 4.0: A review of the concept and of energy management approached in production based on the Internet of Things paradigm. In Proceedings of the 2014 IEEE International Conference on Industrial Engineering and Engineering Management (IEEM), Selangor, Malaysia, 9–12 December 2014; pp. 697–701.
14. Ungurean, I.; Gaitan, N.-C.; Gaitan, V.G. An IoT architecture for things from industrial environment. In Proceedings of the 2014 10th International Conference on Communications (COMM), Bucharest, Romania, 29–31 May 2014; pp. 1–4.
15. Mosterman, P.J.; Zander, J. Industry 4.0 as a Cyber-Physical System study. *Softw. Syst. Model.* **2016**, *15*, 17–29. [[CrossRef](#)]
16. Jazdi, N. Cyber physical systems in the context of Industry 4.0. In Proceedings of the 2014 IEEE International Conference on Automation, Quality and Testing, Robotics (AQTR), Cluj-Napoca, Romania, 22–24 May 2014.
17. Gorecky, D.; Schmitt, M.; Loskyll, M.; Zühlke, D. Human-machine-interaction in the industry 4.0 era. In Proceedings of the 2014 12th IEEE International Conference on Industrial Informatics (INDIN), Porto Alegre, Brazil, 27–30 July 2014; pp. 289–294.
18. Longo, F.; Nicoletti, L.; Padovano, A. Smart operators in industry 4.0: A human-centered approach to enhance operators' capabilities and competencies within the new smart factory context. *Comput. Ind. Eng.* **2017**, *113*, 144–159. [[CrossRef](#)]
19. O'Donovan, P.; Leahy, K.; Bruton, K.; O'Sullivan, D.T.J. Big data in manufacturing: A systematic mapping study. *J. Big Data* **2015**, *2*, 20. [[CrossRef](#)]
20. Pacaux-Lemoine, M.P.; Trentesaux, D.; Zambrano Rey, G.; Millot, P. Designing intelligent manufacturing systems through Human-Machine Cooperation principles: A human-centered approach. *Comput. Ind. Eng.* **2017**, *111*, 581–595. [[CrossRef](#)]
21. Paelke, V. Augmented reality in the smart factory: Supporting workers in an industry 4.0. environment. In Proceedings of the Emerging Technology and Factory Automation (ETFA), Barcelona, Spain, 16–19 September 2014.
22. Posada, J.; Toro, C.; Barandiaran, I.; Oyarzun, D.; Stricker, D.; De Amicis, R.; Pinto, E.B.; Eisert, P.; Döllner, J.; Vallarino, L., Jr. Visual Computing as a Key Enabling Technology for Industrie 4.0 and Industrial Internet. *IEEE Comput. Graph. Appl.* **2015**, *35*, 26–40. [[CrossRef](#)] [[PubMed](#)]
23. Shafiq, S.I.; Sanin, C.; Toro, C.; Szczerbicki, E. Virtual engineering object (VEO): Toward experience-based design and manufacturing for industry 4.0. *Cybern. Syst.* **2015**, *46*, 35–50. [[CrossRef](#)]
24. Varghese, A.; Tandur, D. Wireless requirements and challenges in Industry 4.0. In Proceedings of the 2014 International Conference on Contemporary Computing and Informatics (IC3I), Mysore, Karnataka, India, 27–29 November 2014; pp. 634–638.
25. Zhan, Z.H.; Liu, X.F.; Gong, Y.J.; Zhang, J.; Chung, H.S.H.; Li, Y. Cloud computing resource scheduling and a survey of its evolutionary approaches. *ACM Comput. Surv.* **2015**, *47*, 63. [[CrossRef](#)]
26. Agarwal, N.; Brem, A. Strategic business transformation through technology convergence: Implications from General Electric's industrial internet initiative. *Int. J. Technol. Manag.* **2015**, *67*, 196–214. [[CrossRef](#)]
27. Foidl, H.; Felderer, M. Research Challenges of Industry 4.0 for Quality Management. In Proceedings of the Innovations in Enterprise Information Systems Management and Engineering, Munich, Germany, 16–17 November 2015; pp. 121–137.
28. Ivanov, D.; Dolgui, A.; Sokolov, B.; Werner, F.; Ivanova, M. A dynamic model and an algorithm for short-term supply chain scheduling in the smart factory industry 4.0. *Int. J. Prod. Res.* **2016**, *54*, 386–402. [[CrossRef](#)]
29. Kovács, G.; Kot, S. New logistics and production trends as the effect of global economy changes. *Pol. J. Manag. Stud.* **2016**, *14*, 115–126. [[CrossRef](#)]
30. Zawadzki, P.; Zywicki, K. Smart product design and production control for effective mass customization in the industry 4.0 concept. *Manag. Prod. Eng.* **2016**, *7*, 105–112. [[CrossRef](#)]
31. Begum, R.A.; Sohag, K.; Abdullah, S.M.S.; Jaafar, M. CO2 emissions, energy consumption, economic and population growth in Malaysia. *Renew. Sustain. Energy Rev.* **2015**, *41*, 594–601. [[CrossRef](#)]



32. Friedlingstein, P.; Andrew, R.M.; Rogelj, J.; Peters, G.P.; Canadell, J.G.; Knutti, R.; Luderer, G.; Raupach, M.R.; Schaeffer, M.; Van Vuuren, D.P.; et al. Persistent growth of CO<sub>2</sub> emissions and implications for reaching climate targets. *Nat. Geosci.* **2014**, *7*, 709–715. [[CrossRef](#)]
33. Meinshausen, M.; Meinshausen, N.; Hare, W.; Raper, S.C.B.; Frieler, K.; Knutti, R.; Frame, D.J.; Allen, M.R. Greenhouse-gas emission targets for limiting global warming to 2 °C. *Nature* **2009**, *458*, 1158–1162. [[CrossRef](#)] [[PubMed](#)]
34. Bond, T.C.; Doherty, S.J.; Fahey, D.W.; Forster, P.M.; Bernsten, T.; Deangelo, B.J.; Flanner, M.G.; Ghan, S.; Kärcher, B.; Koch, D.; et al. Bounding the role of black carbon in the climate system: A scientific assessment. *J. Geophys. Res. D Atmos.* **2013**, *118*, 5380–5552. [[CrossRef](#)]
35. Bond, T.C.; Streets, D.G.; Yarber, K.F.; Nelson, S.M.; Woo, J.H.; Klimont, Z. A technology-based global inventory of black and organic carbon emissions from combustion. *J. Geophys. Res. D Atmos.* **2004**, *109*. [[CrossRef](#)]
36. Tsai, W.H.; Lee, K.C.; Liu, J.Y.; Lin, H.L.; Chou, Y.W.; Lin, S.J. A mixed activity-based costing decision model for green airline fleet planning under the constraints of the European Union Emissions Trading Scheme. *Energy* **2012**, *39*, 218–226. [[CrossRef](#)]
37. Lee, K.C.; Tsai, W.H.; Yang, C.H.; Lin, Y.Z. An MCDM approach for selecting green aviation fleet program management strategies under multi-resource limitations. *J. Air Transport Manag.* **2018**, *68*, 76–85. [[CrossRef](#)]
38. Tsai, W.H.; Yang, C.H.; Huang, C.T.; Wu, Y.Y. The impact of the carbon tax policy on green building strategy. *J. Environ. Plan. Manag.* **2017**, *60*, 1412–1438. [[CrossRef](#)]
39. Tsai, W.H.; Yang, C.H.; Chang, J.C.; Lee, H.L. An Activity-Based Costing decision model for life cycle assessment in green building projects. *Eur. J. Oper. Res.* **2014**, *238*, 607–619. [[CrossRef](#)]
40. Tsai, W.H.; Lin, S.J.; Liu, J.Y.; Lin, W.R.; Lee, K.C. Incorporating life cycle assessments into building project decision-making: An energy consumption and CO<sub>2</sub> emission perspective. *Energy* **2011**, *36*, 3022–3029. [[CrossRef](#)]
41. Tsai, W.H.; Lin, S.J.; Lee, Y.F.; Chang, Y.C.; Hsu, J.L. Construction method selection for green building projects to improve environmental sustainability by using an MCDM approach. *J. Environ. Plan. Manag.* **2013**, *56*, 1487–1510. [[CrossRef](#)]
42. Tsai, W.H.; Tsaur, T.S.; Chou, Y.W.; Liu, J.Y.; Hsu, J.L.; Hsieh, C.L. Integrating the activity-based costing system and life-cycle assessment into green decision-making. *Int. J. Prod. Res.* **2015**, *53*, 451–465. [[CrossRef](#)]
43. Tsai, W.-H.; Lin, T.W.; Chou, W.-C. Integrating activity-based costing and environmental cost accounting systems: A case study. *Int. J. Bus. Syst. Res.* **2010**, *4*, 186–208. [[CrossRef](#)]
44. Tsai, W.H.; Hung, S.J. Treatment and recycling system optimisation with activity-based costing in WEEE reverse logistics management: An environmental supply chain perspective. *Int. J. Prod. Res.* **2009**, *47*, 5391–5420. [[CrossRef](#)]
45. Tsai, W.H.; Shen, Y.S.; Lee, P.L.; Chen, H.C.; Kuo, L.; Huang, C.C. Integrating information about the cost of carbon through activity-based costing. *J. Clean. Prod.* **2012**, *36*, 102–111. [[CrossRef](#)]
46. Tsai, W.H.; Chang, J.C.; Hsieh, C.L.; Tsaur, T.S.; Wang, C.W. Sustainability concept in decision-making: Carbon tax consideration for joint product mix decision. *Sustainability (Switzerland)* **2016**, *8*, 1232. [[CrossRef](#)]
47. Tsai, W.H.; Chen, H.C.; Leu, J.D.; Chang, Y.C.; Lin, T.W. A product-mix decision model using green manufacturing technologies under activity-based costing. *J. Clean. Prod.* **2013**, *57*, 178–187. [[CrossRef](#)]
48. Kamal Abd Rahman, I.; Omar, N.; Zainal Abidin, Z. The applications of management accounting techniques in Malaysian companies: An industrial survey. *J. Financ. Report. Account.* **2003**, *1*, 1–12. [[CrossRef](#)]
49. Tang, S.; Wang, D.; Ding, F.Y. A new process-based cost estimation and pricing model considering the influences of indirect consumption relationships and quality factors. *Comput. Ind. Eng.* **2012**, *63*, 985–993. [[CrossRef](#)]
50. Zhang, R.; Zhang, L.; Xiao, Y.; Kaku, I. The activity-based aggregate production planning with capacity expansion in manufacturing systems. *Comput. Ind. Eng.* **2012**, *62*, 491–503. [[CrossRef](#)]
51. Verein, I.C. Industrie 4.0. In *Controlling im Zeitalter der intelligenten Vernetzung. Dream Car der Ideenwerkstatt im ICV*; Internationaler Controller Verein eV: Wörthsee, Germany, 2015.
52. Xia, F.; Yang, L.T.; Wang, L.; Vinel, A. Internet of things. *Int. J. Commun. Syst.* **2012**, *25*, 1101–1102. [[CrossRef](#)]
53. Ślusarczyk, B. Industry 4.0: Are we ready? *Pol. J. Manag. Stud.* **2018**, *17*, 232–248. [[CrossRef](#)]
54. Lee, J.; Kao, H.-A.; Yang, S. Service innovation and smart analytics for industry 4.0 and big data environment. *Procedia Cirp* **2014**, *16*, 3–8. [[CrossRef](#)]

55. Yilmaz, T.G.; Tüfekçi, M.; Karpat, F. A study of lightweight door hinges of commercial vehicles using aluminum instead of steel for sustainable transportation. *Sustainability (Switzerland)* **2017**, *9*, 1661. [[CrossRef](#)]
56. Elsayed, A.; Ravindran, C.; Murty, B.S. Effect of aluminum-titanium-boron based grain refiners on AZ91E magnesium alloy grain size and microstructure. *Int. J. Metalcast.* **2011**, *5*, 29–41. [[CrossRef](#)]
57. Sharma, M.K.; Mukhopadhyay, J. Evaluation of Forming Limit Diagram of Aluminum Alloy 6061-T6 at Ambient Temperature. In *Light Metals 2015*; Springer: Berlin, Germany, 2015; pp. 309–314.
58. Stanton, M.; Masters, I.; Bhattacharya, R.; Dargue, I.; Aylmore, R.; Williams, G. Modelling and validation of springback in aluminium U-Profiles. *Int. J. Mater. Form.* **2010**, *3*, 163–166. [[CrossRef](#)]
59. Wang, N.; Yamaguchi, T.; Nishio, K. Interfacial microstructure and strength of aluminum alloys/steel spot welded joints. *Nippon Kinzoku Gakkaishi* **2013**, *77*, 259–267. [[CrossRef](#)]
60. Deschamps, A.; Martin, G.; Dendievel, R.; Van Landeghem, H.P. Lighter structures for transports: The role of innovation in metallurgy. *C. R. Phys.* **2017**, *18*, 445–452. [[CrossRef](#)]
61. Peng, L.; Fu, P.; Wang, Y.; Ding, W. Computer Simulation and Experimental Validation of Low Pressure Sand Casting Process of Magnesium Alloy V6 Engine Block. In Proceedings of the 5th International Conference on Thermal Process Modeling and Computer Simulation, Orlando, FL, USA, 16–18 June 2014; pp. 26–33.
62. Williams, H.P. *Model Building in Mathematical Programming*; John Wiley & Sons: London, UK, 2013.



© 2019 by the authors. Licensee MDPI, Basel, Switzerland. This article is an open access article distributed under the terms and conditions of the Creative Commons Attribution (CC BY) license (<http://creativecommons.org/licenses/by/4.0/>).

Article

# Activity-Based Standard Costing Product-Mix Decision in the Future Digital Era: Green Recycling Steel-Scrap Material for Steel Industry

Wen-Hsien Tsai \*, Shu-Hui Lan and Cheng-Tsu Huang

Department of Business Administration, National Central University, Jhongli, Taoyuan 32001, Taiwan; lanshjoy@gmail.com (S.-H.L.); chengtsu.huang@gmail.com (C.-T.H.)

\* Correspondence: whtsai@mgt.ncu.edu.tw; Tel.: +886-3-426-7247; Fax: +886-3-422-2891

Received: 21 December 2018; Accepted: 5 February 2019; Published: 10 February 2019

**Abstract:** According to the advanced technologies of digitalization and automation, the interconnection with each individual object is created from data acquisitions into data feedback in the integrated platform of the Manufacturing Execution System (MES). MES automatically and immediately links various functional systems. The time of electronic production management is coming soon, and Activity-Based Standard Costing (ABSC) will be used in the new era. On the other hand, there are environmental protection issues; thus, the high-tech method of the Electric Arc Furnace (EAF) uses the complicated recycling material of steel-scrap, which hypothetically enhances product-mix decisions, as based on the ABSC theory, with a mathematical programming approach.

**Keywords:** Activity-Based Standard Costing (ABSC); Manufacturing Execution System (MES); Activity-Based Costing (ABC); Enterprise Resource Planning (ERP)

## 1. Introduction

This study integrates two important issues that have received a lot of attention. One attempts to create the Activity-Based Standard Costing (ABSC) theory for the future Digital Era, which follows the simultaneously automatic technology of Data Acquisition in the Manufacturing Execution System (MES) [1–3]. The other is the environmental protection issue of steel manufacturing [4], as conducted in a steel factory case, which adapts the complicated recycling of steel-scrap material [4,5] and further examines more value-enhancing measures regarding the quantity of the output and profit produced during the production processes of steel products. Furthermore, we design the various operating resource parameters of the steel company-related data, which includes the diversified information of a public steel company report, an interview with a top steel manager, seminars, government agencies, etc., in order to fulfill the ABSC product-mix decision goals of a steel factory case.

Traditionally, the Activity-Based Costing (ABC) development was from Cooper and Kaplan (1988) for creating accurate cost management in the accounting field. ABC has been applied to various industries and used in efficiency improvement, set-up time reduction, performance measurement, product-mix analysis, and budgeting [3,6]. The ABC theory is applied to activity analyses related to factory, company, product, and customer levels [3,7,8] by using the various levels of activities, including unit-, batch-, product-, and facility-level activities [7,8]. The ABC model uses two stages in cost assignment: (1) to assign resource costs to activities using various resource drivers and (2) to assign activity costs to various cost objects (parts, products, channels, districts, etc.) using various resource drivers. [3,6,7]. However, while the ABC method has been used in the Enterprise Resource Planning (ERP) system for a long time, in the Industry 4.0 environment, there is a huge gap regarding how to deal with ABC [9–11]. Some researchers have used the five CPS (Cyber-Physical system) attributes of connection, conversion, cyber, cognition, and configuration to further develop industry

4.0 digital environments [1,12,13]. Additionally, Internet of Things (IoT) technology network smart objects, the internet, and mobile devices [1,9,12] can be automated for real-time data acquisition [1,9,14]. In other words, the data of resource drivers and activity drivers consumed by products during all manufacturing processes can be recorded in real-time using the technologies of sensor-monitoring, the Internet of Things (IoT), CPS, and Manufacturing Execution Systems (MES) under Industry 4.0 [1,9,15]. Therefore, Activity-Based Standard Costing (ABSC) is the future trend in cost accounting under the smart ERP and links the modern MES of Industry 4.0 [10,15]. Practically, the standards of material, labor, and manufacturing overhead data should be installed into the MES database using the advanced technologies of digitalization before starting production [1,16,17]. All resources used in all manufacturing processes should be tracked, and their real-time status data should be displayed in the MES system [1,18]. The above technologies and approaches can integrate all activity data to automatically manage and control production processes in real-time and measure operating performance in all operating departments in a digital manner [1,19,20].

Indeed, the functions of MES, including data acquisition and information systems, make production management computerization possible in the digital age [1,2,9]. An MES can automatically communicate with all subsystems of the enterprise operations management-related applications through a workshop, including resource management, interface management, information management, personnel management, quality management, data acquisition, data processing, and performance analysis [1,10,14]. Certainly, MES can easily integrate all production management subsystems into its system from data acquisition to data collection, calculation, and storage, as well as data analysis and data application [2,16,20]. However, creating a powerful MES platform in a manufacturing factory must consider the different industry production models for various industries, such as continuous or process manufacturing, batch manufacturing, lot-oriented continuous manufacturing, or item-oriented manufacturing [2,3,7]. The data acquisition order in any production line is from resource input, to work-in-process (WIP), to finish goods, and then, the data is tracked, collected, and stored in a timely manner [1,18,20]. Its advantage is the strict control of all the operating processes to execute the standard procedures of each process, which shows real-time reporting, including various management reports and analysis. All data can be stored in the MES system, which can be used to control all operating activities for the incoming order, from production planning, machining process, assembly process, quality process, and logistic process [1,2,9]. Importantly, MES plays an integrating role that links various individual function systems for data collection, combination, and evaluation, which will synchronize to perform related tasks regarding interfacing about orders, materials, machines, tools, and the latest status information of personnel [1,10,15]. Smartly, when the production process cannot be run according to the original plan, all information is automatically pooled and appropriately prepared to facilitate good decisions [1,16,18].

In the digital era of global competition, it is noteworthy that MES and ABSC are indivisible and have become more and more important issues. This paper offers an important future development for the study of the relationship between MES and ABSC. There are two main points of view in this business strategy. First, in the market-based view, smart business models should be optimized to communicate with customers, products, and services [9,18,20]. Second, in the resource-based view, the integration of resources, capabilities, and processes can create smart business strategic decision capabilities. As all future manufacturing resources can automatically connect and share information, factories will become more intelligent and consciously predict and maintain production lines by autonomously controlling and managing the machines [1,9,18]. Furthermore, the Smart Business Model (SBM) will connect its smart products already sold to customers to monitor product components and provide customers with more services [17–19].

Regarding another issue of environmental protection, the Paris Agreement is an agreement within “the United Nations Framework Convention on Climate Change (UNFCCC)”, which is for mitigating gas emissions around the world. The 195 UNFCCC members signed the agreement in August 2017 [21]. How to protect the environment has become a very important global issue. This paper introduces

the literature on steelmaking production by using the complex recycled material of steel-scrap, which largely replaces the global natural resources of iron ore and coal [5,22].

The traditional steelmaking process of a Blast Furnace (BF) has caused serious air pollution and water pollution due to the use of the raw materials of iron ore and coking coal [4,5,22]. The manufacturing process of a BF not only causes severe decay of the natural global resources of iron ore and coke but also causes the huge problems of global environmental pollution and gas emission. Fortunately, the development of the modern green manufacturing technology of the Electric Arc Furnace (EAF) replaces the traditional high polluting manufacturing process of a BF; moreover, the recycled raw material of steel-scrap substitutes the natural raw materials of iron ore and coal [4,5,22]. An impressive 97% of all global steel product waste can be recycled to achieve an 86% recovery rate [5,22]. As EAF manufacturing technology can use any kind of steel-scrap as its material and remanufacture any new steel product, steel-scrap has become the greenest material of the steel industry. The transformation of modern EAF steelmaking technology and traditional raw materials replaces the processes of mining, ore dressing, coking, and ironmaking to save our natural resources and energy; thus, the steelmaking industry will truly become a natural eco-industry [4,5,22].

In this paper, the first major contribution is to propose a concept of ABSC (Activity-Based Standard Costing) integrated into ERP and MES for achieving efficient production management in a digital environment. Smart ABSC analysis and operations will support smart manufacturing, including work forecasting, status monitoring, WIP tracking, throughput tracking, and capacity feedback for all objects because various standard data (including Material Master and Master Data) are installed into the related objects prior to the production process. Smartly, each object can automatically display its information and then share its information with the related requesters in a timely manner through the smart MES platform and the smart subsystem of ERP.

The second major contribution of this study is for environmental protection. The rubbish of steel-scrap has become a raw material for producing steel billets ( $P\#_1$ ) because of EAF technology. Next, the steel billets ( $P\#_1$ ) produce various new steel products, which certainly help to improve environmental protection. Moreover, enhancing the value of recycled steel-scrap and improving its quality can produce more steel billet ( $P\#_1$ ) outputs in its process. On the other hand, reusing iron ore and coking coal can significantly reduce mining.

The remainder of this paper is as follows: Section 2 presents the research background including (1) the evolution of cost management from the traditional ABC to the innovative ABSC, (2) how to integrate functional subsystems into an MES system for immediate and automatic data acquisition in the system, and (3) a description of the green steelmaking industry. Section 3 creates the ABSC concept by combining the basic theory of ABC and the standards for the resources and activities of MES. Further, it defines ABSC and describes how to automatically calculate the costs of various cost objects by using the two stages of ABC, where related data can be immediately used for various managerial tasks and decisions, and finally, can build “a powerful MES integrating system”. Section 4 describes an ABSC mixed decision model by using mathematical programming for the steelmaking manufacturing industry. Section 5 discusses an illustrative case study. Finally, a numerical example is provided to illustrate how to use the model to obtain an optimal solution using LINGO software. In Section 6, a scenario analysis of four cases is used to demonstrate the profit analysis [7,8,23] to achieve the maximum profit for steelmaking production. Finally, the summary and conclusions are presented in Section 7.

## 2. Research Background

The era of global high-tech digital is coming. MES systems can automatically and immediately integrate a large amount of software from specific internal functions to external suppliers and customers [2,10,18]. A Smart Network and unified interface technologies create a powerful MES integration system, which automatically connects various independent subsystems via networking technology and exchanges data in real-time via interfaces [1,9,18]. Moreover, as it can support

simple input devices, conduct accurate plausibility checks for erroneous inputs, and has convenient information use [1,19,20], MES can provide a reliable and available system for production management [2,9]. However, the readiness of the ABSC model is necessary for the future digital era.

In this steelmaking case, the development of EAF steelmaking technology and the creation of demand for recycled steel-scrap materials will effectively improve climate change [4,5,22]. This steel company wants to focus on accurately evaluating its relevant production costs, including the costs of the raw steel-scrap material, operating costs, and environmental costs, in order to develop their core competencies.

### 2.1. The Evolution from the Traditional ABC to the Innovative ABSC

The traditional ABC was developed around 1988 and has been widely used by most enterprises until now. The accurate cost accounting ability of the ABC model was highly recognized during the mass production of Industry 2.0 and the automated production era of Industry 3.0 [7–9]. However, the 4th industrial revolution, which began in Germany in 2011 [13–15], has the aim of reducing manpower, shortening product lifecycle between design and production, and making efficient use of all resources [10,12]. Industry 4.0 develops towards smart factories, smart products, and smart services in the Internet of Things (IoT) environment [13,16,17]. In this paper, the innovative ABSC model, which is based on the traditional ABC theory, will be used in the future industry 4.0. The following presents the technological gaps between ABC and ABSC as well as three key points for the innovative ABSC in the future Industry 4.0 environment.

- CPS: All smart objects can be intelligently connected together and can continuously interchange data in a timely manner [1,24].
- IoT: The IoT is a ubiquitous virtual infrastructure, also called industrial internet [25,26].
- Sensor technology: Smart objects are embedded with various different sensors and can be perceived, observed, and understood through computers without the need to enter data [10,16,27].

On the other hand, the ABC model has been used in the ERP system for a long time. Assuming that the ABSC model will be used in the ERP system, we must consider the issue of system integration. For example: (1) Smart data are embedded in the ERP system and can share all smart data to related smart objects before production [10,15]. The system-to-system issue, ERP, and MES system-related data issues are from data acquisition to data feedback [15,24,27].

Finally, the ABC model has been adopted by many industries to improve efficiency [3,6]. From the point of view of business strategy and planning, the ABC/ABSC product-mix decision model can be solved by using the LINGO software to obtain the optimal decision solution to maximize profit, which is helpful to enterprises [7,8,23]. In the future Industry 4.0, Big Data and cloud computing can be used to make real-time decisions [14,28,29]. In this subsection, we recommend that the ABC/ABSC product-mix decision model can be used to determine the optimal solutions regarding business strategy and enterprise budget [23,28,29] in the Industry 4.0 era. On the other hand, we recommend that the reference LINGO software system be part of the specification for Big Data policy systems.

To sum up, this subsection describes the evolution of cost management from the traditional ABC model to the innovative ABSC model, including the technological developments and the application of ABSC in Industry 4.0, as shown in Table 1. Figure 1 shows a smart ABSC operational roadmap from strategy to planning and execution in the future industry 4.0 Environment.

### 2.2. Integrating Functional Subsystems into an MES

Obviously, a large number of traditionally independent software (such as ERP) can only provide a one-way supply of the related data; however, MES plays a dialogue platform and integrates all independent systems [2,15]. Smartly, various resources are applied to different systems individually, which execute during the production process to manufacture the products [15,20,30]. Many independent systems are applied and integrated by MES systems [2,9], meaning MES systems

can integrate a variety of various independent function systems, and this subsection will introduce some of the functional systems. First, in the production area, MES integrates a Programmable Logic Controller (PLC) system [2,25], which is a digital control system that prevents operational errors and automatically collects all relevant manufacturing information [1,2,18]. The Statistical Process Control (SPC) system is a quality management system [1,10] which features rapid reaction to production-line abnormalities and effective dispatch of expert personnel to repair and immediately eliminate mechanical or personnel processing anomalies. In addition, the Shop Floor Control (SFC) system can carry out quantity control and transfer on the production line [1,2,10]. Second, in the warehouse area, MES integrates the Warehouse Management System (WMS) for accurate inventory management [2,15,30]. Third, in the inventory area, MES can be vertically integrated into the Supply Chain Management (SCM) system [2,10,14] with its suppliers to achieve “Just in time” (JIT) [7] management to reduce inventory. Fourth, in the data area, currently, Enterprise Resource Planning (ERP) provides complete information about a company or group; however, the actual details of manufacturing processes are difficult to provide [2,15]. Therefore, a wide variety of individual hardware and software have been developed, and all hardware are distributed in one factory in order to generate their data in a timely and automated manner, which is due to CPS and the IoT technologies [31–34]. MES can immediately receive data from all individual systems and send real-time data to those in demand.

**Table 1.** Innovative Activity-Based Standard Costing (ABSC) and applications.

Traditional Activity-Based Costing (ABC)	Technological Development	Innovative ABSC
<b>Resources</b>	<ol style="list-style-type: none"> <li><b>Technology environment:</b> Cyber-Physical system (CPS) and Internet of Things (IoT)</li> <li><b>Software and hardware:</b> Integrated Manufacturing Execution System (MES) and various independent systems (system-to-system)</li> </ol>	<b>Smart resources:</b> <ol style="list-style-type: none"> <li>Resource standards: Smart Data</li> <li>Smart resource objects: Advance Robots, Automatic Machines . . .</li> </ol>
<b>Activities</b>	<ol style="list-style-type: none"> <li><b>Data acquisition infrastructure</b> (ID reader, Scales interface)</li> </ol>	<b>Smart Activities:</b> Smart resource into operation
<b>Products (Cost Objects)</b>	<ol style="list-style-type: none"> <li><b>Connection of the automation level</b> (Scale, Bar code, RFID)</li> </ol>	<b>Smart Products:</b>
<b>Using system:</b> Enterprise Resource Planning (ERP) ERP data, including all standard costs	<ol style="list-style-type: none"> <li><b>Smart Data:</b> Standards of Material Master and Standards of Master Data</li> <li><b>Applications:</b> Automated and real-time data acquisition → data feedback Machine-to-Machine (become conscious and intelligent)</li> </ol>	<ol style="list-style-type: none"> <li><b>Using system:</b> Smart ERP Smart ERP-data, including: smart data and their standard unit-price</li> <li><b>A powerful platform:</b> MES system</li> <li><b>Smart Data applications/data feedback</b></li> </ol>
<b>ABC/ABSC Application:</b> product-mix decision model <b>Method:</b> various constraints and mathematical programming <b>Using strategic system:</b> Decision Support System <b>Results:</b> an optimal decision solution for maximizing profit ABSC application in the Big Data of Industry 4.0: <b>Recommendations:</b> <ol style="list-style-type: none"> <li>Strategy: ABSC Product-mix decision support model as part of Big Data strategy</li> <li>Reference LINGO software system as part of a Big Data strategy system specification</li> <li>Plan: the optimal decision solution as budget target</li> </ol>		



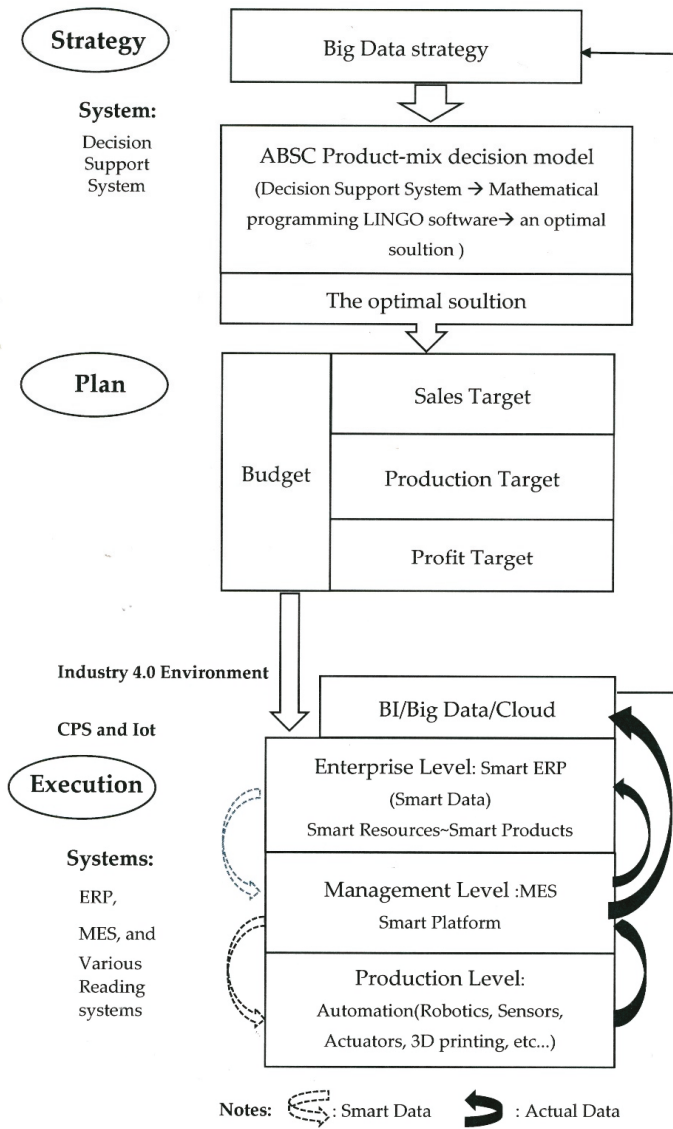

Figure 1. Smart ABSC operational roadmap.

Indeedly, the MES system can solve ERP-related problems and easily collect massive amounts of data during the production process. Finally, in the data application area, the Business Intelligence (BI) system [2,10,15] can be horizontally integrate through an internal database in an ERP system, and all department managers can easily obtain their analysis information if they are authorized access to such related information [2,15,30]. It is entirely conceivable that MES can become the backbone of production management; MES integrates a large number of digital products and systems to improve information processing capabilities, which allows it to become a powerful production management system for achieving the goal of intelligent manufacturing [35–37].



### 2.3. Automatic Data Acquisition in Real-Time in an MES System

Data acquisition is automatically collected via a variety of reading systems, including counters, scales, balances, and comparable devices [34,37,38]. For example: (1) the technology of an ergonomic touch screen is for conducting data acquisition [2,10,12,13]; (2) staff members log their work time using PDA (production data acquisition) [13,28,39], and a cell phone is convenient for conducting immediate mobile data acquisition [2]; (3) RFID (radio frequency identification) [2,18,38] can conduct remote data acquisition [2,9] in the harshest production environments; (4) counter pulse operating signals can automatically and immediately collect the yield data [2]; lastly, (5) using barcodes or batch labels that can be scanned at their storage location is to collect data in real-time [2,13,15]. In other words, MES can collect all kinds of data (such as the characteristic curves of quality data, labor time data, wage data, and material data), and all data of the operational processes are stored in the MES database [2].

Remarkably, production process mapping [2] is embedded into the smart MES, which will connect with all the data collection systems via a uniform interface, and all devices will automatically collect messages and perform all data acquisition activities from the start to the final workstation [1,2,9]. Thus, all information will be supplied to managers, customers, and suppliers in a timely manner [9,34,37].

### 2.4. Background of Steel-Scrap for Green Steelmaking Manufacturing

The use of modern EAF technology instead of the traditional BF technology and adopting the raw material of steel-scrap to reduce the natural energy excavation of iron ore and coal will save 35% of the oil manufacturing costs [22]. Furthermore, the modern production processes of EAF can significantly reduce 75% of carbon emissions [22], as compared to the traditional BF, in order to promote and maintain a healthy global environment.

In the future, the EAF production model will gradually replace the traditional BF manufacturing method in the global steelmaking industry, as steel-scrap raw materials will replace iron ores in large quantities. Every city has a large number of discarded old steel products, which are the source of steel-scrap, including motorcycles, automobiles, rails, furniture, appliances, building demolition, etc. [5]. Steel-scrap will become a secondary mineral due to the large number of recycled old steel products, rendering the steelmaking industry a recycling eco-industry [22]. Through the two concepts of automatic data acquisition and green steelmaking manufacturing, it provides an important development for the ABSC literature in steelmaking manufacturing.

## 3. ABSC in ERP Applications and Linking MES

The ABC model uses a two-stage procedure to calculate product costs: resource drivers and activity drivers. Resource costs are traced to activities using resource drivers, and then, activity costs are traced to cost objects using activity drivers as shown in Figure 2. In the first stage, various resource drivers are used to assign resource costs to the related activities. In the second stage, the activity costs are assigned to the products using the activity drivers. Each activity center usually consists of related activities through a clustering process [27,30,39]. Additionally, all elements of each activity cost pool come from different resource costs and can be traced to their related activity center [23,28,29].

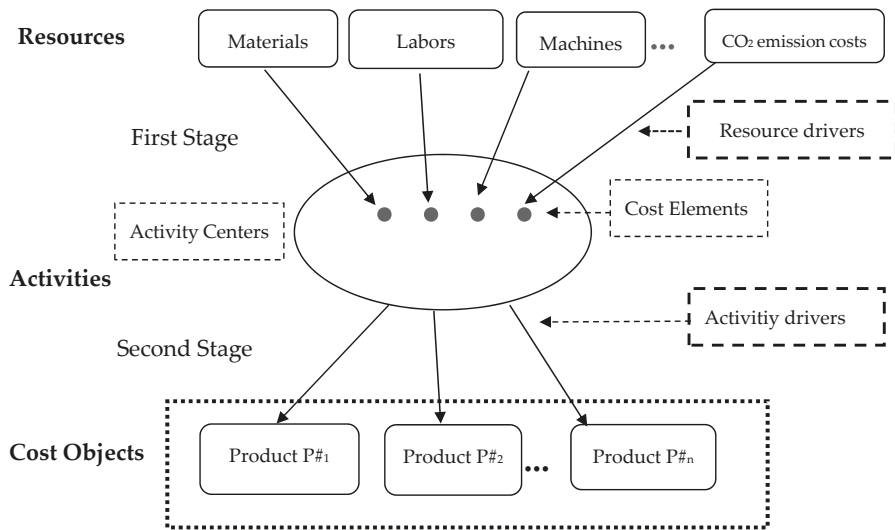

Figure 2. The detailed ABC model.

It is assumed that ABSC (Activity-Based Standard Costing) is embedded in the ERP link with MES, which creates the data storage and information exchange and updates each other every 15 minutes [2,10,31]. From the business practice point-of-view, all industry-relevant objects, such as raw materials, products, machines, customers, and supply chain, can connect with each other for exchanging information and controlling actions independently or autonomously [2,9,15]. Various resources and activities in the ABSC are embedded in an intelligent ERP [10,15], which is also a subsystem of MES. MES is a powerful platform that automatically connects to all independent systems and immediately delivers accurate costs for each product due to its smart integrated data stream including data acquisition, data collection, data storage, data calculation, and data analysis [12,20,27]. Thus, MES's data application can be applied to customers, channels, or markets in a timely manner to fulfill computerized production management [11,24] in the future digital era.

From the management accounting point-of-view, while the traditional ERP system seems to provide all the information of a company or group, the actual data of the manufacturing process can hardly provide all detailed records in real time, such as working hours; utilization of machines; or equipment, material loss, WIP quantity control, etc. [10,15]; therefore, real-time data acquisition will overcome the above problems [15,24,35]. The following describes the standards for the resources and activities in a digital factory.

### 3.1. Resource Standards

Input manufacturing resources include raw materials, machines, tools, laborers, etc. The costs of all resources must be properly assigned to the related operating process using the standards of the Material Master and Master Data lists [9,27,37]. A Material Master list, such as the bill of materials information, includes drawings and required quantities [2,15,24]. Another Master Data list is for the work plan, including work instructions, work centers for planned production, set-up time, running time, and standard speed installed to each related machine; all of which are the standards for all production process mapping [2,15,20]. For example, the above various resource standards are installed in the related advanced robots or automatic machines, and they are embedded with a variety of sensors to collect all the data from production operations in a timely manner. The process of collecting data is called the data layer for comprehensive perception [10].

Additionally, different functional workers, including material controllers, production schedulers, production labors, and logisticians, use the online MES information platform to integrate various independent functional systems [2,15,39] to make preproduction plans. Furthermore, data acquisition from all the input resources are via various reading systems [2,13,27], which automatically receives the information into the data acquisition station [2,19] while simultaneously transferring the information into the MES database [2]. After that, the MES database will feed the data back to all the related independent systems [2,15,18]. Data feedback is the data layer of reliable transmission.

According to the above explanation, the various data acquisitions and data processes will follow three steps. First, set the various standards of the Material Master and Master Data, which are embedded in the advanced robots or automatic machines [2,11,27]. Second, the data layer of comprehensive perception by various sensors and multi-sensor systems automatically acquires data in a timely manner during the operational process [2,15,38]. Lastly, the data layer of reliable transmission collects feedback data and transfers them to the related systems in real-time [2,10–13,15,16,18,34,35]. According to the above data acquisitions, they will automatically collect various Big Data and thus can achieve the submission goals of a smart factory [1,9,24].

### *3.2. Activity Standards in the Future Production Process*

A powerful MES system automatically connects with various functional systems to successfully conduct production management [1,2]. The following introduces the different operational activities.

#### *3.2.1. The Simulation of Production Strategies*

Smart design management can use 3-D printing to make a perfect design prototype before starting production [1,2]. Then, the smart software system will be used to simulate the manufacturing process beforehand [2,24]. MES will make the best plan for production management [2,31,37] by considering how to arrange all the types of intelligent automatic machines within the factory and how to conduct good production operations. For example, it can calculate the consumption of various resources in each production process, such as people, space, energy, materials, equipment, etc [2,19], which can help significantly reduce the operating time. An advanced planning and scheduling (APS) system [2] can be used to make detailed manufacturing plans, including listing all the allocated resources and integrating them into this modern MES system. From the manufacturing process point-of-view, a production line using the MES system can be broken down into the individual machines in each production process to collect the data, including the quantity of raw materials, machine time, tool time, manpower time, etc. [1,2,19]. On the other hand, the quality data achieved from the production processes using the visual mode can achieve the goals of quality management [2].

#### *3.2.2. Tools*

The technology of Augmented Reality (AR) [13] has made great breakthroughs in production management. For example, for job training, workpeople can wear smart glasses to scan their working sites by creating a smart virtual screen that simulates the working conditions. In other words, Standard Operating Procedures (SOP) can be visualized in a timely manner by using the AR's technology in production process simulations [13]. In this way, we can reduce the cost of training and avoid the loss of production.

#### *3.2.3. Information Technology for Horizontal and Vertical Integration*

The MES system creates an important internal and external integrated system by connecting various independent horizontal and vertical systems, meaning it can effectively enhance all functions and support all related requests to achieve efficient digital factories [2,26,27].

Horizontal integration means that a company can integrate all of its internal functions and systems, such as engineering, production, and sales service. All data from all departments are automatically entered into their individual system, and the data can be shared with other related departments (each

15 minutes) by the powerful MES platform [1,2,15]. For example, the data layer of reliable transmission through the MES platform can integrate the data from all departments into the ERP system every 15 minutes [2,9,15]. On the other hand, vertical integration is a thinking of an industry chain; it means that a smart company can develop a cooperative information platform for their suppliers and customers to facilitate their timely exchange of related information [26,34,35]. For example, if the machines are broken down, the suppliers can use the platform's data to know when they should support the machines.

### 3.2.4. Machine-to-Machine Communication

The most significant change in the new manufacturing environment is that all auto-machines can send their information to each other in a factory or different factories [10,27]. From a supply chain point of view, the information of all machines is connected together through MES, and the MES data can be linked to a cloud system [18,26,34]. In other words, each industry chain data will be connected together, and they can know each other. For example, if our suppliers are out of stock, we can know it through cloud system and MES and make a good decision to resolve our inventory problem. Furthermore, the technologies of cloud and IoT [18,26,34] can also store data for each industry chain and can collect marketing information to make real-time decisions using Big Data and cloud computing [1,18,32].

### 3.3. ABSC Application in a Digital Manufacturing

ABC is widely used in a variety of industries to manage and control businesses [3,23,28], and ABSC can be used to timely analyze the functional costs of its departments [26], such as production, sales, human resource, research and development, information systems, procurement, project management, product design, performance measurement, efficiency improvement, product-mix analysis, set-up time reduction, quality cost measurement, environmental quality management, budgeting, etc. [7,28,29].

In digital factories, all components can indeed be controlled at any time in a powerful MES system: Smart design, smart development, smart manufacturing, and smart selling in a perfect industrial chain system that uses a reliable information technology of horizontal and vertical integration [18,26,35]. All components have autonomous perception, independent forecasts, and self-configuration capabilities to make standard productions or service practices for achieving perfect human-machine interaction [1,2,27]. These technologies will rapidly improve productivity. On the other hand, setting the various standards of the Material Master and Master Data in all smart systems will easily fulfill a variety of standard costs at the unit, batch, product, and facility levels to achieve the needs of factories, businesses, products, and customers in a timely manner [1,2,18].

In the digital era, a smart infrastructure of data acquisition terminal equipment includes scale interfaces, data interface bus systems [2,24,33], counter pulses operating signal, process values, accompanying document labels and ID reader in the environment of a Cyber-Physical System (CPS), and the Internet of Things (IoT) technologies [1,9,37]. The first automatic data are from the data layer of comprehensive perception, which creates the automatic huge-data from data acquisition and data collection to data storage [2,10]. Then, these huge-data become a useful information media that can share various information to related individual systems or devices, including machine-to-system, system-to-system, or machine-to-machine [1,2,27], which we call the second data layer of reliable transmission. The huge-data can be stored in cloud systems for the needs of customers or suppliers [1,34,35]. The cloud systems [26] can also automatically calculate their huge-data and become a variety of smart information for different requesters, which we call the third data layer of intelligent processing.

Specifically, MES plays a backbone role, integrating all the independent horizontal and vertical systems [2,15,26]. Importantly, data acquisitions and data processes automatically collect large amounts of data during the production process from input resources and activities to finished products [2,15,24].

Figure 3 displays the relationship between ABSC and digital factories through smart MES and ERP. Huge-data are entered into the MES data station through a variety of sensors, and then, the data feedback are entered into the ERP database [1,2,18].

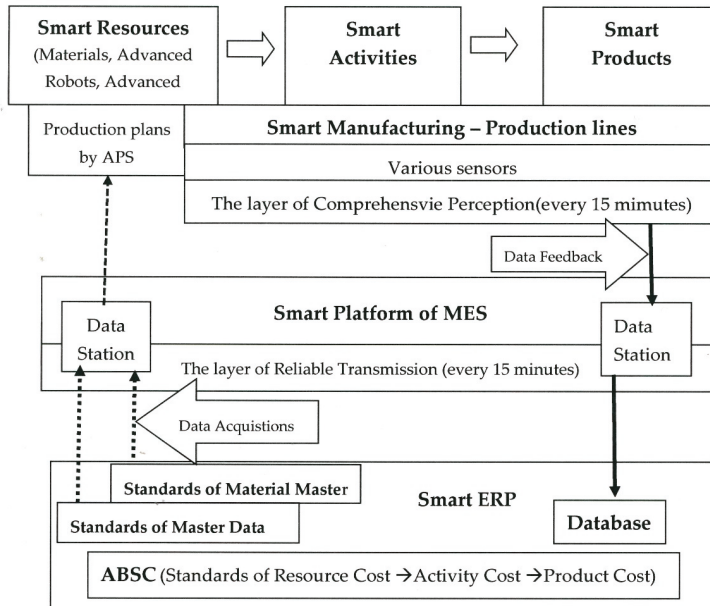

Figure 3. Achievement of ABSC goals through Smart MES and ERP systems.

### 3.4. ABSC Definition and Various Cost Calculation

Cooper and Kaplan (1988) adapted ABC for improving the cost of products in an automated manufacturing environment; however, that is not enough for the individual objects required in the digital age. In an MES system, all resource smart objects [18,24,27] are installed with the related standards of the Material Master and Master Data [2,10] before those objects enter the production process, which we call Activity-Based Standard Costing (ABSC). Those operation-related detailed huge-data are collected by various sensors, and massive amounts of data will automatically be created during the production process, which will facilitate the implementation of ABSC in ERP and MES systems [1,2,15].

According to the previous discussion, ABSC can be embedded in a Smart ERP system and connected to the MES system in a digital factory [10,15,24]. The ABSC approach for a steel company can be successfully implemented by following four steps (see Figure 2):

- Step 1. Calculating Resource Costs: The various resources used in a factory may include direct materials, direct laborers, machine hours, and other resources [3,6,28]. Resource costs are calculated using the quantity standards of the Material Master and Master Data [2] in the production process, as well as the standard of each resource unit price [7,8,28]. All detailed quantity data throughout the whole operation process can automatically be summed up for each resource element and then be tracked to its processes. As a result, resource costs can be calculated immediately in a smart ERP system.
- Step 2. Tracing Resource Costs to Activities: According to the various automatic data acquisitions in the data processes, some direct resource costs can automatically be traced to specific activities if

a resource is consumed only by the specific activity [15,18,27]. Otherwise, the resource cost should be assigned to activities that consume the resource by an appropriate resource driver [2,10,27].

- Step 3. Standardized Activity Costs: An activity may be related to more than one process; thus, its indirect costs will be distributed to the related processes in the MES system [2,15,23]: For example, inspecting incoming material, moving materials, and indirect labor costs; maintaining and repairing machines; and other costs that are beneficial to all the manufacturing processes [15]. In other words, standardized activity costs can be traced to their related activities and processes [2,10,15], and the cost of each activity can be automatically calculated by adding the costs of the resource elements assigned to the activity [7,10,15]. In the new manufacturing era, mass customization is the key focus of manufacturing processes. Traditional standard costing should be changed to setting the detailed standards for elementary cost elements [2,15,18]. Thus, we will have the standard cost rate for each activity executed in the production system. The standard cost of a specific product unit will be calculated by adding the products with standard activity cost rates and standard activity driver quantities consumed by this specific product unit [15,23,28].
- Step 4. Tracing Activity Costs to Products: The product cost for a specific product unit can be automatically calculated by summing up the resource and activity costs traced to a specific product unit [15,23,28].

### 3.5. ABSC in ERP and linking MES in A Smart Factory

To sum up Section 3, the resource standards use the standards of the Material Master and Master Data [2,15,27], which are installed in the related smart objects prior to production. After that, all smart objects will automatically operate their operational activities and acquire their data in a real-time manner [2,10,15]. Regarding the software, this powerful MES system not only integrates all automatic and real-time data from all reading systems into the MES database [2,12,24] but also shares the relevant requirement data through the platform [2,12,24]. Additionally, the MES system automatically connects the internal and external independent systems for horizontal and vertical integration to achieve the goals of smart factories [2,10,24].

From a cost accounting point-of-view, one should understand a smart factory, including how to connect the ERP and MES; the following steps can be followed. Firstly, the structure of a smart factory has four levels, Production Operation, Production Management, Business Operation, and Commerce, with multiple control systems: MES system, ERP system, and BI system. Secondly, Sections 2 and 3 provide many different MES information, including operation processes, functions, and software, to design a powerful MES integrated system for a smart factory. Finally, in particular, the SAP-ERP system mainly includes the following seven modules in order to display ABSC in the CO module: SD (Sales and Distribution), PP (Production Planning), MM (Materials Management), QM (Quality Management), HCM (Human Capital Management), CO (Controlling), and FI (Financial Accounting) [40]. Figure 4 shows a smart factory can use the MES integrated systems in the future Industry 4.0 era.

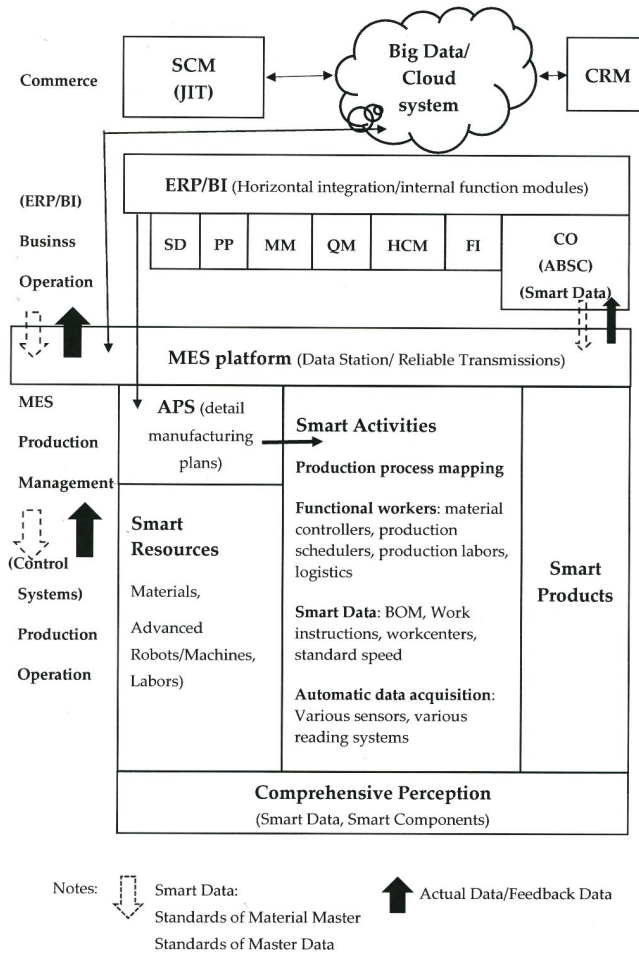

Figure 4. A powerful MES integrated system.

#### 4. Formulation of an ABSC Product-Mix Decision Model for a Steel Factory

Jadicke (1961) applied the Product-Mix model in management accounting to determine the optimal product-mix [23,29] that maximizes total profit under various constraints (e.g., sales, production, and cost elements) in a multiproduct company. Additionally, ABC uses various mathematical programming approaches and conducts a product-mix decision analysis [23,29]. The ABSC theory will be applied in new manufacturing.

##### 4.1. Process Descriptions and Cost Categories for the ABSC Mixed Decision Model for a Steel Factory

Bottom line results (e.g., the income statement in the accounting field) are from sales and various costs to profit, which can be used to evaluate the competitiveness of a company [23,29], and such results are absolutely related to the performance of each functional department. All cost information must be shown, in order for business operators to make good assessments and accurate judgments. This study classifies six cost categories as follows:



1. Material cost: The purchase of steel-scrap raw materials should be based on the needs of EAF to clean, cut, and fracture for finishing all kinds of different sizes. The available steel-scrap will be poured into the hopper of EAF according to size in order for the EAF to be fully loaded and then will start the production of P#<sub>1</sub> products.
2. Labor cost: Including personnel normal and overtime costs;
3. Electrical power cost: Including the high electrical bills for EAF, etc.;
4. CO<sub>2</sub> emission cost: Environmental and social costs in the form of a carbon tax for environmental protection;
5. Machine cost: Machines and equipment are fixed costs in each process;
6. Other indirect costs (overhead): With the exception of the above 1–5 costs in this subsection, other indirect costs per product are calculated as a percentage of the total amount sold for each product.

The flowchart in Figure 5 describes the processes in steel manufacturing. This study includes two main stages. On the one hand, we focus on incorporating the above costs (e.g., Material cost, Labor cost, Electrical power cost, CO<sub>2</sub> emission cost, Machine cost, and other indirect costs) through a mathematical programming approach and obtain the optimal decision using the LINGO software. On the other hand, we hypothesize and enhance the value of steel-scrap raw materials for P#<sub>1</sub> products in the process of steelmaking to achieve maximum profit. The flowchart of the steel factory is shown in Figure 5.

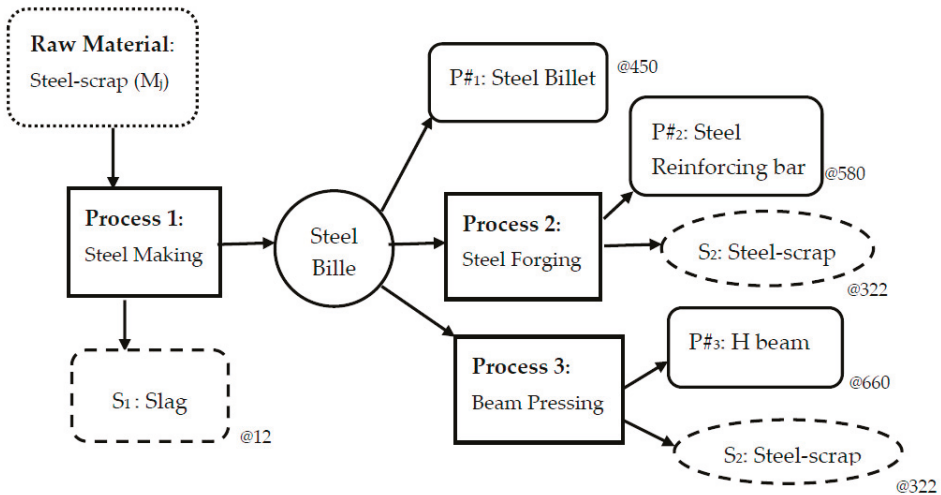

Figure 5. The production process of the steel factory of the case company.

#### 4.2. Assumptions

Assuming that the ABSC product-mix decision in a steel factory considers all operating costs in this paper, there are several assumptions. The following assumptions will be incorporated into a mathematical programming model:

1. The revenue includes steel products and slag byproducts;
2. The direct raw material cost of steel-scrap with different purity levels and recycled materials for byproducts are assumed;
3. Direct labor is related to the time of the production machine;
4. The model complies with government policies, including direct labor overtime and tax cost for carbon dioxide emission;



5. The direct costs include direct materials, machines, CO<sub>2</sub> emission, labor, and electrical power costs;
6. The machine cost of each process is fixed, regardless of any special overtime;
7. The variable costs of other indirect costs are based on the total sales percentage for each product.

#### 4.3. Notations

The variables and parameters used in this paper are defined as follows:

$\Omega$	The total profit;
$P\#_i$	The notation of products;
$P_i$	The sales unit price of Product $i$ ;
$Q_i$	The sales quantity of the products ( $P\#_i$ );
$US_i$	The sales upper quantity limit constraint of Product $i$ ;
$LS_i$	The sales lower quantity limit constraints of Product $i$ ;
$S_1, S_2$	The notations for the byproducts for both slag ( $S_1$ ) and steel-scrap ( $S_2$ );
$Q_p$	The selling quantity of the byproduct;
$K_1$	The unit sales price of the byproduct;
$B$	The amount of input per batch of steel-scrap in the steelmaking process;
$X_j$	The number of batches of steel-scrap of the $j$ th level purity in a period;
$M_j$	The purchase of steel-scrap of the $j$ th level steel purity;
$Mc_j$	The unit purchase cost of the $j$ th level steel-scrap;
$M_{2r}$	The output of the steel-scrap byproduct ( $S_2$ ) in a period
$Mc_{2r}$	The unit cost of the steel-scrap byproduct ( $S_2$ );
$R_j, R_j'$	The output of each batch of $P\#_1$ using the steel-scrap of the $j$ th steel purity level; $R_j'$ is the output by enhancing the steel purity of steel-scrap for more value;
$T_i$	The output of the $i$ th product after the steelmaking process;
$H, H_1, H_2$	The total labor hours ( $H$ ) including the normal hours ( $H_1$ ) and overtime hours ( $H_2$ );
$h_1, h_2, h_3$	The direct labor hours for each batch ( $h_1$ ) in the steelmaking process and other processes for direct labor hours are per mt = 1000 kg ( $h_2$ and $h_3$ ), including in the steel forging process and beam pressing process;
$Lc, Lc_1, Lc_2$	The total direct labor costs ( $Lc$ ) including the normal ( $Lc_1$ ) and overtime ( $Lc_2$ ) direct labor costs;
$\eta_1, \eta_2$	( $\eta_1, \eta_2$ ) is an SOS1 (special ordered set of type 1) set of 0–1 variables within which exactly one variable must be nonzero (Williams 1985);
$\mu_0, \mu_1, \mu_2$	( $\mu_0, \mu_1, \mu_2$ ) is an SOS2 (special ordered set of type 2) set of non-negative variables within which at most two adjacent variables, in the order given to the set, can be nonzero (Williams 1985);
$\theta_1$	The wage rate for normal direct labor hours;
$\theta_2$	The wage rate for overtime direct labor hours;
$nh$	The working hours per working day;
$nd$	The working days within a period;
$eeq_b$	The total CO <sub>2</sub> emission cost;
$eeq_b$	The total quantities of CO <sub>2</sub> emission;
$\gamma_1, \gamma_2, \gamma_3$	An SOS1 (special ordered set of type 1) set of 0–1 variables within which exactly one variable must be nonzero (Williams 1985);
$\psi_0, \psi_1, \psi_2, \psi_3$	An SOS2 (special ordered set of type 2) set of non-negative variables within which at most two adjacent variables, in the order given to the set, can be nonzero (Williams 1985);
$c_r$	The carbon footprint calculated from production batches, which generate the quantity of $c_r$ mts carbon footprint emissions;
$r_b$	The carbon tax rates including a free ( $r_1$ ) tax rate and USD2 ( $r_2$ ) and USD9( $r_3$ ) carbon tax rates per mt;
$Fh_1, Fh_2, Fh_3$	The machine hours for each process;
$Dc_i$	The total direct electricity power cost including batch level in process 1 and unit level in Processes 2 and 3;

Du	The unit cost of 1 KW of electricity power;
Dn <sub>1</sub> , Dn <sub>2</sub> , Dn <sub>3</sub>	The electrical power consumed by processes 1, 2, and 3 are Dn <sub>1</sub> , Dn <sub>2</sub> , and Dn <sub>3</sub> , respectively;
F <sub>i</sub>	All machine costs in each process are fixed;
Oc <sub>i</sub> and pr <sub>i</sub>	Other indirect cost (Oc <sub>i</sub> ) for product i; allocating its cost based on the percentage of revenue of product i (pr <sub>i</sub> ).

4.4. Mathematical Programming Model

According to Section 4.1, assume that there are six cost categories in the case steel factory, including material cost, labor cost, electrical power cost, CO<sub>2</sub> emission cost, machine cost, and other indirect costs. The following discusses the combination of related cost elements and the mathematical programming model; then, we can use a LINGO software to obtain the results for determining an optimal decision. In addition, we conduct a scenario profit analysis by gradually increasing the purchase cost of steel-scrap, where steel purity is from the lowest, to middle, to highest level in order to enhance the yield of P#<sub>1</sub> and maximize profit.

4.4.1. The Model

The objective is to maximize total profit, Ω:

$$\begin{aligned}
 \text{Maximize } \Omega = & \quad (A) \text{ Sales amount (A1. Steel products + A2. Slag byproduct)} \\
 & \quad (B) \text{ Direct material cost (B1. Steel-scrap – B2. Recycling the byproduct of steel-scrap)} \\
 & \quad (C) \text{ Direct labor cost (C1. Normal cost + C2. Overtime cost)} \\
 & \quad (D) \text{ Direct electrical power cost} \\
 & \quad (E) \text{ Direct machine cost} \\
 & \quad (F) \text{ CO}_2 \text{ emission (Environmental and social cost)} \\
 & \quad (G) \text{ Other indirect cost} \\
 \\
 = & \{ \sum_{i=1}^3 P_i Q_i + K_1 * [\sum_{j=1}^3 X_j (B - R_j)] \} - \{ (B * \sum_{j=1}^3 X_j * M_{c_j}) - [(\sum_{i=1}^3 Q_i / T_i) * (1 - T_i)] * \\
 & M_{c_{2r}} \} - (L_{c1} * \mu_1 + L_{c2} * \mu_2) - \{ Du * [Dn_1 * (\sum_{j=1}^3 X_j) + (Dn_2 * Q_2) + (Dn_3 * Q_3)] \} - \\
 & \sum_{i=1}^3 F_i - (e_{ec1} * \psi_1 + e_{ec2} * \psi_2 + e_{ec3} * \psi_3) - \sum_{i=1}^3 Oc_i
 \end{aligned} \tag{1}$$

which is subject to

A. Product sales upper limit constraints

$$Q_i \leq US_i \tag{2}$$

Product sales lower limit constraints

$$Q_i \geq LS_i \tag{3}$$

B1. Direct material quantity constraints

$$B * \sum_{j=1}^3 X_j * R_j = \sum_{i=1}^3 (Q_i / T_i) \tag{4}$$

C. Direct labor hour constraints

$$H = H_1 \mu_1 + H_2 \mu_2, \tag{5}$$

$$(\sum_{j=1}^3 X_j) * h_1 + (Q_2 / T_2) * h_2 + (Q_3 / T_3) * h_3 = H_1 \mu_1 + H_2 \mu_2, \tag{6}$$

$$\mu_0 - \eta_1 \leq 0, \tag{7}$$

$$\mu_1 - \eta_1 - \eta_2 \leq 0, \tag{8}$$

$$\mu_2 - \eta_2 \leq 0, \tag{9}$$

$$\mu_0 + \mu_1 + \mu_2 = 1, \quad 0 \leq \mu_0, \mu_1, \mu_2 \leq 1 \quad (10)$$

$$\eta_1 + \eta_2 = 1, \quad \eta_1, \eta_2 = 0, 1, \quad (11)$$

#### E. Machine hour constraints

$$Fh_1 \leq nh * nd; \quad Fh_2 \geq Q_2 * h_2; \quad Fh_3 \geq Q_3 * h_3, \quad (12)$$

#### F. CO<sub>2</sub> emission constraints

$$(B * \sum_{j=1}^3 X_j) * cr = eeq_1 * \psi_1 + eeq_2 * \psi_2 + eeq_3 * \psi_3, \quad (13)$$

$$eeq_b = eeq_1 * \psi_1 + eeq_2 * \psi_2 + eeq_3 * \psi_3 \quad (14)$$

$$\psi_0 - \gamma_1 \leq 0, \quad (15)$$

$$\psi_1 - \gamma_1 - \gamma_2 \leq 0, \quad (16)$$

$$\psi_2 - \gamma_2 - \gamma_3 \leq 0 \quad (17)$$

$$\psi_3 - \gamma_3 \leq 0, \quad (18)$$

$$\psi_0 + \psi_1 + \psi_2 + \psi_3 = 1, \quad 0 \leq \psi_0, \psi_1, \psi_2, \psi_3 \leq 1, \quad (19)$$

$$\gamma_1 + \gamma_2 + \gamma_3 = 1, \quad \gamma_1, \gamma_2, \gamma_3 = 0, 1 \quad (20)$$

#### 4.4.2. Sales Amount

According to Figure 5, the sales amount comes from the following products: steel billets (P#<sub>1</sub>), steel reinforcing bars (P#<sub>2</sub>), and H beams (P#<sub>3</sub>), which are produced in the different processes. In the production of steel billets (P#<sub>1</sub>), slag byproduct (S<sub>1</sub>) can be produced and sold. In this paper, the weight of the input batch of raw material in process 1 must be equaled to 100 mts (B) regardless of the steel purity (M<sub>j</sub>) of every batch because of the capacity of the furnace. On the other hand, the total number of batches in a period is X<sub>j</sub>, which includes different j levels that will affect the number of output P#<sub>1</sub> (R<sub>j</sub>) and byproduct S<sub>1</sub> (B - R<sub>j</sub>) per batch. Assume also that Q<sub>i</sub> is the selling quantity of product P#<sub>i</sub>. The quantity of byproduct [X<sub>j</sub>(B - R<sub>j</sub>)] is the difference in the quantity between the input quantity of the steel-scrap and the output of the steel billet (P#<sub>1</sub>). In this case, the steel-scrap has j kinds of steel purity levels and j equals 3. Therefore, the total sales amount in Equation (1), i.e.,  $\sum_{i=1}^3 P_i Q_i$  and  $K_1 * [X_j(B - R_j)]$  represent the total sales amount of products and byproducts, respectively. Furthermore, the products may have sales upper limit constraints (Q<sub>i</sub> ≤ US<sub>i</sub>) due to market demand limits, as shown in Equation (2); the products may also have lower sales limit constraints (Q<sub>i</sub> ≥ LS<sub>i</sub>), as shown in Equation (3), due to considering the economics of scale or satisfying the original customers' needs.

#### 4.4.3. Direct Material Cost

The second term in Equation (1), i.e.,  $\{[B * (\sum_{j=1}^3 X_j * Mc_j)] - [(\sum_{i=1}^3 Q_i / T_i) * (1 - T_i)] * Mc_{2r}\}$ , stands for the total direct material cost by purchasing steel-scrap and saving the material cost due to recycling steel-scrap byproducts. Firstly, Equation (4), i.e.,  $(B * \sum_{j=1}^3 X_j * R_j) = (\sum_{i=1}^3 Q_i / T_i)$ , is the quantity of material associated with different steel purity levels in the steel-scrap that is equal to the total sales quantity of products 1–3 (P#<sub>1</sub>, P#<sub>2</sub>, and P#<sub>3</sub>). In this subsection, B, X<sub>j</sub>, and R<sub>j</sub>, as described in the above Section 4.4.2. Sales Amount), and Mc<sub>j</sub> are the unit costs of steel-scrap at the j<sup>th</sup> purity level; thus, the total cost of the direct material for the purchase of steel-scrap is  $(B * \sum_{j=1}^3 X_j * Mc_j)$ . Secondly, the byproduct of recycled steel-scrap is from Process 2 and Process 3. The Q<sub>i</sub> was also introduced in the above Section 4.4.2. Sales Amount), and T<sub>i</sub> is the output of P#<sub>i</sub> in the production process. Additionally, Mc<sub>2r</sub> is the byproduct of steel-scrap (S<sub>2</sub>) recycled from Processes 2 and 3, and the unit cost of S<sub>2</sub> is fixed;

thus,  $[\sum_{i=1}^3 Q_i / T_i * (1 - T_i) * Mc_{2r}]$  is the cost of the direct material for the byproduct of steel-scrap ( $S_2$ ). To sum up, the direct material cost is the second term in Equation (1), i.e.,  $\{B * \sum_{j=1}^3 X_j * Mc_j\} - [(\sum_{i=1}^3 Q_i / T_i) * (1 - T_i)] * Mc_{2r}$

4.4.4. Direct Labor Cost

Figure 6 shows a piecewise linear cost function, which represents that labor hours can be expanded to overtime; thus, the labor cost rate will also increase. In the normal working hour range, the highest labor hour and cost are  $H_1$  and  $L_{c1}$ , respectively. In the overtime labor hour range, the highest overtime labor hour and cost are  $L_{c2}$  and  $H_2$ , respectively. However, the total labor hour (normal + overtime) is represented in Equation (5):  $H = H_1\mu_1 + H_2\mu_2$ . On the other hand, the associated total direct labor cost is shown in the third term in Equation (1), i.e.,  $L_{c1}\mu_1 + L_{c2}\mu_2$ .

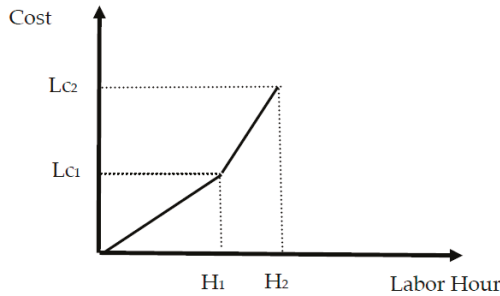

Figure 6. A piecewise linear function for direct labor.

For direct labor hours, the associated constraints are shown in Equations (5)–(11). Particularly, the direct labor hours in each process (Processes 1–3 as in Figure 5) are shown in Equation (6), which is also equal to Equation (5).

$(\eta_1, \eta_2)$  in Equation (11) is an SOS1 set of 0–1 variables, where only one variable will be one.  $\eta_1$  and  $\eta_2$  are indicator variables; if  $\eta_1 = 1$ , it means that the data point will fall within the first segment of Figure 6, and if  $\eta_2 = 1$ , it means that the data point will fall within the second segment of Figure 6. On the other hand,  $(\mu_0, \mu_1, \mu_2)$  in Equation (10) is an SOS2 set of non-negative variables, within which at the most two adjacent, in the order given to the set, can be nonzero (Williams 1985). In Equations (7)–(11), if  $\eta_1 = 1$ , then  $\eta_2 = 0$  from Equation (11),  $\mu_2 = 0$  from Equation (9),  $\mu_0, \mu_1 \leq 1$  from Equations (7) and (8), and  $\mu_0 + \mu_1 = 1$  from Equation (10). It means that the data point will be the linear combination of points (0, 0) and  $(H_1, L_{c1})$ ; the labor hours used and the associated labor costs will be  $H_1\mu_1$  and  $L_{c1}\mu_1$ , respectively. Similarly, if  $\eta_2 = 1$ , then  $\eta_1 = 0$  from Equation (11),  $\mu_0 = 0$  from Equation (8),  $\mu_1, \mu_2 \leq 1$  from Equations (8) and (9), and  $\mu_1 + \mu_2 = 1$  from Equation (10). Thus, the data point will be the linear combination of points  $(H_1, L_{c1})$  and  $(H_2, L_{c2})$ ; the labor hours used and the associated labor costs will be  $(H_1\mu_1 + H_2\mu_2)$  and  $(L_{c1}\mu_1 + L_{c2}\mu_2)$  as shown in Equation (5) and the third term of Equation (1), respectively.

4.4.5. Direct Electricity Power Cost

In this subsection, the direct electricity power cost ( $Dc_i$ ) is divided into two parts, one by batch in process 1 and another by the unit of mt in Processes 2 and 3. The fourth term in Equation (1), i.e.,  $\{Du * [Dn_1 * (\sum_{j=1}^3 X_j)]\}$ , and  $\{Du * [(Dn_2 * Q_2) + (Dn_3 * Q_3)]\}$  represent the total direct electricity power cost of this case.  $Du$  is the unit cost of electricity power.  $Dn_1$  is the quantity of electricity power used for each batch in process 1, and  $Dn_2$  and  $Dn_3$  are the quantities of electricity power used in Processes 2 and 3 per mt.

4.4.6. Machine Costs

The total cost of the machines in each process is fixed, regardless of whether the machines are used during non-normal working hours. The fifth term in Equation (1), i.e.,  $\sum_{i=1}^3 F_i$  represents the total cost of machines in all processes (Processes 1–3 as shown in Figure 3).

4.4.7. CO<sub>2</sub> Emission Costs

In the literature of recent years, carbon tax cost has received considerable attention in various industries such as the construction industry [3,41], the electrical and electronic industry [42], the pharmaceutical industry [43], the tire industry [44–46], the textile industry [47], the knitted footwear industry [48,49], the paper industry [50], the aluminum-alloy wheel industry [51], and so on. The sixth term in Equation (1),  $eec_1*\psi_1 + eec_2*\psi_2 + eec_3*\psi_3$ , represents the total CO<sub>2</sub> emission cost (i.e., carbon tax cost). The steelmaking process, studied in this paper, has successfully operated the manufacturing technology of EAF and adopts the recycling material of steel-scrap to produce the P#<sub>1</sub> steel billets. The factory disclosed the carbon footprint information for each product to identify and implement the philosophies of the energy-conserving design and low-carbon emissions [22], which have the purpose of proactively and actively promoting CO<sub>2</sub> emissions reduction. According to the concept of the Corporate Social Responsibility (CSR) of a public company and its carbon footprint as a strong tool, the quantity of CO<sub>2</sub> emission from the steelmaking process is determined and estimated [22,23]. The manufacturing technology of EAF supports lower CO<sub>2</sub> emission quantities and a tax policy.

Regarding the quantities of CO<sub>2</sub> emissions, the associated constraints are expressed in Equations (13)–(20). In Equation (13), the total amount of CO<sub>2</sub> emissions is divided into three segments with different constraint quantities, as shown in Equation (14), as well as different tax rates. It is a piecewise linear cost function for the carbon tax cost function, as shown in Figure 6.

( $\gamma_1, \gamma_2, \gamma_3$ ) in Equation (20) is an SOS1 set of 0–1 variables, where only one variable will be one.  $\gamma_1, \gamma_2$ , and  $\gamma_3$  are indicator variables; if  $\gamma_1 = 1$ , it means that the data point will fall within the first segment of Figure 6; similarly, if  $\gamma_2 = 1$  or  $\gamma_3 = 1$ , it means that the data point will fall within the second or third segment of Figure 6. On the other hand, ( $\psi_0, \psi_1, \psi_2, \psi_3$ ) in Equation (19) is an SOS2 set of non-negative variables, within which at most two adjacent, in the order given to the set, can be non-zero (Williams 1985).

If  $\gamma_1 = 1$ , then  $\gamma_2 = \gamma_3 = 0$  from Equation (20),  $\psi_2 = \psi_3 = 0$  from Equations (17) and (18),  $\psi_0 \leq 1$  and  $\psi_1 \leq 1$  from Equations (15) and (16), and  $\psi_0 + \psi_1 = 1$  from Equation (19). It means that the data point will fall within the first segment of Figure 7. Then, the total quantity of CO<sub>2</sub> emission is  $eeq_b \leq eeq_1$ , and the carbon tax cost is 0, since  $eec_1*\psi_1 + eec_2*\psi_2 + eec_3*\psi_3 = 0*\psi_1 + eec_2*0 + eec_3*0 = 0$ . This means that the data point ( $eeq_1\psi_1, 0$ ) in the first segment of Figure 7 is the linear combination of (0, 0) and ( $eeq_1, 0$ ).

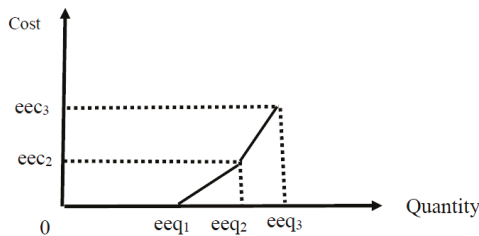

Figure 7. CO<sub>2</sub> emission costs.

If  $\gamma_2 = 1$ , then  $\gamma_1 = \gamma_3 = 0$  from Equation (20),  $\psi_0 = \psi_3 = 0$  from Equations (15) and (18),  $\psi_1 \leq 1$  and  $\psi_2 \leq 1$  from Equations (16) and (17), and  $\psi_1 + \psi_2 = 1$  from Equation (19). It means that the data point will fall within the second segment of Figure 7. Then, the total quantity of CO<sub>2</sub> emissions is  $eeq_b = eeq_1*\psi_1 + eeq_2*\psi_2$  from Equation (14), and the carbon tax cost is  $eec_1*\psi_1 + eec_2*\psi_2 + eec_3*\psi_3 =$

$0*\psi_1 + eec_2*\psi_2 + eec_3*0 = eec_2*\psi_2$  from Equation (1). This means that the data point ( $eeq_1\psi_1 + eeq_2\psi_2$ ,  $eec_2\psi_2$ ) in the second segment of Figure 7 is the linear combination of ( $eeq_1, 0$ ) and ( $eeq_2, eec_2$ ).

If  $\gamma_3 = 1$ , then  $\gamma_1 = \gamma_2 = 0$  from Equation (20),  $\psi_0 = \psi_1 = 0$  from Equations (15) and (16),  $\psi_2 \leq 1$  and  $\psi_3 \leq 1$  from Equations (17) and (18), and  $\psi_2 + \psi_3 = 1$  from Equation (19). It means that the data point will fall within the third segment of Figure 7. Then, the total quantity of CO<sub>2</sub> emissions is  $eeq_b = eeq_2*\psi_2 + eeq_3*\psi_3$  from Equation (14), and the carbon tax cost is  $eec_1*\psi_1 + eec_2*\psi_2 + eec_3*\psi_3 = 0*0 + eec_2*\psi_2 + eec_3*\psi_3 = eec_2*\psi_2 + eec_3*\psi_3$  from Equation (1). This means that the data point ( $eeq_2*\psi_2 + eeq_3*\psi_3$ ,  $eec_2*\psi_2 + eec_3*\psi_3$ ) in the third segment of Figure 7 is the linear combinations of ( $eeq_2, eec_2$ ) and ( $eeq_3, eec_3$ ). In brief, if the company emits more CO<sub>2</sub>, then the company will pay the higher carbon tax rate.

#### 4.4.8. Other Indirect Cost

The seventh term in Equation (1), i.e.,  $\sum_{i=1}^3 Oc_i$ , represents the total amount of other indirect costs which are allocated by the percentage of revenue of product i ( $pr_i$ ).

### 5. Illustrative Case Study and Discussion

This section presents a numerical example and illustrates the application of the model proposed in this paper. The illustrative example data are shown in Table 2. The case company is considering producing products 1, 2, and 3 ( $P_{\#i}$  including  $P_{\#1}$ ,  $P_{\#2}$ , and  $P_{\#3}$ ). We assume that they need three main activities, including one batch-level in Process 1 for  $P_{\#1}$  and two unit-levels in Processes 2 and 3 for  $P_{\#2}$  and  $P_{\#3}$ . In process 1, we can choose the purity level of  $M_j$  steel for steel-scrap, and  $M_j$  includes  $M_1$ ,  $M_2$ , and  $M_3$ . The following example displays the revenue and various costs.

Table 2. Example data (Case 1).

Description	Material ( $M_j$ ) for $P_{\#1}$			Products ( $P_{\#}/S_1$ )		
<b>Sales</b>				$P_{\#1}/S_1$	$P_{\#2}$	$P_{\#3}$
Demand ( $Q_i$ )/mts				$2000 \leq Q_1 \leq 4000$	$Q_2 \geq 3500$	$Q_3 \geq 3500$
Products price ( $P_i$ )/USD				\$450	\$580	\$660
Byproduct price ( $K_1$ )/USD				\$12		
<b>Direct Material</b>	$M_1$	$M_2$	$M_3$			
Unit price ( $M_{c_i}$ )/mt/USD	\$300	\$317	\$330			
Total batches ( $X_i$ )/100mts	$X_1 \leq 65$	$X_2 \leq 65$	$X_3 \leq 65$			
Output $P_{\#i}(R_i)$ /1 batch (B)	$R_1 = 88$	$R_2 = 91$	$R_3 = 94$			
Output $S_1(B-R_1)$ /1 batch (B)	12	9	6			
$P_{\#1}$ for selling Products ( $T_i$ )/mt				1	0.96	0.98
Transfer $P_{\#i}(Q_i/T_i)$ / mts to others process				$Q_1/T_1$	$Q_2/T_2$	$Q_3/T_3$
Recycling the $S_2$ byproduct ( $Q_i/T_i - Q_i$ )/ mts				$(Q_2/T_2)-Q_2$		$(Q_3/T_3)-Q_3$
Unit $S_2$ byproduct cost ( $M_{c_2}$ )/mt/USD					\$322	\$322
<b>Direct Labor</b>						
Cost/USD				$L_{c_1} = \$66,000; L_{c_2} = \$105,600$		
Labor hours				$H_1 = 10,000; H_2 = 14,000$		
Wage rate/USD				$\theta_1 = \$6.6; \theta_2 = 9.9$		
<b>Electrical power</b>						
Each batch level 0.75 hours/KW				45		
Unit level hours/mt					0.1	0.1
1 KW ( $D_u$ ) cost/USD				85	85	85
<b>Machine</b>						
Machine hours ( $F_{h_i}$ )				$F_{h_1} \leq 176$	$F_{h_2} = Q_2$	$F_{h_3} = Q_3$
Machine cost ( $F_i$ )/USD				$F_1 = \$100,000$	$F_2 = \$50,000$	$F_3 = \$150,000$
<b>CO<sub>2</sub> Emission</b>						
Carbon cost ( $eec_b$ )	$eec_1 = \$0; eec_2 = \$2000; eec_3 = \$29,000$					
Carbon Q'ty( $eeq_b$ )	$eeq_1 = 3000; eeq_2 = 4000; eeq_3 = 7000$					
Carbon rate (cr)/batch	$cr = 40$					
Unit carbon ( $r_b$ )/USD	$r_1 = \$0; r_2 = \$2; r_3 = \$9;$					
<b>Other indirect costs</b>						
$Oc_i$				$3\%*Q_1*P_1$	$5\%*Q_2*P_2$	$5\%*Q_3*P_3$

### 5.1. Sales Amount

The first part is the revenue, including the three kinds of products of steel billets ( $P\#_1$ ), steel reinforcing bars ( $P\#_2$ ), and H beams ( $P\#_3$ ), which have the unit prices ( $P_i$ ) of USD450 ( $P_1$ ), USD580 ( $P_2$ ), and USD660 ( $P_3$ ), respectively. The second part is the revenue of the byproduct slag ( $S_1$ ), and the unit price is USD12 ( $K_1$ ). Additionally, in Process 1, the quantity of input raw material per batch of steel-scrap is limited to 100 (B) mts and the same steel purity level ( $M_j$ ) for every batch, and each  $j^{\text{th}}$  level of steel-scrap does not exceed the number of 65 ( $X_j$ ) batches in a period, which is due to the capacity of the furnace. The output quantity of  $P\#_1$  in each batch depends on the different steel purity levels ( $M_j$ ) of the steel-scrap, and their output of  $R_j$  includes 88 ( $R_1$ ), 91 ( $R_2$ ), and 94 ( $R_3$ ) per batch. On the other hand, only the amount of byproduct [ $X_j * (B - R_j)$ ] in process 1 in a period is the difference between the input quantity of steel-scrap raw material ( $X_j * B$ ) and the output  $P\#_1$  ( $X_j * R_j$ ). To sum up, the total revenue is expressed, as shown in Equation (1), as  $\{\sum_{i=1}^3 P_i Q_i + K_1 * [\sum_{j=1}^3 X_j * (B - R_j)]\}$ . We also consider the quantity of sales constraints for each product in the operational policy; product  $P\#_1$  can only sell the quantity of  $Q_1$  between 2000 ( $LS_1$ ) and 4000 ( $US_1$ ) due to market constraints and customers' needs, while the quantities of other products,  $Q_2$  and  $Q_3$ , should be more than 3500 ( $LS_2$  and  $LS_3$ ) mts.

### 5.2. Direct Material

The direct material of steel-scrap is purchased from the steel recycling industry or obtained from the steel-scrap byproducts from Processes 2 and 3. The following introduces the sources of steel-scrap in two ways, external procurement and an internal production byproduct.

#### 5.2.1. Purchasing the Recycling Materials of Steel-Scrap and Producing Products

EAF adopts the recycling material of steel-scrap to produce the  $P\#_1$  product. The purchase of steel-scrap not only conforms to the capacity of EAF but also considers the process of pouring steel-scrap of different dimensions into the EAF. The scrap-steel of different dimensions may include light, heavy, or small, and the various steel-scrap are poured into an EAF through its hopper and pipe to efficiently batch-produce product  $P\#_1$ .

Surprisingly, steel-scrap is recycled from garbage or completely irregular shapes of scrapped equipment. For example, the garbage of steel-scrap is usually supplied from household goods, including furniture, cans, utensils, etc. Another kind of steel-scrap comes from various waste equipment, such as automobile, ships, tools, machines, buildings, and other scrapped equipment. All raw steel-scrap are mixed with lots of soil, cement, sticky sand, clay, rubber, paint, etc. However, the usable steel-scrap for the EAF must be clean, cut, and crushed through different machines in a steel recycling industry. In addition, steel firms have to request that suppliers in the steel recycling industry classify their steel-scrap recycling materials as light, heavy, or small dimensions to meet the pouring process of their EAF.

In this case, the steel-scrap of different steel purity ( $M_j$ ) can be used as raw material to produce steel products. The following numerals assume that the purchase of steel-scrap focuses only on steel purity and will affect the yield of steel billets ( $P\#_1$ ) and slag byproducts ( $S_1$ ) in the steelmaking process. Green steelmaking manufacturing must conduct a good analysis of procurement, have production policies, and make decisions to maximize profit through a LINGO software.

1. Assume that producing  $P\#_1$  can use three kinds of direct materials—steel-scrap  $M_j$  ( $M_1$ ,  $M_2$ , and  $M_3$ ). The input material of product  $P\#_2$  in Process 2 and  $P\#_3$  in Process 3 come only from the  $P\#_1$  (semi-manufactured goods called  $P\#_1$ ). We also assume that the plant needs three main activities to produce these three products ( $P\#_1$ ,  $P\#_2$ , and  $P\#_3$ ), as shown in Figure 5 in Section 4.1.
2. In process 1, inputting the steel-scrap of  $M_j$  into the EAF is for the production of  $P\#_1$  and  $S_1$ .  $P\#_1$ , which not only can be sold but also can produce other products ( $P\#_2$  and  $P\#_3$ ). For other products, meaning the semi-manufactured goods,  $P\#_1$  must be transferred to other processes; one into

Process 2 for producing  $P\#_2$ , another into Process 3 for producing  $P\#_3$ . Additionally, byproduct  $S_2$  will be produced in two Processes, namely, 2 and 3. The byproduct  $S_2$  will become a recycled material of steel-scrap, just as the  $M_{2r}$ , and assume that the unit cost of  $M_{c2r}$  is equal to USD322 each mt.

- For the production of  $P\#_1$ , the purchase of three kinds of steel-scrap recycled materials  $M_j$  ( $M_1$ ,  $M_2$ , and  $M_3$ ) are divided into 3 steel purity levels of the  $M_1$  lowest,  $M_2$  middle, and  $M_3$  highest levels, and the unit costs are USD300 ( $M_{c1}$ ), USD317 ( $M_{c2}$ ), and USD330 ( $M_{c3}$ ), respectively. However, different levels of steel purity per batch ( $B = 100$ ) will affect the yield of  $P\#_1$  and  $S_1$  in Process 1, which range from 88, 91, to 94 mts and from 12, 9, to 6 mts, respectively.

### 5.3. Direct Labor

In a period, in Process 1, we assume that 14 workers work only normal times, including 8 hours each day and 22 working days. Each batch needs direct labor for  $h_1$  hours (17.5 hours), including 14 workers and 1.25 hours of working together.

According to a report by the AISI (American Iron & Steel Institute), the labor productivity per mt of finished steel is from 10.1 hours in the early 1980s to 1.9 hours in 2015 [20]. In future smart manufacturing, the labor productivity per mt of finished steel will improve to one hour ( $h_2$  or  $h_3$ ) in Processes 2 and 3.

In terms of normal direct labor hours,  $H_1$  is 10,000 labor hours with a wage rate of USD6.6 ( $\theta_1$ ) per hour and expands the number of labor hours to  $H_2 = 14,000$  with an overtime wage rate of USD9.9 ( $\theta_2$ ) per hour. Thus, the total labor hours and cost are  $H = H_1\mu_1 + H_2\mu_2$  and  $L_c = L_{c1}\mu_1 + L_{c2}\mu_2$ . This indicates that the completion of this case will require overtime labor.

### 5.4. Electrical Power Cost

According to a report by Taiwan's Ministry of Economic Affairs (MOEA), the electrical power per mt of finished steel is about 0.55 KW. In this case, assume that the use of electrical power includes the batch level in Process 1 and the unit level in Processes 2 and 3 to calculate them. In Process 1, the raw material of steel-scrap in an EAF can contain 100 mts ( $B$ ) per batch and an electricity consumption and time of approximately 45 KW ( $Dn_1$ ) and 0.75 hours. In Processes 2 and 3, one metric ton (mt) of finished steel product for  $P\#_2$  or  $P\#_3$  takes an hour and about 0.1 KW ( $Dn_2$  or  $Dn_3$ ). The electrical power cost of 1 KW is USD85 ( $Du$ ). As shown in Equation (1),  $Du * Dn_1 * (\sum_{j=1}^3 X_j)$  and  $Du * [(Dn_2 * Q_2) + (Dn_3 * Q_3)]$  represent the total direct electricity power costs at the batch level in Process 1 and two unit-levels in Processes 2 and 3, respectively, as soon as possible.

### 5.5. Machine Hours and Cost

This steel manufacturing produces three different products  $P\#_1$ ,  $P\#_2$ , and  $P\#_3$  by using different machines in different Processes, 1, 2, and 3, respectively. Firstly, in Process 1 for one batch, the normal working time of the operating machine is 1.25 hours, including 0.5 hours of setting up time and 0.75 hours of production time. Normally, the working days are 8 (nh) hours each day and 22 (nd) working days in a period, as shown in Equation (12),  $Fh_1 \leq 176 (8 * 22)$ . The total direct machine cost will be fixed at  $F_1 = \text{USD}100,000$  for a period.

In this case, product  $P\#_1$  can be sold to customers or transferred to Processes 2 and 3 as semi-manufactured goods and be used to produce products  $P\#_2$  or  $P\#_3$ . Both Processes 2 and 3 have 10 separate production lines that can produce different products independently. We assume that each unit of products  $P\#_2$  or  $P\#_3$  takes one hour of working process, but their machine costs in each process are fixed to  $F_2 = \text{USD}50,000$  and  $F_3 = \text{USD}150,000$ , respectively, for a period. According to the previous Section 5.1., the  $Q_2$  and  $Q_3$  have to sell more than 3500 mts individually each period; thus,  $Fh_2$  and  $Fh_3$  also separately require more than 3500 hours in Processes 2 and 3 in a period.

The terms from Equation (12)  $Fh_2 \geq 3500$  and  $Fh_3 \geq 3500$  are the constraints associated with the machine hours and are equal to the direct labor hours in Processes 2 and 3. The terms in the fifth set of



parentheses in Equation (1), i.e.,  $\sum_{i=1}^3 F_i = F_1 + F_2 + F_3 = 100,000 + 50,000 + 150,000 = 300,000$ , represent the total direct machine cost.

### 5.6. CO<sub>2</sub> Emission Quantity and Cost

In a period, the carbon footprint will be calculated based on the production batches in Process 1 and the quantity of 40 (cr) mts carbon footprint emissions each batch will make. Assume that the carbon tax rate is free ( $r_1 = 0$ ) when the total carbon emission quantity is less than 3000 mts (eeq<sub>1</sub>); the carbon tax rate is  $r_2$  (USD2/ each mt) when the carbon emission quantity is between 3000 (eeq<sub>1</sub>) and 4000 (eeq<sub>2</sub>) mts; and the carbon tax rate is  $r_3$  (USD9 /each mt) when the carbon emission quantity is between 4000 (eeq<sub>2</sub>) and 7000 (eeq<sub>3</sub>) mts. Thus, the total carbon footprint emission quantity and the carbon tax costs are  $eeq_b = eeq_1 \cdot \gamma_1 + eeq_2 \cdot \gamma_2 + eeq_3 \cdot \gamma_3 = 3000\gamma_1 + 4000\gamma_2 + 7000\gamma_3$  and  $eec_b = eec_1 \cdot \gamma_1 + eec_2 \cdot \gamma_2 + eec_3 \cdot \gamma_3 = 2000\gamma_2 + 29,000\gamma_3$ , respectively. The constraints associated with the carbon tax cost are shown in Equations (13)–(20).

### 5.7. Other Indirect Costs

The various direct costs in this case are described above. However, the total operating costs also include various indirect costs, such as indirect material cost, indirect labor cost, commission fee, etc. Assume that the other indirect costs are estimated by using the percentage of a product's revenue (pr<sub>i</sub>), i.e., 3%, 5%, and 5% for products P#<sub>1</sub>, P#<sub>2</sub>, and P#<sub>3</sub>, respectively. The seventh term in Equation (1), i.e.,  $\sum_{i=1}^3 Oc_i = \sum_{i=1}^3 P_i Q_i \cdot pr_i = Q_1 \cdot P_1 \cdot 3\% + Q_2 \cdot P_2 \cdot 5\% + Q_3 \cdot P_3 \cdot 5\%$ , represents the total other indirect costs.

### 5.8. The Optimal Solution

According to the model, Equations (1)–(20) and the descriptions of Sections 5.1–5.7, the mathematical programming model for the illustrative example data, as shown in Table 2 (called Case 1 in this paper), is presented in Table 3. The model of Case 1 is solved by the LINGO software, and its optimal solution is presented at the bottom of Table 3. The optimal product-mix in the sales quantity of the products (P#<sub>i</sub>) are  $(Q_1, Q_2, Q_3) = (2002, 3504, 7105)$ , and the optimal batch numbers of three kinds of steel-scrap recycled materials M<sub>j</sub> (including: M<sub>1</sub> lowest, M<sub>2</sub> middle, and M<sub>3</sub> highest levels) are  $(X_1, X_2, X_3) = (11, 64, 65)$ . In addition, the company needs to use overtime direct labor hours (since  $\eta_2 = 1$ ), and the carbon tax cost falls within the second taxable range of the carbon emission quantity (since  $\gamma_3 = 1$ ).

In addition, the detailed information under the optimal solution is shown in Table 4. For example, from the sales point-of-view, the optimal product-mix for the sales quantity of three products (including  $Q_1, Q_2, Q_3) = (2002, 3504, 7105)$  is subject to the following constraints:  $2000 \leq Q_1 \leq 4000$ ,  $Q_2 \geq 3500$ , and  $Q_3 \geq 3500$ . Under this optimal solution, the quantity of the byproduct will be  $Q_p = \sum_{j=1}^3 X_j (B - R_j) = X_1(B - R_1) + X_2(B - R_2) + X_3(B - R_3) = 11 \cdot (100 - 88) + 64 \cdot (100 - 91) + 65 \cdot (100 - 94) = 1098$ , since  $X_1 = 11$ ,  $X_2 = 64$  and  $X_3 = 65$ ,  $B = 100$ ,  $R_1 = 88$ ,  $R_2 = 91$ , and  $R_3 = 94$ . Additionally, the optimal input quantity of P#<sub>1</sub> for selling P#<sub>1</sub> and producing P#<sub>2,3</sub> is  $Q_1/T_1$  to obtain  $Q_1 = 2002$ ,  $Q_2 = 3650$ , and  $Q_3 = 7250$ , as shown in Table 4.

**Table 3.** The mathematical programming model and optimal solution (Case1).

---

$$\text{MAX } \Omega = \{(450*Q_1 + 580*Q_2 + 660*Q_3) + 12 [X_1*(100 - 88) + X_2*(100 - 91) + X_3*(100 - 94)]\} -$$

$$\{[100*(X_1*300 + X_2*317 + X_3*330)] - [(Q_2/0.96*(1 - 0.96) + (Q_3/0.98*(1 - 0.98))*322] - (66,000*\mu_1 + 105,600*\mu_2) - (85*45*(X_1 + X_2 + X_3) + 85*0.1*Q_2 + 85*0.1*Q_3) - 300000 - (0*\gamma_1 + 2000*\gamma_2 + 29,000*\gamma_3) - (450*Q_1*0.03 + 580*Q_2*0.05 + 660*Q_3*0.05)\}$$

**Subject to sales**

$Q_1 \geq 2000$   
 $Q_1 \leq 4000$

**Subject to direct material**

$X_1 * 88 + X_2 * 91 + X_3 * 94 - Q_1 - Q_2/0.96 - Q_3/0.98 = 0$   
 $X_1 \leq 65$   
 $X_2 \leq 65$   
 $X_3 \leq 65$

**Subject to machine hours**

$(X_1 + X_2 + X_3) * (0.5 + 0.75) \leq 176$   
 $Q_2 \geq 3500$   
 $Q_3 \geq 3500$

**Subject to direct labor**

$(X_1 + X_2 + X_3) * 17.5 + Q_2 * 1 + Q_3 * 1 \leq 10,000 * \mu_1 + 14,000 * \mu_2$   
 $(X_1 + X_2 + X_3) * 17.5 \leq 14 * 8 * 22;$   
 $\mu_0 - \eta_1 \leq 0;$   
 $\mu_1 - \eta_1 - \eta_2 \leq 0;$   
 $\mu_2 - \eta_2 \leq 0;$   
 $\mu_0 + \mu_1 + \mu_2 = 1;$   
 $\eta_1 + \eta_2 = 1;$

**Subject to CO<sub>2</sub> Emission**

$(X_1 + X_2 + X_3) * 100 * 0.4 = 3000 * \gamma_1 + 4000 * \gamma_2 + 7000 * \gamma_3$   
 $\psi_0 - \gamma_1 \leq 0,$   
 $\psi_1 - \gamma_1 - \gamma_2 \leq 0,$   
 $\psi_2 - \gamma_2 - \gamma_3 \leq 0,$   
 $\psi_3 - \gamma_3 \leq 0,$   
 $\psi_0 + \psi_1 + \psi_2 + \psi_3 = 1, 0 \leq \psi_0, \psi_1, \psi_2, \psi_3 \leq 1,$   
 $\gamma_1 + \gamma_2 + \gamma_3 = 1 \gamma_1, \gamma_2, \gamma_3 = 0, 1$

**Optimal decision solution for Case 1**

$\Omega = 1,824,129, Q_1 = 2002, Q_2 = 3504, Q_3 = 7105, X_1 = 11, X_2 = 64, X_3 = 65, \mu_1 = 0.23525, \mu_2 = 0.76475, \eta_2 = 1,$   
 $\psi_2 = 0.4666667, \psi_3 = 0.5333333, \gamma_3 = 1$

---

**Table 4.** The detailed data list of Case 1 (unit: mt/USD/hours).

Description	Material (M <sub>j</sub> ) for P# <sub>1</sub>			Products (P# <sub>i</sub> )		
	M <sub>1</sub>	M <sub>2</sub>	M <sub>3</sub>	P# <sub>1</sub>	P# <sub>2</sub>	P# <sub>3</sub>
<b>Sales:</b>						
Maximum demand (Q <sub>i</sub> )/mt				2002	3504	7105
Byproduct Q'ty (Q <sub>p</sub> )/mt <sup>1</sup>				1098		
Selling unit price—product/USD				\$450	\$580	\$660
Selling unit price—byproduct/USD				\$12		
<b>Direct material constraint:</b>						
Batch-level activity:						
Direct material:						
Cost/unit price/mt	\$300	\$317	\$330			
Input total batches (100 mts/1 batch)	11	64	65			
Output product 1 (P# <sub>1</sub> ): (mts/ 1 batch)	88	91	94			
P# <sub>1</sub> for the P# <sub>i</sub> /mt				1	0.96	0.98
Transfer P# <sub>1</sub> (q <sub>i</sub> ) to the ith process/mts <sup>2</sup>				2002	3650	7250
Recycling the byproduct (M <sub>2r</sub> ) of products 2 and 3/mt <sup>3</sup>						
<b>Direct labor constraint</b>				0	146	145
Labor cost (P# <sub>1</sub> /P# <sub>2</sub> /P# <sub>3</sub> ) <sup>4</sup>						
Labor hours (P#1/P#2/P#3) <sup>5</sup>				\$16,170	\$26,539	\$53,575.1
<b>Electrical power cost</b>				2450	3504	7105
Batch-level cost <sup>6</sup>						
Unit-level cost <sup>6</sup>				\$535,500		
<b>Direct machine constraint</b>					\$29,784	\$60,393
Machine cost						
Machine cost				\$100,000	\$50,000	\$150,000
Machine hours (batch/unit)				175	3504	7105
CO <sub>2</sub> emission constraint						
Batch-level mts <sup>7</sup>				5600		
Batch-level cost <sup>8</sup>				\$16,400		
<b>Other indirect cost<sup>9</sup></b>				\$27,027	\$101,616	\$234,465

Note: <sup>1</sup> Byproduct Q'ty = 1098 (Q<sub>p</sub> = Σ<sub>j=1</sub><sup>3</sup> X<sub>j</sub>(B - R<sub>j</sub>); <sup>2</sup> Transfer P#<sub>1</sub>(q<sub>i</sub>) = (Q<sub>i</sub>/T<sub>i</sub>); <sup>3</sup> Recycling the byproduct (M<sub>2r</sub>) = (q<sub>i</sub>-Q<sub>i</sub>); <sup>4</sup> Labor cost (P#<sub>1</sub>/P#<sub>2-3</sub>) (μ<sub>1</sub> = 0.23525, μ<sub>2</sub> = 0.76475) = \$66000\*0.23525 + \$105600\*0.76475 = \$96284.1 = P#<sub>1</sub>(\$16,170) + P#<sub>2</sub>(\$26,539) + P#<sub>3</sub>(\$53,575.1); <sup>5</sup> Labor hours (μ<sub>1</sub> = 0.23525, μ<sub>2</sub> = 0.76475) = 10000H\*0.23525 + 14000H\*0.76475 = 13059H = P#<sub>1</sub>(2450H) + P#<sub>2</sub>(3504H) + P#<sub>3</sub>(7105H); <sup>6</sup> Electrical power cost = (85\*45\*(X<sub>1</sub> + X<sub>2</sub> + X<sub>3</sub>) + 85\*0.1\*Q<sub>2</sub> + 85\*0.1\*Q<sub>3</sub>) = P#<sub>1</sub>(\$535,500) + P#<sub>2</sub>(\$29,784) + P#<sub>3</sub>(\$60,393); <sup>7</sup> CO<sub>2</sub> emission quantity (ψ<sub>2</sub> = 0.4666667, ψ<sub>3</sub> = 0.5333333) = 3000\*ψ<sub>1</sub> + 4000\*ψ<sub>2</sub> + 7000\*ψ<sub>3</sub> = 5600; <sup>8</sup> CO<sub>2</sub> emission cost (ψ<sub>2</sub> = 0.4666667, ψ<sub>3</sub> = 0.5333333) = 0\*ψ<sub>1</sub> + 2000\*ψ<sub>2</sub> + 29,000\*ψ<sub>3</sub> = \$16,400; <sup>9</sup> Other indirect cost = 450\*Q<sub>1</sub>\*0.03 + 580\*Q<sub>2</sub>\*0.05 + 660\*Q<sub>3</sub>\*0.05 = P#<sub>1</sub>(\$27,027) + P#<sub>2</sub>(\$101,616) + P#<sub>3</sub>(\$234,465).

### 6. Three Cases on Enhancing the Quality of Steel-Scrap

This section explores two topics: one is the purchase of high cost steel-scrap and the other is for increasing the yield of P#<sub>1</sub> in the steelmaking process. Assume that the company can produce more quantity of P#<sub>1</sub> and reduce the quantity of byproducts in Process 1; if suppliers are requested to conduct more services, meaning to clean, cut, crush, or classify for improving the quality of steel-scrap, then, enhancing the quality of steel-scrap not only increases the productivity of P#<sub>1</sub> but also increases the business profit.

We will discuss an additional 3 cases, from Case 2 to Case 4, which focus only on the purchase of three different levels of steel purity of steel-scrap, where the illustrative data in Case 1 is unchanged. According to Section 5.2.1, there are three levels of steel purity (M<sub>j</sub>): M<sub>1</sub> lowest (M<sub>c1</sub> = USD 300), M<sub>2</sub> middle (M<sub>c2</sub> = USD 317), and M<sub>3</sub> highest (M<sub>c3</sub> = USD 330). In Case 2 to Case 4, assume that the cost of steel-scrap will gradually increase the purchase cost of USD 8 per mt to arrive at M<sub>cj</sub>' (including M<sub>c1</sub>' = USD 308, M<sub>c2</sub>' = USD 325, and M<sub>c3</sub>' = USD 338) in order to increase the P#<sub>1</sub> yield of 2 mt per batch. Table 5 shows the gradual change in the steel purity levels of steel-scraps from Case 1 to Case 4. The purchasing costs from M<sub>cj</sub> (including: M<sub>c1</sub>, M<sub>c2</sub>, M<sub>c3</sub>) to M<sub>cj</sub>' (including: M<sub>c1</sub>', M<sub>c2</sub>', M<sub>c3</sub>') are gradually higher, which will also increase the quantity of P#<sub>1</sub> from R<sub>j</sub> (including: R<sub>1</sub>, R<sub>2</sub>, R<sub>3</sub>) to R<sub>j</sub>'

(including:  $R_1', R_2', R_3'$ ). For example, from Case 1 to Case 2, due to the higher quality, the purchase unit cost of steel-scrap increased from USD300 ( $Mc_1$ ) to USD308 ( $Mc_1'$ ), and the output quantity of  $P\#_1$  increased from  $R_1(88)$  to  $R_1'(90)$  each batch.

**Table 5.** Cases 1–4 for changes in the unit costs of steel-scrap and the output of  $P\#_1$  \*.

	$Mc_j$			$Mc_j' = Mc_j + USD\ 8$		
	$Mc_1$ @300	$Mc_2$ @317	$Mc_3$ @330	$Mc_1'$ @308	$Mc_2'$ @325	$Mc_3'$ @338
P# <sub>1</sub> /Batch (100 mts)						
	$R_j$			$R_j' = R_j + 2\ mts$		
	$R_1$	$R_2$	$R_3$	$R_1'$	$R_2'$	$R_3'$
	88	91	94	90	93	96
Case 1	300	317	330			
Case 2		317	330	308		
Case 3			330	308	325	
Case 4				308	325	338

\* Changes in the purchasing cost of steel-scrap from  $Mc_j$  to  $Mc_j'$  and in the output of  $P\#_1$  from  $R_j$  to  $R_j'$  each batch from Case 1 to Case 4.

6.1. Optimal Solution for Cases 1–4

Cases 1–4 are solved by using the LINGO software, and the optimal solutions are shown in Table 6. The first column shows a gradual increase in  $\Omega$  from Case 1 to Case 4. In comparing Case 1 with Case 2, we find that the only difference in the  $Q_3$  column of Sales quantity are 7105 in Case 1 and 7056 in Case 2, but the profit of Case 2 ( $\Omega = 1,874,986$ ) is higher than that of Case 1 ( $\Omega = 1,824,129$ ). The reason is that the input material in Case 2 is adapted at the lowest material cost of  $Mc_1'$  (USD308) and the number of batches arriving at 65 is more than the other Cases.

**Table 6.** The optimal solutions for Cases 1–4.

Case	Profit	Sales quantity			Batches $X_j$			Direct Labor $\mu_w$		CO <sub>2</sub> emission $\psi_e$			
	$\Omega$	$Q_1$	$Q_2$	$Q_3$	$X_1$	$X_2$	$X_3$	$\mu_1$	$\mu_2$	$\psi_2$	$\psi_3$	$\gamma_3$	$\eta_2$
1	1,824,129	2002	3504	7105	11	64	65	0.23525	0.76475	0.466667	0.533333	1	1
2	1,874,986	2002	3504	7056	65	16	59	0.24750	0.75250	0.466667	0.533333	1	1
3	1,885,635	2001	3504	7252	11	65	64	0.19850	0.80150	0.466667	0.533333	1	1
4	1,909,646	2002	3504	7350	21	54	65	0.17400	0.82600	0.466667	0.533333	1	1

6.2. Further Analysis

The detailed information of the optimal solutions of Cases 1–4 is shown in Table 7. Columns 1–3 show the unit costs of the various purity levels of steel-scrap, including from Case 1 ( $Mc_1 = 300$ ,  $Mc_2 = 317$ , and  $Mc_3 = 330$ ) to Case 4 ( $Mc_1' = 308$ ,  $Mc_2' = 325$ , and  $Mc_3' = 338$ ), as shown in Table 5. Column 4 shows  $M_{2r}$ , the quantity of steel-scrap byproduct from Process 2 or Process 3 in Cases 1–4; column 5 shows the quantity of byproduct  $Q_p = \sum_{j=1}^3 X_j(B - R_j)$ , for example,  $Q_p$  of Case 1 = 1098, as shown in Table 4. Columns 6 ( $P_1 * Q_1$ ) and 7 ( $K_1 * Q_p$ ) show the sales amounts of three products and the byproducts, respectively, where  $P_1 = \$450$ ,  $P_2 = \$580$ , and  $P_3 = \$660$ ;  $Q_1$ ,  $Q_2$ , and  $Q_3$  are as shown in Table 6; and  $K_1 = USD12$ . Columns 8 ( $Mc_j * X_j * B$ ) and 9 ( $M_{2r} * Mc_{2r}$ ) show the costs of purchasing materials and recycling the byproducts, where  $B = 100$  as discussed in Section 5.1. and  $Mc_{2r} = 322$  as discussed in Section 5.2.1. Furthermore, Column 10 shows the labor cost (Lc); columns 11 and 12 show the electrical power cost ( $Dc_e$ ) and carbon emission cost ( $ec_e$ ), and column 13 shows the other indirect costs ( $Oc_i$ ). Table 8 shows the sales, various costs, and total profit for four cases based on the data of Tables 6 and 7.

**Table 7.** More in-depth information for the optimal solutions (Unit: USD/mt).

Case	Assumptions Mcj→Mcj' (USD)			Quantity (mt)		Sales Amount (USD)		Material Cost (USD)			Costs (USD)		
	(1)	(2)	(3)	(4)	(5)	(6)	(7)	(8)	(9)	(10)	(11)	(12)	(13)
	Mc <sub>1</sub>	Mc <sub>2</sub>	Mc <sub>3</sub>	M <sub>2r</sub>	Q <sub>p</sub>	P <sub>i</sub> *Q <sub>i</sub>	K <sub>1</sub> *Q <sub>p</sub>	Mc <sub>1</sub> *X <sub>1</sub> *B	M <sub>2r</sub> *Mc <sub>2r</sub>	Lc	Dc <sub>i</sub>	eec <sub>b</sub>	Oc <sub>i</sub>
1	300	317	330	291	1098	7,622,520	13,176	4,503,800	93,702	96,284	625,677	16,400	363,108
2	308	317	330	290	1148	7,590,180	13,776	4,456,200	93,380	95,799	625,260	16,400	361,491
3	308	325	330	294	949	7,719,090	11,388	4,563,300	94,668	97,739	626,926	16,400	367,946
4	308	325	338	296	848	7,784,220	10,176	4,598,800	95,312	98,710	627,759	16,400	371,193

**Table 8.** Sales, costs, and total profit of Cases 1–4 (Unit: USD).

Description	Case 1	Case 2	Case 3	Case 4				
Total sales (A=A1+A2)	7,635,696	100.0%	7,603,956	100%	7,730,478	100%	7,794,396	100%
Product sales (A1)	7,622,520	99.8%	7,590,180	99.8%	7,719,090	99.9%	7,784,220	99.9%
Byproduct sales (A2)	13,176	0.2%	13,776	0.2%	11,388	0.1%	10,176	0.1%
Direct material cost (B=B1-B2)	4,410,098	57.8%	4,362,820	57.4%	4,468,632	57.8%	4,503,488	57.8%
Purchasing material (B1)	4,503,800	59.0%	4,456,200	58.6%	4,563,300	59.0%	4,598,800	59.0%
Recycling material (B2)	93,702	1.2%	93,380	1.2%	94,668	1.2%	95,312	1.2%
Direct labor cost (C)	96,284	1.3%	95,799	1.3%	97,739	1.2%	98,710	1.3%
Electrical power cost (D)	625,677	8.2%	625,260	8.2%	626,926	8.1%	627,759	8.1%
Machine cost (E)	300,000	3.9%	300,000	3.9%	300,000	3.9%	300,000	3.8%
CO <sub>2</sub> emission cost (F)	16,400	0.2%	16,400	0.2%	16,400	0.2%	16,400	0.2%
Other indirect cost (G)	363,108	4.8%	361,491	4.8%	367,946	4.8%	371,193	4.8%
Total profit (H=A-B-C-D-E-F-G)	1,824,129	23.9%	1,842,186	24.2%	1,852,835	24.0%	1,876,846	24.1%

## 7. Summary and Conclusions

ABC (Activity-Based Costing) implementation can satisfy the cost information needs of company managers. However, ABSC (Activity-Based Standard Costing) may be a suitable costing tool to enhance the business operating abilities of quality, cost, delivery, service, resources, and productivity in a modern smart factory that uses high-tech unmanned vehicles, advanced robots, various sensors, etc.

In the analysis of Cases 1–4, we hypothesized that (1) three levels of steel purity steel-scrap can produce product P#<sub>1</sub> steel billets and byproduct slag S<sub>1</sub> and (2) in the purchasing process, each level of recycled steel-scrap can gradually enhance its steel purity quality, which not only increases the yield of P#<sub>1</sub> products but also reduces the quantity of byproduct S<sub>1</sub>. With some limited resources, the optimal solution and optimal profit are obtained from the mathematical program decision model and solved using the LINGO software, as shown in Tables 2–8. The final profit, as shown in the last row of Table 8, gradually increased from Case 1 to Case 4. Affirmatively, ABSC may be used soon in the digital era. The high-tech manufacturing of EAF adapts the recycled material of steel-scrap for reproducing various new steel products, which will make great global contributions in terms of pollution and nature mineral resources.

Finally, ABSC can be used to integrate internal and external systems in MES to connect all real-time information regarding the relevant requirements that will help all industries in the digital age.

**Author Contributions:** W.-H.T. provided the research idea and the research purpose and designed the research; S.-H.L. provided the research method, collected and analyzed the data, and wrote the paper; C.-T.H. provided the research method and analyzed the data; W.-H.T. provided the research method and supervised, corrected, and revised this paper. All authors read and approved the final manuscript.

**Funding:** This research was funded by the Ministry of Science and Technology of Taiwan under Grant No. MOST106-2410-H-008-020-MY3.

**Acknowledgments:** The authors are extremely grateful to the sustainability journal editorial team and reviewers who provided valuable comments for improving the quality of this article. The authors also would like to thank the Ministry of Science and Technology of Taiwan for the financial support of this research under Grant No. MOST106-2410-H-008-020-MY3.

**Conflicts of Interest:** The authors declare no conflict of interest.

## References

1. Qin, J.; Liu, Y.; Grosvenor, R. A Categorical Framework of Manufacturing for Industry 4.0 and Beyond. *Procedia CIRP* **2016**, *52*, 173–178. [CrossRef]
2. Kletti, J. *Manufacturing Execution System-MES*; Springer: Berlin/Heidelberg, Germany; New York, NY, USA, 2007; pp. 61–78.
3. Tsai, W.-H.; Yang, C.-H.; Chang, J.-C.; Lee, H.-L. An-Activity-Based Costing Decision Model for Life Cycle Assessment in Green Building Projects. *Eur. J. Oper. Res.* **2014**, *238*, 607–619. [CrossRef]
4. Wikipedia. Steelmaking. Available online: <https://en.m.wikipedia.org/wiki/Steelmaking> (accessed on 23 January 2019).
5. American Iron and Steel Institute. Steel Production, Recycling. Available online: <http://www.steel.org/about-aisi/industry-profile.aspx> (accessed on 23 January 2019).
6. Tsai, W.-H. Activity-Based Costing Model for Joint Products. *Comput. Ind. Eng.* **1996**, *31*, 725–729. [CrossRef]
7. Tsai, W.-H. Project Management Accounting Using Activity-Based Costing Approach. In *The Handbook of Technology Management*; Bidgoli, H., Ed.; John Wiley & Sons, Inc.: Hoboken, NJ, USA, 2010; Volume 1, pp. 469–488.
8. Tsai, W.-H. A technical note on using work sampling to estimate the effort on activities under activity-based costing. *Int. J. Prod. Econ.* **1996**, *43*, 11–16. [CrossRef]
9. Wagner, T.; Herrmann, C.; Thiede, S. Industry 4.0 impacts on lean production systems. *Procedia CIRP* **2017**, *63*, 125–131. [CrossRef]
10. Bedolla, J.S.; D’Antonio, G.; Chiabert, P. A novel approach for teching IT tools with Learning Factories. *Procedia Manuf.* **2017**, *7*, 175–181. [CrossRef]
11. Liu, C.; Xu, X. Cyber-Physical Machine Tool—The Era of Machine Tool 4.0. *Procedia CIRP* **2017**, *63*, 70–75. [CrossRef]
12. Pacaux-Lemoine, M.P.; Trentesaux, D.; Rey, G.Z.; Millot, P. Designing intelligent manufacturing systems through Human-Machine Cooperation principles: A human-centered approach. *Comput. Ind. Eng.* **2017**, *111*, 581–595. [CrossRef]
13. Gašová, M.; Gašo, M.; Štefánik, A. Advanced industrial tools of ergonomics based on Industry 4.0. *Procedia Eng.* **2017**, *192*, 219–224. [CrossRef]
14. Santos, M.Y.; e Sá, J.O.; Andrade, C.; Lima, F.V.; Costa, E.; Costa, C.; Martinho, B.; Galvão, J. A Big Data system supporting Bosch Braga Industry 4.0 strategy. *Int. J. Inf. Manag.* **2017**, *36*, 750–760. [CrossRef]
15. Moutaz, H.; Ahmed, E. The Readiness of ERP Systems for the Factory of the Future. *Procedia Comput. Sci.* **2015**, *64*, 721–728.
16. Grundstein, S.; Freitag, M.; Scholz-Reiter, B. A new method for autonomous control of complex job shops—Integrating order release, sequencing and capacity control to meet due dates. *J. Manuf. Syst.* **2017**, *42*, 11–28. [CrossRef]
17. Kans, M.; Ingwald, A. Business Model Development towards Service Management 4.0. *Procedia CIRP* **2016**, *47*, 489–494. [CrossRef]
18. Wang, S.; Wan, J.; Zhang, D.; Li, D.; Zhang, C. Towards smart factory for industry 4.0: A self-organized multi-agent system with big data based feedback and coordination. *Comput. Netw. Volume* **2016**, *101*, 158–168. [CrossRef]
19. Stock, T.; Seliger, G. Opportunities of Sustainable Manufacturing in Industry 4.0. *Procedia CIRP* **2016**, *40*, 536–541. [CrossRef]
20. Becker, T.; Stern, H. Future trends in human work area design for cyber-physical production system. *Procedia CIRP* **2016**, *57*, 404–409. [CrossRef]
21. Wikipedia. Paris Agreement. Available online: <https://en.wikipedia.org/wiki/Parisagreement> (accessed on 15 March 2018).
22. Tung Ho Steel Enterprise Corp. Profile, CSR, Products. Available online: <http://www.tunghosteel.com/EN/HomeEg/about/intro> (accessed on 23 January 2019).
23. Tsai, W.-H.; Lin, S.-J.; Liu, J.-Y.; Lin, W.-R.; Lee, K.-C. Incorporating life cycle assessments into building project decision-making: An energy consumption and CO<sub>2</sub> emission perspective. *Energy* **2011**, *36*, 3022–3029. [CrossRef]

24. Bauerdick, C.J.; Helfert, M.; Menz, B.; Abele, E. A common software Framework for Energy Data Based Monitoring and Controlling for Machine power Peak Reduction and Workpiece Quality Improvements. *Procedia CIRP* **2017**, *61*, 359–364. [[CrossRef](#)]
25. Chen, J.-Y.; Tai, K.-C.; Chen, G.-C. Application of programmable Logic Controller to Build-up an Intelligent Industry 4.0 Platform. *Procedia CIRP* **2017**, *63*, 150–155. [[CrossRef](#)]
26. Rudolph, J.P.; Emmelmann, C. A Cloud-Based Platform for Automated Order Processing in Additive Manufacturing. *Procedia CIRP* **2017**, *63*, 412–417. [[CrossRef](#)]
27. Chen, K.-C.; Lien, S.-Y. Machine-to-machine communications: Technologies and challenges. *Ad Hoc Netw.* **2014**, *18*, 3–23. [[CrossRef](#)]
28. Tsai, W.-H.; Lin, T.-W.; Chou, W.-C. Integrating Activity-Based Costing and Environmental Cost Accounting Systems: A Case Study. *Int. J. Bus. Syst. Res.* **2010**, *4*, 186–208. [[CrossRef](#)]
29. Tsai, W.-H.; Lin, T.W. A Mathematical Programming Approach to Analyze the Activity-Based Costing Product-Mix Decision with Capacity Expansions. In *Applications of Management Science*; Lawrence, K.D., Ed.; JAI Press Inc.: Greenwich, CT, USA, 2004; Volume 11, pp. 161–176.
30. Chinnathai, M.K.; Günther, T.; Ahmad, M.; Stocker, C.; Richter, L.; Schreiner, D.; Vera, D.; Reinhart, G.; Harrison, R. An application of physical flexibility and software reconfigurability for the automation of battery module assembly. *Procedia CIRP* **2017**, *63*, 604–609. [[CrossRef](#)]
31. de Sampaio, R.J.; Wollmann, R.R.; Vieira, P.F. A flexible production planning for rolling-horizons. *Int. J. Product. Econ.* **2017**, *190*, 31–36. [[CrossRef](#)]
32. de Man, J.C.; Strandhagen, J.O. An Industry 4.0 research agenda for sustainable business models. *Procedia CIRP* **2017**, *63*, 721–726. [[CrossRef](#)]
33. Poonpakdee, P.; Koivaniit, J.; Yuangyai, C. Decentralized Network Building Change in Large Manufacturing Companies towards Industry 4.0. *Procedia Comput. Sci.* **2017**, *110*, 46–53. [[CrossRef](#)]
34. Meissner, H.; Ilsen, R.; Aurich, J.C. Analysis of control architectures in the context of Industry 4.0. *Procedia CIRP* **2017**, *62*, 165–169. [[CrossRef](#)]
35. Kolsch, P.; Herder, C.F.; Zimmermann, V.; Aurich, J.C. A novel concept for the development of availability-oriented business models. *Procedia CIRP* **2017**, *64*, 340–344. [[CrossRef](#)]
36. Schlegel, A.; Langer, T.; Putz, M. Developing and harnessing the potential of SMEs for eco-efficient flexible production. *Procedia Manuf.* **2017**, *9*, 41–48. [[CrossRef](#)]
37. Majstorovic, V.; Stojadinovic, S.; Zivkovic, S.; Djurdjanovic, D.; Jakovljevic, Z.; Gligorijevic, N. Cyber-Physical Manufacturing Metrology Model (CPM) for sculptured surfaces- Turbine Blade Application. *Procedia CIRP* **2017**, *63*, 658–663. [[CrossRef](#)]
38. Lee, J.; Bagheri, B.; Kao, H.A. A Cyber-Physical Systems architecture for Industry 4.0-based manufacturing systems. *Manuf. Lett.* **2015**, *3*, 18–23. [[CrossRef](#)]
39. Li, H.; Parlikad, A.K. Social Internet of Industrial Things for Industrial and Manufacturing Assets. *IFAC* **2016**, *49*, 208–213.
40. Functional SAP ERP Modules. SAP ERP Modules: Complete List of SAP ERP Modules. Available online: <https://solutiondots.com/blog/sap-erp-modules/> (accessed on 13 January 2019).
41. Tsai, W.-H.; Yang, C.-H.; Huang, C.-T.; Wu, Y.-Y. The Impact of the Carbon Tax Policy on Green Building Strategy. *J. Environ. Plan. Manag.* **2017**, *60*, 1412–1438. [[CrossRef](#)]
42. Tsai, W.-H.; Tsaur, T.-S.; Chou, Y.-W.; Liu, J.-Y.; Hsu, J.-L.; Hsieh, C.-L. Integrating the Activity-Based Costing System and Life-Cycle Assessment into Green Decision Making. *Int. J. Prod. Res.* **2015**, *53*, 451–465. [[CrossRef](#)]
43. Tsai, W.-H.; Chang, J.-C.; Hsieh, C.-L.; Tsaur, T.-S.; Wang, C.-W. Sustainability Concept in Decision-Making: Carbon Tax Consideration for Joint Product Mix Decision. *Sustainability* **2016**, *8*, 1232. [[CrossRef](#)]
44. Tsai, W.-H. A Green Quality Management Decision Model with Carbon Tax and Capacity Expansion under Activity-Based Costing (ABC)—A Case Study in the Tire Manufacturing Industry. *Energies* **2018**, *11*, 1858. [[CrossRef](#)]
45. Tsai, W.-H. Carbon Taxes and Carbon Rights Cost Analysis for the Tire Industry. *Energies* **2018**, *11*, 2121. [[CrossRef](#)]
46. Tsai, W.-H.; Lu, Y.-H. A Framework of Production Planning and Control with Carbon Tax under Industry 4.0. *Sustainability* **2018**, *10*, 3221. [[CrossRef](#)]

47. Tsai, W.-H. Green Production Planning and Control for the Textile Industry by Using Mathematical Programming and Industry 4.0 Techniques. *Energies* **2018**, *11*, 2072. [[CrossRef](#)]
48. Tsai, W.-H.; Jhong, S.-Y. Carbon Emission Cost Analysis with Activity-Based Costing. *Sustainability* **2018**, *10*, 2872. [[CrossRef](#)]
49. Tsai, W.-H.; Jhong, S.-Y. Production Decision Model with Carbon Tax for the Knitted Footwear Industry under Activity-Based Costing. *J. Clean. Prod.* **2019**, *207*, 1150–1162. [[CrossRef](#)]
50. Tsai, W.-H.; Lai, S.-Y. Green Production Planning and Control Model with ABC under Industry 4.0 for the Paper Industry. *Sustainability* **2018**, *10*, 2932. [[CrossRef](#)]
51. Tsai, W.-H.; Chu, P.-Y.; Lee, H.-L. Green Activity-Based Costing Production Planning and Scenario Analysis for the Aluminum-Alloy Wheel Industry under Industry 4.0. *Sustainability* **2019**, *11*, 756. [[CrossRef](#)]



© 2019 by the authors. Licensee MDPI, Basel, Switzerland. This article is an open access article distributed under the terms and conditions of the Creative Commons Attribution (CC BY) license (<http://creativecommons.org/licenses/by/4.0/>).





Article

# Carbon Emissions Cost Analysis with Activity-Based Costing

Wen-Hsien Tsai \* and Shi-Yin Jhong

Department of Business Administration, National Central University, Jhongli, Taoyuan 32001, Taiwan; a29583362@gmail.com

\* Correspondence: whtsai@mgt.ncu.edu.tw; Tel.: +886-3-4267247; Fax: +886-3-4222891

Received: 4 July 2018; Accepted: 8 August 2018; Published: 13 August 2018

**Abstract:** Due to growing awareness about environmental issues, consumers are becoming more likely to purchase environmentally friendly products that involve lower carbon emissions (CE). Environmental regulations are being enforced and lower-carbon products are being produced in order to maintain competitiveness when complying with such regulations. This paper aims to explore the effect of CE on profit through three kinds of models using the activity-based costing (ABC) approach. The results indicate that governmental policy makers can effectively decrease CE by Total Quantity Control (TQC) to resolve problems of environmental degradation. Governmental policy makers can control CE by limiting the quantities of CE, thereby forcing manufacturers to decrease CE during production. Furthermore, policy makers can set up regulations on CE quotas to control CE well instead of imposing carbon taxes. Therefore, manufacturers will try their best to find methods of improving production processes, equipment, and/or materials to decrease the CE quantity and achieve maximum profit under the restricted carbon emissions quotas.

**Keywords:** carbon emissions; cap & trade; green production; footwear industry; activity-based costing (ABC)

## 1. Introduction

Climate change has become a global issue that requires comprehensive solutions to prevent serious environmental, social, and economic impacts [1]. Environmental issues are especially serious for shoe manufacturers due to the production processes and the sourcing of raw materials, as well as workers being harmed by organics and solvents while producing a pair of shoes [2,3]. The evidence suggests that the adverse effects of climate change can be improved by mitigating man-made greenhouse gas emissions (GHG) [4].

In the footwear industry, manufacturers generate many different kinds of shoes to satisfy the demands of consumers. However, the enormous amount of shoes produced has resulted in environmental degradation due to the production methods and materials used to make shoes in the past [5]. Because environmental consciousness is currently gaining ground, consumers will be more likely to purchase environmentally friendly products that involve lower carbon emissions (CE) [6–9]. Thus, changing the production methods and adding environmentally friendly products are key factors to maintaining a competitive advantage.

Due to growing awareness about environmental issues, green production has become widely used to keep a competitive advantage [10,11]. Manufacturers will need to consider other solutions to improve operation performance in order to estimate production costs and environmental cost accurately. To effectively decrease the damage caused by CE, related low-carbon laws, regulations, and policies have been put in place. For example, regulations on cap-and-trade have forced manufacturers to effectively decrease CE in order to improve the environment for humanity's survival [12,13].

However, traditional management accounting considers environmental costs as normal overhead costs, and manufacturers have no interest in addressing issues relevant to the environment [14], such as the carbon emissions cost (CEC). Various industries have used the activity-based costing (ABC) approach to accurately estimate production costs alongside environmental costs, including industries such as construction, DRAM, tourism, automotive, aviation, and metal manufacturing [15–19]. Furthermore, the ABC approach has been used to estimate environmental cost and to evaluate the impact on profit of carbon emissions, Volatile Organic Compounds (VOCs) emissions, coal ash, sludge and waste residue in the models [17,18,20,21]. However, there are few studies that use the ABC approach in the footwear industry to resolve problems of cost and the environment. Therefore, this study utilized the ABC approach to accurately estimate the effect of CE.

Moreover, previous researchers did not consider the possibility of purchasing carbon rights to get a larger CE allowance for production, but only considered carbon tax (CT) in their models when using the ABC approach to estimate CEC [17,21–23]. For this reason, the models in this study discussed the effect of CE on profit through three kinds of situations. We incorporated the concept of cap-and-trade (CAT), in which companies have a limited number of permits for carbon emissions allocated from the government. The companies are required to hold permits in an amount equal to their emissions; otherwise they need to buy carbon rights (CR) from the market.

In this paper, we assume that the company has a CE quota allocated from the government. Carbon emissions allocation is a fundamental method of carbon emissions reduction through government policy. Zhou and Wang [24] classified the allocation method into four approaches through a comprehensive literature review: (1) *Indicator approach*: the carbon emissions allocation is based on a “single indicator” such as population [25], historical emissions [26], per capita GDP [27], etc., or on a “composite indicator” [28]; (2) *Optimization approach*: Pang et al. [29] used the ZSG-DEA (zero sum gains–data envelopment analysis) model, proposed by Gomes and Lins [30], to allocate emissions permits among sample countries, and Filar and Gaertner [31] explored the GHG emissions reduction allocation using a nonlinear programming approach; (3) *Game theoretic approach*: this approach will consider the negotiation between different entities in carbon emissions allocation. Ren et al. [32] developed a Stackelberg game model to investigate the allocation of carbon emissions reduction targets in a made-to-order supply chain; (4) *Hybrid approach*: this approach uses a mixture of various methods for emissions allocation [33,34]. In all four approaches, the main principles considered are “fairness” and “efficiency.” The indicator and hybrid approaches are suitable when the major concern is “fairness”; the optimization approach will be considered when the major concern is “efficiency.” However, each approach has its strengths and weaknesses and is suitable for specific allocation problems [24].

The results of our research have indicated that a more effective solution to decrease CE quantity is to control the amount of CE through the use of a CE quota allocated by the government rather than adjusting the CT or CR. If manufacturers can afford the cost of CE, they will not have an incentive to improve production to decrease CE [35,36]. In the future, policy makers could consider Total Quantity Control (TQC) of CE to force manufacturers to improve issues regarding environmental degradation. This will force manufacturers to face the problem of limited CE permits and improve production processes, equipment, or materials to effectively comply with standards to decrease the CE quantity and achieve maximum profit.

The remaining sections of this paper are as follows. There is a literature review in Section 2, while a green production planning model with carbon emissions under the ABC approach is proposed in Section 3. An illustration used to explain the application of the model is presented in Section 4, and finally, concluding remarks are given in Section 5.

## **2. Environmental Protection, Carbon Emissions, and Green Production**

### *2.1. Awareness and Protection of the Environment for the Footwear Industry*

The thick haze that has shrouded most large capital cities has caused awareness of the need for environmental protection [37]. Likewise, shoe manufacturers have faced a similar problem in their business operations. The amount of shoes that plants have produced has led to serious issues concerning labor conditions, society, and the environment [38–40] due to complex work environments and the amount of energy consumed during the production process [41,42]. The workers responsible for producing shoes are exposed to harmful mixtures of solvents such as adhesives, primers, degreasers, and cleaners [43] during the production of shoes [40].

The issue of negative environmental externalities [44–46] arises when there is environmental damage caused by industrial pollution coming from manufacturing products, but manufacturers do not bear all the costs. For example, when a factory lets untreated wastewater flow into a river, the river is polluted and the residents and the government bear the costs of health and purification [46]. In view of this, the government may gradually impose various external environmental costs on companies through environmental regulations such as penalties for illegal discharge of wastewater or other pollutants, carbon tax costs for carbon emissions, and so on [45].

In view of this, manufacturers need to produce products by green processes [47], because harmful products that result in environmental issues will affect the purchase willingness of customers [48,49]. Thus, green products and green production methods that can decrease environmental degradation have gradually become a hot topic [50], and it is a matter of vital importance for shoe manufacturers to improve their working conditions by eliminating materials and production methods that harm the environment [40–42].

### *2.2. The Environment, Carbon Emissions, and Green Production*

Economic development has been greatly affected by CE, which has resulted in greenhouse gases [51]. Evidence suggests that the adverse effects of climate change can be improved by mitigating man-made greenhouse gas (GHG) emissions [4]. The more environmental regulations are enforced, the more lower-carbon products will be produced in order to maintain a competitive advantage [52], such as using renewable resources [53]. In the fashion industry, manufacturers have used new technologies to effectively decrease CE in the manufacturing process and manufacture products that are environmentally friendly [54].

Related low-carbon laws, regulations, and policies have been enforced in a number of countries. Cap-and-trade is one of the most effective mechanisms that can help to effectively decrease CE [12,13]. Policy makers can control the quantities of CE produced by manufactures through CR trading [55]. For example, to comply with the trend of the reduction of CE, China has built a carbon market that includes the Shanghai Environment and Energy Exchange (SEEE), the China Beijing Environment Exchange (CBEEEX), and the China Shenzhen Emission Rights Exchange (CSERE) [56]. CT can be considered an effective solution that can help decrease the effect of greenhouse gases [57]. Thus, manufacturers can reduce their impact on the environment and CE to maintain a competitive advantage by adopting green production technologies [10].

## **3. Green Production Planning Model with Carbon Emissions under ABC Approach**

The model in this article uses the activity-based costing (ABC) approach to estimate relevant costs because it can help manufacturers more precisely assign overhead and relevant costs to products and accurately identify non-value-added costs [58,59]. Moreover, manufacturers can effectively increase the benefit through the optimal product mix by using the ABC approach and the theory of constraint (TOC) [60].

In the past, producing a pair of shoes could cause a lot of pollution between sewage, exhaust, and contaminants [61–64]. Redesigning a pair of shoes could improve the environmental problems caused by production methods and materials [42] by decreasing pollution.

In the production process of knitted shoes, a pair of shoes consists of an upper/vamp and sole/bottom [65,66]. Knitted shoes have been changed to a pair of knitted layers formed of a unitary knitted design [66] because manufacturers have combined the techniques of the textile and footwear industries. The production of knitted shoes has the advantages of simplifying the production process enormously and effectively decreasing the demand for labor, thereby effectively decreasing costs. The production process of knitted shoes is shown in Figure 1.

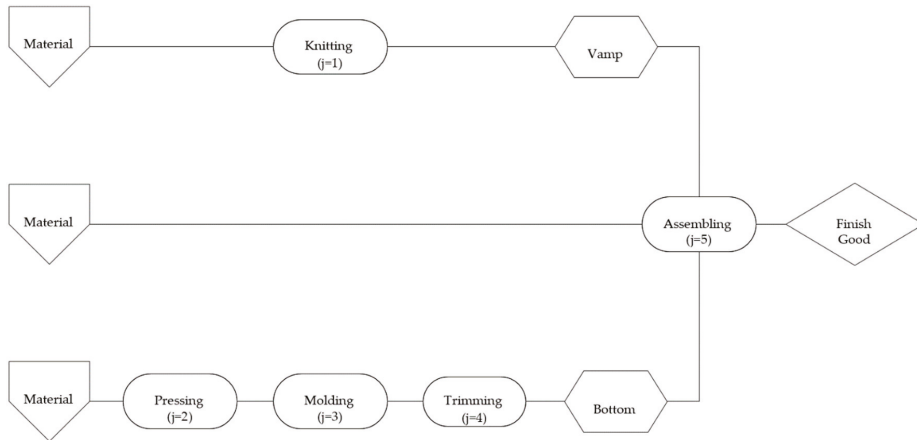

**Figure 1.** Production process of knitted footwear.

In Figure 1, there are five main manufacturing activities to produce knitted shoes, including knitting ( $j = 1$ ), pressing ( $j = 2$ ), molding ( $j = 3$ ), trimming ( $j = 4$ ), and assembling ( $j = 5$ ). Knitting ( $j = 1$ ) is used to manufacture vamps using a knitting machine, and pressing ( $j = 2$ ), molding ( $j = 3$ ), and trimming ( $j = 4$ ) are used to manufacture bottoms. The vamps and bottoms are combined to become shoes through the activity of assembling ( $j = 5$ ). These processing activities use human labor hours and/or machine hours. There are also two supporting activities, setting up ( $j = 6$ ) and material handling ( $j = 7$ ).

### 3.1. Carbon Emissions Costs

#### 3.1.1. Carbon Emissions Quantity Function

A large quantity of shoes is produced each year in order to comply with consumer demand, and the carbon emissions (CE) caused by production have seriously affected the environment. CE are considered an important factor for manufacturers in environmentally sustainable development [20,67], and low-CE products attract customers [37]. Therefore, green production and products are becoming more important in order for manufacturers to comply with CE standards.

The materials and manufacturing process contribute greatly to products' CE for footwear manufacturers. This model considers the effects of CE in the manufacturing process on footwear manufacturers' profit. The collection of CT by the government can force related industries to be concerned about decreasing CE and enhancing environmental protection [68–71].

In order to protect the environment and reduce the risk generated by CE, manufacturers need to effectively control CE. Accordingly, the models proposed in this paper could be used to evaluate the influence of CE resulting from production. In the production process of knitted shoes, we assumed

that CE will result from three kinds of machine operations, including knitting for the vamp ( $j = 1$ ), pressing for the bottom ( $j = 2$ ), and assembling ( $j = 5$ ). Zhang et al. [72] used two substitutable products to explore the impact of consumer environmental awareness when products are produced in different quantities by manufacturers. This study assumed that the total CE quantity ( $g$ ) generated from three kinds of activities to produce three kinds of products can be formulated as in Equation (1):

$$\begin{aligned}
 g &= f_1(X_1, X_2, X_3) = \sum_{i=1}^3 \sum_{j=1,2,5} CE_{ij} X_i \\
 &= (CE_{11} + CE_{12} + CE_{15})X_1 + (CE_{21} + CE_{22} + CE_{25})X_2 + (CE_{31} + CE_{32} + CE_{35})X_3
 \end{aligned}
 \tag{1}$$

where  $X_i$  is the quantity of product  $i$  and  $CE_{ij}$  is the CE quantity of one unit of product  $i$  in activity  $j$ . Equation (1) is the company’s total carbon emissions, which is a function of the products’ quantities. According to Lee et al. [73], CT can be an effective solution to decrease CE. Thus, manufacturers should decrease CT through carbon emissions reduction techniques.

### 3.1.2. Carbon Tax Cost Function

This paper assumed that the carbon tax cost function is as shown in Figure 2. It is a carbon tax cost function with extra progressive tax rates, where the quantity at different ranges of CE quantity will have different tax rates. The upper limits of the CE quantity at the first and second range of CE quantity are  $UCE_1$  and  $UCE_2$  in Figure 2, respectively, and the carbon tax cost at  $UCE_1$  and  $UCE_2$  are  $CTC_1$  and  $CTC_2$ , respectively. In addition, the carbon tax rates in the first, second, and third range of CE quantity are  $TR_1$ ,  $TR_2$ , and  $TR_3$ , respectively. Therefore, the carbon tax cost function in Figure 2 can be represented as in Equation (2):

$$f_2(g) = \begin{cases} g * TR_1, & \text{If } 0 \leq g \leq UCE_1 \\ CTC_1 + (g - UCE_1)TR_2, & \text{If } UCE_1 < g \leq UCE_2 \\ CTC_2 + (g - UCE_2)TR_3, & \text{If } UCE_2 < g \end{cases}
 \tag{2}$$

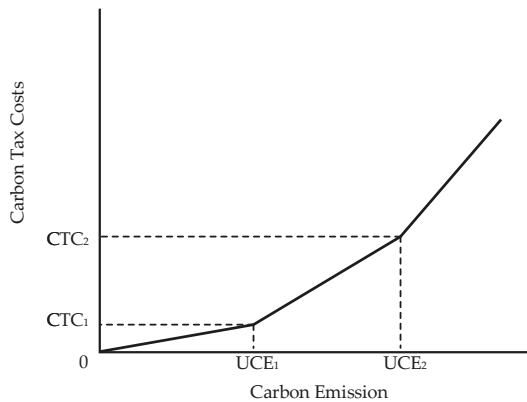

Figure 2. Carbon taxes cost function.

Equation (2) is the general form of the carbon tax cost function, which is a function of a company’s total carbon emissions quantity ( $g$ ) and can be represented by Equations (3)–(15) in the mathematical programming model. Equation (3) is the carbon tax cost, which is a deduction item of total revenue in calculating the company’s total profit. Equations (4)–(15) are the constraints associated with the carbon tax cost.

Carbon tax cost:

$$CTC = CTC_1\mu_1 + CTC_2\mu_2 + CTC_3\mu_3. \tag{3}$$

The associated constraints are:

$$\sum_{i=1}^n \sum_{j=1,2,5} CE_{ij}X_i = UCE_1\mu_1 + UCE_2\mu_2 + UCE_3\mu_3 \tag{4}$$

$$\mu_0 - \theta_1 \leq 0 \tag{5}$$

$$\mu_1 - \theta_1 - \theta_2 \leq 0 \tag{6}$$

$$\mu_2 - \theta_2 - \theta_3 \leq 0 \tag{7}$$

$$\mu_3 - \theta_3 \leq 0 \tag{8}$$

$$\mu_0 + \mu_1 + \mu_2 + \mu_3 = 1 \tag{9}$$

$$\theta_1 + \theta_2 + \theta_3 = 1 \tag{10}$$

$$0 \leq \mu_0 \leq 1 \tag{11}$$

$$0 \leq \mu_1 \leq 1 \tag{12}$$

$$0 \leq \mu_2 \leq 1 \tag{13}$$

$$0 \leq \mu_3 \leq 1 \tag{14}$$

$$\theta_1, \theta_2, \theta_3 = 0, 1, \tag{15}$$

where:

- CE<sub>ij</sub>            The CE quantity of one unit of product i in activity j (j = 1, 2, 5).
- CTC             The company's carbon tax cost.
- UCE<sub>3</sub>            A large quantity of CE since there is no upper limit in the third range of the carbon tax system set by the government; we cannot run the mathematical programming program if we do not give UCE<sub>3</sub>.
- CTC<sub>3</sub>            The carbon tax cost at UCE<sub>3</sub>.
- TR<sub>i</sub>             The tax rate when the CE quantity falls within the ith range of Figure 2.
- θ<sub>1</sub>, θ<sub>2</sub>, θ<sub>3</sub>        A special ordered set of type 1 (SOS1) of 0–1 variables in which only one variable can be 1.
- μ<sub>0</sub>, μ<sub>1</sub>, μ<sub>2</sub>, μ<sub>3</sub>    A special ordered set of type 2 (SOS2) of non-negative variables in which at most two adjacent variables can be non-zero in the order of the set.

(θ<sub>1</sub>, θ<sub>2</sub>, θ<sub>3</sub>) is a special ordered set of type 1 (SOS1) of 0–1 variables in which only one variable can be 1, which are indicator variables. If θ<sub>1</sub> = 1, then θ<sub>2</sub> = θ<sub>3</sub> = 0 from Equation (10), μ<sub>2</sub> = μ<sub>3</sub> = 0 from Equations (7) and (8), μ<sub>0</sub>, μ<sub>1</sub> ≤ 1 from Equations (5) and (6), and μ<sub>0</sub> + μ<sub>1</sub> = 1 from Equation (9). Thus, the company's total CE quantity is UCE<sub>1</sub>μ<sub>1</sub> from Equation (4) and the carbon tax cost is CTC<sub>1</sub>μ<sub>1</sub> from Equation (3), respectively. The company's total CE quantity (g) falls within the first range of Figure 2, [0, UCE<sub>1</sub>] and (g, CTC) is the linear combination of two points, (0, 0) and (UCE<sub>1</sub>, CTC<sub>1</sub>). If θ<sub>2</sub> = 1, then θ<sub>1</sub> = θ<sub>3</sub> = 0 from Equation (10), μ<sub>0</sub> = μ<sub>3</sub> = 0 from Equations (5) and (8), μ<sub>1</sub>, μ<sub>2</sub> ≤ 1 from Equations (6) and (7), and μ<sub>1</sub> + μ<sub>2</sub> = 1 from Equation (9). Thus, the company's total CE quantity is UCE<sub>1</sub>μ<sub>1</sub> + UCE<sub>2</sub>μ<sub>2</sub> from Equation (4) and the carbon tax cost is CTC<sub>1</sub>μ<sub>1</sub> + CTC<sub>2</sub>μ<sub>2</sub> from Equation (3), respectively. The company's total CE quantity (g) falls within the second range of Figure 2, (UCE<sub>1</sub>, UCE<sub>2</sub>) and (g, CTC) is the linear combination of two points, (UCE<sub>1</sub>, CTC<sub>1</sub>) and (UCE<sub>2</sub>, CTC<sub>2</sub>). Similarly, if θ<sub>3</sub> = 1, then the company's total CE quantity (g) falls within the third range of Figure 2, (UCE<sub>2</sub>, UCE<sub>3</sub>), i.e., g = UCE<sub>2</sub>μ<sub>2</sub> + UCE<sub>3</sub>μ<sub>3</sub> from Equation (4) and the carbon tax cost is CTC<sub>2</sub>μ<sub>2</sub> + CTC<sub>3</sub>μ<sub>3</sub> from Equation (3).

3.1.3. Carbon Emissions Cost without Carbon Trading—Model 1

The carbon emissions cost may include the carbon tax cost imposed by the government and the carbon rights cost (CRC) from carbon trading. A company’s CE quantity may be limited by the government’s contribution of a certain permit to the company under a cap-and-trade system [74]. Carbon trading is an effective way to resolve limitations on CE quantity and help the company expand its CE quantity through purchasing carbon rights (CR) in the market.

This paper proposed three models to analyze the effect of carbon emissions; a framework is presented in Figure 3. In this paper, the carbon emissions cost includes carbon tax and carbon rights costs. Model 1 only considers carbon tax; Model 2 considers carbon rights purchase at a single carbon rights cost rate; Model 3 considers carbon rights purchase with a minimum order quantity of carbon emissions (MOQCE).

The main difference between these three models is the carbon emissions cost. If the carbon emissions costs are represented by the components, the three models explored in this paper can be shown in Figure 4. Model 1: The manufacturer only takes CTC into consideration when determining their carbon emissions cost (CEC), so the manufacturer would not undertake carbon trading to purchase CR. Model 2: the manufacturer would consider whether it purchases CR in the market or not; CEC would be equal to  $(CTC)\delta_1$  if the manufacturer does not purchase CR, or equal to  $(CTC + CRC)\delta_2$  if the manufacturer purchases CR at a single carbon rights cost rate during carbon trading. Model 3: The manufacturer would consider whether to purchase a minimum order quantity of carbon emissions (MOQCE) to satisfy their demand, considering that CRC is equal to a fixed carbon rights cost (FCRC), or the manufacturer can purchase CR at a single carbon rights cost rate if CE exceed MOQCE.

Let LCE be the carbon emissions quantity that the company can emit when limited by the government. In Model 1, the carbon emissions cost only includes the carbon tax cost, as shown in Equation (3). The following constraint associated with carbon emissions should be added to the model:

$$\sum_{i=1}^n \sum_{j=1,2,5} CE_{im} X_i \leq LCE \tag{16}$$

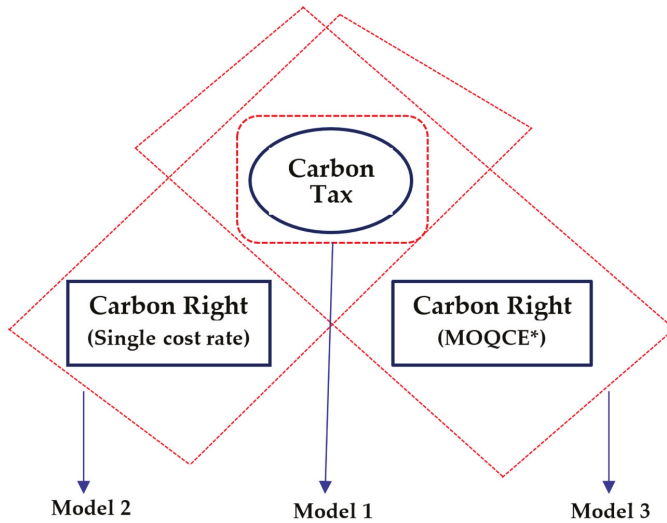
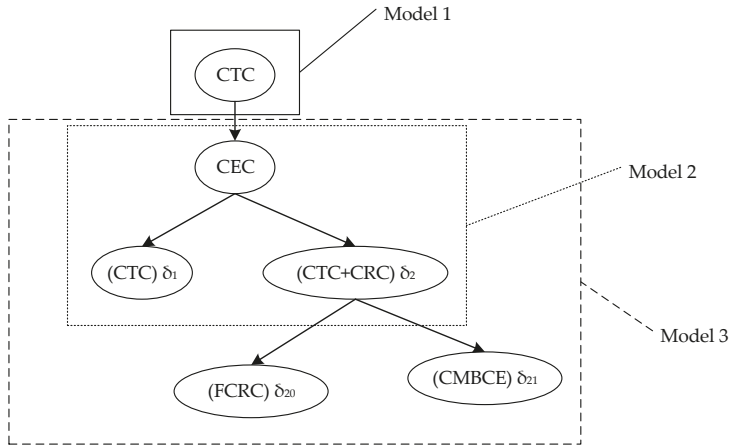

Figure 3. The framework of carbon emissions costs of the three models explored in this paper.



**Figure 4.** The components of carbon emissions cost function for three models; [Note] CTC: Carbon tax cost; CEC: Carbon emissions cost; CRC: Carbon rights cost; FCRC: Fixed carbon rights cost at MOQCE; MOQCE: Minimum order quantity of carbon emissions; CMBCE: Cost of maximum buyable CE quantity that the company can purchase in the market.

3.1.4. Carbon Emissions Cost with Carbon Trading of a Single Carbon Rights Cost Rate—Model 2

In recent years, there have been many studies to estimate the impact of CT on production through ABC [17,22,23]. However, there have been few articles that consider CRC in their decision model through ABC. In Model 2, we assume that the company can purchase CR at a single CRC rate ( $r$ ) for any carbon emissions needed to receive the opportunity of additional sales. The CRC function can be represented as shown in Equation (18) and Figure 5. In Equation (18),  $f_4(g - LCE)$  is a CRC function, which is a function of CR purchase quantity ( $g - LCE$ ). Assume that the upper limit of the carbon emissions purchase quantity is UPCE. The upper limit on the carbon emissions the company can emit is  $LPCE = LCE + UPCE$  and its CRC at UPCE is UCR. Thus, the carbon emissions cost function in Model 2 can be represented as shown in Equation (17):

$$f_3(g) = \begin{cases} f_2(g), & \text{If } 0 \leq g \leq LCE \\ f_2(g) + f_4(g - LCE), & \text{If } LCE < g \leq LPCE (= LCE + YPCE) \end{cases} \quad (17)$$

$$f_4(g - LCE) = r * (g - LCE). \quad (18)$$

Equation (17) can be formulated as Equations (19)–(23) in the mathematical programming model. Equation (19) is the carbon emissions cost function of Model 2, and Equations (20)–(23) and Equations (4)–(15) are the constraints associated with the carbon emissions cost function of Model 2.

Carbon emissions cost of Model 2:

$$CEC = (CTC_1\mu_1 + CTC_2\mu_2 + CTC_3\mu_3)\delta_1 + [(CTC_1\mu_1 + CTC_2\mu_2 + CTC_3\mu_3) + (g - LCE) * r]\delta_2 \quad (19)$$

The associated constraints are:

$$g = \sum_{i=1}^n \sum_{j=1,2,5} CE_{im}X_i = \phi_1 + \phi_2 \quad (20)$$

$$0 \leq \phi_1 \leq \delta_1 LCE \quad (21)$$



$$\delta_2 LCE < \phi_2 \leq \delta_2 LPCE \tag{22}$$

$$\delta_1 + \delta_2 = 1, \tag{23}$$

where:

- CEC                    The carbon emissions cost including the carbon tax and carbon rights.
- LPCE                  The upper limit of the carbon emissions quantity the company can emit.
- UPCE                  The upper limit of the carbon emissions purchase quantity.
- r                        The single carbon rights cost rate.
- $\phi_1$                     The company's total CE quantity when  $g \leq LCE$ .
- $\phi_2$                     The company's total CE quantity when  $g > LCE$ .
- A special ordered set of type 1 (SOS1) of 0–1 variables in which only one variable can be 1;
- $\delta_1, \delta_2$                $\delta_1 = 1$  means that the company does not need to purchase carbon rights, and  $\delta_2 = 1$  means that the company needs to purchase carbon rights.

$(\delta_1, \delta_2)$  is a special ordered set of type 1 (SOS1) of 0–1 variables in which only one variable can be 1. If  $\delta_1 = 1$ , then  $\delta_2 = 0$  from Equation (23), and  $0 \leq g = \phi_1 \leq LCE$  from Equations (20) and (21). This means that the company does not need to purchase CR. The total carbon emissions cost is  $(CTC_1\mu_1 + CTC_2\mu_2 + CTC_3\mu_3)$  from Equation (19), including only the carbon tax cost. If  $\delta_2 = 1$ , then  $\delta_1 = 0$  from Equation (23), and  $LCE < g = \phi_2 \leq LPCE$  from Equations (20) and (22). This means that the company needs to purchase CR. The total carbon emissions cost is  $[(CTC_1\mu_1 + CTC_2\mu_2 + CTC_3\mu_3) + r * (g - LCE)]$  from Equation (19), including the carbon tax cost and the CRC. The associated constraints associated with the carbon tax cost are shown as Equations (4)–(15).

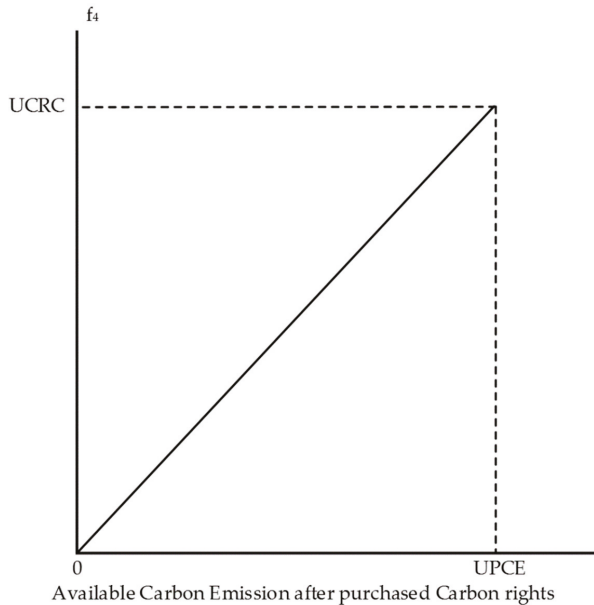

Figure 5. Carbon rights cost function with a single rate.

### 3.1.5. Carbon Emissions Cost with Carbon Trading of MOQCE—Model 3

In Model 3, it is assumed that the company can purchase CR through carbon trading of a minimum order quantity of carbon emissions (MOQCE) based on the Carbon Financial Instrument from the Chicago Climate Exchange (CCX) to allow additional sales. The company should purchase the minimum quantity of CE rights with a fixed carbon rights cost (FCRC). The carbon rights cost

function of Model 3 can be represented as in Figure 6, and its related carbon emissions cost can be represented as in Equation (24). In Equation (24),  $f_2(g)$  is the carbon tax function and  $f_3(g)$  is the carbon emissions cost function, where  $f_2(g)$  and  $f_3(g)$  are the function of the company's total CE quantity ( $g$ ). LCE is the carbon emissions quantity that the company can emit, as limited or allocated by the government; MBCE is the maximum buyable CE quantity that the company can purchase in the market; LMCE is the company's maximum total CE quantity that the company can emit when the company purchases at MOQCE; LMPCE is the company's total CE quantity when the company purchases CR at the MBCE; and  $sr$  is the single carbon rights cost rate when the company purchases a CE quantity that is greater than MOQCE. That is, the carbon emissions cost includes only the carbon tax cost when  $0 \leq g \leq LCE$ . The carbon emissions cost includes the carbon tax cost  $f_2(g)$  and the fixed carbon rights cost at MOQCE (i.e., FCRC) when  $LCE \leq g \leq LMCE$ , and the carbon emissions cost includes the carbon tax cost  $f_2(g)$ , the fixed carbon rights cost at MOQCE (i.e., FCRC), and CRC over MOQCE [i.e.,  $sr * (g - MOQCE - LCE)$ ] when  $LMCE < g \leq LMPCE$ .

$$f_3(g) = \begin{cases} f_2(g), & \text{If } 0 \leq g \leq LCE \\ f_2(g) + FCRC, & \text{If } LCE \leq g \leq LMCE (= LCE + MOQCE) \\ f_2(g) + FCRC + sr * (g - MOQCE - LCE), & \text{If } LMCE < g \leq LMPCE (= LCE + MBCE) \end{cases} \quad (24)$$

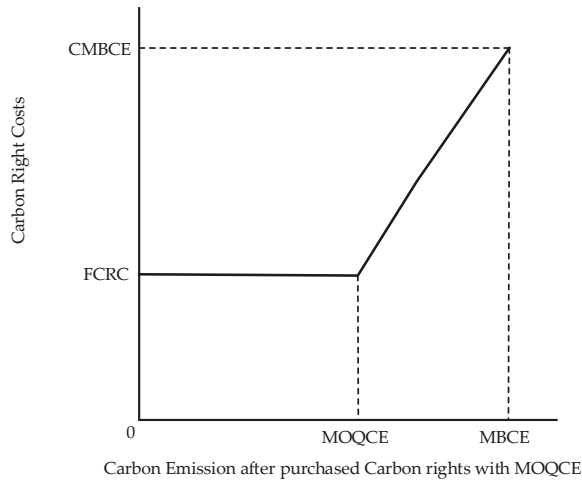

Figure 6. Piecewise linear function of carbon rights.

Equation (24) can be formulated as Equations (25)–(31) in the mathematical programming model. Equation (24) is the carbon emissions cost function of Model 3, and Equations (25)–(31) and (4)–(15) are the constraints associated with the carbon emissions cost function of Model 3.

Carbon emissions cost of Model 3:

$$CEC = \delta_1(CTC_1\mu_1 + CTC_2\mu_2 + CTC_3\mu_3) + \delta_{20}[(CTC_1\mu_1 + CTC_2\mu_2 + CTC_3\mu_3) + FCRC] + \delta_{21}[(CTC_1\mu_1 + CTC_2\mu_2 + CTC_3\mu_3) + FCRC + sr * (g - MOQCE - LCE)] \quad (25)$$

The associated constraints are:

$$g = \sum_{i=1}^n \sum_{m=1}^3 CE_{im}X_i = \phi_1 + \phi_{20} + \phi_{21} \quad (26)$$

$$0 \leq \phi_1 \leq \delta_1 LCE \tag{27}$$

$$\delta_{20} LCE < \phi_{20} \leq \delta_{20} LMCE \tag{28}$$

$$\delta_{21} LMCE < \phi_{21} \leq \delta_{21} LMPCE \tag{29}$$

$$\delta_1 + \delta_{20} + \delta_{21} = 1 \tag{30}$$

$$\delta_1, \delta_{20}, \delta_{21} = 0, 1, \tag{31}$$

where:

MOQCE	The minimum order quantity of carbon emissions.
FCRC	The fixed carbon rights cost at MOQCE.
LMCE	The company's maximum total CE quantity that the company can emit when the company purchases at MOQCE; LMCE = LCE + MOQCE.
MBCE	The maximum buyable CE quantity that the company can purchase in the market.
LMPCE	The company's total CE quantity when the company purchases carbon rights at the MBCE; LMPCE (= LCE + MBCE).
sr	The single carbon rights cost rate when the company purchases a CE quantity that is greater than MOQCE.
$\phi_1$	The company's total CE quantity when $g = \phi_1 \leq LCE$ .
$\phi_{20}$	The company's total CE quantity when $LCE \leq g = \phi_{20} \leq LMCE$ .
$\phi_{21}$	The company's total CE quantity when $LMCE < g = \phi_{21} \leq LMPCE$ .
$\delta_1, \delta_{20}, \delta_{21}$	A special ordered set of type 1 (SOS1) of 0–1 variables in which only one variable can be 1; $\delta_1 = 1$ means that the company does not need to purchase carbon rights; $\delta_{20} = 1$ means that the company needs to purchase carbon rights at MOQCE; and $\delta_{21} = 1$ means that the company needs to purchase carbon rights over MOQCE.

( $\delta_1, \delta_2, \delta_3$ ) is a special ordered set of type 1 (SOS1) of 0–1 variables in which only one variable can be 1. If  $\delta_1 = 1$ , then  $\delta_{20}, \delta_{21} = 0$ , from Equation (30), and  $0 \leq g = \phi_1 \leq LCE$  from Equations (26) and (27). This means that the company does not need to purchase CR. The total carbon emissions cost is  $(CTC_1\mu_1 + CTC_2\mu_2 + CTC_3\mu_3)$  from Equation (25), including only the carbon tax cost. If  $\delta_{20} = 1$ , then  $\delta_1 = \delta_{21} = 0$  from Equation (30), and  $LCE < g = \phi_{20} \leq LMCE$  from Equations (26) and (28). This means that the company needs to purchase CR at MOQEC. The total carbon emissions cost is  $[(CTC_1\mu_1 + CTC_2\mu_2 + CTC_3\mu_3) + FCRC]$  from Equation (25), including the carbon tax cost and the fixed carbon rights costs at MOQCE (i.e., FCRC). If  $\delta_{21} = 1$ , then  $\delta_1 = \delta_{20} = 0$  from Equation (30), and  $LMCE < g = \phi_{21} \leq LMPCE$  from Equations (26) and (29). This means that the company needs to purchase CR over MOQEC. The total carbon emissions cost is  $[(CTC_1\mu_1 + CTC_2\mu_2 + CTC_3\mu_3) + FCRC + (g - MOQCE - LCE) * sr]$  from Equation (25), including the carbon tax cost, the fixed carbon rights cost at MOQCE (i.e., FCRC), and the carbon rights cost over MOQCE (i.e.,  $sr * (g - MOQCE - LCE)$ ). The associated constraints associated with the carbon tax cost are given in Equations (4)–(15).

### 3.2. Unit Level—The Consumption of Direct Labor Cost Function

The direct labor of knitted production includes regular hours and overtime, which can be used in the activities of bottom trimming and assembling at the unit level activity. The cost of regular hours is fixed for the company in the short term, as the company needs to pay for these workers whether or not they are part of the workforce. However, the labor capacity could increase through overtime in the short term owing to rush orders or orders that cannot be completed on time.

In the production of knitted footwear, numerous manual processes have been changed and combined into a simple knitting activity, thereby reducing the number of direct labor hours (DLH) and the direct labor costs (DLC). Therefore, assume that the processes that require workers include bottom trimming ( $j = 4$ ) and assembling ( $j = 5$ ). The total direct labor cost (TDLC) function is a continuous

piecewise linear function, as shown in Figure 7. If the direct labor hours needed exceed the regular working hours, there will be two sets of labor hours paid at two different wage rates.

The direct labor cost function in Figure 7 can be formulated as in Equations (31)–(41) in the mathematical programming model. Equation (31) is the direct labor cost function that will be included in the objective function, and Equations (32)–(41) are the associated constraints. Assume that the wage rates in the three ranges of direct labor hours shown in Figure 7 are  $WR_0$ ,  $WR_1$ , and  $WR_2$ .

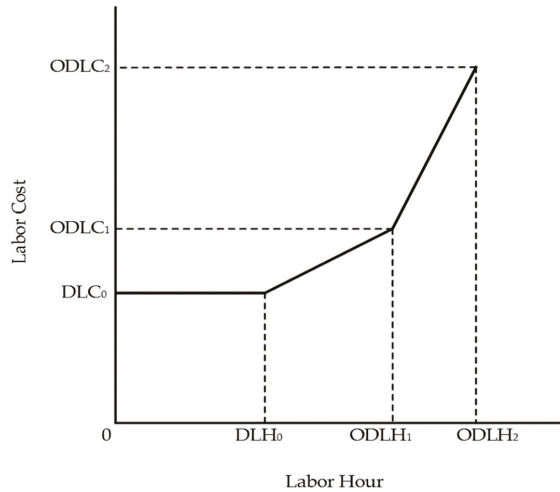

Figure 7. Total direct labor cost (TDLC) function.

Direct labor costs:

$$TDLC = DLC_0 + \gamma_1(ODLC_1 - DLC_0) + \gamma_2(ODLC_2 - DLC_0). \tag{31}$$

The associated constraints are:

$$TDLH = \sum_{i=1}^n (LH_{i4} + LH_{i5})X_i \leq \gamma_0 DLH_0 + \gamma_1(ODLH_1 - DLH_0) + \gamma_2(ODLH_2 - DLH_0) \tag{32}$$

$$\gamma_0 - \Gamma_1 \leq 0 \tag{33}$$

$$\gamma_1 - \Gamma_1 - \Gamma_2 \leq 0 \tag{34}$$

$$\gamma_2 - \Gamma_2 \leq 0 \tag{35}$$

$$\gamma_0 + \gamma_1 + \gamma_2 = 1 \tag{36}$$

$$\Gamma_1 + \Gamma_2 = 1 \tag{37}$$

$$\Gamma_1, \Gamma_2 = 0, 1 \tag{38}$$

$$0 \leq \gamma_0 \leq 1 \tag{39}$$

$$0 \leq \gamma_1 \leq 1 \tag{40}$$

$$0 \leq \gamma_2 \leq 1 \tag{41}$$

variables:

- $X_i$  The quantity of product  $i$ .
- $\gamma_0, \gamma_1, \gamma_2$  A set of non-negative variables of SOS2 (special ordered set of type 2).
- $\Gamma_1, \Gamma_2$  A set of 0–1 indicator variables of SOS1 (special ordered set of type 1).

parameters:

- $LH_{i4}$  The labor hours required for one unit of product  $i$  during the bottom trimming ( $j = 4$ ).
- $LH_{i5}$  The labor hours required for one unit of product  $i$  during the assembling ( $j = 5$ ).
- $DLH_0$  The total regular direct labor hours, as shown in Figure 7.
- $ODLH_1$  The highest overtime hours with the first overtime pay rate, as shown in Figure 7.
- $ODLH_2$  The highest overtime hours with the second overtime pay rate, as shown in Figure 7.
- $DLC_0$  The total regular direct labor costs at  $DLH_0$ , i.e.,  $DLC_0 = WR_0 * DLH_0$ .
- $ODLC_1$  The total regular direct labor costs at  $ODLH_1$ , i.e.,  $ODLC_1 = DLC_0 + WR_1 * (ODLH_1 - DLH_0)$ .
- $ODLC_2$  The total regular direct labor costs at  $ODLH_2$ , i.e.,  $ODLC_2 = ODLC_1 + WR_2 * (ODLH_2 - ODLH_1)$ .

$(\gamma_0, \gamma_1, \gamma_2)$  is a special ordered set of type 2 (SOS2) non-negative variables, and  $(\Gamma_1, \Gamma_2)$  is a special ordered set of type 1 (SOS1) 0–1 variables. If  $\Gamma_1 = 1$ , then  $\Gamma_2 = 0$  from Equation (37), and  $0 \leq \gamma_0, \gamma_1 \leq 1$  and  $\gamma_0 + \gamma_1 = 1$  from Equations (33), (34) and (36). Thus, the company’s total direct labor hour is  $[\gamma_0 DLH_0 + \gamma_1 (ODLH_1 - DLH_0)]$  from Equation (32) and the total direct labor cost is  $[DLC_0 + \gamma_1 (ODLC_1 - DLC_0)]$  from Equation (31). This means that the company’s direct labor hours fall within the second range of Figure 7, and (TDLH, TDLC) is the linear combination of  $(DLH_0, DLC_0)$  and  $(ODLH_1, ODLC_1)$ .

If  $\Gamma_2 = 1$ , then  $\Gamma_1 = 0$  from Equation (37), and  $0 \leq \gamma_1, \gamma_2 \leq 1$  and  $\gamma_1 + \gamma_2 = 1$  from Equations (34)–(36). Thus, the company’s total direct labor hours is  $[\gamma_1 (ODLH_1 - DLH_0) + \gamma_2 (ODLH_2 - DLH_0)]$  from Equation (32), and the total direct labor cost is  $[\gamma_1 (ODLC_1 - DLC_0) + \gamma_2 (ODLC_2 - DLC_0)]$  from Equation (31). This means that the company’s direct labor hours fall within the third range of Figure 7, and (TDLH, TDLC) is the linear combination of  $(ODLH_1, ODLC_1)$  and  $(ODLH_2, ODLC_2)$ .

If  $\gamma_0 = 1$  and  $\Gamma_1 = 1$ , then  $\gamma_1 = \gamma_2 = 0$  from Equation (36),  $\Gamma_2 = 0$  from Equation (37),  $TDLH = \sum_{i=1}^n (LH_{i4} + LH_{i5})X_i \leq \gamma_0 DLH_0$  from Equation (32), and  $TDLC = DLC_0$  from Equation (31). This means that the company’s direct labor hours fall within the first range of Figure 7 and the total direct labor cost is  $DLC_0$ .

### 3.3. Capacity of Machine Hours

Assume that the manufacturing process of knitted products in this study has three kinds of automatic machines that can replace manual activities to improve efficiency. The knitting machine is used to knit the vamp ( $j = 1$ ), the pressing machine is used to generate the shoe’s bottom ( $j = 2$ ), and the automatic gluing machine is used to assemble the vamps and bottoms to the footwear during assembling ( $j = 5$ ). Moreover, the three kinds of machines have upper limits for useable machine hours, facility regions, and worker usage. Assume that the other related costs are fixed at “ $\phi$ ”, including machine depreciation. The machine hour constraints are shown in Equations (42)–(44):

$$\sum_{i=1}^n MH_{i1}X_i \leq LMH_1 \tag{42}$$

$$\sum_{i=1}^n MH_{i2}X_i \leq LMH_2 \tag{43}$$

$$\sum_{i=1}^n MH_{i5}X_i \leq LMH_5, \tag{44}$$

where

$X_i$	The quantity of product i.
$MH_{11}$	The machine hours of the knitting machine required for one unit of product i.
$MH_{12}$	The machine hours of the pressing machine required for one unit of product i.
$MH_{15}$	The machine hours of the gluing machine required for one unit of product i.
$LMH_1$	The capability of machine hours for the knitting machine.
$LMH_2$	The capability of machine hours for the pressing machine.
$LMH_5$	The capability of machine hours for the gluing machine.

3.4. Batch-Level Activity Cost Function for Setup and Material Handling Activities

The model in this paper assumed there are three kinds of activities that can be classified as batch-level activities in the process of knitted shoes: molding the bottom ( $j = 3$ ), setting up ( $j = 6$ ) to produce different kinds of vamps or bottoms, and material handling ( $j = 7$ ). Let the set  $B = \{3, 6, 7\}$  for the batch-level activities. The overall batch-level activity costs can be represented as  $(\sum_{i=1}^n \sum_{j \in B} \Theta_j \Lambda_{ij} \beta_{ij})$ , which is included in the objective function of total profit. The associated constraints are as shown in Equations (45) and (46):

$$X_i \leq \Theta_{ij} \beta_{ij} \quad i = 1, 2, 3; \quad j \in B \tag{45}$$

$$\sum_{i=1}^n \Lambda_{ij} \beta_{ij} \leq T_j \quad \beta_{ij} \geq 0; \quad j \in B \tag{46}$$

where:

$X_i$	The quantity of product i.
$\beta_{ij}$	The number of batches of batch-level activity j ( $j \in B$ ) for product i.
$\Theta_{ij}$	The quantity of product i for each batch of batch-level activity j ( $j \in B$ ).
$\Lambda_{ij}$	The resource consumption of each batch of batch-level activity j ( $j \in B$ ) for product i.
$T_j$	The capacity of the activity driver of batch-level activity j ( $j \in B$ ).

Equation (45) is the constraint concerning the product’s quantity, which cannot be greater than the total quantity of all batches. Equation (46) is the constraint concerning the resource limitations ( $T_j$ ) for batch-level activity j.

3.5. Product-Level Activity Cost Function—Product Design

The company needs to produce different kinds of products in order to meet the various demands in the market. There are three styles of knitted footwear produced by the company, including Mary Janes (Product 1), dress athletic-inspired footwear (Product 2), and high-top footwear (Product 3), and the cost of product design was included in this study as a production-level activity. The overall product-level activity cost can be represented as  $(\sum_{i=1}^n \sum_{j \in P} MD_i \Pi_{ij} P_i)$ , which is included in the objective function of the total profit. The associated constraints are shown in Equations (47) and (48):

$$X_i \leq MD_i \alpha_i \quad i = 1, 2, 3; \tag{47}$$

$$\sum_{i=1}^n \Pi_{ij} \alpha_i \leq C_j \quad j \in P \tag{48}$$

where:

$X_i$	The quantity of product i.
$MD_i$	The market demand of product i.
$\alpha_i$	An indicator variable for whether product i is produced and sold; $\alpha_i = 1$ means that product i will be produced and sold, otherwise, $\alpha_i = 0$ .
$\Pi_{ij}$	The requirement of the activity driver of product-level activity j ( $j \in P$ ) for product i.
$C_j$	The capacity of the activity drivers for product-level activity j ( $j \in P$ ).

Equation (47) is the constraint concerning the product's quantity, which cannot be greater than the market demand of product  $i$ . Equation (48) is the constraint concerning the resource limitations ( $C_j$ ) for batch-level activity  $j$ .

### 3.6. Direct Material Costs

The manufacturers of knitted shoes in this study use thread, polyurethane (PU), and glue as the main direct materials in the three activities to produce knitted footwear: knitting ( $j = 1$ ), pressing ( $j = 2$ ), and assembling ( $j = 5$ ). The total material cost is  $[\sum_{i=1}^n (\sum_{k=1}^3 CM_k MR_{ik}) X_i]$ , which is included in the objective function of the total profit. The material constraint is shown in Equation (49):

$$\sum_{i=1}^n (MR_{ik} X_i) \leq MQ_k \quad k = 1, 2, 3 \quad (49)$$

where:

$X_i$	The quantity of product $i$ .
$CM_k$	The unit cost of material $k$ .
$MR_{ik}$	The quantity of material $k$ required for one unit of product $i$ .
$MQ_k$	The quantity of material $k$ available for production.

### 3.7. Assumptions

The activity-based costing (ABC) approach is used by manufacturers to get more accurate, detailed cost assignments for activities by using activity drivers [21], which can help manufacturers effectively collect and control relevant cost data [75–77]. Without a loss of generality, the Green Production Decision Model with Carbon Emissions (GPDME) proposed in this paper could be used to explore the impact of CE in the knitted footwear industry.

In the models explored in this paper, there were some assumptions. First, the overhead activities in GPDME were divided into the unit level, batch level, and product level [21] by the ABC approach, and their resources and activity drivers were also investigated and selected using the ABC approach [16,78]. Second, the capacity of machine hours was fixed for manufacturers in the short term. Third, depreciation and machine costs were considered as fixed costs, and there were limited machine hours for manufacturers to produce products. Fourth, overtime hours would be paid at a higher rate than normal labor hours. Fifth, the environmental issues considered in this paper were the effect on CE of carbon taxes and cap & trade. Sixth, the CE permits would not be sold to other companies after purchase. Seventh, GPDME is used because it gives data about the direct materials, direct labor, machining of products and so on that a manufacturer can use to produce final goods. We assume that these data can be collected to effectively reflect the manufacturing situation and that these data can help researchers to simulate the production process.

### 3.8. Objective Function

This paper proposed three models of GPDME combining ABC with TOC to achieve the optimal product mix and profit in the knitted footwear industry. These models were also used to explore the effect of carbon emissions. The objective function was to maximize total profit ( $\pi$ ):

$$\begin{aligned} \text{Maximize } \pi &= \text{total revenue of knitted footwear} - \text{total direct material costs} \\ &- \text{total direct labor costs} - \text{total batch level activity costs} \\ &- \text{total product level activity cost} - \text{total carbon emissions cost} \\ &- \text{total fixed costs (depreciation and other fixed cost)} \end{aligned}$$

3.8.1. Model 1: Carbon Emissions Costs without Carbon Trading

Model 1 considers only the carbon tax as the carbon emissions cost imposed by the government. The objective is to maximize the total profit, as shown in Equation (50). The associated constraints include Equations (4)–(16) and (32)–(49):

$$\begin{aligned} \text{Maximize } \pi &= \sum_{i=1}^n SP_i X_i - \sum_{i=1}^n \left( \sum_{k=1}^3 CM_k MR_{ik} \right) X_i - [DLC_0 + \gamma_1(ODLC_1 - DLC_0) \\ &+ \gamma_2(ODLC_2 - DLC_0)] - \sum_{i=1}^n \sum_{j \in \beta} \Theta_j \Lambda_{ij} \beta_{ij} - \sum_{i=1}^n \sum_{j \in P} MD_i \Pi_{ij} P_i - (CTC_1 \mu_1 \\ &+ CTC_2 \mu_2 + CTC_3 \mu_3) - F \end{aligned} \tag{50}$$

3.8.2. Model 2: Carbon Emissions Cost with Carbon Trading of a Single Carbon Rights Cost Rate

Model 2 considers the carbon emissions cost with carbon trading of a single CRC rate. The objective is to maximize the total profit, as shown in Equation (51). The associated constraints include Equations (4)–(15), (20)–(23) and (32)–(49):

$$\begin{aligned} \text{Maximize } \pi &= \sum_{i=1}^n SP_i X_i - \sum_{i=1}^n \left( \sum_{k=1}^3 CM_k MR_{ik} \right) X_i \\ &- [DLC_0 + \gamma_1(ODLC_1 - DLC_0) + \gamma_2(ODLC_2 - DLC_0)] \\ &- \sum_{i=1}^n \sum_{j \in \beta} \Theta_j \Lambda_{ij} \beta_{ij} - \sum_{i=1}^n \sum_{j \in P} MD_i \Pi_{ij} P_i \\ &- [(CTC_1 \mu_1 + CTC_2 \mu_2 + CTC_3 \mu_3) \delta_1 + ((CTC_1 \mu_1 + CTC_2 \mu_2 + CTC_3 \mu_3) \\ &+ (g - LCE * r) \delta_2)] - F \end{aligned} \tag{51}$$

3.8.3. Model 3: Carbon Emissions Cost with Carbon Trading of MOQCE

Model 3 considers the carbon emissions cost with carbon trading of MOQCE. The objective is to maximize the total profit, as shown in Equation (52). The associated constraints include Equations (4)–(14) and (26)–(49):

$$\begin{aligned} \text{Maximize } \pi &= \sum_{i=1}^n SP_i X_i - \sum_{i=1}^n \left( \sum_{k=1}^3 CM_k MR_{ik} \right) X_i \\ &- [DLC_0 + \gamma_1(ODLC_1 - DLC_0) + \gamma_2(ODLC_2 - DLC_0)] - \sum_{i=1}^n \sum_{j \in \beta} \Theta_j \Lambda_{ij} \beta_{ij} \\ &- \sum_{i=1}^n \sum_{j \in P} MD_i \Pi_{ij} P_i - \delta_1 (CTC_1 \mu_1 + CTC_2 \mu_2 + CTC_3 \mu_3) \\ &+ \delta_{20} [(CTC_1 \mu_1 + CTC_2 \mu_2 + CTC_3 \mu_3) + FCRC] \\ &+ \delta_{21} [(CTC_1 \mu_1 + CTC_2 \mu_2 + CTC_3 \mu_3) + FCRC + (g - MOQCE - LCE) * sr] \\ &- F \end{aligned} \tag{52}$$

4. Illustration

4.1. Illustrative Data and Optimal Decision Analysis

The models assumed that a manufacturer of knitted shoes would have relevant costs that include: (1) unit-level activity costs, in which there are three styles of direct material costs and the labor cost; (2) batch-level activity costs, which include the costs of molding, setting up the general footwear-making process, and material handling; (3) the product-level activity cost, which is the design cost; (4) CEC, which includes the CTC and CR costs; and (5) fixed costs, including the depreciation, machine-related costs, and other facility costs in the models. The parameters used in this paper are all shown in Table 1.



Table 1. GPDME with carbon tax cost and carbon rights costs (\$/NT).

				Product1 (i = 1)	Product 2 (i = 2)	Product 3 (i = 3)	Available Capacity
<b>Selling Price (SP)</b>				\$1705	\$1974	\$2178	
<b>Material (Unit-level)</b>							
	k = 1 (thread)	A <sub>1</sub> = \$58/unit	j	P <sub>1</sub>			
	k = 2 (Polyurethane (PU))	A <sub>2</sub> = \$116/unit		MR <sub>11</sub>	1.5	2	MQ <sub>1</sub> = 265,938
	k = 3 (Glue)	A <sub>3</sub> = \$39/unit		MR <sub>2</sub>	2	2	MQ <sub>2</sub> = 364,000
				MR <sub>3</sub>	0.5	1.2	MQ <sub>3</sub> = 156,000
<b>Unit-level activity</b>							
Labor hours	j = 4 (Trimming)		4	LH <sub>4</sub>	0.30	0.40	
	j = 5 (Assembling)		5	LH <sub>5</sub>	1.50	1.60	
Machine hours	j = 1 (Knitting)		1	MH <sub>1</sub>	4	8	LMH <sub>1</sub> = 401,500
	j = 2 (Pressing)		2	MH <sub>2</sub>	0.14	0.2	LMH <sub>2</sub> = 24,024
	j = 5 (Assembling)		5	MH <sub>5</sub>	0.4	0.5	LMH <sub>5</sub> = 64,064
<b>Batch-level activity</b>							
Molding	Activity-driver						
	Molding hours	d <sub>3</sub> = \$100/h	3	Θ <sub>13</sub>	2	2	T <sub>3</sub> = 120,900
				Λ <sub>13</sub>	3	2	
Set up	Set Up hours	d <sub>6</sub> = \$40/h	6	Θ <sub>16</sub>	3	2	T <sub>6</sub> = 713,284
				Λ <sub>16</sub>	3	2	
Material handling	Handling hours	d <sub>7</sub> = \$15/h	7	Θ <sub>17</sub>	4	3	T <sub>7</sub> = 436,800
				Λ <sub>17</sub>	4	3	
				Π <sub>ij</sub>	1500	5000	C <sub>8</sub> = 10,000
<b>Patch-level activity</b>							
<b>Direct Labor constraint cost</b>	Designing	E <sub>8</sub> = \$150	8				
	DLC <sub>0</sub> = \$20,891,640	DLC <sub>1</sub> = \$6,946,470	DLC <sub>2</sub> = 153,616,501				
	DLH <sub>0</sub> = 157,080	ODLH <sub>1</sub> = 39,270	ODLH <sub>2</sub> = 78,540				
	Wage rate	WR <sub>0</sub> = \$133/h	WR <sub>2</sub> = \$221/h				
<b>Carbon emissions cost</b>							
Carbon emission	j = 1 (Knitting)			CE <sub>1</sub>	0.53	1.43	
	j = 2 (Pressing)			CE <sub>2</sub>	0.35	0.95	
	j = 5 (Assembling)			CE <sub>5</sub>	0.89	2.39	
<b>Carbon Tax cost</b>							
Emissions Quantity	CTC <sub>1</sub> = \$33,000	CTC <sub>2</sub> = \$143,000	CTC <sub>3</sub> = \$143,832,000				
Tax rate	UCE <sub>1</sub> = 150,000 kg	UCE <sub>2</sub> = 400,000 kg	UCE <sub>3</sub> = 221,460,000 kg				
	TR <sub>1</sub> = \$0.22/kg	TR <sub>2</sub> = \$0.44/kg	TR <sub>3</sub> = \$0.65/kg				
<b>Carbon rights cost</b>	UCRC = \$78,000	FCRC = \$59,000	CMBCE = \$45,000				
	UPCE = 200,000 kg	MQOCE = 100,000 kg	MBCR = 100,000 kg				LCE = 250,000
	r = \$0.39/kg		sr = 0.45				

We assumed that the unit prices of these products were separate (Product 1 = \$1705 NT, Product 2 = \$1974 NT, and Product 3 = \$2178 NT), as were the wage rates in the labor costs ( $WR_0 = \$133/h$ ,  $WR_1 = \$177/h$ , and  $WR_2 = \$221/h$ ). The CT collection system adopted the piecewise linear function using tax rates of \$0.22/kg ( $TR_1$ ), \$0.44/kg ( $TR_2$ ), and \$0.65/kg ( $TR_3$ ), respectively. The objectives of GPDME for the illustrative data of Table 1 are shown in Tables 2–4. The objective functions included three kinds of CEC functions based on Equations (3), (17), and (34) separately, as well as the constraints of the CE function, which were based on Equations (4)–(14), (18)–(22) and (25)–(30), respectively. The constraints of GPDME are presented in Table 5.

**Table 2.** Objective function for illustrative data without carbon trading for Model 1.

$$\pi = (1705X_1 + 1974X_2 + 2178X_3) - [(58 + 231 + 20)X_1 + (87 + 231 + 39)X_2 + (116 + 231 + 47)X_3] - (20,891,640 + 6,946,470\gamma_1 + 15,616,501\gamma_2) - [(2 \times 100)\beta_{13} + (2 \times 100)200\beta_{23} + (2 \times 100)\beta_{33}] - [(6 \times 40)\beta_{16} + (3 \times 40)\beta_{26} + (2 \times 40)\beta_{36}] + [(6 \times 15)\beta_{17} + (4 \times 15)\beta_{27} + (3 \times 15)\beta_{37}] - (450,000P_1 + 225,000P_2 + 750,000P_3) - [(33,000\mu_1 + 143,000\mu_2 + 143,832,000\mu_3) - 44,996,392];$$

Carbon tax constraints

$$(1.77X_1 + 3.27X_2 + 4.77X_3) = 150,000\mu_1 + 400,000\mu_2 + 221,460,000\mu_3;$$

$$\mu_0 - \theta_1 \leq 0;$$

$$\mu_1 - \theta_1 - \theta_2 \leq 0;$$

$$\mu_2 - \theta_2 - \theta_3 \leq 0;$$

$$\mu_3 - \eta_3 \leq 0;$$

$$\mu_0 + \mu_1 + \mu_2 + \mu_3 = 1;$$

$$\eta_1 + \eta_2 + \eta_3 = 1$$

**Table 3.** Objective function for carbon trading with a single carbon rights rate for Model 2.

$$\pi = (1705X_1 + 1974X_2 + 2178X_3) - [(58 + 231 + 20)X_1 + (87 + 231 + 39)X_2 + (116 + 231 + 47)X_3] - (20,891,640 + 6,946,470\gamma_1 + 15,616,501\gamma_2) - [(2 \times 100)\beta_{13} + (2 \times 100)200\beta_{23} + (2 \times 100)\beta_{33}] - [(6 \times 40)\beta_{16} + (3 \times 40)\beta_{26} + (2 \times 40)\beta_{36}] + [(6 \times 15)\beta_{17} + (4 \times 15)\beta_{27} + (3 \times 15)\beta_{37}] - (450,000P_1 + 225,000P_2 + 750,000P_3) - [(33,000\mu_1 + 143,000\mu_2 + 143,832,000\mu_3)\delta_1 - ((33,000\mu_1 + 143,000\mu_2 + 143,832,000\mu_3) - (\phi_1 + \phi_2 - 250,000) \times 0.39)\delta_2] - 44,996,392;$$

Carbon tax constraints

$$r(1.77X_1 + 3.27X_2 + 4.77X_3) = 150,000\mu_1 + 400,000\mu_2 + 221,460,000\mu_3;$$

$$r\mu_0 - \theta_1 \leq 0;$$

$$r\mu_1 - \theta_1 - \theta_2 \leq 0;$$

$$r\mu_2 - \theta_2 - \theta_3 \leq 0;$$

$$r\mu_3 - \eta_3 \leq 0;$$

$$r\mu_0 + \mu_1 + \mu_2 + \mu_3 = 1;$$

$$r\eta_1 + \eta_2 + \eta_3 = 1;$$

Carbon rights constraints

$$r(1.77X_1 + 3.27X_2 + 4.77X_3) = \phi_1 + \phi_2;$$

$$r\phi_1 \leq \delta_1 250,000;$$

$$r\delta_2 250,000 < \phi_2;$$

$$r\phi_2 \leq \delta_2 450,000;$$

$$r\delta_1 + \delta_2 = 1$$

**Table 4.** Objective function for carbon trading including MOQCE for Model 3.

$$\pi = (1705X_1 + 1974X_2 + 2178X_3) - [(58 + 231 + 20)X_1 + (87 + 231 + 39)X_2 + (116 + 231 + 47)X_3] - (20,891,640 + 6,946,470\gamma_1 + 15,616,501\gamma_2) - [(2 \times 100)\beta_{13} + (2 \times 100)200\beta_{23} + (2 \times 100)\beta_{33}] - [(6 \times 40)\beta_{16} + (3 \times 40)\beta_{26} + (2 \times 40)\beta_{36}] + [(6 \times 15)\beta_{17} + (4 \times 15)\beta_{27} + (3 \times 15)\beta_{37}] - (450,000P_1 + 225,000P_2 + 750,000P_3) - [(33,000\mu_1 + 143,000\mu_2 + 143,832,000\mu_3)\delta_1 + ((33,000\mu_1 + 143,000\mu_2 + 143,832,000\mu_3) + 390,000)\delta_{20} + ((33,000\mu_1 + 143,000\mu_2 + 143,832,000\mu_3) + 390,000 + (\phi_1 + \phi_{20} + \phi_{21} - 100,000 - 250,000) \times 0.45)\delta_{21}] - 44,996,392;$$

Carbon tax constraints

$$r(1.77X_1 + 3.27X_2 + 4.77X_3) = 150,000\mu_1 + 400,000\mu_2 + 221,460,000\mu_3;$$

$$r\mu_0 - \theta_1 \leq 0;$$

$$r\mu_1 - \theta_1 - \theta_2 \leq 0;$$

$$r\mu_2 - \theta_2 - \theta_3 \leq 0;$$

$$r\mu_3 - \eta_3 \leq 0;$$

$$r\mu_0 + \mu_1 + \mu_2 + \mu_3 = 1;$$

$$r\eta_1 + \eta_2 + \eta_3 = 1$$

Carbon rights constraints

$$(1.77X_1 + 3.27X_2 + 4.77X_3) = \phi_1 + \phi_{20} + \phi_{21};$$

$$\phi_1 \leq \delta_1 250,000;$$

$$\delta_{20} 250,000 < \phi_{20};$$

$$\phi_{20} \leq \delta_{20} 350,000;$$

$$\delta_{21} 350,000 < \phi_{21};$$

$$\phi_{21} \leq \delta_{21} 450,000$$

$$\delta_1 + \delta_{20} + \delta_{21} = 1$$

**Table 5.** Constraints of GPDMCE.

---

Subject to:

Direct material constraints

$$r1X_1 + 1.5X_2 + 2X_3 \leq 265,938$$

$$r2X_1 + 2X_2 + 2X_3 \leq 364,000$$

$$r0.5X_1 + 1X_2 + 1.2X_3 \leq 156,000$$

Direct labor constraints

$$r(1X_1 + 1.8X_2 + 2X_3) \leq (\gamma_0 157,080 + \gamma_1 39,270 + \gamma_2 78,540)$$

$$r\gamma_0 - \Gamma_1 \leq 0$$

$$r\gamma_1 - \Gamma_1 - \Gamma_2 \leq 0$$

$$r\gamma_2 - \Gamma_2 \leq 0$$

$$r\gamma_0 + \gamma_1 + \gamma_2 = 1$$

$$r\Gamma_1 + \Gamma_2 = 1$$

Machine hour constraints

$$r1X_1 + 4X_2 + 8X_3 \leq 401,500$$

$$r0.1X_1 + 0.14X_2 + 0.2X_3 \leq 24,024$$

$$r0.2X_1 + 0.4X_2 + 0.5X_3 \leq 64,064$$

Batch-level activity constraints (Molding)

$$rX_1 - 4\beta_{13} \leq 0$$

$$rX_2 - 3\beta_{23} \leq 0$$

$$rX_3 - 2\beta_{33} \leq 0$$

$$r2\beta_{13} + 2\beta_{23} + 2\beta_{33} \leq 120,900$$

Batch-level activity constraints (Set-up)

$$rX_1 - 1\beta_{16} \leq 0$$

$$rX_2 - 3\beta_{26} \leq 0$$

$$rX_3 - 4\beta_{36} \leq 0$$

$$r6\beta_{16} + 3\beta_{26} + 2\beta_{36} \leq 713,284$$

Batch-level activity constraints (Material handling)

$$rX_1 - 2\beta_{17} \leq 0$$

$$rX_2 - 3\beta_{27} \leq 0$$

$$rX_3 - 4\beta_{27} \leq 0$$

$$r6\beta_{17} + 4\beta_{27} + 3\beta_{37} \leq 436,800$$

Product-level activity constraints (Designing)

$$rX_1 - 100,000P_1 \leq 0;$$

$$rX_2 - 25,000P_2 \leq 0;$$

$$rX_3 - 30,000P_3 \leq 0;$$

$$r3000P_1 + 1500P_2 + 5000P_3 \leq 100,000;$$

---

#### 4.2. Analyzing the Optimal Solution

GPDMCE in this study integrated the ABC, TOC, and CEC concepts in order to achieve profit maximization under various resource constraints. The results of GPDMCE were analyzed using LINGO 16 software based on the data of the parameters shown in Table 1. The unknown figures included the maximum profit of the best product mix, total revenue, number of products, TDLC, the cost at the batch level and product level, as well as CEC. The optimal solutions of the three models are presented in Tables 6–8, which could be used to explore the different effects between purchasing and not purchasing carbon rights in the market for manufacturers.

##### 4.2.1. Carbon Tax Cost Function—Model 1

The optimal solution of GPDMCE without carbon trading is presented in Table 6. The results indicated that the maximum profit of the best product mix was (\$110,765,700 NT). The total revenue was (\$224,981,962 NT), which consisted of (\$139,643,348 NT for Product 1, \$40,414,436 NT for Product 2, and \$44,924,179 NT for Product 3). The product quantities were (100,000; 24,999; and 25,188), respectively, which required quantities of vamps (100,000; 37,499; 50,376), bottoms (200,000; 24,999; 50,376), and glue (50,000; 24,999; 30,226). TDLC was (\$27,665,501 NT) and consisted of the costs of normal labor hours (\$20,891,640 NT) and overtime working hours (\$6,773,861 NT). TDLH was (195,374). The machine

hours of the three kinds of machines used for the three kinds of products were (100,000; 99,996; 201,504 for the knitting machines, (100,000; 3500; 5038) for the pressing machines, and (20,000; 10,000; 12,594) for assembling, respectively. The total batch-level activity cost was (\$39,972,465 NT). The batch-level activities consumed (91,854) machine hours for the molding activity, (637,593) set-up hours for the set-up activity, and (352,223) handling hours for material handling. The total product-level activity cost was (\$1,425,000 NT). The total CTC was (\$133,713/NT) the total CE was (378,894 kg), and the CO<sub>2</sub> emissions quantities for Product 1, Product 2, and Product 3 were (177,000 kg), (81,747 kg), and (120,147 kg), respectively.

**Table 6.** The optimal solution of GPDMCE with carbon tax (\$NT).

$\pi$	\$110,765,700	$X_1$	100,000	$X_2$	24,999
$X_3$	25,188	$\bar{a}_0$	0.02	$\bar{a}_1$	0.98
$\bar{a}_2$	0	$\bar{A}_1$	1	$\bar{A}_2$	0
$\beta_{12}$	25,000	$\beta_{14}$	100,000	$\beta_{15}$	50,000
$\beta_{22}$	8333	$\beta_{24}$	8333	$\beta_{35}$	8333
$\beta_{32}$	12,594	$\beta_{34}$	6297	$\beta_{35}$	6297
$P_1$	1	$P_2$	1	$P_3$	1
$i_0$	0	$i_1$	0.08	$i_2$	0.92
$i_3$	0	$e_1$	0	$e_2$	1
$e_3$	0				

4.2.2. Carbon Emissions Cost Function with a Single Rate of Carbon Rights—Model 2

The optimal solution of GPDMCE with carbon trading is presented in Table 7. The maximum profit of Model 2 was (\$110,715,500 NT). The total revenue was (\$224,981,962 NT), which consisted of (\$139,643,348 NT for Product 1, \$40,414,436 NT for Product 2, and \$44,924,179 NT for Product 3). The product quantities were (100,000; 24,999; and 25,188), respectively, which required (187,875) vamps; (300,374) bottoms; and (105,225) units of glue. TDLC was (\$27,665,501 NT) and consisted of the costs of normal labor hours (\$20,891,640 NT) and overtime working hours (\$6,773,861 NT), and TDLH was (195,374). The three kinds of machine hours used for the three kinds of products were (401,500) for the knitting machines, (18,537) for the pressing machines, and (42,594) for the assembling machines, respectively. The total batch-level activity cost was (\$39,972,465 NT), and the batch-level activities consumed (91,854) molding hours for the molding activity, (637,593) set-up hours for the set-up activity, and (352,223) handling hours for material handling. The total product-level activity cost was (\$1,425,000 NT). The total CTC was (\$133,713 NT), and the CR cost was (\$11,268 NT). The total CE was (378,893 kg).

**Table 7.** The optimal solution of GPDMCE with single rate of carbon rights (\$NT).

$\pi$	\$110,715,500	$X_1$	100,000	$X_2$	24,999
$X_3$	25,188	$\gamma_0$	0.02	$\gamma_1$	0.98
$\gamma_2$	0	$\bar{A}_1$	1	$\bar{A}_2$	0
$\beta_{12}$	25,000	$\beta_{14}$	100,000	$\beta_{15}$	50,000
$\beta_{22}$	8333	$\beta_{24}$	8333	$\beta_{35}$	8333
$\beta_{32}$	12,594	$\beta_{34}$	6297	$\beta_{35}$	6297
$P_1$	1	$P_2$	1	$P_3$	1
$i_0$	0	$i_1$	0.08	$i_2$	0.92
$i_3$	0	$\theta_1$	0	$\theta_2$	1
$\theta_3$	0	$\ddot{o}_1$	0	$\ddot{o}_2$	378,894
$\bar{a}_1$	0	$\bar{a}_2$	1		

4.2.3. Carbon Emissions Cost Function with MOQCE—Model 3

The maximum profit of Model 3 with MOQCE was (\$110,715,500 NT), and the total revenue was (\$224,981,962 NT). The product quantities were (100,000; 24,999; 25,188) respectively. TDLC was (\$27,665,501 NT) and TDLH was (195,374). The machine hours for the three kinds of machines used

for the three kinds of products were (401,500) for the knitting machines, (18,537) for the pressing machines, and (42,594) for the assembling machines, respectively. The total batch-level activity cost was (\$39,972,465 NT). The batch-level activities consumed (91,854) machine hours for pressing activity, (637,593) set-up hours for set-up activity, and (352,223) handling hours for material handling. The total product-level activity cost was (\$1,425,000). The total CTC was (\$185,715 NT), and the CR cost was (\$52,002 NT). The total CE was (378,893 kg).

**Table 8.** The optimal solution of GPDMCE with MOQCE (\$NT).

$\pi$	\$110,668,700	$X_1$	100,000	$X_2$	24,999
$X_3$	25,188	$\gamma_0$	0.02	$\gamma_1$	0.98
$\gamma_2$	0	$A_1$	1	$A_2$	0
$\beta_{12}$	25,000	$\beta_{14}$	100,000	$\beta_{15}$	50,000
$\beta_{22}$	8333	$\beta_{24}$	8333	$\beta_{35}$	8333
$\beta_{32}$	12,594	$\beta_{34}$	6297	$\beta_{35}$	6297
$P_1$	1	$P_2$	1	$P_3$	1
$i_0$	0	$i_1$	0.08	$i_2$	0.92
$i_3$	0	$\theta_1$	0	$\theta_2$	1
$\theta_3$	0	$\delta_1$	0	$\delta_{20}$	0
$\delta_{21}$	378,894	$\delta_{21}$	0	$\delta_{20}$	0
$\delta_{21}$	1				

### 5. Conclusions

In a fast and constantly evolving fashion environment, companies need to produce the right products to comply with consumer demand [79]. Recently, the manufacturing model has changed from a traditional manufacturing process to an intelligent production process, because companies need to be more competitive to face the complicated challenges of material, labor, and environment problems, including water and air pollution [80]. The purpose of this paper was to explore the effect of carbon emissions (CE), including carbon taxes (CT) and carbon rights (CR) issues. The production and materials of knitted shoes could reduce the environmental impact and amount of waste created, decrease company costs [42], and reduce the number of skilled laborers that complex processes depend on. Nowadays, the production of knitted shoes can show a decrease in the number of manufacturing activities and reduced human error in the processes.

This study proposed a mathematical programming model that considers CE and related costs through integrating ABC and TOC, which could improve the efficiency of operations and improve profit by a variety of product mixes. The combination of the ABC and TOC approaches could help companies to effectively control costs and increase profits through the mathematical programming model [15,81–83]. Therefore, this study developed the Green Production Decision Model with Carbon Emissions (GPDMCE), which used the technique of managerial accounting in TOC to control related costs and achieve profit maximization [84].

GPDMCE considers the long-term allocation of resources and short-term labor hour capacity expansion. GPDMCE also incorporates the carbon tax and carbon rights cost (CRC) into the model. It utilizes a continuous piecewise linear function with two different higher wage rates to estimate the labor cost. GPDMCE could help footwear manufacturers establish more effective product mixes and reduce costs to improve profit. Moreover, this paper developed three kinds of models to consider the possibilities of carbon trading in the market. For manufacturers, it not only directly considered the effect of CT but also the influence on processes separately through three kinds of situations.

The first model only considered the effect of imposed CT. There are government restrictions on the quantity of CE to prevent corporations from generating excessive CE. Thus, manufacturers need to decrease capacity because they do not have a high enough CE quota to use in the situation. They are not allowed to purchase additional CR because CE is limited by the government. Models 2 and 3 addressed situations in which corporations can purchase CR in the market by different functions of the CRC, which allow them to gain additional CE rights by purchasing CR.

This study tested the three models and found that the main factor affecting production is not the CT imposed by the government but rather the restricted quantity of the CE permits allocated by the government. On the other hand, the cost of CE for manufacturers is affordable, no matter which method they choose (collecting CT or purchasing CR from the market). Thus, manufacturers will produce the quantity of products for their benefit and not consider decreasing CE to protect the environment. According to previous research, decreasing CE from production is more effective through Total Quantity Control (TQC) for carbon emissions than through price changes of CT or CR [35,36].

Therefore, governmental policy makers should know that controlling CE through TQC is a better policy to control carbon emissions and protect the natural environment. Controlling CE through TQC can also improve issues of environmental degradation by forcing manufacturers to manufacture products based on the restricted quota of CE. Manufacturers will then try their best to find methods of improving production processes, equipment, or materials in order to achieve the maximum profit under the restricted quota of carbon emissions.

The contributions of our research are: First, we successfully establish models that can effectively estimate CE and CTC with an ABC approach in the footwear industry. The manufacturer's production is affected by the quantity of CE because CE is a factor of production, and CTC would reduce profit maximization. Therefore, these factors encourage manufacturers to change their production methods to satisfy consumers' expectations and maximize profit. Second, we consider the possibility of CR in carbon trading. We add CR to estimate CEC instead of only considering the effect of CT for a manufacturer. In the three models explored in this paper, the manufacturer can search for the best way to design products and production to decrease the effect on the environment and increase profits. Finally, we provide evidence that the best way for policy makers to decrease CE is to directly control the quantity of CE by TQC instead of adopting CT to change the behavior of manufacturers.

If the GPDMC models proposed in this paper are applied to other industries, the carbon emissions cost functions still can be used in other industries. However, the product prices, direct material costs, direct labor costs, and ABC activity costs in the objective function and the constraints should be revised according to the industry and the company being studied.

**Author Contributions:** W.-H.T. provided the research idea, the research purpose, and the research design; S.-Y.J. collected and analyzed the data and wrote the paper; W.-H.T. provided the research method, supervised, corrected, and revised this paper. All authors have read and approved the final manuscript.

**Funding:** This research was funded by the Ministry of Science and Technology of Taiwan under Grant No. MOST106-2410-H-008-020-MY3.

**Acknowledgments:** The authors are extremely grateful to the *sustainability* journal editorial team and reviewers who provided valuable comments for improving the quality of this article. The authors also would like to thank the Ministry of Science and Technology of Taiwan for financially supporting this research under Grant No. MOST-106-2410-H-008-020-MY3.

**Conflicts of Interest:** The author declares no conflict of interest.

## References

1. IPCC. *Climate Change 2007: The Physical Science Basis*; IPCC: Geneva, Switzerland, 2007; Volume 6, p. 333.
2. Maciel, V.G.; Bockorny, G.; Domingues, N.; Scherer, M.B.; Zortea, R.B.; Seferin, M. Comparative Life Cycle Assessment among Three Polyurethane Adhesive Technologies for the Footwear Industry. *ACS Sustain. Chem. Eng.* **2017**, *5*, 8464–8472. [CrossRef]
3. Staikos, T.; Heath, R.; Haworth, B.; Rahimifard, S. *End-of-Life Management of Shoes and the Role of Biodegradable Materials*; Loughborough University: Loughborough, UK, 2006.
4. IPCC. *Climate Change 2014: Mitigation of Climate Change*; Cambridge University Press: Cambridge, UK, 2015; Volume 3.
5. Weib, M. Recycling Alter Schuhe. *Suchuh-Technik*, May–June 1999, pp. 26–29.
6. Du, S.; Tang, W.; Song, M. Low-carbon production with low-carbon premium in cap-and-trade regulation. *J. Clean. Prod.* **2016**, *134*, 652–662. [CrossRef]

7. Wang, Q.; Zhao, D.; He, L. Contracting emission reduction for supply chains considering market low-carbon preference. *J. Clean. Prod.* **2016**, *120*, 72–84. [[CrossRef](#)]
8. Kotchen, M.J. Impure public goods and the comparative statics of environmentally friendly consumption. *J. Environ. Econ. Manag.* **2005**, *49*, 281–300. [[CrossRef](#)]
9. Motoshita, M.; Sakagami, M.; Kudoh, Y.; Tahara, K.; Inaba, A. Potential impacts of information disclosure designed to motivate Japanese consumers to reduce carbon dioxide emissions on choice of shopping method for daily foods and drinks. *J. Clean. Prod.* **2015**, *101*, 205–214. [[CrossRef](#)]
10. Kong, G.; White, R. Toward cleaner production of hot dip galvanizing industry in China. *J. Clean. Prod.* **2010**, *18*, 1092–1099. [[CrossRef](#)]
11. Puurunen, K.; Vasara, P. Opportunities for utilising nanotechnology in reaching near-zero emissions in the paper industry. *J. Clean. Prod.* **2007**, *15*, 1287–1294. [[CrossRef](#)]
12. Giarola, S.; Shah, N.; Bezzo, F. A comprehensive approach to the design of ethanol supply chains including carbon trading effects. *Bioresour. Technol.* **2012**, *107*, 175–185. [[CrossRef](#)] [[PubMed](#)]
13. Zhang, B.; Xu, L. Multi-item production planning with carbon cap and trade mechanism. *Int. J. Prod. Econ.* **2013**, *144*, 118–127. [[CrossRef](#)]
14. De Beer, P.; Friend, F. Environmental accounting: A management tool for enhancing corporate environmental and economic performance. *Ecol. Econ.* **2006**, *58*, 548–560. [[CrossRef](#)]
15. Tsai, W.-H.; Chang, Y.-C.; Lin, S.-J.; Chen, H.-C.; Chu, P.-Y. A green approach to the weight reduction of aircraft cabins. *J. Air Transp. Manag.* **2014**, *40*, 65–77. [[CrossRef](#)]
16. Tsai, W.-H.; Chen, H.-C.; Leu, J.-D.; Chang, Y.-C.; Lin, T.W. A product-mix decision model using green manufacturing technologies under activity-based costing. *J. Clean. Prod.* **2013**, *57*, 178–187. [[CrossRef](#)]
17. Tsai, W.-H.; Yang, C.-H.; Huang, C.-T.; Wu, Y.-Y. The impact of the carbon tax policy on green building strategy. *J. Environ. Plan. Manag.* **2017**, *60*, 1412–1438. [[CrossRef](#)]
18. Tsai, W.-H.; Lin, T.W.; Chou, W.-C. Integrating activity-based costing and environmental cost accounting systems: A case study. *Int. J. Bus. Syst. Res.* **2010**, *4*, 186–208. [[CrossRef](#)]
19. Tsai, W.-H.; Hsu, J.-L.; Chen, C.-H.; Lin, W.-R.; Chen, S.-P. An integrated approach for selecting corporate social responsibility programs and costs evaluation in the international tourist hotel. *Int. J. Hosp. Manag.* **2010**, *29*, 385–396. [[CrossRef](#)]
20. Tsai, W.-H.; Shen, Y.-S.; Lee, P.-L.; Chen, H.-C.; Kuo, L.; Huang, C.-C. Integrating information about the cost of carbon through activity-based costing. *J. Clean. Prod.* **2012**, *36*, 102–111. [[CrossRef](#)]
21. Tsai, W.-H.; Yang, C.-H.; Chang, J.-C.; Lee, H.-L. An Activity-Based Costing decision model for life cycle assessment in green building projects. *Eur. J. Oper. Res.* **2014**, *238*, 607–619. [[CrossRef](#)]
22. Tsai, W.-H.; Chang, J.-C.; Hsieh, C.-L.; Tsaur, T.-S.; Wang, C.-W. Sustainability Concept in Decision-Making: Carbon Tax Consideration for Joint Product Mix Decision. *Sustainability* **2016**, *8*, 1232. [[CrossRef](#)]
23. Tsai, W.-H.; Tsaur, T.-S.; Chou, Y.-W.; Liu, J.-Y.; Hsu, J.-L.; Hsieh, C.-L. Integrating the activity-based costing system and life-cycle assessment into green decision-making. *Int. J. Prod. Res.* **2015**, *53*, 451–465. [[CrossRef](#)]
24. Zhou, P.; Wang, M. Carbon dioxide emissions allocation: A review. *Ecol. Econ.* **2016**, *125*, 47–59. [[CrossRef](#)]
25. Zhou, P.; Zhang, L.; Zhou, D.Q.; Xia, W.J. Modeling economic performance of interprovincial CO<sub>2</sub> emission reduction quota trading in China. *Appl. Energy* **2013**, *112*, 1518–1528. [[CrossRef](#)]
26. Schmidt, R.C.; Heitzig, J. Carbon leakage: Grandfathering as an incentive device to avert firm relocation. *J. Environ. Econ. Manag.* **2014**, *67*, 209–223. [[CrossRef](#)]
27. Rose, A.; Zhang, Z.X. Interregional burden-sharing of greenhouse gas mitigation in the United States. *Mitig. Adapt. Strateg. Glob. Chang.* **2004**, *9*, 477–500. [[CrossRef](#)]
28. Luzzati, T.; Gucciardi, G. A non-simplistic approach to composite indicators and rankings: An illustration by comparing the sustainability of the EU countries. *Ecol. Econ.* **2015**, *113*, 25–38. [[CrossRef](#)]
29. Pang, R.Z.; Deng, Z.Q.; Chiu, Y.H. Pareto improvement through a reallocation of carbon emission quotas. *Renew. Sust. Energ. Rev.* **2015**, *50*, 419–430. [[CrossRef](#)]
30. Gomes, E.G.; Lins, M.P.E. Modelling undesirable outputs with zero sum gains data envelopment analysis models. *J. Oper. Res. Soc.* **2008**, *59*, 616–623. [[CrossRef](#)]
31. Filar, J.A.; Gaertner, P.S. A regional allocation of world CO<sub>2</sub> emission reductions. *Math. Comput. Simul.* **1997**, *43*, 269–275. [[CrossRef](#)]
32. Ren, J.; Bian, Y.W.; Xu, X.Y.; He, P. Allocation of product-related carbon emission abatement target in a make-to-order supply chain. *Comput. Ind. Eng.* **2015**, *80*, 181–194. [[CrossRef](#)]

33. Yu, S.W.; Wei, Y.M.; Wang, K. Provincial allocation of carbon emission reduction targets in China: An approach based on improved fuzzy cluster and Shapley value decomposition. *Energy Policy* **2015**, *66*, 630–644. [CrossRef]
34. Zhang, Y.J.; Wang, A.D.; Da, Y.B. Regional allocation of carbon emission quotas in China: Evidence from the Shapley value method. *Energy Policy* **2014**, *74*, 454–464. [CrossRef]
35. Chen, X.; Benjaafar, S.; Elomri, A. The carbon-constrained EOQ. *Oper. Res. Lett.* **2013**, *41*, 172–179. [CrossRef]
36. Zhang, Y.-J.; Wang, A.-D.; Tan, W. The impact of China's carbon allowance allocation rules on the product prices and emission reduction behaviors of ETS-covered enterprises. *Energy Policy* **2015**, *86*, 176–185. [CrossRef]
37. Du, S.; Hu, L.; Song, M. Production optimization considering environmental performance and preference in the cap-and-trade system. *J. Clean. Prod.* **2016**, *112*, 1600–1607. [CrossRef]
38. Laundry, D. *Unravelling the Corporate Connections to Toxic Water Pollution in China*; Greenpeace International: Amsterdam, The Netherlands, 2011.
39. Heuser, V.D.; de Andrade, V.M.; da Silva, J.; Erdtmann, B. Comparison of genetic damage in Brazilian footwear-workers exposed to solvent-based or water-based adhesive. *Mutat. Res. Genet. Toxicol. Environ. Mutagen.* **2005**, *583*, 85–94. [CrossRef] [PubMed]
40. Milà, L.; Domènech, X.; Rieradevall, J.; Fullana, P.; Puig, R. Application of life cycle assessment to footwear. *Int. J. Life Cycle Assess.* **1998**, *3*, 203–208. [CrossRef]
41. Cheah, L.; Ciceri, N.D.; Olivetti, E.; Matsumura, S.; Forterre, D.; Roth, R.; Kirchain, R. Manufacturing-focused emissions reductions in footwear production. *J. Clean. Prod.* **2013**, *44*, 18–29. [CrossRef]
42. Borchardt, M.; Wendt, M.H.; Pereira, G.M.; Sellitto, M.A. Redesign of a component based on ecodesign practices: Environmental impact and cost reduction achievements. *J. Clean. Prod.* **2011**, *19*, 49–57. [CrossRef]
43. Nike Sustainable Business Report. Available online: <https://about.nike.com/pages/sustainable-innovation> (accessed on 3 July 2018).
44. Centemeri, L. Environmental damage as negative externality: Uncertainty, moral complexity and the limits of the Market. *E-Cad. CES* **2009**, *5*, 21–39. [CrossRef]
45. Piciu, C.G.; Militaru, I. Economic Conceptualization of Negative Environmental Externalities. *Rom. Econ. Bus. Rev.* **2013**, *8*, 123–130.
46. Sankar, U. Environmental Externalities, Working Paper. 2018. Available online: [https://www.researchgate.net/publication/228644662\\_Environmental\\_Externalities/related](https://www.researchgate.net/publication/228644662_Environmental_Externalities/related) (accessed on 7 August 2018).
47. Hong, Z.; Guo, X. Green product supply chain contracts considering environmental responsibilities. *Omega* **2018**. [CrossRef]
48. Franco, A.; Costoya, M.A.; Roca, E. Estimating risk during showering exposure to VOCs of workers in a metal-degreasing facility. *J. Toxicol. Environ. Health Part A* **2007**, *70*, 627–637. [CrossRef] [PubMed]
49. Hope, B.K. An examination of ecological risk assessment and management practices. *Environ. Int.* **2006**, *32*, 983–995. [CrossRef] [PubMed]
50. Muthu, S.S.; Li, Y.; Hu, J.; Mok, P. Carbon footprint of shopping (grocery) bags in China, Hong Kong and India. *Atmos. Environ.* **2011**, *45*, 469–475. [CrossRef]
51. Ding, H.; Zhao, Q.; An, Z.; Tang, O. Collaborative mechanism of a sustainable supply chain with environmental constraints and carbon caps. *Int. J. Prod. Econ.* **2016**, *181*, 191–207. [CrossRef]
52. Kumar, A.; Jain, V.; Kumar, S. A comprehensive environment friendly approach for supplier selection. *Omega* **2014**, *42*, 109–123. [CrossRef]
53. Molina-Moreno, V.; Leyva-Díaz, J.C.; Sánchez-Molina, J. Pellet as a technological nutrient within the circular economy model: Comparative analysis of combustion efficiency and CO and NOx emissions for pellets from olive and almond trees. *Energies* **2016**, *9*, 777. [CrossRef]
54. Li, X.; Li, Y. Chain-to-chain competition on product sustainability. *J. Clean. Prod.* **2016**, *112*, 2058–2065. [CrossRef]
55. Quesada, J.M.; Villar, E.; Madrid-Salvador, V.; Molina, V. The gap between CO<sub>2</sub> emission and allocation rights in the Spanish Industry. *Environ. Eng. Manag. J. (EEMJ)* **2010**, *9*, 1161–1164.
56. Wang, Z.; Wang, C. How carbon offsetting scheme impacts the duopoly output in production and abatement: Analysis in the context of carbon cap-and-trade. *J. Clean. Prod.* **2015**, *103*, 715–723. [CrossRef]
57. Ekins, P.; Andersen, M.S.; Vos, H.; Gee, D.; Schlegelmilch, K.; Wieringa, K. *Environmental Taxes: Implementation and Environmental Effectiveness*; Publications Office of the European Union: Luxembourg, 1996.



58. Garrison, R.H.; Noreen, E.W.; Brewer, P.C.; McGowan, A. Managerial accounting. *Issues Account. Educ.* **2010**, *25*, 792–793. [[CrossRef](#)]
59. Kaplan, R.S. Management accounting for advanced technological environments. *Science* **1989**, *245*, 819–823. [[CrossRef](#)] [[PubMed](#)]
60. Kee, R.; Schmidt, C. A comparative analysis of utilizing activity-based costing and the theory of constraints for making product-mix decisions. *Int. J. Prod. Econ.* **2000**, *63*, 1–17. [[CrossRef](#)]
61. Guo, J.-J.; Tsai, S.-B. Discussing and evaluating green supply chain suppliers: A case study of the printed circuit board industry in China. *S. Afr. J. Ind. Eng.* **2015**, *26*, 56–67. [[CrossRef](#)]
62. Zhu, Q.; Sarkis, J.; Lai, K.-H. Green supply chain management: Pressures, practices and performance within the Chinese automobile industry. *J. Clean. Prod.* **2007**, *15*, 1041–1052. [[CrossRef](#)]
63. Zhu, Q.; Sarkis, J.; Geng, Y. Green supply chain management in China: Pressures, practices and performance. *Int. J. Oper. Prod. Manag.* **2005**, *25*, 449–468. [[CrossRef](#)]
64. Sarkis, J.; Zhu, Q.; Lai, K.-H. An organizational theoretic review of green supply chain management literature. *Int. J. Prod. Econ.* **2011**, *130*, 1–15. [[CrossRef](#)]
65. Miller, R. *Manual of Shoemaking*; C. & J. Clark Ltd.: Street, UK, 1976.
66. Greene, P.S.; Aveni, M.A.; Lyke, C.J.; Farris, B.N. Article of Footwear Having an Upper with Knitted Elements. U.S. Patent US9149086B2, 6 October 2015.
67. Chen, W.Y.; Jim, C. Resident valuation and expectation of the urban greening project in Zhuhai, China. *J. Environ. Plan. Manag.* **2011**, *54*, 851–869. [[CrossRef](#)]
68. Lu, Y.; Zhu, X.; Cui, Q. Effectiveness and equity implications of carbon policies in the United States construction industry. *Build. Environ.* **2012**, *49*, 259–269. [[CrossRef](#)]
69. Zhu, J. Assessing China's discriminative tax on Clean Development Mechanism projects. Does China's tax have so many functions? *J. Environ. Plan. Manag.* **2014**, *57*, 447–466. [[CrossRef](#)]
70. Yuyin, Y.; Jinxi, L. Cost-sharing contracts for energy saving and emissions reduction of a supply chain under the conditions of government subsidies and a carbon tax. *Sustainability* **2018**, *10*, 895. [[CrossRef](#)]
71. Liu, Z.; Zheng, X.-X.; Gong, B.-G.; Gui, Y.-M. Joint decision-making and the coordination of a sustainable supply chain in the context of carbon tax regulation and fairness concerns. *Int. J. Environ. Res. Public Health* **2017**, *14*, 1464. [[CrossRef](#)] [[PubMed](#)]
72. Zhang, L.; Wang, J.; You, J. Consumer environmental awareness and channel coordination with two substitutable products. *Eur. J. Oper. Res.* **2015**, *241*, 63–73. [[CrossRef](#)]
73. Lee, C.F.; Lin, S.J.; Lewis, C. Analysis of the impacts of combining carbon taxation and emission trading on different industry sectors. *Energy Policy* **2008**, *36*, 722–729. [[CrossRef](#)]
74. Xu, J.; Chen, Y.; Bai, Q. A two-echelon sustainable supply chain coordination under cap-and-trade regulation. *J. Clean. Prod.* **2016**, *135*, 42–56. [[CrossRef](#)]
75. Kamal Abd Rahman, I.; Omar, N.; Zainal Abidin, Z. The applications of management accounting techniques in Malaysian companies: An industrial survey. *J. Financ. Rep. Account.* **2003**, *1*, 1–12. [[CrossRef](#)]
76. Tsai, W.-H.; Hung, S.-J. A fuzzy goal programming approach for green supply chain optimisation under activity-based costing and performance evaluation with a value-chain structure. *Int. J. Prod. Res.* **2009**, *47*, 4991–5017. [[CrossRef](#)]
77. Tsai, W.-H.; Hung, S.-J. Treatment and recycling system OPTIMISATION with activity-based costing in WEEE reverse logistics management: An environmental supply chain perspective. *Int. J. Prod. Res.* **2009**, *47*, 5391–5420. [[CrossRef](#)]
78. Lockhart, J.; Taylor, A. Environmental considerations in product mix decisions using ABC and TOC: As environmental issues increasingly influence corporate performance, they need to be a standard part of management accounting systems. *Manag. Account. Q.* **2007**, *9*, 13.
79. Bhardwaj, V.; Fairhurst, A. Fast fashion: Response to changes in the fashion industry. *Int. Rev. Retail. Distrib. Consum. Res.* **2010**, *20*, 165–173. [[CrossRef](#)]
80. Majeed, A.A.; Rupasinghe, T.D. Internet of Things (IoT) embedded future supply chains for industry 4.0: An assessment from an ERP-based fashion apparel and footwear industry. *Int. J. Supply Chain Manag.* **2017**, *6*, 25–40.
81. Plenert, G. Optimizing theory of constraints when multiple constrained resources exist. *Eur. J. Oper. Res.* **1993**, *70*, 126–133. [[CrossRef](#)]

82. Tsai, W.-H.; Lin, W.-R.; Fan, Y.-W.; Lee, P.-L.; Lin, S.-J.; Hsu, J.-L. Applying a mathematical programming approach for a green product mix decision. *Int. J. Prod. Res.* **2012**, *50*, 1171–1184. [[CrossRef](#)]
83. Tsai, W.-H.; Lin, S.-J.; Liu, J.-Y.; Lin, W.-R.; Lee, K.-C. Incorporating life cycle assessments into building project decision-making: An energy consumption and CO<sub>2</sub> emission perspective. *Energy* **2011**, *36*, 3022–3029. [[CrossRef](#)]
84. Zhu, D.-S.; Lin, Y.-P.; Huang, S.-Y.; Lu, C.-T. The effect of competitive strategy, task uncertainty and organisation structure on the usefulness and performance of management accounting system (MAS). *Int. J. Bus. Perform. Manag.* **2009**, *11*, 336–363. [[CrossRef](#)]



© 2018 by the authors. Licensee MDPI, Basel, Switzerland. This article is an open access article distributed under the terms and conditions of the Creative Commons Attribution (CC BY) license (<http://creativecommons.org/licenses/by/4.0/>).

Article

# An Empirical Investigation of the Relationship between Overall Equipment Efficiency (OEE) and Manufacturing Sustainability in Industry 4.0 with Time Study Approach

Poorya Ghafoorpoor Yazdi <sup>1,\*</sup>, Aydin Azizi <sup>2,\*</sup> and Majid Hashemipour <sup>3</sup>

<sup>1</sup> Department of Mechanical Engineering, Eastern Mediterranean University, Famagusta 99628, Northern Cyprus

<sup>2</sup> Engineering Department, German University of Technology, Muscat 130, Oman

<sup>3</sup> Faculty of Engineering, Cyprus International University, Nicosia 99258, Northern Cyprus; mhashemipour@ciu.edu.tr

\* Correspondence: poorya.ghafoorpoor@gutech.edu.om (P.G.Y.); aydin.azizi@gutech.edu.om (A.A.)

Received: 6 July 2018; Accepted: 13 August 2018; Published: 27 August 2018

**Abstract:** Nowadays, small and medium sized enterprises (SMEs) are becoming increasingly competitive. In order to fulfill the rapidly changing market and diversified demands of customers, the SMEs need to achieve and maintain high productivity and quality, with fast response, sufficient flexibility, and short lead times. Therefore, Industry 4.0 offers various manufacturing paradigms that might be a solution in order to increase the productivity of SMEs such as intelligent and flexible manufacturing. Furthermore, in the last decade, the emphasis on adopting eco-friendly practices, implementing sustainability measures, and protecting the environment has continued to grow, to gain traction across SMEs. In fact, because of this need, many SMEs are now adopting sustainable manufacturing practices in response to this increased focus on sustainability and environmental stewardship. The main purpose of this paper is to design and study the implementation of a sustainable, intelligent material handling system for material distribution with utilizing an agent-based algorithm as control architecture. A time study-based methodology has been implemented to evaluate the overall equipment effectiveness (OEE) to identify the matters that need to be resolved and optimized to increase the OEE percentage with consideration of the sustainability of the system. An exhaustive analytical trend applied to the generated time study data. Accordingly, further hardware, software, and layout design limitation and problems detected, and the proper solutions were anticipated. The observed time study results were presented, a fundamental set of analytical observation and information with associated histograms was reviewed. In addition, the study aims to recognize and analyze effective factors on the sustainability of improved processes, using a simple model. To do this, using experts' viewpoints, affective factors on the sustainability of process improvement activities are determined.

**Keywords:** small and medium enterprises; OEE; OECD; manufacturing sustainability; time study; Industry 4.0; material handling systems; agent-based control architecture

## 1. Introduction

The material handling system is one of the elements that influences the manufacturing of products in SMEs [1]. The duty of distribution of goods contributes a benefit of time and positioning that acquires a value related to getting a product at a provided station with equipment capable to transform the distributed parts into profitable goods.

The process of handling materials in most of the SMEs' facilities includes employees spending great amounts of time and effort for sorting parts and performing manual tasks, which resulted in higher production costs and longer production time [2]. However, the concept of intelligent material handling has been developed and introduced, which only relies on manufacturing resources and their control architecture [3].

Even though, for a few numbers of SMEs, which target the utilization of types of intelligent material handling systems, it would be risky and sometimes not feasible to apply any changes or performance evaluation before a trustable outcome of the system performance validated by a standard about different manufacturing aspects [4].

### *1.1. Material Handling Systems Performance Evaluation*

SMEs nowadays put so much effort to increase the production line's effectiveness, to meet the needs of the market. That does not happen if the performance of the production line is not improved. Although before improving any system, its performance has to be checked and brought to the utmost way possible. In order to develop and improve any production line, it is important to have numbers and data that shows the performance [5].

According to Kathurima et al., to understand material handling systems behavior, it is important to observe and collect records and the data of the system process [6]. Authors in this study mentioned that to improve the material handling system, it is essential to study the system performance by identifying problems to increase the production line performance efficiency. The goal of this research is to check the overall performance using a specific time study methodology, subsequently followed by an optimization process of each part of the material handling system with specific standards in the industry, which will eventually help to utilize the machinery for better productivity.

There are many ways to evaluate the performance of a production line. One of these methods is applied mathematical modeling, meaning that they are determined by an analytical method (a computational formal). The models are categorized into analytical and experimental, or they can be hybrid; which combines both the analytical and experimental models together. The analytical model can be translated as the mathematical interpretation of a real system, and it is primarily categorized into either exact models or approximation models. In contrast, the experimental model is considered a simulation model. Jarrahi et al introduced a linear programming model, which uses a mathematical form of a time cycle measure of a production line that has workstations, and each workstation is likely to fail [7]. On the other hand, the approximation model can be demonstrated by De Koster's method, where he built a continuous flow line of a multi-stage model, which contains some unreliable machines with buffers separating them, and then used repeated aggregation on them to predict the efficiency of the line. Equally for the simulation, Conway et al. have simulated a system in which they investigated the behaviour of buffered lines that lacked synchronization, which led them to discover the aggregation of work-in-process [8].

### *1.2. Overall Equipment Effectiveness (OEE)*

In Industry 4.0, firm effectiveness of equipment plays a major role to lessen the number of rejections and achieve higher productivity [9]. In the current dynamic and challenging environment for SMEs, reliable manufacturing equipment and OEE are the main components for increasing performance and profitability of manufacturing systems [10]. Alternatively, the overall equipment effectiveness (OEE) is an analytical performance evaluation method for SMEs [11]. The OEE is defined as the valuable time of operation over the loading time. Iannone et al. stated that the operation time can be interpreted as the time during which the equipment produces satisfactory products. Whereas the loading time is the time needed for equipment to run through a given period [12]. This method is going to be explained in detail in the next point for the time study [13].

Standard metrics are considered for manufacturing systems evaluation in order to improve productivity of the enterprises. The improvement of the manufacturing system can be determined

and improved using these metrics [14]. Each metric can measure different sides of the production performance, such as efficiency, quality, flexibility, inventory, and profitability. Overall equipment effectiveness (OEE) is one of the metrics to measure the percentage of the truly productive time, and consists of three factors; namely, availability, performance, and quality. Thus, conducting time study with OEE view helps to correct and eliminate the wasted time that may occur in manufacturing process [15]; overall equipment effectiveness is a metric used to measure the percentage of the truly productive time from the planned production time of a plant or manufacturing process when the percentage is as near to 100% as the more productive the process [16].

In addition, OEE assessment in manufacturing system is not just limited to evaluating the manufacturing times. Investigation of OEE provides a systematic process to easily identify common sources of productivity losses so that you can effectively apply resources to improve manufacturing performance [17]. OEE investigation can also improve productivity; reduction cost; and raise awareness, machine productivity, and increase in life of equipment. The effects of these objectives are to reduce costs, increase profits, maintain a distinguished ownership of equipment [18,19].

There are three factors that need to be measured to get the percentage of the OEE, which are the following: availability, performance, and quality, and after calculating the percentage of these factors, the OEE percentage can be determined by Equation (1) [20].

$$\text{OEE} = \text{Availability} \times \text{Performance} \times \text{Quality} \quad (1)$$

Availability is the ratio of the runtime to the planned time of the production and it takes the consideration the availability loss, which are all the down times that the process faces during that time that it is supposed to be running, and there are unplanned stops that may occur because of equipment failure or the lack of materials, and planned stops that may be caused by the changeover, and then the remaining time from the whole production time, deducting the loss availability loss, is called the runtime [14].

Calculating the availability mathematically is done by the following Equation (2):

$$\text{Availability} = \frac{\text{Runtime}}{\text{Planned production time}} \quad (2)$$

As that if the availability is 100%, it means that there were not any stop times at all during the whole production time.

The second factor of the OEE is the performance, which is the ratio of the net runtime to the runtime, and this factor takes into consideration anything that may reduce the speed of the manufacturing to be less than the maximum speed, including minor stops and slow cycles. To calculate the performance, the following Equation (3) is used:

$$\text{Performance} = \frac{(\text{ideal cycle time} \times \text{total count})}{\text{Runtime}} \quad (3)$$

where the total count is the total numbers of products that are produced [21].

This factor concerns the parts that are manufactured during the production process and takes account to the quality loss, which is the products that did not meet the quality standards and have some defects on them, and which may need rework to make them meet the quality standards. Quality factor takes in consideration of all the parts that are manufactured, whether or not they met the quality standards. The quality (4) is calculated by the following equation:

$$\text{Quality} = \frac{\text{good count}}{\text{total count}} \quad (4)$$

where the good count is the number of the products that are manufactured and met the quality standards and the total is the number of all parts manufactured.

Time study tracks the behaviour of each instrument in the process. Also, based on this standard, breaking the process into parts makes evaluation easier, where the actual and the overall performance times of the system are considered [22,23].

### *1.3. Time Study as the Key Factor for OEE*

As mentioned before, time plays the most essential role in analysing the OEE. In order to improve a system, an understanding of the system performance has to be made. Therefore, in a time study approach, the study tracks the behaviour of each instrument in the process. Breaking the process into parts makes the evaluation easier, by measuring their actual performance time then measuring the overall performance time of the system by adding each step to the other. Conducting the time study will help to correct and to eliminate the wasted time and the bottlenecks that may occur in the process [24].

A time study was introduced by Frederick W. Taylor using a paper, pen, and stopwatch with a person observing the system, and can give a performance analysis for a simple production line [25]. Moreover, this method would not be realistic for a complex production line, the solution is to use a monitoring program or software that gives a detailed report of system activities. The author stated that this report will show the problems and errors that occurred while the production line was performing. To detect the problem and identify the system failure, it is important to check the machines of the system individually.

The first step is to watch and observe the process to get familiar with the system. Setting beginning and ending points allows the system to be able to break down the process into single steps. It is important to record each step and label all the components of the system with a brief description. Any time study requires tools or software programs that are able to record the time data of the system accurately, in the case of using software, the appropriate time parameter has to be selected. Once the program is set, the step of collecting data follows. A second time observation of the process is required, paying attention to details of the bottlenecks and errors of each and every step while recording data. The last step is to analyse data recorded from the most to the least important of each part, making sure that the actual time is recorded to compare it with the standard operation time of the machine. Following these steps will help improve and optimize the system, which means both better performance and better product quality [24].

### *1.4. Manufacturing Sustainability Improvement*

According to The Organization for Economic Cooperation and Development (OECD), Sustainable manufacturing is a formal name for an exciting new way of doing business and creating value. It is behind many of the green products and processes in demand and celebrated around the world today [26]. To put it simply, sustainable manufacturing is all about minimising the diverse business risks inherent in any manufacturing operation, while maximising the new opportunities that arise from improving your processes and products. OECD also defined seven steps to set up the requirements for sustainable manufacturing (Table 1) [27].

According to OECD, there are eight key factors that must be considered during the sustainability investigation (Figure 1).

Based on the selected case study system and considering the properties of the functional devices and the defined scenario, the above figure will be simplified to the relationship of the manufacturing sustainability and energy intensity. This means, except for the energy consumption of the devices or the whole system, the other items are neglectable or satisfy the requirement of manufacturing sustainability.

**Table 1.** The Organization for Economic Cooperation and Development (OECD) requirement for sustainable manufacturing.

	Steps	Description
Preparation	Mapping impact and set priorities	In this step, the manufacturing environmental impact of small and medium sized enterprises (SMEs) should be reviewed. Also, priorities of each should be defined. Based on the detected and the priorities of these environmental impacts, sustainability objectives should be defined.
	Select useful performance indicators	Indicators that are essential for SMEs to increase the performance and learn about what data should be collected to help drive continuous improvement should be identified.
Measurement	Measure the inputs used in the production	The way how materials and components used in SMEs production processes influence environmental performance should be identified.
	Assess operations of the SMEs facility	The impact and efficiency of the operations in SMEs facility such as energy intensity, greenhouse gas generation, emissions to air and water, etc., should be considered.
Improvement	Evaluate your products	The factors such as energy consumption in use, recyclability, and use of hazardous substances that help determine how sustainable SMEs end products should be identified
	Understand measured results	Reading and interpreting the SMEs indicators and the method to understand trends in their performance should be learned.
	Take action to improve performance	Opportunities to improve SMEs performance and create action plans to implement them should be chosen.

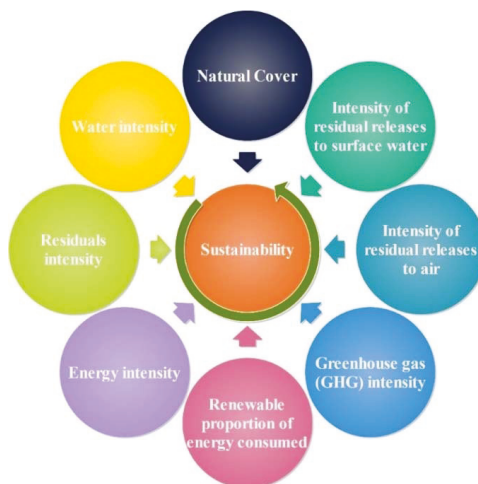

**Figure 1.** Considerable factors in manufacturing sustainability.

Considering time as the main factor for efficiency or effectiveness (OEE) of an equipment or entire enterprise, a relationship between the time (overall production time, idle time, utilization time, etc.) and sustainability of the SMEs is the aim. However, to fully assess the energy-related efficiency or effectiveness of an equipment, the time-based view alone is not sufficient [28]. Furthermore, current energy performance indicators are calculated through aggregate measures of energy consumption (e.g., kWh/month or kWh/part). In this section, a method will be added to the proposed methodology to define the relationship between energy consumption and time. The method is a designed device and facilitates the level of SMEs that is selected based on its major contribution to energy consumption



and energy efficiency improvement potential, as emphasized by May et al. [29]. The proposed method connects manufacturing states about energy consumption during a specific period (discrete or continuous time) to energy states about power requirement in Watt through cause–effect relationships. In this way, an action plan is proposed to reduce the entity of these variables for reducing both the amount of time spent and energy consumed.

This study sought to conduct an analytical system performance evaluation by utilizing a time study methodology on an intelligent material handling system for auto part distribution. The proposed methodology has been implemented in the German University of Technology in Oman (GUtech) [30].

It is noticeable to mention that the system is a small-scale educational manufacturing system with a limited functionality period. Because of utilizing educational equipment to create the system and implement the proposed methodology, system observation and data collection are conducted in a short period of time to prevent any system damage. However, any physical system damage can affect system performance. Thus, all the evaluations and observations and their outcomes have been done in a short period of time and have been expanded theoretically over a long period.

The challenges faced in the implementation of the system and performance evaluation practices are defined in detail. This study used a descriptive methodology for the industrial category target including all of the small and medium enterprises (SMEs). The case study system is an example of an SME with a simple manufacturing system. The research conducted to provide a solution for SMEs to make smooth implementation of a sustainable, intelligent manufacturing system considering the Industry 4.0 preparation requirements. To reach to this goal, OEE standard have been proposed to evaluate the system and provide the required data, which takes into consideration the aim to maintain and improve the sustainability of the system. Thus, a relationship between OEE and manufacturing sustainability has been provided.

The study made use of devices' utilization time as the key to measure performance. Quantitative required data were collected using Prottime Estimation software as the time study tool. In addition, the study conducted an overall equipment effectiveness (OEE) standard analysis to determine the performance evaluation in such material handling systems for SMEs. Finally, the effect of time on energy consumption and sustainability of the system have been investigated.

The study established that considering the time as the key determines most of the hardware, software (control architecture), and layout design problems and limitations. All the system problems, limitations, and solutions, and any possible changes in system performance, are detected from time study results analysis. The study concludes that there will be improvements both partially and overall in the system performance; especially, modification in hardware, software, and layout design of the system were described as solutions. The study also verified the visually observed problems and limitations by time study results.

Finally, by considering the sustainable manufacturing key factors, proper solutions have been suggested to highlight the importance of the result obtained by the proposed methodology and optimization idea on manufacturing sustainability.

## **2. System Description**

In order to implement an intelligent material handling system, a comprehensive layout design including the required resources to accomplish target specific tasks is needed. Figure 2 illustrates the system layout design. The system consists of a main conveyor including four sensors, a robot arm, two side conveyors (left and right) including a motion sensor, and two sliders (left and right) including a color sensor. The main and side conveyors are powered by two sets of motors (four motors) and sliders are powered by one motor each. Motors on conveyors and robot's servo motors are controlled by bricks (controllers) called "slaves". The slaves receive signals from sensors as input to give an output that is commended to motors. The system has an agent-based control architecture in which slaves are operating and controlling the system after confirmation of the main control unit (master). The master control unit includes the main input–output logic of the system and related resources.



Each slave in the system is considered to be an agent including agent software. Slaves (agents) operate and communicate in the system by means of sensors and actuators. A slave with its software agent perceives or communicates with other software entities in other agent via Bluetooth, which do not act to pursue a specific objective, but only to satisfy requests. The master agent may delegate a task to a slave agent. Master and slaves communicating with each other happens when performance of a task needs confirmation of master more than the slave's communications.

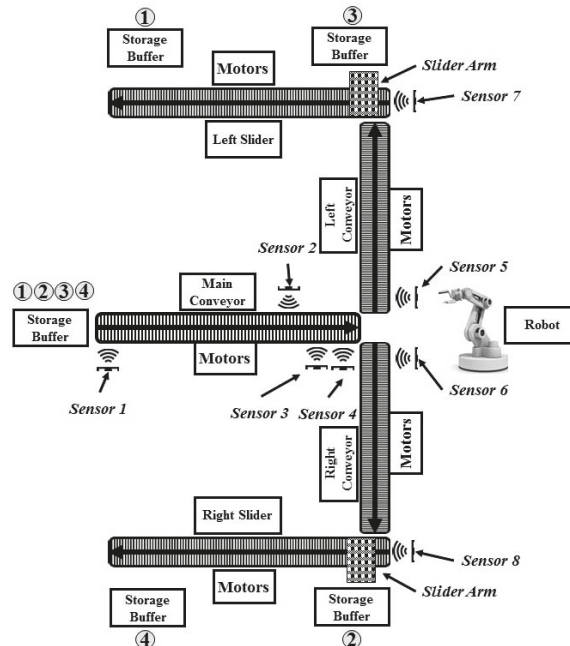

Figure 2. System layout design.

Referring to Figure 2, the system can be divided into four main phases. The first phase comprises four sensors, the object's storage (red, blue, yellow, and green) buffer, the main conveyor, and slave 1. Phase 2 consists of the robotic arm and slave 6. Phase 3 and phase 4 are similar except that they are in the opposite direction and are assigned for handling different objects. Both phases consist of two slider units integrated with a color sensor and controlled by slaves (slave 4 for the right side and slave 5 for the left side), two conveyors integrated with a motion sensor and controlled by slaves (slave 2 for right and slave 3 for left side) and unloading buffers. The unloading buffers are the exits of the system, in which objects are going to be stored separately in each of them based on their color and the scenario.

Each phase in the system has a different functionality and control architecture. In the first phase, sensor 1 is utilized to initialize the conveyor. Sensor 2 is added to the system to slow down the conveyor motion. It is thus essential to have sensor 2, because without this sensor, the conveyor will move at a high speed at a critical point and will be difficult to control. In addition, sensor 3, which is used to stop the motion of the conveyor, will not have enough delay to detect the presence of the object. The robotic arm is programmed to pick the material in a specific position. Therefore, if the object is being stopped at a different position, the robotic arm will not be able to pick it up accurately. Hence, it is necessary to slow down the main conveyor motion by sensor 2, and eventually, sensor 3 will be able to stop the conveyor and object in the exact desired position (Figure 3).

Phase 2 consists of a robot arm. This robot arm’s job is to pick the object from main conveyor and place it either on right or left conveyor depending on the colors and the considered scenario for that color (Figure 4).

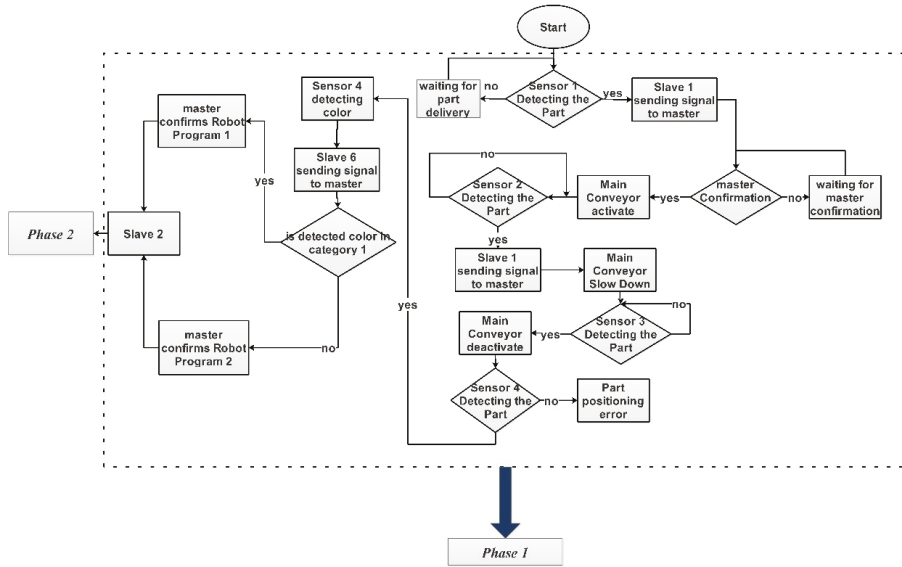

Figure 3. Main conveyor control architecture (phase 1).

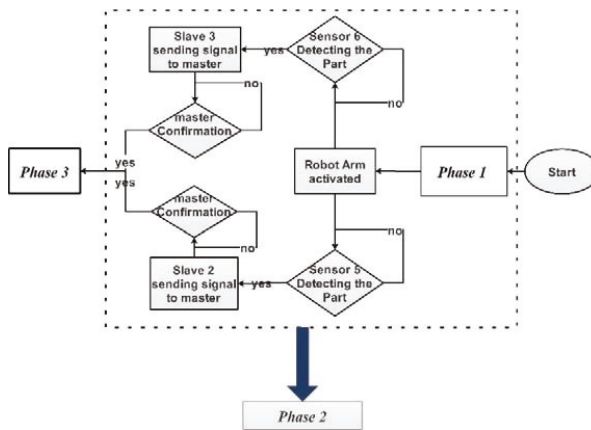

Figure 4. Robotic arm control architecture (phase 2).

In phase 3 and phase 4, the sensors are added at the beginning of the conveyors. These sensors are used to start the motion of the conveyors. However, for these two phases, there is no sensor where it stops (Figure 5). As the object should slide to the slider for differentiation based on their color; once the object slides to the slider, the sensor on the slider will distinguish which color it detects. According to that, it will distribute it to the considered buffer (Figure 5).

The aim to define the system with agent-based control architecture is limited to prevent bottleneck and resource conflict issues during system performance. In order to achieve this goal, slaves and the

master are in continuous communication. The master can control the slaves' functionality based on the defined scenario to prevent any overlapping and conflict between the phases. For instance, slave 1 on the main conveyor activates the conveyor for the first time and waits for master for reactivation of the next part. In the system control architecture, it is defined that master will not give the confirmation signal to slave 1 before placing the part on side conveyors and activating slave 2 or 3 accordingly (Figure 6).

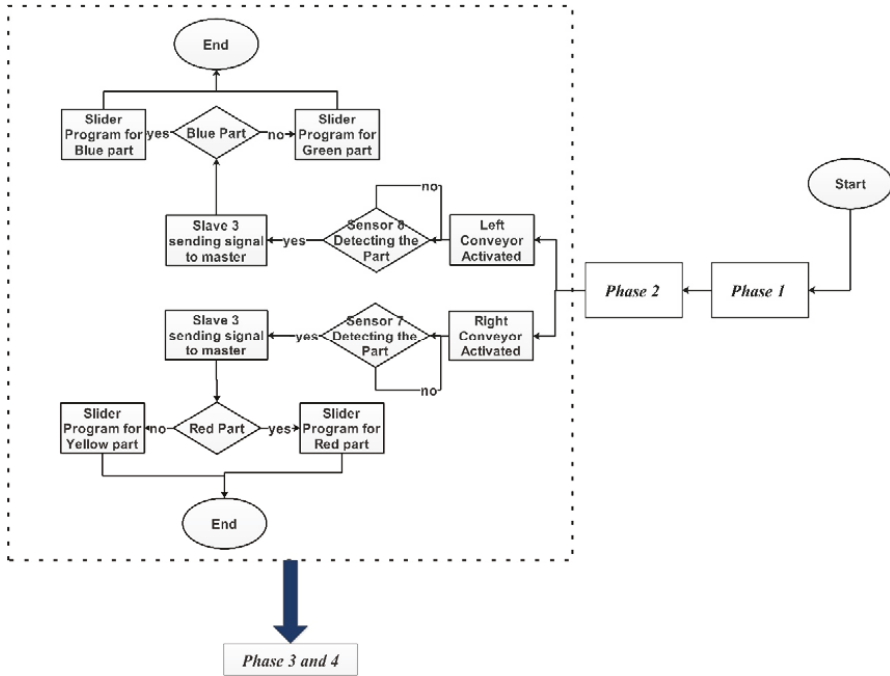

Figure 5. Side conveyors and sliders control architecture (phase 3 & 4).

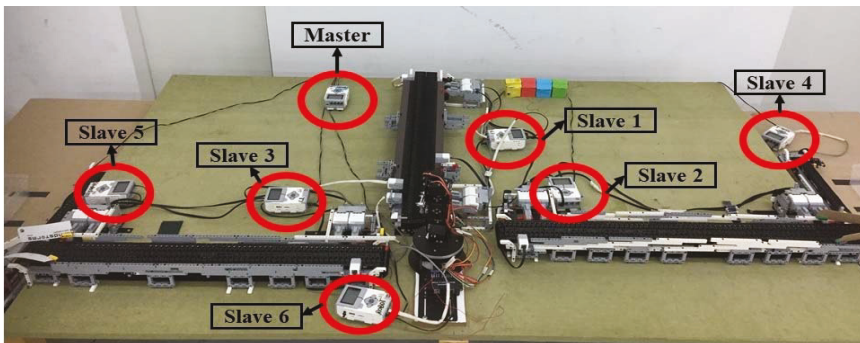

Figure 6. System overview.

### 3. Methodology

The system is subjected to a time study test in the ProTime estimation program to evaluate each part of the process. The aim to do time study on the system is to obtain the utilization time of

each resource and a comprehensive comparison between the resources with the same functionality to record the individual time study result. A time study result of the system shows the individual and overall system performance; limitations; and hardware, software, and layout design problems. These achievements out of time study help to find the proper optimization methods to improve the performance of the system.

Figure 7 illustrates the process for generating the time study report of the system using the ProTime estimation software. Three different views for videos capturing were chosen (right, left, and front view). The videos were uploaded to the software. The time study was performed using the mentioned methodology, where each recorded video was uploaded in the software, and for each video, the mentioned steps were followed for creating the time study reports (Figure 7).

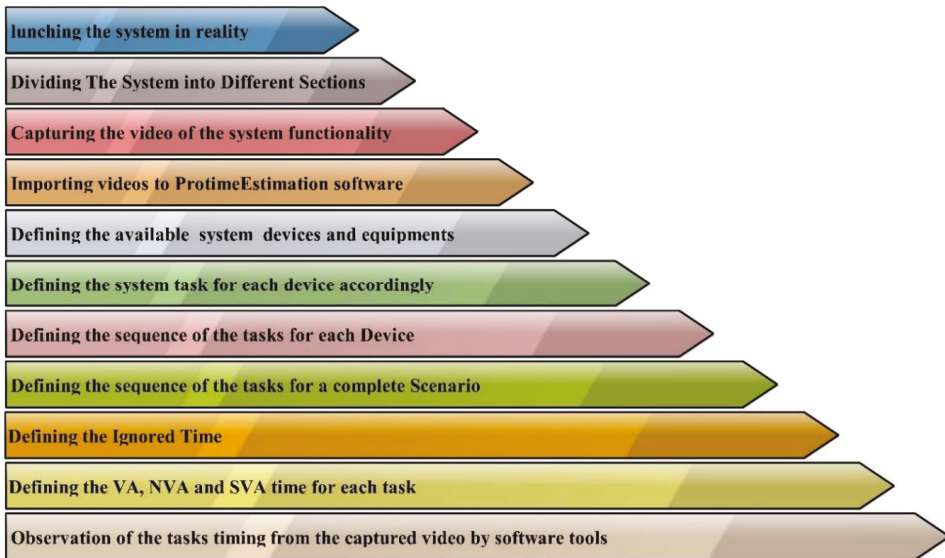

**Figure 7.** Time study overall methodology. Value added (VA), non-value added (NVA), semi-value added (SVA).

The observed time study report for each section was generated for each object (material) individually. Data from each section of the study (left, right, and front) were combined to generate a comprehensive time study of the system.

Table 2 describes the total available tasks to complete the entire scenario. Each of these tasks is labeled with a number (task number) and the included resources to perform that task. These tasks should be defined in the ProTime estimation software. After task definition, the sequence of the tasks should be defined as they are in a real scenario and in the recorded video, respectively. The software has the ability to record the start and stop time by a simple procedure (clicking a record button). The software enables the operator to watch the video with a different playing rate and to record the times for each task by observing the video.

**Table 2.** Task number, description, and related resources for the entire scenario.

Task No.	Task Description	Main Conv.	Robot	Right Conv.	Left Conv.	Right Slider	Left Slider
1	Main conveyor moving Yellow object to Robot	✓					
2	Robot arm picking Yellow Object from main Conveyor		✓				
3	Robot arm placing Yellow Object on right Conveyor		✓				
4	Right conveyor moving Yellow Object to Right Slider			✓			
5	robot arm moving back to home position after placing Yellow Object		✓				
6	Right slider moves yellow object to Yellow buffer					✓	
7	Right slider unloading Yellow Object to Yellow Buffer					✓	
8	Right slider moving back to home position after unloading Yellow Object					✓	
9	Main conveyor moving Green object to Robot	✓					
10	Robot arm picking Green Object from main Conveyor		✓				
11	Robot arm placing Green Object on left Conveyor		✓				
12	Left conveyor moving Green Object to Left Slider				✓		
13	Robot arm moving back to home position after placing Green Object		✓				
14	left slider moves Green object to Green buffer						✓
15	left slider unloading Green Object to Green Buffer						✓
16	Left slider moving back to home position after unloading Green Object						✓
17	Main conveyor moving Red object to Robot	✓					
18	Robot arm picking Red Object from main Conveyor		✓				
19	Robot arm placing Red Object on right Conveyor		✓				
20	Right conveyor moving Red Object to Right Slider			✓			
21	Robot arm moving back to home position after placing Red Object		✓				
22	Right slider moves Red object to Red buffer					✓	
23	Right slider unloading Red Object to Red Buffer					✓	
24	Right slider moving back to home position after unloading Red Object					✓	
25	Main conveyor moving Blue object to Robot	✓					
26	Robot arm picking Blue Object from main Conveyor		✓				
27	Robot arm placing Blue Object on left Conveyor		✓				
28	Left conveyor moving Blue Object to Left Slider				✓		
29	Robot arm moving back to home position after placing Blue Object		✓				
30	left slider moves Blue object to Blue buffer						✓
31	left slider unloading Blue Object to Blue Buffer						✓
32	Left slider moving back to home position after unloading Green Object						✓

In this study, the playing rates were lowered from 1.0 to 0.6 units for getting precise data. The start time for each task was reset. The ignored times were taken into consideration as well, and were calculated manually and written down next to the task that got the ignored time in the observations table. In ProTime estimation software, ignored time is a type of timing that increases the actual timing by human mistakes; for instance, the failure of the operator to put the part on the conveyor on time. Furthermore, this time will not be considered as the effective time on OEE percentage. As the OEE concerns the equipment effectiveness, this time will not take place as breakdown or downtime,

as shown by Figure 8. In this research, there is just one “ignored time”, which is the result of the mentioned example. The amount of this time is 1.83 s.

The value added (VA), non-value added (NVA), and semi-value added (SVA) for each task were defined by the software, which is done by writing the values manually or by double clicking on cells to view the list of actions predefined in the software (Figures 8 and 9).

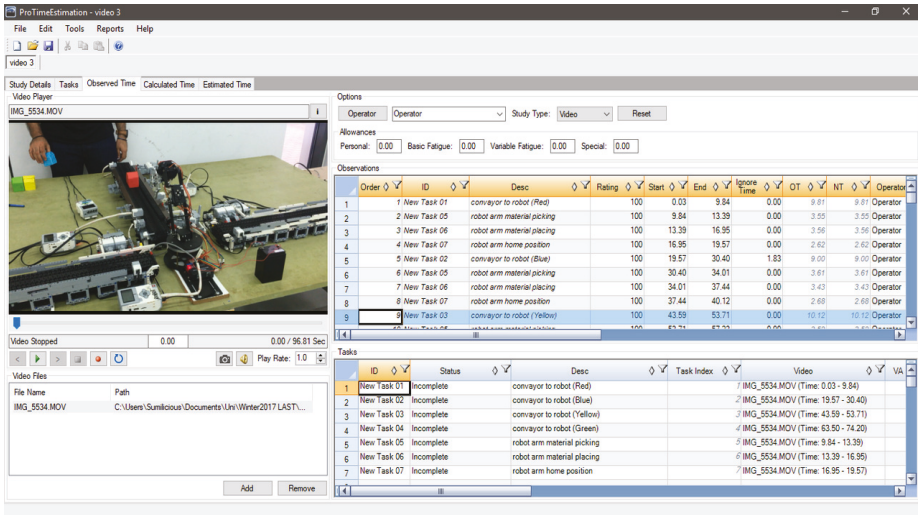

Figure 8. Time study software Graphical User Interface (GUI).

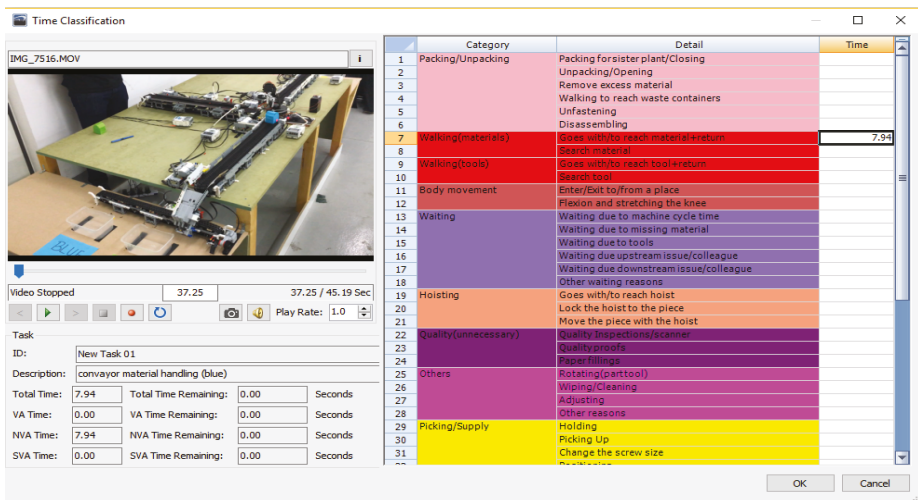

Figure 9. Value added (VA), non-value added (NVA), and semi-value added (SVA) times definition.

### 3.1. Observation of Separate Sections of the System

#### 3.1.1. Main Conveyor and Robot

The first stage of the time study has been done on the main conveyor and the robot arm that contained the specific tasks, as shown in Table 2.

Figure 10 shows the utilization Gantt chart of the main conveyor; the chart displays the overall utilization time. The very first step is when the red object is placed on the conveyor. The motion sensor detects the object and the conveyor moves until 9.81 s, when it comes to a complete stop, where the color sensor detects the red objects and sends signals to the robot to pick it up. Then, the conveyor is on standby for 9.73 s as an idle time, while the robot arm works on picking and placing the object. Once the red object is placed on the right conveyor, the blue object is then placed and handled for 9.04 s until it reaches the robot arm. The process is repeated for the yellow and green objects as well. It can be seen that the idle time of the main conveyor before it handles the yellow object is 10.48 s. The yellow object is delivered to the robot arm in 9.86 s. As for the green object, it was handled for 9.62 s, and the conveyor took 10.25 s before it was handled.

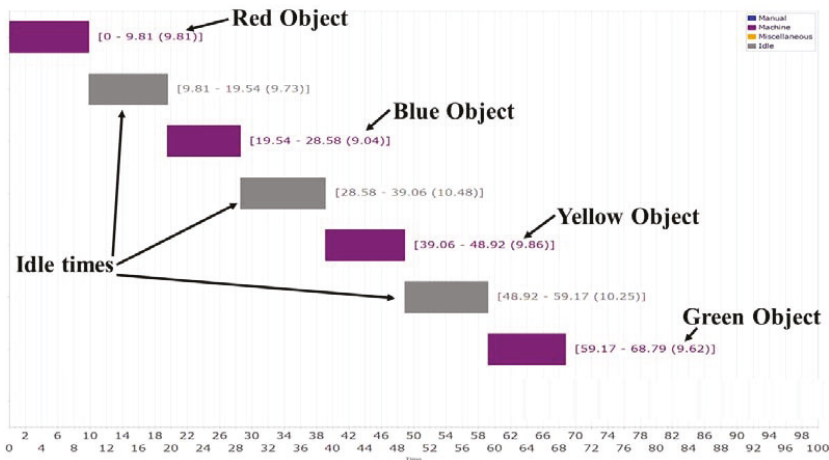

Figure 10. Main conveyor utilization report.

The utilization time of each material handled varies, but they are close in value. The fastest time recorded was the blue object, which indicates that it was the fastest to be delivered, and also means that the rest of the parts can be modified either by shape or color intensity to be recognized faster by sensors. On the other hand, the first three idle times on the chart are nearly the same with a fraction of a second difference. The first problem in the system appeared is the idle time, which cannot be eliminated completely. To reduce the idle time, it is important to optimize the speed of the conveyor and the color of the objects because it affects its recognition by the color sensor.

The robot arm process is steady and the values of picking and placing each object are nearly the same. Table 3 shows the start, end, and total time spent of the robot arm tasks.

From Table 3, we notice that the process is steady except for the yellow object picking material. This indicates that the color sensor had difficulty recognizing the object. Consequently, the sensor programming must be modified, after which it recognizes the color of the objects. Figure 11 shows that the idle times of the robot arm are dependent on the main conveyor process. As a result, reducing the idle time of the robot arm can be achieved by increasing the efficiency of the process of the main conveyor.



Table 3. Robot arm time study data.

Task Description	Start (s)	End (s)	Utilization Time (s)
red object picking	9.81	13.36	3.55
red object placing	13.36	16.92	3.56
robot arm home position	16.92	19.54	2.62
<i>Total Utilization for Red Object</i>			9.73
blue object picking	28.58	32.46	3.88
blue object placing	32.46	36.28	3.82
robot arm home position	36.28	39.06	2.78
<i>Total Utilization for Blue Object</i>			10.48
yellow object picking	48.92	52.97	4.05
yellow object placing	52.97	56.6	3.63
robot arm home position	56.6	59.17	2.57
<i>Total Utilization for Yellow Object</i>			10.25
green object picking	68.79	72.63	3.84
green object placing	72.63	76.23	3.6
robot arm home position	76.23	78.73	2.5
<i>Total Utilization for Green Object</i>			9.94

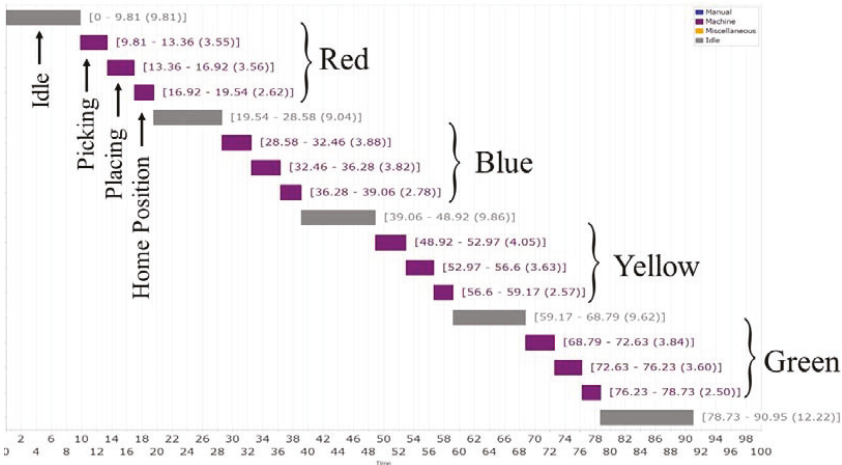

Figure 11. Robot arm utilization report.

3.1.2. Left and Right Conveyors and Sliders

As Figure 12 shows, an overall idle time value of 72.44 is spent by the red and yellow objects on right conveyor divided as follows: 16.92 s waiting for the red object to reach, whereas 33.37 s is for waiting for the yellow object to reach, and the remaining 22.15 s is for waiting for the process to be completed. When looking at the overall performance of the side-conveyor, we notice that the utilization time—which is shown in Table 4—is less than the time spent on standby non-added value. To get a better overall performance, the non-added value has to be reduced, increasing the value added to the process. The possible solution to overcome this issue is to improve the control architecture between main and right conveyor to control the input-outputs (IOs) and communication between the main conveyor agent, robot agent, and right conveyor agent. Furthermore, changing the layout design to increase the access points (system entrance) could be an adequate solution.



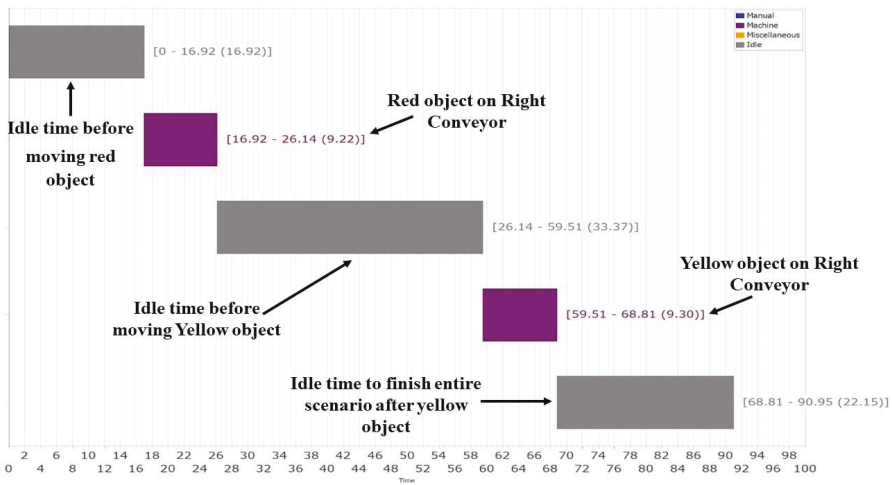

Figure 12. Right conveyor utilization report.

Table 4. Red and yellow object on right conveyors and right sliders time study data.

Task Description	Start (S)	End (s)	Utilization Time (s)
Right conveyor for red object	16.92	26.14	9.22
Right slider to Red buffer	26.14	30.12	3.97
Right slider unloading red	30.12	34.62	4.5
Slider home position after unloading red	34.62	38.63	4.02
Right Conveyor for Yellow Object	59.51	68.81	9.3
Right slider to yellow buffer	68.81	69.79	0.98
Right slider unloading yellow	69.79	74.11	4.32
Slider home position after unloading yellow	74.11	75.36	1.25

Similarly, the slider has a greater idle time than utilization time, resulting in 71.91 s of standby time spent to deliver the objects to it. As the sliders have the same behavior as the conveyors, the same strategy could be used to optimize the timing.

Correspondingly, the same applies to the blue–green side-conveyor and slider. The total idle time is 68.29 s, the reason this value is less than the value of red–yellow conveyor is that the process ends when the last task of this side is done working (Table 5).

Table 5. Blue–green conveyor and slider data.

Task Description	Start (s)	End (s)	Utilization Time (s)
Left conveyor for Blue object	38.63	46.57	7.94
Left slider to Blue buffer	46.57	50.66	4.09
Left slider unloading Blue	50.66	55.08	4.42
Slider home position after unloading Blue	55.08	59.51	4.43
Left Conveyor for Green Object	76.23	84.11	7.88
Left slider to Green buffer	84.11	85.18	1.07
Left slider unloading Green	85.18	89.51	4.33
Slider home position after unloading Green	89.51	90.95	1.44

From Figures 13–15, we notice that the slider utilization time when delivering the first object of each side differs from the second object delivered. This is an indication of the variance of the storage

distance from the slider itself. As for either blue or red, the distance of the storage unit from the slider is greater than the distance of either green or yellow storage.

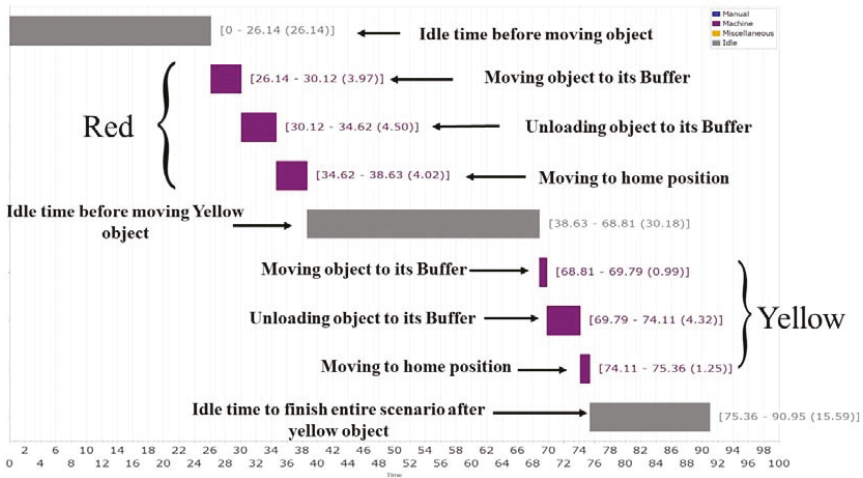

Figure 13. Red-yellow slider utilization report.

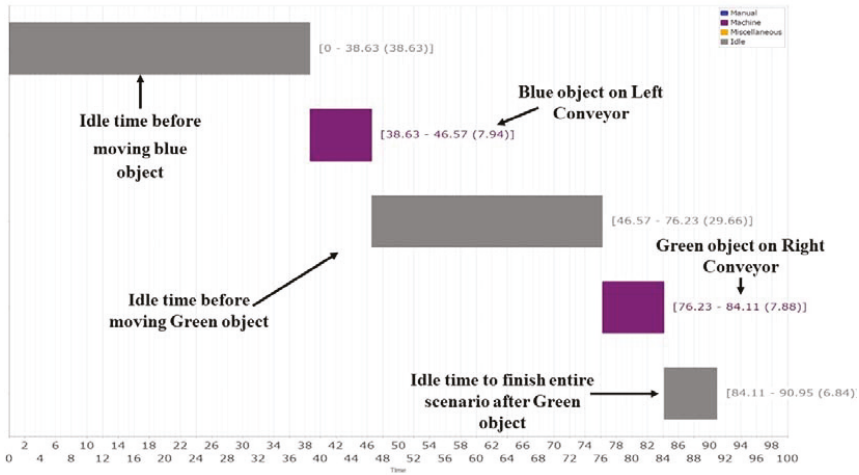

Figure 14. Left conveyor utilization report.

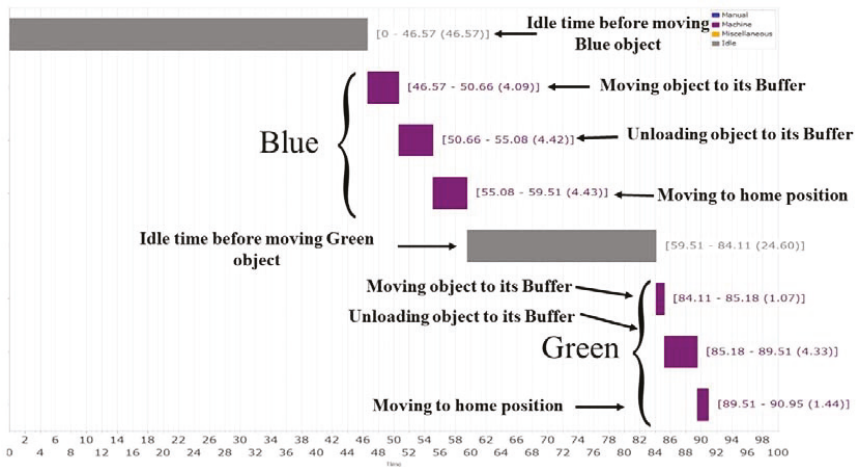

Figure 15. Blue–green slider utilization report.

3.2. Observation of the Entire System

The following Gantt chart (Figure 16) shows the overall system performance with all the sections of the system, showing the utilization time of each resource and the conflicts that occur when two or more resources are working at the same time. This chart was generated using the predecessor of tasks table (Table 6).

Table 6. Predecessors of tasks.

Task No.	Task Description	Predecessors	Related Resources
1	conveyor to robot (Yellow)	13	Main Conv.
2	robot arm material picking	16	Robot Arm
3	robot arm material placing	18	Robot Arm
4	conveyor material handling (Yellow)	19	Right Conv.
5	robot arm home position	20	Robot Arm
6	slider to buffer (Yellow)	22	Right Slider
7	slider unloading (Yellow)	23	Right Slider
8	slider home position (after unloading Yellow)	25	Right Slider
9	conveyor to robot (Green)	21	Main Conv.
10	robot arm material picking	24	Robot Arm
11	robot arm material placing	26	Robot Arm
12	conveyor material handling (Green)	27	Left Conv.
13	robot arm home position	27	Robot Arm
14	slider to buffer (Green)	28	Left Slider
15	slider unloading (Green)	29	Left Slider
16	slider home position (after unloading Green)	30	Left Slider
17	conveyor to robot (Red)	1	Main Conv.
18	robot arm material picking	2	Robot Arm
19	robot arm material placing	3	Robot Arm
20	conveyor material handling (Red)	4	Right Conv.
21	robot arm home position	4	Robot Arm
22	slider to buffer (Red)	6	Right Slider
23	slider unloading (Red)	7	Right Slider
24	slider home position (after unloading Red)	10	Right Slider
25	conveyor to robot (Blue)	5	Main Conv.
26	robot arm material picking	8	Robot Arm
27	robot arm material placing	9	Robot Arm
28	conveyor material handling (Blue)	11	Left Conv.
29	robot arm home position	12	Robot Arm
30	slider to buffer (Blue)	14	Left Slider
31	slider unloading (Blue)	15	Left Slider
32	slider home position (after unloading Blue)	17	Left Slider

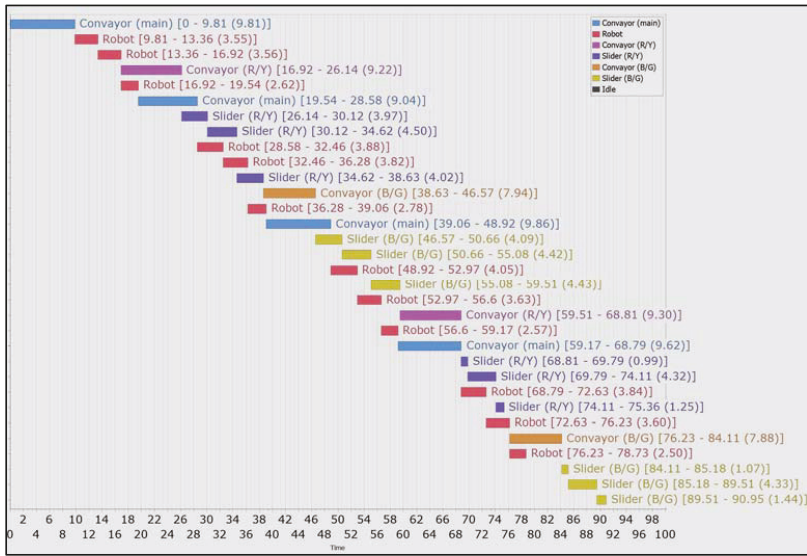

Figure 16. Overall system utilization report.

3.2.1. Main Conveyor

Table 7 shows the time spent by each object to move on the main conveyor. The time is related to the speed of object delivery, meaning that with a decrease of time spent, the speed of object delivery is lower, resulting in a better performance.

From Table 7, it can be seen that the blue object had the fastest delivery time, which is an indication of a minimum utilization time and lesser overall idle time. As for the other objects, there are some factors affecting the time and speed of delivery of the objects, such as the fact that object smoothness and roughness affects the friction and the movement of objects on the conveyor; or the object color intensity, the color sensor on the beginning of the main conveyor does not recognize the object immediately, resulting in a slight increase in the idle time.

Table 7. Object material handling by resources.

Object	Main Conv.	Right Conv.	Left Conv.	Robot Arm	Right Slider	Left Slider
	Utilization Time (s)					
Red	9.81	9.22	-	9.73	12.49	-
Blue	9.04	-	7.94	10.48	-	12.94
Yellow	9.86	9.30	-	10.25	6.55	-
Green	9.62	-	7.88	9.94	-	6.84

3.2.2. Robot Arm

The robot arm moving either to pick or place the object depends on the color sensor at the end of the main conveyor, where it detects the color of the object then sends signals to the robot arm to function, which is why the values of picking and placing objects differ. As for the robot home position after placing all four objects, the values of the time spent are nearly the same, with an average of 2.618 s (Table 7).

### 3.2.3. Side Conveyors

The right conveyor (assigned for red and yellow objects) spends greater time in handling the objects to the slider, whereas the left conveyor (assigned for green and blue objects) spends less time by seconds. At first, when generating the charts and getting these values, it has been thought the values were incorrect because both sides were exactly the same. This led to taking additional videos and repetitive time study to evaluate the conveyor performance again. After applying an accurate time study, especially for this section, and evaluating the data, it turned out that the conveyors were designed with different lengths (right conveyor was 10 cm longer than left one), and the times recorded are correct. Therefore, this great value difference is correct because of the additional length on the right conveyor (Table 7).

### 3.2.4. Sliders

Table 7 also displays the similarity between the red and blue objects, and between green and yellow objects. This points out that the distances of storage units of the blue and red objects are the same, and the storage unit distances of the yellow and green objects are the same. The slight difference in the time values is because of the color sensor detection ability each on slider and processing of each on the bricks (process units).

## 4. Identified Issues and Optimization Suggestions

As part of the objectives of this paper is system optimization, it is essential to point out the issues and problems related to the system performance and prepare a comprehensive overview of them. The most highlighted aspect that has to be optimized in this system is the idle time, as the overall system works well, including some minor problems while performing the process. Table 8 shows that the system has a total utilization time of 151.884 s and 393.822 s of idle time. To calculate the utilization percentage, we add both values to each other, and then divide the busy time by the total time, resulting in 27.83% of utilization.

The partial utilization times belonging to each task are collected in Table 9. This partial time study helps to detect the problems, limitations, and related task/s and resources. In order to optimize the system, this value has to increase, and the idle time has to decrease. After analyzing the overall system utilization report (Figure 16) and predecessors of tasks (Table 6), the importance of decreasing the idle time of the resources will be highlighted more.

Table 6 shows that apart from two periods of time (Task 12, 13 and 20, 21), the other tasks are sequential. This means every task should start after finishing the other one in the other resources. This is the main reason for increasing the non-added value time for most of the resources. By taking a proper action to modify hardware, software, and layout design of the system, it could be optimized and have better performance. Listed in Table 10 are the detected issues and possible solutions to get better performance with time study and visual observation point of view.

**Table 8.** System man/machine utilization report.

Resource	Busy Time (s)	Idle Time (s)	Utilization %
Main Conveyor	15.822	75.129	17.40
Left Conveyor for Blue and Green Objects	38.330	52.621	42.14
Right Conveyor for Red and Yellow Objects	18.516	72.435	20.36
Robot Arm	40.400	50.551	44.42
Left Slider for Blue and Green Objects	19.775	71.176	21.74
Right Slider for Red and Yellow Objects	19.041	71.910	20.94
All Resources	151.884	393.822	27.83

**Table 9.** Time observed from the real system by the time study.

Utilization Time (s)		
Task No.	Task Description	Real
1	Main conveyor handling Red object to Robot	9.81
2	Robot arm picking The Red Object from Main Conveyor	3.55
3	Robot arm placing Red object to Right Conveyor	3.56
4	Right conveyor handling Red object to Right Slider	9.22
5	Robot arm moves to its home position after placing Red object	2.62
6	Right Slider transfers Red object to Red buffer	3.972
7	Right Slider unloading the Red object to Red buffer	4.499
8	Right Slider moves to its home position after unloading Red object	4.018
9	Main conveyor handling Blue object to Robot	9.04
10	Robot arm picking The Blue Object from Main Conveyor	3.88
11	Robot arm placing Blue object to Left Conveyor	3.82
12	Left conveyor handling Blue object to Left Slider	7.939
13	Robot arm moves to its home position after placing Blue object	2.78
14	Left Slider transfers Blue object to Blue buffer	4.09
15	Left Slider unloading the Blue object to Blue buffer	4.419
16	Left Slider moves to its home position after unloading Blue object	4.43
17	Main conveyor handling Yellow object to Robot	9.856
18	Robot arm picking The Yellow Object from Main Conveyor	4.05
19	Robot arm placing Yellow object to Right Conveyor	3.63
20	Right conveyor handling Yellow object to Right Slider	9.296
21	Robot arm moves to its home position after placing Yellow object	2.57
22	Right Slider transfers Yellow object to Yellow buffer	0.985
23	Right Slider unloading the Yellow object to Yellow buffer	4.319
24	Right Slider moves to its home position after unloading yellow object	1.25
25	Main conveyor handling Green object to Robot	9.62
26	Robot arm picking The Green Object from Main Conveyor	3.84
27	Robot arm placing Green object to Left Conveyor	3.6
28	Left conveyor handling Green object to Left Slider	7.883
29	Robot arm moves to its home position after placing Green object	2.5
30	Left Slider transfers Green object to Green buffer	1.069
31	Left Slider unloading the Green object to Green buffer	4.329
32	Left Slider moves to its home position after unloading Green object	1.44

Table 10. Issues and suggestions.

Problems	The rough Motion of the Parts and Inflexibility of the Conveyors to Handle Different Shape of the Material	Conveyors and Sliders Speed	Conveyor and Slider Length	Instability of the Slider's Tray in Slider Units	Robot Failure to Pick and Place the Parts
Problems Observation Method	Visual Time Study	✓	✓	✓	✓
Category of the problem	Software Hardware layout Design	✓	✓	✓	✓
Effective Resources	Main Conveyors Colour sensors Robot Arm Side Conveyors Slider Units	✓	✓	✓	✓
Reason	sharp edges of the selected material and their friction with conveyor guide	Conveyors Motors Speed Conveyors Drive mechanism	conveyors length in Layout design	The Structural design of the Slider Units Tray	main conveyor speed sensor detection accuracy input-output (IO) connection between robot and main conveyor Robot programming accuracy
Solution	Changing the design of lateral guides on conveyors	Changing the conveyor and sliders control program Modification of motion mechanism	Layout design modification calculating the optimum length of conveyors	Redesign of the Slider's Tray to be matched with slider conveyor for more stability	modification of the communication between the master and the robot and the main conveyor slaves modification of sensor detection ranges and improving the robot motion path by increasing the accuracy of the robot program

### 5. OEE Analysis

After the design and implementation of the proposed intelligent material handling system and performance of a comprehensive time study, the outcome was analyzed to get the overall system performance. For this reason, the OEE standard was considered and utilized to reach to this goal. The calculation was performed on Tables 7 and 8 to obtain the partial and overall system performance and consequently prepare the Table 11.

**Table 11.** Overall and partial system performance based on overall equipment effectiveness (OEE) standard.

Resource	Main Conveyor	Left Conveyor	Right Conveyor	Robot Arm	Right Sliders for Red	Right Sliders for Yellow	Left Slider for Blue	Left Slider for Green
Actual Time	38.33	15.82	18.52	40.40	12.49	6.55	12.94	6.84
Expected Time	36.00	15.00	18.00	40.00	12.00	6.00	12.00	6.00
Down Time	2.33	0.82	0.52	0.40	0.49	0.55	0.94	0.84
Total Functional period	68.79	90.95	90.95	90.95	68.81	52.33	84.11	31.44
Idle time	30.46	72.44	75.13	50.55	56.32	45.77	71.17	24.6
Planned Production Time	38.33	18.51	15.82	40.40	12.49	6.56	12.94	6.84
Run Time	36.00	17.69	15.30	40.00	12.00	6.01	12.00	6.00
Availability %	93.92	95.57	96.71	99.01	96.08	91.62	92.74	87.72
Ideal Cycle Time	8.50	7.50	7.50	9.50	11.00	5.00	11.00	5.00
Total Count	4.00	2.00	2.00	4.00	1.00	1.00	1.00	1.00
Good Count	4.00	2.00	2.00	4.00	1.00	1.00	1.00	1.00
Performance%	94.44	84.79	98.04	95.00	91.67	83.19	91.67	83.33
Quality%	100.00	100.00	100.00	100.00	100.00	100.00	100.00	100.00
OEE%	88.70	81.04	94.82	94.06	88.07	76.22	85.01	73.10

OEE percentage is calculated for each part of the system individually (each resource). This percentage provides an accurate view of how effectively the manufacturing process is running. It also makes it easy to track problems and improvements in the system over time. Availability of the resources is the first factor, and is completely dependent on resource downtime, idle time, and planned production time (Figure 17).

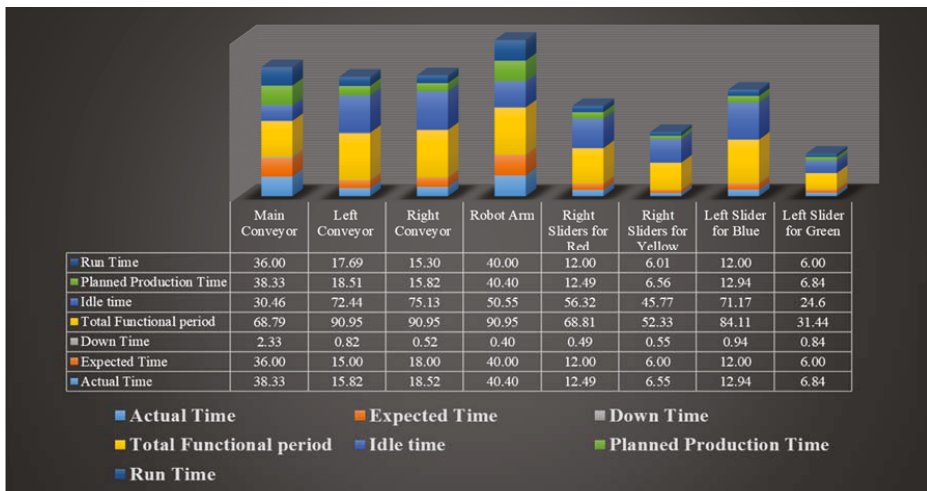

**Figure 17.** Resources timing outcomes.

Figure 18 shows that the availability of all the resources is above 90%, except that of the left slider for sliding green part. This means the overall downtime and breakdowns in the system are not significant in comparison with total functional time. The reason for these deviation from criterion is mentioned in Table 10 as the problem and limitation of the system. The main conveyor has 2.3 s



downtime, which is the result of the inflexibility of the main conveyor for the different shape of objects. In addition, the main conveyor has 30.46s idle time, which is the result of robot downtime of 0.40 s and side conveyors speed limitations. The robot itself has 99% availability because of the total idle time and downtime of 50.49 s out of 90.95 s, which is the minimum value in the comparison between the other resources. In availability percentage analysis, the sliders functionality divided into separated tasks. The reason for this differentiation is the different behavior of sliders to carry the parts to the buffers with different distances. However, as mentioned before, because of physical limitations of the selected system, these breakdowns and downtimes may vary. In order to obtain the most accurate result of the system timing, the observation should be repeated several times in a long period of system functionality. In this research, because of the system limitations, observation have often been conducted instead of increasing the period of functionality.

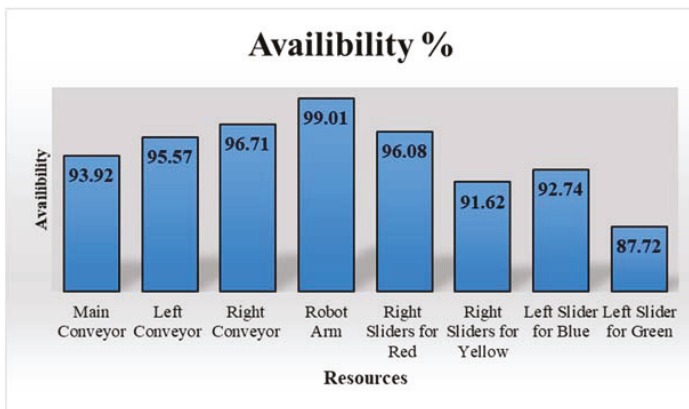

Figure 18. Availability percentage of the resources.

Overall availability of sliders is less than the resources and the reason for this difference is the instability of the slider's tray in slider units while they are performing. Consequently, the slider speed should be kept at a minimum to compensate for this instability. In addition, sliders are the final resources in the system and defined scenario, so that the ratio of their observed idle time and total functional time is less than the other resources. The availability percentage of the left slider for green object is less than the others, at 87.72%. The reason for this percentage drop is the shape of the object, which causes downtime on the main conveyor and breakdown time for robot arm failure to pick and place the object.

Figure 19 illustrates the performance percentage of the available resources in the system. As mentioned before, the performance of the resource is a ratio of ideal cycle time and runtime for a certain number of products. As long as the performance percentage approaches a maximum, it shows the resource has less runtime and more ideal cycle time, and is performing as fast as possible.

The performance of sliders for transformation of yellow and green (sort range of transformation) objects is nearly same, at 83.19% and 83.33%, respectively. Sliders for transferring the red and blue objects have the better performance average of 91.67% for transferring.

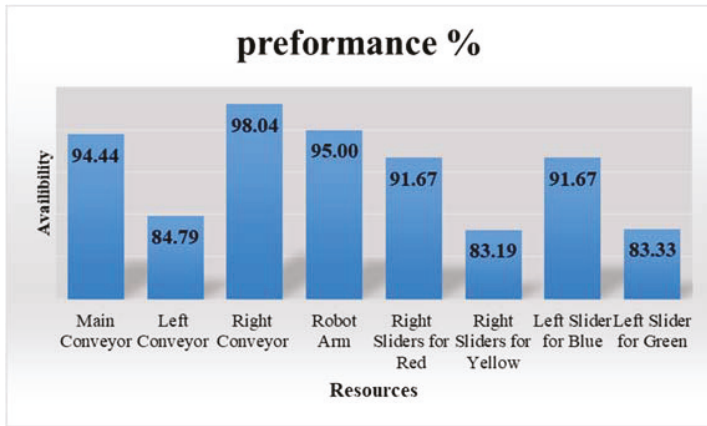

Figure 19. Performance percentage of the resources

Left and right conveyors performance percentages differ dramatically because of the unexpected length inequality (right conveyor is 10 cm longer than the left one). Right conveyor has 13.25% performance percentage in comparison with the left one. Although the right conveyor is longer, it has higher performance. This difference shows that the right conveyor performs with a better speed and with less downtime. In addition, the performance of the side conveyors is totally dependent on the ideal cycle time, runtime, and total good counted products. Furthermore, total good counted products and ideal cycle time for both conveyors is considered as the same. Thus, the only reason for this issue should be the runtime. Runtime is affected by the idle time and downtime, which are both significantly less in value in the right conveyor. It is considerable to mention that idle and downtimes are effacing by the other resources in addition to the conveyors itself. This means that although the right conveyor is 10 cm longer than the left one, the proper value of run and downtime compensates for this difference and gives a better performance as the result.

As mentioned before, OEE percentage of the resources is the percentage multiplication of availability, performance, and quality. As the considered system in this research is a product distribution cell, all of the loading objects (products) loading into the system are assumed as passed quality products and the quality percentage for all system resources is considered as 100%. Figure 20 shows the OEE percentage of the resources individually. The effect of the mentioned issues and limitations of the system in Table 10 is detectable on the OEE percentage of each resource. The problems occurred because rough motion of the parts and inflexibility of the conveyors to handle different shape of material and color detection limitation of the products have been neglected as a result of the assumption that all of the products are good quality products. As OEE is affected by availability and performance, its percentage is a proof of all of the identified issues and limitations by time study. This means that for an improvement and optimization idea on the system, OEE evaluation is an appropriate standard, besides time study.

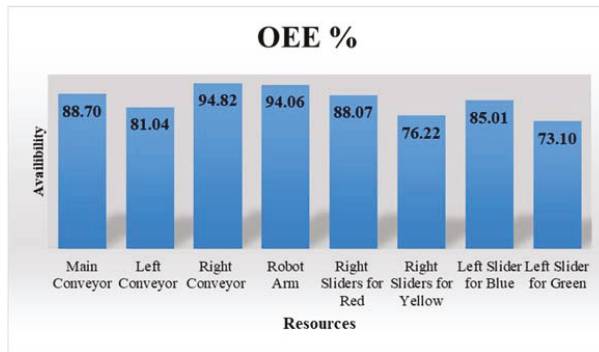

Figure 20. Overall equipment effectiveness (OEE) percentage of the resources.

As mentioned before, after analyzing the importance of timing in OEE, the sustainability of the system should be investigated. To reach to this goal, steps to evaluating the manufacturing sustainability will be explained accordingly. As the first step, the environmental impacts of the manufacturing system should be identified. Table 12 shows that out of the main environmental impact related to the manufacturing sector, only energy consumption could be considered, and it is the only and highest priority. The reason for this selection is the type of energy resources used for the system equipment. As the source of electricity is not one of the common electricity resources, there would be no other impact other than energy intensity.

Table 12. Mapping impact and set priorities of the selected manufacturing system.

Mapping Impact and Set Priorities			
Impacts	Definition		priorities
Water intensity	Consumption of water per unit of output	Not Selected	0
Residuals intensity	Generation of wastes per unit of output	Not Selected	0
Energy intensity	Energy consumed per unit of output	Selected	1
Renewable proportion of energy consumed	Used Energy from Sustainable Resources (%)	Not Selected	0
Greenhouse gas (GHG) intensity	GHGs produced during production per unit of output	Not Selected	0
Intensity of residual releases to air	Release of air emissions per unit of output	Not Selected	0
Intensity of residual releases to surface water	Release of effluents per unit of output	Not Selected	0
Natural Cover	The proportion of land occupied that is natural cover	Not Selected	0

For the next step, the most useful and effective performance indicator should be selected. Because of a part of the objective of this research, time is the selected performance indicator and the other factors are neglectable because of the real selected manufacturing system (i.e., quality and quantity).

In the measurement layer of the investigation of manufacturing sustainability, the influence of the manufacturing system material and components on the selected environmental impact, which is energy consumption in this research, should be investigated. Table 13 shows the effective material and component and their impact on energy intensity in the selected manufacturing system (Table 13).

Table 13. Measurement layer of the investigation of manufacturing sustainability.

Manufacturing System	Related Devices	Energy Consumption Reason	Energy Resource
Intelligent material handling system	Conveyors	Motors related to conveyor motions	Electricity
	Sliders	Motors related to Slider motions	
	Robot Arm	Motors Related to Robot Motions	
	Control units	processing the data	
	Sensors	excitation signal	

Considering the time effectiveness in OEE and the analytical methodology that has been utilized in this research, the relationship between time and energy consumption has been investigated.

As the result of the time study of the considered system, the efficiency of the system is time-dependent. This means that by optimizing the system from any point of view (hardware, software, and layout design optimizations methods), manufacturing times will be directly affected. On the other hand, energy consumption of the equipment or among the whole of the enterprise has a direct relationship with device utilization time (and even idle time in some cases). OEE results show, for a constant amount of good quality products in the target system, increasing the utilization time and decreasing the idle time increase the performance and the availability of the system consequently. Even if the utilization time of the equipment and devices will be kept constant without increasing, by optimizing the system, the idle time will be decreased, and energy consumption will be decreased accordingly.

According to OECD rules, the time is the only selected factor out of the other effective factors in manufacturing system performance for the target system. Electricity consumption is the only source of energy in energy intensity as the only category of factors with impact on manufacturing sustainability. In this case, in order to have more sustainable manufacturing, the amount of consumed electricity should be minimal (Figure 21). The only way to reach this goal in the target system is reducing the idle times and increasing the utilization time.

As mentioned before, because of the property of the selected system (small-scale educational system) and the energy resource that has been used to power the system, the calculation of the energy consumption, and the possible difficulties that might occur to find the influence of the OEE percentage on manufacturing sustainability, need a proper industrial manufacturing system with a long period of functionality for time and energy consumption observation.

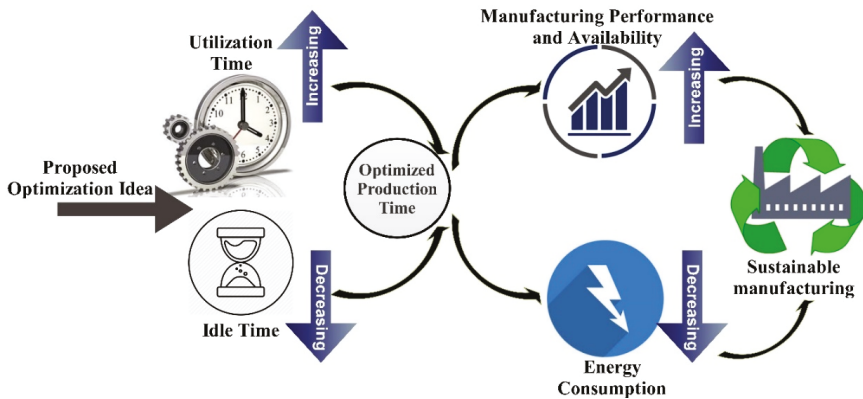

Figure 21. Manufacturing sustainability based on OEE and the Organization for Economic Cooperation and Development (OECD).

## 6. Conclusions

In this research, an intelligent material handling system for product or object differentiation has been designed and implemented. The developed system has been considered as an example of SMEs with a simple manufacturing system. A specific algorithm has been created to deploy an agent base control architecture across the system. By utilizing this control algorithm and intelligent components, the system approaches to Industry 4.0 manufacturing paradigm. To investigate the difficulties of implementation of Industry 4.0 for such a system as SMEs, for example, the system functionality has been evaluated concerning different manufacturing aspects. To evaluate the system, time has been focused on as the most effective factor between the other manufacturing aspects. OEE has been selected

as the standard for measuring manufacturing productivity to highlight the influence of time. As time is the main variable on calculation of the availability, performance, and consequently OEE percentage, a proper time study has been performed on the system. The results of time study extract some issues and limitations in the system during the preforming. The time study result has been categorized to be utilized in calculation of availability, performance, and OEE of each device. The obtained result of the time study and OEE could be used to evaluate any change or optimization methods to improve the productivity. In general, reduction in the expenditure of over timing, deferment of investments of larger capital, reduction in downtime/idle time, and improvement in the performance of the operator are the benefits of OEE for SMEs. In addition, based on OECD rules, the relationship between OEE results and manufacturing sustainability described with selecting the time and consumed electricity as main effective factors for OEE and OECD, respectively. To sum up, this study has tried to provide a solution for SMEs to make smooth implementation of a sustainable, intelligent manufacturing system considering the Industry 4.0 preparation requirements. The only case study in this research is a small-scale educational manufacturing system. Because of this selection, the research and the proposed methodology have been conducted on a system that might have different properties and functionality in comparison with real industrial manufacturing systems. The case study system production time is limited to a short period. Furthermore, the system has been developed utilizing educational components, which is not correct to run the experiment repeatedly over a long period. Thus, investigation of the proposed method on more industrial manufacturing systems as the case study, and choosing the ones with ability to run the experiment for long times, are considered as the future work of this research.

**Author Contributions:** Conceptualization, P.G.Y. and A.A.; Methodology, P.G.Y.; Software, P.G.Y.; Validation, P.G.Y., A.A. and M.H.; Formal Analysis, P.G.Y.; Investigation, P.G.Y., A.A.; Resources, P.G.Y.; Data Curation, P.G.Y. and A.A.; Writing-Original Draft Preparation, P.G.Y.; Writing-Review & Editing, P.G.Y. and A.A.; Visualization, P.G.Y.; Supervision, A.A. and M.H.; Project Administration, A.A.

**Acknowledgments:** This research was supported by German university of technology in Oman (GUtech). We thank our colleagues from GUtech who provided insight and expertise that greatly assisted the research.

**Conflicts of Interest:** The authors declare no conflict of interest.

## References

1. Silver, E.A.; Pyke, D.F.; Peterson, R. *Inventory Management and Production Planning and Scheduling*; Wiley: New York, NY, USA, 1998.
2. Cachon, G.P.; Fisher, M. Supply chain inventory management and the value of shared information. *Manag. Sci.* **2000**, *46*, 1032–1048. [[CrossRef](#)]
3. Caldeira, M.M.; Ward, J.M. Using resource-based theory to interpret the successful adoption and use of information systems and technology in manufacturing small and medium-sized enterprises. *Eur. J. Inf. Syst.* **2003**, *12*, 127–141. [[CrossRef](#)]
4. Hashim, N.D. *Time Study Method Implementation in Manufacturing Industry*; Universiti Teknikal Malaysia: Melaka, Malaysia, 2008.
5. Azizi, A. Introducing a novel hybrid artificial intelligence algorithm to optimize network of industrial applications in modern manufacturing. *Complexity* **2017**, *2017*. [[CrossRef](#)]
6. Kathurima, R.I.; Ombul, K.; Iravo, M.A. Effects of materials handling systems on performance of cement manufacturing firms in Machakos County. *Int. Acad. J. Procure. Supply Chain Manag.* **2016**, *2*, 21–36.
7. Jarrahi, F.; Abdul-Kader, W. Performance evaluation of a multi-product production line: An approximation method. *Appl. Math. Model.* **2015**, *39*, 3619–3636. [[CrossRef](#)]
8. KOSTER, R.D.; Wijngaard, J. Local and integral control of workload. *Int. J. Prod. Res.* **1989**, *27*, 43–52. [[CrossRef](#)]
9. Ramesh, C.; Manickam, C.; Prasanna, S. Lean Six Sigma Approach to Improve Overall Equipment Effectiveness Performance: A Case Study in the Indian Small Manufacturing Firm. *Asian J. Res. Soc. Sci. Hum.* **2016**, *6*, 1063–1072. [[CrossRef](#)]

10. Benjamin, S.J.; Marathamuthu, M.S.; Murugaiah, U. The use of 5-WHYs technique to eliminate OEE's speed loss in a manufacturing firm. *J. Qual. Maint. Eng.* **2015**, *21*, 419–435. [[CrossRef](#)]
11. Yasin, M.F.; Das, G.S. A new approach based on OEE to improve equipment effectiveness in SMEs: An application in a wood processing facility. *J. Fac. Eng. Archit. Gaz.* **2017**, *32*, 45–52.
12. Iannone, R.; Nenni, M.E. Managing OEE to optimize factory performance. In *Operations Management*; InTech: London, UK, 2013.
13. Fam, S.-F.; Loh, S.L.; Haslinda, M.; Yanto, H.; Khoo, L.M.S.; Yong, D.H.Y. Overall Equipment Efficiency (OEE) Enhancement in Manufacture of Electronic Components & Boards Industry through Total Productive Maintenance Practices. In Proceedings of the Malaysia Technical Universities Conference on Engineering and Technology, Penang, Malaysia, 6–7 December 2017; MATEC Web of Conferences, EDP Sciences: Les Ulis, France, 2018.
14. Kumar, J.; Soni, V.; Agnihotri, G. Maintenance performance metrics for manufacturing industry. *Int. J. Res. Eng. Technol.* **2013**, *2*, 136–142.
15. Marri, H.; Gunasekaran, A.; Grieve, R. An investigation into the implementation of computer integrated manufacturing in small and medium enterprises. *Int. J. Adv. Manuf. Technol.* **1998**, *14*, 935–942. [[CrossRef](#)]
16. Thurman, J.E.; Louzine, A.; Kogi, K. *Higher Productivity and a Better Place to Work: Practical Ideas for Owners and Managers of Small and Medium-Sized Industrial Enterprises*; International Labour Organization: Geneva, Switzerland, 1988.
17. Singh, M.; Narwal, M. Measurement of Overall Equipment Effectiveness (OEE) of a manufacturing industry: An effective lean tool. *Int. J. Recent Trends Eng. Res.* **2017**, *3*, 268–275.
18. Esmaeel, R.I.; Zakuan, N.; Jamal, N.M. The Mediating Role of Overall Equipment Effectiveness on the Relationship between Fit Manufacturing and Business Performance. *Int. J. Eng. Technol.* **2018**, *7*, 1089–1093. [[CrossRef](#)]
19. Ylipää, T.; Skoogh, A.; Bokrantz, J.; Gopalakrishnan, M. Identification of maintenance improvement potential using OEE assessment. *Int. J. Prod. Perform. Manag.* **2017**, *66*, 126–143. [[CrossRef](#)]
20. Webster, D.B.; Reed, J.R.R. A material handling system selection model. *AIIE Transactions* **1971**, *3*, 13–21. [[CrossRef](#)]
21. Michalos, G.; Makris, S.; Papakostas, N.; Mourtzis, D.; Chryssolouris, G. Automotive assembly technologies review: challenges and outlook for a flexible and adaptive approach. *CIRP J. Manuf. Sci. Technol.* **2010**, *2*, 81–91. [[CrossRef](#)]
22. Jonsson, P.; Lesshammar, M. Evaluation and improvement of manufacturing performance measurement systems—the role of OEE. *Int. J. Oper. Prod. Manag.* **1999**, *19*, 55–78. [[CrossRef](#)]
23. Kumar, D.; Mandloi, R. Analysis & prospects of modification in belt conveyors. *IJERA* **2013**, *3*, 581–587.
24. Stevenson, W.J.; Hojati, M. *Operations Management*; McGraw-Hill/Irwin: Boston, MA, USA, 2007.
25. Babu, V.R. *Industrial Engineering in Apparel Production*; Woodhead Publishing Limited: Cambridge, UK, 2012.
26. Organisation for Economic Co-operation and Development. *Seven Steps to Environmental Excellence*; OECD: Paris, France, 2014.
27. Roni, M.; Jabar, J.; Mohamad, M.; Yusof, M. Conceptual study on sustainable manufacturing practices and firm performance. In Proceedings of the International Symposium on Research in Innovation and Sustainability (ISO-RIS), Melaka, Malaysia, 15–16 October 2014; pp. 1459–1465.
28. Lai-Ling Lam, M. Challenges of sustainable environmental programs of foreign multinational enterprises in China. *Manag. Res. Rev.* **2011**, *34*, 1153–1168. [[CrossRef](#)]
29. May, A.D. Urban transport and sustainability: The key challenges. *Int. J. Sustain. Transp.* **2013**, *7*, 170–185. [[CrossRef](#)]
30. Azizi, A.; Ghafoorpoor Yazdi, P.; Humairi, A. Design and fabrication of intelligent material handling system in modern manufacturing with industry 4.0 approaches. *Int. Robot. Autom. J.* **2018**, *4*, 186–195.



© 2018 by the authors. Licensee MDPI, Basel, Switzerland. This article is an open access article distributed under the terms and conditions of the Creative Commons Attribution (CC BY) license (<http://creativecommons.org/licenses/by/4.0/>).

Article

# Antecedents to Digital Platform Usage in Industry 4.0 by Established Manufacturers

Julian Marius Müller

Department of Logistics and Operations Management, Salzburg University of Applied Sciences, 5412 Puch bei Hallein, Austria; julian.mueller@fh-sazburg.ac.at

Received: 26 December 2018; Accepted: 18 February 2019; Published: 20 February 2019

**Abstract:** Digital platforms are expected to have the potential for a multitude of purposes for industrial enterprises, for instance when integrated within the concept of Industry 4.0. Despite its relevance for industrial value creation, little research on platforms in the industrial context has been undertaken so far. Owing to the lack of research in this field, the paper aims to investigate the potentials and challenges of digital platforms in order to generate an understanding of the antecedents to the use of digital platforms by established manufacturers. In the qualitative-exploratory study, the paper uses a qualitative empirical research approach, relying on in-depth expert interviews. The sample comprises interviews with managers of 102 German and Austrian industrial enterprises from several industrial sectors. All of the enterprises regarded have practical experiences with digital platforms. The results show that the main potentials of digital platforms are reducing transaction costs, combining strengths of enterprises, and realizing economies of scale as well as economies of scope. Yet, digital platforms bring challenges, such as a lack of trust, competitive thinking, high coordination efforts, and loss of confidential information. The paper further distinguishes between various industry sectors revealing interesting differences. Based on the results, the paper indicates possibilities for future research and provides corporate practice with implications.

**Keywords:** Industry 4.0; industrial internet of things; digital transformation; digital platforms; qualitative-empirical study; small and medium-sized enterprises

---

## 1. Introduction and Problem Outline

Industry 4.0 is expected to lead to vertically and horizontally interconnected industrial value creation networks [1,2]. In this context, the industrial landscape is predicted to undergo fundamental changes, accompanied by benefits, but also several challenges [3]. Because of its technological and economic implications, Industry 4.0 has the potential to transform ordinary industrial value creation of industrial companies and relocate it onto digital platforms [4].

When companies engage in digital platforms, those are expected to create novel economic ecosystems and revolutionize future value creation [5]. Via their virtual interconnection on digital platforms, several entities are combined on one single space for gathering, processing and managing data. So-called multi-sided platforms combine customers, suppliers, and partners on one single platform, serving all stakeholders' interests [6]. By engaging in platforms, stakeholders lay the foundation for new forms of interaction between stakeholders inaugurating new ecosystems. In the consumer industry, platform providers already have radically transformed traditional businesses, e.g., Airbnb, Amazon, and Alibaba [4]. Thus, platforms also pave the way for new, innovative business models in the industrial sector [7].

Up to now, using digital platforms in the industrial sector are yet to grow due to some unsolved theoretical and practical issues. Whereas companies in the information technology sector have been developing such platforms for years [5], industrial companies are still significantly less active on



this path [8,9]. It remains unclear which potentials digital platforms imply for the industrial sector, as developments unfolding in business to consumer (B2C) markets might have different effects in the business to business (B2B) context [10]. Further, there are challenges caused by remaining questions, for instance, data ownership, management and control of platforms, and relationships between the entities [11]. Addressing these questions and solving these issues is of high importance, as digital platforms are expected to generate large potential for industrial value creation [7].

Despite its relevance, little research on digital platforms in the industrial context has been undertaken so far. This raises calls for empirical research that helps to better understand challenges and potentials, as well as practical experiences gained in the field [12].

Given its importance for future value creation, research has lately begun to turn its focus on platforms. So far, most academic studies so far almost exclusively examine platforms of non-industrial contexts, neglecting digital platforms in industrial contexts and their potential and challenges respectively [13,14]. In response, research calls for studies that complement the findings of digital platforms in a B2C context [3,10,12].

Digital platforms in the context of Industry 4.0 are scarcely understood, calling for research for the underlying benefits and challenges by academic papers [3,10,12–14]. The extant literature in the field of digital platforms is quite sparse, and a comprehensive understanding of digital platforms in an industrial context has not been developed yet [3,10–12].

For instance, the majority of the papers that examine digital platforms in the industrial contexts from an empirical perspective so far rely on single cases, but are not able to generate a holistic understanding of digital platforms [5,10,12]. However, a comprehensive overview of potentials and challenges provides a fruitful insight for academia, as described by several authors [3,10]. Platforms in the industrial context are just beginning to generate high interest, but also concerns of industrial manufacturers [1,4]. Relating to this early stage of development, but the numerous potentials known from B2C contexts, research is required in order to investigate the possibilities to transfer digital platforms to the B2B context [5,10]. Furthermore, the specific requirements and challenges of digital context need to be investigated in detail [3,11].

Additionally, it has been found that in the case of Industry 4.0 as well as for digital platforms, industry-specific differences can be observed regarding the implementation and unfolding of Industry 4.0 and digital platforms respectively [3,5,10,12]. Hence, this paper attempts to compare the findings among several industry sectors.

In sum, the following research questions are addressed within this paper:

RQ 1: What are the underlying challenges that impede the unfolding of digital platforms in an industrial context?

RQ 2: Which are the potentials that can be achieved through the usage of digital platforms in an industrial context?

RQ 3: How do challenges and potentials of digital platforms in an industrial context differ among industry sectors?

Concomitant with the high interest of academia in digital platforms, the paper further intends to investigate digital platforms from the perspective of corporate practice. Therefore, the paper aims to provide insights about the potential of digital platforms and reasons to use them in corporate industrial value creation. In addition, the paper indicates challenges of platforms, unveiling critical aspects of platform usage and differentiate those for different industry sectors. In that way, industrial firms shall receive as close guidance as possible for their respective requirements and frame conditions.

The remainder of the paper is organized as follows. In Section 2, Industry 4.0 and digital platforms are introduced, whereas Section 3 describes the method. Section 4 presents the results, providing a comprehensive overview of benefits and challenges of digital platforms. Based on the empirical findings of this paper, those are discussed with extant literature in Section 5, highlighting the theoretical



contributions of this paper. The paper further provides managers with practical implications, followed by limitations and suggestions for future research in Section 6.

## **2. Theoretical Background**

### *2.1. Industry 4.0*

The term Industry 4.0 refers back to a concept of the German federal government and indicates a *de novo* change of paradigm in industrial value creation. The concept aims at shifting the industrial value creation towards the digital future to secure the future competitiveness of the industrial sector [2]. It is based on the expectation that industrial value creation is about to undergo a fourth industrial revolution [1]. The first three industrial revolutions have led to significant increases in productivity [15]. They were driven by technological developments such as mechanization, electrification, and the application of information technologies, respectively [16].

Cyber-physical systems form the technological basis of Industry 4.0, enabling real-time interconnection of the physical and virtual world as well as smart data analyses [17]. These systems offer mechanisms for human-to-human, human-to-object, and object-to-object communication. Their application in industrial production leads to cyber-physical production systems [18] enabling condition monitoring, preventive diagnostics and maintenance, and self-regulating control of machines [19]. Applying these systems and functions within the industrial context paves the way for creating a so-called smart factory. In turn, connecting several smart factories leads to smart production networks that represent whole supply chains [20–22].

Industry 4.0 is a concept that is based on the Internet of Things. Relating to an application of the Internet of Things in industry, it is sometimes described as an equivalent to the Industrial Internet of Things [1,2]. Still, the exact definition of Industry 4.0 remains disputed. It varies among academic disciplines, and aspects relevant for each discipline tend to be highlighted [23]. Most authors relate to horizontal and vertical interconnection across the life cycle of products, machines and humans by the means of cyber-physical systems in real time [1,7,23]. However, the majority of current definitions or understandings of the term Industry 4.0 does not include a management perspective. Hereby, management of digital transformations, for instance of business models, can be regarded as a central aspect of Industry 4.0 [3,7,23].

Similar concepts to the German Industry 4.0 emerge worldwide [24]. These include the Industrial Internet Consortium in the USA [25], the Internet Plus concept within the Made in China 2025 program in China [26], and Manufacturing Innovation 3.0 in South Korea [27].

These attempt to help companies managing and coping with changing environmental conditions such as globalization, increased uncertainty of markets, intensified competition, shortened innovation and product life cycles. Further potentials include flexibility and productivity increases, development of new business models, ecological potentials such as reducing energy consumption, and social potentials like smoothly integrating people into adaptive working environments [1,14]. The reasons for adopting Industry 4.0 technologies differ depending on several company characteristics [28].

Industry 4.0 is expected to pose several challenges to existing companies including high investments, disrupted existing business models, and employees' fear to be replaced [3]. These challenges are especially harmful for small and medium-sized enterprises (SMEs), which are frequently intimidated and ask for special attention [7].

So far, research has primarily focused on technological aspects of Industry 4.0. In contrast, economic aspects of Industry 4.0 have been less regarded [23,24,29,30]. This contrasts with Industry 4.0 promising new, data-centric, and platform based business models with large potentials for industrial manufacturers, which research has examined scarcely [3,31,32].

## 2.2. Digital Platforms

Digital platforms are expected to create novel economic ecosystems and revolutionize value creation [5]. They have numerous implications for industrial value creation, including the transformation of value chains into digital value creation networks [4]. By gathering, managing, and analyzing data, platforms unite, e.g., partners, customers, and suppliers on one platform serving the interests of several players [3,6,31]. In general, digital platforms are expected to foster innovation and collaboration between partners by easing communication and coordination among several stakeholders [21,32]. Further, customers can be integrated into the value creation process [33], e.g., in open innovation contests [34]. Because platforms open up new perspectives as well as new forms of interactions and relationships, they provide the basis for creating new business models [35].

In the study, digital platforms are understood as “products, services, and technologies that are organized in a common structure through which a company can create derivative products, services, and technologies” [5]. They in turn provide the basis for external companies to be able to contribute their products, technologies, and services. Thereby, they pave the way for new economic ecosystems as well as new logics for value creation [5,35]. Furthermore, the paper uses the extension of the definition by Hagiu and Wright [6] according to whom “multi-sided platforms” are characterized by two core elements: First, these platforms must enable direct interaction between two or more players while, second, each player is connected to the platform. As a result, the digital platform fulfills the needs of several customer groups, combining their needs for which a common business model finds synergies and compound effects [5,6].

In that sense, digital platforms differ from traditional technology platforms. Such technology platforms are typically characterized by the provision of several products and services by a platform provider to its customers. The combination of several customer groups, that can also partially serve as providers of, for instance, data for other customers, as well as their interconnection in real time is not seen in traditional technology platforms [5,6,10]. Hence, the technological requirements, as well as the underlying logics for value creation for the customers, differ significantly between technology platforms and digital platforms.

Information technology companies have been developing such platforms for years [36], while the rather traditional industrial sector undertakes less effort in this respect [8]. In particular in the industrial context, established enterprises face the challenge to find partners to create digital platforms and to develop new competitive business models [9,37]. In addition, digital platforms call for the development of adequate IT competencies, which does not represent a core competence of traditional industrial manufacturers [38]. Additionally, further issues remain unresolved, such as, to whom data belongs to, how to control such platforms, and how to manage the relationships between players adequately [11].

Despite the relevance of platforms, especially for the industrial context, there are hardly any scientific studies examining the effects and implications of digital platforms from a management perspective or in an industrial context [12–14]. In addition, existing research rather refers to a specific understanding or to partial aspects than generating a holistic picture [8,11,39–41]. Nevertheless, digital platforms help addressing future challenges that should call for researchers’ interest [12]. New, data-centric business models are expected through platforms within the concept of Industry 4.0 [42]. Further, some authors show successful application examples of platforms in the context of the Internet of Things [43–46].

## 2.3. The Interplay of Industry 4.0 and Digital Platforms towards Sustainability

Industry 4.0 is expected to generate numerous benefits towards sustainability in the context of the Triple Bottom Line, i.e., economic, ecological and social benefits. Concomitant challenges in all three dimensions of the triple bottom line of sustainability have to be considered. This is especially the case for their interplay, for instance short-term economic efforts that are necessary to achieve long-term benefits in all three dimensions of sustainability, has just started to be considered from an academic perspective. However, understanding the interdependencies between the three dimensions

of the Triple Bottom Line in the context of Industry 4.0 is of vital importance in order to support its implementation [3,26,28].

From an economic perspective, process efficiency can be increased on an operational level through interconnection along the supply chain [1,5]. Relating to the use of digital platforms, production capacities among several production plants can be coordinated, whereas logistics processes can be better aligned. Hereby, digital platforms can serve as the communication and coordination means among several enterprises, especially among multiple stakeholders in a supply chain [3]. This also contributes to the ecological benefits of Industry 4.0, for instance, through the reduction of transport routes, reduction of energy consumption, or reduction of idle times and downtime. Further benefits include a reduction of waste and enhanced recycling processes. [3,28]. Digital platforms can assist here not only to optimize production and logistics processes from an economic, but also from an ecological perspective [3,26]. However, increased energy consumption through emerging new technologies, such as server capacities and data transmission on data hubs through digital platforms, must not be neglected as a negative ecological effect of digital platforms [26]. Furthermore, especially SMEs are reluctant to share information and data digitally, as they fear to become more transparent. As a result, they fear, for instance pressure to lower prices through increased transparency to larger enterprises with a higher bargaining power, among other possible scenarios [7].

On a strategic level, new business models shall be developed in the context of Industry 4.0. In this regard, digital platforms are seen in a prominent manner as a means to generate novel business models [1]. For instance, data generation, data transmission and data evaluation can be eased through the use of digital platforms. However, emerging new business models also raise fears of established firms that not them, but the platform providers will be able to generate value that the customers are willing to pay for. Consequently, established firms fear being driven into niche segments, losing their established market shares and revenues through the emergence of digital platforms [3,7].

From a social perspective, Industry 4.0 is expected to generate several benefits for employees. One example includes workers on the shop floor, for which the reduction of monotonous tasks or physically exhausting process steps can be achieved through new technologies housed under the term Industry 4.0, such as human–machine interaction systems, collaborative robotics, or augmented reality, among further examples [1,3]. However, the introduction of new, data-driven technologies also raises fears among employees to be replaced thorough machines, to be transparent and subject to data collection, and to lose decision power to artificial intelligence [3,28].

With regard to the use of data-driven approaches, innovation management shall be enhanced in Industry 4.0, for instance, through an eased backflow of data from products in use to product development. Thereby, product development can be improved while also including ideas of several stakeholders in the supply chain, or additionally including the ideas of the customers. In this context, digital platforms can help to bundle information related to product usage and customer requests on a common platform to which all stakeholders of a platform have access. Using this approach, the fear that one stakeholder in the supply chain might become to dominant can be decreased [1,3]. Still, SMEs are again reluctant to share such information, as they fear losing market share and confidential information to competitors [7].

In sum, it has to be noted that digital platforms in the context of Industry 4.0 could lead to benefits in all three dimensions of the Triple Bottom Line of Sustainability. So far, little is known about the antecedents that influence platform usage and therefore their broader implementation. This paper is therefore devoted to give insights on the little regarded topic of digital platforms usage by established manufacturers.

### **3. Methodology**

#### *3.1. Research Design*

The paper is of exploratory nature since management research does not provide an integrative, holistic, and systematic investigation of Industry 4.0 platforms so far. Following common research practice, a qualitative empirical research approach based on inductively analyzed in-depth expert interviews is applied [47,48]. This method was chosen for several reasons: First, it is well-suited for analyzing contemporary, novel and complex phenomena within their real-life contexts [49–51], which is true for Industry 4.0 platforms. Second, qualitative research has proven to be effective in the context of information systems that constitute the core of Industry 4.0 technologies [52]. Third, relying on multiple interviews instead of a single case increases the robustness and generalizability of the findings [48].

#### *3.2. Data Sample*

In the qualitative research, semi-structured in-depth expert interviews with managers from corporate practice are used as main source of empirical material [52]. This approach facilitates a structured data collection, while maintaining the level of openness to allow unexpected and novel knowledge to emerge, which corresponds to the exploratory nature of this study [50,53].

Between December 2016 and May 2017, 494 German and Austrian managers of companies with varying firm sizes and from varying industry sectors were randomly selected and contacted via email. The companies were asked to present their most suitable representative regarding Industry 4.0 and digital platforms. Regarding digital platforms, the companies as well as their representative were required to have practical experience, which as validated in the first part of the questionnaire. In total, a final sample of 102 enterprises that participated in the study was achieved, resembling a response rate of 20.65 per cent. These include mechanical and plant engineering (n = 37), electrical and ICT engineering (n = 25), plastics engineering (n = 14), steel and metal processing (n = 12), automotive (n = 8), wood processing (n = 5), and a single participant from the medical engineering industry.

All of the representatives are experienced in the implementation of Industry 4.0, which was ensured by the interview results and secondary case data. Furthermore, all of the companies are using at least one digital platform. In this regard, all 102 companies use supply chain management or purchasing platforms. Moreover, 46 of the 102 companies use production management platforms, e.g., for scheduling and coordinating production capacities. Also, 22 out of the 102 companies are using innovation management platforms, that can be used for sharing and commonly developing ideas among several enterprises. Finally, five out of 102 companies have launched their own digital platform, and are simultaneously using digital platforms in the contexts named above. The low number of only five enterprises can be reasoned by the early stage of implementation of digital platforms that are provided by established manufacturers themselves [1,3].

The average turnover is 123.86 million euros with an average of 590 employees. Regarding annual sales 62 out of 102 enterprises can be classified as SMEs with an annual turnover below 50 million euros, according to the definition of the European Union [7]. A detailed list of interviewees can be found in Appendix A. The heterogeneity of the empirical material counteracts potential negative effects of sample bias on the findings and follows Yin's [50] recommendation for multiple case study sampling.

Germany and Austria were chosen because of their representative character for developed and industrialized economies, their importance for the European market, and their advanced experiences in Industry 4.0. The sectors chosen are among the industries that contribute the most to the gross domestic products of Germany and Austria respectively. Furthermore, Industry 4.0 mainly targets these industries [1].

The interviews lasted between 35 and 80 min. They were conducted in German, the native language of the interviewees and interviewers, to avoid language or cultural barriers, and to ensure comparability. For confidentiality reasons, the interviewees' data is anonymized.

Corresponding to the exploratory nature of the study, the development of the interview guide was informed by literature but followed the principle of openness and flexibility. Thereby, it allowed unexpected and novel topics to emerge [54]. It consists of three parts. The first part aims at verifying the interviewees' reliability and knowledgeability. Therefore, it deals with general and personal questions, e.g., the expert's job position, company tenure, and understanding of Industry 4.0 and digital platforms. The second part contains questions about benefits that the respective companies faces in the context of digital platforms:

- Which company-internal economic benefits did you experience by using digital platforms?
- Which economic benefits achieved together with other platforms members did you experience by using digital platforms?
- Which further benefits did you experience by using digital platforms?

The third part of the interview guideline includes questions about challenges related to the usage of digital platforms. The questions are mainly inspired by the framework of Kiel et al. [3], relating to challenges experienced in economic, social, technical and legal terms:

- Which economic challenges did you experience by using digital platforms?
- Which organizational, relating to company-internal challenges did you experience by using digital platforms?
- Which organizational, relating to challenges with other platform members did you experience by using digital platforms?
- Which technical challenges did you experience by using digital platforms?
- Which legal challenges did you experience by using digital platforms?

### *3.3. Data Analysis and Reliability of the Study*

The empirical material is analyzed applying a qualitative content analysis in accordance with the well-established procedure of Miles and Huberman [55]. The transcription of the 102 audio-recorded interviews resulted in almost 1200 pages of text material. A qualitative content analysis is applied to identify and interpret common patterns, themes, and categories of the interviews. The categories are mainly defined inductively but are also informed by extant literature, allowing novel aspects and concepts to emerge [56–58]. For triangulation purposes, expert interviews are verified using secondary data, e.g., annual reports, whenever possible [50,59].

To increase methodological rigor, the paper follows the established procedure of Gioia, Corley, and Hamilton [56]. Initially, first-order (informant-centric) concepts were developed. Subsequently, these concepts were synthesized into second-order themes, followed by the creation of final categories. The entire coding process was conducted in a team comprised of the study's authors to achieve rich interpretations and profound understandings [60]. Finally, a frequency analysis according to Holsti [61] was conducted. Key informant and retrospective biases are addressed by selecting experts who are experienced, assuring all interviewees of full anonymity and confidentiality, and using secondary data for triangulation reasons [48,50,62]. This approach helps to further increase the robustness of the results as well as to account for routine criticisms in qualitative research designs [48,50].

## **4. Empirical Results**

### *4.1. Potential of Digital Platforms*

The results indicate several potentials for digital platforms which are presented in Table 1. The most important potential of digital platforms is reducing transaction cost which is mentioned by 53 out of 102 interviewees. The reduction of transaction cost is mainly caused by two developments. First, one common platform allows establishing standards, interfaces, and norms. This helps to overcome issues that would be the result of differing standards, interfaces, and norms, e.g., slower

data exchange, non-value adding processes, and loss of data. Second, interactions and communication via platforms are more efficient than regular forms of doing business. Instead of having a multitude of interaction and communication channels, a platform provides an exclusive way to consolidate all transactions. According to the interviewees, this helps to support and relieve employees in communication, relating to potential social benefits.

As mentioned by 23 interviewees, combining companies' strengths represents another potential. Instead of acquiring single customers and closing individual contracts with them, a platform allows addressing a large customer base simultaneously and at low cost. Furthermore, companies that are active on a platform are able to combine their assets and financial resources. For instance, know-how can be shared in order to achieve a common goal. Another aspect is that companies on a platform can share risks, e.g., production capacity can be split among players so that production peaks may be balanced preventing production downtimes.

Likewise, important are economies of scale and economies of scope discussed by 21 experts. First, companies can purchase commonly, which increases their buying power and volume, and in turn, helps them to negotiate favorable conditions and discounts. Second, sharing helps companies to improve efficiency. For instance, companies can divide financial investments in infrastructure for a platform and later on use it commonly. As platforms allow scaling output easily, fixed cost are divided by large volume leading to lower costs for each player. Furthermore, this allows to achieve ecological benefits, as the overall resource and process efficiency can be enhanced.

Open innovation (named by 19 experts), benchmarking, and developing partnerships (each named by 7 experts) are further important potentials revealed by the study.

**Table 1.** Potentials of Industry 4.0 platforms.

First-Order Concept	Second-Order Theme	Frequency *	Exemplary Statements
Reducing transaction costs	<ul style="list-style-type: none"> <li>▪ Reducing communication efforts</li> <li>▪ Establishing standards, inter-faces, and norms</li> </ul>	53	"With platforms, every communication, every pay-ment, every transaction becomes more efficient." (Interview no. 32)
Combining strengths	<ul style="list-style-type: none"> <li>▪ Addressing a large customer base</li> <li>▪ Combining assets and financial means, sharing risks</li> </ul>	23	"Especially small enterprises are able to virtually combine their abilities on a platform." (Interview no. 2)
Economies of scale and economies of scope	<ul style="list-style-type: none"> <li>▪ Reducing costs when purchas-ing commonly</li> <li>▪ Sharing resources and capacities</li> </ul>	21	"By combining purchasing activities, economies of scale can be generated." (Interview no. 49)
Open innovation	<ul style="list-style-type: none"> <li>▪ Opening and extending innova-tion processes</li> <li>▪ Enabling virtual product devel-opment</li> </ul>	19	"Virtual product devel-opment, located at different geographical places, can be integrated." (Interview no. 96)
Bench-marking	<ul style="list-style-type: none"> <li>▪ Facilitating access to best- practice examples</li> <li>▪ Establishing a community for process optimization</li> </ul>	7	"On a platform, best practice examples, [ . . . ] can be interchanged easily." (Interview no. 6)
Developing partnerships	<ul style="list-style-type: none"> <li>▪ Fostering existing partnerships</li> <li>▪ Building up trust</li> </ul>	7	"Partners on a platform can communicate and interact much more easily." (Interview no. 67)

\* Multiple answers possible.

#### 4.2. Potentials Differentated According to Industry Sectors

The potentials of using platforms in the industrial value creation vary in different industry sectors. Figure 1 depicts the detailed differences while the aspects attracting attention are discussed in the following. The single respondent of the medical engineering industry is not shown. Furthermore, the results of the wood processing industry, although showing quite distinct results, have been excluded from the interpretation of the results due to the low number of cases.

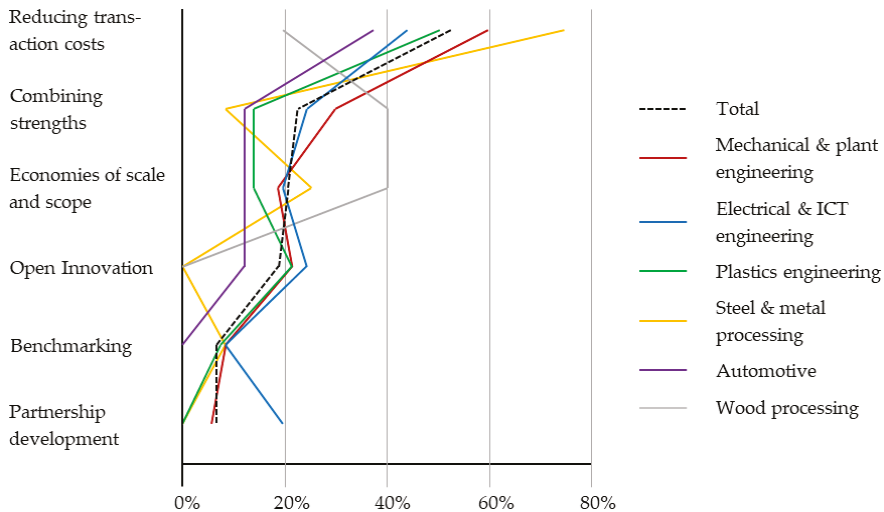

Figure 1. Industry-specific differences as for potentials of Industry 4.0 platforms.

Steel and metal processing as well as mechanical and plant engineering foresee potential especially in the reduction of transaction costs. This can be explained partially by the characteristics of the respective industry sectors. For instance, in the mechanical engineering industry, negotiating contracts usually consumes many resources. This is a result of the complexity of products, as especially plant engineering enterprises sell complex products to their customer. These also require more complex contracts, as products are often tailored specifically to customer demands, having “lot size one” characteristics. Further aspects that could be relevant in this context are, for instance, more complex liability of plants or when having service business models in place that go beyond selling a product.

The results also show that both potentials, combination of strengths and economies of scale and scope, play only a subordinate role in the automotive and in the plastics engineering industries. In particular, SMEs profit from the combination of strengths and economies of scale and scope when doing business on a platform the most. The sample contains major players as for the automotive industry and the plastics engineering industry, whereas SMEs dominate in the other industry sectors that can explain the different perceptions. Furthermore, the automotive industry is known for already achieving high economies of scale and having efficient supply chain management practices in place. Therefore, platforms might not be seen as having such an impact on improving the efficiency in comparison to other industry sectors.

Open innovation does not play a role as for potentials of platforms in the steel and metal processing industry. This might be referred back to that open innovation in these sectors generally is not as important as in other sectors due to the characteristics of the products and services in those industries. In the steel and metal processing industry, rather large quantities and less specific products are produced. Hence, an integration of the customer in the innovation process might not be seen as



important as for industries that provide products and services that are tailored more specifically to customer demands.

Interestingly, the electrical and information and communications technology (ICT) engineering uses and appreciates platforms to further develop their partnerships. In this context, the closeness of electrical and ICT engineering to IT solutions, and thereby to digital platforms, might play a significant role.

Having presented the potentials of digital platforms and their differentiation among industry sectors, the following sections list challenges of digital platforms found and differentiate those for several industry sectors.

#### *4.3. Challenges of Digital Platforms*

Using platforms poses several challenges, which are presented in detail in Table 2. The results indicate the biggest challenge as for digital platforms is lacking trust between the players that hinders a smooth implementation and usage of platforms, named by 53 out of 102 experts. First, in order to ensure smooth transactions and communication between players, a certain level of transparency need to be maintained. This includes sensible data, such as infrastructure, capacities, and cost structure. Some fear that being transparent strengthens competitors instead of bringing individual profits. Second, investing in infrastructure and committing oneself to a platform, increases the costs to cut the strings and terminate the business. In turn, this decreases individual player's bargaining power as they become more dependent on a platform. Subsequently, they must accept what they might not like due to the lack of (financially reasonable) alternatives.

Fifty one out of 102 experts named competitive thinking as a challenge of digital platforms. Working together on a platform requires a collaborative and cooperative thinking. However, individual players tend to focus on their own benefits, strive for their own profit, and behave in a selfish way, which hinders smooth transactions and interactions on platforms. This may culminate in an unwillingness to cooperate impeding the idea of doing business on a platform. Furthermore, there is a lack of understanding that collective benefits in the long run are larger when players work together. Individual player might need to take the risk of suboptimal decisions from an individual perspective and lower individual short-term profits. Yet, it is a challenge to ensure an understanding for this given the individual interests and incentives of players, managers, and employees.

The results indicate the high coordination efforts represent a further challenge that was mentioned by 46 out of 102 experts. From a technical point of view, it is difficult to create interfaces between the platform and the players that enable smooth data exchange. Here it comes into question which players will prevail in setting the standards and which players need to invest to meet the interfaces' requirements. From a juridical point of view, it is difficult to enter into a contract as such contracts are rather difficult to design. When these initial challenges are overcome, there remain efforts such as to generate a common vision and strategy for the platform, requiring high short-term investments with unclear and undetermined amortization.

A likewise important challenge is the loss of confidential information that was mentioned by 45 out of 102 experts. Many companies do not trust in digital information sharing in general and prefer offline communication. Additionally, many fear that confidential information may be passed on to third parties resulting from industry espionage and hacker attacks.

Further challenges include difficulties in finding adequate partners (named by 39 experts), the fact that some players prefer being independent (discussed by 36 experts), and unsolved questions about data ownership (mentioned by 24 out of 102 experts).



Table 2. Challenges of Industry 4.0 platforms.

First-Order Concept	Second-Order Theme	Frequency *	Exemplary Statements
Lacking trust	<ul style="list-style-type: none"> <li>▪ Fearing transparency</li> <li>▪ Losing bargaining power</li> </ul>	53	"All members are opponents in some way or another. This mindset needs to change." (Interview no. 27)
	<ul style="list-style-type: none"> <li>▪ Focusing on own benefits, selfish behavior, unwillingness to cooperate</li> <li>▪ Individual, short-term orientation contrasts collective long-term profits</li> </ul>	51	"Everyone just thinks about his own profit and how to outreach competitors. But that doesn't work on platforms." (Interview no. 4)
High coordination efforts	<ul style="list-style-type: none"> <li>▪ Accomplishing interfaces with other firms is difficult</li> <li>▪ Designing contracts for platforms is difficult</li> <li>▪ Investments to generate a common vision and strategy</li> </ul>	46	"Who do you find that integrates interfaces, aligns data exchange [...] ? Everyone just runs his own processes and throws them on the platform." (Interview no. 80)
Losing confidential information	<ul style="list-style-type: none"> <li>▪ Lacking trust in digital information sharing</li> <li>▪ Losing confidential information (hackers or industry espionage)</li> </ul>	45	"I wouldn't trust to share with everyone on such a platform. And many others neither do so." (Interview no. 23)
Finding adequate partners	<ul style="list-style-type: none"> <li>▪ Imbalance between industrial enterprises and IT enterprises</li> <li>▪ Some players do not share same vision or trust each other</li> </ul>	39	"There are mostly manufacturers on such a platform, but too few IT experts." (Interview no. 91)
Preferring in-dependence	<ul style="list-style-type: none"> <li>▪ Some players prefer doing business on their own</li> <li>▪ Sustainable loyalty to the platform comes into question</li> </ul>	36	"I believe that especially smaller enterprises want to stay on their own." (Interview no. 74)
Data ownership	<ul style="list-style-type: none"> <li>▪ Unsolved questions about data ownership and right to use data</li> <li>▪ Contracts do not satisfactory cover all issues of data security</li> </ul>	24	"I don't know who is allowed to use the data; does the platform generate revenues with my data, like Facebook?" (Interview no. 9)

\* Multiple answers possible.

#### *4.4. Challenges Differentiated According to Industry Sectors*

As for the potentials, the challenges in the context of using digital platforms differ in the industry sectors, depicted by Figure 2. Comparably to Figure 1, the single respondent of the medical engineering industry is not shown. Furthermore, the results of the wood processing industry, although showing quite distinct results, have been excluded from the interpretation of the results due to the low number of cases.

The automotive industry, mechanical and plant engineering industry perceive a lacking trust as being a bigger challenge than the sample average. This can be explained because of the sensible information resulting from the complexity of the value creation, which applies for the automotive industry as well as for the mechanical and plant engineering industry. In the automotive industry, several numbers and figures, such as the overall equipment effectiveness, cycle times, or cost breakdowns are regarded as trade secrets. Those shall not be shared as companies fear that these figures will be used against them, for instance, to put pressure on them in price negotiations.

In the mechanical and plant engineering industry, as explained for the potentials of digital platforms, products have a high complexity and are tailored to customer demands. Sharing information on digital platforms might hereby be seen as losing a trade secret to competitors.

In contrast, electrical and ICT engineering rate potential lack of trust below the total sample. The electrical and ICT engineering sector might already have gained experiences with digital data exchange that has created a greater confidence in technology. This can be reasoned with their higher closeness and affinity to IT solutions, as explained for the potentials of digital platforms.

Similar relationships can be observed for competitive thinking, that can be reasoned with comparable explanations as for the previous challenges mentioned. While mechanical and plant engineering enterprises fear competitive thinking on a platform, electrical and ICT engineering rate it as a significantly less important challenge.

High coordination costs and issues of data ownership are particularly important in the steel and metal industry. These sectors might have low experience with platforms so far which possibly helps to explain these findings. Furthermore, those industry sectors typically provide products and services with lower complexity and larger lot sizes, as explained before. In contrast, coordination costs only play a minor role in the electrical and ICT engineering and in the plastics engineering industry.

The plastics engineering and the automotive industry in particular fear losing confidential information when using platforms and see this as a significant challenge. This is especially the case for the automotive industry, this might relate to figures that are seen as trade secrets and shall not be shared, as explained for lacking trust at the beginning of this section. Steel and metal processing industry as well as electrical and ICT engineering industry perceive this as a challenge that is not seen as important. For the steel and metal processing industry, this might relate to the products and services provided, whereas for the electrical and ICT engineering industry, those companies might have a higher affinity and closeness to platform solutions, as explained before.

Finding adequate partners for a digital platform seems to be no challenge for the electrical and ICT engineering industry. These industry sectors might either already have gained some experience with finding partners for platforms, especially the electrical and ICT engineering companies within the sample. As a further reason, they face a competitive environment that forces companies to search for further partnerships anyway.

Companies in the industrial sectors steel and metal processing as well as wood industry prefer being independent. In contrast to that, the electrical and ICT engineering and the plastic engineering industries face fewer issues as per this challenge.

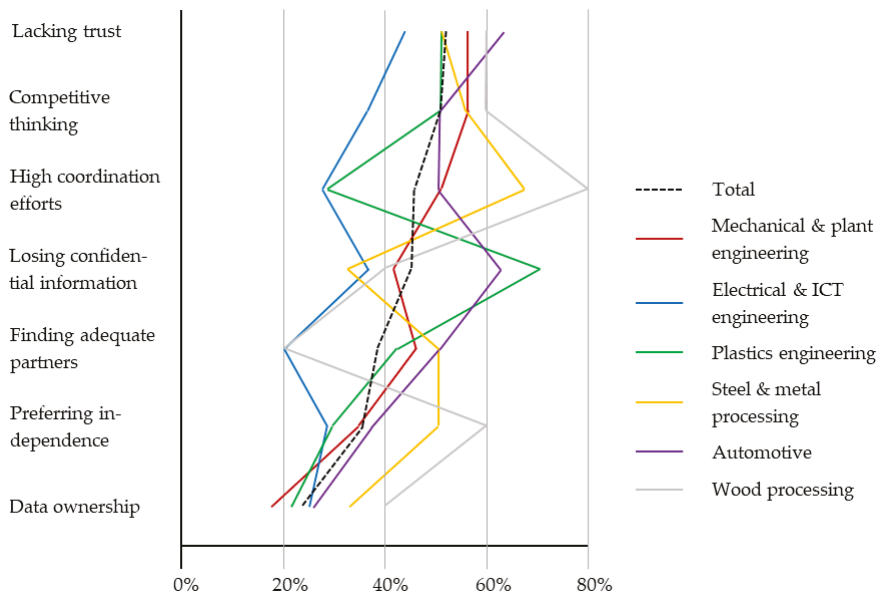

Figure 2. Industry-specific differences regarding challenges of Industry 4.0 platforms.

## 5. Discussion and Theoretical Contribution

The paper provides a comprehensive overview of benefits and challenges of digital platforms at the current stage of development in industrial application. In that regard, this paper adds manifold to the sparse literature that has investigated digital platforms in the context of industrial companies from a management perspective [8,9].

Furthermore, combining results from both industry-spanning and industry-specific perspectives, the paper synthesises potentials and challenges of digital platforms in the industrial context. In that sense, the paper is able to contribute to calls for research in understanding the benefits and challenges of digital platforms in an industrial context [3,10]. Additionally, the paper is able to generate a holistic overview of potentials and challenges of digital platforms, whereas the majority of extant literature relies on single cases that cannot be generalized for a broader context [5,11,12].

Using this approach, the paper contributes to the understanding of digital platforms in an industrial context, adding to extant studies that have mostly regarded platforms in non-industrial contexts [10,12–14]. In particular, the paper finds that platform-based business models, approaches to open innovation, and new forms of value creation are not yet understood entirely by industrial manufacturers [10,12].

In this regard, the paper shows that the majority of answers rather relates to operational benefits that are generated through the use of digital platforms. New ecosystems, unseen business models, or entirely new forms of value creation were not mentioned by the majority of interviewees. Such benefits as new ecosystems of new business models have been mentioned in literature regarding digital platforms for B2C contexts several times [4,5,10–12,35].

However, when regarding the current state of research regarding reasons for Industry 4.0 implementation, this orientation towards operational benefits might become clearer. As the sample consists of many SMEs, but only a few large enterprises, the findings extend and complement the main results of studies in the field of Industry 4.0. Here, it was found that operational benefits of Industry 4.0 are mainly pursued by SMEs, whereas new business models or strategically-oriented targets are only pursued by a minority [7,28]. This finding is complemented by the insights of extant literature,

that describe a rather reluctant behavior of SMEs towards taking risks that might lead them to leave their, so far, successful niche [7,62].

Compared to the behavior of SMEs, rather process-oriented industries regarding Industry 4.0 are also rather operationally oriented towards digital platforms, such as steel and metal processing, or the automotive companies within this sample, which also show a pursuit of operationally-oriented potentials in this study. Those industries tend to be path-dependent on their existing success factors and logics of value creation rather than turning to new opportunities that arise from digital platforms [7,26,28].

Additionally, the findings of this study regarding a rather operationally oriented pursuit of digital platforms could relate to the current stage of development of digital platforms in an industrial context, which several interviewees stress to be at an initial phase. The majority of application examples raised by interviewees rather relate to more efficient data exchange and thereupon achieved data transparency, for instance along supply chains or in research and development (R&D), than to the aforementioned potential of “multi-sided platforms” [6,31]. As a result, the findings, to a larger extend, relate to eased collaboration and communication mentioned in current literature [21,32]. Only a smaller group interviewees relate to aspects of customer integration or open innovation approaches that can be found in extant literature [33,34].

However, the paper is able to show why digital platforms in the industrial context might still be at this stage of development, in contrast to, for instance, in the B2C market [8,36]. This is due to challenges, that have not been presented in literature so far in a comprehensive way, especially not for digital platforms in an industrial context [10–12].

As a first aspect to be named among challenges of digital platforms, this confirms that finding adequate partners represents a challenge for establishing Industry 4.0-platforms. Comparable evidence has been found for Industry 4.0 implementation in extant literature. Further, this aspect has especially been found for SMEs, claiming a challenge to find adequate partners for them for Industry 4.0 [7,9,37,38,63].

As a second aspect of challenges regarding digital platforms, considerations of data ownership and data usage rights, lacking trust, as well as and losing confidential information hamper the unfolding of digital platforms [11]. The unclear legal situation of legal and property rights can also be found for Industry 4.0, where several studies mention that those remain unclear if data is stored and transferred using digital platforms, especially via several countries [3,28,63,64].

In that sense, the findings have to be divided into three categories relating to data security and data property rights, as explained below.

First, technical security, i.e., security that protects against data theft and hackers has to be regarded. Comparable aspects are described to hamper Industry 4.0 implementation in extant literature [3,63]. SMEs in particular are not prepared to develop secure data transmission and storage solutions and their own. The acquisition of external partners for this purpose, however, cannot be afforded by SMEs in many cases [7]. In this way, the present paper is able to show the close interrelations that hinder the implementation of both Industry 4.0 and digital platforms.

Second, security against data transparency, i.e., loss of confidential information to third parties, especially competitors, has to be regarded. Again, the paper complements the findings regarding SMEs in the context of Industry 4.0, as SMEs especially fear that data might be passed on to competitors and that they do not have the necessary power to negotiate terms for data usage for third parties [63,64].

Third, the right to collect and use data have to be clarified from a legal and from a contractual perspective. Comparable insights can be found in the literature regarding Industry 4.0 [3,63]. In this regard, it remains unclear for many companies which data they are allowed to collect and store, and more importantly, to use. For instance, if a benefit is gained by data that was generated by a partner on a digital platform, it remains unclear if this benefit needs to be shared with this partner, or if this partner even has to be informed [63]. This requires among authorities and public institutions that need to ensure a dependable legal framework, as described below, a change in the mindset, as sharing data

might not always lead to one's own benefit on a platform. This also relates to the found challenge of competitive thinking, that needs to be changed towards an understanding among partners [64].

In response to the aforementioned challenges arising from data security and data property, technical solutions and clear contracts between partners are one possible solution, which can, however, not be the single solution. Several papers in the context of Industry 4.0, authorities and public institutions have to adapt and extend the existing legal framework and ensure legal conditions that are dependable, especially in an international context [3,63]. For digital platforms, the paper shows that it is also necessary to adapt framing conditions accordingly.

As a third main group of challenges to be named, the paper is able to show competitive thinking and preferred independence play a central role in the context of perceived challenges of digital platforms. Such challenges have been raised in current literature, but the frequency in which they are named by the interviewees stresses their importance for successfully establishing digital platforms [3,7,11]. Especially the aspect of preferred independence is often described in literature among SMEs, which are often run by the owner [7].

Additionally, the paper complements research regarding Industry 4.0 that draws an interconnection between sustainability aspects and efforts of digitization [3,26,28]. This paper is able to contribute to this research stream, combining the findings of research on Industry 4.0 and adding sustainability aspects of digital platforms, which has not been accomplished so far in extant literature.

In particular, the paper helps to shed light on potentials and challenges of digital platforms in the context of Industry 4.0. For economic benefits, reducing transaction costs as well as generating compound effects play an important role. These findings complement the research about Industry 4.0 in general, that finds that SMEs tend to neglect strategically oriented potentials [3,28,64]. In this regard, the paper is able to show that this is valid for SMEs for both, digital platforms and Industry 4.0.

Furthermore, a generation of compound effects can also lead to ecological potentials in an indirect way. This relates to, for instance, aspects of common purchasing with optimized transport routes and less traffic generated [3,36].

Whereas the benefits of reducing transaction costs and economies of scale and economies of scope can be directly associated to economic benefits, indirect ecological benefits as a result could also be achieved in a comparable way to the generation of compound effects. For instance, more efficient production and logistics processes might also lead to more sustainable production and logistics processes from an ecological point of view. For instance, reduced energy consumption, eased accessibility of recycling guidelines, and specifications are among aspects to be named in this context.

Social aspects can be enhanced by, for instance, reducing coordination efforts of humans and reducing monotonous work for relabeling and adaption of standards, as this information can be shared easily on digital platforms. Those aspects represent compound effect of economic benefits and ecological benefits, as well as economic and social benefits, that can be confirmed in the context of digital platforms [3,63,65,66].

The benefits of combination if strengths and benchmarking can be associated to all three dimensions of the Triple Bottom Line, economic, ecological and social benefits. For instance, bringing knowledge about resource-efficient processes together easily on a digital platform, sharing information about recycling specifications, or easing the workflow of humans are possible aspects in this regard [26,63].

Additionally, open innovation and developing partnerships could can be associated to benefits in all three dimensions in the Triple Bottom Line of sustainability, economic, ecological and social. The interconnection of social enhancements with ecological and economic benefits in particular confirms findings that have been found for Industry 4.0 respectively. For instance, better partnerships and better ways of collaboration and innovation pave the way for better economic success and achieving ecological aspects together, which becomes enhances via the use of a digital platform [26,63].

On the other hand, lacking trust, competitive thinking, high coordination efforts, and losing confidential information relate to economic and social concerns simultaneously. Both categories

appear simultaneously in this context, highlighting their close interrelation, which hamper the unfolding of the benefits described above. Further social and economic aspects in combination, such as finding adequate partners and preferred independence, as well as concerns from a technical and legal perspective, namely data ownership, should be considered as described above. In this regard, the paper complements findings regarding Industry 4.0, that economic and social challenges have to be mastered before being able to access the benefits possible in all three dimensions of the Triple Bottom Line of Sustainability [3,63].

In sum, it has to be noted that short-term economic efforts and addressing social concerns in particular might be necessary in order to generate benefits within all three dimensions of the Triple Bottom Line of Sustainability, as found for Industry 4.0 [3,26,63]. The paper hereby illustrates the close interrelations and dependencies between the three dimensions, also in a temporal and logical interrelation. Furthermore, the close interrelatedness and dependence of Industry 4.0 as a concept for horizontal and vertical interconnection and digital platforms, bringing together multiple stakeholders for mutual benefits, becomes apparent [1,3].

## **6. Conclusions**

### *6.1. Managerial Implications*

On the one hand, this paper shows that operational potential relating to a combination of strengths, economies of scale and scope, and the reduction of transaction costs can be achieved by using digital platforms. As a result, established manufacturers are advised and recommended to pursue those potentials by using digital platforms. Further, platforms providers are well advised to foster and promote those potentials, as platform users might see those potentials as most relevant at the current stage.

The paper further finds that the characteristics and complexity of the products and services provided play an essential role as to whether and how potentials and challenges of digital platforms are perceived. For instance, processing industries, different have a different approach than those of potential providers of Industry 4.0-based products and services [7,28]. In the sample, this applies in particular to the mechanical and plant engineering industry.

Furthermore, the potential affinity, experience and closeness to IT solutions might influence the perception of digital platforms. Especially the electrical and ICT engineering industries hereby partially show a different behavior than other industry sectors.

Additionally, specific characteristics of certain industries, for instance, feared transparency when sharing information digitally in the automotive industry, play a role in the perception of potential and challenges of digital platforms. Hereby, an understanding that competitive thinking must be addressed in order to operate digital platforms successfully must be created. Giving benefits and rewards for sharing information digitally, and even on a digital platform, to smaller and less powerful supply chain partners might represent a strategy from the perspective of automotive OEMs (original equipment manufacturers).

On the other hand, the paper finds that potentials of digital platforms that relate to entirely new ways of value creation, and the creation of new ecosystems, are hardly addressed within the sample. As these potentials have been found decisive and powerful in B2C contexts, those should be considered in the future in order to grasp the potentials that digital platforms offer.

In sum, the challenges identified in the study require appropriate strategies in order to be able to profit from the potential. The following five principles are derived from the results and the experts' experiences, derived as a comprehensive overview integrated into corresponding strategies in corporate practice:

First, it is essential to ensure secure and trustworthy technical solutions for data exchange and storage to address the lack of trust between partners and the risk of losing information. At the same

time, it must properly be defined who owns which data on a digital platform and to what extent it may be used.

Second, a fair distribution of costs and risks as well as returns must be guaranteed to counter prevailing competitive thinking. Likewise, partnerships on platforms must be designed in a way that participating companies are not endangered.

Third, it is particularly important to promote the future reduction of transaction costs and the leverage of synergies to compensate for the initial high coordination efforts. The same applies to the optimization of processes wherefore interfaces and processes must be harmonized.

Fourth, the advantage of improving partnerships using platforms must be promoted, in particular as smaller companies can jointly establish a stronger position on the market. Appropriate and successful benchmark examples of digital platforms help to attract further suitable partners.

Fifth, the potential of digital platforms go beyond efficiency increases and, for instance, includes paving the way for new data-driven business models. This should be better emphasized and promoted in corporate practice.

## *6.2. Limitations and Further Research*

The study faces some limitations due to its methodological nature. First, the qualitative approach allows analyzing the complex topic of digital platforms, but this approach in turn impedes general theoretical contributions. However, the study at hand consolidates and aggregates detailed information, while keeping the necessary informational content relevant. In doing so, the paper is able to derive general theoretical and managerial implications. Second, the paper presents various biases along with the measures taken to reduce their impact on the results. The approaches presented ensure methodological rigor and quality of the study. Third, this study exclusively focuses on German and Austrian companies for the aforementioned reasons. This choice may appropriately serve the study's purpose but should be kept in mind when generalizing the implications and transferring them to different cultural contexts.

Given the novelty of the research area, there are further limitations. For this reason, it is noteworthy that many of the companies examined have only been dealing with the topic of digital platforms for a short period of time. The majority of interviewees only has experience with platforms from a user's perspective, while only very few have already started their own platform. Accordingly, the study's results cover the current state that is generated before a broad use of digital platforms in industrial corporate practice. Therefore, the paper mostly relates to operational benefits of digital platforms whereas new business models, new ways of value generation or entirely new ecosystems cannot be uncovered and understood from the current sample.

Furthermore, while a majority of the interviewees only begin to fully grasp the topic of digital platforms in the context of Industry 4.0, some interviewees within the sample already have advanced experience, a few already having launched their own platform. In response, a recommendation for future research is to elaborate on the different stages of experience with digital platforms in the context of Industry 4.0. A possible outcome here could be a stage-gate model that shows the specific challenges and potentials within the stages of implementation.

An additional recommendation for future research is to investigate platform providers, although found in very few cases in industrial contexts so far, in future research. Nevertheless, this study gives valuable insights into the corporate cultural changes that are necessary. Furthermore, this provides insights regarding the challenges that must be tackled, and the environmental conditions that must be provided.

A further limitation can be found in the diverse understandings and definitions of the term Industry 4.0. Although found in journalistic publications and trade magazines, the term "digital platforms" related to cannot be regarded as entirely defined from an academic perspective. This lack of a comprehensive framework should be addressed in future research, aiming for an understanding that encompasses the understanding of several research disciplines.

Future research can help us to shed light into how to apply digital platforms in corporate practice. For instance, academia could consider investigating the experienced IT sector to be able to derive recommendations for the industrial context. Furthermore, the extent to which efficiency gains can be expected using platforms in industrial value creation is of interest. Here, academia can help to quantify efficiency gains by conducting research on existing platforms.

**Funding:** This research received no external funding.

**Acknowledgments:** The author thanks the anonymous reviewers for their helpful comments for revising the paper.

**Conflicts of Interest:** The author declares no conflict of interest.

## Appendix A

**Table A1.** Detailed list of expert interviews.

Case No.	Company Years	Industry	Employees	Sales [in Million Euro]
1	>10	Wood processing	[0–200]	[10–50]
2	[3–5]	Medical engineering	[0–200]	[10–50]
3	>10	Steel and metal processing	[200–500]	[50–200]
4	>10	Plastics engineering	[200–500]	[50–200]
5	>10	Plastics engineering	[500–1000]	[50–200]
6	[3–5]	Electrical and ICT engineering	[0–200]	[0–10]
7	>10	Wood processing	[200–500]	[50–200]
8	[1–3]	Mechanical and plant engineering	[0–200]	[10–50]
9	[1–3]	Mechanical and plant engineering	[0–200]	[0–10]
10	[5–10]	Automotive	[0–200]	[10–50]
11	[1–3]	Mechanical and plant engineering	[0–200]	[0–10]
12	>10	Steel and metal processing	[0–200]	[10–50]
13	[1–3]	Mechanical and plant engineering	[0–200]	[10–50]
14	>10	Automotive	[200–500]	[10–50]
15	[5–10]	Mechanical and plant engineering	[0–200]	[10–50]
16	>10	Plastics engineering	[500–1000]	[50–200]
17	[5–10]	Mechanical and plant engineering	[200–500]	[10–50]
18	>10	Electrical and ICT engineering	[200–500]	[10–50]
19	[5–10]	Automotive	[0–200]	[10–50]
20	>10	Plastics engineering	[0–200]	[0–10]
21	>10	Mechanical and plant engineering	[1000–5000]	[200–500]
22	>10	Steel and metal processing	[0–200]	[0–10]
23	[3–5]	Mechanical and plant engineering	[0–200]	[0–10]
24	[5–10]	Steel and metal processing	[0–200]	[0–10]
25	>10	Plastics engineering	[1000–5000]	[50–200]
26	[1–3]	Steel and metal processing	[500–1000]	[50–200]
27	[1–3]	Mechanical and plant engineering	[200–500]	[10–50]



Table A1. Cont.

Case No.	Company Years	Industry	Employees	Sales [in Million Euro]
28	>10	Mechanical and plant engineering	[0–200]	[0–10]
29	[5–10]	Steel and metal processing	[0–200]	[0–10]
30	>10	Plastics engineering	[0–200]	[10–50]
31	[1–3]	Electrical and ICT engineering	[0–200]	[10–50]
32	[3–5]	Electrical and ICT engineering	[200–500]	[10–50]
33	[1–3]	Electrical and ICT engineering	[500–1000]	[50–200]
34	>10	Mechanical and plant engineering	[1000–5000]	[50–200]
35	[1–3]	Automotive	[0–200]	[10–50]
36	[5–10]	Automotive	[500–1000]	[50–200]
37	>10	Mechanical and plant engineering	[200–500]	[10–50]
38	[5–10]	Plastics engineering	[1000–5000]	[200–500]
39	[5–10]	Mechanical and plant engineering	[0–200]	[10–50]
40	[5–10]	Electrical and ICT engineering	[200–500]	[10–50]
41	[1–3]	Mechanical and plant engineering	[0–200]	[0–10]
42	>10	Automotive	[1000–5000]	[200–500]
43	[3–5]	Mechanical and plant engineering	[0–200]	[0–10]
44	>10	Electrical and ICT engineering	[0–200]	[0–10]
45	>10	Mechanical and plant engineering	[0–200]	[0–10]
46	[5–10]	Mechanical and plant engineering	[0–200]	[0–10]
47	>10	Steel and metal processing	[0–200]	[0–10]
48	[5–10]	Mechanical and plant engineering	[1000–5000]	[200–500]
49	>10	Electrical and ICT engineering	[200–500]	[50–200]
50	>10	Mechanical and plant engineering	[500–1000]	[50–200]
51	[1–3]	Mechanical and plant engineering	[200–500]	[10–50]
52	>10	Mechanical and plant engineering	[500–1000]	[50–200]
53	[3–5]	Steel and metal processing	[0–200]	[0–10]
54	[1–3]	Steel and metal processing	[200–500]	[50–200]
55	>10	Mechanical and plant engineering	[500–1000]	[50–200]
56	[1–3]	Electrical and ICT engineering	[0–200]	[50–200]
57	>10	Automotive	[1000–5000]	[200–500]
58	[1–3]	Automotive	[1000–5000]	[10–50]
59	[1–3]	Plastics engineering	[0–200]	[10–50]
60	[5–10]	Plastics engineering	[0–200]	[200–500]
61	>10	Electrical and ICT engineering	[500–1000]	[0–10]
62	[1–3]	Mechanical and plant engineering	[500–1000]	[10–50]
63	[5–10]	Mechanical and plant engineering	[200–500]	[10–50]
64	>10	Electrical and ICT engineering	[0–200]	[10–50]
65	>10	Mechanical and plant engineering	[5000–10000]	>500
66	>10	Wood processing	[1000–5000]	[200–500]
67	>10	Electrical and ICT engineering	[500–1000]	[50–200]
68	[5–10]	Electrical and ICT engineering	[1000–5000]	>500
69	[1–3]	Electrical and ICT engineering	[0–200]	[0–10]
70	>10	Electrical and ICT engineering	[0–200]	[0–10]

Table A1. Cont.

Case No.	Company Years	Industry	Employees	Sales [in Million Euro]
71	[1–3]	Electrical and ICT engineering	[1000–5000]	>500
72	[3–5]	Electrical and ICT engineering	[0–200]	[0–10]
73	>10	Electrical and ICT engineering	[1000–5000]	[200–500]
74	[3–5]	Electrical and ICT engineering	[0–200]	[50–200]
75	>10	Electrical and ICT engineering	[0–200]	[0–10]
76	>10	Electrical and ICT engineering	[0–200]	>500
77	>10	Wood processing	[0–200]	[200–500]
78	[1–3]	Electrical and ICT engineering	[200–500]	[10–50]
79	[5–10]	Plastics engineering	[0–200]	[0–10]
80	>10	Electrical and ICT engineering	[1000–5000]	>500
81	[5–10]	Electrical and ICT engineering	[200–500]	[50–200]
82	>10	Mechanical and plant engineering	[0–200]	[10–50]
83	>10	Mechanical and plant engineering	[1000–5000]	[200–500]
84	[5–10]	Electrical and ICT engineering	[0–200]	[10–50]
85	>10	Mechanical and plant engineering	[0–200]	[0–10]
86	[1–3]	Plastics engineering	[0–200]	[10–50]
87	>10	Steel and metal processing	[0–200]	[0–10]
88	>10	Mechanical and plant engineering	[0–200]	[10–50]
89	[5–10]	Plastics engineering	[1000–5000]	[50–200]
90	>10	Steel and metal processing	[200–500]	[10–50]
91	>10	Mechanical and plant engineering	[0–200]	[10–50]
92	>10	Mechanical and plant engineering	[0–200]	[0–10]
93	[5–10]	Plastics engineering	[200–500]	[10–50]
94	[1–3]	Mechanical and plant engineering	[500–1000]	[200–500]
95	[0–1]	Wood processing	[200–500]	[50–200]
96	[0–1]	Mechanical and plant engineering	[0–200]	[0–10]
97	[1–3]	Plastics engineering	[500–1000]	[200–500]
98	>10	Mechanical and plant engineering	[200–500]	[50–200]
99	>10	Steel and metal processing	[0–200]	[0–10]
100	>10	Mechanical and plant engineering	[0–200]	[0–10]
101	>10	Mechanical and plant engineering	[500–1000K]	[50–200]
102	[1–3]	Mechanical and plant engineering	[0–200]	[0–10]

## References

1. Kagermann, H.; Wahlster, W.; Helbig, J. *Recommendations for Implementing the Strategic Initiative Industrie 4.0—Final Report of the Industrie 4.0 Working Group*; Communication Promoters Group of the Industry-Science Research Alliance, acatech: Frankfurt am Main, Germany, 2013. Available online: <https://www.acatech.de/Publikation/recommendations-for-implementing-the-strategic-initiative-industrie-4-0-final-report-of-the-industrie-4-0-working-group/> (accessed on 20 February 2019).
2. Lasi, H.; Fettke, P.; Kemper, H.; Feld, T.; Hoffmann, M. Industry 4.0. *Bus. Inf. Syst. Eng.* **2014**, *6*, 239–242. [CrossRef]
3. Kiel, D.; Müller, J.M.; Arnold, C.; Voigt, K.I. Sustainable Industrial Value Creation: Benefits and Challenges of Industry 4.0. *Int. J. Innov. Manag.* **2017**, *21*, 1740015. [CrossRef]
4. Kenney, M.; Zysman, J. The Rise of the Platform Economy. *Issues Sci. Technol.* **2016**, *32*, 61–69.
5. Gawer, A.; Cusumano, M.A. Industry Platforms and Ecosystem Innovation. *J. Prod. Innovat. Manag.* **2014**, *31*, 417–433. [CrossRef]

6. Hagiu, A.; Wright, J. Multi-Sided Platforms. *Int. J. Ind. Organ.* **2015**, *43*, 162–174. [[CrossRef](#)]
7. Müller, J.M.; Buliga, O.; Voigt, K.I. Fortune Favors the Prepared: How SMEs Approach Business Model Innovations in Industry 4.0. *Technol. Forecast. Soc.* **2018**, *132*, 2–17. [[CrossRef](#)]
8. Parker, G.; Van Alstyne, M.; Choudary, S.P. *Platform Revolution: How Networked Markets are Transforming the Economy and How to Make Them Work for You*; Norton and Company: New York, NY, USA, 2016; ISBN 978-0393249132.
9. Wiegand, N.; Witt, S.; Steiner, M.; Backhaus, K. Platform Adoption in Network Markets: Selecting Beneficial Partners to Achieve Market Dominance. *Int. J. Innov. Manag.* **2015**, *19*, 1550028. [[CrossRef](#)]
10. Müller, J.M.; Pommeranz, B.; Weisser, J.; Voigt, K.I. Digital, Social Media, and Mobile Marketing in industrial buying: Still in need of customer segmentation? Empirical evidence from Poland and Germany. *Ind. Mark. Manag.* **2018**, *73*, 70–83. [[CrossRef](#)]
11. Boudreau, K. Open Platform Strategies and Innovation: Granting Access vs. Devolving Control. *Manag. Sci.* **2010**, *56*, 1849–1872. [[CrossRef](#)]
12. De Reuver, M.; Sørensen, C.; Basole, R.C. The Digital Platform: A Research Agenda. *J. Inf. Technol.* **2017**, *1*–12. [[CrossRef](#)]
13. Gawer, A. Bridging differing perspectives on technological platforms: Toward an integrative framework. *Res. Policy* **2014**, *43*, 1239–1249. [[CrossRef](#)]
14. McIntyre, D.P.; Srinivasan, A. Networks, Platforms, and Strategy: Emerging Views And Next Steps. *Strateg. Manag. J.* **2017**, *38*, 141–160. [[CrossRef](#)]
15. Schuh, G.; Potente, T.; Wesch-Potente, C.; Weber, A.R.; Prote, J.P. Collaboration Mechanisms to Increase Productivity in the Context of Industrie 4.0. *Procedia CIRP* **2014**, *19*, 51–56. [[CrossRef](#)]
16. Veza, M.; Mladineo, M.; Gjeldum, N. Managing Innovative Production Network of Smart Factories. *IFAC-Papers OnLine* **2015**, *48*, 555–560. [[CrossRef](#)]
17. Lee, J.; Bagheri, B.; Kao, H.A. A Cyber-Physical Systems Architecture for Industry 4.0-Based Manufacturing Systems. *Manuf. Lett.* **2015**, *3*, 18–23. [[CrossRef](#)]
18. Schlechtendahl, J.; Keinert, M.; Kretschmer, F.; Lechler, A.; Verl, A. Making Existing Production Systems Industry 4.0-Ready. *Prod. Eng.* **2015**, *9*, 143–148. [[CrossRef](#)]
19. Lee, J.; Lapira, E.; Bagheri, B.; Kao, H.A. Recent Advances and Trends in Predictive Manufacturing Systems in Big Data Environment. *Manuf. Lett.* **2013**, *1*, 38–41. [[CrossRef](#)]
20. Davis, J.; Edgar, T.; Porter, J.; Bernaden, J.; Sarli, M. Smart Manufacturing, Manufacturing Intelligence and Demand-Dynamic Performance. *Comput. Chem. Eng.* **2012**, *47*, 145–156. [[CrossRef](#)]
21. Radziwon, A.; Bilberg, A.; Bogers, M.; Madsen, E.S. The Smart Factory: Exploring Adaptive and Flexible Manufacturing Solutions. *Procedia Eng.* **2014**, *69*, 1184–1190. [[CrossRef](#)]
22. Wang, F.; Zhao, J.; Chi, M.; Li, Y. Collaborative Innovation Capability in IT-Enabled Inter-Firm Collaboration. *Ind. Manag. Data Syst.* **2017**, *117*, 2364–2380. [[CrossRef](#)]
23. Piccarozzi, M.; Aquilani, B.; Gatti, C. Industry 4.0 in Management Studies: A Systematic Literature Review. *Sustainability* **2018**, *10*, 3821. [[CrossRef](#)]
24. Liao, Y.; Deschamps, F.; De Freitas Rocha Loures, F.; Pierin Ramos, L.F. Past, Present and Future of Industry 4.0—A Systematic Literature Review and Research Agenda Proposal. *Int. J. Prod. Res.* **2017**, *55*, 3609–3629. [[CrossRef](#)]
25. Müller, J.; Dotzauer, V.; Voigt, K.-I. Industry 4.0 and its Impact on Reshoring Decisions of German Manufacturing Enterprises. In *Supply Management Research: Aktuelle Forschungsergebnisse 2017*; Bode, C., Bogaschewsky, R., Eßig, M., Lasch, R., Stölzle, W., Eds.; Springer Gabler: Wiesbaden, Germany, 2017; pp. 165–179. [[CrossRef](#)]
26. Müller, J.M.; Voigt, K.-I. Sustainable Industrial Value Creation in SMEs: A Comparison between Industry 4.0 and Made in China 2025. *Int. J. Precis. Eng. Manuf.-Green Technol.* **2018**, *5*, 659–670. [[CrossRef](#)]
27. Kang, H.S.; Lee, J.Y.; Choi, S.; Kim, H.; Park, J.H.; Son, J.Y. Smart Manufacturing: Past Research, Present Findings, and Future Directions. *Int. J. Precis. Eng. Manuf.-Green Technol.* **2016**, *3*, 111–128. [[CrossRef](#)]
28. Müller, J.M.; Kiel, D.; Voigt, K.I. What Drives the Implementation of Industry 4.0? The Role of Opportunities and Challenges in the Context of Sustainability. *Sustainability* **2018**, *10*, 247. [[CrossRef](#)]
29. Brettel, M.; Friederichsen, N.; Keller, M.; Rosenberg, M. How Virtualization, Decentralization and Network Building Change the Manufacturing Landscape: An Industry 4.0 Perspective. *Int. J. Mec. Aero Ind. Mech. Eng.* **2014**, *8*, 37–44.

30. Laudien, S.M.; Daxböck, B. The Influence of the Industrial Internet of Things on Business Model Design: A Qualitative-Empirical Analysis. *Int. J. Innov. Manag.* **2016**, *20*, 1640014. [[CrossRef](#)]
31. Arnold, C.; Kiel, D.; Voigt, K.I. How the Industrial Internet of Things Changes Business Models in Different Manufacturing Industries. *Int. J. Innov. Manag.* **2016**, *20*, 1640015. [[CrossRef](#)]
32. Schallmo, D.; Williams, C.A.; Boardman, L. Digital Transformation Of Business Models—Best Practice, Enablers, And Roadmap. *Int. J. Innov. Manag.* **2017**, *21*, 1740014. [[CrossRef](#)]
33. Eisenmann, T.; Parker, G.; Van Alstyne, M.W. Strategies for Two-Sided Markets. *Harv. Bus. Rev.* **2006**, *84*, 92.
34. Sedera, D.; Lokuge, S.; Grover, V.; Sarker, S.; Sarker, S. Innovating with Enterprise Systems and Digital Platforms: A Contingent Resource-Based Theory View. *Inform. Manag.* **2016**, *53*, 366–379. [[CrossRef](#)]
35. Xie, K.; Wu, Y.; Xiao, J.; Hu, Q. Value Co-Creation between Firms and Customers: The Role of Big Data-Based Cooperative Assets. *Inform. Manag.* **2016**, *53*, 1034–1048. [[CrossRef](#)]
36. Esposito De Falco, S.; Renzi, A.; Orlando, B.; Cucari, N. Open Collaborative Innovation and Digital Platforms. *Prod. Plan. Control.* **2017**, *28*, 1344–1353. [[CrossRef](#)]
37. Inoue, Y.; Tsujimoto, M. Genres of Complementary Products in Platform-Based Markets: Changes in Evolutionary Mechanisms by Platform Diffusion Strategies. *Int. J. Innov. Manag.* **2018**, *22*, 1850004. [[CrossRef](#)]
38. Gawer, A.; Cusumano, M.A. Platform Leadership: How Intel, Microsoft, and Cisco drive industry innovation. Harvard Business School: Boston, MA, USA, 2002; ISBN 978-1578515141.
39. Tiwana, A.; Bush, A.A. Spotting Lemons in Platform Markets: A Conjoint Experiment on Signaling. *IEEE T. Eng. Manag.* **2014**, *61*, 393–405. [[CrossRef](#)]
40. Ravichandran, T. Exploring the Relationships Between IT Competence, Innovation Capacity and Organizational Agility. *J. Strateg. Inf. Syst.* **2017**, *27*, 22–42. [[CrossRef](#)]
41. Fatorachian, H.; Kazemi, H. A Critical Investigation of Industry 4.0 in Manufacturing: Theoretical Operationalisation Framework. *Prod. Plan. Control.* **2018**, 1–12. [[CrossRef](#)]
42. Kiel, D.; Arnold, C.; Voigt, K.I. The Influence of the Industrial Internet of Things on Business Models of Established Manufacturing Companies—A Business Level Perspective. *Technovation* **2017**, *68*, 4–19. [[CrossRef](#)]
43. Martinez, B.; Vilajosana, X.; Kim, I.H.; Zhou, J.; Tuset-Peiró, P.; Xhafa, A.; Poissonnier, D.; Lu, X. I3Mote: An open development platform for the intelligent industrial internet. *Sensors* **2017**, *17*, 986. [[CrossRef](#)] [[PubMed](#)]
44. Menon, K.; Kärkkäinen, H.; Wuest, T.; Gupta, J.P. Industrial internet platforms: A conceptual evaluation from a product lifecycle management perspective. *Proc. Inst. Mech. Eng. Part B: J. Eng. Manuf.* **2018**. [[CrossRef](#)]
45. Silva, M.; Vieira, E.; Signoretti, G.; Silva, I.; Silva, D.; Ferrari, P. A Customer Feedback Platform for Vehicle Manufacturing Compliant with Industry 4.0 Vision. *Sensors* **2018**, *18*, 3298. [[CrossRef](#)] [[PubMed](#)]
46. Alexopoulos, K.; Sipsas, K.; Xanthakis, E.; Makris, S.; Mourtzis, D. An industrial Internet of things based platform for context-aware information services in manufacturing. *Int. J. Comp. Integ.* **2018**, *31*, 1111–1123. [[CrossRef](#)]
47. Edmondson, A.C.; McManus, S.E. Methodological Fit in Management Field Research. *Acad. Manag. Rev.* **2007**, *32*, 1246–1264. [[CrossRef](#)]
48. Eisenhardt, K.M.; Graebner, M.E. Theory Building from Cases: Opportunities and Challenges. *Acad. Manag. J.* **2007**, *50*, 25–32. [[CrossRef](#)]
49. Benbasat, I.; Goldstein, D.K.; Mead, M. The Case Research Strategy in Studies of Information Systems. *MIS Q.* **1987**, *11*, 369–385. [[CrossRef](#)]
50. Yin, R.K. *Case Study Research: Design and Methods*; Sage: Thousand Oaks, CA, USA, 2009; ISBN 978-1506336169.
51. Dubé, L.; Paré, G. Rigor in Information Systems Positivist Case Research: Current Practices, Trends, and Recommendations. *MIS Q.* **2003**, *27*, 597–636. [[CrossRef](#)]
52. Mason, J. *Qualitative Researching*; Sage: Thousand Oaks, CA, USA, 2002; ISBN 978-0761974284.
53. Cannell, C.F.; Kahn, R.L. Interviewing. In *The Handbook of Social Psychology*, 2nd ed.; Lindzey, G., Aronson, E., Eds.; Addison-Wesley: Reading, MA, USA, 1968; pp. 525–595, ISBN 978-0201042634.
54. Kasabov, E. Start-Up Difficulties in Early-Stage Peripheral Clusters: The Case of IT in an Emerging Economy. *Entrep. Theory Pract.* **2015**, *39*, 727–761. [[CrossRef](#)]
55. Miles, M.B.; Huberman, M.A. *Qualitative Data Analysis*; Sage: Thousand Oaks, CA, USA, 1994; ISBN 978-0803955400.
56. Gioia, D.A.; Corley, K.G.; Hamilton, A.L. Seeking Qualitative Rigor in Inductive Research: Notes on the Gioia Methodology. *Organ. Res. Methods* **2013**, *16*, 15–31. [[CrossRef](#)]

57. Graebner, M.E.; Eisenhardt, K.M. The Seller's Side of the Story: Acquisition as Courtship and Governance as Syndicate in Entrepreneurial Firms. *Admin. Sci. Q.* **2004**, *49*, 366–403. [[CrossRef](#)]
58. Krippendorff, K. *Content Analysis*; Sage: Los Angeles, CA, USA, 2013; ISBN 978-1412983150.
59. Maxwell, J.A. *Qualitative Research Design*; Sage: Thousand Oaks, CA, USA, 1996; ISBN 978-0803973282.
60. Weston, C.; Gandell, T.; Beauchamp, J.; McAlpine, L.; Wiseman, C.; Beauchamp, C. Analyzing interview data: The development and evolution of a coding system. *Qual. Sociol.* **2001**, *24*, 381–400. [[CrossRef](#)]
61. Holsti, O.R. Content Analysis. In *The Handbook of Social Psychology*; Lindzey, G., Aronson, E., Eds.; McGraw-Hill: New York, NY, USA, 1968; pp. 596–692, ISBN 978-0201042641.
62. Eisenhardt, K.M. Building theories from case study research. *Acad. Manag. J.* **1989**, *14*, 532–551. [[CrossRef](#)]
63. Birkel, H.S.; Veile, J.W.; Müller, J.M.; Hartmann, E.; Voigt, K.-I. Development of a risk framework for Industry 4.0 in the context of sustainability for established manufacturers. *Sustainability* **2019**, *11*, 384. [[CrossRef](#)]
64. Müller, J.M.; Veile, J.W.; Voigt, K.-I. Cooperation strategies among SMEs for Implementing Industry 4.0. *Proc. Hamburg Int. Conf. Logist.* **2017**, *23*, 301–318. [[CrossRef](#)]
65. Seuring, S.; Müller, M. From a literature review to a conceptual framework for sustainable supply chain management. *J. Clean. Prod.* **2008**, *16*, 1699–1710. [[CrossRef](#)]
66. Ojala, A.; Evers, N.; Rialp, A. Extending the international new venture phenomenon to digital platform providers: A longitudinal case study. *J. World Bus.* **2018**, *53*, 725–739. [[CrossRef](#)]



© 2019 by the author. Licensee MDPI, Basel, Switzerland. This article is an open access article distributed under the terms and conditions of the Creative Commons Attribution (CC BY) license (<http://creativecommons.org/licenses/by/4.0/>).

Article

# A Decision Support Approach to Provide Sustainable Solutions to the Consumer, by Using Electrical Appliances

João Carlos de Oliveira Matias <sup>1,2</sup>, Ricardo Santos <sup>2,\*</sup> and Antonio Abreu <sup>3,4</sup>

<sup>1</sup> DEGEIT—Department of Economics, Management, Industrial Engineering and Tourism, University of Aveiro, 3810-193 Aveiro, Portugal; jmatias@ua.pt

<sup>2</sup> GOVCOPP—Research Unit on Governance, Competitiveness and Public Policies, University of Aveiro, 3810-193 Aveiro, Portugal

<sup>3</sup> Instituto Superior de Engenharia de Lisboa (ISEL), 1959-007 Lisboa, Portugal; ajfa@dem.isel.ipl.pt

<sup>4</sup> CTS—Uninova—Instituto de Desenvolvimento de Novas Tecnologias, 2829-516 Caparica, Portugal

\* Correspondence: ricardosimoessantos84@ua.pt

Received: 31 December 2018; Accepted: 13 February 2019; Published: 21 February 2019

**Abstract:** The diversity of energy efficiency appliances existent on the market, with all its different issues, contributes to the existence of several tradeoffs (e.g., energy and water consumption vs. initial investment), which make the consumer's choices in the market difficult. This becomes even more relevant, by knowing that nowadays a consumer tries to get a solution from the market, with a good compromise between the economic, social and environmental dimensions, and according to its priorities and specific needs, which can be different from other consumers. By adopting a multicriteria approach, combined with an optimization technique, based on evolutionary algorithms (EA), it will be possible to provide a set of sustainable solutions from the market to the consumer, that respects the compromise referred before. In this work, it will be presented an approach to support a decision-agent (DA) (consumer), by performing a set of sustainable choices based on electrical appliances, from the market and suitable to its needs. The method will be applied to a case study, to demonstrate its application. Regarding the obtained solutions, several savings are achieved (electrical and water consumption, CO<sub>2</sub> emissions) by taking into account the consumer's relative importance, regarding each dimension considered.

**Keywords:** sustainable development; energy efficiency; electrical appliances; life cycle cost analysis (LCCA); multi-attribute value theory (MAVT); multi-objective optimization; NSGAII

---

## 1. Introduction

Nowadays, energy plays an important key role on our society, where energetic necessities, are highly associated with issues such the growth of population, the economic development and the progress of technology [1].

Despite the technology progress, the energy demand has risen in the last years, especially regarding the last decade, threatening therefore, the last commitments made on behalf of the reduction of greenhouse gas emissions (GEE) in the atmosphere, given the high dependency of the electrical energy production, in the use of fossil fuels [2].

According to [3,4] and more recently [5] the reduction of energy consumption is necessary to get sustainability, with buildings accounting 40 percent (approx.) of the final energy consumed [6].

From that percentage, the residential sector, represents about 14% of the final world's electric energy consumed [7], representing thus an important sector to improve energy efficiency, by achieving sustainable solutions/measures.

Recently, there were made some energy efficiency improvements regarding electrical household appliances, not only in the European region, but in other regions around the world, such as Asia, America and Africa [8]. One of such measures is mandatory labeling [8–10], which provides relevant information to the consumer, related to each electrical appliance (e.g., noise (air conditioner), energy consumption, cloth capacity (washing machine), etc.), promoting therefore a suitable use, adjusted to its needs [11].

However, and given the several options available in the market (brands and models) as well as an appliance's own features, it is difficult to analyze their benefit–cost ratio and, therefore, which solution is better to the consumer [12–16].

In this sense, multiple-attribute value theory (MAVT), could be used as a method, to define the space decision and both objective functions.

Furthermore, the use of optimization techniques, combined with MAVT, can support the decision-agent (consumer), by achieving sustainable solutions, through the household appliances to be acquired.

Given the previous work from [17], evolutionary algorithms (EA), more specifically genetic algorithms, have been successfully applied to solve optimization problems with less time than other algorithms, given their stochastic nature and global search ability [18–23].

Therefore, this work aims to contribute with an integrated approach, based on MAVT and Non-Dominated Sorting Genetic Algorithm II (NSGAI), by providing the consumer with sustainable solutions from the market, considering its different needs.

## **2. Literature Review and Contribution**

### *2.1. Literature Review*

Methods like simulation (e.g., [24]), based on what if analysis, are commonly employed to simulate a limited set of options.

Some approaches, however, are mainly economical, allowing consumers therefore to obtain the highest energy savings, for the same initial investment (e.g., [24,25]). Other approaches explore issues such as benefit-cost analysis, initial investment costs, GEE emission savings, among others, regarding retrofitting measures (e.g., [26]), where some of them are even combined with technologies too (e.g., [25]).

Although, these approaches are considered limited, since they don't account other important factors (e.g., environment, labelling, legal, social, among others) to find solutions, that are suitable to the occupant's needs. They also don't consider the criteria related to each electrical appliance, exist on market, which varies according to the number of household occupants.

Nowadays, some works have developed multi-criteria decision-making (MCDM) models to support decision-agents to solve problems regarding building's retrofits, by considering energy efficiency and building's internal comfort (e.g., [22]), although others, were performed through the ranking of different options (e.g., [23]).

In the same context, there are also other MCDM models, as well as multiple-attribute value theory (MAVT) methods found in the literature that joins optimization with multicriteria methods to obtain feasible solutions through a set of measures/solutions, chosen according to a set of criteria (e.g., [24–26]).

Although, such methods don't take into consideration the different criteria related to each electrical appliance, existed on the market, suitable to the occupants' needs.

Metaheuristics have been also considered to solve energy problems as method to provide a set of feasible solutions, such as particle swarm optimization (PSO) (e.g., [15]) as well as genetic algorithms (GA's) (e.g., [19]), among others.

However, none of these methods have been integrated into a combined approach that allows selection of sustainable appliances by a decision-agent, according to a set of criteria.

## 2.2. Contribution

The literature, discussed above, shows one gap, regarding the retrofit measures for buildings, that allows to support a household consumer to choose a set of sustainable solutions (electrical appliances) from the market.

To fill the gap discussed before in the literature, this paper presents a decision support method, which allows the decision agent to be provided with a set of household appliances, existed in the market, by considering each energy service to be acquired.

The obtained solutions allow promotion of sustainability by acting on its tree dimensions, i.e., economical (e.g., consumption savings, savings regarding initial investment costs), environmental (GEE emissions and water consumption savings), and social. The approach includes economical (e.g., budget restrictions) as well as environment (e.g., noise) restrictions, regarding each energy service considered in the case study.

## 3. Materials and Methods

### 3.1. Problem Statement

This problem will take into account a household consumer, that wants to buy from the market, a set of household appliances. In this case, it was considered that seven different energy services were to be acquired; lighting, air conditioner, washing machine, dish washing machine, electric oven, dryer machine and refrigerator.

The DA has a limit budget to perform such decision (2100 € in the case study), and he wants to achieve a set of sustainable solutions, not only good from the social point of view (by pre-selecting the appliances according to its needs), but a set of solutions that allows them to achieve a good compromise between its economic and environment concerns, which are expressed as a set of two relative importance factors (weights), respectively  $\omega_A$  (economics) and  $\omega_B$  (environment). In this case, it was considered (respectively) 0.7 and 0.3.

The building has four occupants (decision-agent included). Given his intention into acquire an air conditioner (and based on the well-known room area to be climatized), the corresponding heating and cooling needs were calculated. Such value, as well as the remain criteria to pre-select the appliances from the market, regarding the number of 4 occupants, is presented on Table 1.

**Table 1.** Criteria used to pre-select the appliances from the market (applied to case study).

Electrical Appliance	Criteria Used	Characteristics
Air conditioner	types of air conditioner considered: heated/cooled zone minimum capacity required	wall (mono split) wall (multi split) Portable living room 9905.6 BTU
Washing machine	Capacity according to the number of household's occupants [9]	7 kg
Dishwasher	load capacity.	12 cutlery
Oven	volume, based on the nr. of occupants [9]	47 cm × 68 cm
Dryer machine	type of dryer machines load capacity from [9]	by exhaust 7 kg
Lighting	technology	halogen Compact Fluorescent Light (CFL) Fluorescent
Refrigerator	capacity of the refrigerators [9] type of refrigerator according to the number of occupants [9]	150 L refrigerator Combined type



The remaining assumptions are shown on Tables 2 and 3, as well as the correspondent consumption profile (Table 3).

**Table 2.** Tariffs used and other assumptions considered.

<b>Emission Factor [gCO<sub>2</sub>/kWh]</b>	<b>675</b>	<b>Discount Factor [%]</b>	<b>7</b>
Life cycle (usage phase) [years]:	10	Annual Factor	7.02
Electrical Energy tariff [€/kWh]	0.162	Water tariff [€/m <sup>3</sup> ]	1.19

**Table 3.** Consumer usage profile (considered).

<b>Emission Factor [gCO<sub>2</sub>/kWh]</b>	<b>675</b>	<b>Discount Factor [%]</b>	<b>7</b>
<b>Life cycle (usage phase) [years]:</b>	<b>10</b>	<b>Annual Factor</b>	<b>7.02</b>
<b>Electrical Energy tariff [€/kWh]</b>	<b>0.162</b>	<b>Water tariff [€/m<sup>3</sup>]</b>	<b>1.19</b>
<b>Energy Service</b>	<b>Usage Profile (h)</b>		
	Daily	Weekly	Monthly
<b>Air Conditioner</b>	2	12	48
<b>Washing Machine</b>	1	4	16
<b>Dryer Machine</b>	1	4	16
<b>Refrigerator</b>	11	77	330
<b>Electric Oven</b>	1	2	8
<b>Dish Washing Machine</b>	1	4	16
<b>Lighting</b>	5	35	150
			1825
<b>Energy Service</b>	<b>Usage Profile (Frequency)</b>		
	Daily	Weekly	Monthly
<b>Air Conditioner</b>	1	6	24
<b>Washing Machine</b>	1	4	16
<b>Dryer Machine</b>	1	4	16
<b>Refrigerator</b>	1	7	30
<b>Electric Oven</b>	1	2	8
<b>Dish Washing Machine</b>	1	4	16
<b>Lighting</b>	1	7	30
			365

The consumption profile was performed, by making a set of assumptions based on the hours, which was then extrapolated to a weekly and year base. However, the decision-agent (consumer) can also define its usage profile, according to its needs, or by using the profile, presented here, as a default.

The data, from Table 3, will be adopted to perform a life cycle cost analysis (LCCA), considering each individual solution, as will be described in the next section.

### 3.2. Data Set

Additionally to the data referred to before, regarding the criteria used (Table 1) and consumer usage profile (Table 2), data regarding the electricity consumption were considered, according to the consumer usage profile assumed in Table 2, i.e., on an hourly, daily, monthly and yearly basis, even then extrapolated for the lifecycle considered in this case study (10 years), performing a LCCA, regarding each appliance from each energy service, during the usage phase (Annex I).

Data regarding the initial investment, as well as the criteria referred above and the remain data (brand and model) regarding each appliance, was also considered (Annex I).

### 3.3. Proposed Approach

The approach presented here, was developed to support a DA who wants to buy a set of household appliances existed on market.

This set of appliances, regarding each energy service, are potential solutions, provided by the proposed approach, presented on Figure 1.

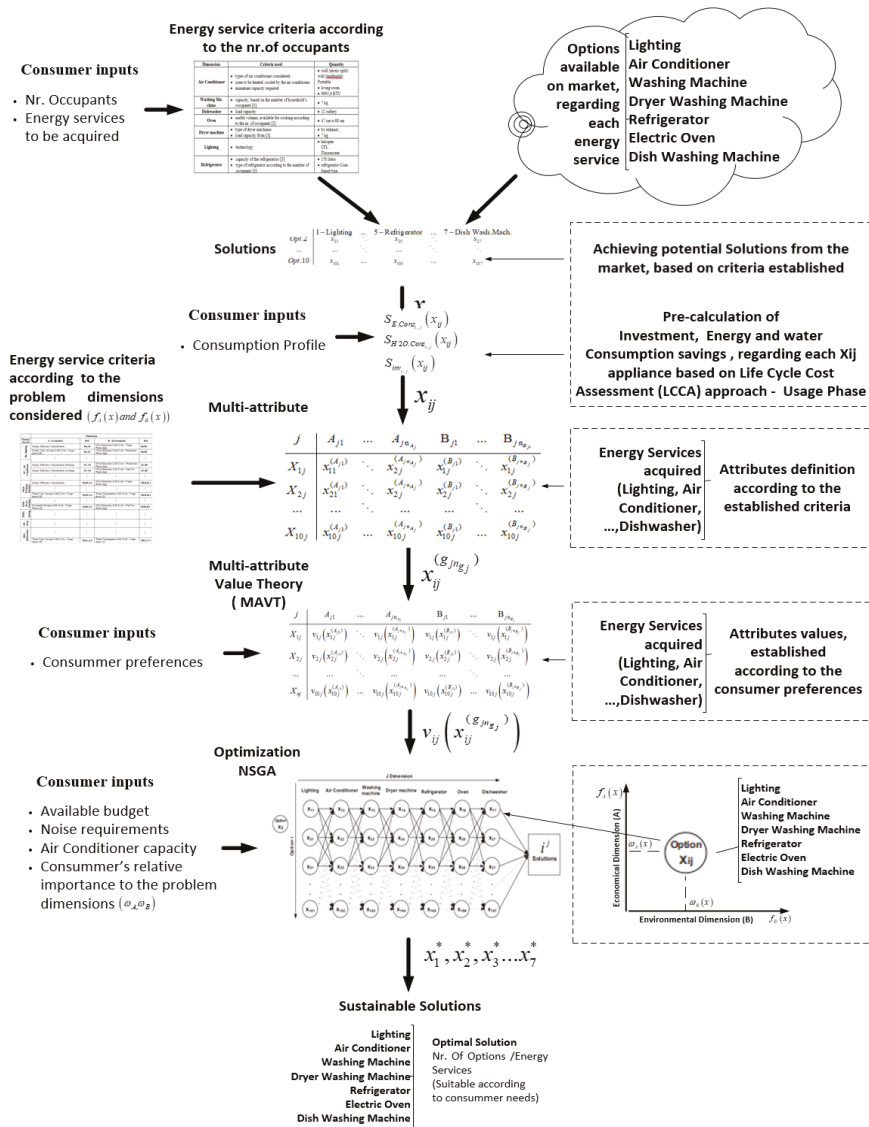

Figure 1. Model proposed.

At first, a set of potential solutions ( $x_{ij}$ ) are pre-selected from the market, according to specific criteria, according to building occupants. The criteria are the same, although the value of the correspondent attributes can change according to the building number of occupants. An example of such a table is presented in Table 1 regarding the case study presented here.

This pre-selection allows to reduce the decision space, accounting only the solutions, suitable to the consumer needs, as well as to increase NSGAII efficiency, by achieving optimal solutions with less time.

Each one of these potential solutions ( $x_{ij}$ ), is then formulated as an option  $i$ , regarding energy service  $j$ , to be acquired by the DA (consumer) from the market.

Given a DA consumption profile (e.g., Table 2), LCCA is then performed to achieve, for each appliance, the corresponding savings, regarding energy consumption ( $S_{E.Cons_{ij}}(x_{ij})$ ), water consumption ( $S_{H_2O.Cons_{ij}}(x_{ij})$ ) as well as the initial investment ( $S_{inv_{ij}}(x_{ij})$ ). Both parameters, are savings, obtained from the comparison between the efficient and the correspondent “standard solution” (less efficient one).

Given the diversity of features, regarding each solution, as well as the DA’s economic, social and environmental concerns, a set of attributes was defined according to the consumer preferences and regarding each energy service, for the two problem dimensions considered; A-Economics, B-Environment. These attributes are presented on Table 4.

**Table 4.** Attributes used to define problem dimensions, regarding each energy service considered.

Energy Service	Dimension			
	A-Economics	Ref.	B-Environment	Ref.
Ilu—lighting	Energy Efficiency Classification	Ilu.A1	CO <sub>2</sub> e Emissions (Life Cycle—Usage Phase) [kg]	Ilu.B1
	Energy Cons. Savings (Life Cycle—Usage phase) [€]	Ilu.A2	CO <sub>2</sub> e Emissions (Life Cycle—Production Phase) [kg]	Ilu.B2
	⋮	⋮	⋮	⋮
AC—Air Conditioner	Energy Efficiency Classification (Heating)	AC.A2	CO <sub>2</sub> e Emissions (Life Cycle—Production Phase) [kg]	AC.B2
	Energy Efficiency Classification (Cooling)	AC.A3	CO <sub>2</sub> e Emissions (Life Cycle—End Use Phase) [kg]	AC.B3
	⋮	⋮	⋮	⋮
MLR—Washing Machine	Energy Efficiency Classification	MLR.A.1	CO <sub>2</sub> e Emissions (Life Cycle—Usage Phase) [kg]	MLR.B.1
	⋮	⋮	⋮	⋮
	Water Cons. Savings (Life Cycle—Usage phase) [€]	MLR.A.4	Water Consumption (Life Cycle—Usage phase) [3]	MLR.B.4
MSR—Dryer Machine	⋮	⋮	⋮	⋮
	Investment Savings (Life Cycle—Usage Phase) [€]	MSR.A.3	CO <sub>2</sub> e Emissions (Life Cycle—End Use Phase) [kg]	MSR.B3
FRIG.—Refrigerator	⋮	⋮	⋮	⋮
FE—Oven	⋮	⋮	⋮	⋮
MLL—Dishwasher	⋮	⋮	⋮	⋮
	Water Cons. Savings (Life Cycle—Usage phase) [€]	MLL.A.4	Water Consumption (Life Cycle—Usage phase) [3]	MLL.C.4

Apart from the energy efficiency classification (Table 4), regarding each energy label, belonging to each energy service, all the adopted attributes can be applied into other regions. In this case, the EU’s Energy Labelling framework Regulation (2017/1369) was adopted, although, and with the correspondent adjustments referred before, it can be applied in other world regions.

The consumption profile was performed, by making a set of assumptions based on the hours, which was then extrapolated to a weekly and year base. However, the decision-agent (consumer) can also define its usage profile according to its needs, or by using the profile, considered in the case study presented here, as a default.

As referred to before, MAVT is used to support the DA, by evaluating a set of alternative solutions, according to a set of criteria/attributes established (Table 1).

Based on criteria from Table 1, it was defined  $x_{ij}^{(gjt)}$ , as the attribute regarding each alternative solution  $i$ , associated to a certain energy service  $j$ , established according to criteria  $t$ , associated to energy service  $j$  and problem dimension  $g$  considered (A-Economical; B-Environmental), i.e.,

$$g_{jt} \in \left\{ \left\{ A_{j1}, A_{j2}, \dots, A_{jn_{A_j}} \right\} \cup \left\{ B_{j1}, B_{j2}, \dots, B_{jn_{B_j}} \right\} \right\} \tag{1}$$

with:

$$g = \{A, B\} \wedge j = \{1, 2, \dots, 7\} \wedge t = \left\{ \left\{ 1, 2, \dots, n_{A_j} \right\} \cup \left\{ 1, 2, \dots, n_{B_j} \right\} \right\} \wedge n_{A_j}, n_{B_j}, t, j \in \mathbb{N} \tag{2}$$

By following the notation described above and based on criteria established in Table 1, as well as the assumptions presented on Tables 2 and 3 for the considered case study, the correspondent attribute  $\left(x_{ij}^{(gjt)}\right)$  behavior/pay-off was defined, regarding each option  $i$ , belonging to energy service  $j$ . On Figure 2a), an example of this table, regarding the energy service “Lighting”, is presented.

Lighting	A.1 <sub>1</sub>	...	A.n <sub>1</sub>	B.1 <sub>1</sub>	...	B.n <sub>1</sub>	Lighting	A.1 <sub>1</sub>	...	A.n <sub>1</sub>	B.1 <sub>1</sub>	...	B.n <sub>1</sub>
X <sub>11</sub>	x <sub>11</sub> <sup>(A.1)</sup>	...	x <sub>1n<sub>1</sub></sub> <sup>(A.n<sub>1</sub>)</sup>	x <sub>11</sub> <sup>(B.1)</sup>	...	x <sub>1n<sub>1</sub></sub> <sup>(B.n<sub>1</sub>)</sup>	X <sub>11</sub>	v <sub>11</sub> (x <sub>11</sub> <sup>(A.1)</sup> )	...	v <sub>11</sub> (x <sub>1n<sub>1</sub></sub> <sup>(A.n<sub>1</sub>)</sup> )	v <sub>11</sub> (x <sub>11</sub> <sup>(B.1)</sup> )	...	v <sub>11</sub> (x <sub>1n<sub>1</sub></sub> <sup>(B.n<sub>1</sub>)</sup> )
X <sub>21</sub>	x <sub>21</sub> <sup>(A.1)</sup>	...	x <sub>2n<sub>1</sub></sub> <sup>(A.n<sub>1</sub>)</sup>	x <sub>21</sub> <sup>(B.1)</sup>	...	x <sub>2n<sub>1</sub></sub> <sup>(B.n<sub>1</sub>)</sup>	X <sub>21</sub>	v <sub>21</sub> (x <sub>21</sub> <sup>(A.1)</sup> )	...	v <sub>21</sub> (x <sub>2n<sub>1</sub></sub> <sup>(A.n<sub>1</sub>)</sup> )	v <sub>21</sub> (x <sub>21</sub> <sup>(B.1)</sup> )	...	v <sub>21</sub> (x <sub>2n<sub>1</sub></sub> <sup>(B.n<sub>1</sub>)</sup> )
...	...	...	...	...	...	...	...	...	...	...	...	...	...
X <sub>101</sub>	x <sub>101</sub> <sup>(A.1)</sup>	...	x <sub>10n<sub>1</sub></sub> <sup>(A.n<sub>1</sub>)</sup>	x <sub>101</sub> <sup>(B.1)</sup>	...	x <sub>10n<sub>1</sub></sub> <sup>(B.n<sub>1</sub>)</sup>	X <sub>101</sub>	v <sub>101</sub> (x <sub>101</sub> <sup>(A.1)</sup> )	...	v <sub>101</sub> (x <sub>10n<sub>1</sub></sub> <sup>(A.n<sub>1</sub>)</sup> )	v <sub>101</sub> (x <sub>101</sub> <sup>(B.1)</sup> )	...	v <sub>101</sub> (x <sub>10n<sub>1</sub></sub> <sup>(B.n<sub>1</sub>)</sup> )

Figure 2. Example of evaluation table (lighting energy service): (a)  $x_{ij}^{(gjt)}$ ; (b)  $v_{ij}(x_{ij}^{(gjt)})$ .

Therefore, and according to MAVT, there is a value  $v_{ij}^{(gjt)}\left(x_{ij}^{(gjt)}\right)$ , associated to the attribute  $x_{ij}^{(gjt)}$ , such as:

$$x_{ij}^{(gjt)} \longrightarrow v_{ij}^{(gjt)}\left(x_{ij}^{(gjt)}\right) \tag{3}$$

Given the 2 objectives considered, different attributes are used to define the performance regarding the set of objectives defined.

Therefore, in order to transform the criteria to follow the same scale and units, an expression was used to establish the relationship between the new and the previous value of  $x_{ij}^{(gjt)}$ , respectively  $\left(v_{ij}^{(2)}\left(x_{ij}^{(gjt)}\right)\right)$  and  $\left(v_{ij}^{(1)}\left(x_{ij}^{(gjt)}\right)\right)$ , by using also the corresponding worst and better results, for a given criteria  $g_{jt}$ , i.e.,

$$v_{ij}(x_{ij}^{(2)}) = \frac{\left(v_{ij}^{(1)}\left(x_{ij}^{(gjt)}\right) - v_{worst,ij}\left(x_{ij}^{(gjt)}\right)\right)}{\left(v_{better,ij}\left(x_{ij}^{(gjt)}\right) - v_{worst,ij}\left(x_{ij}^{(gjt)}\right)\right)} \tag{4}$$

The new values of each  $x_{ij}^{(gjt)}\left(v_{ij}\left(x_{ij}^{(gjt)}\right)\right)$ , fills a new evaluation table, belonging to each energy service  $j$ . On Figure 2b), it's shown an example for a table regarding energy service “Lighting”.

Based on the value attributes, previously achieved, it was used the additive model to aggregate them, referred to each option  $i$ , regarding energy service  $j$ , which was further improved, by applying optimization techniques, by using NSGAII algorithm.

The consumer will face a problem of the type of a combinatorial (Figure 1), where the number of combinations is dependent on the number of individual solutions to be considered, related to each energy service (23 million combinations in the case study considered here). This number of

combinations can be reduced by assuming that the consumer cannot perform any choices ( $x_{ij}$ ), given his limited budget (Figure 1).

Constraints like the air conditioner capacity and appliances noise maximal requirements will also be accounted for to suit consumer needs in order to improve its social wellbeing.

After defining the value attributes of each potential solution, and by using the additive model, the problem presented here can be formulated as follows:

$$\begin{aligned} \max \quad & V_m(x), \quad c / m = A, B \\ \text{subject to } & x \in X \quad c / V_m(x) = [V_A(x), V_B(x)]^T \end{aligned} \tag{5}$$

where  $x$  is the decision variable vector, defined as:

$$x \in X : x \in \left\{ x_{ij}^{(A_{jt})}, x_{ij}^{(B_{jt})} \right\} \wedge t, i, j \in \mathbb{N} \tag{6}$$

with,

$$j = \{1, \dots, 10\} \wedge j = \{1, 2, \dots, 7\} \wedge t = \left\{ \{1, \dots, n_{A_j}\} \cup \{1, \dots, n_{B_j}\} \right\} \wedge n_{A_j}, n_{B_j} \in \mathbb{N} \tag{7}$$

where  $V_A(x)$  and  $V_B(x)$ , are the aggregate objective functions, regarding each dimension considered (A-Economics; B-Environment):

$$V_g(x) = \sum_{j=1}^{n_j} \sum_{t=1}^{n_{g_j}} v_j(x_j^{(g_{jt})}) \quad w/g = \{A, B\} \wedge v_j(x_j^{(g_{jt})}) \wedge n_j, n_{g_j}, t, j \in \mathbb{N} \tag{8}$$

Therefore, and based on (8), the objective functions are:

$$\text{Economic Well - being : } \max V_A(x) = \sum_{j=1}^{n_j} \sum_{t=1}^{n_{A_j}} v_j(x_j^{(A_{jt})}) \tag{9}$$

$$\text{Environment Well - being : } \max V_B(x) = \sum_{j=1}^{n_j} \sum_{t=1}^{n_{B_j}} v_j(x_j^{(B_{jt})}) \tag{10}$$

The first objective function is based on the work of [20].

By using the additive model from MAVT, the aggregated function results in a unique objective function, weighted by the decision-agent relative importance ( $\omega_g$ ) as follows:

$$V(V_A(x), V_B(x)) = \omega_A \cdot V_A(x) + \omega_B \cdot V_B(x) = \sum_{j=1}^{n_j} \left( \omega_A \sum_{t=1}^{n_{A_j}} v_j(x_j^{(A_{jt})}) + \omega_B \sum_{t=1}^{n_{B_j}} v_j(x_j^{(B_{jt})}) \right) \tag{11}$$

The constraints, regarding economic and environment well-being/dimensions, are:

Economic–Budget:

$$r_1 : \sum_{j=1}^{n_{dim}} I_j(x_j) \leq \text{available budget } (\eta_{disp.}) \Leftrightarrow \sum_{j=1}^{n_{dim}} x_j^{(A_{jt})} \leq \eta_{disp.} \tag{12}$$

with

$$A_{jt} = \{A_{14}, A_{26}, A_{35}, A_{44}, A_{54}, A_{64}, A_{75}\} \wedge n_{dim}, t, j \in \mathbb{N} \tag{13}$$

Environment–Noise:

$$r_j : \text{Noise}_j \leq \text{Max.Noise}_j \Leftrightarrow x_j^{(B_{jt})} \leq \text{Max.Noise}_j \tag{14}$$

With:

$$B_{jt} = \{B_{24}, B_{35}, B_{44}, B_{54}, B_{64}, B_{75}\} \wedge n_{\text{dim}}, t, j \in \mathbb{N} \quad (15)$$

The NSGAI individual framework, is presented as follows on Figure 4.

As referred to before, NSGAI's codification used was real so that it can only be chosen in one individual solution, regarding each type of appliance at the time.

The model will be applied, using the case study presented before, and by considering a consumer (DA), who wants to buy seven energy services.

### 3.4. Strengths and Weakness of the Presented Model

The presented approach deals with the LCCA concept by predicting, according to a given consumption profile, the costs associated with the usage phase, corresponding to each electrical appliance (energy service) to be considered. The consumer's needs (e.g., cloth dryer machine, fridge and air conditioner capacities, among others) are also considered, to provide the decision-agent with more suitable appliances existing in the market.

Besides the Environment dimension, the preferences regarding the consumer's relative importance corresponding to each dimension (Environment and Economics) are also considered in this work.

Given its advantages in getting several optimal (sustainable) and different solutions, the approach presented here allows use to prevent an eventual unavailability of a specific appliance.

The social dimension, although implicit through consumer preferences and needs, needs to be more explicit, which will be one of the improvements of this work.

The LCCA only accounts the usage phase in this work. Therefore, further developments will be included in future, given this issue.

### 3.5. Non-Dominated Sorting Genetic Algorithm II (NSGAI)

Given GA's successful in guaranteeing optimal solutions, as well as its advantages faced other methods [27], we decided to use it in this study.

Therefore, the approach proposed here, will use the NSGAI as an optimization method to deal with the potential solutions, resulting from the multicriteria analysis.

In general, NSGAI presents good performance on optimizing two objective functions, with efficiency, by making use of two approaches; a non-domination rank and crowding distance. The first one allows to reduce the time of computation, while the second one, guides in the selection process [28].

In a maximization problem (for both objective functions), if a fitness value of solution j is more than the correspondent one from solution i, then solution j dominates solution i, with j having a better ranking.

When both solutions, have the same rank, the solution placed in the region with less crowd, is selected [28] (Figure 3). We used NSGAI in our study, to create diverse solutions for the two objectives considered.

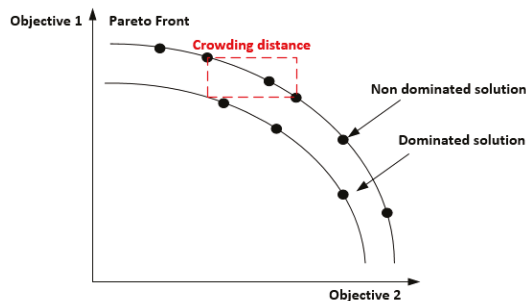

Figure 3. Crowding distance and non-dominated solutions.

As it was referred before, NSGAI’s codification used, was real, so it can only be chosen as one individual solution, regarding each type of appliance at the time.

The NSGAI individual framework is presented as follows in Figure 4:

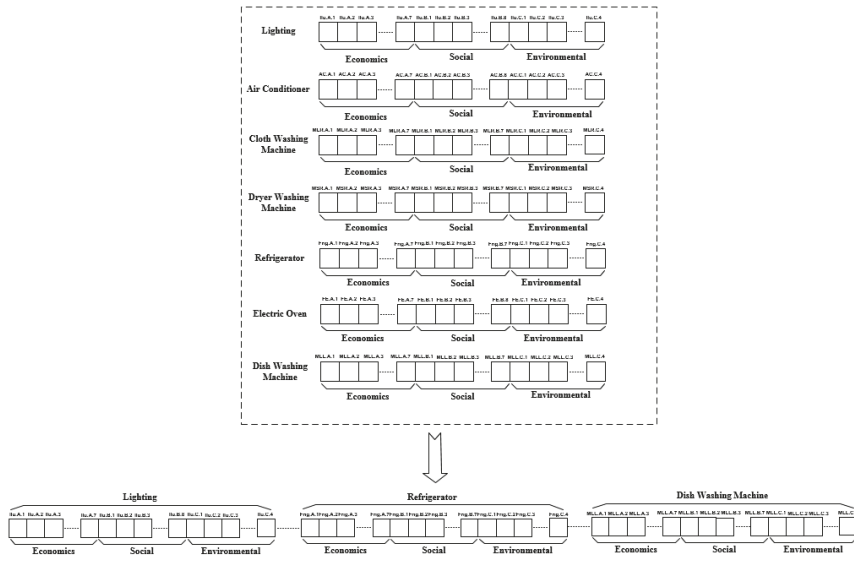

Figure 4. GA’s individual framework.

The GA’s iteration process, applied here, makes use of several steps, which includes initialization, crossover, and selection (Figure 5). Parameters like the population size, iteration size, and crossover rate, were determined experimentally.

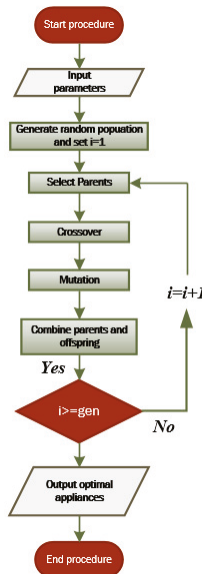

Figure 5. Non-dominated sorting genetic algorithm II (NSGAI) individual framework.

### Initialize population

The first generation is formed by the randomized generation of a number  $n$  of individuals, which is called the population size. In this work, each solution carries the information of a potential aggregated solution formed by a set of appliances desired by the DA.

### Evaluate fitness

The fitness function allows us to perform a continuous evolutionary search by NSGAI, with the fitness values of each individual solution, being calculated and evaluated.

Each individual is then ranked, selected and determined.

### Selection, crossover and mutation

The next generation is achieved by the selection, crossover and mutation operators. Individuals are randomly selected by Tournament into a group, where the best ones, are selected for crossover [17]. Therefore, it's introduced by this operator, the randomness and certainty characteristics.

The best solutions/individuals are selected from the parents and offspring. The last one, is obtained through the individuals generated from the crossover and mutation operators. The iteration process finishes, after the maximum iteration is satisfied, by finding the correspondent Pareto frontier.

## 4. Results and Discussion

NSGAI was implemented by using Matlab code, by considering the following parameters:

- Selection method: tournament
- Crossover method: single point
- Mutation used: normal random mutation

The remaining NSGA-II parameters (initial population, crossover and mutation rate) were defined after several runs.

The max generations parameter was tested at first, where it was selected a maximum generation number of 90 to show that if 90 iterations were enough to find the Pareto curve. Other parameters were also tested, such as the population size (100 individuals), the tournament size (10), the crossover rate (0.9), and the mutation rate (0.3). The results obtained, regarding the 90th and 100th generations, are presented on Figure 6, where it can be seen that both cases have a similar Pareto frontier. In this sense the max number of iterations/generations of 90 were selected. Then, several combinations of crossover and mutation rates of NSGA-II were performed (Table 5).

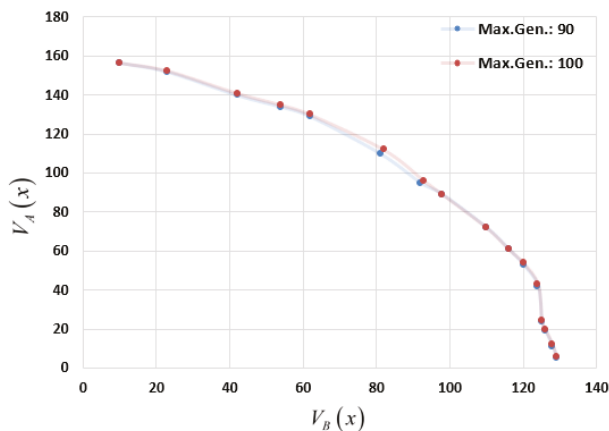

Figure 6. Pareto frontier for 90th and 100th generations.



Table 5. Combinations of crossover and mutation rates used.

Experiment	Crossover Rate	Mutation Rate
1	0.8	0.1
2	0.8	0.3
3	0.9	0.1
4	0.9	0.3

The combinations, presented on Table 4, were performed by setting a max iteration of 90. The correspondent results are shown on Figure 7, where it's noted that the small change on parameters, has a reduced effect in the results. Thus, NSGAI's parameters were used to show the results of the present case: population size (100), max iteration (90), tournament size (10), crossover rate (0.9) and mutation rate (0,1).

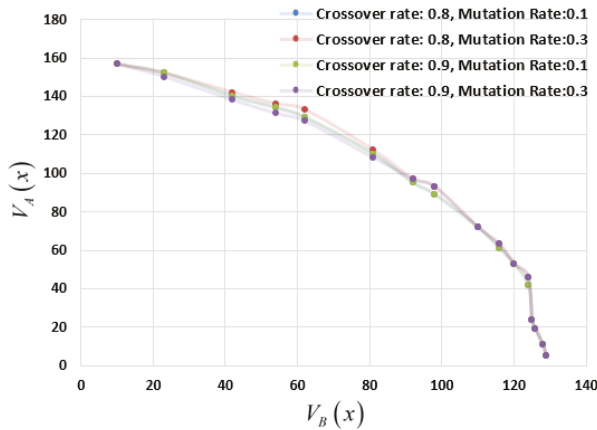

Figure 7. Pareto frontier for different parameters of NSGAI.

NSGA-II is applied on resolution of multi-objective problems. Therefore, the correspondent solution, is a Pareto frontier, which is gradually formed through an iteration process, where is an increase in the number of solutions of Pareto frontier in the first generations. Once the frontier was formed, improved results regarding each solution were founded in further generations (Figure 8).

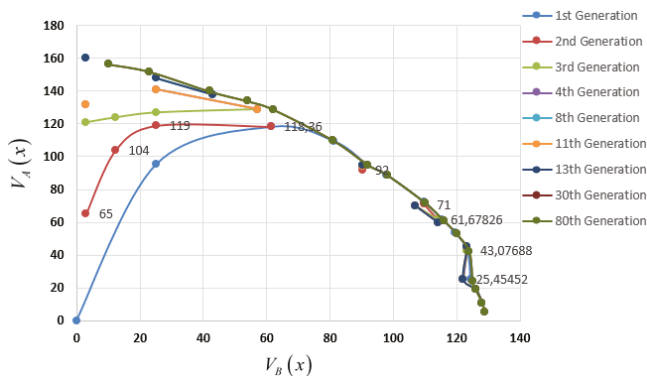

Figure 8. Pareto frontier for different generations of the selected parameters.

After NSGAII calculations, the Pareto frontier in Figure 9 is thereby obtained, where each node represents a potential solution of the problem, i.e., a set of sustainable solutions (appliances) regarding each energy service required.

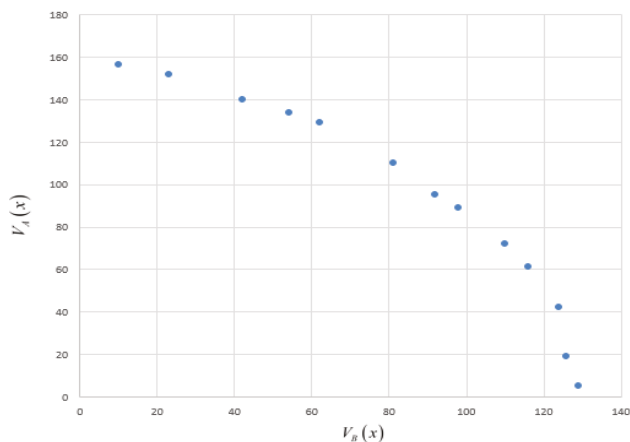

Figure 9. Pareto frontier of the last generation.

Although the economic well-being decreases, the environmental well-being increases here.

One of these nodes are presented on Table 3, as an example of a feasible solution obtained, considering a budget of 2100 €.

Thirteen potential solutions were selected regarding the last generation by the algorithm, as an example of a Pareto frontier.

One of these nodes are presented in Table 6, as an example of a feasible solution, considering a budget of 2100 € and a life cycle (usage phase) of 10 years.

Table 6. Example of a sustainable solution obtained.

Electrical Appliance	Stand. Solution Total Invest. (€)	Effic. sol. Total Invest (€)	Invest. Saving (€)	Energy Consum. Savings (€)	Water Consum. Savings (l)	CO <sub>2</sub> Savings (kg)	Brand	Model
Lighting	15.89	09.53	5.34	59.40	-	28.90	GE	EFL23W
Air Conditioning	368.00	299.00	69.00	1320.60	-	1315.70	Whirlpool	PACW9HP
Refrigerator	250.00	529.00	-279.00	708.10	-	8.70	Candy	CFET 6182W
Dishwasher Machine	310.00	349.00	-39.00	3.20	423.00	6.90	Bosch	SMS25AI00E
Washing Machine	262.00	294.00	-32.00	6.90	317.00	94.80	Siemens	WI12A222ES
Oven	170.00	199.00	-29.00	1.70	-	2.20	Zanussi	ZZB21601XV
Clothes dryer	349.00	419.00	-70.00	12.30	-	1.70	Electrolux	EDP2074PDW
Total	1724.90	2099.60	-374.70	2112.30	740.00	1458.90	-	-

The CO<sub>2</sub> savings are also presented, compared with the less efficient one (standard solution).

Based on Table 6, if the consumer opts for the solutions set provided by this approach, he can save up to 2112.3 €, further contributing to a 1458.9 kg of CO<sub>2</sub> and 740 L of water, both savings/years, based on the life cycle considered.

## 5. Conclusions and Further Work

In this paper, an approach to provide sustainable electrical household appliances from the market to the decision-agent (consumer) was presented, considering two problem dimensions (objectives), regarding sustainability; environment and economic well-being.

Both solutions were pre-selected, based on a set of specific criteria, related to each type of appliance, considered by the case study.

Criteria were used to pre-select the appliances from the market adjusting therefore, the method to the case study presented here.

Other criteria were also used combined with MAVT to model the consumer preferences, according to the two problem dimensions presented here.

The main objective was to maximize consumer well-being (environment and economics). Social wellbeing was also promoted, by suit the obtained solutions to the consumer needs.

The relative importance, given by the DA (consumer), was also considered, in order to weight the DA decision through both dimensions.

NSGAI were then applied here to obtain optimal solutions by maximizing both dimensions, considering the environmental impact (CO<sub>2</sub> and water savings), as well as the economic rationality (initial investment and energy consumption savings) regarding the lifecycle of each appliance, during its usage phase.

The results show that this method provides alternative (and sustainable) appliances that attend the consumer's needs.

We test different parameters (max number of iterations, crossover and mutation rates) and their correspondent values, are not quite sensitive to the results. Additionally, NSGAI can also find the Pareto frontier of the solutions, providing therefore several alternative solutions to the consumer.

The achievements presented on this work, allows to proceed in a way of getting a more completed approach that maximizes all the dimensions of sustainability: economical, environmental and social.

Therefore, the social dimension, although implicit through consumer preferences and needs, will more explicit, by being expressed through a third dimension to be included in the model.

As referred to before, the LCCA only accounts the usage phase in this work, bringing up the need to include the remaining LCCA phases (Production and Final Disposal) as further developments to be considered in this work.

As referred to in Section 1, there are several regions around the world, where energy efficiency measures have been applied.

Therefore, and based on what was referred to in Section 3, apart from energy efficiency classification, all the adopted attributes can be applied into other regions. In this work, it was adopted the EU's Energy Labelling framework Regulation (2017/1369) for energy efficiency classification, although, and with the correspondent adjustments referred before, it can be applied into other world's regions, adjusted to each consumer's individual needs, as referred to above.

**Author Contributions:** Conceptualization, J.C.d.O.M. and R.S.; methodology, A.A., R.S.; software, A.A.; validation, R.S.; formal analysis, J.C.d.O.M.; investigation, R.S.; resources, R.S. and A.A.; data curation, A.A.; writing—original draft preparation, R.S.; writing—review and editing, J.C.d.O.M., Ricardo Santos and A.A.; visualization, A.A.; supervision, J.C.d.O.M. and A.A.

**Funding:** This research received no external funding.

**Acknowledgments:** In this section you can acknowledge any support given which is not covered by the author contribution or funding sections. This may include administrative and technical support, or donations in kind (e.g., materials used for experiments).

**Conflicts of Interest:** The authors declare no conflict of interest.

## References

1. Matias, J.C.O.; Devezas, T.C. Socio-Economic Development and Primary Energy Sources Substitution towards Decarbonization. *Low Carbon Econ.* **2011**, *2*, 49–53. [[CrossRef](#)]

2. IPCC. *Climate Change 2014: Mitigation of Climate Change Summary for Policymakers and Technical Summary*; Intergovernmental Panel on Climate Change (IPCC): Geneva, Switzerland, 2015; ISBN 978-92-9169-142-5.
3. IEA. *Energy Efficiency 2017—Market Reports Series*; OECD/IEA: Paris, France, 2017.
4. 2020 Climate & Energy Package. Available online: [https://ec.europa.eu/clima/policies/strategies/2020\\_en](https://ec.europa.eu/clima/policies/strategies/2020_en) (accessed on 28 January 2019).
5. Climate and Energy Framework. Available online: <https://www.consilium.europa.eu/en/policies/climate-change/2030-climate-and-energy-framework/> (accessed on 28 January 2019).
6. Gul, M.; Patidar, S. Understanding the energy consumption and occupancy of a multi-purpose academic building. *Energy Build.* **2015**, *87*, 155–165. [[CrossRef](#)]
7. Santos, C.P. Reabilitação de edifícios para promoção do conforto e da eficiência energética. In Proceedings of the 1st Net-Zero Energy Buildings Conference LNEG, Lisboa, Portugal, 13 March 2012. (In Portuguese)
8. EES. *Energy Standards and Labelling Programs Throughout the World in 2013*; Energy Efficiency Strategies and Maia Consulting for the Australian Department of Energy: Victoria, BC, Canada, 2014.
9. ADENE. *Manual da Etiqueta Energética*; ADENE: Lisboa, Portugal, 2017; ISBN 978-972-8646-36-3.
10. DGEG. *Eficiência Energética em Edifícios—Programa E4*; Direção Geral de Energia e Geologia: Lisboa, Portugal, 2002.
11. Wong, L.; Krüger, E. Comparing energy efficiency labelling systems in the EU and Brazil: Implications, challenges, barriers and opportunities. *Energy Policy* **2017**, *109*, 310–323. [[CrossRef](#)]
12. Fell, M. Energy services: A conceptual review. *Energy Res. Soc. Sci.* **2017**, *27*, 129–140. [[CrossRef](#)]
13. Hoxha, E.; Jusselme, T. On the necessity of improving the environmental impacts of furniture and appliances in net-zero energy buildings. *Sci. Total Environ.* **2017**, *596–597*, 405–416. [[CrossRef](#)] [[PubMed](#)]
14. Ting, T.O.; Rao, M.V.; Loo, K.C. A novel approach for unit commitment problem via an effective hybrid particle swarm optimization. *IEEE Trans. Power Syst.* **2006**, *21*, 411–418. [[CrossRef](#)]
15. Ko, M.J.; Kim, Y.S.; Chung, M.H.; Jeon, H.C. Multi-objective design for a hybrid energy system using genetic algorithm. *Energies* **2015**, *8*, 2924–2949. [[CrossRef](#)]
16. Randall, M.; Rawlins, T.; Lewis, A.; Kipouros, T. Performance Comparison of Evolutionary Algorithms for Airfoil Design. *Procedia Comput. Sci.* **2015**, *51*, 2267–2276. [[CrossRef](#)]
17. Goldberg, D. *Genetic Algorithms in Search Optimization and Machine Learning*; Addison Wesley: Boston, MA, USA, 1989.
18. Chuah, J.W.; Raghunathan, A.; Jha, N.K. ROBESim: A retrofit-oriented building energy simulator based on EnergyPlus. *Energy Build.* **2013**, *66*, 88–103. [[CrossRef](#)]
19. Pombo, O.; Allacker, K.; Rivela, B.; Neila, J. Sustainability assessment of energy saving measures: A multi-criteria approach for residential buildings retrofitting—a case study of the Spanish housing stock. *Energy Build.* **2016**, *116*, 384–394. [[CrossRef](#)]
20. Santos, R.; Abreu, A.; Matias, J.C.O. Energy Efficiency in buildings by using evolutionary algorithms: An approach to provide efficiency choices to the consumer, considering the rebound effect. In Proceedings of the Technological Innovation for Resilient Systems: 9th IFIP WG 5.5/SOCOLNET Advanced Doctoral Conference on Computing, Electrical and Industrial Systems, DoCEIS 2018, Costa de Caparica, Portugal, 2–4 May 2018; Springer: Basel, Switzerland, 2018; ISBN 978-3-319-78574-5.
21. Asadi, E.; Silva, M.G.; Antunes, C.H.; Dias, L. Multi-objective optimization for building retrofit strategies: A model and an application. *Energy Build.* **2012**, *44*, 81–87. [[CrossRef](#)]
22. Caccavelli, D.; Gugerli, H.T. A European diagnosis and decision-making tool for office building upgrading. *Energy Build.* **2002**, *34*, 113–119. [[CrossRef](#)]
23. Kaklauskas, A.; Zavadskas, E.K.; Raslanas, S. Multivariate design and multiple criteria analysis of building refurbishments. *Energy Build.* **2005**, *37*, 361–372. [[CrossRef](#)]
24. Jafari, A.; Valentin, V. An optimization framework for building energy retrofits decision-making. *Build. Environ.* **2017**, *115*, 118–129. [[CrossRef](#)]
25. Mauro, G.M.; Hamdy, M.; Vanoli, G.P.; Bianco, N.; Hensen, J.L.M. A new methodology for investigating the cost-optimality of energy retrofitting a building category. *Energy Build.* **2015**, *107*, 456–478. [[CrossRef](#)]
26. Heo, Y.; Augenbroe, G.; Graziano, D.; Muehleisen, R.T.; Guzowski, L. Scalable methodology for large scale building energy improvement: Relevance of calibration in model-based retrofit analysis. *Build. Environ.* **2015**, *87*, 342–350. [[CrossRef](#)]

27. Santos, R.S.; Matias, J.C.O.; Abreu, A.; Reis, F. Evolutionary algorithms on reducing energy consumption in buildings: An approach to provide smart and efficiency choices, considering the rebound effect. *Comput. Ind. Eng.* **2018**, *126*, 729–755. [[CrossRef](#)]
28. Deb, K.; Pratab, S.; Agarwal, S.; Meyarivan, T. A Fast and Elitist Multiobjective Genetic Algorithm: NSGA-II. *IEEE Trans. Evolut. Comput.* **2002**, *6*, 182–197. [[CrossRef](#)]



© 2019 by the authors. Licensee MDPI, Basel, Switzerland. This article is an open access article distributed under the terms and conditions of the Creative Commons Attribution (CC BY) license (<http://creativecommons.org/licenses/by/4.0/>).

Article

# The Application of Material Flow Cost Accounting in Waste Reduction

Shaio Yan Huang <sup>1</sup>, An An Chiu <sup>2</sup>, Po Chi Chao <sup>1,\*</sup> and Ni Wang <sup>1</sup>

<sup>1</sup> Department of Accounting and Information Technology, National Chung Cheng University, No.168, Sec. 1, University Rd., Minhsiung, Chiayi 62102, Taiwan; actsyh@ccu.edu.tw (S.Y.H.); s04527017@ccu.edu.tw (N.W.)

<sup>2</sup> Department of International Business, Feng Chia University, No. 100, Wenhwa Rd., Seatwen, Taichung 40724, Taiwan; aachiu@fcuoa.fcu.edu.tw

\* Correspondence: d05526001@ccu.edu.tw; Tel.: +886-9-3714-6164

Received: 22 December 2018; Accepted: 22 February 2019; Published: 27 February 2019

**Abstract:** Due to the rise in environmental awareness, corporate companies have shifted their focus from an obsession with short-term profits to contemplating long-term strategies to achieve sustainable management. Effective use of resources is the primary indicator of this achievement. Fulfillment of corporate social responsibility and thinking beyond the regulatory aspects of corporate sustainable management are goals that have continually attracted attention worldwide. Material flow cost accounting based on ISO 14051, which was announced by the International Organization for Standardization (ISO), is a tool that can be used to achieve a balance between the environment and economy. We focused on using ISO 14051-based material flow cost accounting as an analytical evaluation tool from the perspectives of finance and accounting personnel. We conducted a case study on a flat-panel parts supplier to determine whether the efficient use of recycled glass could reduce company costs. The primary finding is that the film layer on recycled washed glass tends to be stripped during the production process, causing increased reprocessing costs and thus rendering the cost of renewable cleaning higher than that of reworking. This study revealed that the ISO 14051-based material flow cost accounting analysis constitutes a valuable management tool, thereby facilitating the promotion of sustainable development.

**Keywords:** sustainability; ISO14051; material flow cost accounting

## 1. Introduction

The rapid industry development, the depletion of natural resources, and the rise in environmental awareness have led corporate companies to shift their attentions from short-term profits to long-term strategies to achieve sustainable management and smooth progress into a new era. The World Commission on Environment and Development established sustainable development policies for future environmental and economic development, defining sustainability as a development model that meets the needs of contemporary people and protects the environment without comprising future competition. Sustainability indicators are a suitable means for assessing the development of production technologies and integration of business decisions [1]. Achieving an acceptable environmental performance has become a universal commitment for all organizations to maintain competitiveness. Environmental accounting (or green accounting) is an environmental analytical tool that measures and communicates the costs and benefits of the overall economic effects [2,3]. It is a process that involves collecting material-volume and cost information to identify the costs incurred by corporate companies in the pollution emission, waste treatment, and environmental protection. Currently, environmental accounting has garnered international attention and the disclosure of corporate environmental information is actively encouraged while theoretical frameworks and practical guidelines are gradually developed. Environmental cost and ecological balance remain a topic of intense discussion in the

field of environmental accounting. In 2007, the Environmental Protection Administration of Taiwan formulated a set of environmental-accounting guidelines, which are currently commonly adopted by Taiwanese corporations as the foundation for environmental-accounting practices.

Taiwan has a serious environmental pollution problem, such as air pollution caused by the power plants and pollution of water sources, which has a significant impact on the society, people, and enterprises. Even though many SMEs have environmental awareness, they do not have the knowledge required and/or the skills needed to apply the appropriate environmental tools [4,5]. One study indicated that the eco-efficient optimization of material flow cost management, which aims to reduce costs while simultaneously decreasing environmental influence, has become an explicit objective of practical and scientific activities and efforts. Although discussions have been frequent, little has actually been done to realize these goals [6]. Even in Germany and Japan, numerous companies remain ill-informed regarding the MFCA process and few have fully incorporated this practice into their operations [7]. However, Schaltegger et al. [8] used tools for sustainability management to examine large German companies and reported that more well-known environmental accounting tools are more likely to be implemented. Therefore, communication channels and publicity regarding the release of the ISO 14051: Material flow cost-accounting standard are crucial [7].

To standardize MFCA practices, a working group of the ISO Technical Committee ISO/ TC 207, Environmental Management, developed ISO 14051, which complements the ISO 14000 family of environmental management system standards, including life cycle assessment (ISO 14040, ISO 14044) and environmental performance evaluation (ISO 14031). The standard was published in the second half of 2011. Material flow cost accounting (MFCA) based on ISO 14051 is an environmental-management accounting (EMA) tool providing the analysis of environmental and economic balance [3]. ISO 14051 provides a general framework for material flow cost accounting. The ultimate goal of MFCA is to mitigate environmental problems and simultaneously improve the economic performance [9]. The concept of MFCA has been successfully applied in numerous industrial practices to improve waste-reduction decisions, such as in brewing companies in South Africa [3], small textile factories in Thailand [10], pharmaceutical companies in Japan [9], and small- and medium-sized enterprises in Malaysia [11]. These cases indicate that MFCA increases environmental sustainability and improves the overall economic performance of a company.

The purpose of this study is to use case companies to prove whether the introduction of MFCA management tools can be successfully promoted only by referring to the ISO14501 manual. In addition, by using the financial and cost data provided by the case company, this study explores whether the MFCA analysis tool is a set of stability tools, and whether it is possible to produce different results because of the different managers of operation analysis tools.

The case company is the first company in Taiwan fully implementing MFCA. The reason why the case company takes the lead to implement MFCA is to reduce the waste and pollution, which can assist the case company in reaching sustainability. Other companies in Taiwan only implement the MFCA in one factory or one product line, which makes it difficult to know the real effects of the implementation. Thus, understanding the implementation process and steps of the case company can provide suggestions to other companies.

The analysis of the case company's implementation of MFCA revealed that the film layer on recycled washed glass tends to be stripped during the production process, causing increased reprocessing costs that result in the cost of renewable cleaning being higher than that of using new materials. Because remanufacturing requires that used products serve as inputs, the success of remanufacturing depends on the efficiency with which used products are collected [12]. The present study does not focus on the process of collecting used products, which is a topic that can be addressed by manufacturers, retailers, or third parties in future studies. Despite uncertainty regarding whether the efficient use of recycled glass can reduce company costs and environmental loads, the case company can determine whether recycling is beneficial by evaluating the benefits of outsourcing recycled materials following an analysis of ISO 14051-based MFCA. This study analyzes Taiwan CFI Company,

the first company to receive ISO 14051 MFCA certification in Taiwan, which is recommended to get the business environmental protection award. The case company can be the role model of promoting business sustainability. The experience of applying MFCA can be the guidelines of the business in manufacturing and service industries, which are devoted to improving the sustainable environment and lowering the costs.

Studies on MFCA in Taiwan have primarily been based on environmental-management or industry cases. However, the basic information required for MFCA analysis is obtainable from the original cost-management accounting process. For the purpose of increasing the corporate resource efficiency and using natural resources more effectively and sustainably [13], analysis with MFCA is highly reasonable as the most prospective [14] and the only international standardized method [15]. Therefore, a cost-management accounting perspective was adopted, and a flat-panel parts supplier that had obtained ISO 14051-based MFCA certification served as a case in this study to describe implementation and teardown analysis methods, as well as investigate implementation results. Through this research, we hope to introduce a method as revolutionary as MFCA and help manufacturing companies to evolve in a changing environment and economy, overcome environmental damage inflicted by companies in a low-profit seeking era, and achieve mutual benefits for both the company and the environment. We expect that an analysis of ISO 14051-based MFCA will enable companies to consider all facets of MFCA and thereby become a valuable management tool that links companies to the environment and economy, as well as facilitates the promotion of sustainable development. The hypothesis of the research is whether the application of ISO 14051-based MFCA can assist the case company to analyze the cost, which helps manufacturing companies to evolve in a changing environment and economy.

The rest of this paper is organized as follows. In Section 2, we provide the review of the related literature. In Section 3, we give the background introduction and case analysis. Lastly, the final conclusions and recommendations are presented.

## **2. Literature Review**

### *2.1. Material Flow Management*

Adopting sustainable development while also retaining business competitiveness is a common goal in corporate communities. Because of this trend, a goal-oriented innovative management method is necessary for economic optimization and the reduction of material-related environmental pollution. Wagner and Enzler [6] explained that material flow management, which contributes to full utilization of the potential sustainable management of a company, provides a new framework for economic research and initiates standardization processes for sustainable management. Because material flow and its effects are direct causes of ecological problems, material flow management can be used to directly address the root of a problem and facilitate the reduction in the environmental pollution, which also leads to cost reduction [16].

Material flow management is focused on optimizing systems rather than a single product or material and is primarily characterized by interdisciplinarity and networking on the basis of a normative orientation [6]. The initial step of material flow management is goal setting. Because material flow management is a component of a superordinate management concept, the goals of material flow management arise from the normative and strategic goals of the company. In fact, the environmental-management tool with life-cycle-assessment orientation is designed to reveal the life-cycle-related effects of products and services on the natural environment. This approach helps to reduce environmental damage, but does not provide clear contributions to cost savings or corporate profits [16]. Traditional cost-accounting methods in the evaluation of material flow processes neglect the complexity of material and energy flow [16]. Environmental-management accounting has expanded rapidly, and MFCA has become one of the most promising environmental-management accounting tools [17].



MFCA is an environmental-management accounting practice proposed by Professor Wagner from the Institut für Management und Umwelt in Augsburg. MFCA aims to reduce material input through analysis. All input materials equal the amount of finished goods (positive products) plus that of generated waste (negative products). This equation represents the identification of material balance. When the number of positive products is constant, the number of negative products decreases, which reduces the environmental effect and amount of waste produced.

Environmental protection is critical for sustainability. Continuous investments in energy consumption and natural resource consumption, as well as manufacturing sectors and infrastructure, have had seriously harmful impacts on the environment [18]. Environmental accounting creates accountability for business entities in terms of their efforts to protect the environment in their corporate decisions [19]. Environmental accounting constitutes a tool for applying the sustainable development concept and now commands acceptance as a means of ensuring the preservation of the environment. Environmental accounting information includes financial, environmental performance, and policy aspects, which are scattered in many parts of annual reports and social responsibility reports. The quality of disclosures can be characterized from aspects of comprehensiveness, reliability, and compliance (Masud, Bae, & Kim, 2017). In decision making, an organization considers different pressures from internal and external parties and attempts to legitimize the impact of its activities on the environment in the eyes of society and various pressure groups. Environmental accounting plays an active role in preparing, presenting, and analyzing environmental information for interested party holders, thus encouraging top management to improve environmental conditions [19].

## *2.2. Material Flow Cost Accounting*

MFCA aims to reduce the material input through the analysis. All input materials equal the amount of finished goods (positive products) plus that of generated waste (negative products). This equation represents the identification of material balance. When the number of positive products is constant, the number of negative products decreases, which reduces the environmental effects and amount of waste produced. Nakajima [20] indicated that the production process in traditional cost accounting is a consumption process of economic value in which the added value of a product is valued, and the consumption in an official production process is regarded as cost accounting. All monetary values of inputted resources are calculated in the production cost of a product as the output of the corresponding production process, meaning that a product should be burdened with all of the costs of utilized resources. Additionally, waste is not recognized in traditional cost accounting because it is considered to be unrelated to a value chain of various inputted resources (monetary value and physical volume), which are completely separated from production processes. By contrast, in MFCA analysis, wastes are not regarded as a process of value addition. Unlike traditional cost accounting, MFCA aims to recover the value of a product in a production process by equally valuing all of the outputs from a production process [20].

When using traditional cost-accounting methods, management authorities are mostly focused on the costs of manufacturing a product, which cover all of the costs incurred during the production process, including direct materials, labor, and production overheads. All of the costs incurred when manufacturing a product comprise the cost of the product. Irrespective of the amount of losses generated in an output process, the cost of losses is still allocated to the product cost.

In MFCA, quantity of input refers to the actual quantity of input remaining in the final product. Input in MFCA differs from input in a manufacturing and production process in that the quantity of input in the final product is the actual amount of input required to produce 100% yield without taking yield into consideration. Yield is generally considered in the production process, producing a standard value, which represents a standard dosage that is considered to be the target value. At the beginning of the production process, the quantity of allowable losses in management is considered in addition to yield, and yield plus the quantity of allowable losses leads to the development of an

ideal standard. The difference between a realistic standard and ideal standard is the loss examined in MFCA; accordingly, the hidden value in this loss can be identified.

In MFCA, waste is considered to be negative products. The main consequence of this assumption is that the manufacturing cost is used to produce not only the required products, but also the undesired negative products (waste). Thus, waste is considered to bear part of the processing cost of all upstream processing steps. Conventional cost-accounting practices typically overlook significant costs incurred by waste; therefore, the cost incurred by waste is known as the hidden cost. To reduce this cost and thereby improve the economic performance, waste recovery is an essential strategy for manufacturing companies [21].

Numerous studies worldwide have identified the advantages of MFCA. Several studies have identified the advantages of MFCA. Based on a case study of a Sri Lankan crepe rubber factory, Dunuwila et al. [22] adopted a cost-efficient and eco-friendly approach to improve the processing sector for natural rubber in the following three phases: 1. Quantifying factory resource use, economic loss, and greenhouse gas emissions through material flow analysis, MFCA, and life-cycle assessment; 2. developing proposals for viable improvement options; and 3. confirming the benefits of implementing the suggested improvement options. The results indicated that the proposed methods enabled 26% and 79% decreases in cost and global warming potential, respectively. Provided that the improvement options are viable, the results published by Dunuwila et al. [22] can be used to ultimately increase profits for the rubber company, reduce the amount of toxic gas released into the atmosphere, reduce water consumption, and enhance the company image.

Nitto is a leading Japanese diversified materials manufacturer that offers a wide variety of products, including tapes, vinyl, LCDs, insulation, and reverse osmosis membranes. With the support of the Japanese Ministry of Economy, Nitto was the first model company to use MFCA. Before introducing MFCA, Nitto had long been committed to enhancing the efficiency and mitigating the environmental effects of its operations. Nitto discovered that its environmental-accounting system was incomplete, primarily because only environmental protection costs were considered, and a few costs associated with environmental effects were still hidden. The environmental protection costs incurred through conventional environmental accounting only represented 1.6% of total sales in 2005. However, other costs, such as energy-consumption costs related to environmental effects, are usually regarded as production costs, which accounted for approximately 13.6% of total sales, substantially higher than that for environmental protection costs (1.6%). During the process of target-product selection, Nitto focused on a product that exhibited an upward market trend and had production lines that generated a considerable amount of material loss and consumed a substantial amount of energy during the manufacturing process. Through MFCA, Nitto could accurately assess its material losses and associated costs. This information became a driving force for Nitto to improve the material productivity of this production line. Hence, the implementation team established its improvement plans on the basis of a cost-benefit analysis using the physical and cost data under MFCA. The plans and countermeasures were subsequently planned and implemented. Nitto recognized MFCA as a method that was helpful for clarifying losses in terms of cost, enabled managers to set explicit improvement goals, and provided a means for identifying potential cost reductions and positive effects on the environment. Using a professional management method such as MFCA ensured increased competitiveness for achieving the goal of a sustainable operation (Manual on Material Flow Cost Accounting ISO14051, 2014).

Kokubu and Kitada [17] indicated that intensely competitive Japanese companies have identified further room for improvement by using MFCA because the loss concept in MFCA is different from the general concept of compliance in traditional business management. The value of MFCA-derived information is attributed to this concept of difference in loss.

Kokubu and Kitada [17] examined three cases of companies that had applied MFCA in the EMA trial of the Japanese METI and investigated how the case companies used MFCA to introduce countermeasures to solve problems. The findings demonstrated that applying MFCA and DOE

increased product quality and reduced the adverse environmental effects of the production process of the case-study company, thereby reducing the cost and strengthening competitiveness. Kokubu and Kitada [17] investigated how the case companies used MFCA to introduce countermeasures to solve problems. The first case study indicated that Tanabe Seiyaku introduced MFCA as a trial in 2001. Although most Japanese companies still use Microsoft Excel for MFCA calculations, Tanabe Seiyaku has already combined the enterprise resource planning system for the entire company with MFCA [23]. Through the integration of MFCA data, information on improvement activities is shared across the entire company. The second case is Canon Inc., one of the leading precise machine companies in Japan. The company introduced MFCA as a trial from 2001 to 2002, after which time Canon successively introduced MFCA at individual manufacturing plants on the basis of cooperation between the environmental department and plants. In a report on sustainable development, Canon also mentioned that through its workplace-centered environmental assurance system using MFCA, it is committed to reducing waste and cost. The last case study focused on Sekisui Chemical Co. Ltd., which introduced MFCA in 2004 and indicated that through MFCA activities, the company continues to lower and stabilize costs, verifying that from a business perspective, using an innovative MFCA management system is conducive to the development of manufacturing industries.

Chompu-inwai et al. [24] conducted a case study on a wood-product manufacturer in northern Thailand. An analysis of the company's production process revealed that almost 70% of the raw wood materials used were waste in the form of chippings, sawdust, off-cuts, and defects. The objective of the study was to discuss whether the application of MFCA can reduce material consumption and waste to the maximum extent. The results of their experiment were subsequently integrated into practical applications, reducing the amount of wood material loss incurred during the cutting process from approximately 69% to 54%. The findings demonstrated that applying MFCA increased product quality and reduced the adverse environmental effects of the production process of the case-study company, thereby reducing the cost and strengthening competitiveness.

In response to the rising cost of raw materials obtained from the natural environment, consistently high production costs, and the inevitable imposition of carbon or energy taxes by environmental agencies, the China Steel Corporation installed MFCA integrated with functions for managing resources, the environment, and waste. Findings obtained using this tool can serve as a basis for determining improvement options and provide clear insight into which types of cost and expenditure are the sources of maximum loss. Furthermore, these results reveal the flow and proportion of iron resources from the main products, recycling and reuse within plants, and waste gases to facilitate the formulation of improvement options.

One key difference is how you recognize the cost MFCA represents as a different way of management accounting. In conventional cost accounting, the data is used to determine whether the incurred costs are recovered from sales. It does not require determining whether material is transformed into products or disposed as waste. In conventional accounting, even if waste is recognized in terms of quantity, the costs to produce 'material losses' are included as part of the total output cost. On the other hand, MFCA, as explained before, focuses on identifying and differentiating between the costs associated with 'products' and 'material losses'.

In this way, 'material loss' is evaluated as an economic loss, which encourages the management to search for ways to reduce material losses and improve business efficiency. The figure below shows the difference between MFCA and Conventional Accounting. MFCA is the cost accounting system that can be installed in the ERP system. Therefore, there is no system integration issue of the MFCA system.

The aforementioned studies present cases of successful MFCA implementation. Thus, through the promotion of ISO 14051-based MFCA analysis, this study constructed a material flow model to determine the potential environmental and financial consequences of raw material and energy use and manufacturing processes. Other aims were to increase the transparency of material and energy use and manufacturing processes, as well as to highlight the loss of raw material input and waste-treatment cost that have always been neglected. Creating a management mechanism can effectively strengthen green

designs and enhance the research and development of clean processes, while also identifying methods for mitigating environmental effects and reducing costs, with the hope of achieving the optimal balance between the promotion of environmental conservation and economic growth. In traditional cost accounting, the cost of finished goods increases with the number of steps in the production process, and this cost increases incrementally. The physical volume of materials does not necessarily accumulate with the number of steps in a production process because they may be cut and lost during manufacturing, thereby generating enough waste whose quantities plus the final output equal the total physical volume of materials inputted.

In traditional cost accounting, the basic calculation model involves allocating manufacturing costs to various products. Therefore, the value of wastes generated during the production process in most companies is “zero.” Generally, little analysis is performed on waste, except for the waste management cost recognized in environmental accounting. The basic calculation model in MFCA involves using the same approach to allocate the manufacturing costs of finished goods (positive products) and waste (negative products) generated during the production process. Thus, the true value of generated waste (negative products) can be calculated, and a hotspot for improvement can be identified from this originally zero-value waste (negative products).

### 2.3. ISO 14051 Based MFCA

ISO 14051 defines MFCA as a “tool for quantifying the flows and stocks of materials in processes or production lines in both physical and monetary units” where ‘materials’ include energy and water [14]. These flows and stocks of materials are important because they pervade business practice [25]. The aim of MFCA is to provide information to management about opportunities for reducing material use and improving the monetary performance of businesses at the same time, representing an irresistible opportunity.

To facilitate implementation, ISO 14051 proposes several MFCA implementation steps, as delineated below. The level of detail and complexity of the analysis will depend on the size of the organization, nature of the organization’s activities and products, number of processes, and quantity centers chosen for analysis, among other factors. These conditions make MFCA a flexible tool that can be applied in a wide range of organizations.

#### 2.3.1. Implementation Step 1: Engaging Management and Determining Roles and Responsibilities (Clause 6.2, 6.3, ISO 14051:2011)

Successful projects usually start with support from the company’s management; MFCA is not an exception. If the company management understands the benefits of MFCA and its usefulness in achieving an organization’s environmental and financial targets, it is easier to gain commitment from the whole organization. In order to be effectively implemented, it is highly recommended that top management take the lead in MFCA implementation by assigning roles and responsibilities, including setting up an MFCA project implementation team, providing resources, monitoring progress, reviewing results, and deciding on improvement measures based on the MFCA results.

In general terms, management should be engaged in all phases of MFCA implementation and it is recommended that MFCA projects start with aggressive support from management, followed by a bottom-up approach on-site. In addition, successful implementation of MFCA requires collaboration between different departments within the organization. The reason why collaboration is needed is because different sources of information are required to complete MFCA analysis. Through engagement of the company management in the MFCA implementation process, the required expertise can be determined and the correct flow of information between all areas involved can be facilitated.

### 2.3.2. Implementation Step 2: Scope and Boundary of The Process and Establishing A Material Flow Model (Clauses 6.4, 6.5, ISO 14051:2011)

Based on collected material flow data, the MFCA boundary needs to be specified to clearly understand the scale of MFCA activity. During implementation, it is usually recommended that there is a focus on specific products or processes at the beginning, before then expanding implementation to other products. By implementing MFCA in steps, the analysis is simplified and better results can be achieved.

The boundary can be limited to a single process, multiple processes, an entire facility, or a supply chain. It is recommended that the process or processes that are chosen for initial implementation be the ones with potentially significant environmental and economic impacts. After specifying the boundary, the process should be classified in quantity centers using process information and procurement records. In MFCA, the quantity center is the part of the process in which inputs and outputs are quantified. In most cases, quantity centers represent parts of the process in which materials are transformed. If the material flow between two processes is the source of significant material loss, the flow can be classified as a separate material flow.

After determining the boundary and quantity centers, a time period for MFCA data collection needs to be specified. While MFCA does not indicate the period during which data must be collected for analysis, it should be sufficiently long to allow meaningful data to be collected and to minimize the impact of any significant process variation that can affect the reliability and usability of the data, such as seasonal fluctuations. Several historical MFCA projects indicate that the appropriate data collection period can be as short as a month, with a half-year or a year of data collection being the most common.

### 2.3.3. Implementation Step 3: Cost Allocation (Clauses 5.3, 6.8, ISO 14051:2011)

MFCA divides costs into the following categories:

- Material cost: cost for a substance that enters and/or leaves a quantity center;
- Energy cost: cost for electricity, fuel, steam, heat, and compressed air;
- System cost: Cost of labor, cost of depreciation and maintenance, and cost of transport;
- Waste management cost: cost of handling waste generated in a quantity center.

Material costs, energy costs, and system costs are assigned or allocated to either products or material losses at each quantity center based on the proportion of the material input that flows into the product and material loss. The material costs for each input and output flow are quantified by multiplying the physical amount of the material flow by the unit cost of the material over the time period chosen for the analysis. When quantifying the material costs for products and material losses, the material costs associated with any changes in material inventory within the quantity center should also be quantified. In contrast to material, energy, and system costs that are assigned to products and material losses proportionally, 100% of the waste management costs are attributed to material loss, since the costs represent the costs of managing this material loss.

### 2.3.4. Implementation Step 4: Interpreting and Communication MFCA Results (Clauses 6.9, 6.10, ISO 14051:2011)

MFCA implementation provides information such as material loss throughout the process, the use of materials that do not become products, overall costs, and energy and system costs associated with the material loss. This information brings about multiple impacts by increasing the awareness of the company's operations. Managers who are aware of the costs associated with material losses can then identify opportunities to increase efficiency in material use and improve business performance.

### 2.3.5. Implementation Step 5: Improving Production Practices and Reducing Material Loss through MFCA Results (Clause 6.11, ISO 14051:2011)

Once MFCA analysis has assisted an organization to understand the magnitude, consequences, and drivers of material use and loss, the organization may review the MFCA data and seek opportunities to improve the environmental and financial performance. The measures taken to achieve these improvements can include the substitution of materials; modification of processes, production lines, or products; and intensified research and development activities related to material and energy efficiency.

### 3. Research Method

This research adopted the case-study method using a flat-panel parts supplier as an example to analyze the implementation of ISO 14051-based MFCA by the case company and investigate the results. This method is most commonly used in exploratory research for which the relevant qualitative research techniques are convenient [26]. The case study method can disclose the problem and then systematically collect and analyze the problem in a scientific way to find the solution [27]. The importance of this case study is that the process of applying MFCA can provide suggestions for the future installation of MFCA. For example, the setting of the quantity center should be the same as the existing data record and periodic review framework to avoid ineffective use. Second, the historical data should be saved in the operating system, and the material flow currency should be quantitatively linked to the accounting, and the existing management system of each departments should be comprehensively integrated to facilitate the rapid introduction of the product. The analysis of material flow and energy use helps the company understand the relationship between material usage and cost, identify the hot spots of material and cost loss, improve the efficiency of data analysis, and systematically review the process to promote and strengthen the environmental cost management.

However, this is confidential financial and cost information within the company. Different companies have different cost data due to different processes and information system construction. In the absence of database or cross-company consistency data, we use case studies to conduct empirical analysis. Some management accounting-related research [28–30] uses case studies for the empirical analysis due to the lack of public information.

Although the case-study method provides a comprehensive understanding of a situation and causal relationships, it is still overly subjective and lacks objectivity. Thus, in our case analysis, we first described the implementation manuals adopted in Taiwan Industrial Development Bureau, Ministry of Economic Affairs, and then analyzed the case company by following the implementation methods specified by the manual to circumvent the effects of subjectivity on this research.

The financial information of the case company T is collected from the database of the Company T. The production process and cost structure are summarized from the database of company T. According to Clause 6.2, 6.3, ISO 14051:2011, successful projects usually start with the support of the company's management. MFCA is not an exception. Through engagement of the company management in the MFCA implementation process, the required expertise can be determined and the correct flow of information between all areas involved can be facilitated. Therefore, we also conducted in-depth interviews with the production manager, accounting manager, and other internal personnel to further understand the flow of the company's existing product line and cost structure. We interviewed five employees, including one production manager, one account manager, and three internal members of staff to increase the integrity of data collection through a discussion and observation of visits.

To facilitate implementation, ISO 14051 proposes five MFCA implementation steps, as delineated in the literature review section, which are listed in Section 2.3.

## **4. Case Analysis**

### *4.1. Company Profile*

The case discussed in the study is a Japanese company in Taiwan (hereafter referred to as “Company T”). Company T, established in 2001 with a capital of NT\$15.3 billion, was a professional manufacturer and supplier of color filters and strategically collaborated with Company A in 2006. The plant consisted of two buildings, one of which specialized in the production of generation 4.5 and 5 color filters and the other of which produced generation 6 color filters. Company T was highly automated in that its equipment-production information was linked by the manufacturing execution system, which is managed by its industrial engineering department, to the ORACLE-ERP system (hereafter referred to as the “ERP system”). The company adopted the standard costing system as the cost-accounting method.

### *4.2. Decision for Implementing MFCA*

As it strove to achieve sustainable development, Company T received the ISO14001 environmental-management system, ISO14064 greenhouse gas verification, carbon footprint and water footprint, and the ISO50001 energy management system certification before introducing the MFA system. To elucidate the environmental effects of its raw material and energy practices, Company T promoted the ISO14051-based MFCA in 2013, which could not only be used to comprehensively examine the transparency of the company regarding raw materials and energy use, but also to minimize its environmental effects while also reducing the costs incurred by losses. Ultimately, the company aimed to fulfill its social responsibilities in a low-interest-rate environment. Regarding research methods, we described the standard operating procedures for introducing MFCA analysis by using the “Introductory Manual for Industry Implementation of Material Flow Cost Accounting” from the Taiwan Ministry of Economic Affairs and the “Material Flow Cost Accounting Introduction.

### *4.3. The Initial Stage of Establishing a Project Group*

While companies implement MFCA-based projects, companies often struggle with implementing the project and managing costs. To effectively implement MFCA, the collective participation of professionals among departments is necessary because the integration of the information for cross departments is crucial. For example, acquiring supervisory supports from the finance department and plant affairs department is greatly beneficial while implementing the MFCA. Establishing a project group is key in the initial stage of implementation. Project members include personnel from environmental safety, manufacturing, technical, plant affairs, and finance departments. The responsibilities of each department are as follows:

1. Finance department integrates the construction and cost information to construct a material flow model, compile reports, and document findings for future reference. It also provides valuable assistance in the implementation process, from preliminary planning to the compilation of an MFCA balance sheet. In the preparatory stage of MFCA implementation, a scope and time period must first be specified;
2. Environmental-safety department provides the information regarding the environmental effects of wastes, including types of the waste and waste-treatment activities;
3. Plant affairs department identifies types and methods of the energy application and quantifies the consumption of the energy, including the energy loss in each quantity center (QC);
4. Manufacturing and technical department analyzes the material balance in a material flow model and assists in providing the missing information.



#### 4.4. Scope Specification

The key to successful MFCA implementation is to select the product or production line and time period in accordance with the following characteristics:

1. Product with the highest unit price;
2. Product or production line associated with the maximum material input;
3. Product or production line associated with the maximum energy consumption;
4. The simplest product variety;
5. Production line with a discernible scope;
6. Process that easily generates wastes.

#### 4.5. Quantity Center Selection

A quantity center is a basic unit of MFCA calculation. Theoretically, MFCA is used to define the quantity center as work sections that generate loss during the process. The scope of the quantity center includes facilitating the collection and calculation of relevant data, but may lose its focus in practice when differentiating among the types and losses of negative product costs as a result of excessive variety. Conversely, a small scope for a quantity center may result in overly detailed and complex MFCA calculations, which impede and prolong the process of data collection and organization. Company T selected quantity centers according to their most detailed work sections.

#### 4.6. Cost Classification in MFCA

MFCA is particularly effective for improving resource efficiency because it increases transparency through the visualization of material flow, relevant costs, and internal environmental effects [31]. Strobel and Redmann [32] indicated that four types of cost are classified under the concept of MFCA. The cost classification of Company T is described as follows:

##### 1. Material Cost:

- (1) Direct materials: Direct materials refer to materials inputted at the beginning of the process and remain in the final product. The direct materials of Company T include glass, BM resist, R resist, G resist, and B resist;
- (2) Indirect and auxiliary materials: Indirect materials are added during an intermediary process. Auxiliary materials, such as detergents and solvents, are not directly required for manufacturing products, but are essential to the process. Auxiliary materials vary in type and account for less than 10% of the total cost. We therefore eliminated auxiliary materials in the current analysis.

##### 2. Energy Cost (Water & Electricity cost):

The energy cost of Company T primarily consisted of water and electricity costs. Because the company had acquired Carbon Footprint, Water Footprint, and ISO50001 Energy management system certifications prior to introducing MFCA, it had implemented water-recycling measures and electricity-meter controls, which simplified the process of obtaining data on each quantity center. Water cost was based on the amount paid to the Taiwan Water Corporation, and electricity cost was based on the amount paid to Taiwan Power Company.

##### 3. System Cost:

Other costs not related to materials, energy, and waste treatment were categorized as system costs. Depending on how Company T classifies its accounts, system costs include labor costs, repairs, depreciation expenses, rentals, tax, packaging fees, insurance premiums, and the cost of photomasks.



#### 4. Waste-Management Cost:

Waste management cost refers to the costs incurred from treating the wastes resulting from manufacturing and production processes, including the costs and fees associated with air emissions, wastewater, and solid-waste treatment.

##### 4.7. Specification of a Time Period

The specification of a time period is chiefly based on the period in which data can be easily collected and organized. This study analyzed one-year data to reduce the short-term abnormalities caused by short-term economic recessions. Because the implementation year is 2013, we selected data generated throughout 2012. Figure 1 depicts the time period of work orders specified by Company T.

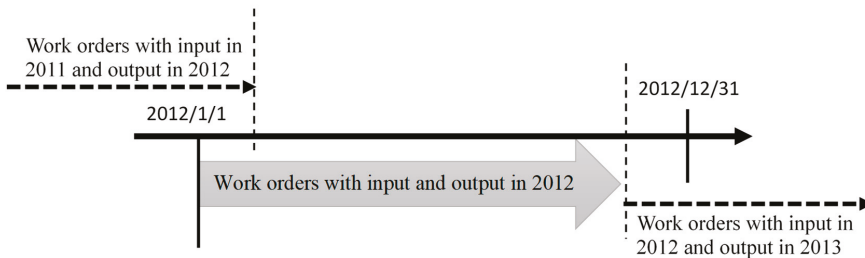

Figure 1. Time period of work orders specified by Company T.

Based on the aforementioned principles, the data of each quantity center were collected and organized as follows.

##### 4.8. Summary of Material Flow

A material flow chart was compiled after the scope of a product or production line had been specified. Cost allocation in each quantity center was necessarily considered when drawing the material flow chart. The costs of each quantity center should not be more than or less than the allocation because over-allocation conceals loss items and under-allocation renders the process of data collection excessively time-consuming. Processes free of waste loss could be combined with other processes.

##### 4.9. Determination of Material Balance

The materials of each quantity center are inputted according to the material flow chart and the output products are classified as either positive or negative products. Table 1 presents the process contents, input, output, and loss items of each quantity center. The input materials of each quantity center include direct materials, indirect materials, and all processed materials in a product. If auxiliary materials are excessively used and incurred wastewater-treatment costs, we advocated the incorporation of these materials in MFCA analysis. By integrating ERP and MFCA systems to obtain the cost of wastes, the management can acquire a material flow model chart (Figure 2) to improve the decisions [3].

Table 1. Description of each quantity center.

QC	Process	Input	Output	Loss
QC1: Unpacked Cleaner	Automated robot arm inputted material into the production line for production	Raw and recycled glass	Raw and recycled glass	Defective raw glass and recycled glass
		Electricity		Electricity
QC2: BM processes	Coat a glass substrate with BM resist and project a photomask pattern onto the glass substrate, which is then exposed to photoresist agent and engraved to form a BM pattern. The primary function of a color filter was to enhance contrast and prevent light leakage and photoelectric flow	Raw and recycled glass	Partly finished BM goods	Defective raw glass and recycled glass
		BM resist		Defective BM resist
				BM resist (switch outlet)
		Auxiliary material		Auxiliary material (including switch to cleaning and repair and maintenance)
		Electricity		Electricity
QC3: RGB processes	Expose R resist to an R-patterned photomask after it has been coated, and then use a developing agent to remove the unexposed part and thereby reveal the R pattern. Oven-dry the R resist to ensure that the pattern is drug resistant, and then repeat this process for the G and B resists. The colors red, green, and blue were separated by a BM. The primary function of the RGB resist was to transform black and white images into color images	Partly finished BM goods	Partly finished RGB goods	Defective raw glass and recycled glass
				Defective BM resist
		R resist		Defective RGB resist
		G resist		R resist (switch outlet)
		B resist		G resist (switch outlet)
				B resist (switch outlet)
		Auxiliary material		Auxiliary material (including switch to cleaning and repair and maintenance)
		Electricity		Electricity
QC4: POL and ITO processes	Grind the coated RGB glass substrate using a polyamide to flatten the photoresist layer. The purpose of the ITO process was to spread a layer of ITO film onto the flattened glass substrate to form a transparent conducting layer.	Partly finished RGB goods	Partly finished ITO goods	Defective raw glass and recycled glass
				Defective BM resist
		ITO target		Defective RGB resist
		Auxiliary material		Defect ITO target
		Electricity		Auxiliary material
QC5: PS processes	Subject the coated PS resist to light exposure, image- developing, and oven-drying to obtain substrate gap control for the required thickness to enhance contrast	Partly finished ITO goods	Partly finished PS goods	Defective raw glass and recycled glass
				Defective BM resist
				Defective RGB resist
				Defective ITO target
				Defective PS resist
		PS resist		PS resist (switch outlet)
		Auxiliary material		Auxiliary material (including switch to cleaning and repair and maintenance)
Electricity		Electricity		
QC 6: Inspection	Manually perform a visual inspection using an inspection machine	Partly finished PS goods	Finished goods	Defective raw glass and recycled glass
				Defective BM resist
				Defective RGB resist
				Defective ITO target
		Defective PS resist		
Auxiliary material		Auxiliary material		
Electricity		Electricity		
QC	Process	Input	Treatment Method	
QC 7: Waste treatment	Because waste at the output end are worthless (e.g., waste gas and wastewater discharge) or not within the scope of analysis (e.g., externally recycled materials), this QC describes input items and treatment methods	Scrapped glass	Outsource glass waste recycling treatment plants	
		Partly finished goods that have been scrapped	Outsource ITO recycling treatment plants and outsource glass waste recycling treatment plants	
		Output from a manufacturing process	Plant air-pollution control treatment, wastewater and recycled water treatment system, outsourced incineration treatment, outsourced recycling treatment, and external wastewater treatment (wastewater control)	

QC: Quantity center.

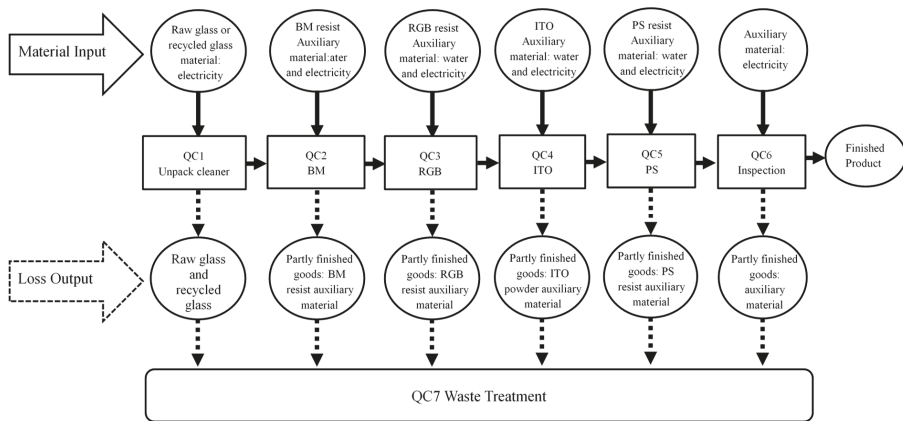

Figure 2. Material flow model for Company T.

#### 4.10. Quantification of Material Loss and Details (Material Balance Sheet for Each Quantity Center)

The total material loss of all quantity centers was measured and summarized using material balance principles based on the material-flow model in Figure 2. Details and the monetary value of losses in all quantity centers were recorded. Subsequently, the total loss and subtotal loss details were compared to ensure data consistency. When a value cannot be measured, it is estimated using logic reasoning, and the unit of a material is expressed in kilograms or in terms of the area or volume if it cannot be converted into kilograms. All units of measurement should be the same to facilitate subsequent analysis and comparison.

#### 4.11. Calculation of Material Flow Cost

The total quantity of a given material in each quantity center is calculated and multiplied by the unit purchase price to identify the hotspots with the highest loss rate.

##### 1. Cost System Calculation Method Adopted by Company T

Company T was not only equipped with a highly automated production system and corresponding MES, but had also finished introducing and integrating an ERP system in 2010. The quantity centers are defined in the utmost detail and data collection primarily depended on support from the ERP system.

Cost calculation in the ERP system began with the bill of material. Two types of work orders were issued: a standard-order bill of material (realistic standard) and production-order bill of material (ideal standard). The difference between them was used to adjust uncertain losses during the production and to prepare for material distribution. The two types of work orders are described as follows:

- (1) Standard-order bill of material: A standard-order bill of material is the accounting evidence and also consists of the amount of materials used in each quantity center, hours of labor, and other manufacture quantities of input materials required to produce a piece of color filter without any substantial loss ring costs;
- (2) Production-order bill of material: It is almost impossible that no loss is incurred during the production process. Therefore, production-management staff adopt a standard-order bill of material as the basis for adjusting input quantity according to the status of a production line. Adjustments are most commonly made to yields. On a production-order bill of material, the quantity of usage is also the basis for calculating material stock and the quantity of materials to be purchased. Cost accounting is based on the data provided on a production-order bill of material, which documents the production start time, actual usage in each quantity center, and

the amount of loss. In the case of actual usage, cost is calculated by multiplying the bill of material-based input quantities in each quantity center by the standard unit price. Standard unit price is the unit price of the most recently approved order. The actual cost of each quantity center is summarized in Table 2. In the following section, adjustments to figures in the table are simulated. After a work order has been completed and inventoried, a work order record sheet is completed, as displayed in Table 3.

Table 2. The actual cost for each quantity center.

Type	Item	Name	Unit	Standard Unit Price	QC 1		QC 2		QC 3		QC 4		Total	
					Quantity of Usage	Monetary Amount	Quantity of Usage	Monetary Amount	Quantity of Usage	Monetary Amount	Quantity of Usage	Monetary Amount		
Material		Class	Piece	2800	303	848,400	-	-	-	-	303	848,400		
		Resist 1	Kg	3200	0.8	2560	-	-	-	-	0.8	2560		
		Resist 2	Kg	1800	0.7	1260	-	-	-	-	0.7	1260		
		Resist 3	Kg	1500	-	-	-	-	-	0.8	1200	0.8	1200	
Labor		I/O	Kg	21,000	-	-	-	0.2	4200	-	-	-	4200	
		Direct labor	Hour	125	3.5	438	4	500	2	250	3.5	438	13	1625
		Indirect labor	Hour	165	3	495	3	495	3	495	3	495	12	1980
Manufacturing Costs		Depreciation expense	Area/Square	10,000	10	100,000	30	300,000	20	200,000	20	200,000	80	800,000
		Consumables	Hour	800	3.5	2800	4	3200	2	1600	3.5	2800	13	10,400
		Other costs	Hour	600	3.5	2100	4	2400	2	1200	3.5	2100	13	7800
		Electricity	KWH	4500	3.5	15,750	4	18,000	2	9000	3.5	15,750	13	58,500
	Total					971,243		327,155		216,745		222,783		1,737,925

Note: The examples for QC2 are shown in Table A1 of Appendix A, respectively.

Table 3. Quantity of materials used in a work order.

Type	Name	Unit	MFCA Terms			Yield	Ideal Standard	Consumption Quantity		Loss	
			Standard Unit Price	Standard Usage	Standard Monetary Amount			Actual Quantity of Usage	Monetary Amount Equivalent of Actual Amount of Usage		
Material	Class	Piece	2800	300	840,000	99%	303	303	848,400	8400	3.0
	Resist 1	Kg	3200	0.3	960	98%	0.306	0.8	2560	1600	0.5
	Resist 2	Kg	1800	0.6	1080	99%	0.606	0.7	1260	180	0.1
Labor	Resist 3	Kg	1500	0.6	900	97%	0.618	0.8	1200	300	0.2
	I/O	Kg	21,000	0.1	2100	85%	0.115	0.2	4200	2100	0.1
	Direct labor	Hour	125	10	1250	80%	12	13	1625	375	3.0
Manufacturing Costs	Indirect labor	Hour	165	11	1815	80%	13.2	12	1980	165	1.0
	Depreciation expense	Area/Square	10,000	80	800,000	100%	80	80	800,000	-	0.0
	Consumables	Hour	800	11	8800	100%	11	13	10,400	1600	2.0
Electricity	Other costs	Hour	600	12.5	7500	100%	12.5	13	7800	300	0.5
	Electricity	KWH	4500	10	45,000	100%	10	13	58,500	13,500	3.0
	Total				1,709,405			1,737,925		28,520	

In the process of MFCA calculation, a realistic standard refers to the cost, as stated in a standard bill of material, required to produce a piece of color filter without incurring loss. An ideal standard refers to the anticipated input quantity under consideration for yield. Quantity of consumption refers to the actual quantity of the input. The difference between the realistic standard and quantity of consumption is the difference in work order. Company T performed an analysis by multiplying the realistic standard quantity of usage by the annual average unit price. The cost required to produce a piece of color filter is regarded as the basis for calculating positive products, and the remaining costs are regarded as losses. This approach differs considerably from the calculation methods generally used in cost accounting.

In the initial stage of implementation, Company T attempted to use the cost-accounting method based on the material inventory sheet of a standard cost system and then allocated order differences to each material cost. However, MFCA analysis first appealed to the rate of losses and subsequently based cost allocation on the monetary amount or quantity of each production, which does not significantly influence the percentages of positive and negative products.

## 2. Material-Flow Cost-Accounting Analysis

The aim of the MFCA technique is to assess material and energy flow in material flow and monetary evaluations during the production process [9]. MFCA is a tool that captures material flow and monetary evaluations. The most substantial difference between cost accounting and MFCA is in the calculation of loss. Cost accounting of company T incorporates the cost of losses into the cost of a finished product. For example, the quantity of consumption in Table 3 was recorded in terms of the quantity of losses on a work order form, but the cost of loss was “zero.” By contrast, MFCA involves the separate calculation of the sum of the cost of losses and determination of the causes for these losses. The focus of MFCA is on recognizing waste as nonmarketable products. In this study, we consolidated work orders for an entire year and listed all of the inputted materials, ascertaining “Input = positive products + negative products” to obtain a material flow model record sheet for Company T.

## 3. Material Input and Loss Calculation

Material quantity is calculated using the total quantity of materials in a work order that has both input and output in the same year within the scope of the specified time period. Calculations were based on the scope of the calculation in Table 4.

**Table 4.** Scope of calculation.

QC	Quantity of Material Input (INPUT)	Usage of Positive Products in Each Resist	Quantity of Resist Lost	Quantity of Losses	Input Cost and Cost of Losses
QC1: Unpacked Cleaner	Quantity of glass inputted in QC1 is the total quantity of glass inputted in 2012 (because QC1 only has glass input and no other material input, and the input of a piece of glass produces a piece of glass filter, which is characteristic of the company's product)			Quantity of glass lost = quantity of defective glass at a station	Quantity × unit price = input and loss costs
QC2: BM Processes	Quantity of positive products in QC1 OUTPUT + Total quantity of new materials input in QC2	Sum of the quantity of glass positive products × the realistic-standard quantity of resist usage in each work order	Total number of resist input – the value for the usage of each resist positive product	Quantity of glass lost = quantity of defective glass at a station	Quantity × unit price = input and loss costs
QC3: RGB Processes	Quantity of positive products in QC2 OUTPUT + Total quantity of new materials input in QC3	Sum of the quantity of glass positive products × the realistic-standard quantity of resist usage in each work order	Total number of resist input – the value for the usage of each resist positive product	Quantity of glass lost = quantity of defective glass at a station	Quantity × unit price = input and loss costs
QC4: POL Processes and ITO Processes	Quantity and monetary amount of each material used in the QC thereafter				
QC5: PS Processes	Quantity and monetary amount of each material used in the QC thereafter				
QC 6: Inspection	Quantity and monetary amount of each material used in the QC thereafter				
QC 7: Waste Treatment	Quantity and monetary amount of each material used in the QC thereafter				

The total quantity of each material in each quantity center is calculated and multiplied by the unit purchase price to produce the MFCA balance sheet and identify hotspots with the highest loss rate.

#### 4.12. Summary of Energy and System Costs

Companies establish the cost center to which manufacturing costs can be allocated. Generally, the collection and organization of system and energy costs are based on data regarding manufacturing costs. Therefore, the cost center of a company can use manufacturing costs as a source of data regarding energy and system costs. Quantity centers in MFCA encompass system and energy costs, which are allocated to quantity centers according to the quantity of positive and negative products. Companies have begun to install electronic meters in their production lines to control electricity consumption, thereby conserving energy and reducing carbon emissions. If energy costs can be determined for individual quantity centers, then the results can be effectively analyzed.

##### 1. Energy Cost (Water & Electricity Cost) Calculation

Company T selected the sixth generation plant, primarily because the production line is equipped with unique water and electricity meters, which facilitated the collection of energy data. However, not all stations had an electricity meter. Therefore, we still used input quantity as the basis of the allocation. Table 5 presents details of the calculation method. As shown in Table 5, Input Cost of Each QC that Cost allocation and calculation for QCs that have inputted water resources, as displayed in Table 6 = Total quantity of glass input at a station (including the number of times stripped glass was reworked) × the unit cost of tap water.

**Table 5.** Energy cost (Water & Electricity Cost) calculation method.

Energy	Usage	Unit Cost	Input Cost of Each QC	Cost of Losses in Each QC
Tap water	Data regarding tap-water consumption were obtained from the quantity and monetary amount indicated by the Taiwan Water Corporation, but these data excluded the consumption of pure water	Unit cost of tap water = total monetary amount for 2012/total water consumption	Cost allocation and calculation for QCs that have inputted water resources = Total quantity of glass input at a station (including the number of times stripped glass was reworked) × the unit cost of tap water	= Total quantity of glass input at a station (including the number of times stripped glass was reworked) × the unit cost of tap water
Electricity	The plant owned by Company T supplied electricity to its two plant buildings; therefore, electricity consumed by the plant was allocated according to the ratio of electricity consumption by the two plant buildings. Subsequently, total electricity consumption was allocated to each QC, and costs were calculated as follows: Total electricity consumption = (amount of electricity consumption by a production line + amount of electricity allocated to plant buildings) in 2012	Unit cost of electricity = (monetary amount for a production line indicated by the Taiwan Power Company + the monetary amount allocated to plant buildings) in 2012/total electricity consumption	Cost allocation and calculation of QCs that have inputted electricity = total quantity of glass input at a station (including the number of times stripped glass was reworked) × the unit cost of electricity	= Total quantity of defective glass at a station (including the number of times stripped glass was reworked) × the unit cost of electricity × the number of stations passed

**Table 6.** Energy-cost calculation of Company T. (Unit: NT\$).

Item	Work Section	Input Quantity	Monetary Input	Average Unit Price	Cumulative Input Quantity	Cumulative Monetary Input
Tap Water	QC1 INC					
	QC2 BM	53,260	698,425	13.11	53,260	698,425
	QC3 RGB	222,398	2,916,395	13.11	275,658	3,614,820
	QC4 POL/ITO	301,265	3,950,633	13.11	576,923	7,565,453
	QC5 PS	350,053	4,590,404	13.11	926,976	12,155,857
	QC6 INS	344,913	4,523,001	13.11	1,271,889	16,678,858
Tap Water Subtotal		1,271,889	16,678,858	13.11		
Electricity	QC1 INC	2,905,791	4,217,049	1.45	2,905,791	4,217,049
	QC2 BM	20,315,148	29,482,497	1.45	23,220,939	33,699,546
	QC3 RGB	55,192,669	80,098,737	1.45	78,413,608	113,798,283
	QC4 POL/ITO	93,347,887	135,471,756	1.45	171,761,495	249,270,039
	QC5 PS	108,138,933	156,937,362	1.45	279,900,428	406,207,401
	QC6 INS	109,630,206	159,101,582	1.45	389,530,634	565,308,983
Electricity Subtotal		389,530,634	565,308,983	1.45		
Total		390,802,523	581,987,841	1.49		

Note: Figures adjusted through simulation. The examples for Water cost are shown in Table A2 of Appendix A, respectively.

## 2. System Cost Calculation

System costs includes labor, depreciation expenses, consumables, and other expenses. With the exception of labor costs, system costs are fixed costs. Table 7 presents the system cost calculation method.

**Table 7.** System cost calculation method.

Cost	Calculation Method	Unit Cost	Input Cost of Each QC	Cost of Losses in Each QC
System Cost	System cost = total production costs for a work order that has both input and output in 2012 – (Material cost + energy cost + waste treatment cost)	Unit cost of system cost = system cost / (the quantity of glass input at a station + the number of times stripped glass was reworked at each station)	Cost allocation and calculation for each QC = quantity of glass input at a station (including the number of times stripped glass was reworked) × the unit cost of the system	= Quantity of defective glass at a station (including the number of times stripped glass was reworked) × the unit cost of the system × the number of stations passed

### 4.13. Waste-Treatment Cost Calculation

The income from scraps sold was deducted from the cost expended on handling waste to obtain the sum of the entire waste treatment cost. Because each quantity center generated waste, the waste could be viewed as a quantity center for calculation to facilitate data collection. Waste treatment cost includes waste-treatment fees, air-pollution controls and handling fees, and wastewater control and handling fees, all of which also cover outsourcing fees and the deduction of scrap income. Waste treatment cost reflects 100% loss and is therefore not allocated to product costs.



#### 4.14. Development of Improvement Plans

After establishing an MFCA calculation model, material balance sheet, and MFCA balance sheet, we identified negative product costs and types, reasons, and quantity of losses; proposed improvement topics; determined improvement targets; investigated the feasibility of improvement methods; and implemented the improvement methods on the basis of predicted improvement effectiveness. MFCA is essentially a practice that improves a manufacturing site. MFCA is a form of analysis and planning, and daily activities conducted at a manufacturing site are practices. Thus, blending MFCA and daily activities ensures that the results of MFCA analysis are goal-oriented and can therefore provide concrete benefits rather than vague and superficial results. When numerous concerns must be addressed, MFCA serves as an effective prioritization tool.

##### 1. Results of Material Flow Cost-Accounting Analysis

We performed an MFCA analysis on each quantity center based on the information provided in the aforementioned material flow model record sheet and subsequently produced an MFCA balance sheet.

##### 2. Findings Based on an Analysis of the Material Flow Cost Accounting Implementation of Company T

Because the original product yield of Company T was 99.1%, the cost of the negative products was low. Of all costs, the material cost (67.1%) was the primary input of a product, in which the cost of glass materials accounted for 51% of the material cost. Through analysis, we discovered that lowering the glass-stripping rate resulted in reductions of other material, energy, and system costs required for reworking. Additionally, recycled glass is associated with a high stripping rate. Whether the sum of this cost and the cost of renewable cleaning is lower than the cost of reworking should be re-evaluated to determine the benefits of outsourcing recycled materials. Even though MFCA is considered an effective tool for reducing waste and environmental effects, its procedures are confined to recycling processes and recycled materials involving a production system. Therefore, product designs should aim to lower the cost of byproducts and fully utilize the materials of a production department to ultimately reduce the amount of waste produced [10].

Regarding the energy cost, problems related to climate change are integral to the sustainable development of Company T. The analysis indicated a loss rate of 3.09% in the energy cost. In response, the company can first improve its power supply by installing smart electricity meters and developing energy-resource management systems to track energy usage and then specify goals to promote environmental sustainability and emission reduction. In 2012, Company T introduced the goal of reducing the emissions in 2010 by an additional 25% by 2015.

Regarding the waste treatment cost, Company T can improve its efficiency in the process of collecting volatile organic compounds and reduce its hazardous air pollutant fugitive emissions by increasing the process efficiency of its terminal air-pollution control equipment. In 2012, the company improved its method for wastewater treatment by investing in an anaerobic wastewater-treatment system and increasing wastewater-treatment efficiency.

The analysis revealed that the internal process management of the company could still be improved. For example, the collected data indicated that the costs and ratios of losses were low, and the materials lost had no value and could therefore be treated as waste. Consequently, we were unable to determine whether the quantity of recognized waste was the same as the ideal quantity of waste. Because the losses could not be accurately determined, the realistic standard usage implied in the bill of material might include the reasonable loss standard. Therefore, this process must be further improved. Additionally, because the records of reworking are not properly managed, the question of whether reworking should be incorporated into process management can be considered in the next stage of improvement.

#### *4.15. Improvement Implementation*

In the initial stage of implementing improvements, the following steps can be taken: become familiar with the MFCA operating process, remain up-to-date regarding the logic and methods of data collection, and then initiate improvement plans for MFCA. In performing a detailed analysis, the management indicators of a manufacturing site (e.g., finished product rate, defect rate, and availability or uptime) can be combined to help define a standard value or improvement target and achieve these standards or targets. MFCA focuses on the analysis of informative data, and specifically on the application of data following analysis. The operation of MFCA essentially involves the application of a plan–do–check–act cycle, which is the key to project improvement and continual improvement for many corporations. A clearly defined scope of responsibility and the participation of executives and interdepartmental professionals are the pillars for implementing short-term, mid-term, and long-term MFCA improvement plans. MFCA can provide companies with informational feedback, including feedback on financial performance, for operating the planning and completion phases of the plan–do–check–act management cycle, considering subsequent improvement targets and decisions, and defining new corporate improvement indicators. Material flow is an integral component of management for two reasons: from an environmental perspective, material flow reflects the direct influence of an organization on the environment; and from an economic perspective, it helps to reduce the production cost, thereby enhancing the corporate financial performance [25]. Thus, this phenomenon proves that MFCA is a tool that enhances the corporate resource efficiency and thereby facilitates the actualization of sustainable development [31].

### **5. Conclusion and Recommendations**

Companies have begun to increasingly focus on how they can align requirements for social sustainability and competitiveness [33]. When companies cease to pursue only individual sustainable operations, they inevitably regard the environment as a component of corporate development [34]. MFCA has expanded the scope of conventional accounting to include the environment and the economic effects of corporate sustainability and eco-efficiency concepts [21,35], thereby rendering goal management increasingly more scientific and systematic. This study assists companies to examine the process of recycled glass production by using ISO 14051-based MFCA and investigate whether a company can reduce costs by using recycled glass and mitigate the pollution and improve the companies' environmental performances.

There is no previous paper discussing the MFCA implementation steps and providing suggestions for reducing the cost in Taiwan. One of the reasons for this is that the number of certified companies in Taiwan remains low, and whether these companies continue to conduct analyses after receiving certification is unknown. The reason that the case company successfully implements MFCA is the attitude of its chief executive officer. In the second year of implementation, the case company performed an analysis of the entire plant and discovered that its wastewater-treatment expenses were positively correlated with resist loss, chemical usage, and water consumption. In the one month that did not exhibit a positive correlation, the company discovered that the sluice gate controlling wastewater discharge was damaged, which was causing a considerable increase in wastewater-treatment expenses because of the direct discharge of untreated wastewater. Although MFCA does not yield immediate effects regarding an increase in company profits, this practice demonstrates another type of long-term corporate value that contributes to effective cost reduction in low-profit environments. Compared with previous research, this paper not only introduces the advantages and effects of implementing the MFCA, but also lists the key action plan when applying the MFCA. This can help future companies to have a complete idea in assessing whether to implement the MFCA.

To bolster competitiveness, companies have continually invested monetary resources in the adoption of environmentally friendly practices. However, questions are often raised during this process regarding whether such an investment is truly beneficial for the environment or corporate development, and some companies remain focused on acquiring certifications to boost sales performance. Currently,

introducing MFCA helps companies to obtain not only certificates that contribute to sales, but also rewards in the form of cost reduction due to environmental initiatives.

Team composition, interpersonal communications, and the efforts of revolutionists are factors that contribute to the success of MFCA implementation. However, a potential barrier for improving MFCA is the inability of senior managers to solve performance-management problems [11]. Government authorities in Taiwan have begun to follow the steps implemented in Japan in terms of encouraging companies to introduce ISO14051-based MFCA analysis. Personnel in contact with companies primarily include those from environmental-safety, quality-control, or plant affairs departments. However, the basic information required for the analysis is generally managed by the finance and accounting departments. Therefore, the implementation of MFCA should collect, analyze, compile, and describe data from the perspectives of financial and accounting specialists to alert these specialists to the difference between conventional cost accounting and MFCA. After a balance sheet for basic analysis has been obtained, it should then be administered to plant personnel for hotspot improvements.

We determined that the original rate of product yield for the case company was 99.1%, indicating that the costs of negative products were low. Of all costs, the cost of glass materials accounted for 51% of the material cost (67.1%). During analysis, we discovered that reducing the glass-stripping rate resulted in a reduction of other material, energy, and system costs required for reworking. However, recycled glass is associated with a high stripping rate. Whether the sum of this cost and the cost of renewable cleaning is lower than the cost of reworking should be re-evaluated to determine the benefits of outsourcing rework. The analysis also indicated a loss rate of 3.09% in the energy cost. In response, the company can improve its power supply by installing smart electricity meters and developing energy-resource management systems to monitor energy usage. Therefore, this study verified that MFCA analysis both provides insights regarding areas that require improvement in the internal process management of the company and helps the company to achieve sustainable development with the goal of promoting environmental sustainability and reducing emissions. The primary finding is that the film layer on recycled washed glass tends to be stripped during the production process, causing increased reprocessing costs and thus rendering the cost of renewable cleaning higher than that of reworking.

By observing the case company's promotion of the ISO14051 MFCA tool, we can confirm that the inter-departmental flow of information is more accurate according to the steps in Chapter 2.3.1, which helps organizations better understand the application of materials and energy. Because the scope of sharing was expanded, it helped to improve the company to reduce the implementation of operating procedures. Through this study, we also found that managers could understand the MFCA tool more easily, and also helped the organization to better understand the application of materials and energy. That is to say, even if different managers operate MFCA tools, the results of this study are not very different from those calculated by the case company. Therefore, it is an analytical management tool that can be popularized.

The MFCA analysis tool is effectively optimizing the cost management system in reducing the cost, especially when the limited resources are input by the business. Thus, the implementation of the MFCA analysis tool receives more benefits than cost spending. The academic contributions of the study are as follows. The study promotes the application of MFCA to SMEs because the case company sets an example to other SMEs that MFCA can be embarked on with relative ease, and indicates perhaps an inexpensive cost of implementation. The research fills the research gap by providing the steps and suggestions of the successful application of an ISO 14051-based MFCA case in Taiwan. The case company utilizes MFCA to analyze the recycling process of a film layer, which can actually reflect the cost of the waste. The results can be applied to review the recycling process of the case company to effectively reduce the costs. The analysis can achieve the goal of reducing the costs and increasing the efficiency and set the model for promoting the sustainability.

The practical contributions of the study are as follows. This study analyzes Taiwan CFI Company, the first company to receive ISO 14051 MFCA certification in Taiwan, which is recommended to get the business environmental protection award. The case company can be a role model for promoting

business sustainability. The experience of applying MFCA can act as guidelines for businesses in manufacturing and service industries, which are devoted to improving the sustainable environment and lowering the costs.

The MFCA analysis shows that the recycling process increases the reprocessing cost, which is not beneficial for the case company to promote the sustainability. It provides, based on the case company, improvement directions and guidelines for waste recycling after the application of MFCA. The results can utilize the Material Circularity Indicator, developed by the Ellen MacArthur Foundation, to analyze the actual recovery rate of the materials and the life or frequency of the product use, which can be the reference for the improved design of the second-hand recycling process system.

#### Recommendations

MFCA is still in the nascent stage of implementation in Taiwan. Companies remain ill-informed with respect to the process of MFCA analysis. Furthermore, support services in Taiwan are primarily grounded in science and technology and lack professional knowledge on finance and accounting. This results in a context that is characterized by different cost concepts, missing data, and a lack of multidisciplinary talents, which greatly impedes MFCA implementation. However, because finance and accounting units primarily hold the controlling power and a strong subjective awareness, when implementation is governed by these units, the result is often a phenomenon that deviates from the site of implementation. Therefore, departmental support is necessary during project development. In the early stages of MFCA implementation, finance and accounting personnel should not be overly focused on balancing data and account analyses because analysis results are not affected by a one-dollar difference. Moreover, the purpose of MFCA is not solely to reduce the consumption of a single company. MFCA is ultimately aimed at achieving green activities on a global scale through the integration of upstream, midstream, and downstream processes.

The limitations of this case study should be considered. Because remanufacturing requires used products to serve as the input, the success of remanufacturing largely depends on the efficiency with which used products are collected [12]. Recycled glass is a used item; therefore, the reliability of recycled and washed glass in the recycling system of a production process should be extensively evaluated before a study is conducted. The present study was not focused on the process of collecting used products. The reliability of recycled glass in the recovery process should be evaluated before the study. This study does not focus on the collection process of used products. The evaluation of the effectiveness and reliability of the recycling process requires further steps, which can be carried out by manufacturers, retailers, or third parties. That is much more suitable for the follow-up research. Further steps are required to assess the effectiveness and reliability of a recycling environment, and in future research, these could be implemented by manufacturers, retailers, or third parties, which is more suitable for subsequent studies.

The case company of this study was highly automated in that its equipment-production information was linked by an MES that was managed by its industrial engineering department and integrated into the ORACLE-ERP system. With the advent of Internet of Things, various technologies have led to the development of automated systems and digital information. To optimize production processes and create higher-quality products, artificial intelligence technology has become the mainstream in the market. The development of robotic process automation provided the case company with a means for introducing new technologies in its corporate operations (e.g., business processes, labor management, supply chain management, procurement, and accounting) to improve corporate efficiency and reduce costs, thereby helping the company to make progress towards achieving sustainable development.

**Author Contributions:** S.Y.H.: Writing—review & supervision; A.A.C.: Writing—review & editing; P.C.C.: Writing—original draft; N.W.: Writing—Methodology.

**Funding:** This research received no external funding.

**Conflicts of Interest:** The authors declare no conflict of interest.

## Appendix A

Table A1. Taking QC2 as an example for Table 2.

The calculation steps are as follows	
Material_Resist 1: Standard Unit Price \$3200 × Quantity of Usage 0.8 = Monetary Amount \$2560	
Labor_Direct labor: Standard Unit Price \$125 × Quantity of Usage \$4 = Monetary Amount \$500	
Labor_Indirect labor: Standard Unit Price \$165 × Quantity of Usage \$3 = Monetary Amount \$495	
Manufacturing Costs_Depreciation expense: Standard Unit Price \$10,000 × Quantity of Usage \$30 = Monetary Amount \$300,000	
Manufacturing Costs_Consumables: Standard Unit Price \$800 × Quantity of Usage \$4 = Monetary Amount \$3200	
Manufacturing Costs_Other costs: Standard Unit Price \$600 × Quantity of Usage \$4 = Monetary Amount \$2400	
Manufacturing_Electricity: Standard Unit Price \$4500 × Quantity of Usage \$4 = Monetary Amount \$18,000	
The total cost of QC2 is \$327,155	

Table A2. Taking Tap Water's Cumulative Input Quantity and Cumulative Monetary Input as an example for Table 6.

The calculation steps are as follows			
Step1 Monetary Input/Input Quantity = Average Unit Price			
Step2 last Cumulative Input Quantity + Input Quantity = Cumulative Input Quantity			
Step3 Cumulative Input Quantity × Average Unit Price = Cumulative Monetary Input			
Work Section	Step1 Average Unit Price	Step2 Cumulative Input Quantity	Step3 Cumulative Monetary Input
QC2 BM	\$698,425/53,260 = \$13.11	0 + 53,260 = 53,260	53,260 × \$13.11 = \$698,239
QC3 BM	\$2,916,395/222,398 = \$13.11	53,260 + 222,398 = 275,658	275,658 × \$13.11 = \$3,613,876
QC4 POL/I/O	\$3,950,633/301,265 = \$13.11	275,658 + 301,265 = 576,923	576,923 × \$13.11 = \$7,563,460
QC5 PS	\$4,590,404/350,053 = \$13.11	576,923 + 350,053 = 926,976	926,976 × \$13.11 = \$12,152,655
QC6 INS	\$4,523,001/344,913 = \$13.11	926,976 + 344,913 = 1,271,889	1,271,889 × \$13.11 = \$16,674,464
Tap Water Monetary Input Subtotal: \$ 698,425 + \$2,916,395 + 3,950,633 + \$4,590,404 + \$4,523,001 = 16,678,858			

## References

- Stotz, P.M.; Bey, N. Integrating Sustainability in the Development and Operation of High-volume Production Lines. In Proceedings of the 25th CIRP Life Cycle Engineering (LCE) Conference, Copenhagen, Denmark, 30 April–2 May 2018.
- Cheng, L.C. The Study of Accounting Statements of Environmental Costs. Master's Thesis, Business Administration National Sun Yat-sen University, Kaohsiung, Taiwan, 2017.
- Fakoya, M.B.; van der Poll, H.M. Integrating ERP and MFCA systems for improved waste-reduction decisions in a brewery in South Africa. *J. Clean. Prod.* **2013**, *40*, 136–140. [\[CrossRef\]](#)
- Daian, G.; Ozarska, B. Wood waste management practices and strategies to increase sustainability standards in the Australian wooden furniture manufacturing sector. *J. Clean. Prod.* **2009**, *17*, 1594–1602. [\[CrossRef\]](#)
- Van Hoof, B.; Lyon, T.P. Cleaner production in small firms taking part in Mexico's Sustainable Supplier Program. *J. Clean. Prod.* **2013**, *41*, 270–282. [\[CrossRef\]](#)
- Wagner, B.; Enzler, S. *Material Flow Management: Improving Cost Efficiency and Environmental Performance*; Springer: Berlin, Germany, 2005; pp. 8–12.
- Christ, K.L.; Burritt, R.L. ISO 14051: A new era for MFCA implementation and research. *Rev. Contab. Span. Account. Rev.* **2016**, *19*, 1–9. [\[CrossRef\]](#)
- Schaltegger, S.; Windolph, S.E.; Herzig, C. *From Knowledge to Application: Dissemination of Sustainability Management Tools in Large German Companies*; Centre for Sustainability Management, Leuphana University: Lueneburg, Germany, 2011.
- Onishi, Y.; Kokubu, K.; Nakajima, M. Implementing material flow cost accounting in a pharmaceutical company. In *Environmental Management Accounting for Cleaner Production*; Schaltegger, S., Bennett, M., Burritt, R.L., Jasch, C., Eds.; Springer: Dordrecht, The Netherlands, 2009; pp. 395–409.

10. Kasemset, C.; Chernsupornchai, J.; Pala-ud, W. Application of MFCA in waste reduction: Case study on a small textile factory in Thailand. *J. Clean. Prod.* **2015**, *108*, 1342–1351. [CrossRef]
11. Sulong, F.; Sulaiman, M.; Norhayati, M.A. Material Flow Cost Accounting (MFCA) enablers and barriers: The case of a Malaysian small and medium-sized enterprise (SME). *J. Clean. Prod.* **2015**, *108*, 1365–1374. [CrossRef]
12. Tang, C.S.; Zhou, S. Research advances in environmentally and socially sustainable operations. *Eur. J. Oper. Res.* **2012**, *223*, 585–594. [CrossRef]
13. Energy Research Centre of the Netherlands. Resource Efficiency: What Does It Mean and Why Is It Relevant? 2013. Available online: <https://www.ecn.nl/docs/library/report/2013/o13004.pdf> (accessed on 30 August 2018).
14. International Organization for Standardization (ISO). *Environmental Management—Material Flow Cost Accounting—General Framework (ISO 14051:2011)*; ISO: Geneva, Switzerland, 2011.
15. Seuring, S.; Müller, M. Integrated chain management in Germany—Identifying schools of thought based on a literature review. *J. Clean. Prod.* **2007**, *15*, 699–710. [CrossRef]
16. Sygulla, R.; Bierer, A.; Götz, U. Material Flow Cost Accounting—Proposals for Improving the Evaluation of Monetary Effects of Resource Saving. In Proceedings of the 44th CIRP Conference on Manufacturing Systems, Madison, WI, USA, 31 May–3 June 2011.
17. Kokubu, K.; Kitada, H. Material flow cost accounting and existing management perspectives. *J. Clean. Prod.* **2015**, *108*, 1279–1288. [CrossRef]
18. Mahmood, H.; Furqan, M.; Bagais, O. Environmental Accounting of Financial Development and Foreign Investment: Spatial Analyses of East Asia. *Sustainability* **2019**, *11*, 13. [CrossRef]
19. Masud, M.A.K.; Bae, S.M.; Kim, J.D. Analysis of Environmental Accounting and Reporting Practices of Listed Banking Companies in Bangladesh. *Sustainability* **2017**, *9*, 1717. [CrossRef]
20. Nakajima, M. On the differences between material flow cost accounting and traditional cost accounting: In reply to the questions and misunderstandings on material flow cost accounting. *Kansai Univ. Rev. Bus. Commer.* **2004**, *6*, 1–20.
21. Wan, Y.K.; Ng, R.T.; Ng, D.K.; Tan, R.R. Material flow cost accounting (MFCA)-based approach for prioritisation of waste recovery. *J. Clean. Prod.* **2015**, *104*, 602–614. [CrossRef]
22. Dunuwila, P.; Rodrigo, V.H.L.; Goto, N. Sustainability of natural rubber processing can be improved: A case study with crepe rubber manufacturing in Sri Lanka. *Resour. Conserv. Recycl.* **2018**, *133*, 417–427. [CrossRef]
23. Kokubu, K. *Practice of Material Flow Cost Accounting*; Japan Environmental Management Association for Industry: Tokyo, Japan, 2008.
24. Chompu-Inwai, R.; Jaimjit, B.; Premsuriyanunt, P. A combination of Material Flow Cost Accounting and design of experiments techniques in an SME: The case of a wood products manufacturing company in northern Thailand. *J. Clean. Prod.* **2015**, *108*, 1352–1364. [CrossRef]
25. Jasch, C. How to perform an environmental management cost assessment in one day. *J. Clean. Prod.* **2006**, *14*, 1194–12133. [CrossRef]
26. Chetty, N.S. The case study method for research in small-and medium-sized firms. *Int. Small Bus. J.* **1996**, *15*, 73–85. [CrossRef]
27. Yin, R.K. *Case Study Research: Design and Methods*, 2nd ed.; Sage Publications: Thousand Oaks, CA, USA, 1994.
28. Gustafsson, A.; Johnson, M.D. Measuring and managing the satisfaction-loyalty performance links at Volvo. *J. Target. Meas. Anal. Mark.* **2002**, *10*, 249–258. [CrossRef]
29. Gosman, M.L.; Kohlbeck, M.J. Effects of the existence and identity of major customers on supplier profitability: Is Wal-Mart different? *J. Manag. Account. Res.* **2009**, *21*, 179–201. [CrossRef]
30. Banker, R.D.; Potter, G.; Srinivasan, D. An empirical investigation of an incentive plan that includes nonfinancial performance measures. *Account. Rev.* **2000**, *75*, 65–92. [CrossRef]
31. Rieckhof, N.R.; Bergmann, A.; Guenther, E. Interrelating material flow cost accounting with management control systems to introduce resource efficiency into strategy. *J. Clean. Prod.* **2015**, *108*, 1262–1278. [CrossRef]
32. Strobel, M.; Redmann, C. Flow cost accounting, an accounting approach based on the actual flows of materials. In *Environmental Management Accounting: Informational and Institutional Developments*; Bennett, M., Bouma, J.J., Walters, T., Eds.; Kluwer: Dordrecht, The Netherlands, 2002; pp. 67–82.

33. Schönborn, G.; Berlin, C.; Pinzone, M.; Hanisch, C.; Lanz, M. Why social sustainability counts: The impact of corporate social sustainability culture on financial success. *Sustain. Prod. Consum.* **2019**, *17*, 1–10. [CrossRef]
34. China Productivity Center myMKC.com. MFCA Practice “Business and the Environment” of Sustainable Development 2017. Available online: <https://mymkc.com/article/content/22738> (accessed on 20 September 2018).
35. Strazza, C.; Borghi, A.D.; Borghi, M.D. Resource productivity enhancement as means for promoting cleaner production: Analysis of co-incineration in cement plants through a life cycle approach. *J. Clean. Prod.* **2011**, *19*, 1615–1621. [CrossRef]



© 2019 by the authors. Licensee MDPI, Basel, Switzerland. This article is an open access article distributed under the terms and conditions of the Creative Commons Attribution (CC BY) license (<http://creativecommons.org/licenses/by/4.0/>).



Article

# An Internal Control System that Includes Corporate Social Responsibility for Social Sustainability in the New Era

Jau-Yang Liu

Department of Accounting, Chinese Culture University, 55, Hwa-Kang Road, Yang-Ming-Shan, Taipei 11114, Taiwan; lcy13@faculty.pccu.edu.tw; Tel.: +886-937-544-654

Received: 11 September 2018; Accepted: 19 September 2018; Published: 21 September 2018

**Abstract:** Although the importance of corporate social responsibility has received more attention over the years, the goal of social sustainability has still not been achieved. The main reason is that companies seeking to implement social sustainability, have failed to incorporate the concept of corporate social responsibility into their corporate internal control objectives. Furthermore, studying the interactive relationship between corporate social responsibility and internal control and ensuring the consistency of corporate strategy and internal control objectives are done to help promote the sustainable development of enterprises. In order to promote social sustainability and improve management decision-making gaps, therefore, the purpose of this paper is to develop a new hybrid multi-attribute decision model to assess the impact of corporate social responsibility for the implementation of internal control that includes corporate social responsibility. The empirical results show that a social responsibility-oriented internal control system may be a better strategy than maintaining the original internal control objectives. In addition, by adjusting the internal control system to jointly promote the sustainable development goals of the company and ensure the consistency of corporate strategy and internal control objectives, the company can be truly guided to implement the social responsibility management objectives. Finally, the social sustainable development goals can be truly realized, and the interests of all stakeholders in the enterprise can be truly satisfied.

**Keywords:** sustainability performance; corporate social responsibility (CSR); internal control; multi-attribute decision model (MADM); decision making trial and evaluation laboratory (DEMATEL); DANP (DEMATEL based ANP); VIKOR

---

## 1. Introduction

In recent years, there have been many examples of the undesirable effects of the neglect of corporate social responsibility around the world, such as the BP oil spill in the Gulf of Mexico, and the fraud scandals created by some of the world's largest automakers, such as Volkswagen, and Mitsubishi Motors, involving the falsification of diesel vehicle emissions data and fuel consumption tests. These events not only caused major financial loss to the companies, but also affected the interests of other interested parties, and even caused damage to the company's goodwill and corporate image, as well as seriously endangering sustainable development. Clearly, attaching importance to corporate social responsibility is an important issue that cannot be ignored in current business operations. In addition to requiring the company to actively implement relevant internal controls to prevent similar incidents from happening again, society also requires the company's stakeholders to take responsibility and perform corporate social responsibility work to meet the expectations of stakeholders.

The purpose of internal control is to promote sound company operations, to ensure reasonable effectiveness and efficiency of these operations, and reporting on the reliability, timeliness, transparency



and compliance with the relevant laws and regulations as well as other goals [1]. Sound internal controls will not only improve the company's operating efficiency, but also reduce the risk. If the company incorporates corporate social responsibility principles into its internal control objectives, effective implementation of the internal control system will be able to meet the expectations of stakeholders and avoid major incidents of neglect of corporate social responsibility, resulting in significant company losses [2]. Therefore, strengthening the internal control to cope with various issues and leading companies to attach importance to social responsibility is the most important problem encountered by the current society.

In the past, the focus in the stakeholders' analysis of company performance has been on the financial performance aspect, neglecting non-financial information. The current objectives of the Committee of Sponsoring Organizations (COSO) are focused only on the achievement of operational effectiveness and efficiency, reporting reliability, and compliance with relevant laws and regulations. In other words, the COSO framework lacks the relevant connotations of corporate social responsibility [3–7]. Finally, although the company's internal control objectives may be immediately achieved, the results may not necessarily meet societal expectations or those of stakeholders. Therefore, given the current trend of attaching greater importance to corporate social responsibility, the three major objectives of COSO have been unable to meet the needs of stakeholders. It can be seen that the company must first make a good assessment of risks. They must also establish a sound internal control system, in which corporate social responsibility-oriented internal control is an important key to societal sustainability.

Moreover, the success of social sustainability is largely dependent on successful implementation of an internal control system which integrates all aspects of the organization into a series of activities aimed at reaching sustainable objectives [8,9]. Therefore, based on the existing two areas of internal control and corporate social responsibility, this paper will introduce the internal control system of corporate social responsibility orientation with the concept of balanced scorecard. Finally, the multi-criteria decision-making model is used to analyze the performance of this sustainable internal control system. The main purpose of combining the decision-making trial and evaluation laboratory (DEMATEL) and the analytical network process (ANP) methods is to determine the importance of each criterion and the interrelation among them. The VlseKriterijumska Optimizacija I Kompromisno Resenje (VIKOR) method is used to evaluate the overall performance gap in the sustainability performance for the empirical cases and identify and prioritize improvement strategies [10]. Based on this framework, senior management can further not only understand the priority and relationship of the company's corporate social responsibility (CSR)-oriented internal control objectives, but can also reduce performance gaps between current levels of social sustainability and the expectations of stakeholders.

## **2. Literature Review**

### *2.1. The Importance of Corporate Social Responsibility*

The topic of corporate social responsibility (CSR) continues to be of interest to researchers. It has been debated in the management literature for more than 50 years (e.g., [11–13]). Although consensus on a precise definition has yet to be found, it is widely accepted that CSR refers to the responsibility of an enterprise for the environment, social mores and quality of governance of its operations [14–16]. That is, while the company is producing profits, it also has to assume social responsibility for all stakeholders to achieve the ideals of economic prosperity, social welfare and sustainable environmental protection.

In recent decades, firms engaging in CSR have thus exhibited philanthropic and socially responsible business practices beyond the pursuit of economic self-interest and compliance with the law [17,18]. According to the World Business Council for Sustainable Development (WBCSD), corporate social responsibility requires a company's continued commitment to comply with ethical norms in its operations, while contributing to economic development, as well as improving the quality

of life of employees, their families, local communities and society as a whole. A growing body of literature suggests that an organization's involvement in CSR policies and practices tends to contribute not only to improvement of financial outcomes at the organizational level, but also to nonfinancial outcomes such as the firm's reputation in the eyes of its consumers and its attractiveness to investors by satisfying external stakeholders' expectations [19–22].

Recalling the evolution of corporate social responsibility suggests its importance. Modern companies are also actively making CSR efforts for the benefit of various stakeholders [23–25]. However, the company must somehow consider the interests of various stakeholders and implement actions into the management of the company to meet stakeholder expectations. Wood [26] (1991) has pointed out that managers have some discretion into which projects to devote their energy to. Information about the direction the manager takes can tell us much about the company's goals, the company's vision, and whether the company's responsibilities can be realized [27,28]. It can be seen from this that whether corporate social responsibility can be concretely realized requires the design, planning, and management of related systems. The goal is not simply to engage in empty talk, but also to have the opportunity to achieve concrete realization.

## *2.2. Improving Internal Control and Strengthening Corporate Social Responsibility*

Modern concepts of internal control emerged in the 1940s. After more than half a century of theoretical research and practical exploration, efforts have gradually consolidated to form a series of relatively systematic and feasible internal control frameworks and guidelines. According to the internal control framework of the international COSO organization, the objectives of internal control are nothing more than business objectives, reporting goals, compliance goals, and strategic objectives [29,30]. The different definitions of "internal control" can include the elements for the control of the internal environment, risk assessment, control activities, information and communication, and internal supervision [31,32]. The latest enterprise risk management integration framework further refines the monitoring of risks. From this we can realize that internal control theory has undergone five stages of internal control, internal control, internal control structure, internal control integration framework, and enterprise risk management integration framework [33,34]. The overall internal control development process is not a big bang, but a gradual process of theoretical development. It constantly absorbs new content in accordance with changes of the control environment over time.

In the past, internal control focused on the internal elements of the company, only emphasizing the interests of internal relations, and often neglecting the common interests of people outside the company [35,36]. As a consequence, the benefits of internal control were often limited to the interests of internal stakeholders. The results might not only fail to meet societal expectations, but could trigger a crisis because of differences in internal and external control for the company and sustainable development of corporate society. Therefore, a single, static internal control architecture appears to no longer be sufficient, but rather a more complex and dynamic internal control integration framework incorporating a multitude of stakeholder expectations need to be embedded in the enterprise's overall strategic risk management architecture.

From the above, we can see that, due to the increasingly complex control environment, in order for companies to meet the expectations of both internal and external stakeholders, internal control objectives need to consider the interests of both internal and external stakeholders. A more macroscopic perspective is required to meet the goal of corporate social responsibility as a social institution. Such development would not only promote changes in the values of society and stakeholders, but would also further improve internal control theory and control objectives [35]. The overall framework for internal control and enterprise risk management integration should not only consider changes in the external environment of the company's internal control, but also the risks of incorporating corporate social responsibility [37,38]. It should also actively strengthen the integration of corporate social responsibility and internal control objectives. Based on the perspective of corporate

social responsibility, inspecting corporate internal control issues and establishing a CSR-oriented internal control system are the fundamental guarantees for long-term corporate stability.

### *2.3. Practical Application of the Balanced Scorecard and Its Extension in Corporate Sustainability*

The balanced scorecard, as conceived by Kaplan and Norton [39], is a systematic strategic management system which provides a comprehensive framework for the evaluation of financial and non-financial performance measures from finance, customer, internal business process, and learning and growth perspectives. To reach a consensus on the overall strategy for development of a company, the balanced scorecard approach can effectively integrate the four objectives, targets, and initial action plans for design and implementation. The main purpose is to transform the company's strategy into concrete action plans to create a competitive advantage [40,41].

The balanced scorecard is also an advanced tool for performance measurement which divides the strategy into four different perspectives on operational objectives. Appropriate performance measures can be designed based on these four perspectives. Therefore, it not only provides enterprises with all kinds of information necessary for effective operation, but also overcomes the complexity and asymmetry of that information. More importantly, the indicators it provides to enterprises are quantifiable, measurable, and assessable, which is conducive to comprehensive and systematic monitoring and promotion of the company's strategic and long-term goals.

Aside from being a performance evaluation framework, the balanced scorecard can also help illuminate the driving forces of performance after a systematic analysis of the relevant factors required to meet the intended strategy [39,42–44]. Furthermore, some extended balanced scorecard designs have been developed to integrate the measurements of economic, social, and environmental factors in order to evaluate corporate sustainability performance (e.g., [45–49]). Scholars and practitioners therefore believe that the balanced scorecard is an appropriate tool for assessing the corporate sustainability performance because it can integrate the economic, environmental, and social needs of key stakeholders (e.g., [45,50–53]).

In addition, the balanced scorecard (BSC) is also an effective communication tool connecting strategy and practice. The goals and assessment indicators used in the balanced scorecard are derived from organizational strategy. It can translate the abstract vision of the organizational mission into tangible, concrete, practical, clear and effective goals and measurement indicators. Among them, in terms of the customer aspect, the BSC may need to consider all the various stakeholders that need to be satisfied to attain corporate social responsibility, by consideration of the expectations and vision of each stakeholder. The internal business process of the BSC is related to the organization's internal operational processes which the company needs to focus on and achieve in order to meet the expectations of various stakeholders. In this regard, the BSC is not concerned with the mere improvement of existing business processes, but with developing new internal business processes based on the vision and expectations of stakeholders. Moreover, the aspect of learning and growth in the BSC is related to the organization's investment in the future which is needed in order to realize the long-term interests and expectations of the various stakeholders, including measurement of employee abilities, the organization's value system and so on. Finally, the success of the organization in all these aspects must be translated into financial success and the efficient use of resources. Therefore, the BSC lists the financial goals of the organization and measures and whether the implementation and execution of the strategy is contributing to the improvement of the final operating results.

The goals and measurement metrics in the BSC are interconnected. This link not only includes causality, but also a combination of measurement of outcomes and measurement of the process leading to the results, which ultimately reflects the success of the organization's strategy. Compared with traditional and short-term oriented performance evaluation models, the BSC can assist in performance evaluation of the CSR-oriented internal control, because it focuses more on the various stakeholders' interests, reflecting the need for sustainable corporate development [53,54] and the links between the main sources of value and corporate strategy [43].

2.4. A Discussion of Prior Literature

Internal control objectives are reflected by maximization of shareholder value as the axis. The emphasis is on increasing the value of assets, to enhance the effect of economic efficiency and other economic goals. At the same time, internal controls also need to take into account social goals such as legal compliance and external stakeholder information needs, although consideration of the interests of other stakeholders is not comprehensive.

Modern companies have recognized that common corporate and social trends are critical in today’s business environment. In this regard, companies must incorporate the implications of CSR into the goals and scope of the internal company control. At the same time, they must also combine internal control with corporate social responsibility as a way to bring about mutual progress. For this purpose, the goal of corporate internal control is expanded from the original three COSO goals to four major goals with the inclusion of corporate social responsibility. The goal of corporate social sustainable development can be considered complete, and the goals of internal control can be achieved under the guidance of social responsibility.

When an organization commits itself to the development and implementation of activities related to social responsibility, the company’s stakeholders perceive that the organization is fulfilling its social responsibilities and is aligned with the common interests of stakeholders. Society is satisfied with the performance of the organization. Employee recognition of the organization’s socially responsible behavior indirectly impacts future performance and pursuit of excellence. The purpose of investment in CSR is not only to improve the internal efficiency of the company, to achieve reliability, but also to comply with related laws and regulations [55]. At the same time, social returns can also be expected from corporate socially responsible behavior.

A study of the impact of the interaction of internal control coupled with CSR on corporate performance by Zhu and Sun [56] showed that the main advantages of implementing CSR practices for internal or external stakeholders affect the company itself, suppliers, government, employees, and customers/stakeholders. Based on a review of the extant literature, we prepared and pre-tested a questionnaire in consultation with domain experts. The questionnaire includes 4 dimensions and 12 important criteria. The integrated framework for an internal control system with innovative and practical guiding CSR values is shown in Figure 1 and Table 1. It is hoped that a win-win relationship between the enterprise and society will be realized.

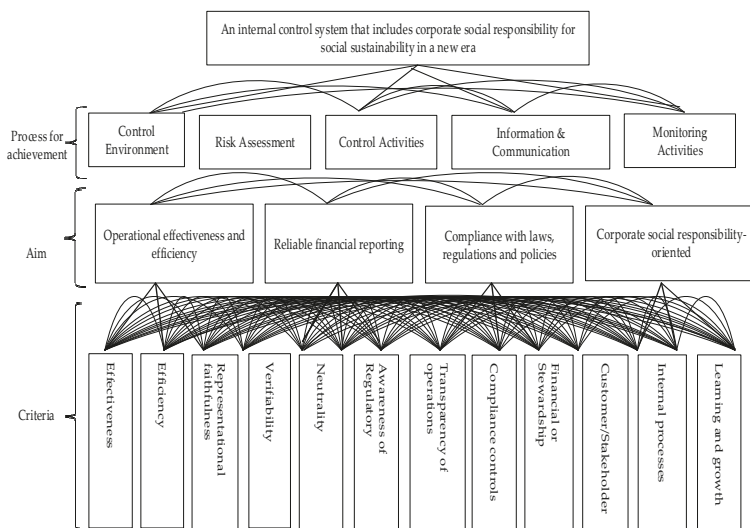

Figure 1. A corporate social responsibility (CSR)-oriented internal control social sustainable system.

### **3. Methodology**

#### *3.1. Data Collection and Empirical Case*

The dimensions and criteria of an internal control system that includes corporate social responsibility for social sustainability are often not independent but rather affect and interact with one another. As shown in Figure 1 and Table 1, we have collected a series of factors that can improve the effectiveness of internal control with innovative and practical guiding values for CSR obtained from the literature review and expert opinion. The four aspects having significant impact on the implementation of this new CSR-oriented internal control socially sustainable system, four aspects have a potentially significant impact are:

1. operational performance;
2. financial reporting;
3. regulatory compliance; and
4. corporate social responsibility.

Accordingly, the research process described in the paper is designed to include three phases: the pre-test questionnaire, the official questionnaire and the application of the survey to empirical cases. In the first phase, a pre-test questionnaire was designed to find a limited number of criteria from a single perspective in order to ensure the validity of the pairwise comparison [57,58]. The eighteen domain experts included 7 auditors of local CPA firms, 3 officials from the Financial Supervisory Commission in Taiwan, 4 members of CSR policy committees in listed companies and 4 academicians that specialize in internal control.

These domain experts all had a profound theoretical or practical understanding of the sustainability of internal control or corporate social responsibility. Among the participants, the 7 accountants had not only been involved in the actual case review of an internal control system project for the past three years, but also had relevant experience in the preparation of corporate social responsibility reports. They answered the pre-test questionnaire face-to-face in order to identify the most important criteria from a pool of criteria drawn from prior studies.

The pre-test questionnaire responses were rated in the range from 0 to 10 with a high score representing greater importance. The important criteria were selected based on triangular fuzzy numbers (with a mean of 8 or above). The evaluation criteria for a corporate social responsibility-oriented internal control system are shown in Table 1. The operational performance aspect is affected by two criteria: effectiveness, and efficiency; the financial reporting aspect is affected by three criteria: representational faithfulness, verifiability, and neutrality; the regulatory compliance aspect is affected by three criteria: awareness of regulations, transparency of operations, and compliance controls; the corporate social responsibility aspect is affected by four criteria: finances or stewardship, customers/stakeholders, internal processes, and learning and growth.

In the second phase, the official questionnaire was formulated according to Table 1. Respondents received instructions on how to complete the questionnaire before answering the questions. Each subject spent 20–30 min completing the questionnaire. The respondents were either chief executive officers or senior managers in Internal Control departments. A total of 178 survey responses were retrieved: among the respondents, 59.6% were male and 84.3% had over 9 years' work experience. All of the respondents were based in Taiwan. Table 2 presents detailed information about the survey participants.

**Table 1.** The evaluation dimensions and criteria of an internal control system that includes corporate social responsibility for social sustainability in a new era.

Dimensions	Criteria	Description	References
A. Operational performance	a1 Effectiveness	Adequate to accomplish the purpose; producing the intended or expected result.	[35,36,55,59,60]
	a2 Efficiency	Performing or functioning in the best possible manner with the least waste of time and effort.	
B. Financial reporting	b1 Representational faithfulness	Financial statements represent reality or what actually happened during the year	[36,61–63]
	b2 Verifiability	Financial information is verifiable when multiple, independent measures are used to come up with the same result.	
	b3 Neutrality	Management prepares completely unbiased financial statements	
C. Compliance with laws, regulations and policies	c1 Awareness of Regulations	Ensure that they are aware of and take steps to comply with relevant laws, policies, and regulations	[64–66]
	c2 Transparency of operations	(1) Easily detectable or transparent (visibility), and (2) readily understandable.	
	c3 Compliance controls (assurance)	Adopting the use of consolidated and harmonized sets of compliance controls	
D. Corporate social Responsibility-oriented	d1 Finances or Stewardship	Views organizational financial performance and the use of financial resources	[17–22,67]
	d2 Customers/Stakeholders	Views organizational performance from the point of view of the customer or other key stakeholders that the organization is designed to serve	
	d3 Internal processes	Views organizational performance through the lenses of quality and efficiency related to their own products or services or other key business processes	
	d3 Learning and growth	Views organizational performance through the lenses of human capital, infrastructure, technology, culture and other capacities that are key to breakthrough performance	

In the third phase, we invited each of the aforementioned dual-experienced CPAs to provide a case as an example for empirical analysis; which provided us with, in total, seven cases. The seven case companies are listed companies that have been selected as Excellence in CSR in Taiwan. Next, the CPAs were asked to assign linguistic values to the seven different cases for the twelve criteria for the CSR-oriented internal control social sustainable system proposed in this study. The questionnaire was designed to obtain performance values, which were very good, good, median, poor, and very poor, which were transformed by scaling into the numbers: 100, 75, 50, 25, 0, respectively. Finally, we use the weighted average method to calculate the individual scores of each company in different indicators. In the meanwhile, the final values obtained can be applied by VIKOR to evaluate the overall performance gap in empirical cases' sustainability performance of CSR-oriented internal control system.

**Table 2.** Detailed information about interviewees.

Category	Content	N	Percentage
Education level	Doctorate	5	2.8%
	Master's	72	40.5%
	Undergraduate	93	52.2%
	High School and Below	8	4.5%
Sex	Male	106	59.6%
	Female	72	40.4%
Years of work experience in Internal Control Department	<10 years	28	15.7%
	10–15 years	62	34.9%
	15–20 years	68	38.2%
	>20 years	20	11.2%

### 3.2. Research Design and Operational Procedure of the Decision-Making Model

In prior studies, most hypothetical performance evaluation models consider the evaluation dimensions and criteria to be independent. However, there are mutual interactions between the evaluation dimensions and criteria [65,68]. Hwang and Yoon [69] noted that the MADM is able to simultaneously consider multiple attributes of the research topic to help decision-makers evaluate each alternative, to set priorities according to specific characteristics, and to finally select the best solution. Nekhili et al. [70] also pointed out that the relationships between CSR and internal control variables are more complex and less linear than many scholars have assumed. Therefore, MADM is a very suitable technique that can be used to solve the dynamic problems that arise in the evaluation of the social sustainability internal control performance in the real world.

In this approach, the DEMATEL (Decision Making Trial and Evaluation Laboratory) technique, the DEMATEL-based Analytic Network Process (DANP), and the modified VlseKriterijumska Optimizacija I Kompromisno Resenje (VIKOR) method are included. The multiple attribute decision making (MADM) method combined with these three analytical techniques can not only prioritize the criteria based on the intensity of their interrelations but also identify the root of the problem to help formulate optimal improvement strategies, in turn facilitating effective resource allocation and continuous, dynamic improvement targeting the needs of the sustainability objective of internal control conditions.

The detailed operational procedure of the decision-making model is divided into three phases based on the three analytical techniques. The calculations involved in each phase are illustrated in Figure 2. First, the DEMATEL technique is used to construct an influential network relation map (INRM) to show the relationships among these evaluation dimensions and criteria.

The DEMATEL technique was developed for the purpose of explaining specific societal problems based on a network relation diagram and a structural model. The DEMATEL can clarify the interrelations among criteria, thereby lifting the restriction imposed by the assumption in conventional analytical techniques that the assessment criteria are independent of one another [71]. In addition, DEMATEL can perform prioritization and standard selection despite conflicts among the attributes. It can also use the ideal standard as a benchmark rather than a relative standard to avoid having to select the best option out of a bad batch. Last, but not least, from the results obtained by executing the DEMATEL one can propose improvement strategies systemically at the source of the impacts. Therefore, these basic concepts are used to create a series of new hybrid MCDM models to solve complex and dynamic real-world problems [72–75]. The details of DEMATEL are shown in Appendix A.

After building an influential network relation map with DEMATEL, the DANP technique is used to obtain the influential weights. First, the total influence matrix  $T$  was vertically partitioned according to different dimensions. The criteria under each dimension are added up horizontally. Afterward, each criterion in the partitioned matrix is divided by the horizontal sum of the dimension



to which it belongs to obtain the normalized matrix  $T_C^x$ . Eventually, the limit supermatrix is computed by multiplying the weighted supermatrix  $W$  by itself to achieve a convergent and stable matrix  $W^x$ . The ANP combined with the DEMATEL can provide the DANP influential weights (also call the “global weights”), thereby resolving the interdependence issue, making this technique more appropriate for real world applications. The DANP is described in detail in Appendix B.

Finally, a modified VIKOR approach is adopted to evaluate the socially sustainable internal control performance for continuous improvement. Opricovic and Tzeng [10] developed the VIKOR approach, which solves MADM problems when conflicting criteria are present. The VIKOR method uses the class distance function based on the idea of an aspired level to a worst level to rank all the solutions [76,77]. The modified VIKOR is not only applied to rank and select optimal alternatives but is also used for performance gap improvement among the criteria and their dimensions, even for the overall performance gap. Thus, this new model provides more accurate information about the gap between the current sustainability performance in the empirical cases and the target level. This information can help decision makers understand the sustainability performance in empirical situations covering the range from the target level to the tolerable level for all dimensions and criteria. The details of the modified VIKOR are presented in Appendix C.

A diagram of the socially sustainable internal control performance evaluation method is illustrated in Figure 2.

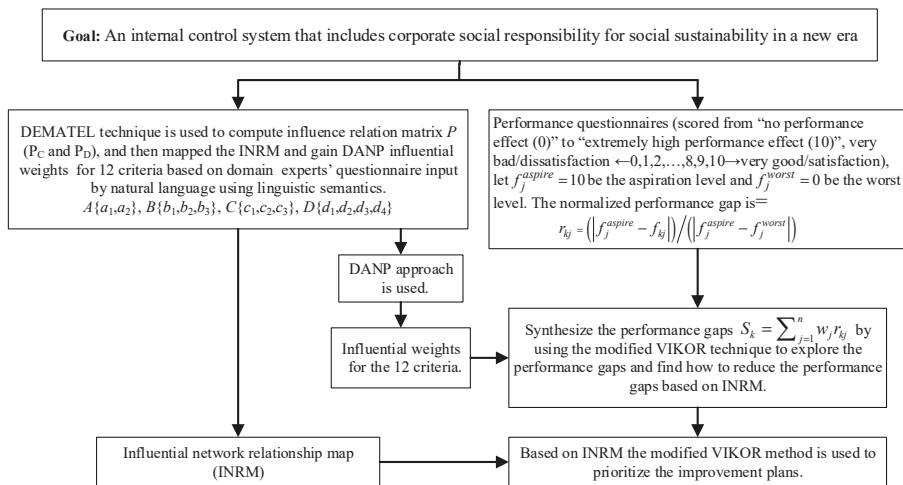

Figure 2. Flowchart for evaluation of sustainable internal control performance.

#### 4. Empirical Analysis of Sustainable Internal Control Performance

This paper first discusses the relationship between the dimensions and criteria for sustainable internal control performance obtained by using the DEMATEL technique, based on the questionnaire results from domain experts. Second, the DANP method is used to determine the weights of these evaluation criteria. Lastly, the author applies the influential weights calculated above for empirical analysis of case studies and employs the modified VIKOR method to evaluate the overall performance gap of the case companies' sustainability performance and to identify priorities for improvement strategies based on INRM. The results of DEMATEL for Analyzing the Relationships Between Dimensions and Criteria are obtained as shown in Appendix D.

Zhu and Sun [56] concluded that there are several advantages to using a mixed multi-criterial decision analysis model: DEMATEL can clarify the interrelations among criteria, thereby lifting the restriction imposed by the assumption in conventional analytical techniques that the assessment



criteria are independent of one another; prioritization and selection of criteria can be carried out despite any conflicts among the attributes; using the ideal standard as the benchmark instead of a relative standards one can avoid selecting the best option out of a bad batch; this model can be used to systematically propose improvement strategies at the source of the impacts.

As shown in Table 3, the sum of the influence of each dimension and criterion can be derived by applying Equations (A5) and (A6) in DEMATEL's step 3. INRM in Figure 3 illustrates the influential network-relationship from the 4 dimensions and the subsystem of the CSR-oriented internal control system. According to the value of influence given  $d_i - r_i$ , operational performance (A) is influenced by reliable financial reporting (B), compliance with laws, regulations and policies (C), and corporate social responsibility-oriented (D), because the  $d_i - r_i$  value of operational performance (A) is negative and a minimum (−1.263). The dimensions with positive values of  $d_i - r_i$  have great influence on the other dimensions. Meanwhile, the sum of the compliance with laws, regulations and policies (C) has the highest value with  $d_i + r_i$  (3.086) while the sum of operational performance has the lowest value with  $d_i + r_i$  (2.112).

The criteria with negative values of  $d_i - r_i$  are greatly influenced by the other criteria. A significantly positive value of  $d_i - r_i$  represents that this criterion affects the other criteria much more than the other criteria affect it, which means it should be given priority for improvement. In turn, reliable financial reporting (B) is influenced by compliance with laws, regulations and policies (C) and corporate social responsibility-oriented (D), whereas compliance with laws, regulations and policies (C) is influenced by corporate social responsibility-oriented (D). Thus, to improve the dimension of operational performance (A), improvements to reliable financial reporting (B), compliance with laws, regulations and policies (C), and corporate social responsibility-oriented (D) should be emphasized. In turn, to improve the dimension of reliable financial reporting (B), improvements to compliance with laws, regulations and policies (C) and corporate social responsibility-oriented (D) should be emphasized. Finally, it should be noted that corporate social responsibility-oriented (D) with a maximum value of  $d_i - r_i$  (1.309) has the most influence on the other dimensions. Therefore, Figure 3 illustrates the priority of influence of the four dimensions from four perspectives which are, in order corporate social responsibility-oriented (D), compliance with laws, regulations and policies (C), reliable financial reporting (B), and operational performance (A).

**Table 3.** Sum of the influences and ranking of each dimension and criterion.

Dimensions and Criteria ( <i>i</i> )	Row Sum ( $d_i$ )	Column Sum ( $r_i$ )	$d_i + r_i$	$d_i - r_i$	Ranking
Operational effectiveness and efficiency (A)	0.424	1.688	2.112	−1.263	
a <sub>1</sub> Effectiveness	0.276	1.717	1.993	−1.442	1
a <sub>2</sub> Efficiency	0.188	1.707	1.895	−1.519	2
Reliable financial reporting (B)	1.208	1.522	2.730	−0.314	
b <sub>1</sub> Representational faithfulness	0.981	1.694	2.675	−0.713	3
b <sub>2</sub> Verifiability	1.436	1.704	3.140	−0.267	1
b <sub>3</sub> Neutrality	1.251	1.666	2.917	−0.415	2
Compliance with laws, regulations and policies (C)	1.677	1.409	3.086	0.269	
c <sub>1</sub> Awareness of regulations	1.647	1.353	3.000	0.294	1
c <sub>2</sub> Transparency of operations	1.326	1.538	2.864	−0.213	3
c <sub>3</sub> Compliance controls	1.633	1.465	3.097	0.168	2
Corporate social responsibility oriented (D)	2.147	0.838	2.985	1.309	
d <sub>1</sub> Financial or Stewardship	1.917	1.238	3.155	0.679	4
d <sub>2</sub> Customer/Stakeholder	2.476	0.991	3.467	1.485	1
d <sub>3</sub> Internal processes	2.064	1.207	3.271	0.857	3
d <sub>4</sub> Learning and growth	2.177	1.092	3.270	1.085	2

Table 3 and Figure 3 show the results of the analysis of each criterion. It can be seen that in the dimension of operational performance (A), effectiveness (a1) is the most important criterion ( $d_i - r_i = -1.442$ ), whereas efficiency (a2) is the least influential ( $d_i - r_i = -1.519$ ). Management that pursues efficiency will attach greater importance to maintaining internal stability and the status quo; while management that pursues effects will attach more importance to external changes and

pursues innovation. However, it is often difficult for companies to maintain a balance between the two. In terms of the difference between “efficiency” and “effectiveness”, the former refers to “do things right” while the latter refers to “do the right thing.” Now management is paying more attention to effectiveness. The pursuit of effectiveness must be concerned with change. For corporate social responsibility, companies can not only increase economic effects, but also attract additional external benefits to the company. Thus, effectiveness is the most important criterion in the dimension of operational performance.

In the dimension of reliable financial reporting (B), verifiability (b2) is the most important criterion ( $d_i - r_i = -0.267$ ), whereas representational faithfulness (b1) is the least influential ( $d_i - r_i = -0.713$ ). With consideration of cost-effectiveness and importance, for information to be faithfully expressed or reasonably presented, it must be considered reliable. Whether or not it is reliable is determined as follows: first of all, information must be verifiable, and accounting information must not be affected by the personal biases of the measurer. Second, for the selection or disclosure of accounting principles or policies, the accounting information generated should be crucial in nature. It should faithfully express the economic reality rather than merely focusing on economic consequences. Accounting-related information should not be manipulated. In this way, the information required by the internal control system for planning, supervision, etc. can be obtained or revealed in a timely manner and provided to all stakeholders. The effectiveness of the information and communication systems will affect the effectiveness of the internal control systems.

In the dimension of compliance with laws, regulations and policies (C), awareness of regulations (c1) is the most important criterion ( $d_i - r_i = 0.294$ ), whereas transparency of operations (c2) is the least influential criterion ( $d_i - r_i = -0.213$ ). As part of a social organization, a company’s operations should comply with the laws and regulations of the state and there is a basic obligation for the company to fulfill its social responsibilities. Internal control, from the perspective of auditing, is meant to ensure that enterprises fulfill basic social obligation. The starting point for internal control of auditing is to be aware of relevant laws and regulations and to implement effective compliance control. Enterprises spontaneously implement measures for internal control and strive to comply with national laws. On the one hand, they want to reduce their own legal risks while on the other hand, fulfill their basic corporate responsibilities and obligations to society. Through the establishment of coordinated internal control mechanisms, enterprises can fulfill their contractual goals as well as their social responsibilities for a harmonious society.

In the dimension of corporate social responsibility-oriented (D), customer/stakeholder (d2) is the most important criterion with a stronger influential effect ( $d_i - r_i = 1.485$ ), whereas financial or stewardship (d1) is the least influential criterion ( $d_i - r_i = 0.679$ ). From the perspective of corporate social responsibility, customers are also viewed as stakeholders that need to be satisfied in addition to the company’s shareholders. Therefore, in addition to meeting the expectations and vision of shareholders, companies need to actively fulfill their social responsibilities. In order to improve operations and assist the board of directors and management to fulfill their responsibilities, the company should facilitate the learning and growth of employees, establish a complete internal control system and internal processes, and ensure the effective use of finances and resources.

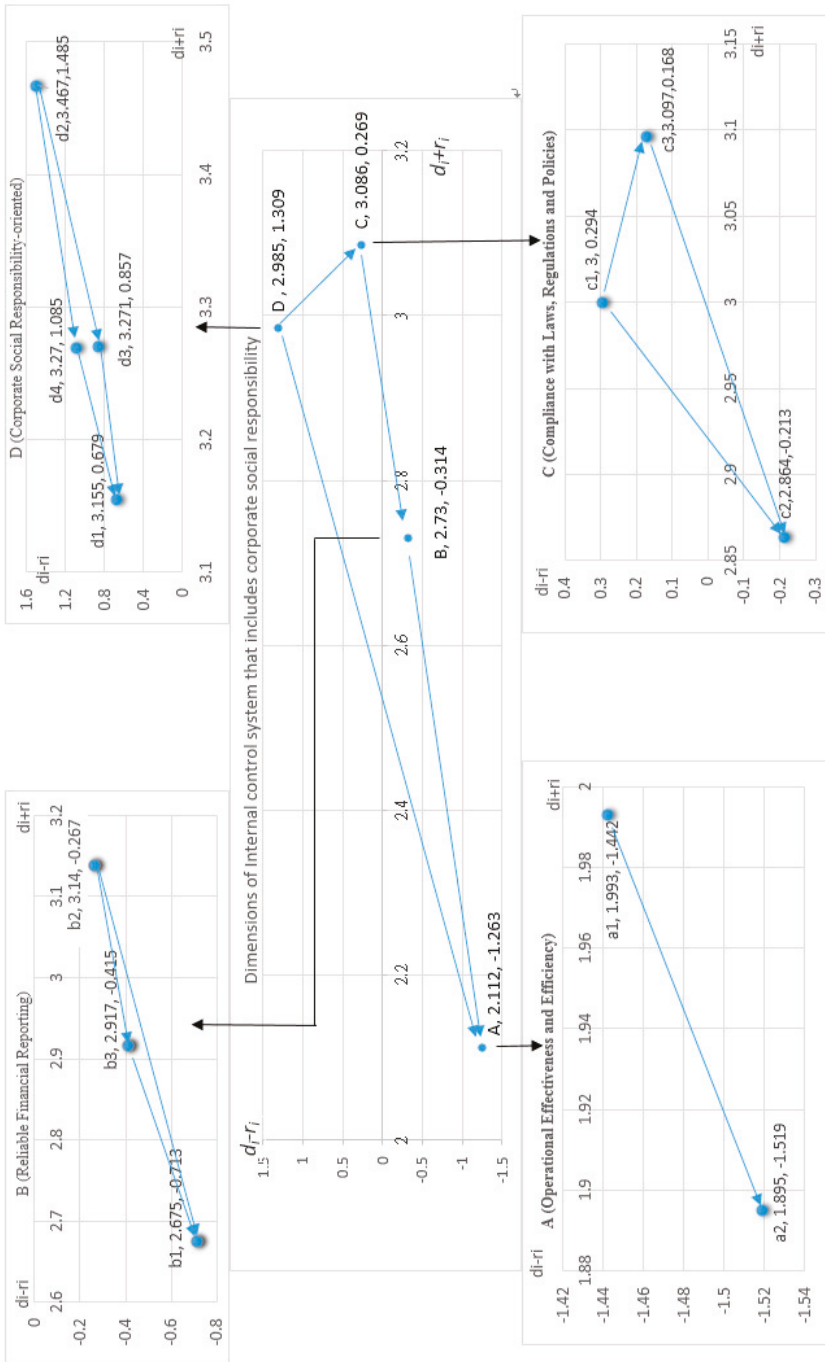

Figure 3. Maps of the influential network relations of each dimension and criterion.

4.1. Using DANP for Calculating the Weights of the Criteria

In the next section, we expect to obtain the most accurate influential weights after confirming the influential relationships among the criteria. By utilizing a combination of the DEMATEL and ANP methods, the influential weights of DANP for each criterion can be obtained as shown in Table 4. The DANP approach allows us to derive the local weights of the assessment factors at their respective hierarchical levels and global weights, which helps us understand the absolute weights of individual criteria across all four dimensions. The DEMATEL total influence-relation matrix is used to construct the weighted supermatrix by applying Equations (A10) and (A11) in DANP’s step 2. The weighted supermatrix for each criterion can be obtained by applying Equations (A8) and (A14). Consequently, the limit supermatrix is used to obtain the global weights of the elements, which are applied to the modified VIKOR approach to evaluate the sustainability performance of the case companies.

**Table 4.** Influential weights of decision making trial and evaluation laboratory-based analytical network process (DANP) for each criterion obtained by  $\lim_{h \rightarrow \infty} (W^h)$ .

Dimension	Criteria	Weight	Rank
A Operational performance	a1 Effectiveness	0.02412	11
	a2 Efficiency	0.02047	12
B Financial reporting	b1 Representational faithfulness	0.04260	8
	b2 Verifiability	0.03825	9
	b3 Neutrality	0.02436	10
C Compliance with regulations	c1 Awareness of Regulations	0.08377	5
	c2 Transparency of operations	0.04561	7
	c3 Compliance controls	0.06647	6
D Corporate social responsibility	d1 Financial or Stewardship	0.10967	4
	d2 Customer/Stakeholder	0.21766	1
	d3 Internal processes	0.18040	2
	d3 Learning and growth	0.14662	3

4.2. Performance Measurement of Empirical Cases

The compromise ranking method is an applicable technique that not only assists researchers to evaluate the overall performance gap in empirical cases’ sustainability performance of CSR-oriented internal control system, but also to identify and prioritize improvement strategies. The evaluation results of the modified VIKOR method are obtained as a performance matrix as shown in Appendix E.

The values of  $S_j$ ,  $R_j^{mod}$ , and  $Q_j^{mod}$  are computed by selecting  $v = 0.5$  based on Equations (A16) and (A17) and the results are shown in Table 5. The values of “concordance” ( $S_j$ ) and “discordance” ( $R_j^{mod}$ ) represent the group utility and the individual regret measures, respectively, for alternative  $a_j$ . From this table, it can be seen that the values of  $S_j$  are (A1, A2, A3, A4, A5, A6, A7) = (0.337, 0.272, 0.142, 0.326, 0.341, 0.314, 0.576, respectively), with the ranking of  $A_1 \succ A_3 \succ A_5 \succ A_4 \succ A_2 \succ A_7 \succ A_6$ ; the values of  $R_j^{mod}$  are (A1, A2, A3, A4, A5, A6, A7) = (0.500, 0.500, 0.250, 0.500, 0.500, 0.550, 0.750, respectively), with the ranking of  $A_2 = A_3 = A_5 \succ A_1 \succ A_4 \succ A_7 \succ A_6$ . In addition, the values of  $Q_j^{mod}$  are (A1, A2, A3, A4, A5, A6, A7) = (0.419, 0.386, 0.196, 0.413, 0.420, 0.432, 0.663, respectively). Therefore, the empirical cases are ranked as follows:  $A_3 \succ A_5 \succ A_1 \succ A_2 \succ A_4 \succ A_7 \succ A_6$ , where  $A \succ B$  means the A is preferred to B. If an alternative is the closest to the ideal solution, it has the smallest value of  $Q_j^{mod}$ . Meanwhile, a compromise solution could be accepted by the decision-makers because it provides the maximum “group utility” (measure  $S_j$  represents “concordance”), and a minimum of individual regret of the “opponents” (measure  $R_j^{mod}$  represents “discordance”) [78]. The results show the A3 has the best performance overall and is the closest to the ideal point. The performance variance rate of A3 is 0.196 indicating that there are still some gaps (0.196) to the goal value (0). In contrast, A7 is the farthest from the ideal solution, because of its larger  $Q_j^{mod}$  value (0.663) than the others.

Given these results, conditions C1 and C2 are satisfied. Hence, A3 has an acceptable advantage; in other words,  $Q[2] - Q[1] = 0.19 \geq DQ = 0.077$ . In addition, A3 is stable within the decision-making process; in other words, it also has the best rank in  $R[\cdot]$ . Therefore, A3 is the best alternative among the seven empirical cases. There are no other compromise solutions in these case studies.

**Table 5.** Ranking of alternatives for  $v = 0.5$ .

	$S_j$		$R_j^{mod}$		$Q_j^{mod}$	
	Distance	Ranking	Distance	Ranking	Distance	Ranking
A1	0.337	5	0.500	2	0.419	4
A2	0.272	2	0.500	2	0.386	2
A3	0.142	1	0.250	1	0.196	1
A4	0.326	4	0.500	2	0.413	3
A5	0.341	6	0.500	2	0.420	5
A6	0.314	3	0.550	6	0.432	6
A7	0.576	7	0.750	7	0.663	7

## 5. Management Implications and Discussion

Given the importance of the role enterprises play in society, corporate social responsibility is receiving increasing attention in relation to long-term development. Corporate social responsibility is one of the factors that enhance the competitiveness of an enterprise. It contributes to the realization of the long-term economic goals of the enterprise and is key to the company's long-term success under the current socio-economic environment.

The research results from the modified VIKOR method show that the companies in these empirical cases performed poorly in terms of the aspects of corporate social responsibility aspect (D), compliance with regulations (C) and operational performance (A). The average variance rates for these criteria are 0.429–0.157, as shown in Table A5. First, particular attention should be given to the dimension of corporate social responsibility (D) with the criterion of the customer/stakeholder (d2) within this dimension being in most urgent need of improvement. Next, the dimensions of compliance with regulations (C) and operational performance (A) have the second highest variance rate.

With the rapid development of the economy and society, and continuous improvement in the people's quality of life, education, and civilization, consumers have changed from being merely concerned with the satisfaction of their own needs to concern for the future development of society as a whole. Enterprises should therefore be customer-centric, actively thinking about how to combine internal processes, employees' learning and growth, as well as financial and resource allocation, to promote excellence, so that companies can continue to maintain competitiveness and sustainable development.

Secondly, in the dimensions of compliance with regulations, companies have long considered their own interests as having priority, coupled with fear of punishment. Therefore, although there is greater compliance with relevant laws and regulations, the construction of internal controls for social responsibility-oriented self-development is relatively insufficient. In order to fulfill its role as a social organization, enterprises need to conduct on-the-spot inspections and review the company's compliance with regulations on issues such as product safety, environmental safety, labor safety, personal data protection, and corporate social responsibility through the establishment of a harmonious internal control mechanism, especially for major social security incidents in recent years. Enterprises should also expand the scope of their internal control objectives, actively achieve their goals of fulfilling social responsibilities to produce a harmonious society.

Next, within the aspect of business operation performance, the value of the company usually consists of two parts. The first part is corporate value in the traditional sense, that is, the return of value for capital based on the cash flow from assets which reflects the value of the asset's future profitability. The second part is the value of positive externalities brought about by corporate social responsibility.

Enterprises usually only strive to pursue their own interests, to avoid punishment, with less efforts at deriving the positive external effects of social responsibility. For this purpose, companies need to weigh the relationship between the company, the community, and society, to obtain government support, optimize the company's living environment, and actively take care of the interests of all parties, thereby realizing greater social value for the company.

Moreover, business operations mostly focus on short-term operating efficiency, paying little attention to long-term social responsibility; social responsibility is seldom incorporated into management objectives. As a result, the process of operational effectiveness sometimes contradicts the goals set by the company, resulting in a conflict between the company's goals and the stakeholder's goals and vision. Therefore, apart from seeking corporate profits, companies should also actively respond to corporate social responsibilities through technological and managerial innovation, improve environmental protection measures, to bring the company's operating results more in line with the interests of various stakeholders. Finally, the results indicate that within the dimension of financial reporting (B) the company performs relatively well in terms of the criteria representational faithfulness (b1) and verifiability (b2). These two criteria have the second lowest variance rate, but improvement is still needed in order to produce the accounting-related information that stakeholders care about, such as green accounting, environmental investment, carbon emissions, other environmental accounting information, etc.

## **6. Conclusions and Future Research**

In the past, the corporate social responsibility and internal control fields conformed to the development of the enterprise. Each had its own history and development process, forming two independent disciplines each with its own theoretical framework. However, because there is too much emphasis on theory, these disciplines are not compatible with practice, with bottlenecks and problems derived from corporate practice. For example, the theoretical goal of corporate social responsibility cannot be achieved, although the internal control objectives have been reached. The expectations of interested people could not be met. The failure of internal control not only causes the company to suffer great losses, but has also hurts the long-term accumulation of goodwill, along with the loss of related stakeholders.

The goal of internal control is to identify, analyze, and control risks by integrating corporate social responsibility goals into corporate strategic goals. Then, in compliance with regulations, the internal control report on corporate social responsibility (whether individual reports or embedded in the internal control report) is compiled and disclosed, and internal control evaluation reports and audit reports on corporate social responsibility are generated based on the statutory procedures and the company's procedures. Therefore, the company can promote the efficient allocation of various stakeholders' capital and the equitable distribution of equity, and realize the maximization of comprehensive value including the economic, social and environmental benefits to the company. Finally, socially-oriented internal control objectives will promote the harmonious co-existence of enterprises and society and the sustainable development of the company itself.

Effective internal controls can help companies realize the maximization of corporate value; actively shouldering social responsibilities not only helps companies create profits, maximize economic value, but also contributes to the long-term development of the company. As a for-profit organization, it is indeed important for companies to achieve financial goals but these are not the only goals. The goals of internal control can integrate the motivation to pursue profit with social performance from the perspective of a broad-based stakeholder, reduce the waste of resources, and achieve corporate comprehensive social responsibility. Therefore, corporate social responsibility is the driving force for the improvement of internal control. The effectiveness of internal control is the guarantee for the company to fulfill its social responsibility.

In sum, this article uses the management tool of the balanced scorecard, commonly used in the current strategic management theory to incorporate corporate social responsibility into the internal

control objectives, and to synthesize a framework for internal control and corporate social responsibility. Therefore, this method not only can further integrate theory and practice, but can also transform the abstract vision of corporate social responsibility into tangible, concrete and practical goals and measurement indicators. It is hoped that we can achieve comprehensive internal control objectives for the sustainable development of a company.

In addition, this work makes several contributions to the sustainability performance literature. First, the focus is on the sustainability performance of CSR-oriented internal control, which has rarely been studied in the prior literature. Second, this paper establishes a hybrid MCDM model combining DEMATEL with ANP and VIKOR based on BSC to evaluate the sustainability performance of empirical cases. This model is able to illustrate the influential network among the criteria for Taiwanese social sustainability internal control performance, which has been ignored in traditional models that have presumed the dimensions and criteria of sustainability performance to be independent and hierarchical in structure. Furthermore, this model presents the key factors and their weights of CSR-oriented sustainability performance, which were not provided by models in prior internal control performance studies.

This study is of course subject to several limitations. At present, in academic research on the internal control of corporate social responsibility, the main problems are the lack of basic theoretical research, and lack of determination of the interactive mechanism between social responsibility and internal control. The lack of clarity about the interaction directly leads to problems with constructing the theoretical framework. Although, the content of social responsibility is incorporated into the objectives of internal control, the understanding of the concept of sustainable development performance, and the objectives of future internal controls should also be adjusted and developed with changes in the environment. For example, other criteria related to economic, environmental, and social factors should be considered in future. Such considerations will make for more complete, concrete and operational internal control objectives.

In addition, in practice, the construction of the internal control framework for social responsibility is still limited to the development of industries or companies that have already experienced major accidents. There are few studies in other industries or of companies with high social responsibility risks. The lack of systematic and comprehensive research results may weaken the guiding role of the application of theories in practice, and may eventually lead to a disconnect between the development of theory and practice. In the case study herein, this paper investigates only empirical cases in Taiwan. Therefore, further applications of this model and comparative studies can be conducted based on the data of firms or industries from other countries.

Finally, research on the internal control of corporate social responsibility in future will turn to the mechanism for the realization of internal control of social responsibility, control paths, performance evaluation, internal control auditing of social responsibility, and reporting of internal control of social responsibility information. The research of the internal control framework system of social responsibility also highlights the connotation of “social responsibility”. At the same time, the case study of internal control of social responsibility in different industries will also become an important area of research. By promoting the development of internal control of enterprises, and then expanding to other industries, it can eventually be extended to the country, or the appropriate industry to establish an internal framework for supporting the industrial social responsibility.

**Author Contributions:** J.-Y.L. proposed ideas, collected and analyzed the data and wrote the paper.

**Funding:** This research received no external funding.

**Acknowledgments:** The author is extremely grateful to the sustainability journal editorial team and reviewers who provided valuable comments for improving the quality of this article.

**Conflicts of Interest:** The author declares no conflict of interest.



**Appendix A. Building an INRM Using DEMATEL**

The DEMATEL technique comprises three steps as follows:

Step 1. Calculate the direct influence-relation average matrix  $F$  based on the scores. Assume that there are  $P$  CPA experts and  $n$  criteria who are asked to make pairwise comparisons between any two criteria expressed as an integer score from 0 to 4, ranging from “absolutely no influence (0)” to “very high influence (4)” and showing the degree of influence that each criterion  $i$  has on each criterion  $j$ . Each domain expert questionnaire forms an  $n \times n$  non-negative matrix  $X^p = [x_{ij}^p]_{n \times n}$ ,  $p = 1, 2, \dots, P$ , where  $X^1, \dots, X^p, \dots, X^P$  are the response matrices for  $P$  domain experts. The elements of  $X^p$  are denoted by  $x_{ij}^p$  from domain expert  $p$ . Thus, an  $n \times n$  average matrix  $F$  for all domain experts can be built by using Equation (A1):

$$F = \begin{bmatrix} f_{11} & \cdots & f_{1j} & \cdots & f_{1n} \\ \vdots & & \vdots & & \vdots \\ f_{i1} & \cdots & f_{ij} & \cdots & f_{in} \\ \vdots & & \vdots & & \vdots \\ f_{n1} & \cdots & f_{nj} & \cdots & f_{nn} \end{bmatrix} \tag{A1}$$

The average scores from the  $P$  domain experts are  $f_{ij} = \frac{1}{P} \sum_{p=1}^P x_{ij}^p$ . The average matrix, the “initial direct relation matrix  $F$ ”, represents the degree of influence of one criterion on another criterion, and the degree of influence from the other criteria.

Step 2. Normalize the initial direct-influence relation average matrix  $F$ . The normalized initial direct influence relation matrix  $Y$  can be obtained by normalizing the average matrix  $F$ . Matrix  $Y$  can be derived from Equations (A2) and (A3). All principal diagonal criteria are equal to zero:

$$Y = s \cdot F \tag{A2}$$

$$s = \min \left\{ \frac{1}{\max_{1 \leq i \leq n} \sum_{j=1}^n f_{ij}}, \frac{1}{\max_{1 \leq j \leq n} \sum_{i=1}^n f_{ij}} \right\} \tag{A3}$$

Step 3. Construct the total influence-relation matrix  $P$ . A continuous decrease in the indirect effects of problems moves with the powers of matrix  $Y$ , e.g.,  $Y^2, Y^3, \dots, Y^\infty$ , and  $\lim_{k \rightarrow \infty} Y^k = [0]_{n \times n}$ , for  $\lim_{k \rightarrow \infty} (I + Y + Y^2 + \dots + Y^k) = (I - Y)^{-1}$ , where  $I$  is an  $n \times n$  unit matrix. The total influence-relation matrix  $P$  is an  $n \times n$  matrix, and is defined by  $P = [t_{ij}]_{n \times n}$ ,  $i, j = 1, 2, \dots, n$  as shown in Equation (A4).

$$\begin{aligned} P &= Y + Y^2 + \dots + Y^k \\ &= Y(I + Y^2 + \dots + Y^{k-1}) \\ &= Y(I + Y^2 + \dots + Y^{k-1})(I - Y)(I - Y)^{-1} \\ &= Y(I - Y)^{-1}, \text{ when } \lim_{k \rightarrow \infty} Y^k = [0]_{n \times n} \end{aligned} \tag{A4}$$

The total influence relation matrix  $P$  of the INRM can be derived from Equations (A4)–(A6) to generate the sums of each column and row in matrix  $P$ .

$$d = (d_i)_{n \times 1} = \left[ \sum_{j=1}^n t_{ij} \right]_{n \times 1} = (d_1, \dots, d_i, \dots, d_n)' \tag{A5}$$







Step 3. Derive the weighted supermatrix  $W^\alpha$ . The total influence-relation matrix  $P_D$  of the dimensions is obtained according to the DEMATEL method, as given by Equation (A12):

$$P_D = \begin{bmatrix} p_D^{11} & \cdots & p_D^{1j} & \cdots & p_D^{1n} \\ \vdots & & \vdots & & \vdots \\ p_D^{i1} & \cdots & p_D^{ij} & \cdots & p_D^{in} \\ \vdots & & \vdots & & \vdots \\ p_D^{n1} & \cdots & p_D^{nj} & \cdots & p_D^{nn} \end{bmatrix} \tag{A12}$$

The normalized total influence-relation matrix  $P_D^\alpha$  of the dimensions can be derived from the total influence-relation matrix  $P_D$  divided by  $\sum_{j=1}^n p^{ij} = p^i, i = 1, 2, \dots, n$ , as shown in Equation (A13).

$$P_D^\alpha = \begin{bmatrix} p_D^{11}/p_1 & \cdots & p_D^{1j}/p_1 & \cdots & p_D^{1n}/p_1 \\ \vdots & & \vdots & & \vdots \\ p_D^{i1}/p_i & \cdots & p_D^{ij}/p_i & \cdots & p_D^{in}/p_i \\ \vdots & & \vdots & & \vdots \\ p_D^{n1}/p_n & \cdots & p_D^{nj}/p_n & \cdots & p_D^{nn}/p_n \end{bmatrix} = \begin{bmatrix} p_D^{\alpha 11} & \cdots & p_D^{\alpha 1j} & \cdots & p_D^{\alpha 1n} \\ \vdots & & \vdots & & \vdots \\ p_D^{\alpha i1} & \cdots & p_D^{\alpha ij} & \cdots & p_D^{\alpha in} \\ \vdots & & \vdots & & \vdots \\ p_D^{\alpha n1} & \cdots & p_D^{\alpha nj} & \cdots & p_D^{\alpha nn} \end{bmatrix} \tag{A13}$$

The normalized  $P_D^\alpha$  and the un-weighted supermatrix  $W$  (shown in Equation (A11)), and the weighted supermatrix  $W^\alpha$  (normalized supermatrix) can be easily obtained by Equation (A14).

$$W^\alpha = P_D^\alpha \times W = \begin{bmatrix} p_D^{\alpha 11} \times W^{11} & \cdots & p_D^{\alpha i1} \times W^{i1} & \cdots & p_D^{\alpha n1} \times W^{n1} \\ \vdots & & \vdots & & \vdots \\ p_D^{\alpha 1j} \times W^{1j} & \cdots & p_D^{\alpha ij} \times W^{ij} & \cdots & p_D^{\alpha nj} \times W^{nj} \\ \vdots & & \vdots & & \vdots \\ p_D^{\alpha 1n} \times W^{1n} & \cdots & p_D^{\alpha in} \times W^{in} & \cdots & p_D^{\alpha nn} \times W^{nn} \end{bmatrix} \tag{A14}$$

Step 4. Calculate the limit supermatrix  $W^\alpha$ . Limit the weighted supermatrix by raising it to the  $k$ th power, until the supermatrix has converged and become stable. The global priority vectors, known as the DANP influential weights, are derived, such as in  $\lim_{h \rightarrow \infty} (W^\alpha)^h$ , where  $h$  represents any power number.

**Appendix C. Measuring the Satisfaction Performance by the Modified VIKOR**

The compromise ranking method (VIKOR) had been introduced as a technique within the MCDM [76]. The data matrix of the VIKOR method is expressed in Table A1.

As shown in Table A1,  $a_j$  represents the  $j$ th alternative,  $j = 1, 2, \dots, m$ ;  $c_i$  represents the  $i$ th criterion,  $i = 1, 2, \dots, n$ ;  $w_i$  represents the weight of the  $i$ th criterion,  $i = 1, 2, \dots, n$ ; and  $x_{ij}$  indicates the performance of alternative  $a_j$  with respect to the  $c_i$  criterion. A large  $x_{nm}$  is better than a small one. The VIKOR method included the following steps:

**Table A1.** Data matrix of weights and performance scores.

Criteria	Weights	Alternatives					Max <sub>j</sub>	Min <sub>j</sub>
		a <sub>1</sub>	⋯	a <sub>j</sub>	⋯	a <sub>m</sub>		
c <sub>1</sub>	w <sub>1</sub>	x <sub>11</sub>	⋯	x <sub>1j</sub>	⋯	x <sub>1m</sub>	x <sub>1</sub> <sup>*</sup>	x <sub>1</sub> <sup>-</sup>
⋮	⋮	⋮		⋮		⋮	⋮	⋮
c <sub>i</sub>	w <sub>i</sub>	x <sub>i1</sub>	⋯	x <sub>ij</sub>	⋯	x <sub>im</sub>	x <sub>i</sub> <sup>*</sup>	x <sub>i</sub> <sup>-</sup>
⋮	⋮	⋮		⋮		⋮	⋮	⋮
c <sub>n</sub>	w <sub>n</sub>	x <sub>n1</sub>	⋯	x <sub>nj</sub>	⋯	x <sub>nm</sub>	x <sub>n</sub> <sup>*</sup>	x <sub>n</sub> <sup>-</sup>

Step 1: Determining the best rating  $x_i^*$  and the worst rating  $x_i^-$  for all the criteria. Table A1 shows that the criterion  $i$  represents a benefit, then  $x_i^* = \max_j x_{ij}$ ,  $x_i^- = \min_j x_{ij}$ . Naturally, a candidate having the scores  $(x_1^*, x_2^*, \dots, x_n^*)$  would be positive-ideal whereas a candidate having scores of  $(x_1^-, x_2^-, \dots, x_n^-)$  would be an negative-ideal candidate. It is assumed that such an ideal candidate does not exist; otherwise the decision would be trivial.

Step 2: Computing the values of “concordance” ( $S_j$ ) and “discordance” ( $R_j$ ). They represent the group utility and the individual regret measures for the alternative  $a_j$ , respectively, with the relations

$$D_j^{p=1} = S_j = \sum_{i=1}^n w_i [(x_i^* - x_{ij}) / (x_i^* - x_i^-)], \text{ for } j = 1, \dots, m; \tag{A15}$$

$$D_j^{p=\infty} = R_j = \max_i \{w_i [(x_i^* - x_{ij}) / (x_i^* - x_i^-)] | i = 1, 2, \dots, n\}, \text{ for } j = 1, \dots, m, \tag{A16}$$

where the weights of the criteria ( $w_i$ ) are introduced to express the relative importance of the criteria computed by the ANP method.  $D_j^{p=1}$  represents the maximum “group utility” of the “majority”.  $D_j^{p=\infty}$  represents the minimum individual regret of the “opponent”. According to Equations (1) and (2), the VIKOR result stands only for a given set of alternatives. Inclusion (or exclusion) of an alternative could affect the VIKOR ranking of the new set of alternatives. This effect could be avoided by fixing an ideal solution [9]. Thus, in this study we adopt a fixed ideal solution (i.e., the best  $x_i^*$  value = 100 and the worst  $x_i^-$  value = 0).

Step 3: Computing the aggregate value ( $Q_j$ ). The formula is

$$Q_j = v [(S_j - S^*) / (S^- - S^*)] + (1 - v) [(R_j - R^*) / (R^- - R^*)], \text{ for } j = 1, \dots, m, \tag{A17}$$

where  $S^* = \min_j S_j$ ,  $S^- = \max_j S_j$  and  $R^* = \min_j R_j$ ,  $R^- = \max_j R_j$ ; and  $v$  is the weight of the decision-making strategy for “the majority of criteria” (or “the maximum group utility”), whereas  $1 - v$  is the weight of the individual regret. A compromise can be selected by “voting by majority” ( $v > 0.5$ ), with “consensus” ( $v = 0.5$ ), or with “veto” ( $v < 0.5$ ). The VIKOR index ( $Q_j$ ) is obtained by weighing the utility and regret measures of each alternative.

Step 4: Alternatives are ranked by sorting the  $S$ ,  $R$  and  $Q$  values in increasing order. The result is a set of three ranking lists denoted as  $S^{[1]}$ ,  $R^{[1]}$  and  $Q^{[1]}$ .

Step 5: Proposing alternative  $a^{(1)}$  corresponding to  $Q^{[1]}$  (the smallest among the  $Q_j$  values) as a compromise solution. It must satisfy the following two conditions:

**Axiom 1.** Alternative  $a^{(1)}$  has an acceptable advantage; in other words,  $Q^{[2]} - Q^{[1]} \geq DQ$  where  $DQ = 1/(m - 1)$  and  $m$  is the number of alternatives ( $DQ = 0.25$  if  $m \leq 4$ ).

**Axiom 2.** Alternative  $a^{(1)}$  is stable within the decision-making process; in other words, it is also the best ranked in  $S^{[1]}$  or/and  $R^{[1]}$ .

If one of the above conditions is not satisfied, then a set of compromise solutions is proposed, which consists of:

- Alternatives  $a^{(1)}$  and  $a^{(2)}$  if only Axiom 1 is not satisfied, or
- Alternatives  $a^{(1)}, a^{(2)}, \dots, a^{(k)}$  if Axiom 1 is not satisfied; and  $a^{(k)}$  is determined by the relation  $Q^{[k]} - Q^{[1]} \approx DQ$  (the positions of these alternatives are “in closeness”).

The best alternative ranked by  $Q_j$ , is the one with the minimum value of  $Q_j$ . The compromise solution can be accepted by the decision-makers because it provides a maximum “group utility” for the “majority” (with measure  $S_j$  representing “concordance”), and a minimum individual regret for the “opponents” (with measure  $R_j$  representing “discordance”).

In the original VIKOR method, the values of  $S^*$ ,  $S^-$ ,  $R^*$ , and  $R^-$  came from the candidate alternatives. They were not the real positive-ideal or negative-ideal values for all criteria. In fact, the positive-ideal should be represented by a score of 100 and the negative-ideal point should be represented by a score of 0; therefore, the positive-ideal value ( $S^*$ ) would be zero; the negative-ideal value ( $S^-$ ) would be equal to one; the positive-ideal value ( $R^*$ ) would be zero, and the negative-ideal value ( $R^-$ ) would be equal to one. Besides, it is not necessary to include the weight ( $w_i$ ) in the  $R_j$  equation. To improve the measurement of the VIKOR index, we propose a modified VIKOR method. The weights ( $w_i$ ) are removed from the equation for  $R_j$ . The modified  $R_j^{mod}$  index and  $Q_j^{mod}$  are formulated as follows:

$$R_j^{mod} = \max\{[(x_i^* - x_{ij}) / (x_i^* - x_i^-)] | i = 1, 2, \dots, n\}, \text{ for } j = 1, \dots, m; \tag{A18}$$

$$Q_j^{mod} = v[(S_j - 0) / (1 - 0)] + (1 - v)[(R_j^{mod} - 0) / (1 - 0)] \tag{A19}$$

Then,  $Q_j^{mod}$  is simplified as follows:

$$Q_j^{mod} = vS_j + (1 - v)R_j^{mod} \tag{A20}$$

In the original VIKOR method, the value of  $Q_j$  for the best alternative would be zero or close to zero and the value of  $Q_j$  for the worst alternative would be one or close to one. The  $Q_j$  cannot indicate how many variances between  $Q_j$  and the aspiration level, but the modified  $Q_j^{mod}$  index can overcome this drawback. It was worth noting that the value of  $DQ$  should be changed to  $DQ^{mod} = (\max_j Q_j^{mod} - \min_j Q_j^{mod}) / (m - 1)$  in the modified VIKOR method. The other conditions are the same as the conditions used for the original VIKOR method.

**Appendix D. The Results of DEMATEL for Analyzing the Relationships between Dimensions and Criteria**

According to the methodology described above, a  $12 \times 12$  average initial direct-influence matrix  $T$ , including 12 criteria, can be derived based on the data collected by respondents. The normalization matrix shown in Table A2 can be obtained by applying Equations (A2) and (A3) in DEMATEL’s step 2.

As shown in Table A3, the total influence-relation matrix of the criteria can be derived through Step 3 of DEMATEL on the basis of the normalization impact matrix described above.

The total influence matrix  $P_d$  for each dimension/criterion is derived in Table A4. Table A4 shows the results that four dimensions/criteria, namely operational performance (A), reliable financial reporting (B), compliance with laws, regulations and policies (C), and corporate social responsibility-oriented (D) are mutually influential.

Table A2. Normalization matrix Y.

Criteria	a <sub>1</sub>	a <sub>2</sub>	b <sub>1</sub>	b <sub>2</sub>	b <sub>3</sub>	c <sub>1</sub>	c <sub>2</sub>	c <sub>3</sub>	d <sub>1</sub>	d <sub>2</sub>	d <sub>3</sub>	d <sub>4</sub>
a <sub>1</sub>	0.000	0.081	0.014	0.010	0.009	0.008	0.007	0.007	0.005	0.004	0.004	0.004
a <sub>2</sub>	0.032	0.000	0.010	0.007	0.006	0.006	0.006	0.005	0.005	0.004	0.004	0.004
b <sub>1</sub>	0.058	0.050	0.000	0.052	0.055	0.033	0.032	0.035	0.028	0.024	0.032	0.025
b <sub>2</sub>	0.098	0.079	0.102	0.000	0.077	0.044	0.038	0.042	0.042	0.041	0.044	0.040
b <sub>3</sub>	0.072	0.068	0.090	0.062	0.000	0.041	0.039	0.036	0.035	0.033	0.040	0.036
c <sub>1</sub>	0.051	0.046	0.053	0.088	0.087	0.000	0.102	0.115	0.040	0.035	0.036	0.039
c <sub>2</sub>	0.059	0.060	0.077	0.067	0.064	0.035	0.000	0.042	0.039	0.046	0.041	0.037
c <sub>3</sub>	0.074	0.067	0.083	0.122	0.102	0.039	0.098	0.000	0.039	0.031	0.035	0.034
d <sub>1</sub>	0.062	0.056	0.067	0.076	0.075	0.101	0.084	0.090	0.000	0.063	0.058	0.060
d <sub>2</sub>	0.066	0.063	0.067	0.086	0.084	0.101	0.095	0.097	0.101	0.000	0.118	0.121
d <sub>3</sub>	0.069	0.062	0.072	0.080	0.076	0.090	0.083	0.085	0.097	0.067	0.000	0.070
d <sub>4</sub>	0.069	0.067	0.070	0.076	0.072	0.089	0.080	0.082	0.107	0.068	0.111	0.000

Table A3. Total influence-relation matrix of criteria.

Criteria	a1	a2	b1	b2	b3	c1	c2	c3	d1	d2	d3	d4
a1	0.014	0.093	0.026	0.022	0.021	0.017	0.018	0.017	0.013	0.011	0.012	0.012
a2	0.041	0.012	0.020	0.016	0.016	0.014	0.014	0.013	0.011	0.010	0.011	0.010
b1	0.114	0.107	0.057	0.105	0.107	0.076	0.081	0.081	0.067	0.056	0.070	0.060
b2	0.177	0.161	0.176	0.080	0.150	0.106	0.108	0.108	0.098	0.085	0.098	0.089
b3	0.142	0.139	0.156	0.129	0.070	0.095	0.101	0.095	0.084	0.073	0.088	0.079
c1	0.150	0.144	0.152	0.182	0.179	0.074	0.182	0.187	0.107	0.090	0.102	0.098
c2	0.136	0.137	0.150	0.140	0.136	0.094	0.068	0.105	0.093	0.088	0.094	0.085
c3	0.169	0.162	0.176	0.205	0.186	0.109	0.172	0.076	0.102	0.085	0.099	0.091
d1	0.175	0.168	0.178	0.188	0.184	0.183	0.183	0.183	0.082	0.126	0.136	0.130
d2	0.213	0.208	0.213	0.232	0.227	0.215	0.226	0.222	0.205	0.090	0.216	0.208
d3	0.190	0.182	0.192	0.200	0.194	0.183	0.190	0.187	0.179	0.136	0.088	0.145
d4	0.196	0.193	0.197	0.203	0.197	0.188	0.195	0.191	0.195	0.141	0.195	0.085

Table A4. The sum of the effects on dimensions.

Dimensions	A	B	C	D
Operational performance (A)	0.084	0.135	0.121	0.085
Reliable financial reporting (B)	0.390	0.216	0.380	0.222
Compliance with laws, regulations and policies (C)	0.552	0.540	0.271	0.315
Corporate social responsibility-oriented (D)	0.662	0.631	0.638	0.216

## Appendix E. The Evaluation Results of the Modified VIKOR Method

The evaluation results of the modified VIKOR method are obtained as a performance matrix as shown in Table A4. Here, a score of 100 represents the positive-ideal solution ( $x_i^*$ ) and a score of 0 represents the negative-ideal solution ( $x_i^-$ ). As shown in Table A5, A3 had the highest average performance value (88.750) and A7 had the lowest average score (51.667). This performance matrix was calculated using Equation (A15) to obtain performance variance rates between the status quo and the ideal point as shown in Table A6. The last two rows of Table A5 represent simple average variance and weighted average variance of seven empirical cases. As shown in this table, although the simple average variance of A6 is larger than A1 and A2, it performs better than A1 and A2 when using the ANP weights.

**Table A5.** Average performance scores.

Criteria/Case	A <sub>1</sub>	A <sub>2</sub>	A <sub>3</sub>	A <sub>4</sub>	A <sub>5</sub>	A <sub>6</sub>	A <sub>7</sub>	Average
a1 Effectiveness	50.00	80.00	85.00	70.00	75.00	55.00	50.00	66.43
a2 Efficiency	70.00	85.00	90.00	75.00	75.00	75.00	50.00	74.29
b1 Representational faithfulness	90.00	80.00	90.00	90.00	85.00	75.00	80.00	84.29
b2 Verifiability	85.00	80.00	100.00	80.00	85.00	60.00	75.00	80.71
b3 Neutrality	50.00	80.00	90.00	75.00	80.00	70.00	50.00	70.71
c1 Awareness of regulations	80.00	80.00	85.00	90.00	90.00	65.00	75.00	80.71
c2 Transparency	85.00	80.00	90.00	80.00	85.00	50.00	60.00	75.71
c3 Compliance	85.00	75.00	95.00	65.00	90.00	45.00	55.00	72.86
d1 Financial	75.00	75.00	95.00	75.00	50.00	50.00	25.00	63.57
d2 Customer	50.00	75.00	75.00	50.00	50.00	75.00	25.00	57.14
d3 Internal process	50.00	75.00	85.00	75.00	50.00	75.00	25.00	62.14
d4 Learning and growth	75.00	50.00	85.00	50.00	75.00	85.00	50.00	67.14
Average scores	70.42	76.25	88.75	72.92	74.17	65.00	51.67	71.31

**Table A6.** Performance variance rate.

Criteria/Case	A1	A2	A3	A4	A5	A6	A7	Average
a1 Effectiveness	0.500	0.200	0.150	0.300	0.250	0.450	0.500	0.336
a2 Efficiency	0.300	0.150	0.100	0.250	0.250	0.250	0.500	0.257
b1 Representational faithfulness	0.100	0.200	0.100	0.100	0.150	0.250	0.200	0.157
b2 Verifiability	0.150	0.200	0.000	0.200	0.150	0.400	0.250	0.193
b3 Neutrality	0.500	0.200	0.100	0.250	0.200	0.300	0.500	0.293
c1 Awareness of regulations	0.200	0.200	0.150	0.100	0.100	0.350	0.250	0.193
c2 Transparency	0.150	0.200	0.100	0.200	0.150	0.500	0.400	0.243
c3 Compliance	0.150	0.250	0.050	0.350	0.100	0.550	0.450	0.271
d1 Financial	0.250	0.250	0.050	0.250	0.500	0.500	0.750	0.364
d2 Customer	0.500	0.250	0.250	0.500	0.500	0.250	0.750	0.429
d3 Internal process	0.500	0.250	0.150	0.250	0.500	0.250	0.750	0.379
d4 Learning and growth	0.250	0.500	0.150	0.500	0.250	0.150	0.500	0.329
Simple average variance	0.296	0.238	0.113	0.271	0.258	0.350	0.483	0.287
Weighted average variance	0.167	0.147	0.061	0.149	0.155	0.116	0.261	0.151

## References

- Shapiro, B.; Matson, D. Strategies of resistance to internal control regulation. *Acc. Organ. Soc.* **2008**, *33*, 199–228. [CrossRef]
- Borthick, A.F.; Curtis, M.B.; Sriram, R.S. Accelerating the acquisition of knowledge structure to improve performance in internal control reviews. *Acc. Organ. Soc.* **2006**, *31*, 323–342. [CrossRef]
- COSO, Internal Control—Integrated Framework. Committee of Sponsoring Organizations of the Treadway Commission, 1992. Available online: <http://www.sox-online.com/coso-cobit-center/original-coso-framework/> (accessed on 20 September 2018).
- COSO II, Enterprise Risk Management—Integrated Framework. Committee of Sponsoring Organizations of the Treadway Commission, 2004. Available online: <http://www.sox-online.com/coso-cobit-center/coso-framework-2004-version/> (accessed on 20 September 2018).
- COSO III, *Internal Control—Integrated Framework*; Committee of Sponsoring Organizations of the Treadway Commission: New York, NY, USA, 2006.
- Szczepankiewicz, E. Selected Issues in Effective Implementation of the Integrated Risk Management System in an Organization. *Zeszyty Naukowe Uniwersytetu Szczecińskiego. Finanse Rynki Finans. Ubezpiec.* **2011**, *688*, 153–162.
- Szczepankiewicz, E. Zintegrowane zarządzanie ryzykiem (ERM) w przedsiębiorstwie. *Ekon. Org. Przedsiębiorstwa* **2010**, *11*, 37–45.
- Dhaliwal, D.S.; Radhakrishnan, S.; Tsang, A.; Yang, Y.G. Nonfinancial Disclosure and Analyst Forecast Accuracy: International Evidence on Corporate Social Responsibility Disclosure. *Acc. Rev.* **2012**, *87*, 723–759. [CrossRef]
- Vachon, S.; Klassen, R.D. Green project partnership in the supply chain: The case of the package printing industry. *J. Clean. Prod.* **2006**, *14*, 661–671. [CrossRef]
- Opricovic, S.; Tzeng, G.H. Extended VIKOR method in comparison with outranking methods. *Eur. J. Oper. Res.* **2007**, *178*, 514–529. [CrossRef]

11. Bowen, H.R. *Social Responsibilities of the Businessman*; Harper & Row: New York, NY, USA, 1953.
12. Davis, K. The case for and against business assumption of social responsibilities. *Acad. Manag. J.* **1973**, *16*, 312–322.
13. Friedman, M. *Capitalism and Freedom*; University of Chicago Press: Chicago, IL, USA, 1962.
14. Seguí-Mas, E.; Polo-Garrido, F.; Bollas-Araya, H.M. Sustainability Assurance in Socially-Sensitive Sectors: A Worldwide Analysis of the Financial Services Industry. *Sustainability* **2018**, *10*, 2777. [[CrossRef](#)]
15. Malsch, B. Politicizing the expertise of the accounting industry in the realm of corporate social responsibility. *Acc. Organ. Soc.* **2013**, *38*, 149–168. [[CrossRef](#)]
16. Moser, D.V.; Martin, P.R. A Broader Perspective on Corporate Social Responsibility Research in Accounting. *Acc. Rev.* **2012**, *87*, 797–806. [[CrossRef](#)]
17. Bauman, C.W.; Skitka, L.J. Corporate social responsibility as a source of employee satisfaction. *Res. Organ. Behav.* **2012**, *32*, 63–86. [[CrossRef](#)]
18. McWilliams, A.; Siegel, D. Corporate social responsibility: A theory of the firm perspective. *Acad. Manag. Rev.* **2001**, *26*, 117–127. [[CrossRef](#)]
19. Orlitzky, M.; Schmidt, F.L.; Rynes, S.L. Corporate social and financial performance: A meta-analysis. *Organ. Study* **2003**, *24*, 403–441. [[CrossRef](#)]
20. Pelozo, J. The challenge of measuring financial impacts from investments in corporate social performance. *J. Manag.* **2009**, *35*, 1518–1541. [[CrossRef](#)]
21. Kim, H.; Hur, W.M.; Yeo, J. Corporate brand trust as a mediator in the relationship between consumer perception of CSR, corporate hypocrisy, and corporate reputation. *Sustainability* **2015**, *7*, 3683–3694. [[CrossRef](#)]
22. Graves, S.B.; Waddock, S.A. Institutional owners and corporate social performance. *Acad. Manag. J.* **1994**, *37*, 1034–1046.
23. Kim, M.; Kim, B.; Oh, S. Relational Benefit on Satisfaction and Durability in Strategic Corporate Social Responsibility. *Sustainability* **2018**, *10*, 1104. [[CrossRef](#)]
24. Elliott, W.B.; Jackson, K.E.; Peecher, M.E.; White, B.J. The Unintended Effect of Corporate Social Responsibility Performance on Investors' Estimates of Fundamental Value. *Acc. Rev.* **2014**, *89*, 275–302. [[CrossRef](#)]
25. Thoumy, M.; Vachon, S. Environmental projects and financial performance: Exploring the impact of project characteristics. *Int. J. Prod. Econ.* **2012**, *140*, 28–34. [[CrossRef](#)]
26. Wood, D.J. Corporate social performance revisited. *Academy of Management Review* **1991**, *16*, 691–718. [[CrossRef](#)]
27. Sarfraz, M.; Qun, W.; Hui, L.; Abdullah, M.I. Environmental Risk Management Strategies and the Moderating Role of Corporate Social Responsibility in Project Financing Decisions. *Sustainability* **2018**, *10*, 2771. [[CrossRef](#)]
28. Davis, A.K.; Guenther, D.A.; Krull, L.K.; Williams, B.M. Do Socially Responsible Firms Pay More Taxes? *Acc. Rev.* **2016**, *91*, 47–68. [[CrossRef](#)]
29. Hao, D.Y.; Qi, G.Y.; Wang, J. Corporate Social Responsibility, Internal Controls, and Stock Price Crash Risk: The Chinese Stock Market. *Sustainability* **2018**, *10*, 1675. [[CrossRef](#)]
30. Schroeder, J.H.; Shepardson, M.L. Do SOX 404 Control Audits and Management Assessments Improve Overall Internal Control System Quality? *Acc. Rev.* **2016**, *91*, 1513–1541. [[CrossRef](#)]
31. Petrovits, C.; Shakespeare, C.; Shih, A. The Causes and Consequences of Internal Control Problems in Nonprofit Organizations. *Acc. Rev.* **2011**, *86*, 325–357. [[CrossRef](#)]
32. Kopp, L.S.; O'Donnell, E. The influence of a business-process focus on category knowledge and internal control evaluation. *Acc. Organ. Soc.* **2005**, *30*, 423–434. [[CrossRef](#)]
33. Lawson, B.P.; Muriel, L.; Sanders, P.R. A survey on firms' implementation of COSO's 2013 Internal Control-Integrated Framework. *Res. Acc. Regul.* **2017**, *29*, 30–43. [[CrossRef](#)]
34. Harp, N.L.; Barnes, B.G. Internal Control Weaknesses and Acquisition Performance. *Acc. Rev.* **2018**, *93*, 235–258. [[CrossRef](#)]
35. Rezaee, Z. Business Sustainability Research: A Theoretical and Integrated Perspective. *J. Acc. Lit.* **2016**, *36*, 48–64. [[CrossRef](#)]
36. Huang, X.B.; Watson, L. Corporate social responsibility research in accounting. *J. Acc. Lit.* **2015**, *34*, 1–16. [[CrossRef](#)]



37. Weeserik, B.P.; Spruit, M. Improving Operational Risk Management Using Business Performance Management Technologies. *Sustainability* **2018**, *10*, 640. [[CrossRef](#)]
38. Guo, J.; Huang, P.; Zhang, Y.; Zhou, N. The Effect of Employee Treatment Policies on Internal Control Weaknesses and Financial Restatements. *Acc. Rev.* **2016**, *91*, 1167–1194. [[CrossRef](#)]
39. Kaplan, R.S.; Norton, D.P. The balanced scorecard: Measures that drive performance. *Harv. Bus. Rev.* **1992**, *70*, 71–79. [[PubMed](#)]
40. Jassem, S.; Azmi, A.; Zakaria, Z. Impact of Sustainability Balanced Scorecard Types on Environmental Investment Decision-Making. *Sustainability* **2018**, *10*, 541. [[CrossRef](#)]
41. Bhagwat, R.; Sharma, M.K. Performance measurement of supply chain management: A balanced scorecard approach. *Comput. Ind. Eng.* **2007**, *53*, 43–62. [[CrossRef](#)]
42. Kaplan, R.S.; Norton, D.P. Using the balanced scorecard as a strategic management system. *Harv. Bus. Rev.* **1996**, *74*, 75–85.
43. Kaplan, R.S.; Norton, D.P. *The Strategy-Focused Organization*; Harvard Business School Press: Boston, MA, USA, 2001.
44. Ittner, C.; Larker, D.; Randall, T. Performance implications of strategic performance measurement in financial services firms. *Acc. Organ. Soc.* **2003**, *28*, 715–741. [[CrossRef](#)]
45. Figge, F.; Hahn, T.; Schaltegger, S.; Wagner, M. The sustainability balanced scorecard—linking sustainability management to business strategy. *Bus. Strateg. Environ.* **2002**, *11*, 269–284. [[CrossRef](#)]
46. Van der Woerd, F.; van Den Brink, T. Feasibility of a responsive business scorecard—A pilot study. *J. Bus. Ethics* **2004**, *55*, 173–186. [[CrossRef](#)]
47. Van Marrewijk, M. A Value Based Approach to Organization Types: Towards a coherent set of stakeholder-oriented management tools. *J. Bus. Ethics* **2004**, *55*, 147–158. [[CrossRef](#)]
48. Hansen, E.G.; Schaltegger, S. *Pursuing Sustainability with the Balanced Scorecard: Between Shareholder Value and Multiple Goal Optimisation*; Working Paper. Centre for sustainability management (CSM); Leuphana University of Luneburg; Luneburg, Germany, 2012.
49. Xia, D.; Yu, Q.; Gao, Q.L.; Cheng, G.P. Sustainable technology selection decision-making model for enterprise in supply chain: Based on a modified strategic balanced scorecard. *J. Clean. Prod.* **2017**, *141*, 1337–1348. [[CrossRef](#)]
50. Dias-Sardinha, I.; Reijnders, L. Evaluating environmental and social performance of large Portuguese companies: A balanced scorecard approach. *Bus. Strateg. Environ.* **2005**, *14*, 73–91. [[CrossRef](#)]
51. Tsai, W.H.; Chou, W.C.; Hsu, W. The sustainability balanced scorecard as a framework for selecting socially responsible investment: An effective MCDM model. *J. Oper. Res. Soc.* **2009**, *60*, 1396–1410. [[CrossRef](#)]
52. Searcy, C. Corporate sustainability performance measurement systems: A review and research agenda. *J. Bus. Ethics* **2012**, *107*, 239–253. [[CrossRef](#)]
53. Zhao, H.; Li, N. Evaluating the performance of thermal power enterprises using sustainability balanced scorecard, fuzzy Delphic and hybrid multi-criteria decision making approaches for sustainability. *J. Clean. Prod.* **2015**, *108*, 569–582. [[CrossRef](#)]
54. Pérez, C.Á.; Montequín, V.R.; Fernández, F.O.; Balsera, J.V. Integrating Analytic Hierarchy Process (AHP) and Balanced Scorecard (BSC) Framework for Sustainable Business in a Software Factory in the Financial Sector. *Sustainability* **2017**, *9*, 486. [[CrossRef](#)]
55. Khan, M.; Serafeim, G.; Yoon, A. Corporate Sustainability: First Evidence on Materiality. *Acc. Rev.* **2016**, *91*, 1697–1724. [[CrossRef](#)]
56. Zhu, Y.M.; Sun, Y.N. The Impact of Coupling Interaction of Internal Control and CSR on Corporate Performance—Based on the Perspective of Stakeholder. *Procedia Eng.* **2017**, *174*, 449–455.
57. Saaty, T.L. *The Analytic Hierarchy Process*; McGraw-Hill: New York, NY, USA, 1980.
58. Saaty, T.L. *Decision Making with Dependence and Feedback: The Analytic Network Process: The Organization and Prioritization of Complexity*; RWS Publications: Pittsburgh, PA, USA, 1996.
59. Charnes, A.; Cooper, W.W.; Rhodes, E. Measuring the efficiency of decision making units. *Eur. J. Oper. Res.* **1978**, *2*, 429–444. [[CrossRef](#)]
60. Chang, H.; Choy, H.L.; Cooper, W.W.; Ruefli, T.W. Using Malmquist Indexes to measure changes in the productivity and efficiency of US accounting firms before and after the Sarbanes-Oxley Act. Omega—The International. *J. Manag. Sci.* **2009**, *37*, 951–960. [[CrossRef](#)]

61. Hummel, K.; Schlick, C. The Relationship between Sustainability Performance and Sustainability Disclosure—Reconciling Voluntary Disclosure Theory and Legitimacy Theory. *J. Acc. Public Policy* **2016**, *35*, 455–476. [CrossRef]
62. Franzen, L.; Meckfessel, M.; Moehrle, S.R.; Reynolds-Moehrle, F.A. Developments in accounting regulation: A synthesis and annotated bibliography of evidence and commentary in the 2012 academic literature. *Res. Acc. Regul.* **2015**, *27*, 21–38. [CrossRef]
63. Banker, R.D.; Chang, H.; Natarajan, R. Productivity change, technical progress, and relative efficiency change in the public accounting industry. *Manag. Sci.* **2005**, *51*, 291–304. [CrossRef]
64. Lin, T.C.W. Compliance, Technology, and Modern Finance. The Brooklyn Journal of Corporate, Financial and Commercial Law, Temple University Legal Studies Research Paper No. 2017-06. Available online: <https://ssrn.com/abstract=2904664> (accessed on 20 September 2018).
65. Bell, T.B.; Doogar, R.; Solomon, I. Audit labor usage and fees under business risk auditing. *J. Acc. Res.* **2008**, *46*, 729–760. [CrossRef]
66. DeBoskey, D.G.; Luo, Y.; Wang, J.J. Do specialized board committees impact the transparency of corporate political disclosure? Evidence from S&P 500 companies. *Res. Acc. Regul.* **2017**, *30*, 8–19.
67. Ellinger, A.D.; Ellinger, A.E.; Yang, B.; Howton, S.W. The relationship between the learning organization concept and firms' financial performance. *Hum. Resour. Dev. Q.* **2002**, *13*, 5–21. [CrossRef]
68. Chen, Y.S.; Chang, B.G.; Lee, C.C. The association between continuing professional education and financial performance of public accounting firms. *Int. J. Hum. Resour. Manag.* **2008**, *19*, 1720–1737. [CrossRef]
69. Hwang, C.L.; Yoon, K. *Multiple Attribute Decision Making: Methods and Applications a State-of-the-Art Survey*; Springer Science & Business Media: New York, NY, USA, 2012.
70. Nekhili, M.; Nagati, H.; Chtioui, T.; Rebolledo, C. Corporate social responsibility disclosure and market value: Family versus nonfamily firms. *J. Bus. Res.* **2017**, *77*, 41–52. [CrossRef]
71. Tzeng, G.H.; Shen, K.Y. *New Concepts and Trends of Hybrid Multiple Criteria Decision Making*; CRC Press, Taylor and Francis Group: Boca Raton, FL, USA, 2017.
72. Peng, K.H.; Tzeng, G.H. A hybrid dynamic MADM model for problems-improvement in economics and business. *Technol. Econ. Dev. Econ.* **2013**, *19*, 638–660. [CrossRef]
73. Hsu, C.W.; Kuo, T.C.; Chen, S.H.; Hu, A.H. Using DEMATEL to develop a carbon management model of supplier selection in green supply chain management. *J. Clean. Prod.* **2013**, *56*, 164–172. [CrossRef]
74. Su, C.M.; Horng, D.J.; Tseng, M.L.; Chiu, A.S.; Wu, K.J.; Chen, H.P. Improving sustainable supply chain management using a novel hierarchical grey-DEMATEL approach. *J. Clean. Prod.* **2016**, *134*, 469–481. [CrossRef]
75. George-Ufot, G.; Qu, Y.; Orji, I.J. Sustainable lifestyle factors influencing industries' electric consumption patterns using Fuzzy logic and DEMATEL: The Nigerian perspective. *J. Clean. Prod.* **2017**, *162*, 624–634. [CrossRef]
76. Ren, Z.; Xu, Z.; Wang, H. Dual hesitant fuzzy VIKOR method for multi-criteria group decision making based on fuzzy measure and new comparison method. *Inf. Sci.* **2017**, *388–389*, 1–16. [CrossRef]
77. Madjid, T.; Debora, D.C.; Francisco, J.S.A. An extended stochastic VIKOR model with decision maker's attitude towards risk. *Inf. Sci.* **2018**, *432*, 301–318.
78. Opricovic, S.; Tzeng, G.H. Compromise solution by MCDM methods: A comparative analysis of VIKOR and TOPSIS. *Eur. J. Oper. Res.* **2004**, *156*, 445–455. [CrossRef]



© 2018 by the author. Licensee MDPI, Basel, Switzerland. This article is an open access article distributed under the terms and conditions of the Creative Commons Attribution (CC BY) license (<http://creativecommons.org/licenses/by/4.0/>).

Article

# An Integrative Conceptual Framework for Sustainable Successions in Family Businesses: The Case of Taiwan

Jau Yang Liu

Department of Accounting, Chinese Culture University, 55, Hwa-Kang Road, Yang-Ming-Shan, Taipei 11114, Taiwan; liu78705@yahoo.com or lcy13@faculty.pccu.edu.tw; Tel.: +886-937-544-654

Received: 24 September 2018; Accepted: 10 October 2018; Published: 12 October 2018

**Abstract:** Family businesses have long been one of the mainstream business models in developing countries. The smooth succession of control in family businesses is the key to their sustainable development. However, compared with other companies, succession in family business has demonstrated unique complexity, which also affects the development of the business. The paper is based on a review of the existing literature, starting from the theory of family business succession and combining with grounded theory. After that, we conducted field interviews of experts, coding the key factors affecting succession in family businesses in Taiwan. Finally, we explored the considerations and implications of the succession for inheritance planning. The results of this study show that consideration of succession in family businesses involves a multi-dimensional and complex decision-making process. Among the key considerations, it is found that corporate characteristics, family capital and niche inheritance are the most important without consideration of whether the continuation of the business after succession will be doomed to failure. In addition, the family relationship of affection and trust and commitment between both predecessor and successor are important factors that cannot be ignored, especially in a rapidly changing competitive market environment.

**Keywords:** family business; succession plan; corporate characteristics; family capital; niche inheritance; multi-attribute decision model (MADM); social sustainability

---

## 1. Introduction

In a family business, it is not a simple matter for the successor to successfully take over the heavy responsibility of leadership from the predecessor to ensure that the company continues to develop while maintaining harmony among its various family members and stakeholders [1]. For family businesses, succession is not simply the passing of leadership on to the next generation, but also includes considerations of ownership structure, management rights and control rights, governance structure, family interests and the future business direction of the company [2–4]. In other words, leadership succession has certain elements of complexity, and its effects are relatively extensive.

Although some family-owned enterprises have developed into listed companies through entry into the capital market, with the new trend of the enterprise internationalization and the introduction of professional management teams, whether the family business can still maintain its original business model and continue to preserve the momentum for future growth is still unclear. After decades of evolution of Taiwanese family businesses, many are now facing serious issues with generational alternation, corporate transformation and the continuation of family power and freedom from disintegration. In this narrative, the first generation of family businesses is not only strongly reliant on the founders' leadership, but also dependent on the founder's network of relationships and knowledge

base. In this type of situation, a lack of inheritance planning is likely to lead to the loss of these key management resources [5].

In terms of succession, family business owners usually only consider the relationships and configuration of the family and corporate equity. They may lack understanding and analysis of other important factors affecting family business succession, such as changes in the business environment, company characteristics, family tradition and the status of niche inheritance [6]. Despite the consensus among academics on the importance and multidimensional nature of inheritance, scholars have failed to reach any consensus on the components or dimensions of the succession that are most important.

In short, it is obvious that the family business's inheritance decision has clearly not been solved in practice or in theory. The inheritance decisions of family businesses are still unable to be planned. In addition, many past discussions about family heritage appearing in the literature have been descriptive case studies, and few have used qualitative data. Furthermore, there has been a lack of quantitative data related to the inheritance variables in family inheritance, and an even greater lack of integrated research. Therefore, to compensate for this gap in the literature, our research goal is to develop a comprehensive conceptual framework for full consideration of all the potential factors affecting family business inheritance needed to avoid failure in the future and improve the efficiency of inheritance decision-making.

After a review of the existing literature, along with the application of grounded theory, we conduct field interviews to find the key factors affecting family business inheritance, and then employ the decision-making trial and evaluation laboratory method (DEMATEL) and the analytic network process (ANP) of multi-criteria decision-making method to construct the influential network relation maps (INRM) for a systematic performance improvement and to find the weights and priorities of the inheritance factors. Finally, in order to grasp the direction of family inheritance and succession more accurately, the VIKOR (VlseKriterijumska Optimizacija I Kompromisno Resenje) method is integrated for analysis of the positive-ideal solution and negative-ideal solution.

This methodology allows the evaluation of the current situation, to find the key factors that are most important and to make comparisons between candidate solutions and the ideal solution. The results of this study can be used as a reference for family business succession planning. It is hoped that the results will not only be useful in understanding the decision-making environment of the family business and the strategic goals of inheritance and succession, but also contribute to a better theoretical understanding of sustainable family business management, the effects of inheritance of family businesses and the formulation of strategic development.

## **2. Literature Review**

The succession and governance of family businesses is a highly valued research topic that covers a wide range of aspects. This study can be divided into two parts: in the first section, we discuss family business development and governance type; the second section contains an analysis of the key influential factors in family business succession.

### *2.1. Family Business Development, Governance and Succession*

The succession of authority in family businesses has been studied by the academic community since the 1950s, with considerable attention being paid to family business related issues in Asian countries in recent years. Simply put, a family business is a business run by a group of individuals with a blood relationship [7]. Although the definitions of family businesses might be different, the judgment as to what is a family business is based on ownership, management and control. Here, a family business is defined as one run by an entrepreneur or a family member (spouse, children or their children) who holds more than half of the voting rights in the company, with at least one family member holding a management position in the company [8]. In the case of a publicly-held company, the entrepreneur or their family members should hold at least 25% of the shares, with at least one family member serving on the board of directors. In the past, the academic definition of a family

business has differed depending on whether family members hold seats on the board of directors and on their control of shareholding and voting rights [9].

Handler's [10] study of family businesses suggests that aggressive entrepreneurship and strong family cohesion are major factors in the success of family businesses. However, the unique characteristics of the family business may make its corporate governance, management characteristics and corporate governance environment inferior to that of non-family businesses. Longenecker and Schoen [11] pointed out that the enterprise succession process is dynamic and comprises a combination of activities related to inheritance within the context of a specific period of time. In the study of family business, family inheritance is usually regarded as a process of power transfer, which is not simply equivalent to legal inheritance. Recently, Nuñez-Cacho et al. [12] emphasized that environmental issues must also be taken into consideration as they are increasingly important to sustainability, hence the development of theories of functionality, ecology and development.

In short, the issue of succession in a family business is very complex [13–15]. Past models of the process of inheritance of family businesses can be divided into three types: evolutionary process models, family life cycle perspective models and psychological perspective models with more studies focusing on the study of the inheritance evolution process models, emphasizing the process of inheritance. Among them, Longenecker and Schoen [11] broke down the succession process into seven stages, three of which would take place before the successor actually enters the business as a full-time employee. Handler [10] summarized the inheritance process as comprised of three phases of interconnection. In addition, a variety of succession models have been built based on the different perspectives of entrepreneurs, successors and family businesses. For example, Churchill and Hatten [16] used a life cycle approach to describe the succession process between father and son in a family firm. They divided the life cycle of an enterprise into: (1) the stage of owner-management; (2) the stage of training and development; (3) the partnership stage between father and son; and (4) the stage of power transfer.

In addition to the above, Nuñez-Cacho et al. [12] further noted that the very nature of the family company positions it well to face the challenges posed the new environmental scenarios. They employed the principles of a circular economy to design a sustainable model, which shows family businesses' responses to changes in the environment. O'Leary and Swaffin-Smith [17] also proposed an organic model for depicting the transitional nature of family businesses that reflect the dynamics involved when both business and family issues are intermingled. The model depicts a quadrant of family business types (personal, livelihoods, bank and heritage) that overlap to form transition zones between those four principal states of being.

In the inheritance of family businesses, sanguinity is still the key factor and primary consideration [18]. Father-to-son succession is the mainstream inheritance model in the early stage of family business development, and it is still a common way for family businesses to pass from generation to generation [19]. However, from the perspective of history or inheritance theory, when family businesses grow or expand in size, family members will face challenges such as whether they can afford to preserve the family mission and whether they have the will and ability to continue the inheritance. Therefore, the family business's choice of successors might not be limited to family members.

With the rapid development of the economy in Asia, the expansion of family businesses and the development of closer relationships between the enterprise and society, family boundaries are easily broken in the process of inheritance of the family business. The family trust is another emerging enterprise inheritance model for today's family businesses. This model includes the designing of a trust to safeguard the management, inheritance and protection of family wealth. The beneficiaries are generally family members. The main purpose of its establishment is to solve the problem of inheritance when passing property across generations and to achieve an effective and stable transfer of family equity and management for a unique inheritance model [20]. According to relevant research, modern family trusts tend to be more involved with public interests, while still paying attention to

family interests. Modern trusts also include considerations of family and corporate governance, equity management and the distribution of beneficiary rights.

## 2.2. Analysis of the Key Factors Influencing Family Business Inheritance

Since the 1950s, the academic community has studied family businesses. However, although intergenerational inheritance is a core issue in the family business field, no unified conclusions have been reached. Lansberg and Astrachan [14] pointed out that inheritance plans usually include the preparations necessary to ensure family harmony and business continuity and must take into account the future needs of businesses and families. Therefore, in the process of inheritance planning factors such as corporate characteristics, governance patterns and management models, family relationships and inheritance conditions should be considered.

Of course, the assessment framework may also include other factors related to inheritance, such as: industry characteristics, mechanisms for dealing with inheritance and the trust of the predecessor and the willingness and commitment of the successor [21]. To obtain insights into family business inheritance, we gained information from three different sources: the academic literature, the heir's recommended attributes and interviews with predecessors about their expectations of their successors or their perceptions of successor requirements.

Among them, the academic literature mainly comes from the online Web of Science Core Collection (WSCC) database and the ScienceDirect OnSite (SDOS) database. The keywords of the review were searched on the theme of "inheritance," "succession," and "family business" in the period 1979–2018. There are 42 major journals from all the publications identified (121) including family business research (19), entrepreneur theory and practice (8) and sustainability (4). In addition, the main interviewees were entrepreneurs enrolled in a Taiwanese SME Family Business Inheritance Training Course. The content obtained from the interviews was combined with grounded theory and then used to encode the factors affecting inheritance decision-making.

The key considerations of inheritance and succession of the family business after analysis show a multi-dimensional relationship and are interrelated with each other. It is difficult to judge the superiority or the inferiority of the various factors. Moreover, the considerations of business owners are not only complicated, but also various factors of inheritance considerations are very meaningful and logical. The overall considerations are shown in Table 1. They can be divided into five major facets and 13 metrics.

**Table 1.** The dimensions and criteria for family business transferring and succession.

Dimension	Criteria	Description	References
A Corporate Attribute	a <sub>1</sub> Industrial Trait	The external environmental factors that family businesses face in order to survive, such as economic, social, legal, technical and environmental protection.	[12,22–27]
	a <sub>2</sub> Corporate Style	In order to manage the enterprise, the ownership structure is designed by the family business during the process of development. The governance mode for this ownership structure is shown by how ownership, management and control are separated.	
	a <sub>3</sub> Business Scale	According to different classification standards (such as the number of employees, production capacity, fixed asset value, etc.), family businesses can be divided into large enterprises, medium enterprises and small enterprises.	

Table 1. Cont.

Dimension	Criteria	Description	References
B Governance Variables	b <sub>1</sub> Equity Structure	The proportion of different types of shares and their interrelationships, such as the degree of concentration or dispersion of equity in the shareholding structure.	[14,28–34]
	b <sub>2</sub> Governance Culture	The degree of capital socialization and management socialization in family businesses, such as the centralization of family interests and the socialization of family interests.	
C Management Concern	c <sub>1</sub> Leadership Style	Leadership styles displayed in family businesses can include totalitarian authoritative leadership, decentralized professional leadership or group consensus collective leadership.	[20,35–43]
	c <sub>2</sub> Employment Philosophy	The mechanisms and practices for managing human resources in family businesses, such as relationship oriented, technology oriented or professional oriented.	
	c <sub>3</sub> Communication Mode	The arbitrariness or democratic nature of family business decision-making; the mode of horizontal or vertical communication; the standard of performance appraisal and job promotion	
D Family Capital	d <sub>1</sub> Family Structure	The tangible types of interpersonal relationships within the family structure, such as social relationships between members of different hierarchical levels, pedigree, primogeniture	[13,27,44–49]
	d <sub>2</sub> Family Tradition	The tradition of the family is usually reflected in the family beliefs or customs that family members share and abide by, such as the customs, conventions and family rules or family constitutions.	
	d <sub>3</sub> Affection relationship	Intangible interpersonal relationships in the family structure, such as family affection or obedience, unity and cohesion	
E Niche Inheritance	d <sub>1</sub> Succession Planning	The company develops and builds a high-potential successor tracking and developing mechanism that is closely integrated with the company's overall business strategy.	[8,34,39,50,51]
	d <sub>2</sub> Requirement profiles	The requirements of the predecessors and the expected skills of the successor, both explicit and implicit requirements such as soft and hard skills.	

### 3. Methodology

#### 3.1. Grounded Theory and a Decisive Factor Analysis Framework of Succession

A good succession plan helps with the smooth implementation of family business succession over the generations. This study is based on feedback from business owners participating in Taiwan family



business training courses. The aim of this study is to construct an analytical framework containing the key decision-making factors for family business succession. To begin the process of analyzing the data related to family business succession, we first conduct a lengthy review of the literature. We adopt the qualitative research method of semi-structured interviews. The inheritance factors are organized into five pre-planned groups including corporate attributes, governance variables, management concerns, family capital and niche inheritance. These five pre-planned dimensions are extracted from 12 potential topics suggested by experts or obtained based on empirical materials collected from case studies, then used to explore considerations for intergenerational transitions involving family succession. The findings are refined into five facets to be used as research lenses and variables of interest.

As noted by Corbin and Strauss [52] in their seminal work, grounded theory is a systematic methodology used in the social sciences, where theory is constructed through methodical gathering and analysis of data. In other words, there is no pre-conceived theory in the researcher's mind, rather the theory gradually emerges from the data. This qualitative research method is characterized by viewing the world from the perspective of the actor, rather than using the values or the world view of the researcher to construct the framework.

The content of the interview outline is roughly divided into two parts: the first part is used to collect background information from the interviewer, and the second part is designed to further explore the factors for consideration in family business inheritance. The interview questions are listed in Table 2 below.

**Table 2.** The content of the interview on business firm succession.

<b>Part I: Basic Information</b>	
1. Family business background	(a) Industry (b) Year of establishment (c) Education level
2. Inheriting generations	(a) Currently operated by the first generation (b) Currently operated by the second generation (c) Currently operated by the third generation or later
<b>Part II: Factors Affecting the Succession of Family Businesses</b>	
1. Corporate Attribute	(a) How do you see the impact of the corporate attributes on the succession of authority in the family business? (b) What factors do you think will affect family succession in terms of family business traits?
2. Governance Pattern	(a) What is the impact of the governance pattern on succession in the family business? (b) What factors do you think will affect family succession in terms of the family governance pattern?
3. Management Mode	(a) What is the impact of the management mode on succession in the family business? (b) What factors do you think will affect family succession in terms of the family management mode?
4. Family Capital	(a) What is the impact of family capital on succession in the family business? (b) What factors do you think will affect family succession in terms of family capital?
5. Inheritance Condition	(a) What is the impact of the inheritance conditions on succession in the family business? (b) What factors do you think will affect family succession in terms of family inheritance?

To compensate for the limitations in the literature, respondents are free to express their thoughts about the key factors related to inheritance. Therefore, during the interview process, the researchers asked the respondents to express themselves freely within the framework of the problem. The steps followed for the interview procedure are as follows:

Step 1: Translate the information obtained from the interview into a draft: In order to ensure that the data are as authentic as possible, the researcher tried to use a word-by-word translation method, but skipped unnecessary repetitions and irrelevant content. After the translation process was completed, in order to protect the privacy of the interviewee and prevent others from guessing their identity, some parts or information that might reveal the identity of the interviewee are represented by a letter code, and parts that are not related to the study are deleted.



Step 2: Encoding the text draft: Because of the length of the verbatim draft, the content of the different questions is classified first, and then encoded line by line. This coding method can structure the verbatim manuscript in a way that is convenient for both researchers and readers to quickly find the corresponding source of the article citation.

Step 3: Identifying the descriptions of the key factors affecting succession: Researchers repeatedly read the verbatim scripts to find those statements that described key factors affecting family business succession, which were then coded, condensed into short sentences, and recorded in a verbatim paragraph.

Step 4: The above information was combined with information from the literature review and the essence of the key factors of succession integrated and summarized to arrive at five aspects of belonging.

Step 5: The factors that the researcher considers to be relevant to succession are derived based on the results of the previous steps. Finally, to ensure that the factors extracted by the grounded theory methodology are valid, they are modified based on the knowledge and experience of experts who were asked to make recommendations for each standard to ensure the validity of the research framework and to confirm the final results.

Finally, the resultant content of the interview responses was coded by the application of grounded theory. The coded factors that affected family inheritance planning were collected and listed, with a total of 18 criteria used as the basis of the pre-test questionnaire.

As recommended by Saaty [53], the number of factors within a single dimension was limited to ensure the validity and consistency of the pairwise comparisons, and a questionnaire survey of experts was used to obtain the relative importance of the criteria. The 14 domain experts were lecturers in family business inheritance training classes who had a solid theoretical and/or practical insights of the transferring and succession of family enterprises. Regarding the background of these 14 experts, there were 3 high school graduates, 7 university graduates and 4 had Ph.Ds. They were between 28 and 55 years old.

In addition, criteria were defined as important if the triangular fuzzy numbers had a mean value of eight or above. The pre-test questionnaire was scored on a scale of zero to 10, with a higher score representing greater importance. The pre-test results indicated that 13 criteria of the 18 should be adopted. From the afore-mentioned multidimensional evaluation groups that determine the inheritance management of family businesses, we identified the key succession indicators in each of the major groups. This phase ended when the research framework was consistently validated. The revised framework and meaningful terms and descriptions are shown in Figure 1 and Table 1 below.

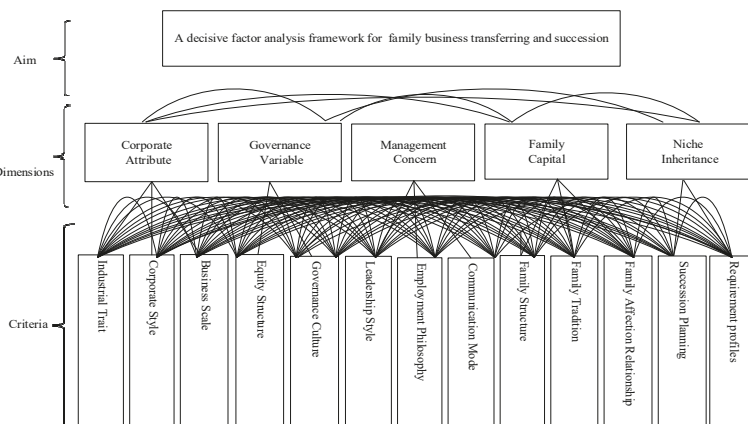

Figure 1. A decision factor analysis framework for family business transferring and succession.

### *3.2. Evaluation Methods and Operational Procedure*

In the real world, the factors affecting family business transmission and inheritance show multi-dimensional and multi-criteria decision-making characteristics. The facets and criteria for the key considerations are not independent of each other, but have mutually influential relationships, and sometimes, there is even a feedback and dynamic cause-effect relationship between them. Therefore, after establishing the research framework, in order to further understand the priorities and interactive relationship between the considerations affecting family business inheritance, this study first uses DEMATEL to build an influential network relationship diagram (INRM). The influential network diagrams can not only help researchers avoid unrealistic individual and independent assumptions, but also systematically clarify the interdependence and feedback relationships of the criteria and dimensions in real-world problems [54]. After clarifying the relationship between multiple criteria, we then use the analytic network process (ANP) to compare the criteria and calculate the weights of the considerations in the framework of family business succession. Finally, in order to more accurately grasp the decision-making direction for family inheritance, the VIKOR (VlseKriterijumska Optimizacija I Kompromisno Resenje) method is integrated with the multi-criteria decision-making method to carry out analysis of the positive-ideal and the negative-ideal solution.

Tsai et al. [55] pointed out in his recent study that the integration of the above three research methods has the following three advantages. First, the use of the DEMATEL method can illustrate the interrelationship among criteria, thereby removing the constraints imposed by the assumption in conventional analytical techniques that the evaluation criteria are independent of one another. Second, prioritization and selection can be executed despite any conflicts among the attributes. In addition, the VIKOR method uses the ideal standard, rather than a relative standard, as the benchmark to avoid choosing the best option from bad batches [56]. Therefore, the aspired to improvement strategies can be proposed systemically at the source of the impacts.

Based on the above three analytical techniques, accordingly, this study divides the detailed operational procedure of the decision-making model into three phases and demonstrates the calculations involved in each phase with the aid of Figure 2:

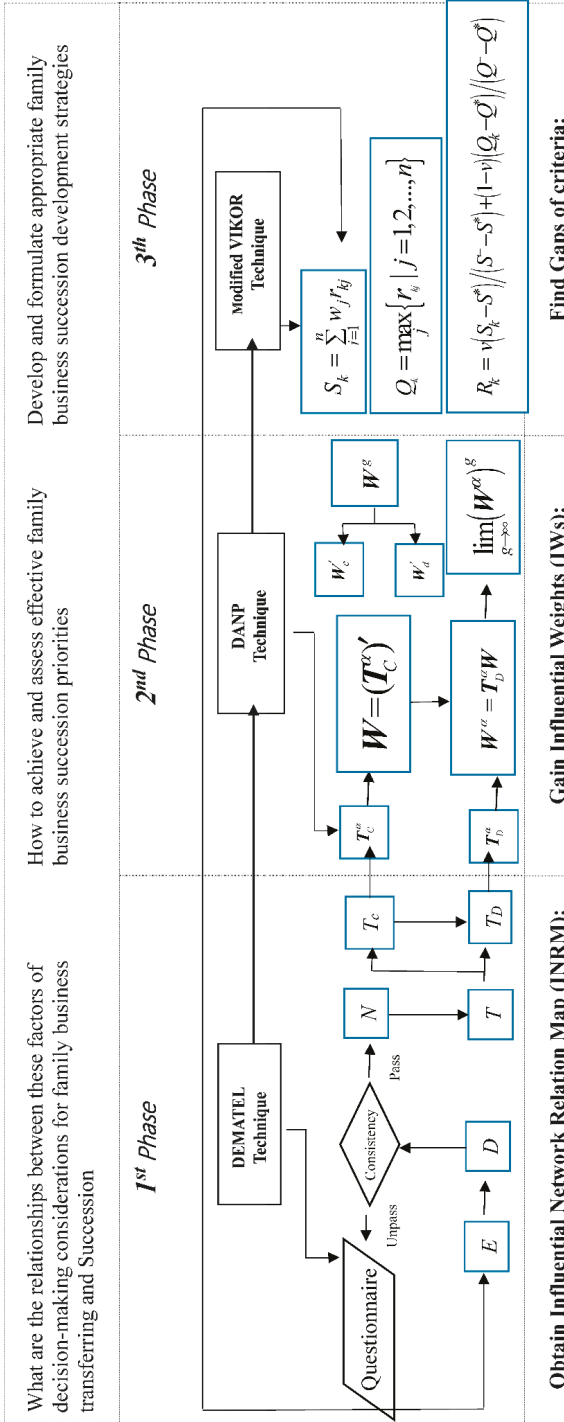

**1<sup>st</sup> Phase:** E denotes the direct influence relation matrix; D denotes the average direct influence relation matrix; N denotes the normalized average direct influence relation matrix; T denotes the total influence relation matrix; T<sub>C</sub> denotes the total influence relation matrix of criteria; T<sub>D</sub> denotes the total influence relation matrix of dimensions.

**2<sup>nd</sup> Phase:** DANP(DEMATEL-Based ANP), T<sub>C</sub> denotes the normalizing total influence relation matrix of criteria; T<sub>D</sub> denotes the normalizing total influence relation matrix of dimensions; W<sup>α</sup> denotes the unweighted supermatrix; W<sup>c</sup> denotes the weighted supermatrix; W<sup>d</sup> denotes the global weight; W<sub>c</sub> denotes the local weight of criteria; W<sub>d</sub> denotes the local weight of dimensions.

**3<sup>rd</sup> Phase:** S<sub>k</sub> denotes the satisfaction level of each criteria; R<sub>k</sub> denotes the gap of each criteria; Q<sub>k</sub> denotes the mean group utility for the gap.

**Figure 2.** Flowchart for the operational procedure. DEMATEL, decision-making trial and evaluation laboratory method; VIKOR, VlseKriterijumska Optimizacija I Kompromisno Resenje.

#### 4. Empirical Analysis of the Key Influential Factors in Family Business Succession

In the empirical analysis phase, the official questionnaire was formulated as in Table 1 and shown in Supplementary Material. The respondents were either business owners or members attending the Taiwan Family Business Inheritance Training Course. A total of 118 survey responses were retrieved; among the respondents, 50.8% were first-generation owners and 44.1% were second-generation owners. Only 5.1% remain for the third generation owners. The remaining 6% were third generation owners. The respondents ranged in age from 23 to 73 years old. The level of education ranged from high school graduates to holders of doctoral degrees in a variety of disciplinary areas. The industrial structure included the primary, secondary and tertiary sector. The results for the backgrounds of the survey participants are summarized in Table 3.

**Table 3.** Detailed information about interviewees.

Category	Content	N	Percentage
Generation	First-generation owners	60	50.8%
	Second-generation owners	52	44.1%
	Third generation of owners	6	5.1%
Sex	Male	86	72.9%
	Female	32	27.1%
Education level	Doctorate	4	3.3%
	Master's	42	35.6%
	Undergraduate	63	53.4%
	High School and Below	9	7.7%
Industry	Primary industrial sectors	8	6.7%
	Secondary industrial sectors	62	52.5%
	Tertiary industrial sectors	48	40.8%

##### 4.1. Results of the DEMATEL

This study used pairwise comparison to investigate the dimension and criteria of impact for each participant. Using the methodology described above and based on the data collected from the respondents, we derive a  $13 \times 13$  average initial direct-influence matrix T, including 13 criteria. The total influence-relation matrices shown in Tables 4 and 5 can be obtained on the basis of the normalization impact matrix described above.

**Table 4.** Total influence-relation matrix of criteria.

Criteria	a <sub>1</sub>	a <sub>2</sub>	a <sub>3</sub>	b <sub>1</sub>	b <sub>2</sub>	c <sub>1</sub>	c <sub>2</sub>	c <sub>3</sub>	d <sub>1</sub>	d <sub>2</sub>	d <sub>3</sub>	e <sub>1</sub>	e <sub>2</sub>
a <sub>1</sub>	0.014	0.152	0.151	0.145	0.157	0.151	0.125	0.114	0.030	0.126	0.112	0.154	0.149
a <sub>2</sub>	0.019	0.057	0.148	0.132	0.146	0.158	0.147	0.137	0.047	0.114	0.101	0.136	0.138
a <sub>3</sub>	0.015	0.089	0.052	0.088	0.105	0.137	0.125	0.119	0.044	0.098	0.076	0.112	0.146
b <sub>1</sub>	0.018	0.092	0.118	0.053	0.136	0.175	0.172	0.148	0.030	0.093	0.082	0.126	0.122
b <sub>2</sub>	0.020	0.077	0.102	0.101	0.063	0.151	0.163	0.134	0.022	0.080	0.081	0.111	0.108
c <sub>1</sub>	0.030	0.059	0.069	0.070	0.110	0.073	0.160	0.171	0.026	0.099	0.090	0.126	0.103
c <sub>2</sub>	0.034	0.063	0.055	0.045	0.090	0.116	0.059	0.122	0.022	0.080	0.074	0.104	0.088
c <sub>3</sub>	0.017	0.033	0.050	0.054	0.072	0.079	0.077	0.044	0.018	0.058	0.059	0.071	0.093
d <sub>1</sub>	0.013	0.059	0.065	0.078	0.088	0.093	0.106	0.110	0.014	0.068	0.060	0.111	0.108
d <sub>2</sub>	0.029	0.165	0.162	0.148	0.212	0.226	0.217	0.217	0.094	0.092	0.182	0.223	0.228
d <sub>3</sub>	0.022	0.145	0.137	0.120	0.155	0.182	0.177	0.176	0.057	0.129	0.066	0.160	0.184
e <sub>1</sub>	0.020	0.106	0.124	0.125	0.140	0.166	0.161	0.160	0.025	0.117	0.058	0.079	0.157
e <sub>2</sub>	0.010	0.061	0.066	0.057	0.062	0.073	0.081	0.072	0.025	0.061	0.072	0.101	0.047

**Table 5.** The sum of effects on dimensions.

Dimensions	A	B	C	D	E
Corporate Attributes (A)	0.462	0.777	0.865	0.690	0.621
Governance Variables (B)	0.373	0.332	0.667	0.370	0.375
Management Concerns (C)	0.273	0.267	0.241	0.216	0.205
Family Capital (D)	0.721	0.881	0.990	0.531	0.760
Niche Inheritance (E)	0.547	0.658	0.786	0.605	0.405

As shown in Table 6, the sum of the influence of each dimension and criterion can be derived by applying Equations of DEMATEL. The INRM in Figure 3 illustrates the influential network-relationship between the five dimensions and their subsystems for the decisive factor analysis framework for family business transferring and succession.

According to the value of influence given  $d_i - r_i$ , management concerns (A) is influenced by governance variables (B), niche inheritance (E), corporate attributes (C) and family capital (D), because the  $d_i - r_i$  value of management concerns (C) is negative and a minimum ( $-2.346$ ). The criteria with negative values of  $d_i - r_i$  are greatly influenced by the other criteria. Conversely, a significantly positive value of  $d_i - r_i$  represents that this criterion affects other criteria much more than those other criteria affect it, which means it should be a priority for improvement. Accordingly, management concerns (C) and governance variables (B) are influenced by niche inheritance (E), whereas niche inheritance (E) is influenced by family capital (D) and corporate attributes (A). Meanwhile, family capital (D) with a maximum value of  $d_i - r_i$  (1.471) has the most influence on the other dimensions.

Due to different family backgrounds, resources and social networks, family businesses have formed different family traditions, which accumulate into unique family capital. Family capital is not only related to the development of the company, but also a key consideration during succession. Family capital will naturally conform to the development of the corporate environment and will lead to the development of differences in corporate forms and governance cultures during the life cycle of the family business. In order to ensure sustainable development of the family enterprise, it is also necessary to examine the place of family development and the enterprise environment, as well as adjustment of the modes of governance and management through the arrangement of the succession plan.

Through a close examination of Table 6, we can recognize how the dimensions of family capital (D), corporate variables (A), niche inheritance (E), governance patterns (B) and management concerns (C) interact and influence each other. To facilitate the success of the inheritance and help companies continue to operate sustainably, improvement and adjustment of the dimensions niche inheritance (E), corporate attributes (A) and family capital (D) should be emphasized. The priority of influence of the five dimensions is thus family capital (D), corporate variables (A), niche inheritance (E), governance patterns (B) and management concerns (C).

**Table 6.** The sum of influences and ranking of each dimension and criterion.

Dimensions and Criteria (i)	Row Sum ( $d_i$ )	Column Sum ( $r_i$ )	$d_i+r_i$	$d_i-r_i$	Ranking
Corporate Attributes (A)	3.414	2.376	5.790	1.038	
a <sub>1</sub> Industrial Traits	1.580	0.260	1.840	1.320	1
a <sub>2</sub> Corporate Style	1.480	1.158	2.638	0.321	2
a <sub>3</sub> Business Scale	1.207	1.298	2.504	-0.091	3
Governance Variables (B)	2.117	2.915	5.032	-0.798	
b <sub>1</sub> Equity Structure	1.366	1.216	2.582	0.150	1
b <sub>2</sub> Governance Culture	1.213	1.537	2.750	-0.324	2
Management Concerns (C)	1.202	3.548	4.751	-2.346	
c <sub>1</sub> Leadership Style	1.186	1.779	2.964	-0.593	1
c <sub>2</sub> Employment Philosophy	0.950	1.770	2.720	-0.819	2

Table 6. Cont.

Dimensions and Criteria (i)	Row Sum ( $d_i$ )	Column Sum ( $r_i$ )	$d_i+r_i$	$d_i-r_i$	Ranking
$c_3$ Communication Mode	0.723	1.723	2.446	-1.000	3
Family Capital (D)	3.883	2.413	6.296	1.471	
$d_1$ Member Structure	0.972	0.455	1.427	0.516	3
$d_2$ Family Traditions	2.195	1.216	3.411	0.979	1
$d_3$ Family Affection Relationships	1.710	1.112	2.822	0.597	2
Niche Inheritance (E)	3.000	2.366	5.367	0.634	
$e_1$ Successor Planning	1.438	1.613	3.050	-0.175	1
$e_2$ Requirement profiles	0.787	1.670	2.457	-0.882	2

#### 4.2. Analysis of the Relationships between Dimensions and Criteria

As shown in Table 6 and Figure 3, the analysis of each criterion shows that in the corporate attribute (A) dimension, industrial traits ( $a_1$ ) is the most important criterion ( $d_i - r_i = 1.32$ ), and business scale ( $a_3$ ) is the least influential ( $d_i - r_i = -0.091$ ). First of all, in terms of corporate attributes, the type of industry, company size, social network and industrial environment in which the family business operates all have different requirements for the qualifications of the successor. The attributes of the industry will also influence the subsequent planning of corporate equity and governance structure, thus affecting intergenerational inheritance and succession planning. The type of corporate style not only also affects the model of family intergenerational succession, but also the required abilities of successors, and this can be different at different stages of family business development. In addition, the scale of the firm is often seen as an important factor influencing the development and implementation of the succession plan. The larger the family enterprise, the more likely that professional managers will be introduced to assist with the business or be replaced by suitable successors. Enterprises also have to adapt to changes in the industrial environment. Thus, the style of the enterprise will change in response to market changes, the scale of the enterprise will continue to expand, and the challenges of employing people will increase, so the needs of successors will be different.

In the governance variables (B) dimension, equity structure ( $b_1$ ) is the most important criterion ( $d_i - r_i = 0.15$ ), whereas governance culture ( $b_2$ ) is the least influential criterion ( $d_i - r_i = -0.324$ ). It is generally believed that corporate governance is clear, equity structure is balanced and the introduction of external independent directors facilitates the initiation of the inheritance process and the implementation of the succession plan. Family businesses often use industrial advantages to design complex equity and sophisticated family equity structures, reducing the need for successor management skills and reducing the impact of uncertainty in the external environment on the succession process [57]. In addition, corporate governance culture is also an important factor affecting family heritage.

In the dimension of management concerns (C), leadership style ( $c_1$ ) is the most important criterion ( $d_i - r_i = -0.267$ ), whereas communication mode ( $c_3$ ) is the least influential criterion ( $d_i - r_i = -1.000$ ). In family businesses, ownership and management rights are generally in the hands of the founders of the company. Leaders often play a key role in the business team or within the family. Therefore, the leader's leadership style, human resource appointment mode and communication mode will affect the development and planning of the family business succession. If the leadership style of the family business is single-paternalistic with a relationship orientation, rather than being performance-based, or focused on group communication, technology or work specialization, then it is easier for the family business to recruit from within the family and rule out non-kin. Furthermore, leadership is more likely to be passed on to family members. Modern enterprises should establish a sound mechanism for the development of human resources, and this mechanism is an important guarantee of success in the succession model.

In the dimension of family capital (D), family traditions ( $d_1$ ) is the most important criterion ( $d_i - r_i = 0.979$ ), whereas member structure ( $d_3$ ) is the least influential criterion ( $d_i - r_i = 0.516$ ).

The importance of the family capital variables in the process of family business inheritance is unquestionable, because family membership is at the core of the family business and the primary consideration for succession. Barach et al. [22], Lansberg and Astrachan [14] pointed out that the family membership structure, family traditions, family relationships and family cohesion have important impacts on the implementation of succession plans. Therefore, Barach [29] argued that the family capital of family stakeholders is one of the most important factors affecting inheritance and development in family businesses. In addition, family capital is particularly meaningful for family succession. Positive family capital can increase family wealth, while negative family capital (such as struggles, accusations and even lawsuits between family members) will destroy the family's wealth. Unity and trust within the family will allow the family assets to grow generation by generation, and such capital can be reflected in family capital by family discipline, family rules and family traditions. Lansberg and Astrachan [14] argued that family harmony, prestige and cohesion have a significant impact on the implementation of succession programs.

In the dimension of niche inheritance (E), successor planning ( $e_1$ ) is the most important criterion ( $d_i - r_i = -0.175$ ), whereas willingness and commitment ( $e_2$ ) is the least influential criterion ( $d_i - r_i = -0.882$ ). Whether the successor's qualifications are sufficient to take on the operational burden of family business is also an important consideration. Succession is definitely not an easy task. It is not easy for the successor to take over and continue to run the business. The key to a company's long-term stability is that its core values can be confirmed by its successors. The experiences, conditions (hard skills, soft skills, personality traits, predecessor-successor relationship), encouragement of continued sustainable development of the enterprise, patterns of innovation and even the leadership and vision of the successor are also important factors that cannot be ignored [58]. For example, Stavrou [8] showed that the key players, that is the willingness and commitment of successors in the process of inheritance should not only receive sufficient attention, but should also be included in the analytical framework of the succession process. Moreover, a company must be able to maintain long-term stability, and business owners generally believe that succession planning is important. The corporate succession plan requires systematic and effective acquisition and organization of human resources. Therefore, the development of a continuous and fair corporate succession plan is of vital importance to the company's succession and sustainable development.

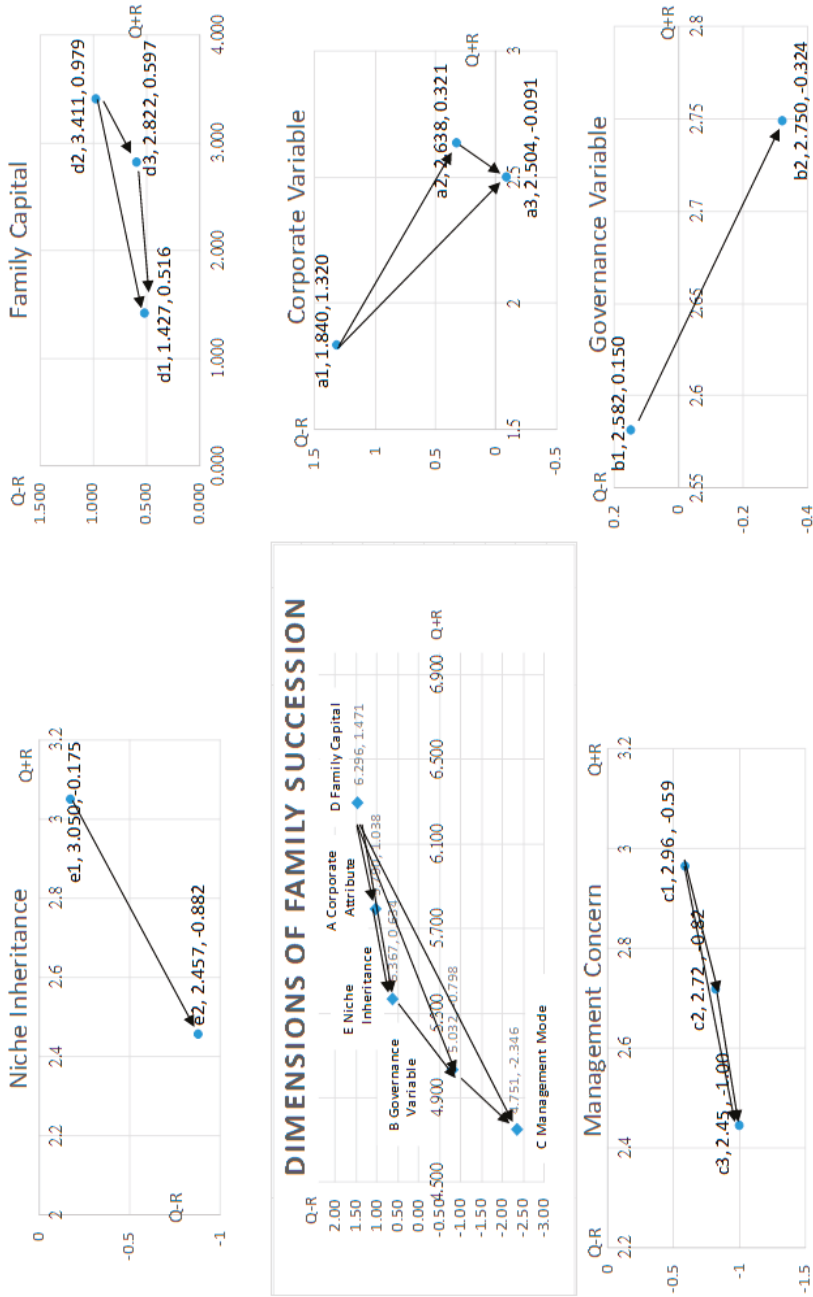

Figure 3. Maps of the influential network relations of each dimension and criterion.



4.3. Using DANP for Computing the Weights of the Criteria

In the next section, the most accurate influential weights can be obtained after confirming the influential relationships among the criteria. Using a combination of the DEMATEL and ANP methods, we obtain the DANP (DEMATEL-Based ANP) influential weights for each criterion as shown in Table 7. The DANP approach allows us to derive the local weights of the assessment factors at their respective hierarchical levels and the global weights, which helps us comprehend the absolute weights of individual criteria across all five dimensions. The DEMATEL total influence-relation matrix is employed to build the weighted supermatrix by using Equations of DANP. The weighted supermatrix for each criterion can be acquired by applying Equations of DANP. Thus, the limit supermatrix is employed to acquire the global weights of the elements, which are applied to the modified VIKOR approach to evaluate the sustainability performance of the case companies.

**Table 7.** Influential weights of DANP for each criterion obtained by  $\lim_{n \rightarrow \infty} (W^n)$ .

Dimension	Criteria	Weight	Rank
A Corporate Attributes	a1 Industrial Trait	0.172694	2
	a2 Corporate Style	0.089596	5
	a3 Business Scale	0.073425	6
B Governance Pattern	b1 Equity Structure	0.042153	9
	b2 Governance Culture	0.032147	10
C Management Concerns	c1 Leadership Style	0.024949	11
	c2 Employment Philosophy	0.019127	12
	c3 Communication Concerns	0.015658	13
D Family Capital	d1 Member Structure	0.090343	4
	d2 Family Tradition	0.186620	1
	d3 Family Affection Relationships	0.136879	3
E Inheritance Condition	e1 Successor Planning	0.069079	7
	e2 Requirement profiles	0.047330	8

4.4. Sustainability Performance Evaluation Obtained Using VIKOR

Next, the respondents were invited to assign linguistic values for thirteen criteria, to evaluate the decisive factor analysis framework. The criteria for the decisive factors are rated from one to 100, with one being the lowest and 100 the highest. The higher the rating is, the higher the satisfaction level. Finally, the global weights obtained from DANP in VIKOR are used to obtain the values of  $S_j$  and  $Q_j^{mod}$  by selecting  $v = 0.5$  as in Equations of VIKOR, and the results are shown in Table 8.

The compromise ranking method not only assists researchers to evaluate the overall performance gap across years, but also helps determine and prioritize strategies in different years. From Table 8, one can see the  $S_j$  values of three years ago, the current  $S_j$  values, the  $R_j^{mod}$  values of three years ago and the current  $R_j^{mod}$ . The values of “concordance” ( $S_j$ ) and “discordance” ( $R_j^{mod}$ ) represent the group utility and the individual regret measures, respectively, for alternative  $a_j$ . In addition, the  $Q_j^{mod}$  values of three years ago are ( $a_1, a_2, a_3, b_1, b_2, c_1, c_3, c_4, d_1, d_2, d_3, e_1, e_2$ ) = (0.082, 0.163, 0.215, 0.261, 0.284, 0.282, 0.285, 0.305, 0.218, 0.059, 0.091, 0.187, 0.262, respectively); the current  $Q_j^{mod}$  values are ( $a_1, a_2, a_3, b_1, b_2, c_1, c_3, c_4, d_1, d_2, d_3, e_1, e_2$ ) = (0.419, 0.386, 0.196, 0.413, 0.420, 0.432, 0.663, respectively). Accordingly, the empirical results for three years ago can be ranked as follows:  $d_2 > a_1 > d_3 > a_2 > e_1 > a_3 > d_1 > e_2 > b_1 > c_1 > b_2 > c_2 > c_3$ , where  $A > B$  means that A is preferred over B. The alternative closest to the ideal solution has the smallest value of  $Q_j^{mod}$ . The current empirical results can be ranked as follows:  $d_2 > d_3 > e_1 > a_1 > a_2 > e_2 > a_3 > d_1 > b_1 > c_1 > b_2 > c_2 > c_3$ .

Meanwhile, a compromise solution could be accepted by the decision-makers because it provides the maximum “group utility” (measure  $S_j$  represents “concordance”) and a minimum of individual regret of the “opponents” (measure  $R_j^{mod}$  represents “discordance”) [59].

Table 8. Gap ratio values obtained by VIKOR.

Dimension	Criteria	Global Weight (by DANP)	Three Years Ago			Current Year			
			$S_j$	$R_j^{mod}$	$Q_j^{mod}$	$S_j$	$R_j^{mod}$	$Q_j^{mod}$	
A	Corporate Attributes	a <sub>1</sub> Industrial Environment	0.173	0.024	0.082	0.140	0.043	0.147	0.250
		a <sub>2</sub> Corporate Style	0.090	0.027	0.163	0.300	0.027	0.163	0.300
		a <sub>3</sub> Business Scale	0.073	0.029	0.215	0.400	0.029	0.215	0.400
B	Governance Variables	b <sub>1</sub> Equity Structure	0.042	0.021	0.261	0.500	0.021	0.261	0.500
		b <sub>2</sub> Governance Culture	0.032	0.018	0.284	0.550	0.018	0.284	0.550
C	Management Concerns	c <sub>1</sub> Leadership Style	0.025	0.014	0.282	0.550	0.014	0.282	0.550
		c <sub>2</sub> Employment Philosophy	0.019	0.011	0.285	0.560	0.011	0.285	0.560
		c <sub>3</sub> Communication Mode	0.016	0.009	0.305	0.600	0.009	0.305	0.600
D	Family Capital	d <sub>1</sub> Member Structure	0.090	0.036	0.218	0.400	0.036	0.218	0.400
		d <sub>2</sub> Family Tradition	0.187	0.019	0.059	0.100	0.019	0.059	0.100
		d <sub>3</sub> Family Affection Relationships	0.137	0.022	0.091	0.160	0.027	0.114	0.200
E	Inheritance Conditions	e <sub>1</sub> Successor Planning	0.069	0.024	0.187	0.350	0.017	0.134	0.250
		e <sub>2</sub> Requirement profiles	0.047	0.024	0.262	0.500	0.019	0.209	0.400

The empirical results show that family capital is still the most important factor of influence for inheritance, with the scores evaluated being closest to the ideal point. The performance variance rate for three years ago for family capital is 0.059, indicating that there are still some gaps (0.059) to the goal value (zero). The results of this study show that family businesses are not only deeply influenced by family traditions, but family members recognize family traditions. Note that the importance of continuing the family tradition is slightly greater than the impact of the family business variables. In the face of changes in the industrial environment, the will of the family will also influence the style of governance of the company. However, the results show that in the case of changes in the family business environment, the family capital and governance variables remain stable, and successor planning becomes an important consideration in order to cope with continued development. The results will also affect the requirement profiles. Therefore, the family business still hopes to continue its development through an appropriate inheritance plan.

4.5. Discussion and Implications

This paper proposes a hybrid model for the incorporation of critical dimensions and their associated criteria, drawn from decisive factor analysis for examination of family business authority transfer and succession and provides empirical evidence for the sequencing of the order of improvement for making inheritance decisions. The results show that there are five dimensions and 13 criteria that are the decisive factors affecting family business inheritance and that these are interdependent on and related to each another. Due to the diversity and complexity of succession decisions, the factors considered should not be limited to a single facet of family interests. The factors

required for comprehensive consideration of succession must include the environment of the family business, overall future development, the existing structure and management concerns of the company and the basic conditions of the existing family succession such as the trust of the predecessor and the commitment of the heirs [20]. When the critical foundation of the considerations is unstable, the factors are not complete, or there is no comprehensive succession layout, the family’s generational succession will be challenging, perhaps even doomed to failure.

From the dimension standpoint, the assessment strategy shows that family capital (D) is the most important and influential dimension affecting inheritance strategy; see Table 9. Prioritizing assessment dimensions from highest to lowest, we obtain the following: family capital (D) → corporate attributes (B) → niche inheritance (E) → governance variables (B) → management concerns (C).

**Table 9.** Priorities for improvement.

Method	Priority for Improvement
Relational influence of dimensions’ network (per DEMATEL)	D → A → E → B → C
Inter-dimensional influence of individual criteria (per DEMATEL)	A: → (a <sub>1</sub> ) → (a <sub>2</sub> ) → (a <sub>3</sub> ) (a <sub>2</sub> ) → (a <sub>3</sub> )
	B: (b <sub>1</sub> ) → (b <sub>2</sub> )
	C: → (c <sub>1</sub> ) → (c <sub>2</sub> ) → (c <sub>3</sub> ) (c <sub>2</sub> ) → (c <sub>3</sub> )
	D: → (d <sub>2</sub> ) → (d <sub>3</sub> ) → (d <sub>1</sub> ) (d <sub>3</sub> ) → (d <sub>1</sub> )
	E: → (e <sub>1</sub> ) → (e <sub>2</sub> )

The five major facets and 13 criteria of family succession are integrated into an analytical framework. The results show that the factors for consideration of succession are not only diverse, but also require logical decision-making that is also relatively dynamic with consideration of mutual influence. When one of the key factors, such as the corporate environment or governance structure, changes, the priorities of other decision-making factors will change accordingly. From the criteria standpoint, the assessment strategy of inheritance showed family capital (D) to be the most important and influential dimension. Sorting the top five criteria from highest to lowest, we obtain the following: family tradition (d<sub>2</sub>) → family affection relationships (d<sub>3</sub>) → successor planning (e<sub>1</sub>) → industrial traits (a<sub>1</sub>) → corporate style (a<sub>2</sub>).

Based on field expert interviews and questionnaire responses, the results of this study provide a sequence of dimensions and criteria that will enable family businesses to more effectively analyze key inheritance factors and further promote the success of the family business through heritage. The results also show that family owners still perceive there to be room for improvement in the current status of family tradition (d<sub>2</sub>), family affection relationships (d<sub>3</sub>) and successor planning (e<sub>1</sub>) with values of 5.90%, 11.4% and 13.4%, respectively. The research results show that in order to meet the needs of an optimal inheritance plan, business owners still believe that the current status of family capital and niche heritage still has room for improvement of 35.07% and 34%, respectively. This improvement strategy would allow family businesses to achieve optimal results in terms of organizational reengineering, family business vision mapping and heritage succession as organizations face environmental changes. More importantly, the analytical framework and decision analysis method constructed in this paper can contribute to the theory of family business sustainable management, the continuation of the family business heritage and the development strategy. The research results can also be adapted to the decision-making environment of the family business and the strategic goals of inheritance and succession.

## 5. Conclusions and Limitations

Family businesses are an important part of the world economy, and the successful realization of intergenerational inheritance is the key to ensuring the sustainable development of a family business [6,24]. It is estimated that only 20% of the family business can be successfully passed down to the second generation, and no more than 10% passed down to the third generation. Only about 5% of Taiwanese family businesses have a succession plan, far below the global average of 16%, meaning that most Taiwanese companies face succession problems, leading to family split-ups, crises, corporate recession and even early termination of business operations.

Based on the existing literature on family business, starting from the theory of family business succession, using grounded theory, we conducted field interviews to uncover and code the key factors affecting succession. We interviewed Taiwanese entrepreneurs enrolled in a business inheritance training class to explore the considerations and implications of the succession. Finally, this work not only carries out an analysis of family business transmission and inheritance, but also analyzes the influence of key decision factors and related improvement strategy through multi-criteria decision-making methods.

The results show that the considerations for succession of authority in the family business are multi-dimensional, requiring a complex decision-making process. Among the key considerations, corporate characteristics, family capital and niche inheritance are the keys to family inheritance. Without these important factors, the outcome of the succession will be doomed to failure. In addition, the relationships of family affection and the trust and commitment of both the predecessor and successor are important factors that cannot be ignored, especially in a rapidly changing competitive market environment. With a correct understanding of the company's environmental factors and future development needs, family business practices can also be aligned with the family's business traditions and advantages, through the construction of the appropriate strategies and plans for succession [20]. By making the correct succession arrangements, the family business can finally ensure continued and sustainable development.

Certainly, this study has some limitations. First, only five facets are included, and the variables of interest are viewed from the perspective of Taiwan. Therefore, the scope of research can be expanded in future to include additional factors such as the sustainability of the family business and long-term orientation. Moreover, due to cultural differences, the criteria may not be generalizable or extendable to other countries. In addition, other studies combining and using different MADMs can provide insight into the considerations of family business heritage not found in this study. Future research can use different methodologies, such as longitudinal studies, to study this issue from different perspectives.

**Supplementary Materials:** The following are available online at <http://www.mdpi.com/2071-1050/10/10/3656/s1>.

**Author Contributions:** J.Y.L. proposed the ideas, collected and analyzed the data and wrote the paper.

**Funding:** This research received no external funding.

**Acknowledgments:** The author is extremely grateful to the Sustainability Journal Editorial Team and reviewers who provided valuable comments for improving the quality of this article.

**Conflicts of Interest:** The authors declare no conflict of interest.

## References

1. Oudah, M.; Jabeen, F.; Dixon, C. Determinants Linked to Family Business Sustainability in the UAE: An AHP Approach. *Sustainability* **2018**, *10*, 246. [[CrossRef](#)]
2. Chrisman, J.J.; Chua, J.H.; Sharma, P. Important attributes of successors in family businesses: An exploratory study. *Fam. Bus. Rev.* **1998**, *11*, 19–34. [[CrossRef](#)]
3. DeMassis, A.; Chua, J.; Chrisman, J. Factors preventing intra-family succession. *Fam. Bus. Rev.* **2008**, *21*, 183–199. [[CrossRef](#)]
4. Dumas, C.A. Preparing the new CEO: Managing the father-daughter succession process in family businesses. *Fam. Bus. Rev.* **1990**, *3*, 169–181. [[CrossRef](#)]

5. Beckhard, R.; Dyer, W.G. Managing Change in the Family Firm-Issues and Strategies. *Sloan Manag. Rev.* **1983**, *22*, 59–65.
6. Molly, V.; Laveren, E.; Deloof, M. Family business succession and its impact on financial structure and performance. *Fam. Bus. Rev.* **2010**, *23*, 131–147. [[CrossRef](#)]
7. Hamrouni, A.D.; Mnasser, K. Basics factors of success in family-owned businesses from second to third generation. *Int. J. Entrep. Small Bus.* **2013**, *18*, 57–78. [[CrossRef](#)]
8. Stavrou, E.T. A four factor model: A guide to planning next generation involvement in the family firm. *Fam. Bus. Rev.* **1998**, *11*, 135–142. [[CrossRef](#)]
9. Astrachan, J.; Klein, S.; Smyrniotis, K. The F-PEC scale of family influence: A proposal for solving the family business definition problem. *Fam. Bus. Rev.* **2002**, *15*, 45–58. [[CrossRef](#)]
10. Handler, W.C. Succession in family firms: A mutual role adjustment between entrepreneur and next-generation family members. *Entrep. Theory Pract.* **1990**, *15*, 37–51. [[CrossRef](#)]
11. Longenecker, J.G.; Schoen, J.E. Management succession in the family business. *J. Small Bus. Manag.* **1979**, *16*, 1–6.
12. Núñez-Cacho, P.; Molina-Moreno, V.; Corpas-Iglesias, F.A.; Cortés-García, F.J. Family Businesses Transitioning to a Circular Economy Model: The Case of “Mercadona”. *Sustainability* **2018**, *10*, 537. [[CrossRef](#)]
13. Le Breton-Miller, I.; Miller, D.; Steier, L.P. Toward an integrative model of effective FOB succession. *Entrep. Theory Pract.* **2004**, *28*, 305–328. [[CrossRef](#)]
14. Lansberg, I.; Astrachan, J.H. Influence of family relationships on succession planning and training: The importance of mediating factors. *Fam. Bus. Rev.* **1994**, *7*, 39–59. [[CrossRef](#)]
15. Dyer, W.G. *Cultural Change in Family Firms*; Jossey-Bass: San Francisco, CA, USA, 1986.
16. Churchill, N.C.; Hatten, K.J. Non-Market-Based Transfers of Wealth and Power: A Research Framework for Family Businesses. *Am. J. Small Bus.* **1987**, *11*, 51–64. [[CrossRef](#)]
17. O’Leary, S.; Swaffin-Smith, C. *Organic Model to Reflect the Transitional Nature of Family Firms*; Regent’s Working Papers in Business & Management, Working Paper 1501: RWPBM1501; REGENT’S University: London, UK, 2015.
18. Gersick, K.E.; Lansberg, I.; Desjardins, M.; Dunn, B. Stages and transitions: Managing change in the family business. *Fam. Bus. Rev.* **1999**, *12*, 287–297. [[CrossRef](#)]
19. Ramadani, V.; Bexheti, A.; Rexhepi, G.; Ratten, V.; Ibraimi, S. Succession issues in Albanian family businesses: An exploratory research. *J. Balk. Near East. Stud.* **2017**, *19*, 294–312. [[CrossRef](#)]
20. Mayer, R.; Davis, J.; Schoorman, D. An integrative model of organizational trust. *Acad. Manag. Rev.* **1995**, *20*, 709–734. [[CrossRef](#)]
21. Matthews, C.H.; Moore, T.W.; Fialko, A.S. Succession in the family firm: A cognitive categorization perspective. *Fam. Bus. Rev.* **1999**, *12*, 159–170. [[CrossRef](#)]
22. Barach, J.A.; Gantisky, J.; Carson, J.A.; Doochin, B.A. Entry of the next generation: Strategic challenge for family business. *J. Small Bus. Manag.* **1988**, *26*, 49–56.
23. Evert, R.E.; Martin, J.A.; McLeod, M.; Payne, G.T. Empirics in family business research: Progress, challenges, and the path ahead. *Fam. Bus. Rev.* **2016**, *29*, 17–43. [[CrossRef](#)]
24. Holt, D.T.; Madison, K.; Kellermanns, F.W. Variance in family members’ assessments: The importance of dispersion modeling in family firm research. *Fam. Bus. Rev.* **2017**, *30*, 61–83. [[CrossRef](#)]
25. Schein, E.H. The role of the founder in creating organizational culture. *Organ. Dyn.* **1983**, *12*, 13–28. [[CrossRef](#)]
26. Olson, P.D.; Zuiker, V.S.; Danes, S.M.; Stafford, K.; Heck, R.K.Z.; Duncan, K.A. The impact of the family and business on family business sustainability. *J. Bus. Ventur.* **2003**, *18*, 639–666. [[CrossRef](#)]
27. Anglin, A.H.; Reid, S.W.; Short, J.C.; Zachary, M.A.; Rutherford, M.W. An archival approach to measuring family influence: An organizational identity perspective. *Fam. Bus. Rev.* **2017**, *30*, 19–36. [[CrossRef](#)]
28. Handler, W. Succession in family business: A review of the research. *Fam. Bus. Rev.* **1994**, *7*, 273–286. [[CrossRef](#)]
29. Barach, J.A.; Ganitsky, J.B. Successful succession in family business. *Fam. Bus. Rev.* **1995**, *8*, 131–155. [[CrossRef](#)]
30. Denis, D.J.; Denis, D.K.; Sarin, A. Ownership structure and top executive turnover. *J. Financ. Econ.* **1997**, *45*, 193–221. [[CrossRef](#)]
31. Madison, K.; Holt, D.T.; Kellermanns, F.W.; Ranft, A. Viewing family firm behavior and governance through the lens of agency and stewardship theories. *Fam. Bus. Rev.* **2015**, *28*, 312–331. [[CrossRef](#)]

32. Chirico, F.; Nordqvist, M. Dynamic capabilities and trans-generational value creation in family firms: The role of organizational culture. *Int. Small Bus. J.* **2010**, *28*, 487–504. [[CrossRef](#)]
33. Kelly, L.M.; Athanassiou, N.; Crittenden, W.F. Founder centrality and strategic behavior in family-owned firm. *Entrep. Theory Pract.* **2000**, *25*, 27–42. [[CrossRef](#)]
34. Kotlar, J.; De Massis, A. Goal setting in family firms: Goal diversity, social interactions, and collective commitment to family-centered goals. *Entrep. Theory Pract.* **2013**, *37*, 1263–1288. [[CrossRef](#)]
35. Cabrera-Suarez, K. Leadership transfer and the successor's development in the family firm. *Leadersh. Q.* **2005**, *16*, 71–96. [[CrossRef](#)]
36. Boyne, G.A.; James, O.; John, P.; Petrovsky, N. Leadership succession and organizational success: When do chief executives make a difference? *Public Money Manag.* **2011**, *31*, 339–346. [[CrossRef](#)]
37. Sharma, P.; Chrisman, J.J.; Pablo, A.L.; Chua, J.H. Determinants of initial satisfaction with the succession process in family firms: A conceptual model. *Entrep. Theory Pract.* **2001**, *25*, 17–35. [[CrossRef](#)]
38. Cater, J.J.; Kidwell, R.E.; Camp, K.M. Successor team dynamics in family firms. *Fam. Bus. Rev.* **2016**, *29*, 301–326. [[CrossRef](#)]
39. Chrisman, J.J.; Sharma, P.; Taggar, S. Family influences on firms: An introduction. *J. Bus. Res.* **2007**, *60*, 1005–1011. [[CrossRef](#)]
40. Ali, Z.; Sun, H.; Ali, M. The Impact of Managerial and Adaptive Capabilities to Stimulate Organizational Innovation in SMEs: A Complementary PLS–SEM Approach. *Sustainability* **2017**, *9*, 2157. [[CrossRef](#)]
41. Sardeshmukh, S.; Corbett, A. The duality of internal and external development of successors: Opportunity recognition in family firms. *Fam. Bus. Rev.* **2011**, *24*, 111–125. [[CrossRef](#)]
42. McGivern, C. The dynamics of management succession: A model of chief executive succession in the small family firm. *Manag. Decis.* **1978**, *16*, 32–42. [[CrossRef](#)]
43. Feltham, T.S.; Feltham, G.; Barnett, J.J. The dependence of family businesses on a single decision-maker. *J. Small Bus. Manag.* **2005**, *43*, 1–15. [[CrossRef](#)]
44. Stanley, L.J.; Kellermanns, F.W.; Zellweger, T. Latent profile analysis: Understanding family firm profiles. *Fam. Bus. Rev.* **2017**, *30*, 84–102. [[CrossRef](#)]
45. Daspit, J.J.; Holt, D.T.; Chrisman, J.J.; Long, R.G. Examining family firm succession from a social exchange perspective. *Fam. Bus. Rev.* **2016**, *29*, 44–64. [[CrossRef](#)]
46. Danes, S.M.; Stafford, K.; Haynes, G.; Amarapurkar, S. Family capital of family firms bridging human, social, and financial capital. *Fam. Bus. Rev.* **2009**, *22*, 199–215. [[CrossRef](#)]
47. Ahn, S.Y. Founder Succession, The Imprint of Founders' Legacies, and Long-Term Corporate Survival. *Sustainability* **2018**, *10*, 1485. [[CrossRef](#)]
48. Cadieux, I. Succession in small and medium-sized family businesses: Toward a typology of predecessor roles during and after instatement of the successor. *Fam. Bus. Rev.* **2007**, *20*, 95–109. [[CrossRef](#)]
49. Dyer, W.G.; Handler, W. Entrepreneurship and family business: Exploring the connection. *Entrep. Theory Pract.* **1994**, *19*, 71–83. [[CrossRef](#)]
50. Sharma, P.; Irving, G. Four bases of family business successor commitment: Antecedents and consequences. *Entrep. Theory Pract.* **2005**, *29*, 13–33. [[CrossRef](#)]
51. Datta, D.K.; Guthrie, J.P. Executive succession: Organizational antecedents of CEO characteristics. *Strat. Manag. J.* **1994**, *15*, 569–577. [[CrossRef](#)]
52. Corbin, J.; Strauss, A. Grounded Theory Research: Procedures, Canons, and Evaluative Criteria. *Qual. Sociol.* **1990**, *13*, 3–21. [[CrossRef](#)]
53. Saaty, T.L. *Theory and Applications of the Analytic Network Process*; RWS Publications: Pittsburgh, PA, USA, 2005.
54. Liu, J.Y. An internal control system that includes corporate social responsibility for social sustainability in the new era. *Sustainability* **2018**, *10*, 3382. [[CrossRef](#)]
55. Tsai, W.H.; Chou, W.C.; Hsu, W. The sustainability balanced scorecard as a framework for selecting socially responsible investment: An effective MCDM model. *J. Oper. Res. Soc.* **2009**, *60*, 1396–1410. [[CrossRef](#)]
56. Hu, K.H.; Lin, S.J.; Liu, J.Y.; Chen, F.H. The Influences of CSR's Multi-dimensional Characteristics on Firm Value Determination by a Fusion Approach. *Sustainability* **2018**, in press.
57. Opricovic, S.; Tzeng, G.H. Extended VIKOR method in comparison with outranking methods. *Eur. J. Oper. Res.* **2007**, *178*, 514–529. [[CrossRef](#)]

58. Davis, P.; Harveston, P.D. The influence of family on the family business succession process: A multi-generational perspective. *Entrep. Theory Pract.* **1998**, *22*, 31–53. [[CrossRef](#)]
59. Madjid, T.; Debora, D.C.; Francisco, J.S.A. An extended stochastic VIKOR model with decision maker's attitude towards risk. *Inf. Sci.* **2018**, *432*, 301–318.



© 2018 by the author. Licensee MDPI, Basel, Switzerland. This article is an open access article distributed under the terms and conditions of the Creative Commons Attribution (CC BY) license (<http://creativecommons.org/licenses/by/4.0/>).

Article

# The Influences of CSR's Multi-Dimensional Characteristics on Firm Value Determination by a Fusion Approach

Kuang-Hua Hu <sup>1</sup>, Sin-Jin Lin <sup>2,\*</sup>, Jau-Yang Liu <sup>2</sup>, Fu-Hsiang Chen <sup>2</sup> and Shih-Han Chen <sup>2</sup>

<sup>1</sup> Accounting School, Nanfang College of Sun Yat-sen University, Guangzhou 510970, Guangdong, China; khhu0622@gmail.com

<sup>2</sup> Department of Accounting, Chinese Culture University, Taipei 11114, Taiwan; lcy13@faculty.pccu.edu.tw (J.-Y.L.); chenfuhsiang1@gmail.com (F.-H.C.); a0933837319@gmail.com (S.-H.C.)

\* Correspondence: annman1204@gmail.com; Tel.: +886-9-1225-8376

Received: 3 August 2018; Accepted: 23 October 2018; Published: 25 October 2018

**Abstract:** Corporate social responsibility (CSR) implementation has been widely acknowledged as playing a key part in enhancing firm value as well as achieving sustainable development. However, up to now the extant works in the literature have yielded non-conclusive results regarding the relationships between CSR and firm value. One of the possible reasons is that the studies ignore the multi-dimensional characteristics of CSR—that is, they merely utilize a singular synthesized indicator as a proxy to represent the corporate's CSR performance as being unreliable and problematic. Thus, this study breaks down CSR into numerous dimensions and further examines each dimension's impact on firm value. By doing so, managers can allocate their firm's valuable resources to suitable areas so as to increase its reputation and value. In addition, this research sets up an artificial intelligence (AI)-based fusion model, grounded by fusion learning theory that aims at complementing the error made by a singular model, to examine the relationship between CSR's multidimensional characteristics and firm value. Through different combinations of adopted strategies, users can realize the most representative features from an over-abundant database.

**Keywords:** artificial intelligence; corporate social responsibility; decision making; firm value

## 1. Introduction

Forecasting corporate financial troubles has become an essential topic of interest over the past few decades due to its great impact on publicly listed companies, current and potential stakeholders, and even a country's economy [1]. Financial resource providers need to evaluate the financial risk of a corporate before they make a financing decision or grant credit judgments on firms in order to avoid or prevent any tremendous financial shock and/or loss. Corporate suppliers and partners that conduct credit transactions with corporates also require a more detailed illustration of their financial status. If a prediction model is useful, then top-level managers can initiate some initial prevention such as adjusting their capital structure or modifying their financial leverage to avoid any deterioration in corporate status before financial trouble erupts. Current and potential investors can also utilize such a model to change their investment strategy as well as allocate monetary resources to more profitable places [2].

Multivariate discriminant analysis (MDA) was the most frequently utilized forecasting model before the 1980s. Altman [3] introduced a very famous forecasting architecture, the “Z-score”, that incorporated MDA with five financial ratios (i.e., working capital to total assets, retained earnings to total assets, earnings before interest and taxes to total assets, market value of equity to book value of total liabilities, and sales to total assets) so as to discriminate between healthy corporates



and non-healthy corporates. Although this model performs a satisfactory job in forecasting quality, it also comes with some statistical challenges, such as linear separability, independent predictors, and multivariate normality that usually do not hold in real applications. To overcome these obstacles, the literature has proposed the linear probability model (LPM) and logit or probit regression models. Meyer and Pifer [4] employed LPM to handle the task of the corporate financial bankruptcy forecasting task. Martin [5] assessed banks' financial troubles by relying on a logit model. Dimitras et al. [6] provided a detailed review of statistical-based approaches in financial crisis forecasting, indicating that the logit model achieves optimal forecasting performance.

In contrast with those studies that have broadly examined financial crisis prediction and credit risk forecasting, very few have looked into firm value forecasting. Poor firm management is widely recognized as being the main trigger for a financial crisis, and thus firm value can appropriately reflect the quality of corporate management. If managers can run their business with efficiency and target maximizing shareholders' wealth, then investors will likely pay more than average to own their stock. The higher the firm value is, the stronger and more developed it is.

How to increase firm value as well as sound a corporate's competitive edge turns out to be an essential task in this highly turbulent economic atmosphere. Although coming up with some generally accepted conclusions is quite difficult, it is widely acknowledged that corporates with good corporate social responsibility (CSR, which considers the voluntary integration of social and environmental concerns in a business operation and its interaction with stakeholders such as investors, shareholders, employees, suppliers, bankers, and regulators) have the prescribed means for addressing the challenge of globalization and increasing their competitive advantages (Organization for Economic Co-operation and Development, OECD). That is the reason why so many executives and researchers have devoted considerable amount of time and efforts to investigate the influence of CSR on firm value.

Although there are many different types of definitions and dimensions of CSR in the extant studies, Carroll [7–9] defined four CSR dimensions: a corporate should (1) obey the laws and regulations announced by governments in its daily operations, (2) make products or provide services for customers to achieve suitable profitability in the process, (3) meet shareholders' expectations and protect their wealth, and (4) strengthen and increase human welfare or firm reputation. Based on these perspectives, CSR consists of numerous factors, such as community involvement, labor security, environmental protection, human rights, and business standards. CSR may also function similarly to advertising, by enlarging a firm's profit spread, increasing the demand for products and services, eliminating buyers' price sensitivity, and solidifying consumer loyalty [10–12].

Most research works attempt to identify the link between CSR and firm value in order to examine why firms engage in CSR [13,14]. Unfortunately, there is no conclusive theory that can explain the relation between CSR and firm value, although two dominant theories do exist. The agency theory [15] indicates that corporates performing CSR activities see a decrease in firm value when managers use the firm's limited resources to draw benefits of personal reputation at the expense of shareholders [16]. On the other hand, the conflict resolution theory notes that corporates with high CSR activities can lead to higher firm value by mitigating conflicts of interest between managers and investors, raising firm reputation, and enhancing firm profitability [17]. It also views CSR as a strategic investment to increase a firm's competitive edge. The existing research on the relation between CSR and firm value is mixed and sometimes confusing [18]. One of the possible reasons for not reaching a consensus conclusion comes from the effect of the quality–quantity trade-off among each one of the CSR dimensions [2,19,20]. CSR encompasses economic, environmental, business, and social behaviors. Only using one synthesized indicator as a proxy to depict a corporate's CSR performance is not reliable and trustworthy. Therefore, there is an urgent requirement to decompose CSR into some dimensions and further examine the impact of each dimension on firm value.

How to determine the most essential dimension on firm value is quite similar to handling the task of feature selection. The fundamental concept of feature selection is identifying a subset from the original set of features without impeding the model's forecasting performance as well as improving

the quality of the data and facilitating the calculation efficiency [21]. However, most related works that considered feature selection are based on one pre-decided method. It is widely deemed that different method adoptions are likely to yield different outcomes (i.e., different selected features). If we can apply a number of dissimilar feature selection approaches and then combine the selection results, then we not only can realize the most essential feature that all the feature selection approaches “agree” on, but also enhance the model’s forecasting accuracy over utilizing one feature selection approach [22].

This basic idea of combining multiple feature selection approaches is inspired by the ensemble learning theory—that is, the combination strategy is able to complement the error made by a singular method. By doing so, decision makers can realize which dimension of CSR has the greatest influence on firm value. Managers can then consider the potential implications to allocate valuable resources to an appropriate place so as to maximize stakeholders’ wealth and sustain the firm’s reputation. The selected outcome can then be entered into an emerging neural network-based model, namely support vector machine (SVM), to construct the firm value forecasting model. SVM [23], grounded on statistical learning theory, produces an optimal separating hyperplane to discriminate two dissimilar class labels. There are some benefits in performing SVM [24]: (1) there are only two parameters to be decided, (2) the solution of SVM is optimal and unique, and (3) the model has greater tolerance on extreme values. Due to these advantages, SVM was performed by this study. Investors can take the proposed model as a roadmap to adjust their investment portfolios so as to reach the goal of sustainable development.

The rest of this article is organized as follows. Section 2 reviews the existing literature of CSR’s impact on firm value. Section 3 proposes our research design. Section 4 shows the experimental results. Section 5 concludes.

## **2. Literature Review**

### *Corporate Social Responsibility and Firm Value*

McWilliams and Siegel [25] indicated that corporate social responsibility (CSR) is deemed as “actions that appear to further some social good, beyond the interests of the firm and that which is required by law”. Based on this description, CSR activities not only have influence on investing stakeholders such as bankers, suppliers, stockholders, and debt holders, but also have an impact on non-investing investors such as buyers, community, public sectors, and others. CSR-related research topics have been discussed for the last three decades or so with most of the discussions centered on one question: Does CSR help to enhance firm value?

The “overinvestment hypothesis” indicates that the relation between CSR activities and firm value is negative [16]. The agency cost theory stems from the separation of ownership and control when top-level executives/managers have insufficient residual claims on a firm. Based on this theory, executives/managers tend to use corporate resources to enhance their personal reputation and to be entrenched as socially responsible managers at the expense of shareholders—that is, the managers have an incentive to overinvest CSR beyond the optimal level, further resulting in destruction of firm value. Galakiewicz and Burt [26] indicated that CEOs investing in philanthropy will result in acquiring reputation and influential relations with local business elites. In the work done by Werbel and Carter [27], they stated that CEOs’ membership in charitable institutes is positively related to corporate giving. Barnea and Rubin [16] found that executives prefer to overly invest in CSR when they do not bear any cost, but instead enjoy the benefits of increased personal reputations in the community.

According to the “conflict resolution hypothesis”, “stakeholder theory”, or “reputation-building hypothesis” [28–30], one can contend that CSR enhances firm value by balancing the interests of all stakeholders (i.e., investing stakeholders and non-investing stakeholders) and by eliminating the risk of resource acquisitions [31]. Ruf et al. [32] indicated that the changes in CSR status are positively related to firm financial performance. Wang and Choi [33] argued that a firm with good stakeholder relations will contribute largely to its financial performance. Crifo et al. [34] stated that CSR activities

help to eliminate the impact of information asymmetry. Thus, CSR activities can increase firm value by reducing the conflict of interest between managers and non-investing stakeholders.

Even if many existing studies conclude that the relation between CSR and firm value is positive, there is no concrete consensus so far [34]. One of the possible reasons is that CSR activities are multi-dimensional and consist of social, environmental, ethics, and business behaviors. Merely performing a synthesized indicator for CSR performance could lead to a confused result about the relation between CSR and firm value [35]. Thus, there is an urgent need to decompose CSR into some dimensions and further examine the influence of each dimension on firm value.

### **3. Research Design**

#### *3.1. The Research Sample*

China has experienced amazing and admirable economic growth and improvement since the 1980s, but this growth comes with high social costs and environmental pollution. In order to overcome the challenges, the China government has encouraged firms publicly listed on the Shenzhen and Shanghai Stock Exchanges to engage in CSR and provided some incentives to motivate firms to do so, including the “green loan policy” and “green securities” [36]. Moreover, in September 2006 the Shenzhen Stock Exchange provided guidance called “Shenzhen Stock Exchange Social Responsibility Introductions to Listed Companies” for encouraging listed firms to perform CSR activities and list them in their financial reports, while Shanghai Stock Exchange yields guidelines requested the listed companies to disclose CSR issues, including “Notice on Strengthening Listing Companies’ Assumptions of Social Responsibility” and “Guideline on Listed Companies’ Environmental Information Disclosure” launched in May 2008. Stated-owned companies controlled by the central government still need to follow the regulation provided by State-Owned Assets Supervision and Administration Commission of the State Council (SASAC) [37]. In light of the CSR guidelines or regulations, the volume of CSR report disclosures or CSR activities has been growing dramatically since 2008 [38]. Furthermore, some managers viewed CSR activities as strategic investments. By doing CSR activities, firms can gain some benefits and competitive edges. To examine the relation between CSR and firm value, this study takes the top 100 companies in China as a research sample. The data were gathered from the Taiwan Economic Journal (TEJ) databank and Research Report on Corporate Social Responsibility of China for the period 2013–2015.

#### *3.2. The Dependent Variable*

According to previous research works done by Sheikh [14], Lee, and Heo [39] and Buchanan et al. [17], the firm value is determined by Tobin’s Q, which is computed as the market value of assets divided by the book value of assets. The market value of assets is the market value of equity plus the book value of assets minus the book value of common equity net of deferred taxes. It is the most widely implemented measure of firm value [40]. Based on the information of Research Report on Corporate Social Responsibility of China, we can see the top 100 companies’ CSR performance. The top 50% of firm values are designated as 1 “good performance”, while the other 50% are designated as 0 “bad performance”. By doing so, this problem has been transformed into a traditional binary classification task.

#### *3.3. Combination Strategy*

Due to the data being gathered from financial statements, some of them may be contaminated by some degree of error, and thus data cleaning is an inevitable pre-process. Because decision tree (DT) has the merits of being easy-to-use, is comprehensive, and automatically shifts through large, complex databases in searching for and isolating essential features, two different kinds of DT (C4.5 and CART) were conducted. A relative emerging soft computing technique, namely rough set theory (RST) that can handle data with impreciseness, uncertainty, and vagueness, was proposed by Pawlak [41].

It has demonstrated its usefulness in feature selection, knowledge reasoning, and granular computing, and it also performed a satisfactory job in numerous research domains. However, no current research, grounded on the fusion learning theory, has constructed an advanced model to examine the relationships between each CSR dimension and firm value. To examine the effectiveness of the fusion learning theory, this study introduces three different kinds of combination strategies: isolation, combination, and union. The conceptual structures of the three different combination strategies are represented in Figure 1.

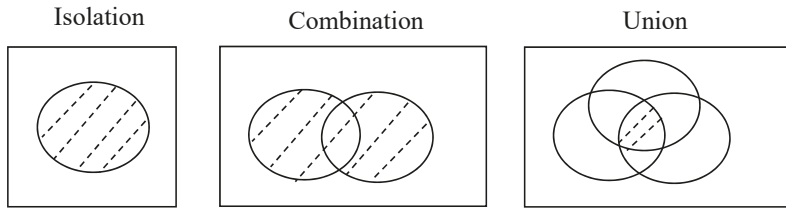

Figure 1. The combination strategies.

### 3.4. Variable Definition

There are many methods to measure firm value, such as Tobin's Q, economic added value, etc. Because Tobin's Q can be used to measure the values of tangible and intangible assets and the figures calculated by it are closest to the market price, this study used Tobin's Q as a method to measure firm value. Tobin's Q is defined as the market value of an enterprise divided by its assets. The higher the value is, the better the investment opportunities and competitive advantages an enterprise has.

The calculation formula of Tobin's Q is as follows:

$$\text{Tobin's } Q_{it} = \frac{(MV_{it} + PS_{it} + DEBT_{it})}{TA_{it}} \quad (1)$$

MV: a multiplication of the closing price of ordinary stock at the end of period t with the number of outstanding common shares during period t. PS: a multiplication of the closing price of special shares at the end of period t with the number of outstanding special shares during period t. DEBT: is equal to current liabilities during period t minus current assets during period t, plus long-term liabilities during period t. TA: is the total assets during period t.

Previous studies have yielded non-conclusive results regarding the relation between CSR and firm value. One of the possible reasons is they ignored CSR's multi-dimensional characteristics. To reach a more conclusive and precise result, this study followed the "Research Report on Corporate Social Responsibility of China" and divided CSR performance into four dimensions (see Figure 2).

The control variables are represented as follows (see Table 1).

1. DEBT: Modigliani and Miller [18] pointed out that debt financing affects a firm's tax shield—the more the enterprise financing, the higher the tax savings benefit, which can create firm value. Therefore, this study considered it as one of the variables affecting firm value.
2. AGE: The measure method is to take the period from the establishment year to the current year of the sample company as AGE. Calantone et al. [42] indicated that a company with a larger AGE is more efficient in responding to market information and has better corporate performance compared to that with a smaller AGE.
3. R&D: Grabowski and Mueller [43] and McWilliams and Siegel [25] suggested that more research and development expenses imply better firm business performance. Therefore, this study regarded it as one of the variables affecting firm value.

4. SALES<sub>G</sub>: Mak and Kusnadi [44] and McWilliam and Siegel [25] indicated that an enterprise's revenue growth could affect the business performance of an enterprise. Therefore, this study regarded it as one of the variables affecting firm value.
5. ROA: Sakhartov and Folta [45] showed that the return on assets is an overall effect index of enterprise capital operations, as higher profits denote higher firm value.

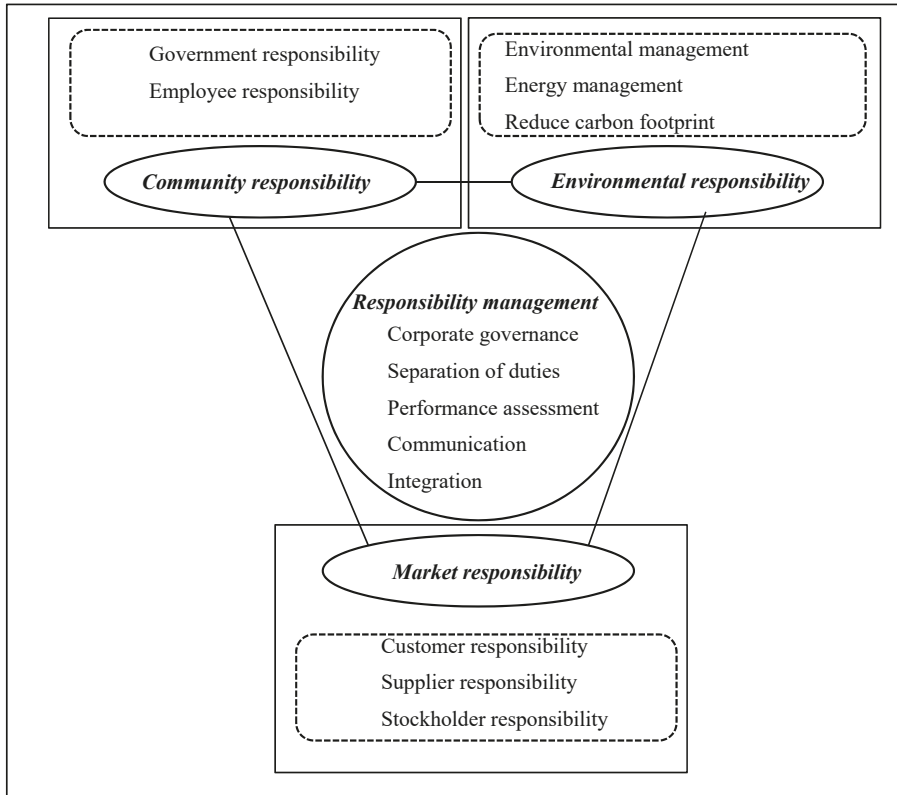

Figure 2. The corporate social responsibility (CSR) multi-dimensional structure.

Table 1. Independent variables.

Symbol	Illustration
X1: Responsibility management	Disclose the current situation of an enterprise's responsibility management
X2: Market responsibility	Disclose the performance of an enterprise's market responsibility
X3: Community responsibility	Disclose the corporate's community responsibility performance
X4: Environmental responsibility	Disclose the performance of an enterprise's environmental responsibility
X5: DEBT	Total liabilities/total assets
X6: AGE	Current year—establishment year
X7: RD	R&D expenditure/net sales revenue
X8: SALES <sub>G</sub>	(Net sales income for the current year—sales revenue for the previous year)/sales revenue for the previous year
X9: ROA	Net profit after tax + Interest * (1 – tax rate)/average total assets

## 4. Empirical Examinations

### 4.1. Data

This study collected 900 CSR variables of the top 100 state-owned enterprises, private enterprises, and foreign enterprises from 2013 to 2015 in the Research Report on Corporate Social Responsibility of China and gathered the variables related to firm value by TEJ according to the above-mentioned samples. Because the foreign enterprises of China are not listed in China, it was difficult to collect the variables related to firm value from the China part of TEJ. Therefore, 300 samples of Chinese foreign-funded enterprises from 2013 to 2015 were excluded. As the state-owned enterprises in China and private enterprises of China include unlisted enterprises, we had a total of 270 samples in this study after deducting unlisted enterprises and ones that lacked data (see Table 2).

**Table 2.** Sample selection rule.

Sample Selection Process	Sample Number
Sample number of top 100 state-owned enterprises, private enterprises, and foreign enterprises issued by the Blue Book of Corporate Social Responsibility of China from 2013 to 2015	900
Minus: the number of enterprises that are not listed or ones in which the relevant financial information is not able to be found in the Taiwan Economic Journal (TEJ)	630
Final sample number	270

### 4.2. Descriptive Statistics

The descriptive statistics of this study's relevant variables are shown in Table 3. With regard to the dependent variables, the median of firm value is 366.21. Based on whether it is greater or less than this median, this study set the firm value as 0 or 1, where 0 represents the enterprise with a worse firm value and 1 represents the enterprise with a better firm value. In the aspect of the independent variables, among four indicators included in CSR, the maximum value of responsibility management and market responsibility is 100, and the minimum value is 0, indicating that the highest score in Chinese enterprises is 100 and the lowest score is 0 in these two indicators. The maximum value of social responsibility is 95.5 and the minimum value is 0, showing that the highest score of Chinese enterprises is 95.5 and the lowest score is 0 in this indicator. The maximum value of environmental responsibility is 100 while the minimum value is 0, implying that the highest score obtained by Chinese enterprises is 100, and the lowest score is 0 in this indicator.

**Table 3.** Descriptive statistics of the variables.

Variable	AVG	S.D.	Q1	Median	Q3	Max	Min
X1	40.1	33.63	10	34.65	70	100	0
X2	43.61	27.78	18.3	47.35	65	100	0
X3	40.31	27.27	13.7	42.65	64	95.5	0
X4	33.78	28.1	6.7	31.1	58	100	0
X5	64.29	20.52	50.24	66.79	79.44	94.86	9.14
X6	22.84	20.24	14	17	24	107	0
X7	2.46	17.60	0	0.25	2.1	288.17	0
X8	1.16	17.80	−0.04	0.06	0.14	292.54	−0.41
X9	3.84	4.04	1.42	2.81	5.51	19.05	−13.33
Y	45,562.7	324,778.23	147.68	366.21	760.99	4,674,101.35	0.07

Y denotes the firm value; AVG: average; S.D.: standard deviation; Max: maximum; Min: minimum.

The average value of DEBT (X5) is 64.29, indicating the average ratio of total liabilities of sample enterprises to total assets, while the median is 66.79, which indicates that the DEBT (X5) of half of the

sample enterprises is 66.79; the average value of AGE is 22.84, indicating the average AGE (X6) of sample enterprises; the median of RD (X7) is 0.25, which indicates that RD (X7) of half of the sample enterprises is up to 0.25; the average number of SALESG (X8) is 1.16 while the median is 0.06 and at least the SALESG (X8) of one half of the sample enterprises is up to 6%; the average value of ROA (X9) is 3.84.

4.3. Results

To examine the effectiveness of the introduced fusion mechanism, this study divided the experiments into three different scenarios: isolation, combination, and union. How to determine a model’s forecasting quality is an essential topic in practical applications, with accuracy or error rate being one of the most widely adopted assessment criteria. However, only relying on one assessment criterion to identify a model’s forecasting quality is not reliable and robust. To overcome this problem, two other assessment criteria—namely, type I error and type II error—were considered.

Table 4 shows the essential variables under three different scenarios. We can see that the most essential variables are X4 (Environment responsibility) and X5 (DEBT). This finding is in accordance with previous research studies [46,47], which stated that the debt ratio has the most significant impact on firm value. In addition, Konar and Cohen [46] indicated that a firm with better environmental responsibility normally has higher firm value, because these firms will focus on green production and offer products with less CO<sub>2</sub> emissions, thus helping out the firm’s reputation while also increasing its profitability. Through a fusion strategy, users can realize the most representative features from an over-abundant database. Managers also may consider the potential implications of allocating valuable resources to suitable places and to formulating future policies that can reach sustainable development.

Table 4. The selected variables under three different scenarios (all samples).

Scenario	Selected Variables
Isolation	
C4.5	X1: Responsibility management, X4: Environmental responsibility, X5: DEBT, X7: RD, X8: SALESG
CART	X2: Market responsibility, X4: Environmental responsibility, X5: DEBT, X6: AGE, X8: SALESG
RST	X1: Responsibility management, X4: Environmental responsibility, X5: DEBT, X6: AGE, X9: ROA
Combination	
$C4.5 \cap CART$	X4: Environmental responsibility, X5: DEBT, X8: SALESG
$C4.5 \cap RST$	X1: Responsibility management, X4: Environmental responsibility, X5: DEBT
$CART \cap RST$	X4: Environmental responsibility, X5: DEBT, X6: AGE
Union	
$C4.5 \cup CART \cup RST$	X4: Environmental responsibility, X5: DEBT

Table 5 shows the model’s forecasting quality under three different combination strategies. Support vector machine (SVM) was taken as a forecasting model. We see that the introduced fusion model (i.e., union strategy) not only reaches the optimal forecasting accuracy, but also presents less biased outcomes. This finding correlates to the concept of the fusion learning theory, which aims at complementing the error made by a singular method [48]. It also has been widely deemed as one of the most efficient ways to increase a model’s forecasting quality. Even a fraction of forecasting accuracy improvement can translate into large future savings. Thus, constructing a forecasting model grounded on the fusion learning theory is an urgent requirement in today’s highly competitive environment.

**Table 5.** The forecasting results (all samples).

Scenario	Assessment Criteria		
	Accuracy	Type I Error	Type II Error
Isolation			
C4.5	64.07	37.04	34.81
CART	62.22	40.74	34.81
RST	70.00	27.41	32.59
Combination			
C4.5∩CART	72.96	27.41	26.67
C4.5∩RST	72.22	29.63	25.93
CART∩RST	74.44	25.93	25.19
Union			
C4.5∪CART∪RST	82.96	17.78	16.30

To reach a more robust outcome, we further divided all the samples into two different groups: (1) group 1 contains all the state-owned enterprises, and (2) group 2 contains all the private enterprises. The selected features from each group are expressed in Table 6. We can see that the X4: Environmental responsibility still poses considerable influence on firm value. The state-own enterprises invested considerable amount of resource in R&D development so as to upgrade its industrial level. The private enterprises focused more on profitability to reach a goal of shareholder's wealth maximization.

**Table 6.** The selected variables from two different groups under three different scenarios.

Group	Scenario	Selected Variables	
Isolation			
Group 1 (all state-own enterprises)	C4.5	X3: Community responsibility, X4: Environmental responsibility, X5: DEBT, X7: RD, X8: SALESG	
	CART	X1: Responsibility management, X4: Environmental responsibility, X5: DEBT, X7: RD	
	RST	X2: Market responsibility, X4: Environmental responsibility, X5: DEBT, X6: AGE, X7: RD, X9: ROA	
	Combination		
	C4.5∩CART	X4: Environmental responsibility, X5: DEBT	
	C4.5∩RST	X4: Environmental responsibility, X7: RD	
	CART∩RST	X4: Environmental responsibility, X5: DEBT, X7: RD	
	Union		
	C4.5∪CART∪RST	X4: Environmental responsibility, X7: RD	
Isolation			
Group 2 (all private enterprises)	C4.5	X3: Community responsibility, X4: Environmental responsibility, X6: AGE, X8: SALESG, X9: ROA	
	CART	X2: Market responsibility, X4: Environmental responsibility, X5: DEBT, X6: AGE, X9: ROA	
	RST	X3: Community responsibility, X4: Environmental responsibility, X6: AGE, X7: RD, X9: ROA	
	Combination		
	C4.5∩CART	X4: Environmental responsibility, X6: AGE, X9: ROA	
	C4.5∩RST	X3: Community responsibility, X4: Environmental responsibility, X6: AGE, X9: ROA	
	CART∩RST	X4: Environmental responsibility, X6: AGE, X9: ROA	
	Union		
	C4.5∪CART∪RST	X4: Environmental responsibility, X6: AGE, X9: ROA	



## 5. Conclusions and Further Research

The many empirical research works up to date have identified no conclusive pattern in the relation between CSR and firm value. Ignoring CSR's multi-dimensional characteristics is one of the possible reasons for this absence of a consensus conclusion. Given this concern, this study followed the "Research Report on Corporate Social Responsibility of China" to decompose CSR into four dimensions and further examine the impact of each CSR's dimension on firm value. The focus of previous studies has been to identify "the single best" mechanism that is most precise for a pre-decided financial task, but this reliance on a single mechanism may be misguided and could contain some biases. To reach a more sound research outcome, a multiple combination strategy, grounded on the ensemble learning theory, was conducted herein. The basic idea of the ensemble learning theory is to complement the error made by a singular mechanism. Through different combinations of adopted strategies, users can realize the most representative features from an over-abundant database and find the most influential dimension on firm value.

The results herein indicate that X4: Environmental responsibility is the most essential element on firm value determination. The reason is because the Chinese government has placed much more emphasis on environmental protection and retains "vote power" over major decisions. In other words, if a corporate pollutes the environment, then the government has the right to delist the corporate regardless of major investors' decisions. Managers of firms can consider the potential implications of these results and allocate valuable resources to an appropriate place in order to enhance their firm's CSR performance, increase firm value, and reach the goal of sustainable development. Investors can look to invest in firms that have better resource utilization efficiency so as to maximize their wealth under anticipated risk exposure.

Certainly, this study has some limitations. First of all, this research was an exploratory study carried out with a high level of technology and a small sample. Larger samples with greater explanatory power will allow for more complex assessments in the future. Second, the effects of corporate social responsibility implementation include economic, social, and environmental impacts. All of these effects have short-term and long-term effects. Furthermore, some companies have implemented corporate social responsibility for some time, but some companies have begun to implement corporate social responsibility in accordance with government regulations. Although this study only attempts to explore the impact of stock prices (Tobin Q). Future research can continue to explore the long-term effectiveness of CSR through long-term concepts such as customer loyalty and/or sustainable value index. Finally, other studies combining and using different multiple attributes decision makings (MADMs) can provide insight into the unrecognized facets of CSR in this study. Future research can use different research methods such as time series analysis and prediction method to continue to study this issue.

**Author Contributions:** Formal analysis, S.-H.C. and F.-H.C.; Methodology, S.-J.L. and F.-H.C.; Writing—original draft, K.-H.H.; Writing—review & editing, J.Y.L. and F.-H.C.

**Funding:** Ministry of Science and Technology, R.O.C. for financially supporting this work under Contracts No. MOST. 106-2410-H-034-011-MY3 and No. MOST 107-2410-H-034-016.

**Conflicts of Interest:** No conflict of interest exists in the submission of this manuscript.

## References

1. Wanke, P.; Barros, C.P.; Figueiredo, O. Measuring efficiency improvement in Brazilian trucking: A Distance Friction Minimization approach with fixed factors. *Measurement* **2014**, *54*, 166–177. [[CrossRef](#)]
2. Lin, S.J.; Hsu, M.F. Decision making by extracting soft information from CSR news report. *Technol. Econ. Dev. Econ.* **2018**, *24*, 1344–1361. [[CrossRef](#)]
3. Altman, E. Financial ratios, discriminant analysis and the prediction of corporate bankruptcy. *J. Financ.* **1968**, *23*, 589–609. [[CrossRef](#)]
4. Meyer, P.A.; Pifer, H.W. Prediction of bank failures. *J. Financ.* **1970**, *25*, 853–868. [[CrossRef](#)]

5. Martin, D. Early warning of bank failure. A logistic regression approach. *J. Bank. Financ.* **1977**, *1*, 249–276. [[CrossRef](#)]
6. Dimitras, A.I.; Zanakis, S.H.; Zopounidis, C. A survey of business failures with an emphasis on prediction methods and industrial applications. *Eur. J. Oper. Res.* **1996**, *90*, 487–513. [[CrossRef](#)]
7. Carroll, A.B. A three-dimensional model of corporate performance. *Acad. Manag. Rev.* **1979**, *4*, 497–505. [[CrossRef](#)]
8. Carroll, A.B. The pyramid of corporate social responsibility: Toward the moral management of organizational stakeholders. *Bus. Horiz.* **1991**, *34*, 39–48. [[CrossRef](#)]
9. Carroll, A.B. The four faces of corporate citizenship. *Bus. Soc. Rev.* **1998**, *100*, 1–7. [[CrossRef](#)]
10. Aguinis, H.; Glavas, A. What we know and don't know about corporate social responsibility a review and research agenda. *J. Manag.* **2012**, *38*, 932–968. [[CrossRef](#)]
11. Dahlsrud, A. How corporate social responsibility is defined: An analysis of 37 definitions. *Corp. Soc. Responsib. Environ. Manag.* **2008**, *15*, 1–13. [[CrossRef](#)]
12. Farrington, T.; Curran, R.; Gori, K.; O'Gorman, K.D.; Queenan, C.J. Corporate social responsibility: Reviewed, rated, revised. *Int. J. Contemp. Hosp. Manag.* **2017**, *29*, 30–47. [[CrossRef](#)]
13. Lindgreen, A.; Swaen, V. Corporate social responsibility. *Int. J. Manag. Rev.* **2010**, *12*, 1–7. [[CrossRef](#)]
14. Sheikh, S. Corporate social responsibility, product market competition, and firm value. *J. Econ. Bus.* **2018**, *98*, 40–55. [[CrossRef](#)]
15. Jensen, M.C.; Meckling, W.H. Theory of the Firm: Managerial Behavior, Agency Cost and Ownership Structure. *J. Financ. Econ.* **1976**, *3*, 305–360. [[CrossRef](#)]
16. Barnea, A.; Rubin, A. Corporate social responsibility as a conflict between shareholders. *J. Bus. Ethics* **2010**, *97*, 71–86. [[CrossRef](#)]
17. Buchanan, B.; Cao, C.X.; Chen, C. Corporate social responsibility, firm value, and influential institutional ownership. *J. Corp. Financ.* **2018**, *52*, 73–95. [[CrossRef](#)]
18. Modigliani, F.; Merton, H.M. Corporate Income Taxes and the Cost of Capital: A Correction. *Am. Econ. Rev.* **1963**, *53*, 433–443.
19. Cavaco, S.; Crifo, P. CSR and financial performance: Complementarity between environmental, social and business behaviours. *Appl. Econ.* **2014**, *46*, 3323–3338. [[CrossRef](#)]
20. Pope, S.; Wæraas, A. CSR-washing is rare: A conceptual framework, literature review, and critique. *J. Bus. Ethics* **2015**, *137*, 173–193. [[CrossRef](#)]
21. Zhang, Y.; Zhang, Z. Feature subset selection with cumulate conditional mutual information minimization. *Expert Syst. Appl.* **2012**, *39*, 6078–6088. [[CrossRef](#)]
22. Tsai, C.F.; Hsiao, Y.C. Combining multiple feature selection methods for stock prediction: Union, intersection, and multi-intersection approaches. *Decis. Support Syst.* **2010**, *50*, 258–269. [[CrossRef](#)]
23. Vapnik, V. *The Nature of Statistical Learning Theory*; Springer: New York, NY, USA, 1995.
24. Shin, K.S.; Lee, T.S.; Kim, H. An application of support vector machines in bankruptcy prediction model. *Expert Syst. Appl.* **2005**, *28*, 127–135. [[CrossRef](#)]
25. McWilliams, A.; Siegel, D. Corporate social responsibility: A theory of the firm perspective. *Acad. Manag. Rev.* **2001**, *26*, 117–127. [[CrossRef](#)]
26. Galaskiewicz, J.; Burt, R.S. Interorganization contagion in corporate philanthropy. *Adm. Sci. Q.* **1991**, *36*, 88–105. [[CrossRef](#)]
27. Werbel, J.D.; Carter, S.M. The CEO's influence on corporate foundation giving. *J. Bus. Ethics* **2002**, *40*, 47–60. [[CrossRef](#)]
28. Freeman, R.E. *Strategic Management: A Stakeholder Approach*; Pitman Publishing: Boston, MA, USA, 1984.
29. Jo, H.; Harjoto, M. Corporate governance and firm value: The impact of corporate social responsibility. *J. Bus. Ethics* **2011**, *103*, 351–383. [[CrossRef](#)]
30. Makni, R.; Francoeur, C.; Bellavance, F. Causality between corporate social performance and financial performance: Evidence from Canadian firms. *J. Bus. Ethics* **2009**, *89*, 409–422. [[CrossRef](#)]
31. Backhaus, K.; Stone, B.A.; Heiner, K. Exploring the relationship between corporate social performance and employer attractiveness. *Bus. Soc.* **2002**, *41*, 292–318. [[CrossRef](#)]
32. Ruf, B.M.; Muralidhar, K.; Brown, R.M.; Janney, J.J.; Paul, K. An empirical investigation of the relationship between change in corporate social performance and financial performance: A stakeholder theory perspective. *J. Bus. Ethics* **2001**, *32*, 143–156. [[CrossRef](#)]

33. Wang, H.; Choi, J. A new look at the corporate social–financial performance relationship. *J. Manag.* **2013**, *39*, 416–441. [[CrossRef](#)]
34. Crifo, P.; Diaye, M.A.; Pekovic, S. CSR related management practices and firm performance: An empirical analysis of the quantity–quality trade-off on French data. *Int. J. Prod. Econ.* **2016**, *171*, 405–416. [[CrossRef](#)]
35. Surroca, J.; Trib, J.A.; Waddock, S. Corporate responsibility and financial performance: The role of intangible resources. *Strateg. Manag. J.* **2010**, *31*, 463–490. [[CrossRef](#)]
36. Kao, E.H.; Yeh, C.C.; Wang, L.H.; Fung, H.G. The relationship between CSR and performance: Evidence in China. *Pac.-Basin Financ. J.* **2018**, *51*, 155–170. [[CrossRef](#)]
37. Li, Q.; Luo, W.; Wang, Y.; Wu, L. Firm performance, corporate ownership, and corporate social responsibility disclosure in China. *Bus. Ethics* **2013**, *22*, 159–173. [[CrossRef](#)]
38. Marquis, C.; Qian, C. Corporate social responsibility reporting in China. *Organ. Sci.* **2014**, *25*, 127–148. [[CrossRef](#)]
39. Lee, S.; Heo, C.Y. Corporate social responsibility and customer satisfaction among US publicly traded hotels and restaurants. *Int. J. Hosp. Manag.* **2009**, *28*, 635–637. [[CrossRef](#)]
40. Bebchuk, A.; Cohen, A.; Ferrell, A. What Matters in Corporate Governance? *Rev. Financ. Stud.* **2009**, *22*, 783–827. [[CrossRef](#)]
41. Pawlak, Z. Rough Sets. *Int. J. Comput. Inf. Sci.* **1983**, *11*, 341–356. [[CrossRef](#)]
42. Calantone, R.J.; Tamer Cavusgil, S.; Zhao, Y. Learning orientation, firm innovation capability, and firm performance. *Ind. Mark. Manag.* **2002**, *31*, 515–524. [[CrossRef](#)]
43. Grabowski, H.G.; Mueller, D.G. Industrial research and development, intangible capital stocks, and firm profit rates. *Bell J. Econ.* **1978**, *9*, 328–343. [[CrossRef](#)]
44. Mak, Y.T.; Kusnadi, Y. Size Really Matters: Further Evidence on the Negative Relationship between Board Size and Firm Value. *Pac. Basin Financ. J.* **2005**, *13*, 301–318. [[CrossRef](#)]
45. Sakhartov, A.V.; Folta, T.B. Getting beyond relatedness as a driver of corporate value. *Strateg. Manag. J.* **2015**, *36*, 1939–1959. [[CrossRef](#)]
46. Konar, S.; Cohen, M.A. Does the market value environmental performance? *Rev. Econ. Stat.* **2001**, *83*, 281–289. [[CrossRef](#)]
47. Wahba, H. Does the market value corporate environmental responsibility? An empirical examination. *Corp. Soc. Responsib. Environ. Manag.* **2008**, *15*, 89–99. [[CrossRef](#)]
48. Hsu, M.F.; Yeh, C.C.; Lin, S.J. Integrating dynamic Malmquist DEA and social network computing for advanced management decisions. *J. Intell. Fuzzy Syst.* **2018**, *35*, 231–241. [[CrossRef](#)]



© 2018 by the authors. Licensee MDPI, Basel, Switzerland. This article is an open access article distributed under the terms and conditions of the Creative Commons Attribution (CC BY) license (<http://creativecommons.org/licenses/by/4.0/>).



MDPI  
St. Alban-Anlage 66  
4052 Basel  
Switzerland  
Tel. +41 61 683 77 34  
Fax +41 61 302 89 18  
[www.mdpi.com](http://www.mdpi.com)

*Sustainability* Editorial Office  
E-mail: [sustainability@mdpi.com](mailto:sustainability@mdpi.com)  
[www.mdpi.com/journal/sustainability](http://www.mdpi.com/journal/sustainability)





MDPI  
St. Alban-Anlage 66  
4052 Basel  
Switzerland

Tel: +41 61 683 77 34  
Fax: +41 61 302 89 18

[www.mdpi.com](http://www.mdpi.com)



ISBN 978-3-03921-025-1