

Frandsen, Thomas

Doctoral Thesis

Managing Modularity of Service Processes Architecture

PhD Series, No. 9.2012

Provided in Cooperation with:

Copenhagen Business School (CBS)

Suggested Citation: Frandsen, Thomas (2012) : Managing Modularity of Service Processes Architecture, PhD Series, No. 9.2012, ISBN 9788792842459, Copenhagen Business School (CBS), Frederiksberg,
<https://hdl.handle.net/10398/8420>

This Version is available at:

<https://hdl.handle.net/10419/208806>

Standard-Nutzungsbedingungen:

Die Dokumente auf EconStor dürfen zu eigenen wissenschaftlichen Zwecken und zum Privatgebrauch gespeichert und kopiert werden.

Sie dürfen die Dokumente nicht für öffentliche oder kommerzielle Zwecke vervielfältigen, öffentlich ausstellen, öffentlich zugänglich machen, vertreiben oder anderweitig nutzen.

Sofern die Verfasser die Dokumente unter Open-Content-Lizenzen (insbesondere CC-Lizenzen) zur Verfügung gestellt haben sollten, gelten abweichend von diesen Nutzungsbedingungen die in der dort genannten Lizenz gewährten Nutzungsrechte.

Terms of use:

Documents in EconStor may be saved and copied for your personal and scholarly purposes.

You are not to copy documents for public or commercial purposes, to exhibit the documents publicly, to make them publicly available on the internet, or to distribute or otherwise use the documents in public.

If the documents have been made available under an Open Content Licence (especially Creative Commons Licences), you may exercise further usage rights as specified in the indicated licence.



<https://creativecommons.org/licenses/by-nc-nd/3.0/>

COPENHAGEN BUSINESS SCHOOL
HANDELSHØJSKOLEN
SOLBJERG PLADS 3
DK-2000 FREDERIKSBERG
DANMARK

www.cbs.dk



**Copenhagen
Business School**
HANDELSHØJSKOLEN

Managing Modularity of Service Processes Architecture

Managing Modularity of Service Processes Architecture

Thomas Frandsen

PhD Series 9-2012

LIMAC PhD School
Department of Operations Management

PhD Series 9-2012

ISSN 0906-6934

Print ISBN: 978-87-92842-44-2

Online ISBN: 978-87-92842-45-9

Managing Modularity of Service Processes Architecture

Thomas Frandsen

Supervisors:

Associate Professor Juliana Hsuan

Professor Allan Hansen

PhD School LIMAC

PhD programme in Technologies of Managing

Department of Operations Management

Copenhagen Business School

Thomas Frandsen
Managing Modularity of Service Processes Architecture

1st edition 2012
PhD Series 9.2012

© The Author

ISSN 0906-6934

Print ISBN: 978-87-92842-44-2

Online ISBN: 978-87-92842-45-9

LIMAC PhD School is a cross disciplinary PhD School connected to research communities within the areas of Languages, Law, Informatics, Operations Management, Accounting, Communication and Cultural Studies.

All rights reserved.

No parts of this book may be reproduced or transmitted in any form or by any means, electronic or mechanical, including photocopying, recording, or by any information storage or retrieval system, without permission in writing from the publisher.

Acknowledgements

While these opening paragraphs initiate this thesis, to me they simultaneously conclude three years of study at Copenhagen Business School. For me this has been a venture into unfamiliar territory and the open and curious environment at the Department of Operations Management has sparked both moments of reflection and genuine uncertainty. Throughout this journey numerous conversations with faculty and fellow PhD students at the department have provided me with invaluable guidance points for which I am grateful.

In particular I would like to thank my supervisors Associate Professor Juliana Hsuan and Professor Allan Hansen for challenging me along the way and for encouraging me in the process of developing this thesis.

I furthermore appreciate the constructive critiques which I have received from Associate Professor Tamás Vámosi and Associate Professor Günter Prockl during my research seminars at the department. Likewise I am grateful for the valuable critique which I have received from both faculty and fellow doctoral students at the EurOMA Doctoral Consortium as well as the EIASM writing workshop in Vicenza.

I would also like to thank the employees at the case company who have kindly engaged in my scholarly endeavor with genuine interest. Their candid collaboration has provided access for me to an environment in which I could pursue a deeper understanding of the phenomenon of modularity.

Finally my appreciations goes to my family, and particularly Pernille without whose love and support this thesis would not have been possible.

Thomas Frandsen

Frederiksberg, February, 2012

Executive Summary

The world is increasingly turbulent with shorter and shorter technological life cycles and more and more frequent changes in customer demand. This situation implies that flexibility and agility are crucial for producers of products and services. Much effort has been directed toward understanding innovation and the ways in which management can increase the value of innovation efforts. As a consequence, suggestions emphasizing different aspects of innovation and creativity have been put forward. However, the value of architectural knowledge for innovation is increasingly recognized as crucial with modular architectures proposed as one way of increasing the rate of innovation by introducing flexibility and agility without sacrificing efficiency.

Modularity is a way to design a system with the intent of reducing its complexity by decomposing the system and reducing interdependencies between the subsystems of the system through standardized interfaces. Systems designed in this way allow for greater flexibility through recombination; however, they retain efficiency by means of standardization and scale economies from the reuse of components. For this reason modular architectures present an interesting solution to the dilemma of whether to invest in innovation or in efficiency. The topic has received much attention in the face of demands from customers for increasingly heterogeneous products and services. However, an important aspect to keep in mind is that, while decomposition is a powerful way of reducing complexity, most real systems remain only *nearly decomposable* (Simon, 1962) or *loosely coupled* rather than uncoupled (Orton & Weick, 1990).

Although modular architecture has been on the research agenda for well over 40 years, the literature on modular architecture of physical products has grown significantly during the past two decades. Several typologies, frameworks, and empirical investigations have led to a significant insights on modular products. However, the extent to which the same frameworks can be applied to the domain of services still remains an open question. Although many managerial challenges are similar in the delivery of goods and services, there are significant

differences. These differences would suggest that modularity of services and service processes presents different challenges than modularity of products does.

These differences notwithstanding, practitioners have in recent years been presented with information and communication technology that supposedly offers the capability to create loosely coupled system architectures based on the notion of well-defined services, acting as components of business functionality. Service-oriented architecture has thus been presented as a definitive approach to achieve both economies of scale and substitution as well as to achieve agility and flexibility. However, the open systems nature of service delivery systems might also require us to consider the extent to which modularity operates in the same way as for products.

A frequent assumption in the literature on modularity of product architecture is that the important interdependencies between components of the architecture can be identified *a priori*, in order for the components to be partitioned in such a way that interdependencies across modules are minimized. Recent empirical studies have questioned this assumption, (Türcher, 2008; Garud et al., 2007) in the context of services in particular (Staudenmayer et al., 2005; Miozzo and Grimshaw, 2005; Zirpoli and Becker, 2011). In this context important interdependencies have a tendency to emerge unexpectedly. As a result management must direct attention toward managing interdependencies as they arise and mitigating their negative consequences, rather than attempting to fully specifying them *a priori* (Staudenmayer et al., 2005). This observation about management attention resonates well with the earlier suggestion by Garud and Kumaraswamy (1995) that management systems and incentives play an important role in realizing modularization. However, only a few empirical studies have investigated the way in which management systems are involved in realizing modularization.

This thesis examines the management of modularity of service process architecture. It asks the research questions of *how is it possible to conceptualize and measure modularity of service processes?* and *how does process modularization unfold and challenge the architecture?* To answer these questions a longitudinal case study was conducted at a Danish financial service provider that has specialized in providing administration of financial schemes for public and private organizations.

The research findings demonstrate how service process modularity can be conceptualized and measured through the use of the service modularity function. The main contribution of the thesis, however, is to show that the development of the architecture is a dynamic process in which multiple performance criteria are at stake and are affected by intended and unintended consequences of actions and compensatory actions taken. The study documents the use of company-initiated mechanisms of control for reducing uncertainty arising from the emergence of unintended interdependencies.

The thesis thus provides deep insights into the effect of management control mechanisms created in response to uncertainties within the modular architecture. Although they mitigate uncertainties, they have the paradoxical effect of introducing rigidities into an architecture that was initially constructed with the intention of providing flexibility and agility.

Resume

Verden bliver tiltagende mere turbulent med kortere og kortere teknologiske livscyklusser, og hyppigere ændringer i kundernes efterspørgsel. Denne situation bevirker, at fleksibilitet og agilitet er afgørende for producenter af produkter og services. En stor indsats har været rettet imod at forstå innovation, og måderne hvorpå ledelse kan øge værdien af innovationsindsatser. Som resultat er der blevet fremsat forskellige forslag, der fremhæver forskellige aspekter ved innovation og kreativitet. Imidlertid bliver værdien af arkitekturel viden for innovation i stigende grad opfattet som afgørende, og modulær arkitektur er blevet foreslået som en måde at øge innovationsraten ved at introducere fleksibilitet og agilitet uden at ofre effektiviteten.

Modularitet er en måde at designe et system på, med henblik på at reducere dets kompleksitet, ved at dekomponere systemet og reducere gensidige afhængigheder imellem systemets undersystemer gennem standardiserede grænseflader. Systemer designet på denne måde giver mulighed for større fleksibilitet gennem re-kombination. De fastholder dog effektivitet gennem standardisering og skalaøkonomi fra genbrug af komponenter. Af denne årsag fremstår modulære arkitekturer som en interessant løsning på dilemmaet om, hvorvidt der skal investeres i innovation eller effektivitet. Emnet har modtaget megen opmærksomhed i lyset af efterspørgsel fra kunder efter mere heterogene produkter og services. Imidlertid er et vigtigt aspekt at holde sig for øje, at mens de-komponering er en stærk måde at reducere kompleksitet, så er de fleste virkelige systemer kun *næsten dekomponerbare* (Simon, 1962) eller *løst koblede* frem for ikke koblede (Orton og Weick, 1990)

På trods af, at modulær arkitektur har været på den forskningsmæssige dagsorden i over 40 år, så er litteraturen om modulære arkitekturer for fysiske produkter vokset markant indenfor de seneste to årtier. En række typologier, rammeværk, og empiriske undersøgelser har medført en væsentlig større forståelse for modulære produkter. I hvilket omfang de samme rammeværker kan overføres til services, er imidlertid stadig et åbent spørgsmål. På trods af, at mange af de ledelsesmæssige udfordringer er tilsvarende i leverancen af produkter og services, så er der også væsentlige forskelle. Disse forskelle antyder, at modularitet af services og service processer stiller andre udfordringer, end modulære produkter gør.

Uafhængig af disse udfordringer er praktikere i de seneste år blevet præsenteret for informations- og kommunikationsteknologi, der antageligt tilbyder muligheden for at skabe løst koblede systemarkitekturer baseret på veldefinerede services, der fungerer som komponenter af forretningsfunktionalitet. Service-orienteret arkitektur er således blevet præsenteret som netop en måde at opnå både skalaøkonomi og substitutionsøkonomi såvel som agilitet og fleksibilitet. Imidlertid gør service leverancesystemers natur som åbne systemer, at det måske også forudsætter, at vi overvejer, i hvilket omfang modularitet kan fungere på samme måde som for produkter.

En hyppig antagelse indenfor litteraturen om produktmodularitet er, at de væsentlige gensidige afhængigheder mellem komponenter i arkitekturen kan identificeres *a priori*, således at komponenter kan partitioneres på en måde, der minimerer afhængigheder imellem moduler. Nylige empiriske studier har imidlertid sat spørgsmålstegn ved denne antagelse (Türcher, 2008; Garud et al., 2007), særligt når det gælder service kontekster (Staudenmayer et al., 2005; Miozzo og Grimshaw, 2005; Zirpoli og Becker, 2011). I denne kontekst har vigtige afhængigheder en tendens til at optræde uventet. Som konsekvens må ledelsen retter opmærksomhed mod at styre afhængigheder som de opstår, snarere end at forsøge at specificere disse fuldstændigt *a priori* (Staudenmayer et al., 2005). Denne observation omkring ledelsens opmærksomhed stemmer godt overens med det tidlige forslag af Garud og Kumaraswamy (1995), at ledelsessystemer og incitamenter spiller en vigtig rolle i at opnå modularisering. Imidlertid har kun få empiriske studier undersøgt, hvordan sådanne ledelsessystemer er involverede i opnåelsen af modularisering.

Denne afhandling undersøger ledelsen af modularitet indenfor service proces arkitektur. Den stiller forskningsspørgsmålene *hvordan er det muligt at konceptualisere og måle modularitet af service processer?* og *hvordan folder proces modularisering sig ud og udfordrer arkitekturen?* For at besvare disse spørgsmål er gennemført et længerevarende case studie ved en dansk finansiell serviceleverandør, der har specialiseret sig i at levere administration af finansielle ordninger for offentlige og private organisationer.

Forskningsresultaterne demonstrerer hvordan service proces modularitet kan konceptualiseres og måles gennem anvendelse af service modularitets funktionen. Afhandlingens primære

videnskabelige bidrag er imidlertid at vise, at udviklingen af arkitekturen er en dynamisk proces, i hvilken multiple præstationskriterier er på spil og påvirkes af intenderede og uintenderede konsekvenser af handlinger og kompensatoriske handlinger. Studiet dokumenterer brugen af virksomhedsinitierede kontrolmekanismer beregnet på at reducere usikkerheder opstået som følge af uintenderede afhængigheder. Afhandlingen bidrager derved med dyb indsigt i den effekt ledelsesmæssige kontrolmekanismer skaber som svar på usikkerheder indenfor den modulære arkitektur. På trods af at de håndterer usikkerheder, så har samtidig den paradoksale effekt at de introducerer rigiditet i den arkitektur der oprindeligt var skabt med henblik på at skabe fleksibilitet og agilitet.

Table of content

| | |
|---|----|
| Executive Summary | 1 |
| Resume | 4 |
| Chapter 1 Introduction | 14 |
| 1.1 Motivation | 15 |
| 1.1.1 Using architecture as a strategic weapon | 17 |
| 1.1.2 Design of service processes | 18 |
| 1.2 Contribution to the literature | 20 |
| 1.3 Research Questions | 23 |
| 1.4 Research method | 23 |
| 1.5 Structure of the thesis | 26 |
| Chapter 2 Domain literature | 27 |
| 2.1 Literature review on modularity | 28 |
| 2.1.1 Introduction | 28 |
| 2.1.2 Methodology and data for the literature review | 37 |
| 2.1.5 Product modularity with strategic impact | 51 |
| 2.1.6 Modularity within engineering and operations management | 55 |
| 2.1.7 Organizations and modularity | 63 |
| 2.1.8 Development of the field of modularity | 80 |
| 2.1.9 The intellectual structure of the literature on modularity | 82 |
| 2.1.10 Findings from the literature review on modularity | 85 |
| 2.2 Managing service operations | 91 |
| 2.2.1 Defining services | 93 |
| 2.2.2 The challenges of designing and managing service operations | 95 |
| 2.2.3 Classification of services | 96 |

| | |
|---|-----|
| 2.2.4 Performance criteria of service operations | 97 |
| 2.2.5 Service Process Architecture | 99 |
| 2.3 Modularity of services and processes | 102 |
| 2.3.1 Service Oriented Architecture | 106 |
| 2.3.2 Service interfaces | 107 |
| 2.4 Chapter summary | 108 |
| Chapter 3 Theory development | 110 |
| 3.1 Economics of modularity | 111 |
| 3.2 A Modularity theory of the firm..... | 117 |
| 3.3 A practice lens for studying the emergence of architectures | 118 |
| 3.4 The role of management control in achieving modularization | 128 |
| 3.5 Chapter summary | 131 |
| Chapter 4 Methodology | 132 |
| 4.1 Philosophy of science..... | 133 |
| 4.1.1 Ontological and epistemological considerations | 133 |
| 4.1.2 Reflexivity and management dilemmas..... | 137 |
| 4.2 Research design..... | 137 |
| 4.2.1 Case research | 138 |
| 4.2.2 Data collection | 139 |
| 4.3 Chapter summary | 141 |
| Chapter 5 Designing processes at DK-Finance | 143 |
| 5.1 Case company – Financial Services | 144 |
| 5.1.1 Introduction to the case company | 144 |
| 5.1.1 The practice of process design within DK-Finance..... | 152 |
| 5.2 Conceptualizing and measuring service process modularity | 159 |

| | |
|--|-----|
| 5.3 Chapter summary | 167 |
| Chapter 6 Problems and dilemmas | 168 |
| 6.1 The emergence of unexpected and unintended consequences | 169 |
| 6.1.1 The architecture vision and realization | 169 |
| 6.1.2 The fear of unintended consequences from unanticipated interdependencies | 172 |
| 6.1.3 The sequence of the design process | 176 |
| 6.1.4 The variety across schemes and the difficulty of generalizations | 177 |
| 6.2 Chapter summary | 178 |
| Chapter 7 Control mechanisms and coordination..... | 179 |
| 7.1 Results controls through budgets and business cases | 180 |
| 7.2 Action controls through administrative procedures | 180 |
| 7.2.1 Release structure and testing..... | 181 |
| 7.2.2 Integration contracts..... | 185 |
| 7.3 Personal and cultural controls through standardized methods..... | 187 |
| 7.4 Chapter summary | 189 |
| Chapter 8 Conclusions..... | 191 |
| Chapter 9 Discussion | 198 |
| 9.1 Implications for theory | 198 |
| 9.2 Implications for practice..... | 202 |
| 9.3 Limitations and further research | 203 |
| References..... | 205 |

List of figures

| | |
|--|-----|
| Figure 1 Search strategy | 39 |
| Figure 2 Analytical approach to identifying structure within the literature on modularity | 45 |
| Figure 3 Example of referencing from a subset of the literature on modularity | 47 |
| Figure 4 Network visualization of the literature on modularity in relation to management | 49 |
| Figure 5 Development of the literature on modularity (1995 – 2010) | 81 |
| Figure 6 Network visualization of the intellectual structure behind the literature on modularity in relation to management | 84 |
| Figure 7 Propositions identified in the literature on modularity | 86 |
| Figure 8 Schematic representation of the two great unbundlings | 92 |
| Figure 9 Service processes as events | 100 |
| Figure 10 The service encounter triad | 108 |
| Figure 11 Giddens stratification model of action | 124 |
| Figure 12 The dimensions of the duality of structure..... | 126 |
| Figure 13 Enactment of technology in practice..... | 128 |
| Figure 14 Management control systems as packages..... | 130 |
| Figure 15 The transition to an architecture based on principles of loose coupling..... | 146 |
| Figure 16 Incoming inquiries for specific scheme | 150 |
| Figure 17 Illustration of solution flow..... | 156 |
| Figure 18 Illustrating the decomposition of the service process architecture | 162 |
| Figure 19 Identifying the elements of a modular service process | 163 |
| Figure 20 Illustration of decomposition of process | 164 |
| Figure 21 Service modularity function for the two analyzed processes..... | 166 |
| Figure 22 Model of the dynamic effects of modularity in service processes | 192 |

List of tables

Table 1 Key principles on which the literature on modularity draw 34

Table 2 Seminal contributions within the literature on modularity.....43

Table 3 Groupings identified within the literature on modularity..... 78

Table 4 Typology of flexibility98

Table 5 Articles on modularity of services identified through the literature search 104

Table 6 List of interviews and observations 140

Table 7 Existing measures of modularity 160

Table 8 Elements in the service modularity functions 165

List of appendixes

| | |
|---|-----|
| Appendix 1 List of journals from which articles were retrieved through Web of Science | 225 |
| Appendix 2 Factor analysis for bibliographic coupling | 228 |
| Appendix 3 Factor analysis of co-occurrences | 231 |

Part I

Theorizing on Modularity

Chapter 1 Introduction

This chapter will provide an introduction to the thesis and the research questions addressed by the thesis. In doing so section 1.1 will discuss the motivation for the thesis by introducing the literature with which the thesis engages. Section 1.2 will continue this by elaborating on how the thesis seeks to contribute to the literature. On the basis of this, section 1.3 will present the research questions of the thesis, and section 1.4 will briefly discuss how these are addressed empirically by introducing the research method. Finally section 1.5 will provide an overview of the structure of the thesis.

1.1 Motivation

Services are playing a growing role in the economy not just in Denmark but internationally with the perspective of an increasing importance of the trade in services. For service companies the ability to develop their services and delivery systems is playing a major role. In practice increasing attention is given to the importance of innovation for the ability of service companies to adapt in an ever changing world. Such abilities are crucial for long term survival in the face of rapid changes in the marketplace. Much research has investigated how the conditions for innovation can be improved, and how creativity can be stimulated i.e. by influencing organizational and cultural parameters. Innovation is frequently portrayed as a benefit which is generally to be preferred to less innovation.

However innovation also carries changes and challenges to existing ways of operating thereby eroding the value of existing competencies. While it is expensive to innovate increased complexity of service offerings can also have negative consequences for the operation of underlying service delivery systems. For management this calls for a more nuanced understanding of innovation and how it can be sensible to dose and ration on innovation. Development and marketing of new services can thereby be seen in relation to the development and adaption of the operational activities through which these are delivered. Understanding the impact of architectural knowledge on innovation adds an important distinction by introducing architectural and modular innovations as alternatives to the traditional distinction between radical and incremental innovations (Henderson and Clark, 1990).

Modularity is exactly about these two types of innovation, architectural and modular and how they can be achieved through the development of architectural competencies. Through standardization and reuse of components modular architectures have been proposed as one way of increasing the rate of innovation and adaptation while maintaining efficiency. For that reason modular architectures present an interesting potential solution to the dilemma of investment in innovation or efficiency. Ulrich (1995, p. 420) defines product architecture as *“(1) the arrangement of functional elements; (2) the mapping from functional elements to physical components; (3) the specification of the interfaces among interacting physical*

components.” According to Ulrich modular product architectures are characterized by a one-to-one mapping from functional elements to physical components and decoupled interfaces. Through the opportunity of recombination modular architectures can thus be one way of increasing variety without increasing the costs which would otherwise be connected with increased flexibility (Ulrich 1995).

Research in product architecture has been well established but an interesting question is to which extent the established knowledge from this field has relevance to service organizations. A characteristic of many services is a high degree of variety caused partly by heterogeneous preferences of customers and the fact that customers themselves contribute with input to service production and are present during the process (Sampson & Froehle 2006). In order to meet the individual customers demand it is thus often crucial to be able to adapt the service. A significant part of such adaption happens through the person to person interaction between the customer and front line personnel. However an alternative or complement is to adapt services by configuring heterogeneous service elements in an individually adapted service package. It is thus important to distinguish between personalization and customization (Voss & Hsuan 2009) with the latter facilitated by an architecture enabling reconfiguration. In that connection knowledge on architecture and modularity should feature prominently in service contexts as well.

Voss and Hsuan (2009) point exactly to how such use of the notion of architecture can be used in a service context and they seek to operationalize this by decomposing the service architecture and analyze it in light of its elements (nodes) and interfaces (linkages). By investigating the various elements and characterizing these as either standardized or unique Voss and Hsuan are able to establish different degrees of modularity. Such conceptualization and measures can contribute to the design and management of complex service architectures. Architecture and modularity is closely related to the notion of mass customization (Pine 1993, Feitzinger & Lee 1997, Fine 1998) and the platform perspective (Meyer et al. 1997, Meyer & Lehnerd 1997, Robertson & Ulrich 1998). According to the platform perspective it is exactly the established platform which is intended to be kept stable with the intent to create variety through innovation and recombination of modules (Meyer & DeTore 2001). The platform is

thus the physical manifestation of the design rules which are established as a part of the architecture (Baldwin 2010).

Service architecture is thus a relatively new field of research in which empirical studies is in demand (Voss & Hsuan 2009). There are differences between manufacturing and services which naturally imply that both elements and interfaces have different characteristics. For example de Blok et al. (2010) on the basis of case studies of elderly care in the Netherlands show that modular components function differently depending on the time of interaction and interestingly that the logic is different than in manufacturing as compared to the model of Duray et al. (2000). They conclude that in the early customer interaction there is a low degree of customization in which the primary service modules are configured. The detailed configuration of the care package however required that the service personnel interact with the client which in their case is an independently living elderly with a need for care. Service modules and components (and thereby also the degree and type of standardization) thus play different roles depending on the time of delivery. They thus point out that the interface between service modules can play different roles depending on whether the intent is to create variety or coherence and depending on whether the interface is between humans or objects in the service production.

1.1.1 Using architecture as a strategic weapon

Baldwin (2010) emphasizes that architectural competencies play a crucial role and she shows how such competences can be utilized by an entrepreneur to challenge incumbents. She points out that by utilizing their knowledge about the architecture firms can choose to focus attention on essential modules which are acting as bottlenecks for system performance and outsource remaining modules. Again the central questions of how modules are defined and not least how their interfaces are designed arise. Which modules and interfaces are thus to be proprietary and which can be made open and thereby be placed outside the boundary of the firm? A central point in the theory of modularity is exactly that modules create what Baldwin notes as 'thin crossing points' that is interfaces through which market transactions can occur (Baldwin 2008). A modular architecture thus enables firms to place part of the architecture outside of the boundary of the firm. Which parts is thus a central question to which Baldwin

answer that it is exactly the architectural competencies of the challenger that enable him to know which modules constitute bottlenecks for system performance. By keeping and developing these it is possible for the challenger to increase system performance and at the same time minimize the need for capital by outsourcing non-essential modules. This combination, she argues, presents incumbents with a formidable challenge and is as such a lethal strategic weapon.

Innovation is critical but it is not trivial to determine which kind of innovation to choose, as innovation challenges existing capabilities in different ways. In any case architectural competencies play an important role and the design of service architecture and the specification of interfaces are critical. However the development of such competencies is in itself full of dilemmas. In example the establishing of architectures and determining of modular standards often imply an intention to create options for recombination. However the architecture could alternatively have been kept open and the interfaces that through standardization have been established could have remained uncertain. Thereby other options could have existed potentially implying even more radical innovation. A managerial challenge is thus to determine when and how to close the architecture to create important options and not disregard even more important options in the process.

1.1.2 Design of service processes

In contrast to the design of physical products, designing service processes is to a large extent about organizational design, design of decision rights and rules and the design of information technology. There are thus many dimensions at work and decomposition in just one dimension would seem insufficient to capture the benefits of modularity. For modularity to work it seems that you must be able to decompose in many dimensions implying that many entities must be aligned by the designers. Secondly as described above service systems are often characterized by high degree of variety and importantly like organizations service systems are open systems (Lilrank, 2010) with the turbulence which follow from this characteristic. Most theories and investigations of modularity however assume that the architecture can be specified a priori (Garud et al. 2008) Different types of modularity and different ways of standardizing interfaces are addressed but the questions of the complexity of

the process of modularization are seldom raised. Based on my case study I was puzzled to see, that the architecture rather than being a fixed entity established a priori was indeed described as something which had been subject to major changes during the course of developing and implementing the new processes and systems. Attempts were made with much effort to establish overall architectural principles a priori, but upon implementation critical aspects of this architecture was challenged. Tensions between implementation efforts and architectural principles thus influenced the principles of the architecture and reduced the power of the architecture.

Likewise the appearance of determinate specification and unity across the different lines of services was only clear when described on abstract levels. When working on detailed levels the restrictions of practice challenged the specifications necessitating changes to components and modules. The intention was to create generic modules consisting of reusable components which could be compiled to establish the individual lines of service. This was intended to lower cost by reducing redundancy and achieving economies of substitution. At the same time it was intended to lower the time required to configure a new line of service, as components would only have to be defined once, with subsequent reuse. Finally this architectural approach was intended to promote flexibility and thus enable business agility.

However it turns out that the architecture exactly because of the reuse of components across multiple service lines become vulnerable to effects at the system level. To enable reuse of components it is often necessary to make alterations to the component in order to accommodate the requirements of different service lines which were not anticipated when the component was first designed. However this introduces the risk of unintended consequences to the service lines in which the component has previously been used. In order to mitigate this, alteration of components could be reduced or the consequences of alterations inspected. Reducing alteration of components either requires sufficient foresight to develop components which are capable of meeting the needs of the lines of service not yet implemented, or it requires the introduction of new component variants which thus increase the complexity of the architecture and reduce the economies of substitution. Alternatively any alteration in components could be required to involve testing of existing lines of services potentially at the

system level. This, however imply costs as testing is a time consuming activity requiring coordination. The intention of reusing modules of processes across services thus had the paradoxical effect that it did in fact enable the creation of a business platform from which new service lines could be added but only to the extent that they relatively closely resemble existing lines of service. Furthermore a consequence of component reuse was that it constrained the flexibility of the architecture to meet new requirements from existing service lines.

1.2 Contribution to the literature

Underlying much of the literature on management in general and the use of specific management concepts is an implicit assumption that structures can be purposefully designed via an *a priori* understanding of the requirements and goals resulting in a complete specification of the resulting requirements for the components of the structure. As Garud et al argue this may well be have been an appropriate case in settings of relative certainty and stability, but in current turbulent and evolving environments this is an inappropriate conceptualization of the role of design in management (Garud et al., 2008). On the contrary they argue that in such contexts design may well be characterized as incomplete and that it can be quite appropriate to purposefully design for incompleteness as in shown in the case of the Linux operating system and the open encyclopedia of Wikipedia (Garud et al., 2008). Similarly the underlying assumption that the architecture can be designed prior to its implementation and thus that design rules can be specified *a priori* is frequently made within the literature on modularity. This assumption presents an interesting puzzle as the design of architectures obviously requires architectural competencies and detailed knowledge of the system being designed. Although much of this knowledge can surely be acquired through analysis and planning activities it begs the question of how the design of an architecture can be unrelated to its implementation. As noted by Simon there will often be a conflict between the issues of the present and planning for the future as “It is a commonplace organizational phenomenon that attending to the needs of the moment – putting out fires – takes precedence over attending to the needs for new capital investment or new knowledge” (Simon, 1996, p. 161). The design and implementation is thus linked on the one hand by the attention given but

perhaps more importantly our abilities of foresight is limited and the process of designing thus become one of deciding on actions which have both intended and unintended consequences thus requiring reflexivity and alteration. *“The idea of final goals is inconsistent with our limited ability to foretell or determine the future. The real result of our actions is to establish initial conditions for the next succeeding stage of action”* (Simon, 1996, p. 161). Recently these emergent properties of design and the role of reflexivity have received attention in the study of design (Boland & Collopy, 2004; Beguin 2003; Schön 1983) the design of information technology (Orlikowski, 2010; von Krogh & Haefliger, 2010; Orlikowski, 2000) and organizational routines (Pentland & Feldman, 2008). As Orlikowski point out *“Designs are conceived and developed on paper, whiteboards, and computers, with models, graphics, and text, in software, hardware, foam-core, and mortar. They are representations of possible realities. However inventive, intuitive, brilliant, or beautiful these designs may be, their ultimate value is dependent on the engagement of others. They are incomplete until realized in action, until integrated into the everyday practices of human actors for whom the designs are a means to an end”* (Orlikowski, 2004, p. 93). This integration leads to intended and unintended consequences of which the designer needs to be aware, and as such the process of designing can be characterized as *“a conversation with the materials of a situation”* and *“in a good process of design, this conversation with the situation is reflective. In answer to the situation’s back-talk, the designer reflects-in-action on the construction of the problem, the strategies of action, or the model of the phenomena, which have been implicit in his moves”* (Schön, 1983, p. 78-79).

Thus the idea of modularity turns out to present us with a paradox that while modularity is intended to reduce complexity by coordinating disparate components through standardized interfaces at the same time it introduces new complexities which require coordination efforts by managers. As such it would seem that in investigating modularity these complexities rightly deserve attention in order to understand how managers deal with these and the dilemmas they present. What started as an assumption underlying the idea of modularity, that we are required to specify the design rules of the system a priori, thus turn out to be questionable in the sense that maybe the design rules not only deserve attention as a starting point but could well be entities which are challenged and reconstituted when they are put into

practice. As abstract ideas overall principles of architecture only involve friction when they become boundary objects for decisions made in 'the real world'. They become interesting and potentially problematic when they are present as limitations to decision makers and have consequences for the decisions that are made. In order to understand the dynamics of modularity it is thus necessary not only to study the causes of modularity, its different types and direct effects, but importantly to be aware of unintended consequences and how these are dealt with by managers and designers in their efforts to achieve their objectives. Including such a view would allow for a greater understanding of the dynamics of modularity when it is introduced in a social setting such as the design of service processes.

Curiously however, only sparse attention is given to this aspect of architecture and design within the literature on modularity. The work of Garud et al. (2008) present an interesting exception which challenges existing views by questioning the sequence of events in design. Through a pragmatic approach to design they study the question of what it means to design for incompleteness or incomplete by design. As they note this does not seem to be the case, as what could be thought of as the pivot point of modularity is often transformed into an initial assumption. That is an assumption of decomposability in which the object of study is the effects of this assumption. Türtscher (2008) go so far as to ask what actually comes first, an architecture with design rules specifying how modules should interact or the modules themselves leading in the end to a modular architecture. He explore this question through a case study of the design of ATLAS, a specific detector in the large hadron collider at the European Organization for Nuclear Research (CERN). The study demonstrates how the architecture was the result of numerous negotiations over discrepancies between researchers working on different components of the detector rather than an a priori specified architecture. Given the nature of the project it was not possible to foresee in advance the interdependencies of components which often emerged in unexpected ways. As a consequence the critical design decisions were made as a series of "trials" in which researchers would argue their respective case in order to reach a solution which would satisfy both of the interdependent components. By following the resulting decisions which were published and co-authored by the negotiating researchers Türtscher was able to address a central assumption in relation to the design of modular systems, the role of the architecture. His study questions the

assumption of ex ante specification determining the rules of the architecture and show the design process as an iterative process through which the architecture emerged as the result of reflexivity and negotiations between designers and the design.

1.3 Research Questions

This thesis will engage in the important topic of architecture and modularity within the context of service processes. Modularity is primarily about reducing complexity by decomposing a system into independent or nearly independent entities which is still able to function as a whole through standardized interfaces. The thesis will thus address the research question of *how it is possible to conceptualize and measure modularity of service processes?* However when investigating modularity in practice it turns out that what is intended to reduce complexity is in itself a complex enterprise. The principles which the architecture lays out are not entities independent of their implementation but are themselves challenged as modules are created and modified in the implementation of the architecture. By addressing the question of how the architecture is established and transformed and by following projects of implementation his thesis will thus also ask the question of *how the process of modularization unfolds and challenges the architecture?* Through a case study of a Danish financial service provider this thesis will show that defining the boundary around modules becomes a challenging endeavor when the heterogeneous requirements of praxis sets in. It is thus one challenge to design abstract principles and ‘power point’ modules but quite another to follow those principles and specify the workings of the modules at detailed level required by practical implementation.

1.4 Research method

This thesis attempts to study this question of design through case research in a financial service company which during the course of several years have been designing and implementing new processes and systems. The case study reveal that while the company has deliberately chosen a path to process and system design which resemble principles of modularity this venture has brought about consequences which the company have attempted to mitigate by establishing a range of coordination and control mechanisms. These

mechanisms however are not neutral in the sense that they impact the outcomes of the design efforts and are as such important to include when attempting to understand modularity in praxis.

An interesting facet of the case company is that they during the course of 6-7 years have been replacing almost all existing systems and introducing a re-organization from a functional service line organization into an organization with shared functions, systems and processes across service lines. Through this reorganization it was intended to achieve both scale economies as well as faster time to market through the reuse of applications and processes across service lines. This endeavor was undertaken as a major architectural development resulting in a new Business Platform. As part of this development each of the existing service lines were implemented on the Business Platform. The platform was to be built based on Service Orientation, which through loose coupling and reuse of services was argued to provide both flexibility and scale economies. During the period many companies have been attempting similar development projects but it turns out that the service oriented paradigm has inherent challenges. Many service oriented architecture projects have failed and the case company is considered to have been successful in establishing a pragmatic architecture. The thesis propose that not only can the understanding of these challenges benefit from the knowledge on modularity, rather, this setting also provides an opportunity to contribute to the knowledge on modularity in general and modularity of services in particular.

The issues that arise thus carry traits which can also be found in the literature on modularity, such as the propagation of effects throughout the system based on unanticipated interdependencies and the subsequent deterioration of resilience of modular systems given imperfect interface specifications. This have effects on the need for testing which in a modular system can quickly become massive in the case that module level testing is insufficient to provide confidence on the system level.

In order to ensure confidence and to protect the system from such interface compatibility effects a number of coordination mechanisms were built around the architecture. These include a project model specifying gates and gate criteria for all development projects and governance structure which include the specification of responsibilities across IT and

business units which are required to validate defined aspects of project deliveries at individual gates. Furthermore release cycles have been established, which place restrictions on the timing of changes to the system in order to ensure that changes can be sufficiently tested before released. The testing activities themselves follow specific requirements with responsibility assigned to test managers and detailed protocols specifying which test activities to perform. Especially regression testing require efforts and are needed when components have been used across several service lines with subsequent alterations made to the component. The information needed to perform these activities is modeled in various representations of the processes, information and systems. Building and maintaining these representations are further complicated by the co-presence of multiple methods to represent similar data partly due to the use of external vendors, each of which provide their own methods, and partly because the development of a unified method has itself turned out to be a process.

As a consequence of these coordination efforts, mechanisms and representational entities the business platform which was intended to provide flexibility is in some respects considered inflexible. Even minor changes to existing service lines are thus basically considered to be major projects and are required to follow the project governance model and the bi annual release cycle with requirements for testing.

The case thus offers a context to understand how various elements are constructed in relation to each other and how this construction process is a challenging undertaking. Studying these challenges has the potential to contribute to the literature on modularity, as it essentially is an investigation into what is otherwise considered an initial assumption. Rather than neglecting these challenges, by assuming that a set of a priori given design rules ensure decomposable interdependencies and standardized interfaces, we should turn our attention to the instances where this turns out to be insufficient. Doing so enables us to understand the limitations of foresight and the actions and coordination mechanisms that designers and managers employ as they reflexively engage in the construction activity. Furthermore attention to the actions taken to compensate for the unintended effects and how these affect performance outcomes

could provide a more dynamic understanding of the concept of modularity of service processes.

1.5 Structure of the thesis

The thesis is structured in three parts. In part I, chapter 1 provide an introduction to the thesis and outline the research objective and research question. Chapter 2 gives a more comprehensive introduction to the domain literature to which the thesis seek to contribute. This includes a detailed literature review on the topic of modularity as well as an outline of the challenges of managing service processes. The chapter concludes by specifically addressing modularity of services. Chapter 3 introduces organizational economic theories to discuss modularity as an economic phenomenon. Furthermore the chapter presents a practice lens to the study of modularity in order to capture emergent properties of modular design. Finally the chapter introduces a framework for management control which is relevant to the understanding of management responses to the risk of unintended consequences following from reuse of process components. Chapter 4 presents the research method of the thesis.

Part II comprises three chapters of empirical analysis through which the thesis attempt to answer the research questions of the thesis. Chapter 5 provides an introduction to the case company and its process design practices. In order to conceptualize modularity of service processes the service modularity function is applied to the context of specific processes within the process architecture. Chapter 6 identifies a number of problems and dilemmas involved in the efforts to standardize and reuse components which have had an impact on the architecture. Chapter 7 address the managerial responses which have been put in place in order to control the unintended consequences identified in chapter 6. In order to do so, the framework on management control presented in chapter 3 is applied.

Part III provides conclusions in chapter 8 and discussion in chapter 9.

Chapter 2 Domain literature

This chapter introduces the domain literature to which the thesis attempt to contribute. The starting point is the literature which focuses on modularity as a managerial design concern. In section 2.1 a systematic review of the literature on modularity is conducted based on a literature search covering the period 1990 – 2010 revealing how this area has received growing attention during recent years. The attention within the literature has predominantly been on the design of physical products and manufacturing systems. However within recent years modularity of services and service processes are however becoming a major concern. A contributing factor is the development of ICT which increasingly enable the design of loosely coupled service systems. Section 2.2 introduces concerns for managing services based on the literature on service engineering and service operations management. On the basis of the introduction of these two domain literatures Section 2.3 draws a synthesis in order to locate the discussion of modularity in a service process context. Section 2.4 concludes the introduction to the domain literature.

2.1 Literature review on modularity

The purpose of this section is to review the management literature on modularity in order to identify its central positions and intellectual structure. The review is based on a bibliographic search to identify relevant academic contributions on the topic of modularity as a managerial concern. On the basis of the identified contributions network analysis of their citation structure enabled identification of distinct areas of research on modularity as well as intellectual positions on which the literature is based. The section demonstrates how the literature on modularity has evolved and illustrates how it is based on distinct intellectual positions within the literature. Previous contributions have reviewed the literature on modularity within the field of management in general and operations management and engineering management in particular. These have contributed by identifying the various approaches and research contributions as well as highlighting areas for further investigation. Through the use of bibliographic information this section advances our understanding of the literature on modularity by applying network analysis to systematically identify the intellectual structures and development of the literature on modularity. While others have conducted bibliographic analysis within operations management (Pilkington & Fitzgerald, 2006; Pilkington & Meredith, 2009) the analysis below is distinct as it explores the development of a specific topic within a research field rather than investigating the field itself.

2.1.1 Introduction

Modularity is a key aspect of the structure of systems in general and has thus been proposed to be an area which is of particular relevance for designers and managers of business organizations. This section surveys the extant literature on modularity from a managerial perspective in order to identify its intellectual structure and the developments of this literature. Several researchers have already contributed to the field by reviewing different aspects of the literature on modularity. Fixson (2007) provides an extensive review of the literature on modularity and commonality from a concurrent engineering perspective and Salvador (2007) reviews and re-conceptualizes product modularity in order to arrive at a clear definition (Salvador, 2007). Other reviews have focused on particular aspects of modularity

such as manufacturing operations (Doran & Hill, 2009) and supply chain management (Gunasekaran & Ngai, 2005) as well as related topics such as platform strategies (Chen & Liu, 2005) and product architecture (Yassine & Wissmann, 2007). Within information systems research Ali et al. review the related area of aspect oriented programming within information systems research (Ali et al., 2010). Finally in a broader review Campagnolo & Camuffo (2010) describes the overall trends within the literature on the managerial aspects of modularity.

Although the topic of modularity has recently gained substantial attention, it has been discussed in the literature for many years and modular principles have been applied since the building of the pyramids (Starr, 2010). Adam Smith's classical work on the division of labor (Smith, 1776/1991) provides an early contribution on the role of the structure of production (Langlois, 2002, 2006). However since the middle of the 20th century a number of seminal contributions have discussed different aspects of modularity in various contexts. Within operations management an early contribution is made by Starr (1965) who proposed modular production as a way to increase the variety of product offerings to meet market requirements without sacrificing efficiency in production. Starr points out that the design of the individual parts is essential to modular production as *"It is the essence of the modular concept to design, develop, and produce those parts which can be combined in the maximum number of ways"* (Starr, 1965, p. 138). The solution thus included adding different assembly configurations to the production process, through which parts can be brought together to achieve combinatorial output.

Whereas Starr specifically addresses manufacturing operations, Simon (1962) turns to complex systems in general. He conceptualizes architectures as hierarchical systems and argues that the ability to decompose systems hierarchically is the primary means of managing complexity. He thus argues that hierarchy *"is one of the central structural schemes that the architect of complexity uses... In hierarchic systems, we can distinguish between the interactions among subsystems, on the one hand, and the interactions within subsystems - i.e., among the parts of those subsystems - on the other"* (Simon, 1962, p. 468 and 473). Architecture in the sense of this thesis consists of a complex set of related systems which are

organized with the intent to achieve a certain outcome. The architecture is assumed to some extent to be layered in order to reduce complexity or in the language of Simon, the architecture is assumed to potentially be considered a nearly decomposable system “*As a second approximation, we may move to a theory of nearly decomposable systems, in which the interactions among the subsystems are weak, but not negligible*” (Simon, 1962 p. 474). Decomposition is essentially a way to manage complexity and is tightly related to the notion of modularity as discussed below. However the notion of near decomposability is important as it maintain that there are usually interdependencies between subsystems and that these are essential in understanding the managerial challenges of modularity.

Within the area of design Alexander in his “*notes on the synthesis of form*” explains how the challenge of design is not usually one of optimizing a set of individual requirements but rather the more complex task of designing interdependent subsystems which simultaneously meet their requirements and create a functioning whole – the synthesis of form. “*A design problem is not an optimization problem. In other words, it is not a problem of meeting any one requirement or any function of a number of requirements in the **best possible** way (though we may sometimes speak loosely as though it were, and may actually try to optimize one or two things like cost or construction time). For most requirements it is important only to satisfy them at a level which suffices to prevent misfit between the form and the context, and to do this in the least arbitrary manner possible*” (Alexander 1964, p. 99, emphasis in original). To Alexander synthesis is thus preceded by analysis in the form of identifying which variables have interdependencies with other variables, and how the problem can be represented in such a way that it allows for the experimentation on subsystems which are relatively independent of other subsystems. Through his emphasis on the importance of problem representation he is thus suggesting a program of functional decomposition as an important aspect of design. He is however very much aware that the essence of a design problems is exactly that no mechanical method preexist which would allow the identification of the perfect solution. “*A moment’s thought will convince us that we are never capable of stating a design problem except in terms of the errors we have observed in past solutions to past problems. Even if we try to design something for an entirely new purpose that has never been conceived before, the best we can do in stating the problem is to anticipate how it might*

possibly go wrong by scanning mentally all the ways in which other things have gone wrong in the past” (Alexander 1964, p. 102). Alexander thus provides a crucial early contribution to later research on modularity by suggesting the importance of decomposition within the area of design. Furthermore Alexander explicitly point to the importance of this notion for the adaptability of systems in general: *“No complex adaptive system will succeed in adapting in a reasonable amount of time unless the adaptation can proceed subsystem by subsystem, each subsystem relatively independent of the others”* (Alexander 1964, p. 41). Both the notion of decomposition into subsystems and the benefit of adaptation are key aspects in the literature on modularity.

An early theorist on organizations to realize the importance of uncertainty and the need for adaptability in organizational systems was Thompson who pointed to the nature of interdependencies and how these differ within and across organizations. While Thompson does not explicitly discuss modularity he proposes that organizational design is crucially related to the grouping of components based on the nature of their interdependencies with other components within the organization. He distinguishes between pooled, sequential and reciprocal interdependence and argues that there are different ways of achieving coordination their appropriateness depending on the nature of interdependencies: *“We can make two observations about interdependence and coordination which are crucial to our examination of structure: First, there are distinct parallels between the three types of interdependence and the three types of coordination. With pooled interdependence, coordination by standardization is appropriate; with sequential interdependence, coordination by plan is appropriate; and with reciprocal interdependence, coordination by mutual adjustment is called for. Second, the three types of coordination, in the order introduced above, place increasingly heavy burdens on communication and decisions”* (Thompson, 1967, p. 56). Grouping together components of the organization based on the nature of their interdependencies is thus a way to reducing uncertainty but this homogenizing runs into the problem that organizations are not one-dimensional and that it is therefore not obvious which dimension to group them. Rather than a matter of selecting which criteria should be used Thompson suggest that they should rather be prioritized based on the *“nature and location of interdependency, which is a function of both technology and task environment”* (Thompson,

1967, p. 57). Thompson treats complex organizations as natural systems which are subject to rationality norms with the implication that they are seeking to reduce uncertainty while at the same time attempting to adapt to changing environmental factors. It is thus important to distinguishing between different parts of organizations as the technical core will predominantly be seeking to reduce uncertainty while boundary spanning units face the challenge of negotiating changes from the organizations external environment. The administrative process, which function to achieve this constant co-alignment of institutionalized action, must therefore paradoxically “*reduce uncertainty but at the same time search for flexibility*” (Thompson, 1967, p. 158).

Building on the insight of Thompson that organizations simultaneously attempt to operate as closed systems in some regards and open systems in other Weick proposed the notion of loose coupling as a way to capture nuances of organizations which is not captured by “*words like connection, link, or interdependence*” (Weick, 1976, p. 3). He argues that these words miss a nuance of organizations as “*coupled events are responsive, **but** that each event also preserves its own identity and some evidence of its physical or logical separateness... Loose coupling also carries connotations of impermanence, dissolvability, and tacitness all of which are potentially crucial properties of the “glue” that holds organizations together.*” (Ibid, emphasis in original). Like Simons notion of nearly decomposable systems, the concept of loose coupling thus embrace the idea that most systems are neither entirely decoupled nor fully coupled but rather nearly decomposable or hierarchical. This directs attention to the tension that should be part of understanding organizations in the sense that “*the concept of loose coupling allows theorists to posit that any system, in any organizational location, can act on both a technical level, which is closed to outside forces (coupling produces stability), and an institutional level, which is open to outside forces (looseness produces flexibility)*” (Orton & Weick 1990, p. 205). Loose coupling thus allows the comprehension of organizations as systems which are open and closed at the same time. In their review of the literature on loose coupling Orton and Weick identify five streams of research which have focused on different aspects of loose coupling. By bringing these streams together they suggest a theoretical framework to explain the organizational outcomes of loose coupling

which including not only causes, typologies and direct effects but also the managerial actions undertaken to compensate for loose coupling.

Within the software engineering literature Parnas (1972) offered early insights on the value of information hiding by suggesting that modules should be “*characterized by its information of a design decision which it hides from all others. Its interface or definition was chosen to reveal as little as possible about its inner workings*” (Parnas 1972, p. 1056). Furthermore in relation to processes he suggested that when designing software systems the basis for decomposition into modules should be based on design decisions as opposed to steps in the process. Difficult design decisions and decisions which are likely to change should thus be hidden from others by decomposing them into separate modules. These modules would then allow for the assembling of subroutines and programs in which modules can be changed independently without impacting other modules. The principle of information hiding has since been of major importance in object oriented programming and service oriented architecture.

Based on the notion of task problem-solving interdependencies von Hippel propose that they can be managed in two ways, either partitioning the tasks so as to reduce interdependencies between tasks or to reduce the cost of problem-solving across task boundaries. Partitioning tasks has three requirements. Firstly the anticipating of tasks most likely to be sources of new information, secondly predicting which other tasks will be affected by such information and finally the incorporation of these insights in the specification of tasks (von Hippel, 1990). Although it can be expected that in routine innovation projects the participants can make such expectations von Hippel points to the difficulty of making the same predictions when the project undertaken is novel at least initially. Instead he suggests that in such projects task partitioning should take place while the project is unfolding. In conclusion he argues that how to partition tasks in innovation projects have important impacts on the efficiency of innovation processes as well as the solution developed in the end (von Hippel, 1990)

Table 1 Key principles on which the literature on modularity draw

| Author | Area of research | Key principle | Implication |
|------------------------------------|-----------------------------|--|---|
| Simon (1962) | General systems theory | Nearly decomposable systems | Decomposing systems hierarchically is the primary way in which designers can reduce complexity |
| Alexander (1964) | Design | Decomposition of systems into subsystems | Suggest a program of functional decomposition based on the identification of requirement variables and their interdependencies as a key to solve problems of design. |
| Starr (1965) | Operations Management | Modular production | Propose modular production as a method to increase flexibility in manufacturing systems |
| Thompson (1967) | Organizational studies | Interdependencies of components | Complex organizations are natural systems subject to rationality norms, which at the same time attempt to adapt to environment change and reduce uncertainty. Suitable organizational design and coordination depend on the nature of interdependencies |
| Parnas (1972) | Information systems | Information hiding | Modules should be characterized by the knowledge of key design decisions and this should be hidden from other modules through interfaces which reveal as little as possible about its inner workings |
| Weick (1976), Orton & Weick (1990) | Organizational studies | Loose Coupling | Suggest a dialectic interpretation of loose coupling as systems in which responsiveness and distinctiveness are simultaneously present. That is “coupled events are responsive, but that each event also preserves its own identity and some evidence of its physical or logical separateness” (Weick 1976) |
| Von Hippel (1990) | Innovation process research | Task partitioning | Suggest that the way tasks are partitioned in innovation projects has important effects on innovation efficiency and effectiveness. Tasks should be partitioned so as to group together tasks with expected interdependencies. |

Source: Based on literature search on modularity

While the growing academic interest in the topic of modularity is becoming increasingly fine grained with respect to empirical objects of modularity and theoretical understanding of causal mechanisms several seminal contributions are typically drawn upon for key principles which underpin discussions of modularity. As the discussion above reveal these principles are related to different areas of research and bring the principle of modularity into different domains of relevance to management. From being primarily related to physical systems such as products modularity is thus increasingly being discussed in relation to organizations, information systems and innovation. Section 2.1.9 will elaborate on this development and how different intellectual structures are being mobilized by the literature on modularity.

2.1.1.1 Defining modularity

Modularity is a way to design a structure with the intention of reducing its complexity. While complexity is clearly related to the number of different elements of a structure, the nature of

the interdependencies between these and the way they interface has profound implications on structural complexity. Handling this complexity can be done through reducing the number of units and by grouping these units in subsystems. The primary driver in the reduction of complexity is consequently to reduce the interdependencies between elements across subsystems (Langlois, 2002). Modularity can hence be defined based on the relations between the elements of the module and the relations to the elements of other modules. Originating in the Latin word *modulus* for ‘a small measure’ (Webster’s Revised Unabridged Dictionary, 1913) a module has been used to designate various meanings¹. A contemporary meaning of the word module consonant with the above characterization can be found in The Wiktionary defining a module as ‘A self-contained component of a system, often interchangeable, which has a well-defined interface to the other components’. A module is characterized by a high degree of interdependence between the elements of the modules and a high degree of independence across modules (Baldwin & Clark, 2000). The loose coupling of components is enabled through defining an architecture which specifies the interfaces between the components of the architecture (Sanchez & Mahoney, 1996). The degree of modularity thus depends on the components used, their interfaces, the character of the coupling and the opportunity for replacement (Mikkola, 2006).

Through modularity it can be possible to achieve a number of design advantages (Ethiraj & Levinthal, 2004; Sanchez & Mahoney, 1996; Baldwin & Clark, 2000). The modular construction improves opportunities for rapid changes through the splitting and substitution of modules (Baldwin & Clark, 2000). Through the modular product architectures opportunity for ‘mixing and matching’ of modules it is thus argued to be possible to achieve strategic flexibility with the opportunity of greater product variation as well as a higher and more frequent number of product introductions (Sanchez & Mahoney, 1996; Worren et al., 2002). Moreover reusing the same module in several structures enable scale benefits (Baldwin & Clark, 2000) and economies of substitution (Garud & Kumaraswamy, 1995). Product modularity is thus closely related to product configuration strategies such as mass customization and postponement strategies (Mikkola & Skjøtt-Larsen, 2004). Reducing the

¹ Within mathematics modulus is thus the absolute value of a complex number (Sydsaeter & Hammond, 1995, p. 882).

interdependence between modules can reduce asset specificity (Baldwin, 2008), increase the opportunity for outsourcing (Schilling & Steensma, 2001) and in general reduce the cost of coordination between components (Langlois, 2002). In addition modular constructions are more robust to changes in the environment (Pil & Cohen, 2006).

Modularity is not only relevant in relation to product design but can be applied with regard to processes and organizations (Sanchez & Mahoney, 1996; Baldwin & Clark, 2000) although the suggestion that modular product architecture necessarily leads to modular organizations has been questioned (Hoetker, 2006). MacCormack et al. argue that in turbulent environments the flexibility of the development process is essential in order to respond to “*new or changing information during a development project*” (MacCormack et al., 2001, p. 134). In achieving such a flexible development process they point to investments in architectural design, early feedback of system level performance and development teams with generational experience as central elements (MacCormack et al., 2001). The turbulence involves requirements not only for a modular design that can be adapted after its development, but increasingly for a design that can be adapted during its design (Buganza & Verganti, 2006). With regard service design Verganti and Buganza point to a modular technological architecture as being one factor by which life-cycle flexibility of services can be increased (Verganti & Buganza, 2005).

However modularity is not a choice between either – or, but should be made as a tradeoff between the benefits and disadvantages in the specific context (Ethiraj & Levinthal, 2004) in which it is associated with a cost to achieve a modular design over an integrated design (Langlois, 2002). However identifying the optimal level of modularity is not a trivial task, and modularity should not be considered a panacea, rather “*Designers engage in acts of creation, but unlike a divine creator, they lack omniscience. Choices of modules are guesses about appropriate decompositions – decompositions that even in reality are only partial (i.e. nearly decomposable). In making these guesses, our analysis suggests that there should be no presumption of a ‘promodularity’ bias*” (Ethiraj & Levinthal, 2004, p. 172). Indeed there may be a punishment associated with pursuing modularity too far (Ethiraj & Levinthal, 2004).

2.1.2 Methodology and data for the literature review

This section investigates the extant literature on modularity through a review of the literature on modularity. In order to perform such investigation an extensive literature search was performed with a subsequent detailed survey of the resulting literature. This section describes the selection criteria used to identify articles on modularity as well as the criteria by which these were evaluated. Furthermore the methodology for analyzing the literature using bibliographic data is presented.

2.1.2.1 Inclusion and exclusion criteria for literature search

In order to establish a base population of items within the topic of modularity a search was performed on the ISI Web of Science using the Science Citation Index and Social Science Citation Index. The period covering the years 1990 through to 2010 was chosen with the intent to identify the most current state of the research on modularity as well as to uncover developments in the literature. The Web of Science field ‘topic’ was chosen as inclusion criteria, as it evaluates not only the title or author supplied keywords of an article but also abstracts and keyword plus². The search was performed using the Boolean search terms “modularity”, “modular AND design” and “modular AND architecture” and resulted in a total number of 12.100 items.

In order to narrow the search to items focusing on modularity in relation to management, the Web of Science field ‘subject area’ was used as exclusion criteria by omitting items not classified within one or more of the subject areas of ‘Management’, ‘Operations Research and Management Science’, ‘Economics’ and ‘Business’. Furthermore the search was narrowed by the field ‘type’ including only ‘Articles’. The omitted items resulting from this were evaluated in order to ensure that relevant items of other types were not omitted. This evaluation led to the inclusion of the types ‘Proceedings papers’ and ‘Reviews’, as each

² KeyWords Plus[®] are index terms created by Thomson Reuters from significant, frequently occurring words in the titles of an article's cited references

contained several relevant items³ while the residual item types⁴ remained omitted from the search. Finally articles published prior to the search period of 1990-2010 were excluded resulting in an identification of a total number of 524 articles. Based on reading of the abstracts, titles and keywords of these articles a screening was performed, in order to exclude those articles which were not relevant, as well as those articles to which modularity was only treated peripherally. Articles were mainly excluded due to modularity being mentioned as a characteristic of a developed model, or as it related to mathematical algorithms. The screening of abstracts resulted in a list of 342 articles which were either relevant (225) or potentially relevant (117) to the review on modularity as a managerial issue. Figure 1 provides a schematic representation of the search strategy and the items resulting from the search.

³ TS=Modularity OR TS=(Modular AND Design) OR TS=(Modular AND Architecture) Refined by: Subject Areas=(ECONOMICS OR BUSINESS OR OPERATIONS RESEARCH & MANAGEMENT SCIENCE OR MANAGEMENT) AND Document Type=(ARTICLE OR PROCEEDINGS PAPER OR REVIEW) Databases=SCI-EXPANDED, SSCI Timespan=All Years

⁴ Excluded types include: Book reviews (3), Editorial material (3), Note (2), Correction (1), Letter (1), news item (1)

Figure 1 Search strategy

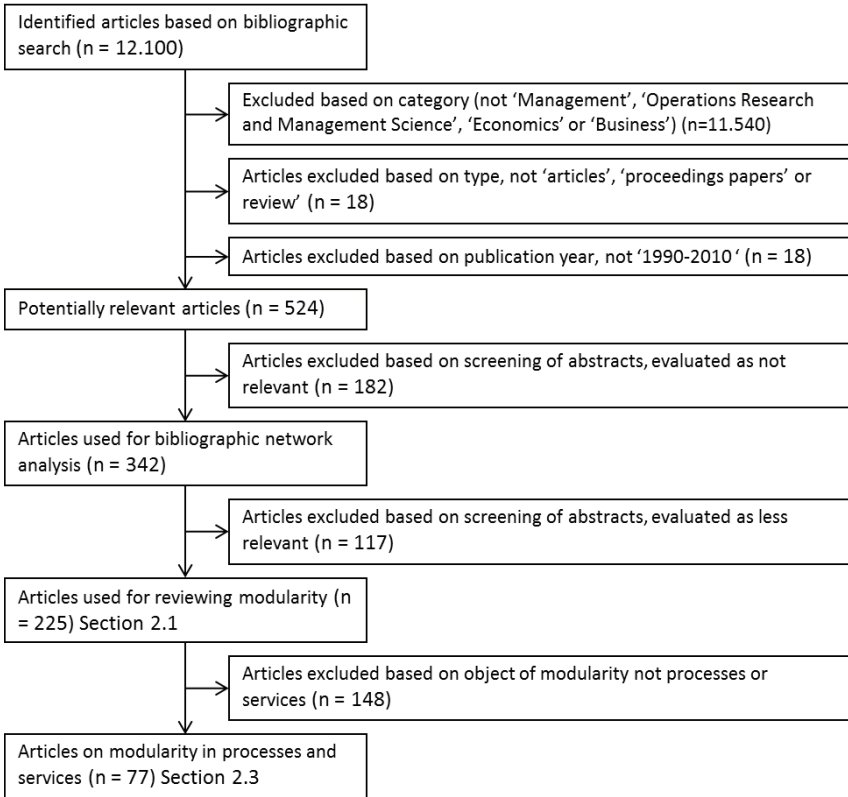

Source: Based on literature search on modularity through ISI Web of Science⁵

2.1.2.2 Limitations of search criteria

The identification of the group of articles which best reflects the topic under investigation is of critical importance to any literature review and different strategies can be chosen. However any search whether subjective or mechanical run the risk of excluding articles which should have been included and conversely include articles which are not relevant to the review. The search strategy and screening process described above thus have limitations and can be

⁵ The literature search was conducted on March 28, 2011

problematized on a number of accounts. Firstly Web of Science only contains selected journals implying that the inclusion criteria may omit relevant items from journals not included in the citation index. Consequently this can result in the omission of journals which may hold articles relevant to understanding the research area of modularity. Furthermore the ISI web of science citation index does not hold full account of all journals included⁶. In example the journal 'Industrial & Corporate Change' is only includes issues from 2002 while the journal has been published since 2000. The search thus excludes Brusoni & Prencipe (2001) which is clearly relevant to the topic investigated. Secondly the choice of terms for performing the search has consequences for the articles resulting from the search. Performing the search only on the term 'modularity', and not including 'modular', 'modul*', 'decomposable', 'platform' etc. necessarily result in a narrow set of items, and could fail to capture important articles on the topic which is not using the exact word of 'modularity'. Using more and broader search terms was thus considered but very broad terms as 'modul*' resulted in a very large fraction of irrelevant items. The narrower set of 'modul AND design' and 'modul AND architecture' widened the search without the raising the number of irrelevant items considerably.

A number of choices were made in order to mitigate the shortcomings of the mechanical nature of the search. Firstly using 'topic' as main search criteria allows the search to be performed not only in the titles of the items but in addition the search also identifies the criteria within the 'abstract', 'author supplied keywords' as well as in the 'keyword plus'. In particular 'keyword plus' enables the identification of articles which touch upon the area of modularity without specifying so in either title, abstract or keyword. Keyword plus are indexed based on the titles of the articles cited references. This resulted in inclusion of clearly relevant articles like Garud et al. (2008) although the search terms are not featured in the title, abstract or author keywords of that article. The search terms are only captured as the article reference three articles with modularity in their titles (Baldwin & Clark, 2000; Ethiraj & Levinthal, 2004; Langlois, 2002). Articles which are relevant to the search but not using

⁶ A list of journals from which articles were identified can be found in appendix 1. The period covered by Web of Science at the time when the literature search was conducted appear in this list.

either of the words used in the search will therefore still have a high chance of being included, provided that their references include articles with the search terms in their titles.

2.1.2.3 Improvements to data quality

Based on the above literature search a dataset consisting of the 342 relevant or potentially relevant articles along with their 16625 individual references (links between article and cited reference) was constructed. Each individual reference was treated as an edge between two vertices (the citing and cited article respectively). In order to identify the individual vertices in the dataset unique reference identification was created.⁷ The data quality of ISI Web of Science is generally high, in particular for items added to the index within recent years. However several inconsistencies were identified. These were caused in particular by errors in abbreviation of author names, page numbers as well as in the abbreviation of journal names. Such inconsistencies imply that the same contribution is not identified as such but is represented as two vertices in the dataset. To eliminate inconsistencies, as well as to handle the occurrences of multiple editions, corrections were made by identifying similar but not identical items and evaluating whether similarity was caused by error in the dataset.⁸ A total of 1342 corrections were made to the data set which largely eliminated redundant occurrences among the most frequently cited references resulting in the dataset being suitable for bibliographic and network analysis.

2.1.2.4 Citation analysis

In order to identify seminal contributions to the literature on modularity citations were analyzed with respect to two groups of articles. Firstly the articles identified in the literature search which were most frequently cited by other articles in the group give an indication of seminal contributions to the literature on modularity. Table 2 shows the 20 articles on modularity which are most frequently cited by other articles on modularity. Articles

⁷ The identification was created by concatenating first author, year, abbreviated publication name (journal or book title), volume and first page.

⁸ An algorithm was constructed in which the concatenated identification was used to compare the number of times it was found in the data set with the number of times its twenty left and right characters was found. Differences between these figures were investigated and changes were made accordingly. For those cases in which an error could not be determined immediately the item was retrieved from journals and library catalogues to enter correct information.

frequently cited by articles identified in the search but which were not themselves returned in the search give an indication of the major pieces of knowledge on which the literature on modularity rest. Section 2.1.9 will briefly discuss this intellectual foundation.

Table 2 Seminal contributions within the literature on modularity

| Reference* | Cited** | Methodology | Theoretical Perspective | Object of modularity |
|--|---------|---|---------------------------------------|--|
| Sanchez & Mahoney (1996) <i>Management in product modularity, flexibility, and knowledge organization design</i> (SMD) | 121 | Conceptual | Strategic Management | Products and organization |
| Baldwin & Clark (1997) <i>Managing in an age of modularity</i> (HBR) | 87 | Conceptual with illustrative cases | Strategic Management | Products and processes |
| Schilling (2000) <i>Toward a general modular systems theory and its application to inter-firm product modularity</i> (AMR) | 85 | General Theory development | General theory of modular systems | Products and General systems |
| Garud & Kumaraswamy (1995) <i>Technological and organizational designs for realizing economies of substitution</i> (SMD) | 44 | Conceptual | Strategic Management | Technological systems |
| Sanchez (1995) <i>Strategic flexibility in product competition</i> (SMI) | 43 | Conceptual | Strategic Management | Products |
| Schilling & Stevensa (2001) <i>The use of modular organizational forms: An industry-level analysis</i> (AMJ) | 41 | Test of model using data from 330 manufacturing industries in the US | General theory of modular systems | Organization |
| Ethiraj & Levinthal (2004) <i>Modularity and innovation in complex systems</i> (MS) | 34 | Conceptual with NK simulation model | Complex Adaptive Systems | Decision variables |
| Sanchez (1999) <i>Modular architectures in the marketing process</i> (JM) | 31 | Conceptual with reference to cases in the literature | Strategic/Marketing Management | Product, processes and knowledge |
| Salvador et al. (2002) <i>Modularity, product variety, production volume, and component sourcing: theorizing beyond generic prescriptions</i> (JOM) | 29 | Multiple case studies (six product families) | Managerial/Engineering | Products |
| Mikkola & Cassmann (2005) <i>Managing modularity of product architectures: Toward an integrated theory</i> (IEEE TEM) | 26 | Modeling (modularization function) with illustrative case (Schindler elevators) | Engineering/Management | Products |
| Langlois (2002) <i>Modularity in technology and organization</i> (JEB0) | 25 | Conceptual - developing a modularity theory of the firm | Organizational Economic | Organization |
| Duray et al. (2000) <i>Approaches to mass customization: configurations and empirical validation</i> (JOM) | 24 | Configuration model to classify mass customizers with empirical validation | Engineering | Products |
| Worren et al. (2002) <i>Modularity, strategic flexibility, and firm performance: A study of the home appliance industry</i> (SMD) | 23 | Conceptual model tested with SEM model (data from managers in home appliance comp.) | Management | Products |
| Mikkola (2003) <i>Modularity, component outsourcing, and inter-firm learning</i> (R&D M) | 17 | Case study (Chrysler Jeep WIPER) | Engineering/Organizational | Products |
| Fleming & Sorenson (2001a) <i>Technology as a complex adaptive system: evidence from patent data</i> (RP) | 16 | Modeling based on CAS with empirical evidence from patent citations | Complex Adaptive Systems | Technology inventions (patents) |
| Sosa et al. (2004) <i>The misalignment of product architecture and organizational structure in complex product development</i> (MS) | 16 | Case study (large commercial aircraft engine development process) | Engineering/Organization | Products and organization |
| Hoerster (2006) <i>Do modular products lead to modular organizations?</i> (SMI) | 14 | Causal model (empirical) | Economic | Products and organization |
| Browning (2001) <i>Applying the design structure matrix to system decomposition and integration problems: A review and new directions</i> (IEEE TEM) | 12 | Literature review (Design Structure Matrix) | Engineering | Products, organization and process |
| PH & Cohen (2006) <i>Modularity: Implications for imitation, innovation, and sustained advantage</i> (AMR) | 11 | Develop theoretical framework | Management/Organizational | Products, processes and design practices |
| Tu et al. (2004) <i>Measuring modularity-based manufacturing practices and their impact on mass customization capability: A customer-driven perspective</i> (DS) | 11 | Empirical survey (n=303, LISREL to estimate structural relations) | Engineering/Organizational/Management | Products and manufacturing processes |

*Academy of Management Journal (AMJ), Academy of Management Review (AMR), Decision Sciences (DS), Harvard Business Review (HBR), IEEE Transactions on Engineering Management (IEEE TEM), Journal of Economic Behavior & Organization (JEB0), Journal of Marketing (JM), Journal of Operations Management (JOM), Management Science (MS), R & D Management (R&D M), Research Policy RP, Strategic Management Journal (SMJ)

** Number of citations from articles identified in the bibliographic search on modularity described in section 2.1.2

Table 2 shows the twenty articles on modularity which are most frequently cited by other articles on modularity and as such gives an indication of the articles which among peers in the field of modularity are considered to be seminal within the recent literature. A number of early articles are conceptual in nature and contribute by bringing together a stream of literature to propose theoretical frameworks on modularity from both the perspective of general systems (Schilling, 2000), strategic management (Garud & Kumaraswamy, 1995; Sanchez, 1995; Sanchez & Mahoney, 1996; Baldwin & Clark, 1997), organizational economics (Langlois, 2002) and organizational studies (Ethiraj & Levinthal, 2004, Pil & Cohen, 2006). Recently several articles have offered empirical insights on modularity through the use of case research (Duray et al., 2000; Salvador et al., 2002; Mikkola, 2003; Mikkola & Gassman, 2003; Sosa et al., 2004), empirical testing using panel data (Schilling & Steensma, 2001; Fleming & Sorensen, 2001a; Hoetker, 2006) and surveys (Worren et al., 2002 and Tu et al., 2004).

2.1.2.5 Bibliographic coupling

Based on the dataset of citations an asymmetric adjacency matrix of references was constructed. As articles that have similar referencing patterns are likely to be related to each other this matrix was used to identify structure in the group of articles resulting from the literature search on modularity. It is possible to calculate metrics for bibliographic coupling as either the number of identical references (Newman, 2010) or Pearson correlation coefficients of the citing references (Pilkington & Meredith, 2009). A high number of identical references or a high correlation coefficient indicate a proximity of two articles whereas low or no shared references or negative correlation coefficients indicate distance in the content of the articles. Based on the data a correlation coefficients matrix was calculated including the 167 articles with 20 or more co citations. To avoid negative values the correlation coefficients were normalized to values between 0 and 1. Based on the correlation coefficients a network graph can be drawn which is shown in figure 4.

Figure 2 Analytical approach to identifying structure within the literature on modularity

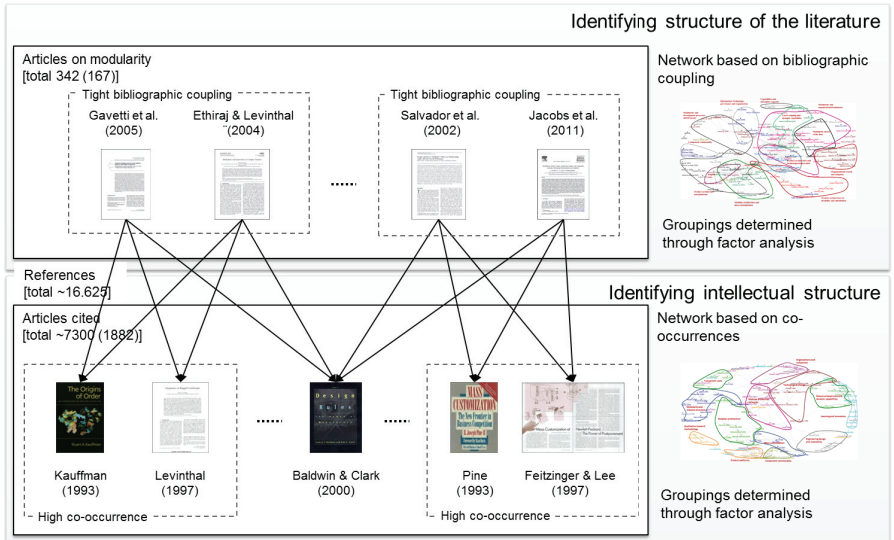

Source: Bibliographic data from literature search on modularity

Figure 2 illustrates how the citation patterns of the identified contributions on modularity enable the identification of two types of structure within the literature. The bibliographic coupling measure enables the identification of groupings of articles with similar citation patterns, which is used to indicate proximity between the content of the citing articles. In example Gavetti et al. (2005) and Ethiraj & Levinthal (2004) display tight bibliographic coupling, as both have a number of references to the literature on complex adaptive systems. Likewise Salvador et al. (2002) and Jacobs et al (2011) display tight coupling due to a number of common references to literature on production systems and mass customization. On the other hand a high number of co-occurrences among cited references indicate proximity in the ideas of the cited articles. The same dataset thus indicate that Kauffman (1993) and Levinthal (1997) are related as an element in the intellectual structure underpinning the literature on modularity. Studying the content of these two contributions reveal that they indeed both are concerned with organizational search and adaptation in

complex systems. The two measures thus provide indications of proximity which can be used to identify structure within the literature. A directed network graph based on a subset of the established dataset on the literature on modularity can illustrate the causes of these proximity measures.

The directed network graph in figure 3 show the referencing relationships between eight articles found through the literature search on modularity and commonly referenced sources. As the figure illustrate the eight articles has a number of references in common, notably Simon (1962), Baldwin & Clark (2000), Sanchez & Mahoney (1996) and Ulrich & Eppinger (1995). However the figure also illustrate that the articles fall in two groups each of which use a distinct set of common references. Although the edges of the graph only contain information on the direction of the reference, these common references indicate that the articles within the two groups have conceptual proximity. Bibliographic coupling is used to estimate this proximity. Similar citation patterns of two articles thus result in a higher measure of bibliographic coupling. On the basis of this measure a network graph in figure 4 is constructed and illustrates the relationships between the articles identified in the literature search on modularity. Linkages in this graph indicate bibliographic coupling between two articles with denser links indicating higher bibliographic coupling. On the basis of the bibliographic coupling measure factor analysis was used to identify groups of articles which are tightly coupled with other articles within the group and less so with articles outside the group. Figure 4 show such a network visualization of the literature on modularity with indication of the identified groupings within the literature.

Figure 4 Network visualization of the literature on modularity in relation to management

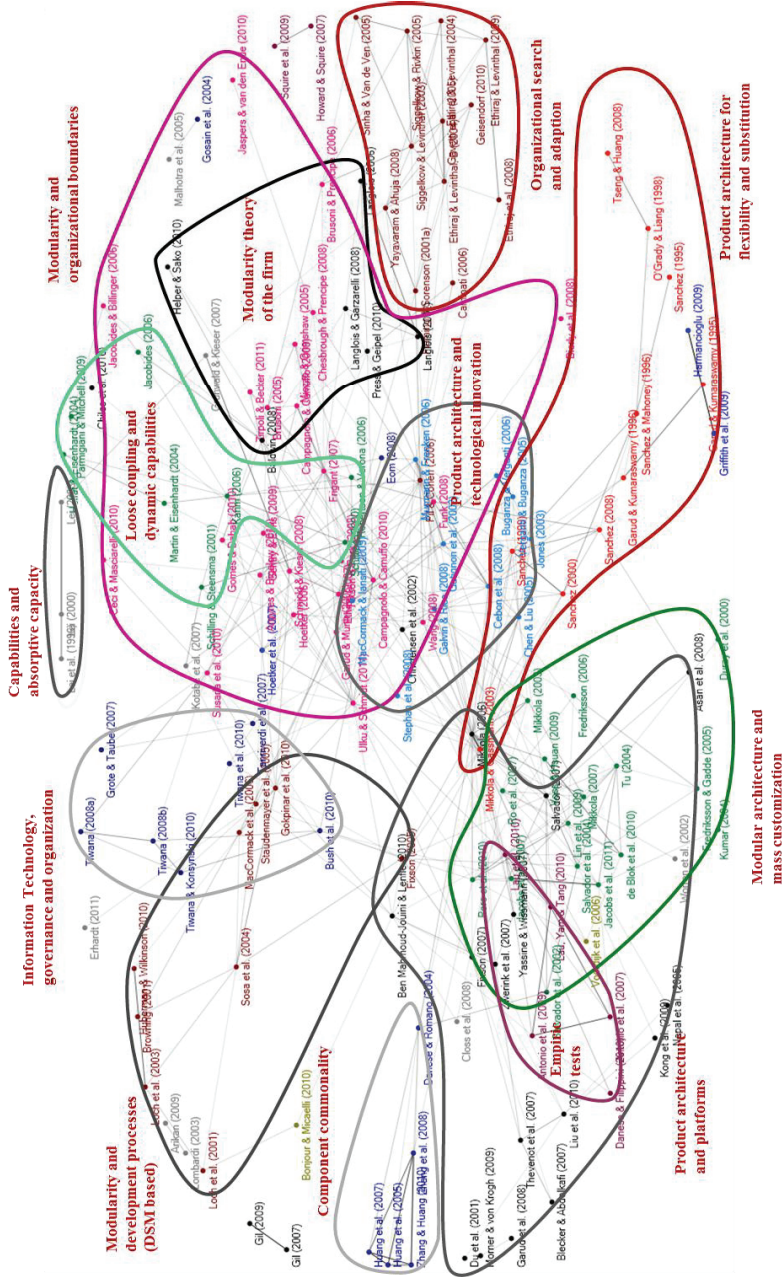

Source: Bibliographic data from literature search on modularity

Figure 4 is created using the software NodeXL based on bibliographic coupling citation data from the literature search on modularity as described above. The network reveals that the literature on modularity has distinct groupings of research with similar referencing patterns. The figure also shows that several of these groupings are related and in some cases overlapping which indicate that although distinct they do share commonalities. These groupings and their individual contributions are discussed in the sections below.

On the basis of the network graph it is possible to identify groupings of articles with higher correlations. In order to analyze these groupings a factor analysis was conducted using the statistical software SPSS (PASW 18). The factor analysis was performed using Varimax rotation with the number of components determined on the basis of a scree plot of their eigenvalues (see appendix 3). The rotated component matrix was inspected to identify the characteristics of each component on the basis of the individual article in the component. In order to interpret these groupings the content of the articles in each group was investigated to identify commonalities among the articles. In addition the individual references of each group were used to identify what caused the articles to have high bibliographical coupling. As will also be discussed in relation to the co-citation analysis different groupings of articles typically draw on different strands of research and modularity as a topic tend to be defined and discussed in relation to different seminal articles on modularity. I.e. the group ‘organizational search and adaption’ tend to define modularity with reference to Simon (1962) on near decomposability and Baldwin and Clark (2000) whereas the group ‘product architecture and technological innovation’ tend to define modularity with reference to Henderson & Clark (1990) and Ulrich (1995).

Based on the groupings identified through the bibliographic analysis of the content within each of these groupings the next section will explore the field of modularity and its development. The analysis revealed three overall strands of the literature on modularity. One strand of literature has focused on the strategic impact of product modularity with an emphasis on the relation between product architecture and strategic flexibility and technological innovation. Another strand, primarily based on engineering and operations management, has on the one hand sought to conceptualize and measure modularity within

product architectures and on the other hand related product architecture to production strategies of mass customization and platforms. Finally the relevance of the concept of modularity to the study of organizations has sparked a number of research interests into organization studies and modularity. The subsequent three sections will investigate each of these by taking a closer look at the groups within each of the three strands of literature on modularity.

2.1.5 Product modularity with strategic impact

As discussed above much of the focus in the literature on modularity has traditionally been on product architecture and how modular design is related to strategic outcomes. A key interest has been how modularity enables the organization to achieve strategic flexibility and economies of substitution. While the focus of one part of this literature has primarily been on strategic advantages of the organization, another has been interested in how modular product architecture has strategic implications on industry level by impacting technological innovation.

2.1.5.1 Product architecture for strategic flexibility and the economics of substitution

One group of papers including the seminal paper by Sanchez and Mahoney (1996) address the strategic benefits of achieving flexibility through the design of product architectures for substitution. Modularity is defined with primary reference to the work of Langlois & Robertson (1992), Simon (1962), Garud & Kumaraswamy (1993) and Sanchez & Mahoney (1996). In a conceptual paper Sanchez and Mahoney argue that standardized interfaces in modular product architectures enable embedded coordination and thus create loosely coupled organizational forms. They thus suggest that modular product architectures lead to modular organizations. This in turn has the consequence that product development can be carried out more effectively due to the flexibility of modular organizational structures (Sanchez & Mahoney, 1996). Sanchez argue that strategic flexibility of modular product architectures is of primary importance, and that it is a strategic benefit of modularity, as it enables the configuration of products to increase variety and the ability to update products (Sanchez

1995, Sanchez 2008). The economics of this ability is what Garud and Kumaraswamy denote economies of substitution which *“exist when the cost of designing a higher-performance system through the partial retention of existing components is lower than the cost of designing the system afresh”* (Garud & Kumaraswamy, 1995, p. 96).

O’Grady and Liang (1998) likewise take the benefits of strategic flexibility as point of departure, and develop a formal evaluative framework of design with modules. Using an object oriented approach their framework attempts to capture the benefits and costs of different combinations of modules, in evaluating different design with modules and illustrate using the example of PC configuration (O’Grady & Liang, 1998). By analyzing components, interfaces, degree of coupling and interfaces Mikkola and Gassmann (2003) evaluate the product architecture of two elevator systems and compare their respective degrees of modularity. However the application of the function also highlights some of the architectural tradeoffs facing designers as they have to decide on using novel or standardized components, their reuse across product families and the specification of interfaces. Mikkola and Gassmann further point out, that these decisions are linked to the manufacturing strategy and organizational design, as well as to the sourcing strategies of the company (Mikkola & Gassmann, 2003).

Whereas Sanchez & Mahoney is predominantly concerned with the benefits of modularity, Garud & Kumaraswamy explicitly include both the cost and benefits of modularity and note that *“the benefits of upgradability and associated retention of components must be weighed against the costs of component reuse”* which are related to the performance slippage, incorporation costs, testing costs and search costs (Garud & Kumaraswamy, 1995, p. 96). Importantly Garud & Kumaraswamy point to system integrity as a crucial aspect of design, which is impacted by incompatibility of system components. System integrity can be achieved by manufacturing compatible components, either by crafting them individually and making them fit together through trials and rework, or by standardizing component specifications. This standardization *“involves codification pertaining to the form and function of components and the interfaces among components”* (Garud & Kumaraswamy, 1996, p. 885) and allow for learning to take place at different levels. The use of standards is a crucial

feature of modularity and is what protect system integrity from eroding. However modularity is not without its own dangers, as Garud and Kumaraswamy point out “*Excessive modularity, however, can compromise system integrity. For instance, with each new effort to modularize the system, the number of interfaces increases. As the number of interfaces increases, the possibility of performance losses at the interfaces also increases. Furthermore, excessive modularization increases the complexity of the design.*” (Garud & Kumaraswamy, 1996, p. 885). In addition to achieving products with both system integrity and modularity they emphasize upgradability as the key to realizing economic benefits. Upgradability requires sufficient technological degrees of freedom to allow designers to increase performance by updating lower level components.

Using object oriented programming as an illustrative example, Garud and Kumaraswamy (1996) argue for the importance of upgradability of technologic systems but at the same time note that there are organizational impediments to achieving such design: “*Retention and reuse can be accomplished by designing modularly upgradable technological systems. However, such a design focus raises several organizational issues. For instance, the organizational structure needs to be modified considerably to promote learning and knowledge sharing. Additionally, the control and incentive system need to be changed so that designing for reuse and actual reuse are monitored closely and rewarded*” (Garud & Kumaraswamy, 1996, p. 889). Therefore “*a key challenge in realizing economies of substitution is the design of organizational systems that enhance component retention or reuse while reducing associated costs*” (Garud & Kumaraswamy, 1995, p. 98). Specifically “*within the firm, for instance, competition for a limited pool of resources between individuals creates incentives for increasing current performance even at the expense of future performance*” (Garud & Kumaraswamy, 1995, p. 104). They thus point to a fundamental discrepancy between those aiming at a design for reuse and the efficiency in designing and producing an individual component. Reuse requires abstraction and consideration for incorporating into the design openness for possible future usage whereas efficiency in developing a component favors specificity to the current use situation.

2.1.5.2 Product architecture and technological innovation

The modularization of technical systems has important implications for the understanding of technological innovation, product life cycles and dominant design. Defining modularity primarily with reference to Henderson & Clark (1990), Sanchez & Mahoney (1996), Ulrich (1995) and Baldwin & Clark (1997) these articles combine modularity and the literature on technology management (Tushman & Anderson, 1986; Clark, 1985; Christensen & Rosenbloom, 1995). Gatignon et al. (2002) point out that much of the previous literature on innovation does not take modularity into account. They propose a structural approach to innovation which takes into account not only the type of innovation (generational and architectural) and innovation characteristics (incremental/radical, competence-enhancing, and competence-destroying) but also the innovations place in the product hierarchy (core/peripheral). Based on a survey of 141 R&D managers they find that *“innovation type, characteristics, and locus in a product's hierarchy have contrasting effects on innovation outcomes. Innovations in core subsystems seem to be treated as strategic and are executed rapidly. Where architectural innovation seems to challenge organizational capabilities, organizations seem to quickly execute both competence-enhancing and new competence acquisition innovation in core subsystems”* (Gatignon et al., 2002, p. 1121). Based on a review of the literature on dominant design Murmann and Frenken (2006) synthesize ideas from prior research and based on complexity theory they propose a model of dominant designs in which modularity of product architectures is incorporated. They claim that *“As a result, our complex system model of dominant designs can explain both why artifacts evolve as a nested hierarchy of technology cycles... and why multiple mechanisms can contribute towards the emergence of a dominant design”* (Murmann & Frenken, 2006, p. 931). In a conceptual paper Ceborn et al. (2008) suggest that modularization alters the traditional life cycle model by undermining the drivers that would otherwise lead to lock-in to dominant designs. Modular product architecture thus acts as a destabilizing force for the industry by increasing innovation on several levels. A consequence of modularization according to Ceborn et al. is thus that *“Innovation processes no longer stabilize the industry, but rather destabilize it. This destabilizing force limits the specific synergies that might be obtained from*

current design and product systems within an industry, thereby weakening the incentives that lead to lock-in." Ceborn et al. (2008, p. 376).

In the context of services Verganti and Buganza focus on the managerial need for flexibility in the entire life-cycle and not only in the product architecture or the development process. They suggest that modularity can be one way to increase the flexibility over the life-cycle (Verganti & Buganza, 2005) and explore this in the context of the on-line broker industry (Buganza & Verganti, 2006).

2.1.6 Modularity within engineering and operations management

Modularity has important implications for the production and delivery of products and services and has thus been a growing topic within recent years within the engineering and operations management literature. One area of research within this literature has been on developing frameworks and methods for defining, conceptualizing and measuring modularity in product architecture. Other major areas of research have focused on the relation between modularity and manufacturing practices, in particular mass customization, and on modularity in relation to product development processes. Finally a number of empirical studies have recently investigated the relationship between modularity of products and the performance of firms and supply chains.

2.1.6.1 Frameworks and definitions for product architecture,

Modularity is an important aspect of product architecture and there are thus a significant number of contributions on product architecture which consider different aspects of modularity. These primarily define modularity in relation to the literature on engineering design (Pahl, 1996; Ulrich, 1995), product platforms (Meyer & Lehnerd, 1996; Fisher et al., 1999) and mass customization (Pine, 1993). Many of the articles in this group provide conceptual frameworks with applications to illustrative cases while a few present formal optimization models.

Zwerink et al. (2007) develop a framework to evaluate product architectures based on relations between different product architecture decisions and -capabilities as well as to

different aspects of performance on the organizational (internal) and business unit level (external). The various dimensions are illustrated through a case from the home appliances industry (electrical toothbrush) and questionnaire constructs are developed. The study reports on the procedural findings from a pilot application of the framework within two cases. However the study does not report on the results of the product architecture framework.

Kong et al. (2009) review the history of modularity and develop a framework for modular product development consisting of a 15 step sequential development process. During the first seven steps functional modularization is conducted which is a virtual decomposition of functions. Subsequent to an architecture assessment the last seven steps are concerned with physical modularization, that is the realization of the architecture. Although they suggest that each of the steps in the virtualization and realization phases of the development has its counterpart and is related, the logic of their framework is nevertheless linear with reverse flows only falling between adjacent steps. The paper is purely conceptual and although claims are made for the appropriateness of the framework no empirical evidence is presented.

Nepal et al. (2005), present a method for optimizing modularization during the early stages of product development based on fuzzy logic approach. The approach involves obtaining multiple estimates of the cost effects of different pairwise combinations of a set of components into modules. These estimates are then transformed into a cost performance index for each combination of components based on which linear programming can be used to optimize the composition of modules with respect to cost. Although the case of a non-specific coffee maker is used to illustrate the method, the study does not provide empirical testing of the proposed methodology in an industrial context.

Mikkola (2006) suggest a general framework for conceptualizing product architecture as well as the application of the modularization function to capture the degree of modularity in a product architecture based on the framework. The cases of two product architectures (an elevator and a windshield wiper) are used to illustrate the application of the framework and the modularization function and highlight a number of managerial tradeoffs and dilemmas (Mikkola, 2006). Whereas the function of Mikkola measures degree of modularity Blecker & Abdelkafi (2007) suggest an index based approach to measure commonality.

While the above frameworks are all related to single product architecture the architecture of product families have been discussed in the literature. Du et al. (2001) thus point to the importance of considering decisions that span across the individual product and consider the architecture of product families. They suggest a framework comprising a common bases, differentiation enablers, and configuration mechanisms. A generic product structure which act as the basis for variety generation achieved through the mechanisms of attaching, removing, swapping, and scaling. The framework is illustrated through a case of the design of a specific Power supply product family. Liu et al. (2010) develop a similar framework but extend this into a formal optimization model for architecture decisions across products within a product family. Their model is based on a sequential design process in which modularity is used to achieve variety of functions while commonality design is used to economize by reusing elements of the platform. Application of the model is illustrated through the case of a family of power tools (Liu et al., 2010). The tradeoff between commonality and diversity is an inherent aspect of product family design for which Thevenot et al. (2007) develop an index based method to help designers manage during all stages of the product family design process.

Ben Mahmoud-Jouini & Lenfle (2010) extend the discussion of the architecture of product families by considering platform evolution across its lifetime. They focus on the reuse of platforms from one generation of products to the next. Through a single case study within the automotive industry they show how two design rules were mobilized implicitly by designers at different times during the development of the new product. These involved on the one hand a rule of carrying over components in order to favor commonality and on the other hand a rule to avoid overdesigning. However in their case of reusing the platform itself across product generations they find that these design rules are challenged by what they label ‘smart reuse’. This involves a learning mechanism resulting in the co-evolution of the product and the platform itself.

2.1.6.2 Modular architecture and mass customization

Although most of the articles in this group are also interested in product architectures they are generally so in relation to the capabilities of the production system. Modularity in this group

is not only discussed in relation to products but also processes (Tu et al., 2004; Jacobs et al., 2011; Fredriksson, 2006; Fredriksson & Gadde, 2005) as well as services (de Blok et al., 2010; Voss & Hsuan, 2009). Major attention is given to the relationship between product architecture and supply chain configuration (Pero et al., 2010; Lin et al., 2009) and particularly mass customization (Tu et al., 2004; Duray et al., 2000; Mikkola, 2007; Ro et al., 2007; Salvador et al., 2004; Kumar, 2004). Common references are made to Pine (1993) and Feitzinger & Lee (1997) and modularity in this group of articles is primarily defined with reference to Baldwin & Clark (1997), Ulrich (1995), Schilling (2000) and Starr (1965).

Duray et al. (2000) suggest a typology of mass customization by characterizing according to when customers are involved in specifying the product and the type of product modularity which is employed. Similarly Salvador et al. analyze the relationship between types of modularity and types of mass customization using the product family as unit of analysis in a multiple case study (2002, 2004). They identify two distinct supply chain configurations which they characterize as 'hard' and 'soft' mass customization and find that the type of modularity depends on the level of customization. With moderate levels of customization component swapping modularity is a key element in the 'soft' configuration while with high levels of customization component modularity is crucial for the 'hard' mass customization configuration. The relationship between product architectures and production processes also involve the question of how product modularity affects coordination. In a case study at Volvo Fredriksson and Gadde investigate how Volvo uses the coordination mechanisms of plans, standardization and mutual adjustment to coordinate its modular assembly. They demonstrate how the standardized interfaces of modular product architecture are in themselves insufficient to ensure coordination of the production process (Fredriksson & Gadde, 2005; Fredriksson, 2006). In a recent study of the US automotive Ro et al. show that the move to modularity has led to major changes of supply chain practices but also find that modularity has largely been used to realize cost reductions rather than to allow for customization (Ro et al., 2007).

Mikkola investigate the relationship between product modularity, outsourcing and inter-firm learning on mass customization (Mikkola, 2003) and apply the mathematical modularization function to capture the modularity of product architecture based on its characteristics

(Mikkola, 2007). Similarly Kumar develop metrics based on product characteristics to capture the extent of customization and mass production. As these two measures represent the value and cost of customization respectively Kumar suggest how these two measures can provide the basis for optimizing mass customization capabilities (Kumar, 2004). In order to develop constructs for modularity based manufacturing practices Tu et al. conduct a survey of manufacturing engineers. Based on their survey they construct a structural equations model and find that all of the three constructs ‘product modularity’, ‘production process modularity’ and team modularity’ have positive impacts on mass customization (Tu et al., 2004). Finally through survey research Jacobs et al. find a positive the relationship between product modularity and manufacturing performance (Jacobs et al., 2007) and recently that “*product modularity facilitates process modularity, engenders manufacturing agility, and improves growth performance in ROI, ROS, and market share*” (Jacobs et al., 2011).

2.1.6.4 Empirical surveys of the relationship between modularity and performance

Recently a number of articles have been published based on survey research attempting to empirically test the effects of product modularity and several outcome measures such as supply chain integration and performance. These articles defining modularity with primary reference to Sanchez & Mahoney (1996), Ulrich (1995), Sanchez (1995) and Schilling (2000) and with reference to key articles from Operations Management journals such as Duray et al. (2000) and Salvador et al. (2002).

Based on a structural equation model of survey data from 251 Hong Kong manufacturers Antonio et al. find a positive relationship between product modularity, and competitive capabilities (Antonio et al., 2007) as well as supply chain integration (Lau et al., 2010). When including internal integration (business processes aimed at increasing functional integration) they find both positive relationships as well as interaction effects between product modularity and internal integration to improve product innovativeness and product quality (Antonio et al., 2009). Danese & Filippini use hierarchical regression analysis based on survey data from 186 manufacturing plants and find that product modularity positively affects NPD time performance. Furthermore this effect is intensified by integration between functions in the NPD process (Danese & Filippini, 2010).

Using multiple regression analysis to analyze survey data from purchasing directors in 104 manufacturing companies Howard & Squire (2007) find that modularization lead to increased supply chain collaboration a relationship that is mediated by relationship specific assets and information sharing. As they note “*modularization is not a process of specifying an interface and product dimensions, but involves ongoing consultation after the initial brief has been set to ensure the product architecture functions together as a whole*” and their findings thus contradict the propositions that modularity lead to arms-length relationships (Howard & Squire, 2007). Similarly Squire et al. (2009) find a positive relationship between supplier modularity and buyer responsiveness. However contrary to their expectations they find a negative interaction effect from collaboration indicating that with high modularization there is less to be gained through collaboration (Squire et al., 2009).

2.1.6.5 Modularity and development processes (DSM approach)

These articles are on modularity in relation to product development which primarily applies the design structure matrix to investigate the dependencies within product architectures and its effect on the development process. The group primarily defines modularity with reference to Alexander (1964) and based on Eppinger et al. (1994) and Baldwin & Clark (2000) and the design structure matrix is employed as the primary method of investigation. This field link the study of modularity to the literatures on product development (Ulrich 1995, Thomke 1997, Brown & Eisenhardt 1995), concurrent engineering (Terwiesch et al. 2002) as well as engineering design projects (Mihm et al. 2003, Smith & Eppinger 1997).

The design structure matrix offers a structured way to model the design interdependences between the components of the architecture. Through integration analysis it subsequently enables innovation at the architectural level. The use of clustering algorithms based on the design structure matrixes is one way of realizing modularization by utilizing knowledge of interdependencies to group together components which are highly interdependent among themselves, but relatively independent from other components into modules (Browning 2001). Alternative perspectives are possible to model such as team dependencies and dependencies between activities i.e. in a development process.

A number of studies have investigated modularity from a DSM perspective. MacCormack et al. (2006), apply the DSM to study two different information system designs, that of Mozilla Firefox and the Linux operating system. Using source code to extract and map dependencies between component elements they are able to estimate the modularity of the different software systems. Due to the fact that Mozilla was redesigned in 1998 they were able to identify the level of modularity before and after the redesign. Based on this they demonstrate how the subsequent design was substantially more modular than the prior and by juxtaposing with data on propagation costs they demonstrate a positive economic benefit of modularity. Huberman & Wilkinson (2010), model project dynamism through the use of a work transformation matrix the calculation of which is based on design structure matrices. They suggest their model to be a useful tool for coordinating projects with particular attention to managing unpredictability. Fixson (2005) take the function-component allocation matrix and characterizations of interfaces as point of departure to develop a method for assessing product architecture. He suggests that these two dimensions form the basis for product architecture maps which offer graphical representations of product architectures.

In the context of the development of an aircraft engine at Pratt & Whitney, Sosa et al. (2004), study the misalignment between design interdependencies and team interactions. Through interview with design engineers they decomposed the engine into six modular and two integrative subsystems with corresponding components. They further gathered data on design interdependencies which were represented in a design interface matrix. Comparing this data with a team interaction matrix they estimated an alignment matrix detailing whether or not interdependencies between components were met by interactions between teams responsible for the individual components. This matrix was subsequently analyzed using statistical network analysis in order to identify causes for misalignment. In relation to modularity they find that *“a significantly larger proportion of unmatched design interfaces across modular systems... (this) suggests that modularization itself may further hinder design teams’ ability to handle interfaces across boundaries”* (Sosa et al., 2004, p. 1686-7). Recently Gokpinar et al. (2010) have extended this area of study to include the effect of misalignment on performance. Based on data from in a vehicle development process covering 243 subsystems in 13 vehicle programs, they use social network analysis to estimate measures of subsystem centrality and

misalignment. They use a coordination deficit measure to capture misalignment between connectivity of the product architecture and levels of formal coordination. Using these measures as independent variables in a regression analysis with warranty issues as dependent variable they find that quality problems are more likely to occur in subsystems with intermediate centrality. They speculate that it is more difficult for managers to identify the appropriate attention for such subsystems that are neither obviously simple nor complex. More importantly they find that the coordination deficit metric is positively correlated with warranty incidents suggesting that misalignment of development organization and product architecture is detrimental to performance (Gokpinar et al., 2010).

There are clear linkages between the representation of design projects as design structure matrices and the search and problem solving conceptualization using the interaction matrix between decision variables in the complex systems perspective. Loch et al. (2001) thus construct a model to evaluate the consequences of performing sequential or parallel testing and Loch et al. (2003) model the decision making of design engineers in projects where each engineer is responsible for deciding on a single component whose performance is dependent on the decisions made on other components. This model is an extension of the NK model and based on it they simulate the consequences of introducing cooperation between agents and of increasing modularity in the structure of interdependencies. They find that in design projects quickly become complex and display nonlinear behavior, i.e. the design start to oscillate between different design solutions before it converges. They conclude that it is not possible for management to solve this challenge but that there are actions available which can mitigate it. There are thus large effects from design engineers optimizing globally and being willing to sacrifice a small reduction in the performance of their own component for the sake of increasing performance on other components. Furthermore management can take actions to reduce the size of the development project or reorganize interdependencies of components through modularization (Loch et al. 2003)

Whereas the literature on modularity would typically suggest that modular product architecture enable the use of inter-firm networks by reducing the complexity of their interfaces the case studies of Staudenmayer et al. (2005), suggest a more complex picture.

Based on cases of product development in seven companies within the telecommunication industry they find that in the design of new products companies face a number of challenges in the presence of inter-firm product modularity. Among these they find that whereas a modular architecture is supposed to anticipate and reduce interdependencies in the inter-firm interfaces they find that *“many interdependencies were not necessarily identifiable in advance or visualizable by employees; instead, they emerged unexpectedly over time... These hidden interdependencies could pop up unexpectedly and required flexible management responses”* (Staudenmayer et al., 2005, p. 313). Whereas the literature on modularity tends to suggest the importance of anticipating and severing interdependencies between modules, they contest that the companies instead focused attention on identifying and managing interdependencies as they arose. This reflects an acknowledgement that complete ex-ante identification of interdependencies and subsequent specification of interfaces is unattainable in the contexts they studied and that significant importance lies in the solutions constructed to reflect the divergence to this ideal.

2.1.7 Organizations and modularity

The literature on modularity has increasingly been linked to the study of organizations both in the sense that product and service modularity have effects on the structure of organizations, but also as a structural property of organizations themselves and decision making within organizations. The notion of modularity is thus being used as perspective on organizations offering insights into the boundaries of the individual firm as well as on the structure of knowledge across firm boundaries in industrial networks. Modularity is being linked to the capacity of organizations to absorb knowledge and to build the dynamic capabilities argued to be essential for maintaining competitive advantages. Moreover the development of distributed information and communication technologies have sparked an interest in modularity within information systems research in particular in relation to consequences on outsourcing and alliance formation. Based on research on organizational search and adaption a stream of literature has developed which is studying modularity in relation to decision making in complex systems. Finally several scholars are mobilizing the knowledge on modularity as a

starting point for developing a theory of the firm embracing the dynamism of technological change.

2.1.7.1 Capabilities and absorptive capacity

Drawing on the literature on knowledge creation and learning a number of contributions are studying the role of modularity in the ability of organizations to create competitive advantages. These articles are extending the discussions of organizational learning by drawing on the concept of modularity as a mechanism that facilitates or reduces the need to share knowledge within and across organizations. They are engaged in discussion with the literature on knowledge creation (Nonaka, 1994), organizational learning (March, 1991) and absorptive capacity (Cohen & Levinthal, 1990). These articles are thus interested in the development of capabilities within firms (Lei et al., 1996; Kusunoki et al., 1998) as well as knowledge exchange across firms (Arikan, 2009; Malhotra et al., 2005; Grunwald & Kieser, 2007) and across industries (Lei, 2000; Lei, 2003).

Lei et al. (1996), studied investment in advanced manufacturing technological capabilities and how the value of these capabilities is related to organizational design. They argue that a loosely coupled modular organization increases the option value of such capabilities as it enables the firm to identify and exercise those options made available through advanced manufacturing technologies (Lei et al., 1996). In discussing capabilities Kusunoki et al. (1998), use modularity as one dimension to describe those capabilities which are *“based on individual knowledge units” as opposed to those who “link and combine each unit of knowledge”* (Kusunoki et al., 1998, p. 700). Using this dimension along with the extent to which capabilities are designable they distinguish between local, architectural and process capabilities. Based on a survey of 656 Japanese companies they find that different competencies are related to performance depending on industries. They further note that the competitive strength of process capabilities of Japanese may be threatened by modularity as technologies that enable standardization of interfaces between product subsystems undermine the value of process capabilities.

Focusing on clusters of firms Arikan (2009), in a conceptual paper build on the knowledge creation theory of Nonaka to develop a theoretical model explaining the factors which influencing the knowledge creation capabilities of clusters. He suggest that the degree of product modularity has a negative impact on the opportunities for inter-firm knowledge creation, reflecting that with perfectly modularized products there is no need for knowledge exchange as fully standardized interfaces enable arm's length transactions (Arikan, 2009). In the context of supply chains Malhotra et al. (2005) use the notion of inter-organizational process modularity (Sanchez, 1996) to refer to a supply chain process architecture in which the individual firms are performing well defined sub processes on which they can experiment independently. Consequently: *"enterprises are better able to recognize the holes in their knowledge and identify external sources for obtaining information to improve their own capabilities"* (Malhotra et al., 2005, p. 155). Based on interviews and survey data from 13 partnerships in the RosettaNet Consortium they note that the role of standardized business interfaces is both structural and cognitive in the sense it allows enterprises to link to potential partners faster and also through modular process architectures reduce the cognitive load on managers thus increasing their absorptive capacity (Malhotra et al., 2005).

In a study of cross organizational learning in four architectural innovation projects performed in strategic alliances between SAP and partner companies Grunwald & Kieser (2007), interestingly find that in order to overcome the limited absorptive capacity of the individual the organizations focused on reducing inter-organizational learning rather than increasing it. Instead of integrating knowledge across specialists from the alliance partners they relied on modularizing the projects tasks and products a process in which components were assigned to the partnering organizations and their interfaces specified. Furthermore the storage of knowledge in artifacts, the ability to locate needed knowledge outside the project members and using prototyping to achieve knowledge integration reduced the need for sharing content knowledge, which only occurred selectively when problems arose. Through their study they thus argue that, contrary to the dominant view, innovation projects between alliance partners benefits from learning the mechanisms allowing them to avoid inter-organizational learning, of which modularization is an important mechanism (Grunwald & Kieser, 2007).

The role of modularity on capabilities has not been confined to the single industry but has been extended to include the interaction between industries. Lei (2000) thus discuss the role of modularity on technological convergence and not that *“The concept of modularity becomes especially salient to firms that must compete in convergence-prone environments, since product and service offerings must be ‘malleable’ or flexible enough to adapt easily to new technologies, complementary combinations with other offerings, and new customer usage patterns”* (Lei, 2000, p. 722). In such environments he argues, modularity is one element in a strategy to compete in an innovation net which spans the boundary of particular industries (Lei, 2003). He defines innovation nets as a *“network or cluster of companies that simultaneously cooperates and competes to develop product and service offerings through the use of shared product architectures, technical standards, or technological platforms”* Lei (2003, 697). Competitive advantage in the innovation net he argues is thus impacted by the ability to develop modular products due to the embedded coordination provided by modularity.

2.1.7.2 Loose coupling and dynamic capabilities

These papers focus on modular organizational forms, and thus the conditions of the boundary of the firm in the light of technological change and market dynamism. Common to these papers is a rooting in the competence based perspective of the firm (Penrose, 1959; Chandler, 1962; Teece, 1986; Barney, 1991; Wernerfelt, 1984) and dynamic capabilities (Leonard Barton, 1992; Teece et al., 1997; Eisenhart & Martin, 2000). Modularity is primarily defined in relation to organizational and product architecture and with reference to Baldwin and Clark (2000), Sanchez and Mahoney (1996) and Henderson and Clark (1990).

Schilling attempts to establish a general modular systems theory that explains the forces driving systems from integral to modular and vice versa. The theory is formulated based on systems in general and is used to model inter-firm product modularity (Schilling, 2000) and organizational modularity at the industry level (Schilling & Steensma, 2001). In their analysis Schilling and Steensma use industry level data and hierarchical moderated regression to empirically study the drivers of modular organizational forms. They find support that the heterogeneity of inputs and demands positively influence the level of modularity. This

relationship is affected by the existence of industry standards, the levels of technological change and the degree of competitive intensity (Schilling & Steensma, 2001). The model thus point to trade-offs that management should take into consideration when deciding on levels of organizational modularity. They argue that those with the ability to anticipate and respond to changes in these variables may hold competitive advantage by gaining appropriate levels of flexibility or efficiency. Following similar lines of thought Martin & Eisenhardt (2004), argue that a re-combinative organizational form emphasizing modular organizational structure and dynamic capabilities is advantageous in high velocity markets with frequent decline. Through a case study they illustrate the modular organization and the three dynamic capabilities of probing, patching and recoupling and suggest how these facilitate corporate entrepreneurship (Martin & Eisenhardt, 2004) and suggest how inter-temporal economies of scope can be obtained through redeploying resources between businesses in related diversification (Helfat & Eisenhardt, 2004). Using publication data from guides on the US medical industry Karim (2006) explore *“how firms pursue modular structural change through the reconfiguration of acquired and internally developed business units”*. She finds that firms with greater experience in reconfiguring tend to do so sooner than other firms. Furthermore acquisitions are typically used to experiment with reconfigurations while internally developed units are reconfigured later and remain in the firm for a longer time (Karim, 2006, p. 821).

Attempting to bridge transaction cost economics and the competence based perspective Parmigiani and Mitchell (2009) studied concurrent sourcing of complementary goods. Based on explorative interviews and a survey of the metal stamping and metal powder industry they find that firms often source complimentary goods concurrently that is, at the boundary of the firm. As they note *“this approach bridges the gap between the traditional and modularity arguments by suggesting that firms often do not need to unilaterally make or buy a set of components, but can sometimes do both”* (Parmigiani & Mitchell, 2009, p. 1083). Robertson & Verona (2006) synthesize a range of theoretical insights to reach a number of propositions on changes of the vertical boundary of the firm suggesting mechanisms that drive towards integration and others driving towards disintegration. As such they extend the traditional transaction cost economic explanation by including dynamic transaction costs as well as dynamic capabilities and modularity as relevant explanations in situations of technological

change (Robertson & Verona, 2006). In a similarly integrative manner Jacobides lay forth a research program on architecture and design of organizational capabilities which as he notes has a broad foundation in the sense that it constitutes a Neo-Schumpeterian research program drawing not only on evolutionary based theorizing but also the notion of modularity and transaction cost economics (Jacobides, 2006).

2.1.7.3 Modularity and organizational boundaries

Similar to the previous group of papers these are predominantly interested in the relationship between product modularity and organizational modularity (Sanchez & Mahoney, 1996; Schilling, 2000; Baldwin & Clark, 2000), however their primary interest is the outsourcing relationships and how the vertical boundaries of firms are shaped by modularity. Based on the distinction between partitioning of knowledge and tasks (Brusoni & Prencipe, 2001; Takeishi, 2002) a number of the papers explore the challenges associated with the outsourcing of components and component development tasks through the use of case studies. Several of the papers in this group empirically test the relationships between modularity and vertical disintegration. While some find evidence supporting the claim that modular product architecture lead to modular organizations (Argyres & Bigelow, 2010) others present empirical evidence which contrasts with previous assumptions within the literature on modularity (Brusoni, 2005; Zirpoli & Becker, 2011; Miozzo & Grimshaw). On the contrary they find firms experience a number of problems requiring explicit attention and coordination in contexts such as knowledge intensive business services (Miozzo & Grimshaw, 2005) and engineering and design tasks (Zirpoli & Becker, 2011).

In a theoretical framework Chesbrough and Prencipe (2008) attempt to capture the evolutionary dynamics of technological modularity claiming that modularity is an appropriate response to certain stage of development in the life cycles of technologies rather than being an end stage in the continuous refinement of technological architecture. Based on examination of the literature on innovation networks and modularity they thus suggest that technology follows a dynamic cycle from a pre modular phase in which the technology is not fully understood through a transition phase to the modular phase in which the innovation network changes focus from exploration to exploitation. Finally in a post modular stage firms

attempt to break the technological limits reached in the modular architecture through integration rather than modularity (Chesbrough & Prencipe, 2008). Their framework thus challenges the perceived view that modularity is final stage in the refinement of architectures, but rather an intermediate step in a continuously changing cycle in which an important challenge for firms is to match their innovation network with the stage of the technological development.

In an empirical study of the early us automotive industry (Argyres & Bigelow (2010) investigate the extent of vertical disintegration during the period 1920-31 in which a dominant design was established. Based on data on the choice of production of nine major car components for each car model years they establish a vertical integration measure and through regression analysis identify a modularity effect as the level of vertical integration decreases significantly after the emergence of a dominant design. Furthermore by using car price and engine performance (horsepower) as measures of differentiation by automotive producers they find evidence for a differentiation effect in which differentiated car models tend to be more vertically integrated than lower price/small engine models. They thus find evidence for the transaction cost based argument that increasing standardizations from product modularity lowers transaction costs by reducing asset specificity and the risk of information leaking and therefore lead to higher use of market based transactions (Argyres & Bigelow, 2010). In a similar study but using historical data on both the semiconductor industry and the electronic systems industry in the US, Funk (2008) trace the effect of innovations at the component (semiconductors) level on the system level (electronic systems). He shows how technological discontinuities in semiconductors have resulted in architectural innovations in the electronic systems industry as component improvements have enabled the recombination of standard components in the architecture of electronic systems and simultaneously led to the vertical disintegration of the semiconductor industry from the electronic systems industry. He thus suggests how modular design and the evolution of design rules at one level of a nested industry hierarchy can have profound implications at a higher industry level.

Based on empirical evidence from the UK and Germany, Miozzo and Grimshaw (2005) claim that the idea of modularity as a strategy to stimulate innovation does not appear to hold for outsourcing of knowledge intensive business services. They use case research data on IT outsourcing from four computer services firms and case survey data from thirteen of client organizations and find that *“the sustainability of innovation is brought into question by the intangibility of services, which exacerbated conflicts between the client and supplier organisations”* (Miozzo & Grimshaw, 2005, p. 1434). They suggest that what make it so particularly difficult to separate computer services from operations functions is that IT is inseparable from production technology and therefore difficult to provide through arms-length contracts. Consequently when computer services are separated from operations it requires organizational and knowledge coordination (Miozzo & Grimshaw, 2005). Through an in depth case study of the NPD processes of a European automotive manufacturer and eight of its suppliers Zirpoli and Becker (2011) focused on the decisions and outcomes of outsourcing of engineering and design tasks as well as the organization of product innovation. The company they studied had during the 1990’s chosen a strategy of extreme outsourcing and despite experiencing initial benefits of strategic flexibility they found themselves in a situation in which competencies were eroding. Subsequently the company reversed its outsourcing strategy but realized that they had lost critical systems integration competencies. One of their main findings is that there is an important difference between integration of the physical components of a system and integration of the systems performance. They find that these cannot be decomposed in the same way, as an aspect of performance of the system can be dependent on several systems. Furthermore performance has multiple dimensions making it even more difficult to decompose performance of the automobile. Therefore they find that there are multiple reciprocal interdependencies between the components of the architecture and performance imply that performance trade-offs are of great importance. Managing performance trade-offs however require component specific knowledge and imply a coordination cost especially in the face of outsourcing. This coordination cost is not eliminated by introducing modular product architecture due to the difference between the physical interfaces and product performance.

2.1.7.4 Information technology, governance and organization

These articles all focus on the relation between modularity of information technology and aspects of governance. A common theme is on how information and communication technologies enable outsourcing and offshoring of tasks and processes and how modularity is playing an important role in this development (Tiwana 2008a, 2008b; Grote & Taube, 2007; Tandriverdi et al., 2007). Similarly IT architecture is found to complement IT governance as architecture modularity increase agility and decentralization of IT governance strengthen this (Tiwana & Konsynski, 2010). Modularity, architecture and platforms are thus areas which call for more research attention, especially in relation to the evolution of platforms (Tiwana et al., 2010). Modularity is primarily defined based on Sanchez & Mahoney (1996) And Schilling (2000).

Tiwana (2008a) use the notion of ignorance to capture the degree to which the outsourcing firm while technically competent to perform the specific project lack idiosyncratic knowledge of the business domain. Through a survey of 209 software outsourcing alliances Tiwana analyze the relationship between outsourcee ignorance, inter-firm modularity and project performance and find support for the hypothesis that that increasing inter-firm modularity lowers the need for inter-firm knowledge sharing. The study points to the tradeoff between investing in modularization versus ignorance reduction both of which are costly to undertake. A similar study find that technological modularity can be a substitute for process control in outsourcing alliances but does not decrease the need for output control. The study concludes that “modular product development demands semi modular organizational arrangements where developers can be granted autonomy over the development process but not over outcomes” (Tiwana, 2008b, p. 778). The modularity of the outsourcing object is thus of significant to the outsourcing arrangement and can affect the sourcing decisions. Tandriverdi et al. thus show how the level of modularity directly affects the choice between outsourcing and offshoring of business processes. Through a survey they show that firms with low business process modularity typically turn to low cost offshore providers with high modularization capabilities whereas firms with high business process modularity prefer to use outsourcing through domestic providers with offshore subsidiaries (Tandriverdi et al., 2007).

However Grote and Taube (2007) show through a qualitative study of the investment banking industry that although many aspects of the activities they study are indeed technically modular due to the use of ICT other requirements prevent offshoring decisions. Knowledge is thus still passed over face-to-face from analysts to traders and clients expect interaction with analysts and not just sales persons. This study thus point to of the limitations of modularity in relation to outsourcing.

2.1.7.5 Organizational search and adaption

Recently a stream of literature on modularity has begun to pay significant attention to the challenge of identifying the right number of modules and thus how the architecture should be partitioned. As Ethiraj and Levinthal (2004) point out the question of how many modules designers of architecture should choose is by no means trivial and the choice can have a significant impact on the performance of the system. In order to model this question and examine the consequences on performance this growing subfield within the study of modularity has turned to a complex systems perspective with the notion of organizational search and adaption (Kauffman 1993, Levinthal 1997, Rivkin 2000). Modularity is primarily defined in relation to Simon (1962) and Baldwin and Clark (2000). Organizations and organizational design is in focus with common references to Thompson (1967) and Nelson and Winter (1982). This perspective on modularity explicitly challenges suggested effects of modularity and suggest dilemmas and tradeoffs involved in the notion of modularity such as between speed of search and risk of imitation (Fleming & Sorenson, 2001; Ethiraj et al., 2008) and the risk of ending up in local peaks due to decentralization (Siggelkow & Levinthal, 2003). This perspective on modularity thus challenges the proposition that increased modularity necessarily improve innovation and firm performance. Although illustrations of empirical cases are made this perspective rely primarily on formal modeling through the refinements of NK models of organizational search (Ethiraj & Levinthal, 2004; Ethiraj et al., 2008; Fleming & Sorenson, 2001) and agent based simulations (Siggelkow & Rivkin, 2005; Siggelkow & Levinthal, 2003).

Pil and Cohen thus suggest a theoretical framework highlighting not only the positive effects on exploration but also the negative effect of innovation diffusion resulting from increased

product modularity (Pil & Cohen, 2006). Similarly Fleming and Sorensen offer a contingent view on the effect of modularization on innovation and based on an NK model using empirical patent data and suggest that intermediate levels of modularity are most appropriate to innovation (Fleming & Sorenson, 2001). Gavetti et al. (2005) in their study of decision making by analogy in high dimensional performance landscapes include decomposability of decision variables and investigate its consequences on the benefits of analogy and find that *“for dealing with systems of choices that are inherently non-decomposable or have not yet been decomposed, reasoning by analogy is particularly powerful”* (Gavetti et al., 2005, p. 710).

Siggelkow & Levinthal investigate modularity by analyzing the effects of decentralizing according to an underlying decomposition of the value landscape and show that there are indeed performance benefits to be achieved. However they also demonstrate that the picture changes dramatically if the firm is attempting to the same decentralization in a situation in which the value landscape has randomly distributed interdependencies between decision variables. They find that in this situation a strategy of decentralizing and re-integration outperforms both centralized and decentralized strategies when search is initiated on a random location at the value landscape. Furthermore by introducing environmental disturbance into their model they find that the outcome of the re-integration strategy is dependent on the level of disturbance. They model disturbance by initially locating firms on the peak and change the value landscape so that it requires change in a number of variables to reach the peak again. For high levels of disturbances many variables need to be changed and in this situation re-integration is especially beneficial while with low disturbance a centralized strategy is better. Interestingly they also model the effect of firms decentralizing by deliberately using a ‘wrong’ decomposition of the decision variables and thus create interdependencies between divisions. Again a temporary use of such a mixed solution avoid getting stuck in low performance local peaks while still realizing the benefits of eventually choosing the right decomposition. They conclude that *“firms need to trade off the short-term costs of decentralized exploration and the long-term benefits that can be achieved from coupling initial decentralized exploration with subsequent integration”* (Siggelkow & Levinthal, 2003, p. 662). Ethiraj & Levinthal likewise point to the tradeoffs involved in

determining the level of modularity and interestingly show through an NK simulation model that it is asymmetric cautioning designers against overly modularizing. As they note *“Excessive modularization may blind the designer to potentially important interactions between decision choices and result in dysfunctional perturbations in module- and system-level performance that constrain evolution to inferior designs”*. They further point out that *“Designers engage in acts of creation, but unlike a divine creator, they lack omniscience. Choices of modules are guesses about appropriate decompositions – decompositions that even in reality are only partial (i.e. nearly decomposable). In making these guesses, our analysis suggests that there should be no presumption of a ‘pro-modularity’ bias”* (Ethiraj & Levinthal, 2004, p. 172). This implies that finding the optimal level of modularity is not a trivial task, that modularity should not be considered a panacea and that the specification of standardized interfaces, poses a challenging task. Using an NK model Ethiraj et al. show that nearly modular structures outperform both non modular and modular structures because they simultaneously increase the efficiency of search while impeding imitation and thereby maintaining the performance gains on the long term (Ethiraj et al., 2008).

In a similar model which also assume interdependence between decision variables and a loosely coupled organizational form Ethiraj & Levinthal (2009) extend their investigation include incentive design. Specifically they investigate the incentive problem of pursuing multiple weakly correlated goals and indeed find that this result in lower performance as it *“freezes managerial action when a decision improves one performance goal but undermines one or more other goals”* (Ethiraj & Levinthal, 2009, p. 19). They suggest three alternative solutions; myopic selection of just one goal, spatial (assigning only few goals to each unit) or temporal (rotating goals) differentiation through simulation show that these do in fact improve performance when compared with the multiple goals scenario (Ethiraj & Levinthal, 2009). In a similar NK model Brusoni et al. (2007) study the consequences of varying degrees of modularization and find long term performance deterioration from over modularization. However in contrast to Ethiraj & Levinthal (2004) they identify a short term benefit and conclude by pointing to the trade-off between speed of search and breadth of search. Modular search strategies offer speed of search but risk sticking to local optima whereas integral

search strategies avoid this at the risk of being overtaken by modular search strategies in a selective environment (Brusoni et al., 2007).

Although various studies have used NK models to highlight different aspects of decomposition of decision making different conclusions appear as to the efficacy of modularity which may be due to application of different search strategies (Geisendorf, 2010). The notion of modularity challenge the assumptions of the NK model itself in particular the randomness of the interdependencies between decision variables which is treated as exogenous. As Brusoni et al. note this is a simplification as *“In reality, on the contrary, firms often make a deliberate effort to reduce the amount of interdependencies in the product development problem”* Brusoni et al., 2007, p. 131). Modularity is in essence a counteracting force to the ‘complexity catastrophe’ (Caminati, 2006). As noted by Caminati: *“Selection for modularity implies that the most effective design rules will be those able to counteract the increasing dimension of the knowledge space through the increasing decomposition thereof, to the effect that R&D will be able to exploit the principles of division of labour”* (Caminati, 2006, p. 226). Thus for management interdependencies of decision variables is not just a given but can be altered into decomposability, however subject to the changes to the knowledge space caused radical inventions which *“imply a deconstruction and reconstruction of a knowledge interaction matrix of a more global kind”* (Caminati, 2006, p. 226).

2.1.7.6 A modularity theory of the firm

In recent years efforts have been made to establish a modularity theory of the firm which attempt to include technological innovation and the structure of architectures as an important determinant of the boundaries of the firm. These papers draw on transaction cost economics with primary reference to the work of Williamson (1985) and Coase (1937), and are extensions of the work of Langlois and Robertson (1992) who suggest a theoretical framework for explaining industry development and hence vertical integration and disintegration through integrating transaction cost economic principles with a competence based view of the firm. They argue, that transaction costs are short run phenomena that are reduced over time as firms develop institutional structures that impede transaction costs *“Whether there is continuity, merger, or disintegration is a function of the cost structure at*

that time, which in turn depends on the existing distribution of capabilities and the degree of efficiency of markets” (Langlois & Robertson, 1995, p. 45). Langlois and Robertson points to benefits from modularity being relevant not only to producers but also to consumers: “*The benefits of modularity appear on the producer’s side as well as on the consumer’s side. A modular system is open to innovation of certain kinds in a way that a closed system – an appliance – is not. Thus a decentralized network based on modularity can have advantages in innovation to the extent that it involves the trying out of many alternate approaches simultaneously, leading to rapid trial-and-error learning.*” (Langlois & Robertson, 1995, p. 75). And further on the environment in which modular systems can accelerate innovation: “*This kind of innovation is especially when technology is changing rapidly and there is a high degree of both technological and market uncertainty*”. Organizations that prefer market transaction can in effect modularize activities in order to achieve what Baldwin refers to as ‘thin crossing points’ between modules, where transaction costs are lower Baldwin (2008). Vertically integrated organizations are thus a non-modular reply to the need for interaction between elements in which the alternative is modularity and market interaction (Langlois, 2002). The TCE perspective however has traditionally not sought to explain the origin of transactions or as Baldwin point out, theories on transactions “*almost never ask why the opportunity to have a transaction occurs where it does. As a result, the forces driving the location of transactions in a system of production remain largely unexplored*” (Baldwin, 2008, p. 156). For this change of explanation, Baldwin claims that it is necessary to include a focus on what she labels mundane transaction costs as “*Transactions are designed to match their locations. In a given location, the objects being transacted must be defined and counted (or otherwise measured), and the purchaser must compensate the supplier. Thus, work goes into making the transaction. I call the costs of this work mundane transaction costs to distinguish them from the opportunistic transaction costs that are the focus of analysis by Williamson*” (Baldwin, 2008, p. 156). This has major implications for the analysis of transactions, as expenditures on the mundane transaction costs according to Baldwin can offset the negative transaction costs of opportunism.

Furthermore, as Baldwin point out, transactions are not given a priori but are themselves amendable to change. Specifically the process of modularization affects the thickness of

crossing points and hence the location of transactions. This all imply the importance of introducing the notion of change into the analysis of transactions: *“These new module boundaries provide points of entry for competitors and breakpoints, where vertically integrated firms and industries may split apart. Therefore, transaction locations are not technologically determined, but arise through the interplay of firms’ strategies and knowledge and the requirements of specific technologies. Strategies, knowledge, and technologies all change over time, hence the location of transactions changes as well”* (Baldwin, 2008, p. 156). Likewise Argyres and Bigelow (2010) based on their study of the consequences of technological development in the early US automotive industry on vertical integration, point to the need to endogenize transactions. As they note *“there may be natural patterns of technological evolution—especially as new technologies emerge from firms’ innovation choices—that systematically impact the characteristics of firms’ transactions, and in turn cause temporal patterns in vertical integration behavior. Increasing modularity may be one example of this kind of technological evolution, but there may be others as well”* (Argyres & Bigelow, 2010, p. 851).

Langlois pose similar concerns in relation to treatment of the origin and nature of transactions and transaction costs within ‘mainstream economics of organization’⁹. *“Where exactly do the [institutional] alternatives come from? More subtly: what exactly are these things called ‘transactions’, and where do they come from?”* (Langlois, 2006, p. 1394). In conclusion Langlois claim that: *“The perspective from modularity I advocate here has the benefit of returning our focus to the **process** of organizational change”* (Langlois, 2006, p. 1405, emphasis in original). Thus examining the process of modularization appears to be one way to introduce a notion of dynamism into the study of the evolution and location of transactions. In so doing they seek to extend the traditional transaction cost economic explanation of the boundary of the firm by including technologic change and the role of innovation.

⁹ A category on which Langlois notes: “in which for present purposes I would include even Williamson — takes task boundaries (technologically separable interfaces) for granted and focuses, often single mindedly, on the issue of asset ownership. In many of these theories, indeed, it is the ownership of non-human assets that defines the firm and sets its boundaries (Hart 1989)”.

Table 3 Groupings identified within the literature on modularity

| Grouping | Description | Articles |
|--|---|---|
| Product architectures designed for flexibility and substitutability | These are all related to the strategic benefits of achieving flexibility through the design of product architectures for substitution. Modularity is defined with primary reference to the work of Langlois & Robertson (1992), Simon (1962), Garud & Kumaraswamy (1993) and Sanchez & Mahoney (1996). | Sanchez (1999), Sanchez (2000), Sanchez & Mahoney (1996), Sanchez (2008), O'Grady & Liang (1998), Garud & Kumaraswamy (1996), Mikkola & Gassmann (2003), Garud & Kumaraswamy (1995), Sanchez (1995), Tseng & Huang (2008) |
| Modular product architecture and technological innovation | Discuss modularity with reference to the technology management literature (Tushman & Anderson, 1986; Clark, 1985; Christensen & Rosenbloom, 1995) Define modularity with reference to (Henderson & Clark, 1990; Sanchez & Mahoney, 1996; Ulrich, 1995; Baldwin & Clark, 1997). | Buganza & Verganti (2006), Verganti & Buganza (2005), Jones (2003), MacCormack & Iansiti (2009) Chen & Liu (2005), Murrman & Frenken (2006), Cebron et al. (2008), Gatignon et al. (2002), Galvin & Rice (2008), Stephan et al. (2008) |
| Product architecture, frameworks and definitions | Primary definition of modularity from Ulrich (1995). Major references to Pahl (1996), Ulrich (1995), Meyer (1996), Fisher (1999) and Pine (1993) | Liu et al. (2010), Thevenot et al. (2007), Fixson (2007), Zwerink et al. (2007), Kong et al. (2009), Nepal et al. (2005), Salvador (2007), Yassine & Wissmann (2007), Du et al. (2001), Mikkola (2006), Ben Mahmoud-Jouini & Lenfle (2010), Blecker & Abdelkafi (2007) |
| Modular architecture and mass customization | These articles give major attention to mass customization and architectures. Common references to Pine (1995) and Feilziger & Lee (1997). Modularity is primarily defined with reference to Baldwin & Clark (1997), Ulrich (1995), Schilling (2000) and Starr (1965). | Tu et al. (2004), Salvador et al. (2004), Fredriksson & Gadde (2005), Mikkola (2007), Kumar (2004), Jacobs et al. (2011), Duray et al. (2000), Lin et al. (2009), Salvador et al. (2002), Jacobs et al. (2007), de Blok et al. (2010), Ro et al. (2007), Pero et al. (2010), Fredriksson (2006), Yoss & Hsuain (2009), Mikkola (2003) |
| Component commonality | | Huang et al. (2007), Zhang & Huang (2010), Huang et al. (2005), Zhang et al. (2008), Danese & Romano (2004) |
| Empirical surveys of the relationship between modularity and performance | Defining modularity with primary reference to Sanchez & Mahoney (1996), Ulrich (1995), Sanchez (1995) and Schilling (2000) and key articles from JOM such as Durey et al. (2000) and Salvador et al. (2002) these articles all empirically test the effects of modularity on supply chain integration and performance. | Antonio et al. (2009), Antonio et al. (2007), Lau, Yam & Tang (2010), Lau et al. (2010), Danese & Filippini (2010), Howard & Squire (2007), Squire et al. (2009) |
| Modularity and product development processes | These articles are on modularity in relation to product development. The group primarily defines modularity with reference to Alexander (1964) and based on Eppinger (1994) and Baldwin & Clark (2000) and employs the DSM method. Major references include references to product development (Ulrich 1995, Thomke 1997, Brown & Eisenhardt 1995), Concurrent engineering (Terwiesch et al. 2002) and engineering design projects (Mihm et al. 2003, Smith & Eppinger 1997) | Sosa et al. (2004), Browning (2001), Loch et al. (2003), Fixson (2005), Huberman & Wilkinson (2010) Loch et al. (2001), MacCormack et al. (2006), Staudenmayer et al. (2005), Gokpinar et al. (2010) |
| Capabilities and absorptive capacity | | Lei (2000), Lei (2003), Lei et al. (1996), Kusunoki et al. (1998), Arkan (2009), Grunwald & Kieser (2007), Malhotra et al. (2005), Lombardi (2003) |
| Loosely coupled organizational forms and dynamic capabilities | Based on resource based theory of the firm i.e. Penrose (1959), Henderson & Clark (1990), Chandler (1962), Teece (1986), Barney (1991), Wernerfelt (1984) and dynamic capabilities Leonard Barton (1992), Teece et al. 1997, Eisenhart & Martin (2000) | Karim (2006), Martin & Eisenhardt (2004), Helfat & Eisenhardt (2004), Schilling & Steensma (2001) Schilling (2000), Robertson & Verona (2006) Jacobides (2006), Parmigiani & Mitchell (2009) |
| Modularity and organizational boundaries | Group of papers that are predominantly interested in modularity in relation to organizational architecture. However the unit of analysis is | Frigant (2007), Brusoni (2005), Chesbrough & Prencipe (2008), Gentry & Elms (2009), Campagnolo & Camuffo (2009), Miozzo & Grimshaw (2005), Brusoni & Prencipe (2006), |

| Grouping | Description | Articles |
|---|--|--|
| | generally the industry as opposed to the individual firm. | Campagnolo & Camuffo (2010), Zipoli & Becker (2011), Fixson & Park (2008), Funk (2008), Argyres & Bigelow (2010), Wang (2008), Gomes & Dahab (2010), Jacobides & Billinger (2006) Susarla et al. (2010), Jaspers & van den Ende (2010), Garud & Mumir (2008), Ulku & Schmidt (2011), Ceci & Masciarelli (2010), Schmickl & Kieser (2008) |
| Information technology, governance and organization | These articles all focus on the relation between modularity of information technology and governance structure. A common theme is on how IT is enabling outsourcing and offshoring of tasks and processes and how modularity is playing an important role in this development. Modularity is primarily defined based on Sanchez & Mahoney (1996) And Schilling (2000). | Tiwana (2008a), Tiwana & Konsynski (2010), Bush et al. (2010), Tiwana (2008b), Tanriverdi et al. (2007), Grote & Taube (2007), Tiwana et al. (2010), Eom (2008) |
| Organizational search and adaption | These articles are on modularity in relation to organizational search and adaption based on the perspective of complex adaptive systems (Kauffman 1993, Levinthal 1997, Rivkin 2000). Modularity is primarily defined in relation to Simon (1962) and Baldwin & Clark (2000). Organizations and organizational design is in focus with common references to Thompson (1967) and Nelson & Winter (1982). Formal modeling is employed through NK models of organizational search or agent based simulations. | Siggelkow & Rivkin (2005), Siggelkow & Levinthal (2003), Gavetti et al. (2005), Ethiraj & Levinthal, D (2004), Ethiraj & Levinthal (2009), Ethiraj & Levinthal (2004), Sinha & Van de Ven (2005) Yavavaram & Ahuja (2008), Ethiraj et al. (2008) Geisendorf (2010), Fleming & Sorenson (2001a) Canniati (2006), Pi & Cohen (2006) |
| Modularity theory of the firm | Drawing on Williamson (1985), Coase (1937), Langlois & Robertson (1992), Henderson & Clark (1992), Simon (1962) and Chandler (1977) | Langlois (2006), Langlois (2002), Langlois & Garzarelli (2008), Baldwin (2008), Press & Gelpel (2010), Helper & Sako (2010), Christensen et al. (2002) |

Source: Based on bibliographic data from literature search on modularity

* Articles with factor loadings below 0,25 are suppressed

2.1.8 Development of the field of modularity

As discussed above the literature on modularity has grown significantly and as discussed above a number of different approaches to the study of modularity have emerged. From being primarily related to the strategic benefits of product modularity, the literature has increasingly turned attention to other aspects of modularity including organizations, information technology, manufacturing capabilities and innovation.

Figure 5 show four snapshots of the literature on modularity and indicate that the growth of the literature has increased significantly within recent years. The growth in the literature seems to be caused by growing awareness of the concept of modularity and its relevance within different areas of research.

Figure 5 Development of the literature on modularity (1995 – 2010)

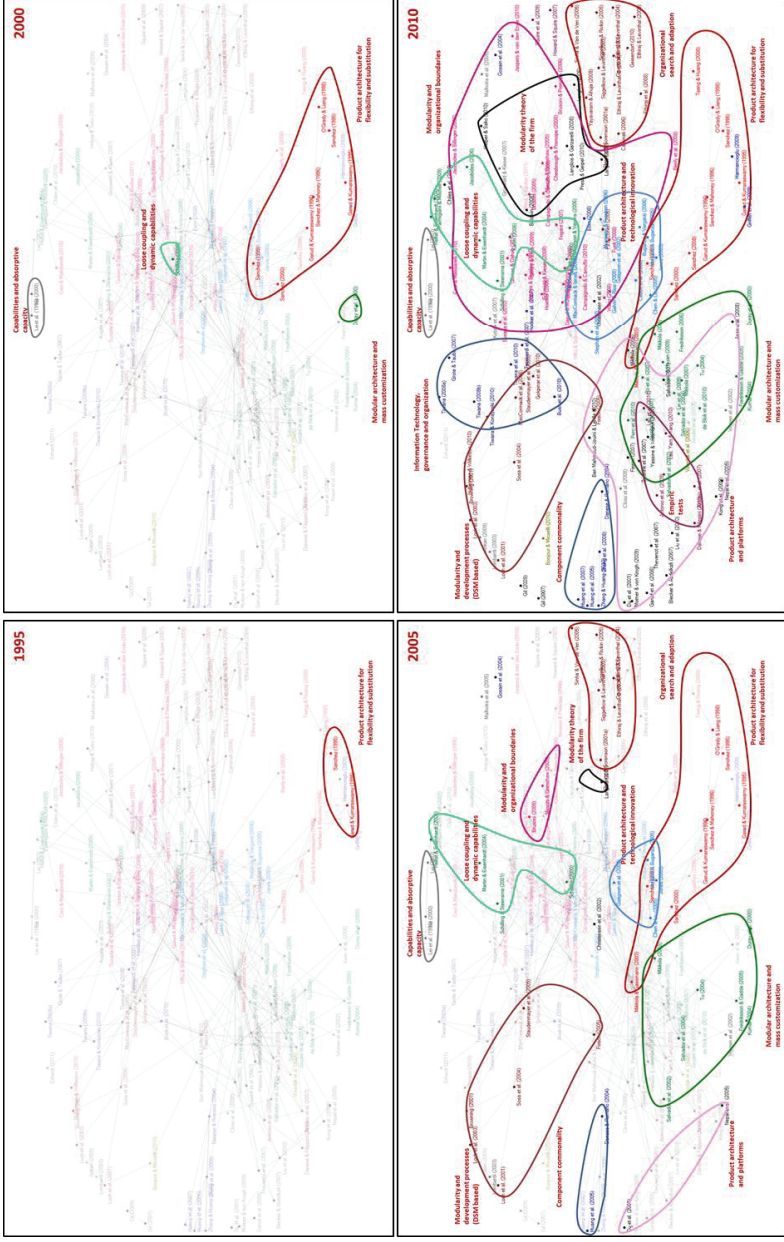

Source: Network graphs based on bibliographic data from literature search on modularity

The use of modularity as a key concept in different areas have resulted in the development of individual groupings within the literature which touches upon different aspects of modularity and focuses on different consequences of modularity. From being perceived primarily in terms of product architecture with strategic relevance modularity is currently being studied in relation to operational capabilities and production strategies, innovation processes, organizational structure and industry evolution.

Furthermore the literature has developed from primarily consisting of theoretical frameworks and propositions to empirical investigations using various research methods. A number of studies have thus attempted to empirically test proposed relationships while others have sought to understand modularization at the level of individual firms and their inter-organizational relationships.

2.1.9 The intellectual structure of the literature on modularity

As indicated in the above discussion the literature on modularity has developed into a number of distinct groupings studying various aspects of modularity. Although there is general consensus on the importance of the concept of modularity the different groupings have emphasized different aspects of modularity and have used different perspectives in their analysis of its consequences. In order to identify these perspectives and to visualize the intellectual structure of the literature on modularity a co-citation analysis was conducted based on the dataset presented above.

The citations of the literature on modularity were used to identify the extent to which individual references were frequently co-cited with other references as indicated by figure 2. References which were frequently cited together by articles on modularity identified in the literature search could thus indicate proximity of ideas suggesting that they belong to the same intellectual perspective. Based on the transposed adjacency matrix Pearson correlation coefficients were calculated to estimate co-occurrence similarly to the calculation of the bibliographic coupling metric. In order to visualize the resulting matrix of co-occurrence the network graph in figure 6 was drawn based on the normalized correlation coefficients. Lines between references indicate that they have frequently occurred in the reference list of the

same citing articles with line thickness representing higher frequencies as measured by the Pearson correlation coefficient. In order to identify groupings within the patterns of citation of the articles on modularity a factor analysis was performed using the raw co citation data. The factor analysis was conducted using the same settings as described in section 2.1.2.5 and scree plot with eigenvalues of extracted components can be found in appendix 4.

Figure 6 Network visualization of the intellectual structure behind the literature on modularity in relation to management

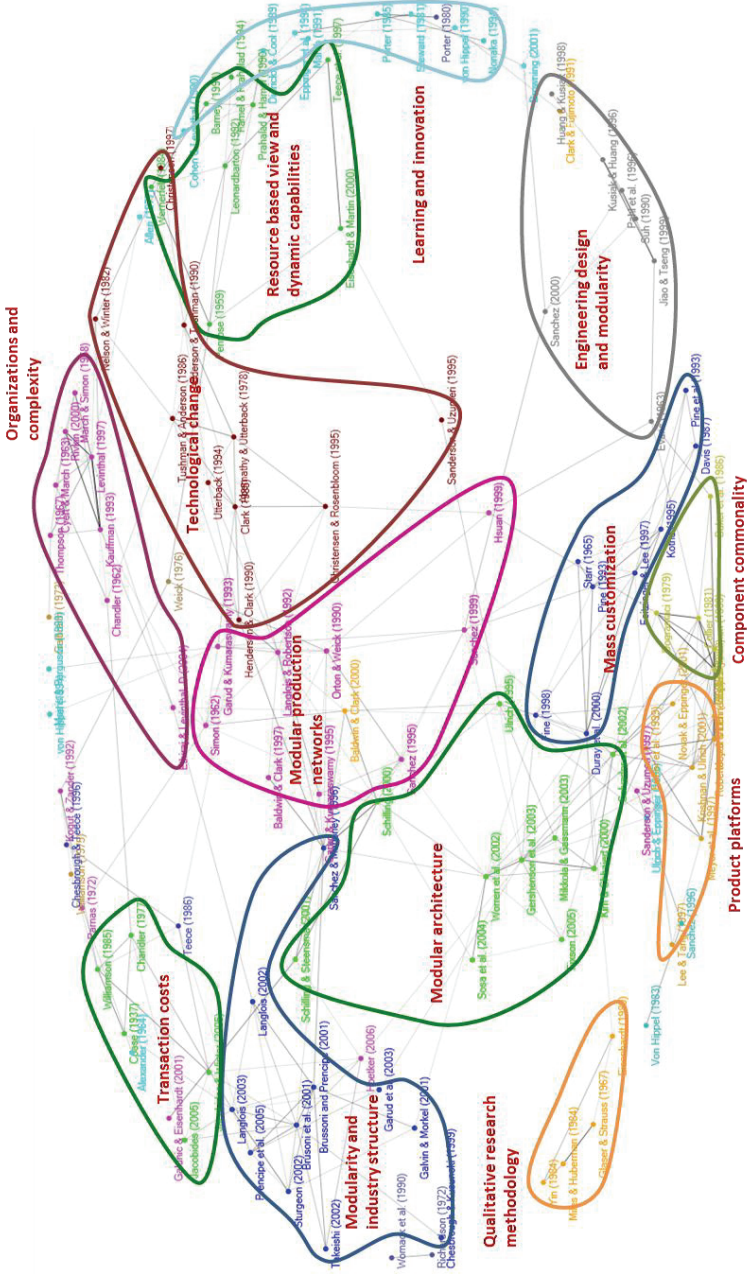

Source: Network graph based on co-citations from articles on modularity

Figure 6 show how an undirected network graph based on the co-citations from articles within the literature on modularity. Groups identified in the factor analysis are circled with headings based on the examination of the individual references. The groupings reveal that the dominant theoretical perspectives on which the modularity literature draw are the transaction costs (Williamson, 1985; Coase, 1937; Jacobides & Winter, 2005), the resource based view (Penrose, 1959; Barney 1991; Wernerfelt, 1984), dynamic capabilities (Eisenhardt & Martin, 2000; Teece et al., 1997; Leonard-Barton, 1992), organization studies (Thompson, 1967; March & Simon, 1958; Chandler 1962; Levinthal, 1997) and technological change (Christensen & Rosenbloom, 1995; Tushman & Anderson, 1986; Henderson & Clark, 1990; Nelson & Winter, 1982).

2.1.10 Findings from the literature review on modularity

There has traditionally been a focus on modularity in relation to products but there is growing attention to the organizational aspects of modularity. Furthermore, although only relatively few studies have been on modularity in services (29) and processes (42) or both (8) there is a growing attention to the study of modularity in service contexts. Section 2.3 elaborates further on this literature. However as discussed above much of the literature on modularity have studied modularity from a structural perspective, in order to analyze the effects of modularity by comparing modular and non-modular alternatives. At the industry level there has been a growing attention to the longitudinal effects of changes to i.e. product architecture on industry structure. This links to the organizational economic literature and the notion of coordination as modularity is argued to provide an implicit coordination thus enabling market transactions.

Figure 7 Propositions identified in the literature on modularity

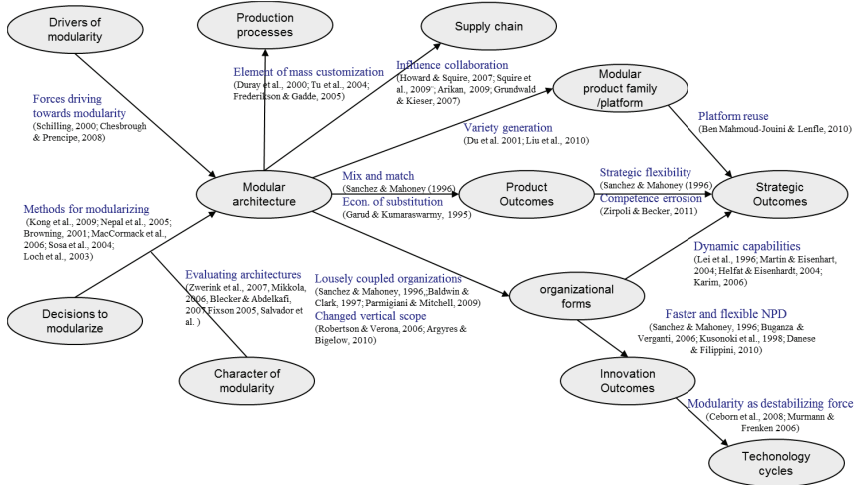

Source: Identified through literature review on modularity

Traditionally the literature on modularity has pointed to the link between product architecture and organizational architecture suggesting that modular products lead to modular organizations (Sanchez & Mahoney, 1996) in which distributed design teams provide flexibility in the development of new products. However recent empirical studies have shown that this is not necessarily the case (Brusoni & Prencipe, 2001, Brusoni et al., 2007; Brusoni & Prencipe, 2006; Miozzo & Grimshaw, 2005; Zirpoli & Becker, 2011) as product and organizational architecture follow different dynamics. To the context of service modularity this is intriguing as the design of service delivery systems are closely linked to the design of organizations. Service provision thus involves not only technical resources but involves socio-technical capabilities. To understand the emergence of service modularity and the consequences of such structure of service provision it would thus seem to be necessary to include organizational perspectives which are attentive to the social aspects of service provision.

However not much of the literature attends to emergent properties of modularization. Only few studies (Garud et al., 2008; Türtscher, 2008) study the process of modularization and how modularity is constructed in a socio-technical domain. Instead modularity is treated from a technical perspective with the ability to decompose frequently being an assumption rather than the object of study. It is thus assumed that interdependencies can be anticipated in advance, and that a modular architecture can therefore be designed. If interfaces cannot be fully specified in advance and the design rules of the architecture are subsequently found to be imperfect, this challenges the embedded coordination assumed which is often expected to be a consequence of modular architectures. Instead it raises the question of how management deals with situations in which they expect or experience problematic interfaces to occur. This intriguing question has not received much attention in the literature on modularity but based on empirical observations appear to be important to answer in order to understand the role of modularity in the context of services.

In their important paper on the economies of substitution, Garud and Kumaraswamy (1995) clearly identify some of the complexities of designing for reuse. Within the firm they point to the tension between competition and cooperation when different projects compete for scarce resources in an environment where reuse of components is sought. One of the tensions is between the intention to design for future usability and current performance as project members may have an incentive to pursue solutions which realize the highest performance of their particular project design at the expense of designing components with a potential for application in different contexts or exerting the efforts needed to identify and incorporate existing components into their designs. As they point out:

“Within the firm, for instance, competition for a limited pool of resources between individuals creates incentives for increasing current performance even at the expense of future performance. Contributions to current performance provide instant recognition and rewards, whereas contributions to future performance (through the design of reusable components) may yield little recognition or rewards. Moreover, creators of reusable components may have to face an additional burden when problems arise with their reusable component.... Clearly, cooperation is required to create and reuse such components. Firms need to balance the

ension between cooperation and competition by instituting appropriate systems, structures, and incentives to encourage the creation of reusable components” (Garud & Kumaraswamy, 1995, p. 104, emphasis added)

They thus clearly point to the important role systems, structures and incentives, play in the creation of reusable components. However, although the literature on modularity has grown significantly as evident from section 2.1.8, only sparse attention has been paid to investigating this further. Instead much of the literature on modularity tends to assume that the architecture itself provides the means to achieve the needed cooperation through embedding coordination within standardized interfaces. However as Garud and Kumaraswamy clearly indicate, institutional arrangements, controls and incentives may be crucial elements in making the architecture work and actually achieving reusability and economies of substitution. Moreover recent empirical studies particularly in the domain of services have indicated that the assumption of a priori identification of interdependencies and specification of interfaces provides significant challenges to managers and designers. Anticipation of interdependencies is frequently imperfect and important interdependencies often only reveal themselves late in the process of design (Staudenmayer et al., 2005; Zirpoli & Becker, 2011; Miozzo & Grimshaw, 2005; Türtscher, 2008). Staudenmayer et al. (2005), thus suggest how interdependencies can have an emergent nature when it is beyond the capabilities of the individuals to conceive them in advance. They suggest that we should pay attention to the relative importance of ex ante identification of interdependencies and the ex post management of these as they pop up unexpectedly. Through their case studies they show how management indeed did pay significant attention to managing unexpected interdependencies. Zirpoli & Becker (2011) distinguish between the product architecture and its performance, arguing that a decomposed product architecture in which physical interfaces between components and subsystems are standardized does not necessarily imply a similarly decomposability in performance. They thus caution against unquestioned outsourcing of component development activities as a consequence of modular product architecture, as this can erode the competencies needed for system integration and thus undermine the innovative capabilities of the firm.

While the literature suggests that modularity in principle provides a powerful vehicle for managing complexity and adapting to uncertainty the realization of modularization in practice also seem to present a complex design challenge which produces uncertainties of its own. From the management accounting literature we know that managers construct and use control devices to align interests and provide coordination (Malmi & Brown, 2008; Merchant & Van de Stede, 2007; Ferreira & Otley, 2009). Such practices are not only utilized in stable environments but also in the face of complexity and uncertainty such as in new product development (Davila et al., 2009; Davila, 2000; Abernethy & Brownell, 1997). It is curious that the literature on modularity only sparsely touches upon how mechanisms of control and coordination relate to modularization as it might be expected that such an exploration would provide a more dynamic account of the management of modularity. While the knowledge of management control has grown within the management accounting literature (Malmi & Brown, 2008; Chenhall, 2003; Merchant & Van der Stede, 2007; Ferreira & Otley, 2009) only very few studies related the investigation of modularity to management accounting and control practices.

Thyssen et al. suggested how Activity Based Costing might provide a way to evaluate the cost effect of modularization through the use of accounting calculations. However they caution that the R&D cost of developing common modules are difficult to allocate appropriately in an ABC calculation due to its nature as an investment. Furthermore they point to the cost relationship between different products and product families utilizing common modules imply that the costs for sustaining such common modules will be placed high in the cost hierarchy, and hence difficult to allocate to the individual product line (Thyssen et al., 2006). Israelsen & Jørgensen (2011) extend the use of ABC in the costing of modular products to the context of new product development. They show how cost allocation in project accounting practices are detrimental to modularization efforts if they do not take into account how the development and use of common modules contribute to the profit of individual projects. Consequently they suggest a method for allocating development cost of common modules to ensure that the decision to use of common modules by the individual project is aligned with portfolio level performance.

Extending the study to include other aspects of management control Jørgensen & Messner (2010) based on an in depth case study of NPD projects show how accounting and strategizing impacted each other in a transition from integral to modular product architectures. Using a practice theory lens they demonstrate how a range of different management control devices were used in the process of translating a strategic imperative for modularity into actual decisions regarding components and modules at the project level. Their study reveals how accounting calculations although unable to create a unified version of the results of modularization were enacted to add to the evaluations taking place in the practicing of strategy. Furthermore they reveal how a number of other control mechanisms were essential elements of practice in the process of attempting to create modularization of the products, to avoid the practices to ‘drifting’ as they point out: “This case shows that even in the absence of a strong reliance on accounting numbers, a “drifting” of practices (Quattrone & Hopper, 2001) can be avoided because other forms of accountability are mobilized to ensure a coordination of NPD practices. In our case, control assumed the form of horizontal information sharing, guided by strategic objectives and a general understanding of the need to be profitable” Jørgensen & Messner (2010, p. 202). This indirect effect of accounting and management control significantly adds to our understanding of the process of modularization in the face of uncertainties of interrelationships and outcomes of decisions at the project level. The findings of Jørgensen and Messner seem to echo the importance suggested by Garud and Kumaraswamy (1995, p. 104) of “*instituting appropriate systems, structures, and incentives*” in attempts to design for reusability but importantly it brings to the forefront the suggestion that understanding how managers mobilize elements of management accounting and control in their practices of managing is important to gain a dynamic understanding of modularity as part of management practice. Within the area of service modularity such a dynamic account seem no less relevant due to the difficulties of specifying interdependencies and the intangible nature of interfaces. Curiously however research providing such an account seem to be perhaps even less prevalent in the area of services.

The next section will provide a discussion of service engineering and the management of services. The intention of this section is to provide the basis for discussing modularity of service processes in section 2.3.

2.2 Managing service operations

The aim of this section is to provide an introduction to the challenges of managing services. This section will draw on literature from service operations management and the growing field of service engineering and service science. Although management of service operations has been on the academic agenda for several decades (Chase 1978, Sasser et al. 1978) it is increasingly being recognized as an important field of inquiry of researchers in operations management (Roth and Menor 2003, Apte et al. 2008). This is not least due to the fact that the service industries are growing in relative importance within western economies (OECD, 2010). Services industries are recognized as increasingly important within the global economy and service companies have been subject to intensified academic investigation.

While the statistical evidence suggests a growing importance of services relative to agriculture and manufacturing, Castells point to the profound changes to society which are taking place as a consequence of advances in information and communication technology. In his treatment of the consequences of these changes on work and organizations he points out how they are resulting in the fragmentation and individualization of elements of work. *“The new social and economic organization which is based on information technology, aims to decentralize management, individualize work and tailor the markets and thereby segmenting work and fragmenting societies. The new information technologies simultaneously offer the possibility of decentralizing tasks and coordinating them in an interactive communication network in real time, whether it's from continent to continent or from floor to floor in the same building”* (Castels, 2010, p. 282, emphasis in original).

Castells views on the network society thus points to some of the opportunities suggested by new information technologies as well as the associated managerial challenges for service organizations. Technologies offer new possibilities but at the same time require managerial competences to design and manage such a decentralized network of tasks. Such competencies could potentially be of value to service companies engaged in designing process architectures

In a report to the European Union addressing the challenges of globalization Richard Baldwin points to a similar fragmentation in what he denotes ‘the great unbundling(s)’. Baldwin thus

point to the change from an old paradigm of the first unbundling in which competition took place between factories trading in goods and services, to a new paradigm in which “*the forces of globalization will achieve a far finer resolution; it predicts that international competition will increasingly play itself out at the level of tasks within firms*” (Baldwin, 2006, p. 28).

Figure 8 Schematic representation of the two great unbundlings

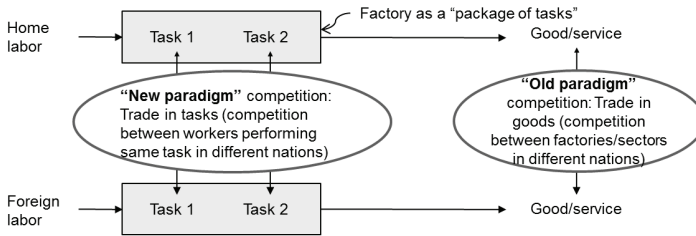

Source: Adapted from Baldwin, 2006, p. 25

This change in paradigm has implications for the conceptualization of competitiveness on a societal level, but it also challenges the architectural capabilities of firms and their ability to design service processes that possess desired levels of modularity.

Within operations management the importance of services organizations has been recognized and the traditional context of manufacturing has been broadened to include service operations management (Hill et al., 2002; Chase & Apte, 2007). In this regard it has been debated whether and to what extent concepts and methodologies originating from product contexts can meaningfully be applied to services. Some authors have pointed to the many similarities between products and services with regard to operations arguing for high applicability (Arbos, 2002) whereas others have pointed to critical differences highlighting the effect of context on service operations management characteristics. As part of this interest there has been an academic debate on arriving at an accepted and comprehensive definition of services and the identification of managerial implications following from this together with classification schemes to capture types of service configurations and their appropriateness.

2.2.1 Defining services

Services are frequently defined on the basis of what they are not rather than what they are, as the label service has been used as a residual category in industry classifications to capture anything which that is not agriculture or manufacturing. Such a distinction is increasingly invalidated and fails to capture the essential aspects of services. Within the marketing and operations management literature other attempts at defining services have traditionally focused on identifying characteristic features of services. Schmenner points to five characteristics which are shared by many services are their intangibility, the inability to keep services on inventory, that service production and consumption occur physically together, that there is an easy entry and that they are affected by outside influences such as deregulation (Schmenner, 1995). Fitzsimmons and Fitzsimmons (2008) notes that the distinction between goods and services is blurred as most goods are accompanied by facilitating services such as installation and deferred payment and that many services include facilitating goods such as the food enjoyed at a restaurant. However they point out that for services inputs can either be the customer or their information, while resources are employees, capital and the facilitating goods. This implies that a distinctive characteristic of services is the participation of the customer in the process which presents managers with the challenge of designing facilities with the customer in mind. Furthermore this aspect of services induces much variety into the service process.

Throughout the literature particular attention has been on the intangibility, heterogeneity, inseparability and perishability of services (Lovelock & Gummesson 2004); however the ability of these to capture the essence of services has recently been challenged (Sampson & Frohle, 2006; Lovelock & Gummesson, 2004; Vargo & Lusch, 2004; Gadrey, 2002; Hill, 1999). In characterizing the economic distinction between goods and services Hill points out that it is not intangible or immaterial features which gives services their defining character. Instead he suggests that a key distinction is related to the ability to establish ownership rights: *“because it is not an entity, it is not possible to establish ownership rights over a service and hence to transfer ownership from one economic unit to another. In contrast to goods, therefore, services cannot be traded independently of their production and consumption”*

(Hill, 1999, p. 442). Following from this Hill reaches the following definition of a service which acknowledges that service is something provided by one agent to the benefit of another as *“it is some change in the condition of one economic unit produced by the activity of another unit”* (Hill, 1999, p. 441)

Johnston and Clark present a more customer focused definition of services as *“the combination of outcomes and experiences delivered to and received by a customer”* (Johnston & Clark, 2008, p. 10). This definition captures the distinction in ‘the change of condition’ between outcome and experience which they show to have important operational implications. It is the combination that constitutes the service product/package and the difficulty of separating outcome and experience provides a particular challenge for service managers. It is usually possible to distinguish the good from the experience of using the good, while this is frequently not possible with services. Experiences are thus commonly more heterogeneous and are based on the individual’s perception of the service provided which can be profoundly difficult for service managers to capture and manage.

In a critical examination of the characteristics often attributed to services Gadrey claim that neither of them captures the essential aspects of services. The output of many non-manufacturing activities do result in tangible and material changes to the matter being transformed whether the matter is an individual undergoing healthcare treatment or a repaired vehicle (Gadrey, 2000). Likewise immaterial goods exist in the form of *originals*¹⁰, such as the case of literature, music and films which through the use of media can be used subsequent to their production. With regard to the non-storable and non-transportable nature of service Gadrey point out that again the output of the service act is frequently as much storable and transportable as is the case in manufacturing, while the acts of production themselves however are not storable or transportable. However as this is the case in services as well as in manufacturing, storability and transportability is not an appropriate criterion for defining services: *“The outcome of one hundred (successful) heart transplants is made up of an observable ‘stock’ of one hundred individuals with transplanted hearts or, if we prefer, a*

¹⁰ As Hill describes *“An original is the archetypal immaterial good. It is a **good** because it is an **entity** over which ownership rights can be established and which is of economic value to its owner. It is also **intangible** because it has no physical dimensions or co-ordinates in space”* (Hill, 1999, 440, emphasis in original)

lasting change of state in those individuals' 'health capital'. Manufacturing firms do not store acts of labour either, only their ultimate effects on the processed material. It is not clear why this analytical principle should not be applied to services” (Gadrey, 2000, p. 374).

Based on Hill's definition Gadrey thus suggest a new definition of services which take into account the existence of three different demand rationales: *“Any purchase of services by an economic agent B (whether an individual or organization) would, therefore, be the purchase from organization A of the right to use, generally for a specified period, a technical or human capacity owned or controlled by A in order to produce useful effects on agent B or on goods C owned by agent B or for which he or she is responsible” (Gadrey, 2000, p. 383).* With this definition of services Gadrey claim to capture three distinct service logics. Firstly the logic of assistance involves the request by the customer of intervention by the service provider to assist in serving the customer. The second logic involves the provision of technical capacities by the service provider to the disposal of the customer while the third logic is that of live performances.

2.2.2 The challenges of designing and managing service operations

The difficulties of defining services precisely within the literature notwithstanding a number of managerial challenges frequently face service organizations. As noted by Morris and Johnston (1987), the customer within the process creating an inherent variability not present in manufacturing processes in which the customer only receives the output from the process. This characteristic can take the form of customer presence where it is essentially the customer being processed to situations in which it is information that is being processed. Sampson and Frohle (2006) argue that customer input into the delivery process is the defining characteristic of services and that this has major managerial implications. An important facet of the nature of service is thus the simultaneous production and consumption, implying reduced opportunities to manage variability through inventories. Consequently the service delivery process plays a fundamental role in new service development as the implied variability must either be reduced or accommodated by the service process design.

As pointed out by Buzacott (2000) “*The service design problem is to develop a system that enables customer’s demand to be met in an effective way*” (Buzacott 2000, p. 17). As he points out, it follows from this that service managers are facing the design of complex production systems which are capable of handling the variability facing the system. Although there are arguable many characteristics specific to service it seems that the challenge of variability and heterogeneity is no less in the context of services. Quite to the contrary the requirements for developing system structures which can accommodate variability and heterogeneity caused by customer inputs (Sampson and Frohle 2006) and customer presence within the service production process (Morris and Johnston 1987) suggest presenting crucial challenges to service process designers. The combination of higher variety in customer demand and reduced opportunities for using inventories imply that the management of capacity and demand is often essential in service companies (Sampson & Frohle, 2006).

Normann points out that at the core of the service economy is “*the coordination and timing of complex activities between different entities*” (Normann, 1991, p. 26). Aligning the numerous entities in time and space to meet the requirements of the individual customer thus present management with a massive coordination challenge. This is reinforced by services often being susceptible to positive and negative circles of effects which can undermine the quality of the service provision (Normann, 1991). Recent research shows that for a number of reasons service systems are very susceptible to variations and can exhibit major amplifying behavior (Akkermans & Vos, 2003) and result in quality erosion (Oliva & Stermann, 2001). Anderson et al. (2005) point to the importance of understanding the dynamics of service supply chains and furthermore caution against hasty transfer of conventional operations management wisdom from manufacturing to service contexts.

2.2.3 Classification of services

Within the literature on service management various classification schemes have been proposed to distinguish and conceptualize service systems according to their characteristics (Silvestro et al., 1992). Such classifications have enabled the comparison of different service systems as well as analysis of the appropriateness of designs of service delivery systems. Similarly the challenge of new service development has recently received much attention

(Droege et al., 2009; Meyer and DeTore, 2001). Developing and managing services and service delivery processes pose challenges for management identifying appropriate structural compositions to handle the service process demand.

From an operational perspective Lovelock and Wright (1999) categorize service processes by distinguishing between tangible or intangible service acts and whether the object being transformed is people or possessions. This classification involves fundamentally different kinds of processes and thus requirements for the process design. This thesis is concerned with the development of modularity in service process design within the financial services, and specifically in the context of information processing. Information and Communication Technology (ITC) thus plays a large role in the development of business process architecture, as a major service quality parameter is the correct handling of individual pieces of information. However technology can play different roles in the service encounter ranging from technology free to technology generated (Fitzsimmons and Fitzsimmons, 2008). In the specific case, the service encounter is mainly technology-mediated and major efforts are made to increase the opportunities for self service through technology-generated service encounters.

2.2.4 Performance criteria of service operations

A crucial aspect of the operations management literature is the existence of a multitude of different performance criteria along which the organization can perform. The incongruence between multiple performance criteria however suggest that trade-offs need to be made between performance criteria. Within operations management Slack et al. (2010) suggest five performance criteria towards which management should orient their efforts. Quality, speed, dependability, flexibility and cost are thus suggested to be import criteria on which to decide how well the organization should perform to align operations and strategic objectives.

Modularity is crucially linked to the criteria of flexibility, however various definitions of flexibility can be found in the management literature. Slack and Lewis explore flexibility as one among five generic performance objectives and in so doing explicate the meaning of each of these objectives. They note that flexibility has two meanings, on the one hand referring to

the ability of something to be bent between possible states and on the other hand the ease with which the move from one state to the other can be accomplished. These two characteristics are defined as range and response flexibility and they further point to four distinct types of operations flexibility (Slack and Lewis, 2008).

Table 4 Typology of flexibility

| Total operations flexibility | Range flexibility | Response flexibility |
|---|--|---|
| Product/service flexibility: The ability to introduce and produce novel products or services or to modify existing ones | The range of products and services which the company has the design, purchasing and operations capability to produce | The time necessary to develop or modify the products or services and processes which produce them to the point where regular production can start |
| Mix flexibility: The ability to change the variety of products or services being produced by the operation within a given time period | The range of products and services which the company produces within a given time period | The time necessary to adjust the mix of products and services being produced |
| Volume flexibility: The ability to change the level of the operations aggregated output | The absolute level of aggregated output which the company can achieve for a given product or service mix | The time taken to change the aggregated level of output |
| Delivery flexibility: The ability to change planned or assumed delivery dates | The extent to which delivery dates can be brought forward | The time taken to reorganize the operation so as to re-plan for the new delivery date |

Source: (Slack and Lewis, 2008)

According to Upton “flexibility is the ability to change or react with little penalty in time, effort, cost or performance” (Upton, 1994) reflecting the multifarious nature of the notion of flexibility. His definition captures the distinction between range and time understood as the scope of variability and the responsiveness of that variability. Furthermore his definition captures the dual sides of flexibility of reaction to environmental requirement for adaption as opposed to proactive change instituting adaption of the environment.

As indicated above variety is a critical element of services where both the heterogeneity of customer requirements and the simultaneity of production and consumption imply a need for service providers to respond flexibly. Within healthcare services Jack and Powers (2004) have considered a range of strategies to address volume flexibility and suggest a framework depending on demand uncertainty and range of flexibility.

As suggested by Arbos (2002) an important element in achieving flexibility is the use of personnel which are able to perform various processes and are able to be re-assigned based on the current tact time of the service system. In a similarly effort Sheu et al. (2003) model the effect of service process design on customer waiting time and find that flexibility can be gained by utilizing different process designs depending on the current demand for service. Much of the literature on modularity has focused on the ability to create heterogeneity in the products and services while maintain simplicity in operations processes. However it would seem that the challenge of variety of demand in service processes would suggest modularity as an important element in creating the necessary flexibility to match capacity and demand in services.

2.2.5 Service Process Architecture

The word 'Process' originates from the Latin word 'processus' meaning advance or progress. Central to the understanding of processes are hence the transformation from one state to another in a way that advances the object being transformed. However processes can be viewed in several ways and consequently leading to different definitions. The service process architecture discussed in this paper refers to a conceptualization similar to what Garvin (1998) terms 'work processes', thus defining processes as "the transformation of inputs into outputs through some sequencing of activities". According to Smart et al. (2009, p. 495) "a process architecture is constructed as a means for understanding the organization from a business process perspective." Much has been written about the management of business processes, which by some is considered as just another management concept not worthy of serious attention. However they contend that, "processes are not simply the management fad of reengineering, but a more pervasive issue, requiring serious attention." According to Batista et al. (2008), "The architecture of process actually refers to the processes that together form the organizational activity and the dynamic relationships between those processes". This view of processes allows for mapping the elements of the architecture and thus conceptualizing the service process architecture at various levels of granularity and the application of principles from systems theory (Batista et al. 2008, p. 540).

One consequence of these characteristics of service as well as the fact that services systems are open systems is that service processes are often not long sequences of standardized activities, but rather mobilizations of processes in service encounters (Lilrank 2010). Lilrank thus suggest that service processes can be understood as events in which process steps are instantiated as episodes in the encounter with the customer.

Figure 9 Service processes as events

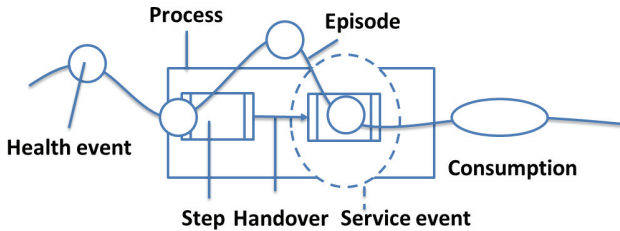

Source: Lilrank (2010, p. 354)

With service processes as events the ability to connect episodes and transfer the correct information and material from episode to episode become crucial. This puts emphasis on the interfaces between episodes within the process and as such highlight that achieving modularity through standardization of these interfaces would seem be critically important. However the fact that episodes can be connected in multiple ways depending on the individual customer highlight the difficulties of achieving such standardization. Lilrank thus points to the fact that some service processes are best understood as mobilizations in service events rather than pre-specified sequences of process.

In a similar vein Callon et al. (2002) elaborate on the mobilization of what they denote a socio-technical capacity which “*consist in human competencies and material devices that have been designed and arranged in a way in which they can be mobilized in order to achieve desired results*” this mobilization is tightly linked to the nature of services as “*Service provision consists in the effects produced by the mobilization and reasoned use of this socio-technical capacity*” (Callon et al., 2002, p. 208-9)

Rather than seeing service provision as a purely technical matter “*service provision, by allowing consumers to use this socio-technical capacity, organizes a system of action in which consumers participate personally in order to benefit from that use. In the course of the interaction thus constructed, they become elements in this system of action. They act, react and, most importantly, interact, thus gradually constructing and clarifying their preferences*” (Callon et al., 2002, p. 209). It is this interaction that enables and places greater importance on the role of qualification of services as “*What is important in the service business is the relationship or, rather, system of relationships which, on a material and collective basis, organizes the qualification of products*” (Callon et al., 2002, p. 210).

Within manufacturing modularity of production processes and product design has been suggested as a way to attenuate the tradeoff between variety in demand and operational performance (Starr, 1965, Salvador et al. 2005). Modularity should thus be investigated rigorously by service management academics in order to extend our knowledge on how the nature of services affects the application of principles of modularity. This is of major relevance to the literature as well as service management practitioners. One important question is whether and how typologies and methodologies originating in product contexts can be applied in service contexts. Voss and Hsuan (2009) discuss and illustrate how services can be conceptualized through the notion of architectures originating in the literature on product architecture and modularity. Chapter 5 of this thesis empirically investigates service modularity function in the context of service processes to measure the structural composition of service process architectures.

Developments in information and communication technology has allowed for the design of increasingly more modular structures (Sahaym, Steensma & Schilling 2007). Modularity in process and information infrastructures thus potentially allow for fast and inexpensive recombination of process modules which would be necessary to benefit from designing multiple instances of the same process.

2.3 Modularity of services and processes

From screening of the articles identified through the literature search 29 articles were identified which were relating their discussion of modularity to services. Of these 6 were conceptual and building theories or frameworks while 19 were empirical using primarily case research methods and to a lesser extent surveys and statistical modeling. Finally 3 articles are reviews of which one touches upon services (Fixson, 2007) while two are explicitly concerned with services and to some extent modularity (Spring & Araujo, 2009; Chen & Hao, 2010). Industry-wise there is a predominant focus on modularity in relation to outsourcing of computer services (Upton & McAfee, 2000; Miozzo & Grimshaw, 2005; Lehrer & Behnam, 2009; Burzagli et al., 2009; Weiss & Gangadharan, 2010; Tiwana, 2008a, 2008b; Susarla et al., 2010) while other services are present as well including finance (Grote & Taube, 2007; Buganza & Verganti, 2006), health care (de Blok et al., 2010), contract research (Konnola et al., 2009) and logistics (Moore et al., 1996). Table 5 shows an overview of these articles including their research type and method as well as industry context.

In a case study Rai et al. (2010) show how two companies transitioned to a modular Enterprise architecture. Likewise Pan et al. (2007) use case research to conceptualize how modularity of organizational routines can be achieved during the capability development process and is linked to the development of dynamic capabilities. Burzagli et al. (2009) Explores how a modular platform makes it possible to build services of various types. Susarla et al. (2010) conduct a case study of large Taiwan call center and inductively develop a process model of modularization. Through the use of survey data from software-as-a-service (SaaS) contracts they study the relationship between modularity of SaaS and multi-task agency problems caused by lack of verifiability of tasks between the provider and client organization. They find that the multi-task problem is present when the service provided is complex business analytics suggesting using low powered incentives. However they also find that introducing modularity of the interfaces reduces the multi-task problem and allow the use of higher powered incentives (Susarla et al. 2010).

Tiwana (2008b) develops and tests the assertion that technological modularity reduces the need for alliance control and finds that modularity and control are imperfect substitutes as

modularity lowers the influence of process control but not of outcome control on alliance performance. Through a case study Lehrer & Behnam (2009) traces the development of the SAP R/2 and R3 ERP suites to identify how SAP addressed the standardization-adaption dilemma to develop a product in which modularity was introduced to handle the growing complexity from programmability of the product. Based on a case study conducted in a contract research organization Könnölä et al. (2009) present a framework for classifying foresight activities. Based on their study they find that modularity of foresight methods helps the company to tailor the processes to the conditions of the individual project. In a conceptual paper based on industry cases from open source software Langlois & Garzarelli (2008) propose that the understanding of the economic organization of open source collaboration can benefit from the principles of the modularity theory of the firm. They suggest that open source collaboration is a hybrid form of organization with an intellectual division of labor where effort is undertaken on a voluntary basis.

Table 5 Articles on modularity of services identified through the literature search

| Article | Type | Method | Industry | Title |
|------------------------------|-------------|------------------|------------------|--|
| Yuan & Lu (2009) | Conceptual | Framework | No specific | An value-centric event driven model and architecture: A case study of adaptive complement of SOA for distributed care service delivery |
| Spring & Sweeting (2002) | Conceptual | Theory building | No specific | Empowering customers: portals, supply networks and assemblers |
| Yoo et al. (2010) | Conceptual | Theory building | No specific | The New Organizing Logic of Digital Innovation: An Agenda for Information Systems Research |
| Moore et al. (1996) | Conceptual* | Framework | Logistics | An architecture for logistics re-planning |
| Langlois & Garzarelli (2008) | Conceptual* | Theory building | No specific | OHackers and Haidressers: Modularity and the Organizational Economics of Open-source Collaboration |
| Voss & Hsuan (2009) | Conceptual* | Theory building | Multiple service | Service Architecture and Modularity* |
| Zack (1996) | Empirical | Case research | Media | Electronic publishing: A product architecture perspective |
| Baldwin & Clark (1997) | Empirical | Case research | Multiple | Managing in an age of modularity |
| Zahorian (2000) | Empirical | Case research | Education | A modular approach to using computer technology for education and training |
| Upton & McAfee (2000) | Empirical | Case research | Comp. Services | A path-based approach to information technology in manufacturing |
| Miozzo & Grimshaw (2005) | Empirical | Case research | Comp. Services | Modularity and innovation in knowledge-intensive business services: IT outsourcing in Germany and the UK |
| Pan et al. (2007) | Empirical | Case research | Call centers | The dynamics of implementing and managing modularity of organizational routines during capability development: Insights from a process model |
| Grote & Taube (2007) | Empirical | Case research | Finance | When outsourcing is not an option: International relocation of investment bank research - Or isn't it? |
| Konnola et al. (2009) | Empirical | Case research | Contract res. | Management of foresight portfolio: analysis of modular foresight projects at contract research organisation |
| Lehrer & Behnam (2009) | Empirical | Case research | Comp. Services | Modularity vs programmability in design of international products: Beyond the standardization-adaptation tradeoff? |
| de Blok et al. (2010) | Empirical | Case research | Health care | Modular care and service packages for independently living elderly |
| Rai et al. (2010) | Empirical | Case research | Multiple | Transitioning to a modular enterprise architecture: Drivers, constraints, and actions |
| Burzagli et al. (2009) | Empirical | Framework | Comp. Services | Design for All in action: An example of analysis and implementation |
| Buganza & Verganti (2006) | Empirical | Multiple | Finance | Life-cycle flexibility: How to measure and improve the innovative capability in turbulent environments |
| Weiss & Gangadharan (2010) | Empirical | Network analysis | Comp. Services | Modeling the mashup ecosystem: structure and growth |
| Tiwana (2008b) | Empirical | Statistic model | Comp. Services | Does technological modularity substitute for control? A study of alliance performance in software outsourcing |
| Tiwana (2008a) | Empirical | Statistic model | Comp. Services | Does interfirm modularity complement ignorance? A field study of software outsourcing alliances |

| Article | Type | Method | Industry | Title |
|-------------------------|-------------|-------------------|------------------|---|
| Gentry & Elms (2009) | Empirical | Statistic model | Electronics | Firm Partial Modularity and Performance in the Electronic Manufacturing Services Industry |
| Miller & Olleros (2008) | Empirical | Survey | Multiple service | To manage innovation learn the architecture |
| Susarla et al. (2010) | Empirical | Survey | Comp. Services | Multitask Agency, Modular Architecture, and Task Disaggregation in SaaS |
| Fixson (2007) | Review | Systematic review | No specific | Modularity and commonality research: past developments and future opportunities |
| Spring & Araujo (2009) | Review | Systematic review | No specific | Service, services and products: rethinking operations strategy |
| Chen & Hao (2010) | Review | Systematic review | No specific | Mass customization in design of service delivery system: A review and prospects |

Source: Based on literature search on modularity

*with illustrative case

2.3.1 Service Oriented Architecture

Within information systems development the notion of Service Oriented Architecture has received attention from academics and practitioners and has been suggested as a paradigm for creating flexible information system architectures (Demirkan et al. 2008). Tiwana & Konsynski (2010) use survey data to empirically test the relationship between IT architecture modularity, IT governance and IT agility and how they influence IT alignment. They claim that increasing modularity increases IT alignment through increased IT agility. Interestingly they find that to achieve agility at a higher level of the architecture requires the enforcement of standardization at lower levels through modularity, which implies less autonomy for line functions over IT decisions.

The reuse of software components is a question which have been on the research agenda for many years (Krueger 1992) since its introduction by McIlroy (1968). However recently the developments of standardized interfaces such as web services the attention toward software reuse have grown and are increasingly enabling the reuse of externally developed information system artifacts within organizations (von Krogh & Haefliger, 2011). Weiss and Gangadharan (2010) thus use publically available data on which they conduct network analysis to study the development of mashup applications from the modularity of open application programming interfaces (APIs).

The OASIS group describes Service Oriented Architecture this way: “SOA is a means of organizing solutions that promotes reuse, growth and interoperability. It is not itself a solution to domain problems but rather an organizing and delivery paradigm that enables one to get more value from use both of capabilities which are locally “owned” and those under the control of others. It also enables one to express solutions in a way that makes it easier to modify or evolve the identified solution or to try alternate solutions” (OASIS, 2006)¹¹. The OASIS definition of Service Oriented Architecture clearly indicates that it is closely related to the principles of modularity. The focus on interoperability is in line with the standardization of interfaces to allow modules to easily connect to arrive at new configurations. Furthermore

¹¹ <http://docs.oasis-open.org/soa-rm/v1.0/soa-rm.pdf>

the intention to reuse is as discussed in chapter 2 among the primary drivers in maintaining efficiency while realizing greater heterogeneity.

Within the service engineering literature the notion of SOA has received growing attention and Cases recently described Service Oriented Architecture in this way “SOA provides a loose coupling of interoperable IT services that enable applications to exchange data in the execution of business processes. It is based on older concepts of modularity and distributed computing” (Cases et al., 2010, p. 111). Cases explicitly link service oriented architecture with modularity, what is new is that ICT is increasingly enabling this to take place through new developments in technology. The expansion of the internet and the development of standardized communication protocols such as XML allow “SOA separates functions into components of services, which are made accessible over a network so that they can be combined and reused in the production of business applications” (Cases et al., 2010, p. 112). While technology clearly plays a role in this, such an ability to combine and reuse must have massive business implications for the opportunities of service companies.

2.3.2 Service interfaces

As discussed in chapter 2.1 interface standardization forms an essential part of a modular architecture, as it is through the definition of standardized interfaces loose coupling of components is achieved. However in defining modularity in relation to services the characteristics of interfaces turn out to be essential as their conceptualization is different from physical products. Merriam Webster defines interfaces broadly as “*a surface forming a common boundary of two bodies, spaces, or phases*”. While the interfaces between components in physical products are often visible and material, in services this is not necessarily the case. Instead they can take on various forms such as the interpersonal encounters between customer and employee, the use of self service facilities, and the flow of information between customers, employees and systems. Interfaces in the context of services are thus a multifaceted element which adds to the complexity of service design. Furthermore in designing service systems it can be difficult to anticipate and specify all potential interfaces in advance due to the heterogeneity of customers and the difficulty in predicting their behaviors.

When considering encounters occurring in services are thus subject to behavioral considerations and the fact that the service encounter occurs in a triad between the service organization, customer and contact personnel as depicted in figure 9.

Figure 10 The service encounter triad

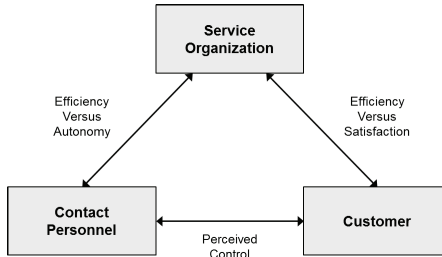

Source: Adapted from Cook et al. 2002, p. 160

The figure points to some of the tradeoffs present in the different interfaces in the service encounter such as the tradeoff between efficiency and satisfaction in the interface between the service organization and the customer as well as between efficiency and autonomy between the organization and its personnel. Finally the interpersonal encounter between contact personnel and customer involves deciding on how much control each of these should have on the encounter. The fact that interfaces in services involves encounters between humans complicates the standardization involved as the behavior is less predictable thus making it more difficult to specify the interfaces in advance.

2.4 Chapter summary

This chapter has introduced the domain literature to which the thesis seek to contribute. The literature on modularity has grown significantly during the past two decades and its focus has been extended from predominantly product focused to including manufacturing and service processes as well as organization and industries. This can be seen in the light of the growing interest in management and engineering of services due to the growing importance of services to Western economies. Service industries experience a transition to more fragmented task distribution enabled by technologies such as service oriented architecture and open source

software. These are clearly related to modularity which makes it particularly interesting to investigate in the context of services. However the nature of services as open systems with inherent variety call for caution regarding the extent that conventional wisdom from product architecture can be uncritically applied. Particularly the assumption that interfaces can be specified a priori as well as the question of how management can respond when this is not the case raises interest. This is an area with only scarce research.

Chapter 3 Theory development

As described in chapter 2 Modularity has been studied in a number of different ways applying different theoretical perspectives. This chapter will present modularity as an economic phenomenon which is tightly linked to central questions within organizational economic perspectives of the firm. The intention is to establish a conceptualization of coordination which will show to be central in the empirical study of modularity. Secondly the chapter will introduce a practice lens for studying modularity of service processes. As described in chapter 2 the development of services frequently present the challenge of designing socio-technical capabilities in ongoing organizational processes. However as shown in chapter 2 much of the literature on modularity tend to treat it from a technical point of view with little attention to how the technology is developed in the recurring practice of situated actors.

3.1 Economics of modularity

Within economic theory Ronald Coase raised a fundamental question in his seminal article “The nature of the firm” in asking “...if production is regulated by price movements, production could be carried out without any organisation at all, well might we ask, why is there any organisation at all?” (Coase, 1937, p. 388). Essentially he questioned established assumptions of neoclassic economics and its predominant emphasis on the ability of price mechanisms to provide coordination by asking why in the presence of such price mechanisms there are firms? From this fundamental question the branch of economics labeled transaction cost economics has since pursued this question in the quest to identify the factors influencing whether a given transaction is carried out on a market or within a firm (Coase, 1960; Williamson, 1979).

From this perspective the role of management is fundamentally involved in defining the boundaries of the firm through establishing governance structures which economize on transaction costs since as Williamson argue “economizing is more fundamental than strategizing – or, put differently, that economy is the best strategy” (Williamson, 1996, p. 308). Following Williamson economizing ultimately implies to “align transactions, which differ in their attributes, with governance structures, which differ in their costs and competencies, in a discriminating (mainly, transaction cost economizing) way” (Williamson, 1996, p. 311). It follows from this that according to Williamson a fundamental role of management is to identify the governance structure which based on the characteristics of the transaction reduces the cost of transacting. In relation to the management of processes this relates to designing efficient structures for governing the process ranging from vertical integration within the firm on the one hand and outsourcing to a market transaction on the other. Management must thus decide which elements of the process that should be performed within the boundaries of the firm, and which could economically be located outside the boundaries of the firm. The attributes according to which the transaction should be aligned with governance structure primarily reflect the degree of asset specificity, the frequency and the uncertainty of the transaction (Williamson, 1985). In particular asset specificity is given prominence as explanatory factor within the theory, and arises when investments are made

specific to an individual transaction. This reduces its alternative uses and hence causes its value to be dependent on a bilateral relationship between transacting partners (Williamson, 1985; Williamson, 1975). In combination with the assumption of bounded rationality and the risk of opportunistic behavior, asset specificity implies the risk of ex post contractual hazards and hence transaction costs.

Extending Williamsons notion of transaction attributes Milgrom & Roberts describe how transactions can be connected in important ways. They thus claim that most companies are not engaging in just one kind of transactions using one kind of asset, but rather engage in a multiplicity of transactions. Consequently the connectedness of transactions defined as “the expected loss incurred from failing to coordinate a particular group of decisions” can thus in certain circumstances be more important to manage than merely aligning governance structures to the individual transaction. Connectedness of transactions is further related to the concept of complementarity, which is central to understanding the relationship between individual design parameters. In some situations design can effectively be the choice between sets of complementary design parameters. Complementarity between design parameters is hence important to consider in the choice of strategy and structure (Milgrom & Roberts, 1992; Foss, 2005). Non convexity in the profit function can thus result in the choice between design parameters essentially being a choice between sets of complementary parameters in which it is risky to choose a combination in between (Milgrom & Roberts, 1990). As example Milgrom & Roberts suggest how it can have a negative impact on profitability to invest in flexible manufacturing technologies while simultaneously maintaining a narrow product line emphasizing mass production (Milgrom & Roberts, 1995).

As described above, it is the connection between modular elements that defines modular structures. Transaction cost economics can hence contribute to understanding the consequences of the loose coupling of modular elements for management and control and the requirements to information for decision making (Roberts, 2007). In addition the difficulties of measurement of performance of different modules can have consequences for the division of work between agents and the possible incentive structures (Holmstrom & Milgrom, 1991). These issues furthermore relate to concepts such as uncertainty, complexity, measurability

and frequency which also will constitute a point of reference in the analysis of process modularity (Milgrom & Roberts, 1992).

The analysis of how the characteristics of transactions affect the execution and governance of transactions can be used to understand a number of central problems in relation to processes and modularity (Langlois, 2006). Through an understanding of how the elements of design affect the cost of the individual transaction the theory is thus capable of enlightening a number of economic problems. This question is important in relation to modularity as the lower cost of transaction between modules is among the most significant arguments for modularity as a design concept (Baldwin, 2008; Langlois, 2006). Furthermore the theory can illuminate a number of problems regarding the organizations of transactions in organizations, i.e. how the choice of design parameters for the specific process affects intra- and inter-organizational issues of governance (Milgrom & Roberts, 1992).

In relation to process modularity the traditional view of the TCE perspective thus suggest several implications for the role of management. Firstly designing and managing processes involve deciding on the governance structure that best align with the characteristics of the transactions taking place in the process. Essentially this involves deciding which parts of the process to locate within the organization and which to outsource. However the use of modularity as a design principle has profound implications on the attributes of the transactions themselves. Standardizing the interfaces between modules thus arguably reduces their interdependencies which could potentially affect asset specificity since engaging in transactions in which the product or service produced must conform to standard formats both reduce the cost of customization and the risk of relation specific lock-in. The TCE perspective however has traditionally not sought to explain the origin of transactions or as Baldwin point out, theories on transactions *“almost never ask why the opportunity to have a transaction occurs where it does. As a result, the forces driving the location of transactions in a system of production remain largely unexplored”* (Baldwin, 2008, p. 156). For this change of explanation, Baldwin claims that it is necessary to include a focus on what she labels mundane transaction costs as *“Transactions are designed to match their locations. In a given location, the objects being transacted must be defined and counted (or otherwise measured),*

and the purchaser must compensate the supplier. Thus, work goes into making the transaction. I call the costs of this work mundane transaction costs to distinguish them from the opportunistic transaction costs that are the focus of analysis by Williamson” (Baldwin, 2008, p. 156). This has major implications for the analysis of transactions, as expenditures on the mundane transaction costs can offset the negative transaction costs of opportunism (Baldwin, 2008).

Furthermore, as Baldwin point out, transactions are not given a priori but are themselves amendable to change. Specifically the process of modularization affects the thickness of crossing points and hence the location of transactions. This all imply the importance of introducing the notion of change into the analysis of transactions: “*These new module boundaries provide points of entry for competitors and breakpoints, where vertically integrated firms and industries may split apart. Therefore, transaction locations are not technologically determined, but arise through the interplay of firms’ strategies and knowledge and the requirements of specific technologies. Strategies, knowledge, and technologies all change over time, hence the location of transactions changes as well*” (Baldwin, 2008, p. 156).

Langlois pose similar concerns in relation to treatment of the origin and nature of transactions and transaction costs within ‘mainstream economics of organization’¹². “*Where exactly do the [institutional] alternatives come from? More subtly: what exactly are these things called ‘transactions’, and where do they come from?*” (Langlois, 2006, p. 1394). In conclusion Langlois claim that: “*The perspective from modularity I advocate here has the benefit of returning our focus to the **process** of organizational change*” (Langlois, 2006, p. 1405, emphasis in original). Thus examining the process of modularization appears to be one way to introduce a notion of dynamism into the study of the evolution and location of transactions.

¹² A category on which Langlois notes: “in which for present purposes I would include even Williamson — takes task boundaries (technologically separable interfaces) for granted and focuses, often singlemindedly, on the issue of asset ownership. In many of these theories, indeed, it is the ownership of non-human assets that defines the firm and sets its boundaries (Hart 1989)”.

Importantly Jacobides and Winter (2005, p. 396) further point to the “*complementary roles of transactional and capability considerations in the micro-analysis of firm decisions*“ in which transaction costs are considered as endogenous to firm decisions to shape their transactional environment and not as in traditional transaction cost economics assumed to be given a priori. In the following this complementary strand of literature is discussed in order to point to the importance of modularization in relation to the shaping of firm resources and thus transactional capabilities.

In contrast to transaction cost economics the focus of the competence/resource based perspective is on the internal resources of the firm and how these resources contribute to the creation of sustained competitive advantages (Barney, 1991; Wernerfelt, 1984). A fundamental assumption of the competence based perspective is thus that resources are heterogeneously distributed across firms and that these resources are not perfectly mobile. In other words, all firms do not have access to the same resource base and are thus not capable of freely acquiring the resources they may desire.

Within recent years the competence based perspective has been developed and several authors suggest that it is increasingly important for firms to develop capabilities to change their resource base (Teece et al., 1997; Augier & Teece, 2008; Teece, 2007; Eisenhardt & Martin, 2000; Helfat, 2007). Teece et al (1997) describe these competences as dynamic capabilities and this refinement to the resource and competence based perspective seem to be central in relation to understanding process modularity and what enable and limit firms abilities to actually use complex design principles such as process modularity in the change of the processes of the firm.

To achieve sustained competitive advantage Teece argues that companies need to build dynamic capabilities which “*can be harnessed to continuously create, extend, upgrade, protect, and keep relevant the enterprise’s unique asset base*” (Teece, 2007). The dynamic capabilities framework thus point to central elements in value creation being that of sensing and seizing opportunities and to adapt accordingly and thus “*the fundamental question for management is to figure out how best to employ the firm’s existing assets, and how to reconfigure and augment those assets and tie them together in a viable business model to help*

augment the value proposition being brought to customers” (Augier & Teece, 2008, p. 1197). As defined above business processes appear to be a central element among the assets of the firm and understanding the value of process design competences can thus benefit from the insights on dynamic capabilities.

Augier and Teece note *“The emergence of new products and processes results from new combinations of knowledge and that processes of organizational and strategic renewal are essential for the long-term survival of the business firm. Enterprises must also match the exploration of new opportunities with the exploitation of existing ones”* (Augier & Teece, 2008, p. 1196). Thus the strategic flexibility resulting from modular products and related organizational forms (Sanchez & Mahoney, 1996) may be closely linked to the creation of dynamic capabilities (Pan et al., 2007). Extending the argument from modular products and development processes to the business processes through which the enterprise produces its products and services may thus be one element in understanding how enterprises can create structures which are adaptable to opportunities identified.

As indicated above Augier and Teece emphasize that the manager plays a distinct role within the dynamic capabilities framework specifically *“in sensing opportunity, in making investment choices, in orchestrating non-tradable assets into combinations that yield economies of scope, and in bringing about continuous organizational renewal”* (Augier & Teece, 2008, p. 1198). As argued above, the design of modular processes could potentially be one element in understanding how to invest in assets that enable such orchestration or non-tradable assets. Furthermore the ability to perform experimentation on a modular level may increase the intensity of such experimentation on modules with high option value of design (Baldwin & Clark, 2000). Thus the inherent features of modular structures could potentially be one way to enable specific dynamic capabilities. Further if modular business processes can be related to organizational structure and enabling loosely coupled organization form this may suggest that it could be a way to facilitate the creation of ambidexterity in organizational design. Modular business processes could thus potentially be one element in resolving the tradeoff between exploitation and exploration (O’Reilly & Tushman, 2008).

3.2 A Modularity theory of the firm

As indicated above the notion of modularity point to a shortcoming in the traditional TCE argument with its lack of attention to technological change and its effect on transaction capabilities. As noted in chapter 2 a stream of literature has taken this as a starting point in the development of a modularity theory of the firm. They are thus arguing for a reintroduction of the importance of technological change to the study of economic organization and the boundaries of the firm. In this modularity appears to play a significant role as it addresses the question of how and where the technologically separable interfaces arise which are the basis for establishing where transactions can occur (Langlois, 2006). Following an organizational economic rationale Langlois argues that modularity can be a useful concept in understanding where transactions actually come from *“But where do technologically separable interfaces come from? Why do activities terminate and begin where they do? Some recent literature, which we may lavishly call the modularity theory of the firm seek to answer these questions in a way consistent with the method of comparative institutional analysis”* (Langlois, 2006, p. 1394). The modularity theory of the firm is thus concerned not only with the question of the how a given transaction is governed based on its characteristics, but as importantly how these characteristics come into being. In other words the modularity theory of the firm is interested in answering the question of how a transfer becomes a transaction: *“When it is costly, for whatever reason, for a transfer to become a transaction, the transfer is best left to take place within a module – within the boundaries of an organization – where it need not be standardized, counted and compensated.”* (Langlois, 2006, p. 1397)

In outlining the theory Langlois bases it on theory of modular design and property rights theory. The theory he claims *“will assert that organizations reflect nonmodular structures, that is, structures in which decision rights, rights of alienation, and residual claims to income do not all reside in the same hands. The reasons behind alternative partitions are numerous and complex, however, calling for subtlety in the application of the idea of modularity to the firm”* (Langlois, 2002, p. 20). Based on the notions of Baldwin & Clark, Langlois refers to modularization as including architecture, interfaces and standards. According to Langlois modular systems implies a *“kind of fixed cost that an intertwined system need not pay”* and

consequently is in some circumstances only limited modularity is required (i.e. systems in a slowly changing environment) (Langlois, 2002, p. 23). Langlois thus claim that *“Firms arise as islands of nonmodularity in a sea of modularity. They may do so in response to externalities arising from the likes of team production or asset specificity. More interestingly, firms may also arise in order to **generate** externalities, that is, to facilitate the communication of rich information for purposes of qualitative coordination, innovation and remodularization. Hybrid forms like joint ventures and collaborative arrangements arise for similar reasons”* (Langlois, 2002, p. 35, emphasis in original). This characteristic provides a more dynamic notion of the theory of the firm than what is implied in the traditional TCE perspective by including the generation of innovation by firms which thus causes changes to the sea of modularity. The theory thus adds elements to TCE which as described by Robertson & Verona is necessary in order to understand the consequences of technological change: *“The effects of technological change on new firms and on existing Chandlerian firms cannot be specified without examining a wide range of influences including, inter alia, the market structures for components; the technological vintages of the various components used in a production process; the extent to which economies of scale are present; whether a process may plausibly be modularised; the strength of Williamsonian transaction costs; and firm strategy”* (Robertson & Verona, 2006, p. 91). There are thus profound theoretical insights to be gained from the inclusion of modularity into the organizational economic theory of the firm.

3.3 A practice lens for studying the emergence of architectures

Much of the early literature on product design and in particular the literature on modularity of product architectures attention has been given to the structural properties of the design rather than the question of how the design emerge through decisions of situated actors. As discussed in chapter 2 much of the literature on modularity originates in engineering which is reflected in the perspective on design. In his seminal work on design and architecture titled ‘The Sciences of the Artificial’ Simon (1996) puts design center stage and defines it broadly as “everyone designs who devises courses of actions aimed at changing existing situations into preferred ones” (Simon, 1996, p. 111).

Central to the literature on modularity is the potentiality for change in particular the benefits related to the ability to mix and match modules thus creating variety and change while maintaining a stable architecture. However not much of the literature focus on the process of change which is involved in the struggles to realize a modular structure. As discussed in chapter 2 a frequent assumption underlying much of the literature on modularity is the ability to identify in advance the important interdependencies and subsequently structure these hierarchically to realize modularity. The sequential conceptualization of the modularization process thus assumes an a priori development of the architecture with its interface specification and only limited attention is given to the process of this construction.

Simon is not blind to the lack of understanding of the process of representing problems as he notes “The process of discovering new representations is a major missing link in our theories of thinking and is currently a major area of research in cognitive psychology and artificial intelligence” (Simon, 1996, p. 109). However it is not a process to which Simon devotes much attention as Schön notes “*Simon proposes to build a science of design by emulating and extending the optimization methods which have been developed in statistical decision theory and management science*” (Schön 1983, p. 47).

The process of the change in social systems in general and organizations in particular has received significant but quite discrepant attention from different theoretical perspectives. Traditionally change has been conceptualized as the move from one state at a point in time and space to another state at a different point in time and space driven by the intention of a rational designer. Schön calls this the Technical Rationality perspective, closely linked to the positivist philosophy of science, which have had a major impact on both academic and practical professions (Schön, 1983). From this perspective practice is about problem solving in which decisions are solved by choosing among a range of available options the best one applicable. However Schön contests that such a perspective neglects the *problem setting* and that the real difficulty in practice is to understand what the problem is in the first hand, rather than the selection between different available solutions. The technical rationality perspective thus directs attention to one aspect of problem solving but fails to capture the crucial fact that to the practitioner problems do not readily present themselves to be solved. Frequently they

are rather the product of a process in which the practitioner discovers and makes sense of a problematic situation as he explains: “In real-world practice, problems do not present themselves to the practitioner as givens. They must be constructed from the materials of problematic situations which are puzzling, troubling, and uncertain. In order to convert a problematic situation to a problem, a practitioner must do a certain kind of work. He must make sense of an uncertain situation that initially makes no sense” (Schön, 1983, p. 40).

The appropriateness of the technical rationality perspective as a point of departure thus depends crucially on the problematic situation facing the practitioners as it requires agreement on ends. However in situations of uncertainty and conflicting ideas of means and ends technical rationality no longer offers an appropriate representation of how practitioners engage with practice. “If the model of Technical Rationality is incomplete, in that it fails to account for practical competence in ‘divergent’ situations, so much the worse for the model. Let us search, instead, for an epistemology of practice implicit in the artistic, intuitive processes which some practitioners do bring to situations of uncertainty, instability, uniqueness, and value conflict” (Schön, 1983, p. 49). What Schön suggest instead to better account for the practice of practitioners in such situations in an appreciation of what he denotes as reflection-in-action which acknowledges that practitioners often know more than what they can express formally but at the same time frequently encounter unknown and uncertain situations in which they have to reflexively negotiate with the situation carrying out artistic acts of improvisation. He describes how practitioners that are engaged in such situations “They deliberately involve themselves in messy but crucially important problems, and when asked to describe their methods of inquiry, they speak of experience, trial and error, intuition, and muddling through” (Schön, 1983, p. 43). These professionals are not only jazz musicians engaged in improvisation but include practitioners engaged in design more broadly speaking. Through his study of architecture practices he demonstrates how the architect engages in a series of experiments in which he listens and iterates as decisions sparks responses from the situation leading to different avenues of exploration. The architect thus “discovers in the situation’s back-talk a whole new idea which generates a system of implications for further moves. His global experiment is also a reflective conversation with the situation” (Schön, 1983, p. 102). Schön thus urge researchers to consider the role of

reflexivity as it is enacted in practice when practitioners engage in conversations and negotiations with the situation at hand.

This challenges the assumptions of technical rationality. Moreover as Béguin (2003) point out the conception of design as an activity which is distinctly separated from activities of use can be challenged “In a developmental perspective on activity, design seems to be without any real beginning or end: it is more a cyclical and never-ending process... design and use mutually shape another. The result of one person’s activity (the designer *or* the user) constitutes a resource for the activity of another. This is very different from the traditional engineering approach, where design is perceived as a change of state during which a problem is solved” (Béguin, 2003, p. 711, emphasis in original).

As discussed in chapter 2 the design of process and system architecture is far from just a technical issue but involves organizational routines and organizational change (Pentland & Feldman, 2005; 2008; Peltokorpi, 2008). In the study of organizations and organizational change such a call seems no less apparent and consequently recent organizational research have focused increasingly on the processes by which organizing and change occur.

Weick points out how organizations emerges as people engage in processes of sensemaking (Weick, 1995) in which “*people organize to make sense of equivocal inputs and enact this sense back into the world to make that world more orderly*” (Weick et al. 2005, p. 410). As with Schöns reflection-in-action the process of sensemaking is not simply a transformation from A to B based on technical rationality but rather is an attempt to capture not only the activity of interpreting confounding situations but also invention of action, as sensemaking is both about trying to understand “*what’s going on here?*,” and equally important “*what do I do next?*” (Weick et al., 2005, p. 412). “*The concept of sensemaking is valuable because it highlights the invention that precedes interpretation. It is also valuable because it implies a higher level of engagement by the actor. Interpretation connotes an activity that is more detached and passive than the activity of sensemaking.*” (Weick, 1995, p. 14)

If we want to study the modularization of systems such as a service process architecture which is inherently social and the development of which takes place in social interaction

between actors, it is not sufficient to study the structural properties of the system but we must importantly turn our attention to the process in which situated actors construct and reconstruct the system. This requires us to turn our attention to designers and their interaction in the process of designing and it suggest that we should pay attention not only to intentions and expected outcomes of decision making, but also embrace the unintended consequences of design. In these processes and in the reflective actions of decision makers we can find not only the characteristics of technology, but rather how technologies are enacted as technology-in-practice (Orlikowski, 2000; Orlikowski & Barley, 2001).

Anthony Giddens devotes much of his theoretical development to the relation between structure and agency, criticizing at the same time structuralism for neglecting the role of human agency and interpenist schools of thought on the other hand for neglecting the role of structures in enabling and constraining human action. To replace the dichotomy he suggest instead a duality of structure in which neither structure nor agency should be the exclusive object of analysis. Structures are constantly reproduced by knowledgeable human actors who in their reproduction of structure are modifying it based on their constant monitoring of practice as well as their discursive practice of monitoring the monitoring. Thus in his theory of structuration, both structure and reflexive agency is essential features:

“All structural properties of social systems, to repeat a leading theme of structuration theory, are the medium and outcome of the contingently accomplished activities of situated actors. The reflexive monitoring of action in situations of co-presence is the main anchoring feature of social integration, but both the conditions and the outcomes of situated interaction stretch far beyond those situations as such. The mechanisms of ‘stretching’ are variable but in modern societies tend to involve reflexive monitoring itself. That is to say, understanding the conditions of system reproduction becomes part of those conditions of system reproduction as such” (Giddens, 1984, p. 191). Giddens thus urge researchers of social systems to give sufficient room for agency as he argues that what moves social systems are human actors and not social categories or structures. However, he maintain that situated actors are not unaffected by the structures in which they are engaged in practice, rather their actions are both enabled and constrained by them. It is thus central that human actors are not designing

social systems free from the context in which they are situated but are rather constantly engaged in a process of transformation in which structures influence the action of actors who in turn influence the structures through their action:

*“Human societies, or social systems, would plainly not exist without human agency. But it is not the case that actors create social systems: they reproduce or transform them, remaking what is already made in the continuity of **praxis**.”* (Giddens, 1984, p. 171, emphasis in original)

In this perspective understanding the design process would imply paying close attention to the reproduction of structure and it challenges the conceptualization of design as a decision making process taking place outside the social context in which it is embedded. Instead agents are recurrently situated in contexts in which they are facing structural elements both enabling and constraining their actions:

“Analysing the structuration of social systems means studying the modes in which such systems, grounded in the knowledgeable activities of situated actors who draw upon rules and resources in the diversity of action contexts, are produced and reproduced in interaction.” (Giddens, 1984, p. 25)

To Giddens praxis is thus the reproduction of action contexts in which agents based on their reflexive monitoring of the situation and their interaction reproduce the rules and resources which constitute structure. In this reproduction the rules and resources are themselves subject to modification based on the action of agents which can have both intended and unintended consequences.

“The duality of structure is always the main grounding of continuities in social reproduction across time-space. It in turn presupposes the reflexive monitoring of agents in, and as constituting, the duree of daily social activity. But human knowledgeable ability is always bounded. The flow of action continually produces consequences which are unintended by actors, and these unintended consequences also may form unacknowledged conditions of action in a feedback fashion.” (Giddens, 1984, p. 27)

Giddens conceptualization of action is that of process in which action is continuously taking place on the basis of the reflexive monitoring of agents which is a distinctive feature of human agents. However Giddens emphasizes that these actions result in both intended and unintended consequences as the knowledgability does not imply complete foresight and

“Agency refers not to the intentions people have in doing things but to their capability of doing those things in the first place... Agency concerns events of which an individual is the perpetrator, in the sense that the individual could, at any phase in a given sequence of conduct, have acted differently. Whatever happened would not have happened if that individual had not intervened. Action is a continuous process, a flow, in which the reflexive monitoring which the individual maintains is fundamental to the control of the body that actors ordinarily sustain throughout their day lives.” (Giddens, 1984, p. 9)

This continuous flow of action is reflected in the stratification model of action in which Giddens considers intentionality to be a process which is a routine feature of human conduct and through which the reflexive monitoring of action which takes place on the background of the expectations of agents to explain and account for their actions in the rationalization of action.

Figure 11 Giddens stratification model of action

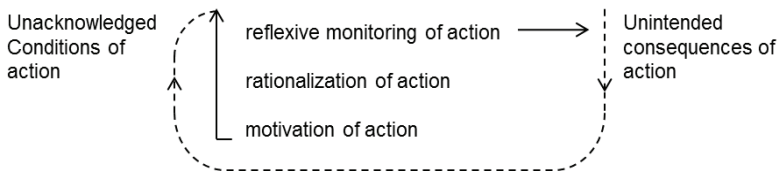

Source: Adapted from Giddens, 1979, p. 56

The reflexive monitoring of action and the rationalization of action are closely related and are taking place primarily as a conscious element in human agency, while the motivation of action is balancing between the conscious and unconscious. Giddens defines intentional as *“characterizing an act which its perpetrator knows, or believes, will have a particular quality or outcome and where such knowledge is utilized by the author of the act to achieve this*

quality or outcome” (Giddens, 1984, p 10). Whereas much attention has been given to intentionality and the study of intended consequences, Giddens maintains that the unintended consequences should be of primary importance to the study of social science: *“The unintended consequences of action are of central importance to social theory in so far as they are systematically incorporated within the process of reproduction of institutions... One such implication is that the unintended consequences of conduct relate directly to its unacknowledged conditions as specified by a theory of motivation. For in so far as such unintended consequences are involved in social reproduction, they become conditions of actions also”* (Giddens, 1979, p. 59). The unintended consequences often overlooked in the literature thus have the important implication that they themselves become conditions for actions in the continuing transformations of praxis. For the studies of modularity in service this would imply that unintended consequences from design decisions can have implications for the future actions of agents as they influence the conditions on which

However that actions have unintended consequences does not imply that agents are without skills, quite to the contrary: *“If the study of unintended consequences and unacknowledged conditions of action is a major part of social research, we should none the less stress that such consequences and conditions are always to be interpreted within the flow of intentional conduct. We have to include here the relation between reflexively monitored and unintended aspects of the reproduction of social systems, and the ‘longitudinal’ aspect of unintended consequences of contingent acts in historically significant circumstances of one kind or another”* (Giddens, 1984, p. 285-286).

While stressing the importance of studying unintended consequences of action Giddens emphasizes how it is critical to maintain the intentionality of situated actors. This implies maintaining the process view of action to study how the reflexive monitoring and unintended consequences are related: *“To study the structuration of a social system is to study the ways in which that system, via the application of generative rules and resources, and in the context of unintended outcomes, is produced and reproduced in interaction.”* (Giddens, 1979, p. 66)

Practices thus constitute the social systems of which structural properties are both medium and outcome. This is what is meant by the duality of structure in which it is important to

emphasize that structure is both enabling and constraining the action of agents. Figure 11 illustrates the different dimensions of the duality of structure which are combined in social practices.

Figure 12 The dimensions of the duality of structure

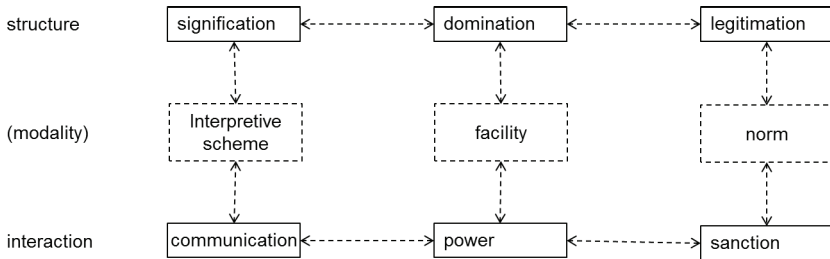

Source: Giddens (1984, p. 29)

Structure or structuring properties consists of rules and resources and these are what provide the ‘binding’ of time and space in social systems. Giddens divides the structural properties into rules of signification, rules of normative sanctions and resources of domination related to power. The modalities are what link the knowledgeable capacities of agents to the structural properties in the duality of structure. “Actors draw upon the modalities of structuration in the reproduction of systems of interaction, by the same token reconstituting their structural properties” (Giddens, 1984, p. 28). According to Giddens all social practices involve the three elements of communication of meaning in interactions, power relations and normative sanctions.

Giddens distinguishes between social systems from structure and argues that social systems exist in time-space (contrary to structure) constituted by social practices: “The concept of social system, understood in its broadest sense, refers to reproduced **interdependence of action**: in other words, to ‘a relationship in which changes in one or more component parts initiate changes in other component parts, and these changes, in turn, produce changes in the parts in which the original changes occurred’” (Giddens, 1979, p. 73 emphasis in original)

The interdependence of action thus involves causal loops where unintended consequences can feedback into the initiating circumstances to reconstitute these and this reconstitution of the conditions of actions is essential in the process of action.

The theory of structuration has received much attention within the literature on information systems but due to the little attention explicitly given to technology by Giddens several authors have suggested modifications to the theory. DeSanctis & Poole (1994) thus propose Adaptive Structuration Theory as a method for studying technological change in which social structure, rules and resources is the focus but with an inclination for technologies. They thus focus on advanced information systems as technologies that enable multiparty participation in organizational activities through sophisticated information management and as they note these *“bring social structures which enable and constrain interaction to the workplace... they support coordination among people and provide procedures for accomplishing interpersonal exchange... advanced information technologies have greater potential than traditional business computer systems to influence the social aspects of work”* (DeSanctis & Poole, 1994, p. 125).

Similarly Orlikowski (2000) has advanced a practice lens to the study of technologies as she argues it will better enable the study of emergence and change in technologies in use. *“Because the enactment of a technology-in-practice is situated within a number of nested and overlapping social systems, people’s interaction with technology will always enact other social structures along with the technology-in-practice”* (Orlikowski, 2000, p. 411)

Figure 13 Enactment of technology in practice

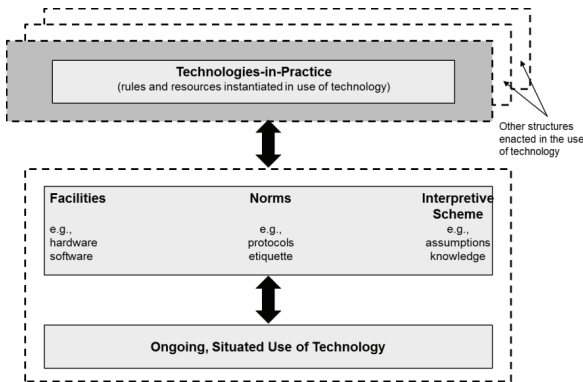

(Adapted from Orlikowski, 2000, p. 410)

“In their recurrent and situated action, actors thus draw on structures that have been previously enacted (both technologies-in-practice and other structures), and in such action reconstitute those structures. Such reconstitution may be either deliberate, or, as is more usual, inadvertent” (Orlikowski, 2000, p. 411)

In order to study the emergent properties of the modularity of service processes the thesis will thus draw on the practice lens in order to be attentive to more dynamic processes involved in the efforts to develop socio-technological architectures of service processes.

3.4 The role of management control in achieving modularization

The previous sections of this chapter have presented modularization as a phenomenon with major economic implications for organizations and society at large. Moreover I have argued that although much progress has been made in establishing an economic theory of modularity providing significant insights into the consequences to industrial organization, this does not pay significant attention to the managerial practices implicated in moves towards modularization. As suggested in section 2.1.10 the study of actual practices of coordination and control may offer insights into the dilemmas facing managers and designers in their efforts to achieve modularity. Although only few links are made to the domain of

management accounting and control within the literature on modularity (Thyssen et al., 2006; Israelsen & Jørgensen, 2011; Jørgensen & Messner, 2010) this field of investigation may offer insights into the mechanisms and practices managers put in place in the face of uncertainty and ambiguity in order to inform decision making and influence behavior within organizations. This section provides a brief review of the theoretical perspectives on control and coordination and a short elaboration of frameworks of management control systems including that of Merchant and Van der Stede (2007) which will be utilized in the empirical analysis to frame the findings from the case by distinguishing different elements of management control.

Anthony distinguishes between strategic planning, management control and operational control and defines management control as “the process by which managers assure that resources are obtained and used effectively and efficiently in the accomplishment of the organizations objectives” (Anthony 1965, p. 17). Management control in this definition would thus seem very much in line with the systems and incentives called for by Garud and Kumaraswamy (1995) as important to the realization of standardization and reuse.

Within the management accounting literature several frameworks have been suggested to describe the elements of management control. Based on a definition of management control systems as “*The formal information based routines and procedures managers use to maintain or alter patterns in organizational activities*” Simons constructs a theory around four levers of control; belief systems, boundary systems, diagnostic control systems and interactive control systems (Simons, 1995, p. 5)

Malmi & Brown (2008) provide an elaborate typology of management control systems which “*starts from the idea that control is about managers ensuring that the behavior of employees (or some other relevant party, such as a collaborating organisation) is consistent with the organisations’ objectives and strategy*” (Malmi & Brown, 2008, p. 295). They suggest that such systems should be viewed as a package of controls rather than individually in isolation. Their typology distinguishes five overall elements in the package of control. These are cultural-, cybernetic- and administrative controls together with reward and compensation as well as planning.

Figure 14 Management control systems as packages

| | | | | | | |
|--------------------------------|-----------------|----------------------------|-------------------------------|-----------------------------------|----------------------------|--------------------------------|
| Cultural Controls | | | | | | |
| Clans | | Values | | | Symbols | |
| Planning | | Cybernetic Controls | | | | Reward and Compensation |
| Long range planning | Action planning | Budgets | Financial Measurement Systems | Non Financial Measurement Systems | Hybrid Measurement Systems | |
| Administrative Controls | | | | | | |
| Governance Structure | | | Organisation Structure | | Policies and Procedures | |

Adapted from Malmi & Brown (2008), p. 291

Ferreira and Otley (2009) provides a framework for analyzing performance management systems by identifying a range of questions relevant to the designers of such systems. While both of these frameworks may clearly provide insight into the use of management control in the context of modularization they are both quite elaborate and for the purpose of providing a frame of reference in the empirical analysis the framework of Merchant and Van der Stede (2007) will be briefly presented below and utilized in chapter 7.

On the basis of the object of control Merchant and Van der Stede distinguishes between *results controls*, *action controls* and *personal controls* and *cultural controls*. According to Merchant and Van de Stede the control problem generally consist of three aspects, lack of direction, motivational problems, and personal limitations. Whereas results controls involve establishing incentives, action controls on the other hand are established to ensure that the actions taken by employees are in line with organizational goals through direct control of these actions. This can take the form of establishing behavioral constraints such as limiting the access to certain actions, pre-action reviews, action accountability and redundancy. Personnel controls consist in procedures for selection and replacement of employees and training as well as job design and provision of necessary resources. Finally cultural controls involves the codes of conduct present in an organization and incentives such as group rewards which can work to reinforce norms.

3.5 Chapter summary

This chapter has introduced theoretical perspectives in order to address modularity of service processes as an economic phenomenon. The first section introduced two organizational economic perspectives on the firm and highlighted that the concern for modularity is importantly related to both of these. However while transaction cost economics generally treat transactions as given the interest in modularity is very much about how transactions are created in the first place. In other words the design of the structure of products and services impact the characteristics of transactions. The ability to design structures in the first place is not homogeneously distributed across firms but require capabilities which are themselves developed over time and relate to the competitive advantages of the firm. The competence based perspective thus emphasizes how the development of capabilities relates to the competitive advantages of the firm. As both of these two theoretical perspectives are centrally linked to the notion of modularity recent efforts have been made to bridge the two perspectives into what has been suggested as a modularity theory of the firm. Although this theory suggest to offer insights into the nature of the firm it follows the assumption that interdependencies can be anticipated a priori as discussed in chapter 2. In order to have a view for such emergence a practice lens was suggested which allow for sensitivity in the empirical investigation for studying unintended consequences and the way in which management react to such. Finally the chapter concluded by introducing a management control framework to provide a lens for capturing how management attempts to control the effects from unintended consequences of the architecture. The next chapter will discuss the methodology used in the empirical analysis.

Chapter 4 Methodology

This chapter will introduce the research methodology of the thesis. The first section seeks to introduce and discuss a number of questions relevant to the research methodology which are of ontological and epistemological nature. These questions are raised and addressed on the basis of critical realist philosophical contributions. Based on these discussions the subsequent section introduces the research design of the thesis. As will be elaborated on below the thesis will employ a case based research design with empirical material of a primarily qualitative nature. Currently one case study has been initiated within a Danish financial service provider however it is expected that further case studies are necessary. The next section will introduce the first case study in more detail including tentative findings in relation to management dilemmas of business process architectures.

4.1 Philosophy of science

The purpose of this section is to introduce the broader considerations related to philosophy of science. While such considerations can appear abstract they nevertheless have implications for the more practical concerns regarding research design. These concerns will be elaborated on in the subsequent section.

4.1.1 Ontological and epistemological considerations

This thesis adopt a critical realist methodological stance implying that it assumes the existence of a real world which however exist independently of our attempts to theorize about it and thus rejects that it is possible to achieve objective knowledge of this world. As Van de Ven note *“because data are theory-laden and error-prone, the challenge is to compare plausible alternative models given our current understanding of the subject matter instead of searching for the ultimate truth”* (Van de Ven, 2007, p. 66). The critical realist philosophy of science thus combines an objective ontology *“that presupposes the existence of a mind-independent reality”* and a subjective epistemology *“.*

Ontologically the critical realist philosophy of science considers social systems as open in the sense that they produce unexpected and unexplainable actions and hence are dynamic in nature. It is thus fundamental to critical realism that the social sciences are essentially different from the natural science due to fundamental difference in the object of their study. Thus as Bashkar notes *“social structures, unlike natural structures, do not exist independently of the agents’ conception of what they are doing in their activity”*. This seem to reflect the principle of the double hermeneutic within the social sciences as stated by Giddens that *“All social research has a necessarily cultural, ethnographic or ‘anthropological’ aspect to it. This is an expression of what I call the double hermeneutic which characterizes social science. The sociologist has as a field of study phenomena which are already constituted as meaningful”* (Giddens, 1984, p. 284). However the role of the social sciences in relation to values and actions is not of a simple deterministic nature as Bhaskar notes *“Although I argue that social science sometimes entails, often informs and always affects values and actions, I am far from holding that either can be wholly determined*

by or analytically reduced to social science. Social science cannot determine or uniquely ground values, because there are other good things in life besides explanatory knowledge; and it cannot determine, or on its own rationally inform, action, because this is always a matter of will, desire, sentiment, capacities, facilities and opportunities as well as beliefs” (Bhaskar, 2009, p. 171).

In a similar vein as Anthony Giddens critique of sociological theoretical traditions emphasizing a dualism between agency and structure (Giddens, 1984) the critical realist perspective maintain that an understanding of social practices necessarily involves both agency and social form *“While society exists only in virtue of human agency, and human agency (or being) always presupposes (and expresses) some or other definite social form, they cannot be reduced to or reconstructed form one another... society is not the creation of unconditional human agency, but neither does it exist independently of it; and individual agents neither completely determine, nor are completely determined by, social forms”* (Bhaskar, 2009, p. 125). Furthermore the conception of the social within the critical realist perspective is of a transformative nature in which agency involves the reproduction of structure, as we *“in our transformative causal agency, mobilizing pre-existing structures, we endow the world with consequences, realizing (or not) our purposes in it, and conferring meaning upon it, including the physical and cultural products of agency, reproducing or transforming those structures in the course of our agency”* (Bhaskar, 2009, p. 172).

As pointed out by Pratten a critical realist methodology breaks with the methodology implied in the theorizing of Williamson and the traditional transaction cost economics: *“I argue that it is precisely Williamson’s acceptance of something like deductivism that links him to orthodoxy, and this constrains his attempts to develop more compelling treatments of human agency and social institutions”* (Pratten, 1997, p. 786). Milgrom & Roberts are similarly open to the limits of the transaction cost approach to economic organization. Specifically they point out that the sum of transaction cost and production cost does not necessarily express total cost of economic activity in the sense that *“production and transaction costs generally depend both on the organization and on the technology, which makes the conceptual separation between production and transaction costs troublesome”*. Furthermore they point

to the fact that economizing can be quite complex given that there can be different solutions to resource allocation problems and *“Too many different patterns of organization might be compatible with efficiency for it to be a useful concept”* (Milgrom & Roberts, 1992, p. 34).

The traditional transaction cost approach may thus be criticized for applying a closed view on economic organization and reducing decision of vertical integration to specifications of only a few dimensions of transactions. As discussed above several authors have pointed to other mechanisms which could potentially supplement and under some circumstances counter the effects of asset specificity. Although the critical realist epistemology rejects the notion of objective truth it maintains a *“In contrast to positivism and relativism, more contemporary forms of realism viewed truth as being a process of successive approximations of reality, or verisimilitude. Furthermore it rejected the positivistic adoption of constant conjunctions and the relativistic view of socially constructed causal relations and replaced them with a realistic construal of causal mechanisms that exist independently of our knowledge”* (Van de Ven, 2007, p. 63). From this it follows that although the critical realist perspective maintains the existence of causal mechanisms the Humean conception of causality as constant conjunctions is rejected on the basis of a layered or stratified ontology in which events in the actual are affected but not determined by real causal mechanisms as Bhaskar (2009, p. 195) point out *“Distinguishing between the domains of the real and the actual and between open and closed systems forges a way, in the teeth of the flat and uniform ontology of Humean empiricism, to a stratified and differentiated ontology of transfactually active causal structures and things”*. However this stratified ontology does not imply a simple deterministic conception of events in the actual or the existence of a simple relation between the real and the actual as Fairclough note *“The ‘actual’ does not in any simple or straightforward way reflect the ‘real’: the extent to which and ways in which the particular causal powers are activated to affect actual events is contingent on the complex interaction of different structures and causal powers of the causing of events”* (Fairclough, 2005, p. 922). This in turn has implications for the objectives of scientific investigation which in the critical realist perspective is the explanation of *“social processes and events in terms of the causal powers of both structure and human agency and the contingency of their effects”* (Fairclough, 2005, p. 923). These causal powers or mechanisms are thus the primary object of theorization

where “*Mechanisms are the stuff of reality that produces events. Mechanisms are not mental constructions: they – like events – exist independently of scientific activity. But to give a scientific explanation of an event or a fact – in a realist framework – is to give a theoretical account of the mechanisms that produced the relevant event or fact*” (Foss, 1994, p. 40). There is thus a long way from the causal laws of the positivist philosophy of science to the generative mechanisms suggested by critical realism. “*By defining the generative mechanisms (causal powers) of, say, the capitalist logic and the kind of social structures that help sustain and reproduce these mechanisms, researchers do not postulate ironclad laws, but tendencies, which may or may not manifest themselves in the empirical domain*” (Tsoukas, 1989, p. 558).

4.1.2 Reflexivity and management dilemmas

The thesis will thus not apply a strictly deductive method of inference as transaction cost economics in the tradition of Williamson (Pratten, 1997). Rather the thesis suggests a method of abduction (Van de Ven, 2007) in which the causal explanations of the theoretical perspectives are considered the interpretive repertoire by which the empirical material of the case studies are met. In order to identify the management dilemmas of the use of process modularity and the mechanisms driving the design of processes toward modularity or integration the thesis seek to remain open to mysteries and breakdowns in knowledge (Alvesson & Karreman, 2007). This involves attention to the limits of the knowledge offered by the different theoretical perspectives as well as sensitivity to the complexity and contextuality of the decisions and actions in practice. The thesis thus seeks to observe the tensions and effects that a transformation towards process modularity entails.

4.2 Research design

The central focus of this thesis lies in trying to understand how and under which conditions the process architectures and individual business processes are development in a more modular way. Thus the thesis is interested in examining the process of modularization in relation to business processes. In other words, how it is that a business process comes to be more or less loosely coupled and how such loosely coupled elements are combined and recombined in the pursuit of benefits and at the expense of certain costs. The thesis thus aims to investigate the development process itself and identify the intentions by which different actions are chosen.

In examining the development process the thesis thus seek to employ a process oriented research methodology (Van de Ven, 2007). As research strategy the project thus employs a case based approach (Yin, 1981; Eisenhardt, 1989). Case studies can be used for: exploration, theory building, theory testing, and theory extension/refinement Voss (2009). In the process of exploring the relationship between business service processes and modularity, it is intended to refine and test the operationalization of the service processes through the lenses of service modularity architecture. To illustrate the application of the service modularity

function in a service process context, a case study of a Danish financial service provider is carried out. Furthermore the case study is an appropriate research method to explore the questions of *how* process modularity unfolds and challenges the architecture. The case study as research strategy is chosen as the research question primarily addresses the understanding of *how* process modularity is achieved, *what* the effects of can be and *why* these effects are observed. In addition it is intended to study the use of process modularity in actual and real environments in which I do not expect to influence its use by the actors to a considerable extent (Yin, 1994).

4.2.1 Case research

The case study is an embedded single case study in the sense that investigations are made on more than one level of analysis (Yin, 1994). On an architectural level interviews have been held with managers and architects within the department responsible for the design of the company's service processes and their process architecture. On a project level three projects has been followed in which individual financial schemes are migrated from legacy systems and existing processes to the new architecture. The case involves direct observation at meetings and workshops performed in a process development project as well as information from interviews and archival records related to projects and the overall architecture (i.e. presentations, documentation of processes and systems etc.). In order to achieve a detailed understanding of the architecture and to mitigate the risk of bias information has been sought from many knowledgeable informants (Eisenhardt & Graebner, 2007). Information has been recorded in a range of different forms and from several organizational members in example through meetings, workshops and interviews with senior managers, project managers and team members as well as with the employees actually performing the business processes.

The case company was selected based on the ability to illustrate interesting observations that can be used in analyzing process modularity and its effects. The hypotheses of the project will be constructed and analyzed during the course of the case investigation but will take as their starting point the concepts discussed in the above sections. The intention is to use a number of dimensions of transactions to characterize and categorize process modularity and the effects of such to enable analysis within each case and search for patterns across cases (Yin, 1981;

Eisenhardt, 1989). The project will primarily seek evidence through the collection of qualitative data. Interviews and observation in the case company therefore constitutes the primary method of data collection.

As indicated above the case involves more than one unit of analysis and can thus be considered an embedded case study (Yin, 1994) in which I through maintaining both a project and architectural level of analysis seek to avoid the risk of not reaching a level of analysis that allow for conclusions on the process architectural level. The present stage of the case study is best characterized as an exploratory pilot study. Meetings and interviews conducted so far have been semi-structured with open ended questions intended to identify areas of relevance to the research question with potential interesting findings. To supplement interviews and in order to gain a more detailed understanding of the design of business processes within the case company I have attended a number of meetings and workshops in the role of observer. In this connection I have been offered company presentations and detailed information on the process design including process diagrams and descriptions, specification of coverage as well as material on methods of process design and analysis within the case company.

4.2.2 Data collection

Empirical data was collected in the period of February 2009 through to June 2011. Different methods were used in collecting data and a total of 30 interviews and observations during meetings and workshops were conducted. In order to allow for analysis of the data interviews and meetings were recorded, transcribed verbatim and subsequently coded and analyzed. All communication during interviews and observations was conducted and transcribed in Danish and quotations used in the thesis have subsequently been translated to English by the author. Informants included a broad range of employees and managers within the case organization involved in the design and management of processes. In total 33 individuals within the organization as well as employees of 3rd party providers of the organization took part in the interviews and meetings. Due to the request for anonymity by the case organization positions instead of the names of individuals are used in the thesis.

Table 6 List of interviews and observations

| Date | Participants | Purpose and overall topic |
|-------------|--|--|
| 03-02-2009 | Manager Enterprise Architect | Interview regarding process design within the organization |
| 31-03-2009 | Manager Enterprise Architect, Project Manager | Interview and introduction to the process design projects |
| 15-04-2009 | Project Manager, Project/Process Manager | Interview and introduction to the Scheme A |
| 15-04-2009 | Multiple participants (the management group of the process development department) | Participation in management meeting of the process development department |
| 06-05-2009 | Manager Enterprise Architect, Enterprise Architect, Head of Process Management and Design | Interview regarding the relation between flexibility and business strategy |
| 06-05-2009 | Project Manager, Project/Process Manager | Interview regarding the scheme A solution flow |
| 14-05-2009 | Project Manager, Project/Process Manager | Interview regarding the scheme A processes |
| 28-05-2009 | Project Manager, Project/Process Manager, Process Consultant, Head of Process Management and Design | Observing discussions of decision paper regarding scheme A |
| 10-06-2009 | Process Consultant, Project/Process Manager, Legal Consultant, Caseworker | Workshop scheme A |
| 02-09-2009 | Project/Process Manager, Project/Process Manager | Interview |
| 04-09-2009 | Project/Process Manager, Project/Process Manager | Interview regarding administration processes |
| 08-09-2009 | Project/Process Manager, Project/Process Manager | Operating processes and scheme B |
| 21-09-2009 | Project Manager, Project/Process Manager, Process Consultant, Project/Process Manager | Workshop in the process development department on Scheme B |
| 25-09-2009 | Manager Enterprise Architect, Project Manager | Interview |
| 03-12-2009 | Multiple participants | Participant observation in meeting with 3rd party vendor regarding KPI's and processes |
| 17-12-2009 | Manager Enterprise Architect, Project Manager | |
| 17-12-2009 | Project Manager, System Specialist | Interview regarding process and system documentation |
| 09-02-2010 | Project Manager, System Specialist, Enterprise Architect, Business Process Manager | Participating in workshop on relation between solution flow and solution design |
| 17-02-2010 | Solution Architect | Interview regarding workshop scheme C |
| 17-02-2010 | Head of Projects, Economist, System Specialists, IT Specialists (external), Solution Architect | Workshop on solution designs of scheme C |
| 19-04-2010 | System Specialists, IT Specialists (external), Solution Architect | Workshop on specification of interfaces of scheme C |
| 21-04-2010 | System Specialists, IT Specialists (external), Solution Architect | Workshop on specification of interfaces of scheme C |
| 21-04-2010 | Solution Architect | Interview regarding design and reuse of interfaces |
| 13-06-2010 | Manager Enterprise Architect, Enterprise Architect, Project Manager, Head of Process Optimization | Workshop on process design |
| 03-05-2011 | Project Manager | Interview regarding process design |
| 03-05-2011 | Business Developer, Business Process Manager, Head of Business Solutions and Process Design, Project Manager | Interview regarding scheme C and the enterprise architecture |
| 17-05-2011 | Business Developer, Solution Architect | Interview regarding scheme C and the enterprise architecture |
| 27-05-2011 | Business Developer, Solution Architect | Interview regarding scheme C |
| 07-06-2011 | Manager Enterprise Architect, Project Manager, Head of Process Optimization | Interview regarding process design |
| 17-06-2011 | Business Consultant | Interview regarding scheme B |

Source: Based on field notes

Table 6 lists the interviews and observations with dates, participating informants as well as the overall purpose of the event.

4.3 Chapter summary

This chapter has provided an introduction to the methodology used in this thesis and has proposed critical realist perspective which implies an attention to the open system characteristic of social systems such as the development of service process architectures. The research design chosen for the empirical analysis is to conduct a longitudinal case study within a Danish financial service provider. The data collection consisted of interviews and participant observations as well as archival material and process documentation. The next chapter introduces the case company in more detail.

Part II

Empirical Analysis

Chapter 5 Designing processes at DK-Finance

This chapter is based on the paper ‘Measuring service process modularity: an empirical application of the service modularity function’ co-authored with Juliana Hsuan and presented at the 17th annual EurOMA conference in Portugal 2010 and the 3rd Workshop on Journal Publishing for Non-Native English-Speaking Researchers in OM in Vincenza 2010. The chapter will introduce the case company in which studies are currently undertaken. The first meetings were held with the company in February 2009 in order to establish whether the company would be interested and interesting in relation to the research question of the thesis. Through a number of interactions it was decided that this was the case primarily due to the fact that flexibility in relation to process architecture was indicated to be a central area of focus for the company which has invested significantly in replacing existing business process and IT infrastructure with a new architecture based on service orientated principles and loose coupling. In this decision consideration was taken to the fact that the word ‘modularity’ does not appear to be applied extensively within the company. However a strong focus on standardization of process components as well as explicit considerations on the degree of coupling between components within the architecture underlined the relevance of the case to the topic of this research which will be elaborated on in the following.

5.1 Case company – Financial Services

The aim of this section is to introduce the case company as well as to discuss the practices of process design within the company.

5.1.1 Introduction to the case company

The case company which will be labeled under the fictitious name DK-Finance is a financial service company which offer administrative handling of pension and insurance like products to a large number of end users on behalf of public and private service providers. The company has +500 employees and is based in Denmark. The company provides an interesting case in relation to process modularity for a number of reasons. Firstly as the company operates as a business process outsourcing provider the company's processes constitute an essential element of its products/services. Hence there is significant management attention on the development and improvement of its processes. Furthermore there are tight links between the design of processes and the development of technological infrastructure. DK-Finance has thus invested heavily in replacing its existing system landscape through developing a modern ICT infrastructure based to some extent on the principles of service orientation in which loose coupling of applications play an important role. This new infrastructure has major consequences for the process architecture of the enterprise as several products are migrated from legacy systems to the new platform. This migration entails process redesign in which major changes are made to improve the performance of the individual processes with regard to lowering costs and improving service toward end customers. A central focus of the process redesign projects is the standardization of processes and reuse of process components across products/services. This involves major changes in work design and organizational structure which again underpins the relevance of DK-Finance as case.

The company provides its services to end customers on behalf of other companies and authorities and thus in effect functions as a process outsourcing provider. The nature of the services provided by the company is characteristic of its high processing volumes which are primarily carried out in large batches of information handled across multiple systems. In addition the company handles customer inquiries and case handling such as claims handling

and settlement procedures. As indicated the company handles both pension and insurance like services and differences exist across the individual financial services indicating heterogeneity of services. Importantly however, where this heterogeneity exists, is primarily between schemes which differ in their characteristics, but not to any significant extent within the individual scheme. The services provided to the individual end customers within a particular scheme do not display much variation. Homogeneity of services and consequently low levels of variability would expectedly result in a lesser focus on modularity (Schilling, 2000) and lower levels of flexibility (Sinha and Van de Ven, 2005). However, as indicated above, major investments have been undertaken with an intention of achieving both economies of scale and scope through standardization and architectural flexibility. Consequently this suggests that the investigation of modularity in service process architectures should pay careful attention to the ways in which the ability to recombine processes to potentially create value.

The company has been working with process management and enterprise architecture for several years. In order to support this work the case company has reorganized by establishing an organizational unit responsible for the design and maintenance of processes. Design and management of processes is considered part of the enterprise architecture which the company has established based on a modified version of the Zachman enterprise architecture framework. According to Neaga and Harding (2005) the Zachman framework can be described as a *“conceptual methodology which shows how all of the specific architectures that an organization might define can be integrated into a comprehensive and coherent environment for enterprise systems”* (Neaga and Harding, 2005, p. 1097). As part of this effort, a process architecture has been established specifying service processes which are considered generic across the individual services offered. According to company material, the process architecture contrast with the way processes were previously orchestrated according as each service then consisted of a set of idiosyncratic processes and systems. Figure 13 illustrates the transition which the company has been trying to achieve through development and implementation of a new IT infrastructure replacing existing scheme specific systems and processes. This new infrastructure has major consequences for the process architecture of the enterprise as several services are migrated from legacy systems to the new platform. This migration entails process redesign in which significant changes are made to improve the

performance of the individual processes with regard to lowering costs and improving service toward end customers.

Figure 15 The transition to an architecture based on principles of loose coupling

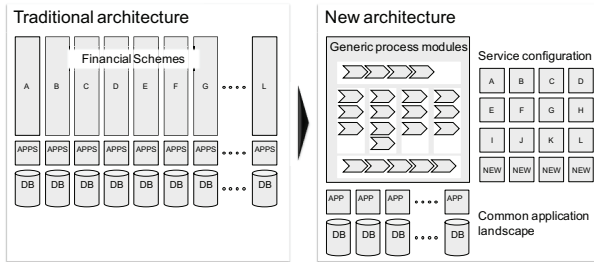

Source: company information

Figure 15 illustrate how the architecture was traditionally centered on each of the financial schemes to which customized applications and databases were developed. In principal these were developed independently of each other, although some were made by copying existing applications as new schemes were added over time. Each scheme thus had its own associated IT specialists with great knowledge of their own scheme and its IT solutions. However resulting from this, different IT solutions existed across the schemes and consequently different processes and routines were used to handle essentially similar business situations. In example the way in which payments were made differed across the various schemes.

“We had ten to twelve different payment systems which were very different... Some of it was made through budding where one has said that this looks like that scheme now we just copy it and adjust it.” [Enterprise Architect]

Through this kind of copying of existing applications many different solutions were created to handle similar issues which resulted in a perceived lack of synergy between the different schemes. It was thus believed to increase costs and perhaps more importantly widespread changes were difficult and costly to make as explained by a solution architect:

“Because a very traditional way of doing this, if you have 14 lines of business, then you build 14 IT systems. We have been there, and it does mean that everyone is entirely free of each other and that you spend your own budget, your own IT budget in each line of business. But it also means that if we have to introduce a new channel of payment then it has to be done 14 times. That was what led to the decision that we made to scrap the whole lot and go in the opposite extreme where we have built one business system which contains 14 lines of business.” [Solution Architect]

Consequently a perceived drawback to this architecture was that it was not sufficiently responsive when new schemes needed to be added to the architecture or significant changes made to several existing schemes. The strategic implication was that the time to market of the architecture was considered too long which motivated the drive to a new architecture. This new architecture centralized the IT systems in the sense that it involves the use of all schemes of the same enterprise application landscape consisting of standardized systems. However the difference of the individual schemes was intended to be encompassed by designing a set of generic process modules from which the individual services could be configured. This configurability was thought to decrease the time to market to introduce new schemes to the platform, as process modules could be reused and easily reconfigured.

“This system (the new architecture) is created because there was too long time to market on the old, so it will be our assertion forever that our time to market has been reduced with this new system, as long as the new that you want to add is fairly similar to something we already have. Then our time to market will be lower... (A new scheme) that is just a bit like one of our schemes or a conglomerate of, there must of course like to be the payment part from one and the claims handling part from another i.e. that would pose no problem to us. And we can almost overnight take on pension schemes with depot, without depot, with injury, without injury, etc. The more they resemble what we already have the quicker we can do it. And we have therefore put an insurance scheme at sea in three months, or was it six?” [Solution Architect]

The design and implementation of the new architecture has not only had technical implications but have had profound effects on organizational practice. The organizational

structure was changed as a consequence of the new architecture and in particular the relationship between IT and line of business has changed. With the drive towards the new architecture new roles for IT specialists were thus established partly through the outsourcing of parts of the company's own IT functions. Furthermore the nature of the dialogue between line of business and IT changed through the process of development and implementation. The solution architect explains this change as follows:

"I think there has been a very great transformation. I have been here for ten years, and back then when I started in 2001, the truth was that line of business was running on the IT systems that were there and they were quite reactive, and then IT had the role of those who made the steps forward and came with the suggestions and were the innovators here. It is a very radical change that line of business are now saying that it is us who are drawing these business processes. Now it is us that define services, etc. And we take on a more supplier like role in this. We are of course still in on this around innovation, etc. but basically we have more of a supplier role. So it has meant a big boost in how much business is engaged in its IT. Because it is increasingly clear that in a financial company, you live and breathe IT from morning to evening. So it is important that business has a decisive influence on it." [Solution Architect]

The distinction between the drawing of processes and the definition and supply of IT services is suggestive of some of the key elements of the architecture and the interplay between requirements to and design of different solutions. In order to facilitate this interpretation of business requirements from line of business to the IT suppliers processes have been an important representational vehicle. The principle of first letting line of business to set requirement to new solutions by designing how the processes is thought to best support business objectives was thus intended to create a better solutions than what would be the result if the capabilities of the IT systems were used by default. However bringing together many lines of business in the same process and system landscape has not been without complications and it brings along its own complexities.

"What makes ours (process architecture) so insanely complex is that we contain many companies within one. That is when you go out and look at others and speak with others who

are doing processes. Gee Wow that is the sheer, and by the way it goes for our IT solutions too, it is the sheer nothing, they have one company they have to model, I just think 'what is the problem?' You don't have the problem that we are actually several companies working in the same flow and that we are doing development at the same time and that we have to be able to handle that too. We have really been good at introducing as many complexities as we at all could." [Head of Business Solutions and Process Development]

As DK-Finance is effectively operating as business process outsourcing provider to different public and private organizations the different financial schemes essentially imply that the platform contains the processes of several companies within the same architecture. The generic process modules thus imply that different schemes using the module may involve the challenge that the use and modification of process modules by different schemes is not independent. This implies that a challenge of the design of processes within the company is the identification of generic properties enabling a single description of the process and at the same time allow for encompassing the differences of the individual schemes. This is made further difficult by the fact that the different schemes follow different regulatory frameworks which set requirements for the design of processes.

"But it is not many companies which have so many variants and which need each of their own ways of doing things, that is for regulatory reasons, then it is not many companies that contain entire companies which they depict in the same way. That is when I speak with others then they can have subsidiaries but then they don't depict it as one, then they have an entirely different way of handling it. So it's a little funny." [Head of Business Solutions and Process Development]

The fact that the processes of the architecture must be designed to encompass several financial schemes introduces complexities which have required the establishing of a practice of process design at DK-Finance.

Challenges of variability to the management of services

As discussed in chapter 2 one of the challenges facing service managers is the difficulties of matching capacity and demand in the face of variability in demand and inflexible capacity.

The different financial schemes for which the company provides administration has this characteristic and was recently exposed to rapid changes in demand due to market conditions.

Figure 16 Incoming inquiries for specific scheme

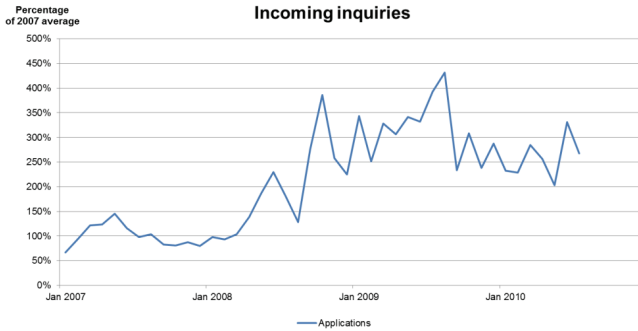

Source: Based on company informaton

Within few months the number of incoming inquiries rose by 300-400% on an ongoing basis which made it difficult for case workers to meet the demand. The case workers handling this scheme are particularly committed as a high level of knowledge of the legal regulations is required of the resources allocated to the process as explained by

“In the scheme the questions are of an individual nature. They are very much related to the individual employee, customers, particular situation... And in order to disburse you have to know the agreements and that require a deep competence. Actually it takes more than a year before you, as seasoned case worker, it takes more than a year before you can actually contribute. So that is a particular problem, you are dealing with a group of people who are a scarce resource and which can easily become a bottleneck because there is only very few of them and you cannot just replace or supplement” [Internal consultant]

In order to solve the challenge different measures were taken including partitioning cases into different process streams depending on their characteristics as well as involving service workers with fewer specific competencies to handle part of the load. However in connection with the project for migrating the scheme to the platform an alternative priority track solution

was subject to discussions within the process design group. This solution would involve being able to activate different variants of the same process depending on the state of the process. In effect this would imply postponing certain activities in situations of large backlogs freeing up capacity for handling activities which were more critical for the individual customer. This solution was discussed during a workshop between process designers and architects regarding the specific scheme:

”But if you have this [alternative process] and we imagine that you deliver the secondary payment after seven weeks and the primary after four weeks in busy periods, then if the period is longer than seven weeks those receiving will actually experience the period even longer. Then you are not doing them a favour to enable this. I think it is wrong to do it like this” [Process designer]

As pointed out by the process designer there would be a danger involved in introducing a variant of the process which sacrifices process efficiency to respond faster to parts of the customer requests. However as a process architect notes this danger represent a tradeoff which depend on the efficiency loss as well as the ability to use alternative resources:

”The crucial point is how much longer it will take. In the example we just constructed it would take 50 percent more time totally and then it starts getting dangerous but then again it might only be 5-10 percent extra, then other effects might begin to be relevant....Then you might use temporary workers for the secondary because then a case worker has already had a look at the case” [Process Architect]

Importantly this challenge and the proposed solution suggest one of the ways in which modularity may be associated with creating flexibility in the management of service processes. Multiple variants of the same process which i.e. could effectively relocate activities to outside providers or divide activities between high and low skilled workers could thus be an important benefit of modularity in the face of variability of services.

5.1.1 The practice of process design within DK-Finance

DK-Finance has been working with process management and enterprise architecture for several years. In order to support this work the case company has reorganized by establishing an organizational unit responsible for the design and maintenance of business processes. On an overall level the company has employed a version of the Zachmann enterprise architecture framework. In that connection a business architecture has been established specifying business processes considered generic across the individual services offered. According to company material the process architecture contrast with the way processes were previously orchestrated according to which each service consisted of a set of idiosyncratic processes and systems.

The design of enterprise architecture was undertaken in 2005 and the architecture has been modified subsequently based on the accumulation of learning and the realization of different challenges.

“We have an enterprise architecture which cuts across the business and IT and we have designated the responsibility based on the framework. We [architecture group within the ‘products’ department] as the business are primarily responsible for the conceptual and logical level and IT is responsible for the other levels [physical and infrastructural]”
[Enterprise Architect]

The focus of the process design is thus stated to a large extent to attempt to establish processes which can function generically across services. In relation to the underlying system an aspiration for loosely coupled services has been sought. In that connection an important aspect is the ability to standardize elements of the processes and handle requirements of individual services by means of introducing variants of the standard process enabled by the loose coupling. One very concrete element of this design of decomposable elements is the specification of letters for users in which composition of letters with standardized components enables variation and individualization of letters while at the same time reducing the total number of letters.

“But that is exactly why it might be that the box looks a little different on service XXX but we can use the principles again and again and that is what makes the system flexible. That I can take out this block of text which is specific to service YYY and put XXX in but still use the rest of the specific letter” [Project manager]

Furthermore automation of communication by composing letters of standardized components based on information from the core system enables customization of letters to the individual customers need further reduces the required number of letters by creating modular text components which are reconfigurable based on business rules:

“It is because of the way that the core has been build that it delivers the set of data which have been changed...In that way we communicate something to the customer so that he can see that for instance that his period has been changed, that there has been a certain absence, or that he has received a certain benefit. Then based on the data we have in the system we can say that what has changed is this and that this is why you have to pay back or it is why you receive an additional amount.” [Project manager]

Thus instead of composing an extensive amount of letters customized to the individual combination of situations, standardized elements are designed which are then composed based on the information to the individual customer.

Organizing the process development and the construction of representations

Over time the organization has developed its methods for representing and documenting the solutions which are implemented. These representations perform important roles in the implementation process as they are the visualizations and specifications according to which the IT solutions are developed and business procedures written. The construction of these representations has been organized in a way in which line of business is responsible for drawing the desired business solution which is labeled ‘solution flows’. These flows along with detailed information on the individual activities and how the individual schemes varies with regard to the activity form the requirements from which detailed solution designs are drawn. These solution designs represent the workings of the systems and how different

domains interface to perform the process. A solution architect explains the relationship between solution flows and solution designs this way:

“In principle the business processes which line of business has drawn are basically implementation neutral. And method wise we have had a development in the house which started with us wanting that for each solution flow, that is the business description, there should be like a one to one match to a solution design. We wanted very much more or less to connect them physically so that you could imagine in a presentational tool that you would double-click on a business process so that you could go to the corresponding solution and by the way preferably click onwards down into the solution. Maybe even down to some implementation details. That was anyway our vision. That linkage has broken.” [Solution Architect]

The construction of the representations is itself a long process of translating ideas for potential solutions and determining current and potential business requirements into something on which agreement can be made. It is thus a process through which different ideas are introduced without necessarily ending up in the implemented solution and in which ideas are challenged by details which can delimit their feasibility. Initially a catalogue of ideas was developed through interactions between process developers and staff from line of business. The catalogue outlined a range of problems with the current process design along with considerations of potential benefits of different solutions and the type of effort required to achieve a solution. Based on the catalogue considerations were made on a more detailed level resulting in the drafting of decision papers presented to management for making decisions on which elements to include in the development and implementation.

A central focus of the process redesign projects is the standardization and reuse of process components across services. Furthermore the redesign involves an explicit focus on improving the level of service provided to the customers. This involves both improvements in the information provided to end customers as well as offering alternative communication channels. One element in achieving this is the reversal of process flows, for instance, by automatically initiating payment of pension and subsequently only asking customers if the payment stream should be moderated, based on the knowledge that the vast majority of

pensioners will choose the standard stream of payments thus reducing the required responses markedly. The redesign of processes thus involves major changes in work design and through the use of generic standard processes components across schemes also in organizational structure.

Developing solution flows and solution designs

The construction of solution flows was thus carried out by process designers in a dialogue with employees working with the individual schemes who are familiar with the legal and business related requirements of the scheme. Solution flows are high level business process diagrams in which activities and their interrelationship are represented. The flow diagram includes decision points in order to visualize the business logic of the process. Activities taking place in IT systems are shown on the flow diagram, but the technical working of these activities is the focus of solution designs and not the solution flows.

Figure 17 Illustration of solution flow

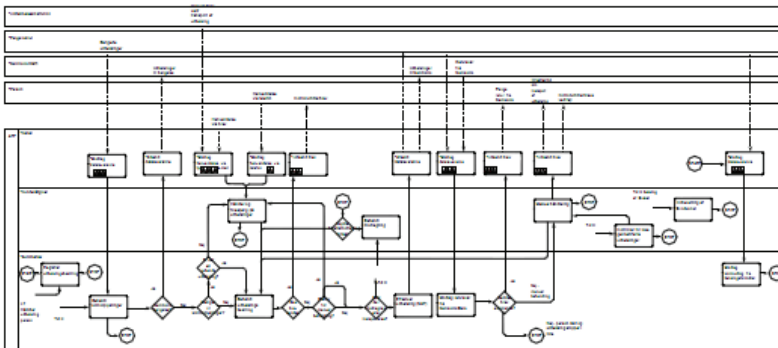

Source: Company information

In order to develop solution flow diagrams process designers maintain a dialogue with the IT architects and specialists having knowledge of the abilities of the IT applications. The intention of this dialogue is to ensure that the appropriate requirements to the final solution are put forth while avoiding setting requirements which can only be met through high development costs. The design situation is thus a careful act of balancing existing and future needs with the knowledge of current and potential solutions. However the dialogue between designers and line of business employees in some cases caused the employees to be overwhelmed by the changes suggested by the new processes, as recalled by a process manager:

“Someone like [line of business employee] down in [specific scheme] was completely run over; he entered the process too late. He has not been part of the core and letter process. He should have been on and suddenly he is completely cut off. Then he is sitting and drawing his own processes which are his world view. And then you say it may be your world view but this was how it looked. But then that is what both [project manager] and I are hired for, and their managers, to try to make them understand. But it is difficult.” [Process Manager]

The timing and form of the dialogue is thus important in order to ensure that processes are designed with careful attention to the needs of the business and at the same time reflect its intended future state.

“As process responsible what I just have to ensure is that we have everything included and that we test what needs to be tested. What I start doing is to make test scenarios on these (solution flows) and then I can reuse them. That’s why I ask ‘have test scenarios been made’, yes there have. Then I can just go in and enter this scheme so that I don’t have to make them myself. (Interviewer: So that is that you test what happens when a customer from this scheme approaches?) Yes and then test cases are made under this scheme, but that is the way that we make sure that our flows are being tested through. So in Quality Center the scenarios are found and then there are test cases attached, and then you can go in and see, just point out this scenario and then you can see, but there is only tested 90%, can we air this or is something blocking or something like that. So we get an overview that way” [Process Manager]

Based on the solution flows a number of scenarios are developed and are entered in the quality assurance application. The solution flows is an essential element in the development process as it is the foundation on which the solution design is based. As such it represents the requirements from the business to the solution and it is thus important that all requirements are included before the solution design is being developed. DK-Finance thus distinguishes between solution flows which are modeling’s of the processes from a business perspective and solution designs which focus on modeling the resulting interaction between applications. In relation to solution flows the Head of Business Solutions and Process Design reminds that:

“you have to remember that this is how we see the business, it is not the way that we think that the systems are supposed to run. We can easily subsequently redraw it because we model the business differently. That does not mean anything, it only means anything in the IT department.” [Head of Business Solutions and Process Design]

Designing for reuse

An important principle of the architecture has been that functionality is designed with an intent to reuse it across schemes.

“One of the first principles is that a group functionality is developed once, that is we develop functionality once and use it many times. And that is actually one of those which have survived in the new strategy also. So that we have domains and that functionality lives in a domain and that we have actually sharpened it a bit so that we now say both that functionality is developed once but also that domain borders have to be kept.” [Enterprise Architect]

However following the principle of reuse has implied learning for the organization as the success of subsequent reuse of functionality is dependent on how it was developed in its first instance. Theoretically this would not present a problem provided that the first development of the functionality was able to take into consideration future uses and document and test it accordingly. However as the Head of Business Solutions and Process Development points out, it has not always turned out this way in practice:

“But I think fundamentally we have learned something, and that has been an unpleasant learning, and that is that when you mess around in the first solution you make on a platform, then it is damn annoying to be number two. And scheme C is number two right. And the scheme that went before this one, that was just not a proper solution and it is badly made and badly documented. And the solutions you would like to reuse, they are almost un-reusable. And the worst part is almost that we did the same on our other core when we made that. There we also made the first scheme and that didn’t go so well and then we had to change everything for number two and this scheme has been affected by being hit on the financing so they have perhaps not had that much money to change it. But that reuse is a damn good thing,

but it is really dismal to be the ones who are allowed to reuse what didn't work the first time." [Head of Business Solutions and Process Development]

To which the Business Developer adds:

"Well there has been some times where we have said 'we can easily reuse that, which sounds really great' and we think it is fantastic that the programmers come down and show us the opportunities. And when we then get it in production then it turns out that it was a thing that didn't work" [Business Developer]

The Head of Business Solutions and Process Development mention a specific example of the attempt to reuse a broken process:

"...The dunning process we have reused and then it didn't work by the way. So 'would you like to reuse it?' 'Yes we would like that very much', and then [the Business Architect] says that she thinks that it was a good idea to reuse, but could we then not just make it work on the first scheme first, before we reuse it on the second one. And unfortunately we have had a few of those. Where if you want to have common functionality and reuse then it is really important that what you reuse is useable right." [Head of Business Solutions and Process Design]

A major intention behind the design of the process architecture has thus been to reuse functionality across the different schemes to avoid redundancy and thereby lower the cost and complexity of the architecture. However it has not been without complications to realize this principle as chapter 6 will elaborate further on.

5.2 Conceptualizing and measuring service process modularity

In order to grasp the concept of modularity in the context of service processes this section will conceptualize and measure service process modularity using the service modularity function. The measurement is intended to illustrate the decomposition of the service process and how clarification of the characteristic of components can contribute in shedding light on the structural composition and the extent of modularity. A number of studies attempt to measure degrees of modularity and commonality within physical product architectures (Fixson and

Park, 2008; Holtta-Otto and de Weck, 2007; Mikkola, 2006; Mikkola and Gassmann, 2003; Thevenot et al., 2007) as well as within manufacturing processes (Tu et al. 2004).

Table 7 Existing measures of modularity

| Authors | Method of measurement | Focus of analysis |
|---|---|---|
| Ulrich and Pearson (1998) | Product costing model based on product archeology | Product architecture with coffee maker example |
| Fisher et al. (1999) | Mathematical model of component sharing | Product design with case of brakes in the automotive industry |
| Fixson (2005), Fixson and Park (2008) | Index measures based on function allocation and nature of interfaces | Design of product architecture with cases from two industries: automotive and bicycle |
| Holtta-Otto and de Weck (2007) | Index value based on Design Structure Matrix | Product architecture with examples of telephones and computers |
| Mikkola and Gassmann (2003), Mikkola (2006) | Mathematical model based on component characteristics and their interaction | Product architecture with examples from two industries: automotive and elevator |
| Kumar (2005) | Mathematical model to measure modularity and mass customization | Mass customization strategy in manufacturing with example from the computer industry |
| Thevenot et al. (2005) | Commonality index based on product components | Product family design with case of cameras |
| Thyssen et al. (2006) | Activity Based Cost allocation to product modules | Module level costing of products with case of intelligent lighting |
| Gentry & Elms (2009) | Measure percentage of inventory managed externally to the firm | Partial modularity and performance in the Electronic Manufacturing Services industry |
| Voss & Hsuan (2009) | Mathematical model based on component characteristics | Service architecture with case from the cruise industry |

Source: Based on literature review

To capture the degree of modularity of service processes the thesis apply the service modularity function (SMF) introduced by Voss and Hsuan (2009). The SMF offers a proven method of evaluating the degree of modularity within architectures of products and services with managerial implications. SMF is a mathematical function (Equation 1) that measures the degree of modularity deriving from unique services and degree of to which the modules can be replicated across a variety of services. It has the following variables: number of unique service components (u), total number of service components (N), and the replicability factor of the unique service component (f). SMF can be interpreted as follows. The degree of service modularity varies exponentially with respect to the total number of services (N), the number of unique services (u), and the number of services families the unique services can be replicated into.

$$SMF(u) = e^{-u^2/2Nf}$$

Equation 1

SMF takes the system perspective on decomposition and assumes that the system is comprised of two types of services: standard and unique. Standard services are routinized and common in multi-site services such as those in fast food and retail industries. Unique services, on the other hand, are service elements that are difficult to be copied by the competitors in the short term, such as with the expertise knowledge of consulting firms. However, service firms (especially the multi-site, multi-service firms) should also consider to what extent the unique service elements can be replicated across services families.

The importance of the design of service delivery processes is recognized as crucial for the operational capabilities of the service provider. The SMF might provide valuable insights to process designers pursuing architectural principles of standardization, reuse and platform design. The extent to which standardized services components are used as opposed to unique components is a crucial factor influencing the degree of modularity of a system. In the case of the financial service provider, the documented and tested business services are available in a service repository, and can be readily applied across the different financial schemes. Unique components, on the other hand, are those which are new to the firm and are introduced on the basis of requirements from a financial scheme under development. As Garud and Kumaraswamy (1995) point out, “the realization of economies of substitution requires knowledge sharing and the reuse of components.” Unique components may emerge due to a lack of awareness or appreciation of the availability of standard components not necessarily due to heterogeneous requirements.

The company has been working extensively with process development and has mapped its processes on various levels. These mappings together with interviews and participant observation in process development efforts form the basis of the case analysis. The decomposition is illustrated in Figure 18 showing how each financial scheme involves a composition of functionalities which is made available to employees as well as relevant stakeholders such as end users. These functionalities comprise a number of service processes depending on the nature of the scheme and the requirements of the customer. These processes

are compiled on the basis of standardized business services which involves components in the form of information system services. For the application of the service modularity function, the level of analysis is set at the service process and business service level and the unit of analysis is the individual business service process.

Figure 18 Illustrating the decomposition of the service process architecture

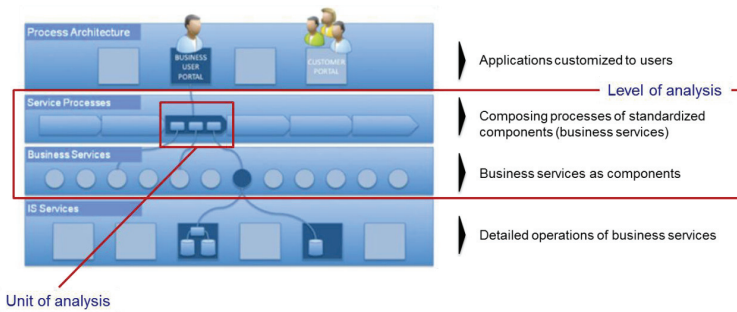

Source: based on the idea of composition architecture (Woods & Mattern, 2006) and service abstraction (Newcomer & Lomow, 2005)

In order to investigate the application of the service modularity function in the context of service processes a specific claim handling process within the case company was chosen for analysis. A simplified mapping of the process is depicted in Figure 19 which illustrates the main steps of the claims handling process. Figure 19 also illustrates the decomposition of Figure 18 in which individual process steps are considered as the component level and the module level consists of sequences of process steps. Two module level structures are selected and evaluated at component level in order to evaluate their structural composition based on the service modularity function.

Figure 19 Identifying the elements of a modular service process

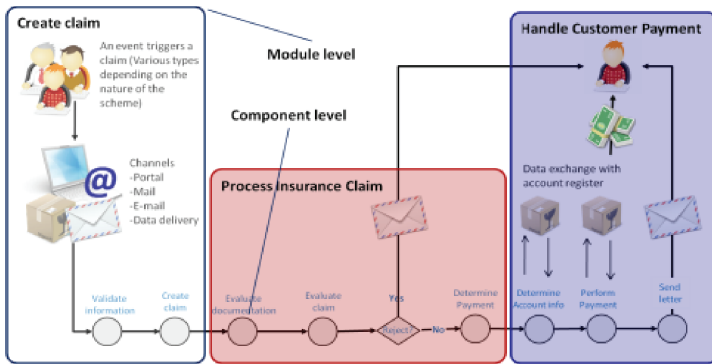

Source: Based on company information

The processes from which services are configurations are broken down according to the layers of the architecture are designed at a high level to be generic across schemes. A simplified example of such as process of evaluating claims is illustrated in Figure 19. The actual mappings of flows are designed and documented using the Business Process Modeling Notation (BPMN) to visualize activities and decisions. Underlying these higher level flowcharts are descriptions and policies explaining the fundamental business aspects of each activity and decision. Most processes involve ICT systems and activities are thus broken down into lower levels for which detailed BPMN diagramming is used to specify the detailed workings and information flows. This level consists of various Information System Services which in some cases are automated and in other cases involve interaction with staff and customers.

Much attention is paid to the standardization of process components and to the intention of reuse across the different financial schemes provided to customers. The processes of the company vary in their characteristics leading to differences in the choice of degree of modularity. However ensuring appropriate degrees of reuse of standardized components is challenging for the designers and managers and influences the enforcement of architectural principles. The reuse of standardized process components requires that these are documented

and made available. This however poses challenges as one of the company's Information System Developers explains:

“Surprisingly documentation is one of the first elements to be dismissed when you are having trouble meeting a deadline. And then you lose the investment it actually is to create a SOA environment for what if you cannot reuse” [Information System Developer].

Another important aspect in realizing the benefits of reuse is that it requires the developers to actively identify previously developed components:

“Even if you can reuse, you may never find out, if the fastest thing is to build it yourself instead of starting to search for it you just create a new one. Then you also know that it will fit” [Business Process Developer].

Figure 20 Illustration of decomposition of process

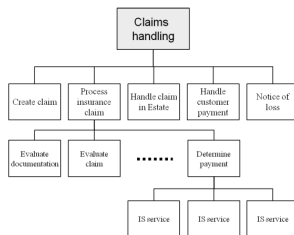

Source: Based on company information

As described above the process architecture can be decomposed in order to evaluate the level of modularity of the service processes. As illustrated in Figure 15 the company has been trying to redesign its processes to be applied across its range of financial schemes enabling service configurations. This involves the reuse of service process flows which, however, on the business services level can be customized as some financial schemes require unique business services. Figure 20 illustrates this composition of service processes based on components. In order to estimate the SMF at the service process level components are identified as the business services. These services are further evaluated on the basis of standardization and uniqueness. Replicability is considered in relation to the ability to

replicate unique components across the range of financial services. Data on the individual components was collected through investigating the company’s process model and by discussing their characteristics with company employees responsible for the process. Table 8 lists the components of the two modules of the service process depicted in figure 18 and corresponding to the third level of figure 20.

Table 8 Elements in the service modularity functions

| Elements of calculation | Process Insurance Claim | Handle Customer Payment |
|-------------------------------------|-------------------------|-------------------------|
| $SMF(u) = e^{-u^2 / 2Nf}$ | 0.66 | 0.83 |
| <i>N</i> Total no. of components | 10 | 16 |
| <i>n</i> no. of standard components | 5 | 10 |
| <i>u</i> no. of unique components | 5 | 6 |
| <i>f</i> no of service families | 3 | 6 |

Source: Based on interviews with company employees

The table depicts the variables relevant to calculate the service modularity function for the two service process modules of figure 19. The table shows the total number of components of each of the two modules as well as how they can be divided into standard and unique components. Furthermore the table shows that the module Process Insurance Claim is used across three service families whereas Handle Customer Payment is used across six service families. This in combination with a lower percentage of unique components implies a higher level of modularity compared with the Process Insurance Claim module.

Figure 21 Service modularity function for the two analyzed processes

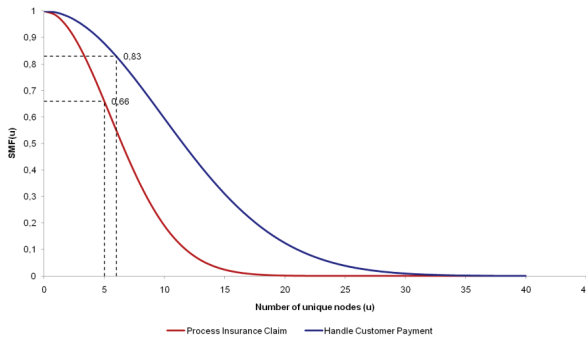

Source: Based on company information

Figure 21 depicts the service modularity function for the two analyzed process modules. The level of modularity depends on the course of the service modularity function as well as the number of unique components. These are depicted along the horizontal axis of the graph and as the number of unique nodes grow the level of modularity falls according to the service modularity function. The difference between the courses of the two functions depicted in Figure 21 result from the different structural compositions of the process modules as indicated in table 8.

As discussed above the company is attempting to design its processes with the intent to maximize the reuse of service process components across its range of financial services. In the application of the specific process across a number of financial schemes, variety however is caused by specific characteristics of the individual financial services. The application of the service modularity function thus indicated a number of tradeoffs that need to be considered when redesigning the service system. For instance, reusability of processes does not appear as simple as management believed to be, even when they are standardized. As illustrated above decomposing the service process architecture and identifying the relevant concepts for measurement provides the basis for application of the service modularity function.

5.3 Chapter summary

This chapter has provided an introduction to the case company and its approach to process design. Particular emphasis has been on the way in which process designers have been attempting to standardize and reuse components across the architecture in accordance with the architecture principles. Based on the representations of processes and interviews with employees the service modularity function was applied in order to evaluate levels of modularity across two specific processes. This showed that the payment process was more modular than the claims handling process, an observation which is in accordance with the perception within the company. Whereas the payment process is indeed considered plug-and-play compatible the claims handling process turn out to present more challenging for the efforts to standardize and reuse. The next chapter will go further into these challenges and the consequences they have for the performance of the architecture.

Chapter 6 Problems and dilemmas

The preceding chapter described the intention of the new enterprise architecture to enable the composition of financial schemes on the basis of generic process modules constructed of components from a common application landscape. The intention was to enable scale economies through the reuse of components across schemes and to lower the time to market by enabling fast configuration of standard components. In the previous chapter the service modularity function was subsequently applied to the claim handling process on the basis of information on the characteristics of individual components. The function revealed that part of process could be considered more modular than other parts of the process. This partly reflects that the payment of claims is less challenging to generalize than actual processing of claims. However it also reflect that the design and implementation of the architecture has taken place over a number of years in which some components have gradually become standardized and reusable across schemes, while others remain unique. The development of the architecture has involved a number of projects through which individual schemes have been migrated from the old architecture to the new architecture being constructed. In this process a number of unexpected and unintended consequences emerged which have required the attention of the company. This chapter presents and analyzes a number of problems which have been experienced in the case company through the transformation process which they have undertaken during a number of years. These problems present management with dilemmas and suggest that modularity is not a solution without its own inherent challenges.

6.1 The emergence of unexpected and unintended consequences

This section will discuss and analyze problems which have occurred during the development of the architecture and resulting from which corrective actions have been taken. Firstly, deviations in the realization of the architecture vision are discussed based on the experiences of the Enterprise Architect. Secondly, the fear of unintended consequences turns out to be an important explanation in relation to reuse of components. Finally the section discusses elements of the development process and nature of the schemes which contribute to the emergence of unintended consequences.

6.1.1 The architecture vision and realization

As discussed in chapter 5 the case company embarked on a transformation journey through which the enterprise architecture was to be fundamentally changed. The new architecture was intended to be based on principles of service oriented architecture involving loose coupling between applications through orchestration of defined services. However the process of moving from the architecture vision to an implemented architecture did not turn out to be without detours as unexpected technical challenges resulted in significant changes to the implementation. As the enterprise architect explains expectations were in place with regard to the technical solution:

“We expected that 80-90% of all case work was to take place through portals. That is, we expected that we were to have a portal across everything so that you didn’t see which backend systems were there. That was the vision. Workflow was to control all end-to-end processes, everything was to go that way around and you would be able to see when an operation had been performed then it would turn up in the workflow. All communication between domains were to be 100% synchronous and SOA enabled, we expected. We would have clean domains without redundancy in the respective areas.” [Enterprise Architect]

However although this was the vision of the architecture it turned out not to correspond exactly to the implemented solution. Quite to the contrary the use of portals and workflow would only be used to a minor extent due to the difficulties and cost of the attempt to keep with the architectural vision:

“20-30% of the casework takes place through portals we estimate and not the 80-90%. [The rest is performed] in backend systems. Workflow has been implemented very ad-hoc and mostly as placeholder for notifications and as in-tray. All communication between domains is done SOA like but is asynchronous” [Enterprise Architect]

These deviations from the vision had major implications for the development and implementation of the architecture as a solution architect explains the ambitions of the architecture took a dive with the realization that the vision was too ambitious and would not be possible to realize as expected:

“It has been a major process that we have been through. Starting very high perhaps and then dived very low from the target, and now the pendulum is approaching the middle again.... (Interviewer: And the great dive what was that?) The thing about ok we don't change all user interfaces to self-written websites, we can't handle that no. So the dive is there, when we decided that 'ok we use the interface from SAP' even though it is not service enabled, even though it is not service oriented and even though you from those screens cannot actually call other systems. So we have found a way of working with it anyway.” [Solution Architect]

This transformation was described to be a struggle between those maintaining a belief in the vision and those who realized on the basis of the progress being made that it could not be achieved successfully. This struggle was set between:

“One wing in IT, hardliners which wanted the SOA landscape run through, and then some others which could see progress figures which were completely red. And if you have an architecture department which says that it has to be so to the developers and the developers listen, then you have to force something through. So we closed down our architecture department in 2007 and we kept part of the drawings and then we have reestablished, what should I say, the compromise that is running now.... But the compromise we have reached, that the surrounding world has chosen to reward us with an SOA price. I don't remember when we got it, if it was actually 2007 or when it was. But this way of using backend systems as SOA enabled partners in a SOA landscape, which has worked for us.” [Solution Architect]

The struggle to decide whether to maintain the vision of implementing a full SOA landscape was fought between those who believed to see the lack of progress implicated in following

the architecture principles, and those concerned with ensuring that the architecture lived up to the agreed vision. The struggle was thus caught between the desire to ensure the long run performance and adaptability of the architecture versus the concern for the current progress and short term completion of the projects. This led to a realization that the implementation of the architecture could not be carried out as expected when the architecture was first developed, rather the architecture turned out to be filled with technical compromises but still retaining the idea of loose coupling between services as explained by a Solution Architect:

“So we have made such a kind of conglomerate but off cause it is important for us to maintain that we operate on services and that the SAP machines are not allowed to call each other across domain borders. So what actually seem crazy to a SAP person is that we step up on a logical level and down again to come from one SAP machine to another which you could get for free if you just plugged a wire between the two SAP systems, ‘just say what you need to each other’ in SAPs internal formats. So there we have some normative confrontations once in a while because the SAP people don’t think there is anything else than SAP in the system so they think that we solve everything with SAP.” [Solution Architect]

Despite these conflicting perceptions he believes that the company has been able to strike a balance and succeeded with remaking the architecture:

“That balancing act we have made enabled us to do this. There are not very many who have been able to do a remake of their IT landscape in a SOA picture.” [Solution Architect]

In conclusion the architecture vision did not turn out to materialize in exactly the way it was initially planned and the journey undertaken was full of surprises and disappointments. However an architecture emerged in which the company did in fact go to great lengths to reuse components as the architecture was gradually developed. Nevertheless this reuse of components was in itself not without problems and the next paragraph will go into more details on some of the unintended consequences which were experienced in the wake of such reuse.

6.1.2 The fear of unintended consequences from unanticipated interdependencies

The criteria of dependability turn out to play a large role in the implementation of the architecture and the fear of unintended consequences arising as a result of unanticipated interdependencies is present in the design:

“The nightmare is that we change something in some little service which means something for a letter without checking the six other letters which are also using this service. And suddenly we are on the cover of Ekstra Bladet [Local tabloid newspaper] because we have written to a pensioner that she can have 13 million in pension next month and for the rest of her life. So that is the kind of caution that causes to behave in this manner. And it is possible that you have to do so if you have a large reuse of services. Even though we can delimit ourselves broker vice for it so that you operationally don’t have to intervene in source codes of these systems which are requestors you still have to test that they can continue their lives.” [Solution Architect]

This created the paradoxical result that the architecture which was founded on the idea of simultaneously realizing economies of substitution through component reuse and agility through recombination of loosely coupled components was able to realize this only when supported by a number of coordinating mechanisms.

“But you can have a service repository where you can put some kind of governance on top of it and we don’t have that yet, but we talk a lot about having one as this is becoming more and more complex. And we have to be careful about these service operations and how they are developing and whether they are reused and that we don’t get some that resemble each other and which one is subscribing to this one. So there are many issues in this and so I think that is the next wave of standardization” [Enterprise Architect]

Importantly these mechanisms of coordination in turn imply that some of the flexibility and agility to which attention was initially put has been sacrificed to ensure predictability in the development and implementation of changes. As the solution architect note the sacrifice of flexibility is not an inherent feature of the architecture, but what he labels ‘the bureaucratic circus’:

"It is mostly for the sake of the bureaucratic circus that we have had to sacrifice some flexibility... Because there are no conditions in the system or in our method or in our development facets which prevents us from sitting down today and writing this correction to that letter and implementing it in fourteen days. There is nothing preventing that" [Solution Architect]

An important part of this bureaucracy is the release structure which all of the schemes have to follow when changes are made to the system architecture. The release structure is closely related to the testing activities taking place as part of each release. Although the notion of time-to market appears to be an important elements of flexibility there seem to exist a tradeoff between time to market and risk, in which under some conditions risk is more critical than time as Manager of Process Design explains:

"For our group customers the decision makers are often politicians and for them the criteria to a large degree depend on whether we are actually able to perform, because if we can't then they lose their seat. So there it is not just a question of the cheapest or fastest solution" [Manager of Process Design]

Furthermore fast responses can be shortcut by designing work around solutions which however are not viable in the long run. Therefore it appears that response flexibility can take various forms:

"You can always achieve a short time to market; it is just a matter of putting it in Excel or to make an Access solution. Flexibility must be a matter of building it in. Our platform must be able to support new products for our existing customers ultra-shortly. [Name of customer] is a good example we must be able to support that within three months" [Business Architect]

The tradeoff suggests that the conditions under which it will be beneficial to invest in flexibility have several dimensions and that flexibility itself can assume various forms depending on the objective. However the reuse of components is fraught with the risk of creating adverse and surprising effects, as the Head of Business Solutions and Process Design explains:

Unfortunately we have realized that if you in example reuse a component in SAP, then when you copy it you can accidentally not change something or change something too much so that

you actually also change something where you copy from. And on that account regression testing is quite important, because they did it in the dunning process, that they had copied something over in the new solution and then they were not aware that it also impacted. When they were then adjusting the new solution it impacted on the old and then the whole trouble was on again. [Head of Business Solutions and Process Design]

This risk of system level effects of component reuse on schemes in which the component has previously been incorporated thus present a case for elaborate testing to ensure that no adverse effects occur due to component reuse.

And that is what we call our platform right. And that is what you need to regression test. We are running at the moment, we make changes twice a year, and we are running this weekend. And it is a rocket where you are starting all the way down on component level and then go all the way up and end with a co-existence test if that is what you have to have. And that process you have to have, that is the price for SOA and that is then overly complicated by us having many companies in one I have also found out. [Head of Business Solutions and Process Design]

However the introduction of elaborate testing procedures tended to reduce the flexibility of the architecture toward local changes which are met with the same requirements for testing as major changes. However the platform maintains flexibility toward major changes which are supported by the reuse and the standardized procedures:

"It gives... I don't think that you should undervalue, that a solution such as scheme C or B, our time to market is actually really really god. On gigantic solutions. We can make a gigantic solution in two years, others can't do that. They have to spend four, five years.... In return we can't do anything in less than a year. That is we can hardly make a change to a letter. We can't get a small idea and then say 'well yes what if all foreigners were to receive payments in cash in the café or something' can we just make that small change. Ohh no, yes about nine months, if you are really quick in this house. And that does give some trouble because the small tasks are usually the ones which take up a lot of attention because there are many of those. So the rumor can quickly have it that it is a crappy platform. Well yes, it is big,

but our time to market on the really big ones... We can go out and make a proposal on an entirely new solution to [name of potential scheme]. We will be able to take over that and implement it in less than two years. That is actually, no one else is able to do that. But we can bloody not change a small corner, we can't" [Head of Business Solutions and Process Design].

So the paradox is that while the platform enables large changes to be implemented quickly compared with competitors, then small changes thought to be straight forward to implement turn out to require a lengthy implementation process.

"Now we are talking components down in SAP where you could have a fundamental assumption that the geniuses that are sitting and doing SAP they would know. That when you want to reuse ZIBR224-4 then it is because it is running already. So yes it may be, but I don't think you can sit down and make red, yellow and green lights down to SAP transactions, but that is basically where the trouble is. They want to reuse transactions which it turns out, that we can't figure out how to use in the first place.... And that is because SAP is theory land right. Really, there is a difference between theory and practice and in SAP there are a lot of SAP people who know a lot about which things you can connect in theory, but when it needs to go into a reality which is that we don't only live in SAP, that it has to be able to reconcile with some other systems or that it has to be able to make letters, then the world becomes really complicated. And that is where SAP perhaps doesn't have its force, to be in communication with the outside world." [Head of Business Solutions and Process Design].

As noted by Garud & Kumaraswamy (1995) there are costs associated with reuse, one of which consist in the risk of lower performance from reusing components which do not function in the new context. The risk mentioned by the Head of Business Solutions and Process Design is very real as it present a significant challenge to the project team to include components which are assumed to be working but turn out to fail when put into reuse. As can be read from the statement such experiences lowers expectations for future reuse of components and raise the need for testing.

6.1.3 The sequence of the design process

As described in chapter 5 an important aspect of the development of solution flows is the dialogue between process designers and line of business in order to ensure that the solution flows constitute an appropriate foundation for the requirements for the final solution. As the Head of *Business Solutions and Process Design* explain, this is not always the case, and she explains how this had consequences in relation to the development of a scheme C:

IT were pretty quick, but that was then a resource issue right. The put in the resources to early in connection with drawing the technical solution so we had not drawn the business solution when they drew the technical. That is a traditional mainframe approach right. Here is the system, it is so and so and that is what you can get. Then you are not allowed to spend the money twice drawing a new technical solution. That gave some trouble. [Head of Business Solutions and Process Design]

As a consequence the dialogue with business was restricted with the solution design already in place which suggested central aspects of the final IT solution to underpin the process design. With this in place more fundamental business requirements were locked and consequently remained out of scope. Furthermore a challenge is that new ideas often arise through the modeling itself which is not always compatible with the models place in the development process:

“When you model something then it is only ok to model it until you start to work with it, and that is what we are struck by all the time. It is the thing about getting new exciting ideas when you are modeling. Because those who model frequently get new exciting ideas, that is actually what they are most good at. The thing about not getting ideas that is quite hard. And it is quite difficult when you go in and use this as the foundation for an entire development process. We test on the basis of this. Once you have been in production which you have tested, then you need to be able to retest, then it is no good if you change it. You constantly have to keep a documentation of what you've done because that is what is in production and it is actually what you have an agreement with your provider that they need to maintain. So you get a schism which is new and old, how do you maintain several generations of the same. And that we have had to learn along the way.” [Head of Business Solutions and Process Design]

6.1.4 The variety across schemes and the difficulty of generalizations

A critical aspect of reuse is the ability to generalize processes to allow the same process to encompass heterogeneous requirements. The difficulty arises as generalizations at the same time reduce the ability to meet the specific requirements of the individual scheme and require more time for development. The challenge of generalizing, which in some cases makes reuse difficult, is the specificity of the individual schemes. Although the schemes are either pension or insurance like, variety across the schemes does exist and it sets different requirements for the process design. On abstract levels of detail the specificity of the individual scheme can remain hidden but when detailed specification is required it emerge as described by a solution architect:

“Once we get down on the IT side, then there are some variants which means that there is not exactly a 100% match. In theory there is a pretty good match and everything looks fine, but then we go down under the hood and see that this scheme varies a bit. And that is about where we are also with this scheme.” [Solution Architect B]

The variety of the individual schemes implies that although it is possible on an abstract level to reuse entire processes as modules, most often there are subtle differences in the way that the individual scheme operates which necessitates specific changes to be made. Consequently it is often components of processes or component interfaces which are reused rather than entire processes. Furthermore the requirements set ‘under the hood‘ also implies that in some situations it is necessary to change a component in order to enable it to be reused on a different scheme, simply because the new scheme sets different requirements not anticipated when the component was first developed.

6.2 Chapter summary

This chapter has analyzed a number of challenges which have been encountered in the course of developing the architecture. While some of these challenges relate to technological expectations which turned out not to prevail, others are directly linked to the intention of standardizing and reusing components. Interestingly the reuse of components across multiple processes and financial schemes has the implication that in some cases they have compromised the trust in system level performance. This is caused by the experience of changes at component level having cascading effects. As such a risk is not tolerated in the organization; initiatives were put in place to mitigate such effects. These initiatives will be the topic of chapter 7

Chapter 7 Control mechanisms and coordination

Based on the identified challenges discussed in the previous chapter this chapter suggests the ways in which managers and designers have attempted to mitigate the unintended consequences and problems following from the application of principles of modularity. A number of control and coordination mechanisms have been established in order to counter some of the problems occurring. These mechanisms however are not neutral in the sense that they have their own effects on performance objectives and in consequence result in the paradoxical effect that while solving some problems arising as a consequence of the modular system, they at the same time influence objectives by introducing rigidities that undermines the flexibility which was initially thought to be compatible with other objectives.

7.1 Results controls through budgets and business cases

Throughout the development of the projects an important reference point has been the initial improvement catalogue which was developed before the implementation began. In collaboration with line of business process designers tried to identify opportunities for optimizing the individual processes to realize savings or improve service quality. This process resulted in a catalogue of improvement opportunities which were further scrutinized during the initial project development to arrive at a business case specifying the intended changes to the process as well as the expected costs and benefits from this. The approved business case formed the baseline for the subsequent scoping of the projects thereby setting the financial limits to the individual project. The project budget thus acted as the frame in which the individual projects could navigate and thereby set boundaries for project activities.

While this is a natural and important role of budgets the question in an organization which seek to promote standardization and reuse of components is that as it is often costly to develop a reusable component, which project should bear its development costs. Likewise an important question is which project should bear the cost of reworking a component which fail to be reused. There did not seem to be clear mechanisms to allocate development costs of common component across projects. Consequently there was little first mover advantage involved for projects including new technology and developing new components. This paradoxically has the effect that while working to control the cost of the individual project, there is a risk that overall architecture principles can be discouraged.

7.2 Action controls through administrative procedures

In addition to installing results controls a number of action controls were established in the form of administrative procedures to govern projects and changes made to the architecture. These will be elaborated on below.

7.2.1 Release structure and testing

In order to manage changes made to the system architecture a release structure was implemented to ensure that proper testing were taking place before changes was being implemented in production.

“Once a scheme has been implemented on the new platform then they will enter a release structure with two annual releases where new functionality can be added or where you can change what you want to change. And when Peter is putting the next one on then it also enters the release structure in the two annual releases, for better or worse” [Enterprise Architect]

The consequences of the platform design was that it became relatively easy to implement a new scheme on the platform as long it was relatively similar to existing schemes because of the ability to reuse components. But at the same time component reuse across schemes increased the need for testing when changes to components were required. The testing requirements increase the cost of making even minor changes to existing components and cause a quite lengthy process. To manage these changes they were included in bi-annual releases of new versions of the architecture which from a business perspective implied that even small business changes would be part of major implementation projects. Factually changing a service is a minor thing, provided that it works without having unintended effects. This provisional statement is important however as it raises a concern which have major effects.

The concerns for agility of the architecture require trust in the specifications made and the ability to anticipate in advance any adverse consequence of even minor changes. This concern was met with concerns of the risk of failures at the system level. “What happens if we add this particular field to this particular service which we have reused extensively across our platform?” – “Could it result in us ending up sending a collection request of several million DKK per month to a pensioner which would bring us on the front page of the tabloids?” We better test that what worked before we changed the service also works after the change, just in case.

The technological promise of agility conducive to change was thus met with the concern for stability and predictability. Modularity of systems thus requires an ability to anticipate in advance the necessary interface specification to contain what would otherwise be system level effects to modules. The inability to contain such effects thus entail a risk that component or module level changes propagate to system level effects. As noted by one Solution Architect:

“That there have been too many bugs in connection with launches has been the observation that has been made. And we have been attempting to counter this by setting this entire administrative hell in motion. I don’t know if it was the right thing to do but we have in any case done a lot to launch less frequently and gather in what we call releases and then you can achieve a testing of it in a reasonable way. And that is then very expensive to do, while we in reality also have 1.000 problems when trying to change three or four things at the same time in such a system as this, then the testing burden can become quite large” [Solution Architect]

So while the release structure has the implication that changes are made less frequently it at the same time has the consequence that many changes occur simultaneously which make it more complex to test the effects of these changes.

“It is possible that we have gone too far in establishing a bureaucracy to ensure a quality in the deliveries. That there is simply too much bureaucracy. You have to have what we call gate passage which is a governance thing where you say which projects we have, which projects we then want to launch and which are on hold and that kind of thing. So the projects have to for instance deliver drawings like these [BPMN 2.0 process flow documents] before they are allowed to go to green gate so that you can prove that we are in control of what we are developing and then are allowed to start. And quite a lot of paperwork has to be done and test plans and test managers etc. And that costs” [Solution Architect]

The bureaucracy thus place major requirements on the change projects which ultimately involve a cost for the design. A business developer explains how she has difficulty explaining these costs to line of business:

“But I experience how I have to defend how it can be that it cost xx million to add a scheme when it is just reuse. That is because it is not just reuse and because it is not ‘just’. It is also

testing. The whole test assignment when you reuse is massive exactly because you reuse.”
[Business Developer]

To which the solution architect adds *“Exactly because you reuse you have to do a lot of regression testing”*. [Solution Architect]

It is interesting to note that these costs arise not because the architecture principle of component reuse is not followed, but exactly because it is so. Thus component reuse resulted in unintended consequence of failures and fear of such which prompted a need for establishing testing procedures. These procedures are working to increase the dependability of the architecture but are themselves producing the unintended consequences of stifling the ability to make changes.

“In reality it is right and we are also ourselves a little disturbed about the costs for us. And we have possibly put in place too large a bureaucratic system. You can hardly do a database transfer which ought to be a very minor issue without having to appoint a test manager and write test specifications and VBT’s. That is it has become a bit rigid for us. In order to raise quality we have instated a large bureaucracy which we are suffering from” [Solution Architect]

The changes which necessitate testing are related to the IT services and how they are implemented in the applications. The challenge is that instead of only having to test on one scheme it is necessary to test that all of the schemes which are using a particular service are still functional after the change. The testing associated with a change is thus increased and thus become a growing workload as more and more schemes use the same services.

“If we alter in the backend implementation of a service, even though we say that the existing systems can still run because they don’t receive any new data, you have still altered the implementation. So basically you have to demonstrate i.e. by firing some existing test cases which you had when this was developed in order to show that your calculations are still providing the same results. But it has to be done and it is a cost which you have to accept when you want ‘one organization - one system’ ... Then you are living together and as we are

adding more and more schemes it is becoming apparent for us that here is suddenly a drawback for us with a lot of tests” [Solution Architect]

The Business Developer describes how the whole architecture is perceived as inflexible as what the business consider minor changes i.e. to a particular letter quickly turns out to be considered a major change which has to follow the release cycle and testing requirements:

”But that is one thing that is flexibility in the schemes that are already running, if there are changes then it is not experienced as flexible you have to say.... An example which you would think to be simple was a letter that have to be changed where a new variable needs to be included, that is new functionality. In principle that has to be introduced in one of the biannual releases and then you are standing there with a customer advisor who has a letter ‘is just have to say, it is in the system, it just have to go there’, yes but you have to announce it in due time before these releases and then there is almost a year until you can have this letter implemented. Of course this is not true if there are legal requirements then we will implement it somewhat sooner. But it is clear that flexibility if we have to comply with the bureaucratic circus that is...” [Business Developer]

The logic as she points out is clear:

“The argumentation is rather clear in that letter, there has to be fiddled with a service to get this extra figure up in the letter. When you fiddle with a service, then there may be someone else using it, then we have to regression test it. We only regression test in the bi annual releases, we don’t do that in the monthly releases. So it is to ensure quality. You can then discuss whether you achieve that in the individual specific incidences, but again if there is a legal requirement then we would have applied for exemption and then it will be in the monthly release and then you take the risk there is.” [Business Developer]

Thus while it is possible to apply for exemption in the case of changes to the legal requirements to a scheme the general case is that any change to services is to be treated in the bi-annual releases.

“Once in a while we observe that we form what is called task forces, which are autonomous projects of relatively small groups, eight to ten people I would typically think. And they are independent of releases and they are typically being given assignments to which a quick response is wanted and they then test and implement it. So to the extent that the business can agree and there is sufficient power behind a need then we do solve it around these releases”
[Solution Architect]

7.2.2 Integration contracts

Another coordination mechanism is the establishing of contracts which govern each integration between domains. As a project manager explains this procedure was established as the complexity was increasing with a growing number of integrations in which confidence was deteriorating:

“There is a contract for each integration. We have simply had a department who have been making those, or a team. And we have actually spend a lot of efforts on that because in the beginning they were just supposed to agree and it just sailed. Then [Name of individual] together with some people were asked to get it under control and it has actually been a full time job since then.” [Project Manager]

To which the Enterprise Architect adds:

“I think there were five man working on this at one point. And there is a system integration policy as a basis for it. And the integration contracts are drawn on the solution designs, that is when you have a solution design you can see the integration contract itself between two domains.” [Enterprise Architect]

Each integration contract specifies how information flows from one system domain to another and the responsibility for setting up the appropriate integration contracts has been assigned to the individual domains.

“Fundamentally I am responsible for in/out (domain for handling payments) having an integration contract which is in place and that they have documented it, but they still have to carry it out. It is as mentioned fundamentally on the integrations. Domain tests usually go

very well, but when we then have to do integration tests then things come crashing down.”
[Project Manager]

Interfaces are thus essential and vulnerable spots in the architecture and in the eyes of one of the solution architects the interfaces are in effect what are primarily reused:

“And then we off course try to reuse as much as possible, and reuse to me is. To the business it has a lot to do with us reusing the entire process, like the payment process which we reuse completely. Reuse to me is to reuse our interfaces so that we reuse the XML structure the XSD we are sending between two systems.” [Solution Architect B]

The risk is that what falls between the domain boundaries often have a tendency to be ignored and consequently result in problems later on.

That is very much my take, that here (in regard to integration) we have some reuse and then we off course have some functionality in the domains, but that is actually more the responsibility of the domains that we reuse there, so that is the project manager on the individual domain, the domain architect. I am a solution architect so that means that I have a focus on the interfaces, I focus on the division of work between domains. That nothing falls between. In this SOA landscape that suddenly someone thought that IDA (domain for handling stakeholder information) that it was a part of 'stakeholder' and in reality then it should have been part of 'Core II', so that nothing falls between two chairs.” [Solution Architect]

In order to facilitate the reuse of integration contracts they consist of two parts mediated by a broker which handle the actual run of the interfaces.

“You simply use the same integration contract or the same format. It is so that we have supplier contracts. Any integration here consist of a provider contract which is the providing domain, that is rather important to understand in relation to reuse, and then it consist of a user contract which is the using domain that is. You can say that the user contract we have to reuse for different users, whereas we make a specific provider contract for each domain and then we enter a queue into our service bus.” [Solution Architect]

7.3 Personal and cultural controls through standardized methods

Finally it proved important to establish common norms around the methods used during development. This was partly due to the number of different parties working on the same project with each of their own methods of documentation etc. However it was also due to a realization that documentation is crucial when design is undertaken with an intention for subsequent reuse. As the enterprise Architect notes, there was a lack of common methods which have impacted the process of development as:

“We also have to learn that we are not all going to be artisans. Especially when you are working in a SOA world, then you really have to, it is no use that I would rather do integration contracts in this way, no I would rather do it this way. It simply is no good. We have to have these common rules of the game in one way or the other. So that I think is a learning, and I think it is going to be difficult” [Enterprise Architect]

As the solution architect point out some of the IT vendors have their own methods of describing and documenting aspects of the literature. A specific example is the integration contracts which as discussed above are considered a crucial aspect of the architecture. In consequence integrations are documented twice using two methods which result in an extra layer of documentation with the risk of inconsistencies:

“And then SAP and Core II found out that they didn’t want to work with our integration contracts because they don’t know those in their development model. And we sort of bought their development model when we bought their standard system, so they work with something that is called IDD’s (Interface Detailed Definitions), so there is a link between IDD’s where they describe their interfaces and our integration contracts. (Interviewer: What does that mean in practice?) In practice it means that there is some double entry bookkeeping. That means that people are speaking in different languages so that the SAP developers sort of speak in their own language and if we need to have something through our broker then we need to speak another language with them. So just very inappropriate. There are no other domains other than in/out and Core II which work with IDD’s. It is difficult for in/out and the

cores because it is really a lot of documentation which is in the IDD's and ADD's" [Solution Architect]

7.4 Chapter summary

This chapter has discussed how the case company in the process of developing the architecture have used and developed a number of different management control mechanisms as a response to the problems arising due to unintended consequences during the development of the architecture. While these management controls were intended to ensure the development of the architecture without risking 'catastrophes' from unintended consequences they have also had an impact on the performance of the architecture and the efforts to modularize through standardization and reuse. This is an interesting finding as it is often assumed in the literature that modularity provides embedded coordination why little attention is given to the coordination mechanisms needed to develop the architecture in the first place. These mechanisms are in line with the suggestion of Garud & Kumaraswamy (1995) and it is interesting to find that they have implications for the architecture which warrant further investigation.

Part III
Conclusions and Discussion

Chapter 8 Conclusions

This thesis have discussed and conceptualized the variables mentioned above within the context to a claim handling process of a Danish financial service provider. The company has been attempting to design its processes with the intent to standardize and reuse service process components across the range of financial services it administers for its customers. In the application of processes across a number of financial schemes, variety however is caused by specific characteristics of the individual scheme. The case study thus indicated a number of tradeoffs that need to be considered when redesigning the service system. For instance, reusability of processes does not appear as simple as management believed to be, even when they are standardized. This thesis contributes to existing literature in operations management by suggesting a way to measure the structural characteristic of the service process architecture and thereby provide designers with reference points in the design of processes to evaluate the consequences of different design options.

The case study provides the basis for application of the service modularity function within a specific empiric context through decomposing the service process architecture and identifying the relevant concepts for measurement. The thesis thus provides the basis for further estimation and evaluation of the degree of modularity embedded in the service process architecture and provide insights into how management and researchers can conceptualize the complexities of service processes into measures so that they can be monitored and controlled. Assessment based on the service modularity function may thus provide managers and process designers with information for evaluating the degree of standardization and reuse across the process architecture. Such information together with simulation and analysis could prove to be useful for the design decisions involved with process development

Based on the conceptualization of the modularity of service processes the case study also revealed that the design and implementation involved a number of unintended consequences to which the organization responded by constructing a number of coordination and management control mechanisms. While these served to reduce the problems experienced in the design and implementation of the process architecture, they also impacted performance outcomes by reducing the flexibility of the architecture. The study thus demonstrate that

although service orientation ideally suggests a new paradigm for system development which is intended to increase flexibility and agility of businesses through configuration and re-configuration of existing loosely coupled components this technological change is not a substitute for the coordinating role of management. The case company initially embraced the architectural principles of service oriented architecture but in the process of designing and implementing these principles they were challenged in part due to technological considerations but also because of the realization of unintended consequences which required the construction of coordinating mechanisms to increase the resilience of the architecture and avoid the risk of system level failures due to component reuse.

Figure 22 Model of the dynamic effects of modularity in service processes

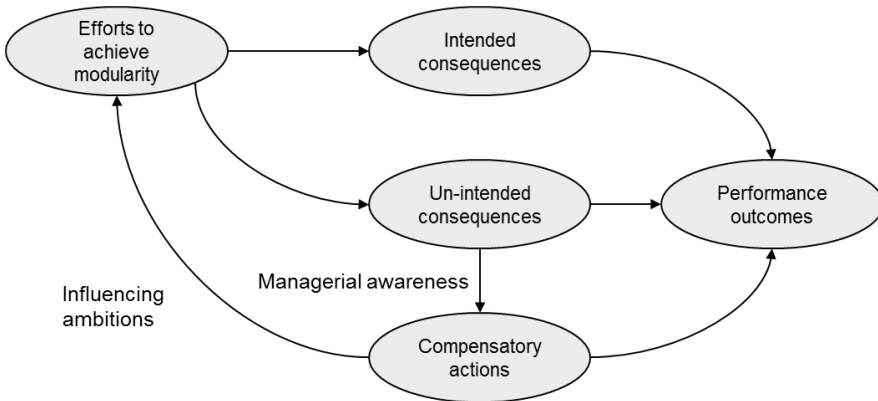

Source: Own construction based on observations from the empirical study

As discussed in chapter 2 most of the literature on modularity has focused attention on identifying types of modularity (classifications and typologies), ways of achieving modularity (product / process development), its effects on product and process outcomes (intended consequences) and the relationship to performance outcomes. Traditionally little attention has been paid to the un-intended consequences of modularity. Recently however a stream of literature has emerged which have highlighted that modularity is likely to have implications on innovation (Fleming & Sorensen 2001) and other performance outcomes contrary to expectations. Furthermore, some authors are questioning the straight direction in the

development of modularity often assumed in the literature on modularity (i.e. Garud et al. 2008). This literature suggest that in practice achieving modularity may often be more of an emergent practice as important interfaces and interdependencies often show up late in the development process. Figure 22 suggest that the relationship between efforts to achieve modularity and performance outcomes may be more complex than suggested by much of the literature on modularity. On the basis of the results from the case study presented in preceding chapters the following discussion concludes by elaborating further on the elements of figure 22.

In the case organization several efforts to achieve a modular architecture were identified in relation the development of a new system and process architecture which was intended to be a common platform across the individual financial schemes. The transformation was thus from a situation in which scheme was operating independently from each other in an integrated way, to a situation in which a platform of shared components would be used to configure the individual scheme.

From a line of business perspective this involved the creation of process components by which the organization was attempting to build and structure the processes of the organization into a decomposable hierarchy from which generic processes could be chosen to configure existing and new service offerings. A primary concern was thus to generalize processes so that they would be able to function across schemes through reconfiguration. In the system architecture IT services were considered components with the architecture build on the principle that IT domains expose services which are delimited areas of functionality that can then be orchestrated together to provide the system support needed for executing processes. The principles stated that functionality should only be built once and subsequently reused across the different financial schemes. In order to do so the architecture would contain an orchestration layer (an enterprise service bus), which would be acting to provide bus modularity, by which the individual services are used (called). The information exchanged was specified through the use of integration contracts which detail the information exchanged by the service.

In order to establish the architecture models were used extensively to capture the different views of the architecture. These representations included information models, domains models detailing their services and process models with different levels of processes.

Modularity by definition implies only limited interdependence between modules in a nearly decomposable architecture in which standardized interfaces specified a priori govern the interrelationships between modules. Consequently the process of specifying interfaces supersedes managerial coordination and provides what is designated as an embedded coordination. This allow the modular architecture of products and services to be mirrored in corresponding modular organizations to a point at which the standardized interfaces suggest places where transactions are likely to occur. Theories of modularity thus suggest that modularity is likely to result in loosely coupled organizational forms in which living up to interface requirements is sufficient to enable the working of the system.

The modular architecture enables the reuse of components through their standardization and mixing and matching thus facilitate variety without sacrificing efficiency through the economies of substitution (Garud & Kumaraswamy, 1995). From the case study it is clear that reuse is indeed thought to have enabled faster configuration of new financial schemes based on existing components within the architecture. This requires that new financial schemes are similar to what have previously been implemented in order for the reuse of existing components to take place.

Recent studies investigating the benefits of modularity empirically have found mixed effects and a number of studies have revealed that modularity can also be associated with a number of effects other than the proclaimed benefits (Miozzo & Grimshaw, 2005; Zirpoli & Becker, 2011). The process of interface specification itself requires detailed knowledge and ability to anticipate in advance the interdependencies. However these are often difficult to anticipate a priori and unidentified interdependencies can impact the dependability of the architecture. In practice this has shown itself as emergence of design rules rather than being designed a priori. Important interdependencies themselves have an inconvenient habit of sometimes being hidden until they show up in unanticipated ways requiring actions to be taken to remedy effects resulting from the interdependence.

Although the company followed a modular architecture with outsourcing of IT development to third party vendors, management of the architecture still required the coordination and visualization of solutions in representations in order to ensure a working solution on a system level. This generated the problem of different vendors using different models of communication raising a need for standardizing the way the business and its systems were modeled and meta models translating the documentation of the IT systems into business level requirements and vice versa. A layer of integration contracts which provided detailed interface specifications was thus established to ensure the dependability of interfaces. The process of establishing these emerged as a consequence of the realization that 'it was a total mess' and in order to have interfaces 'under control'. But even with detailed interface specifications there was still not a sufficient level of trust in the architecture to maintain confidence in a working solution. The fear of experiencing major failures which would have consequences externally thus prompted requests for detailed testing procedures.

A further difficulty lies in maintaining competences to evaluate component level performance when the development of IT applications have been outsourced to external vendors. This raises the question of how to ensure the quality of components and anticipate interdependencies with other components. The benefits of reusing components are thus only obtained when the components being reused are actually living up to their expectations. As explained this did not always turn out to be the case and created frustration and disappointment when components had to be reworked in subsequent implementations. One problem with reuse in this case is that given that components were thought to have already been implemented attention to the need for rework showed up later and with less appreciation.

The study has shown how different performance criteria interact as the concern for quality and dependability displaced the concern for flexibility. The risk of ending on the cover of a tabloid newspaper outweighed the consequences of imposing a bureaucratic solution to ensure dependability. Paradoxically this resulted in the platform being flexible in relation to major changes but inflexible in relation to small local changes. The study has thus shown how the development of an architecture based on principles of modularity is a dynamic

process in which multiple performance criteria are at stake and are affected by the intended and unintended consequences of the actions and compensatory actions taken. The case study have shown how as a result of the emergence of unintended interdependencies the company decided to initiate a number of mechanisms of coordination in order to reduce the number of changes made to processes and systems. The relationship between such compensatory actions and performance outcomes should be taken into consideration when attempting to capture the consequences of modularity.

The important lesson from the case study is not so much that efforts to achieve modularity can have un-intended consequences, but more that actors in light of their own actions continuously engage in a process of acting to respond to these consequences. This reflexive praxis of actors thus results in the emergence of different mechanisms which are intended to obviate the unintended consequences and make the efforts work despite the problems they create. The case study thus showed how the efforts to achieve modularity were thought to reduce the complexity by lowering the number of components through reusing these. However the reuse of components across different financial schemes resulted in the emergence of new complexities as interdependencies between financial schemes unexpectedly began to appear. These interdependencies were caused by changes made to components which despite being perceived to be contained to the individual financial scheme turned up to have cascading effects across the platform. Thus exactly because components were indeed being reused across the platform in accordance with the intentions of the efforts, they had the un-intended consequence of increasing system level effects across the platform. In principle such system level effects are reduced by the modular architecture by the standardization of components and a priori specification of their interfaces. However this assumes that it is possible in advance to fully specify interfaces. However the case study shows that this is not always the case, as reusing components in different financial schemes often required minor changes to be made. Such changes could include making an instance of an IT component to which another field of information is added. Such an addition would require that not only the new instance of the component be tested but that regression testing be performed in order to identify system level effects.

The observation that system level effects were occurring in response to changes made to components led to increased emphasis on following a bi-annual release structure in which any change has to be documented and tested before it can be released into operation. While this is enabling the testing efforts to reduce the number of unanticipated system level effects and therefore increase the reliability and trust in the system it also implies a slowdown in the pace of changes made to the system. While fewer changes to components also serve to reduce the risk of unintended system level effects it impact the perceived flexibility of the system, as even minor changes now require major documentation and testing efforts and basically have to follow the same cycle as major changes. Thus while the benefits of modularity in principle are associated with flexibility to rapidly make alterations to products and services through mixing and matching, the consequences of the actions taken to mitigate the unintended consequences of system level effects actually appear to reduce flexibility.

Chapter 9 Discussion

While the previous chapter presented conclusions based on the case study this chapter will discuss these in relation to their implications for theory and practice. The conclusions have a number of consequences to the literature on modularity as well as to practice constituting the contributions of this thesis.

9.1 Implications for theory

As discussed in chapter 2 the literature on modularity frequently assumes that identification and specification of interfaces can take place a priori. While designers are certainly spending much effort in attempting to do so, this study questions whether a priori interface specification is a useful starting point and assumption in a theory of modularity. Although it would be desirable, the study shows that important interdependencies can show up unexpectedly as consequences of imperfect interface specification or changes made due to unanticipated needs. These unanticipated interdependencies however have important implications as they influence the perceived dependability of the architecture. Such effects have a relationship to the actions taken to mitigate them suggesting that a more dynamic understanding of modularity is called for.

In service modularity it is thus questionable whether the effects of modularity can be measured as a direct cause and effect relationship between efforts and performance outcomes. It is observed that managers and designers when experiencing unintended consequences attempt to build mechanisms which mitigate these. However such efforts are not neutral and warrant attention as they influence performance outcomes as well as the efforts to achieve modularity. In order to achieve a dynamic understanding of the role of modularity in service processes such mechanisms should be studied as well.

While the case study highlights the need for a more dynamic understanding of the design for modularity it nevertheless demonstrates how the literature on service operations management would benefit from the study of modularity. As discussed in chapter 2 profound changes to the way work is organized is taking place based on the enabling role of information and

communication technology. Benefitting from this change requires service organizations to acquire the necessary skills to build and manage architectures of loosely coupled processes and systems. However as the case study has shown building such capabilities is not straightforward. Although only few studies of modularity have investigated the role of management control in achieving modularization (Jørgensen & Messner 2009, 2010; Israelsen & Jørgensen 2011; Thyssen et al., 2006) the case study reveals how the establishing and use of controls became central to the efforts to implement the new architecture. The case study thus point to a more dynamic understanding of the process of modularization in which designers and managers engage not only in trying to anticipate the consequences of actions in advance, but likewise in building mechanisms which can mitigate the effects of unanticipated consequences of actions.

This finding echoes the importance suggested by Garud & Kumaraswamy (1995) for firms to establish “*systems, structures and incentives to encourage the creation of reusable components*”. Surprisingly however the literature on modularity has only paid scarce attention to the role of these elements in the process of achieving modularity and has instead focused much effort on identifying typologies of modularity and evaluating the proposed relationships between modular structures and outcomes of performance. One reason for this may an assumed ability to anticipate interdependencies a priori in the development of modular structures which consequently eliminates the need for coordination or in other words provides embedded coordination. While this may be an important source for many of the proposed benefits of modularity the case study shows that inability to anticipate all such interdependencies or even the risk of such inability may also have implications on coordination. Within the literature on modularity the work of Türtscher (2008) is a notable exception in which focus is instead turned to the mechanisms through which the inability to identify interdependencies and specify interfaces in advance are handled throughout a complex development project. Türtscher thus turns the assumption on its head and addresses instead the question of how in the face of unexpected interdependencies between modules the development can be managed. He found that an elaborate process of trials were established throughout which researchers from different projects would negotiate to resolve technical

controversies as they arose as it would be impossible to anticipate each and every interdependency in advance (Türtscher, 2008).

In a broader perspective the thesis has implications for the modularity theory of the firm as discussed in chapter 3. The concern within transaction cost economics has primarily been on understanding the alignment of governance to transaction characteristics as a way to economize on transaction costs. The technical aspects of products and their production are to a large extent considered given with transactions and their characteristics following from a given technical context. This contrasts with the concern within the modularity literature on shaping the characteristics of technical systems through (re)defining their components and interfaces. Thus whereas transaction cost analysis is concerned with static comparative analysis the modularity theory of the firm would predict that the choice to modularize a process would affect coordination mechanism within and across organizations. Achieving mutual independence can result in reduced asset specificity and thus lower transaction costs. Organizations that prefer market transaction can in effect modularize activities in order to achieve what Baldwin refer to as “thin crossing points” between modules, where transaction costs are lower (Baldwin, 2008). Vertically integrated organizations are thus a non-modular reply to the need for interaction between elements in which the alternative is modularity and market interaction (Langlois, 2002). A consequence of modularity can thus be vertical disintegration and outsourcing and thus a determining factor in the evolving of industries (Schilling, 2000; Schilling & Steensma, 2001) and modularity may potentially have affects the governance structure of inter-organizational relations and the use of control mechanisms (Tiwana, 2008).

Based on organizational economic theory modularity is thus suggested to result in arms-length transactions due to the standardization of interfaces and loose coupling of components. Although this may be the case study provide an example of the importance of maintaining a number of coordination mechanisms in addition to the standardized interfaces of components in order to achieve a working architecture. It also point to the importance of maintaining within the firm the competences necessary to understand and anticipate interdependencies

between components as well as the ability to evaluate the workings of individual components suggesting the role of maintaining system integration skills.

This thesis thus points to the need to include in the theory of modularity the dynamics of the process of modularization requiring the study not only of the relation between modularity and its intended outcomes but also its unintended consequences and how they relate to the purposive actions of knowledgeable agents. Undertaking such research requires the study of micro level processes within organizations undertaking efforts to achieve modularization of technical systems. In the context of service processes this thesis has argued that such research would benefit from adopting a practice lens to the study of organizations as this allow.

9.2 Implications for practice

The thesis has several implications for practice as it firstly raises the concern for architectural capabilities within services as a response to the characteristics of services. However the thesis also through the case study research method point to some of the difficulties of establishing a modular architecture. As argued above this has not received significant attention within the literature on modularity but seem to be a potential explanation for the great number of SOA projects which have failed to realize expected results. In recent years there has been growing interest in SOA governance which seem to be in line with the observation that management control mechanisms are indeed needed in order to avoid an unstable architecture in which reuse of loosely coupled components result in unintended consequences at the system level.

However the implications of the mechanisms of control on the performance of the architecture as well as the efforts made to achieve modularity also seem particularly important. There thus seem to be value to be gained by developing an understanding of how such mechanisms can achieve intended stability of the architecture without sacrificing the flexibility and agility intended by the architecture in the first place. This may involve careful considerations as to how costs are allocated to individual projects developing and using common components. It may also involve the development of a better understanding of the components that are critical to the stability of the architecture in order to concentrate managerial efforts around these while maintaining less rigidity with regard to those components which are less critical.

Alternatively a greater understanding may be gained regarding the notion of flexibility of the architecture. As the case study revealed the architecture was indeed considered quite flexible in certain regards, while very inflexible in other. Flexibility can thus be many things and the ability of the platform to rapidly include new services may not be the same as flexibility to quickly adjust existing services. Flexibility at one level can thus require the architecture to be rigid at another level in order to ensure its dependability. The case study further highlight the need to appreciate the complexities ‘under the hood’ when engaging in efforts to modularize service processes such as the difficulties in making processes generic due to different requirements posed by different customer groups. Finally the thesis suggests the importance

of the mechanisms surrounding the architecture, i.e. the mechanisms that are set in motion to ensure that objectives are met in the face of un-intended consequences. It is important to appreciate that such mechanisms themselves have consequences for the performance outcomes and can thus impact the objectives of the architecture.

9.3 Limitations and further research

Through the use of a case study research strategy this study has tried to demonstrate the use of the service modularity function to investigate the structural composition of service process architecture and how modularization unfolds and challenges the architecture. Although the case study method is a powerful research strategy to investigate and understand complex relationships in their context this value can at the same time reduce the degree of scientific generalizability due to the low-n case study research design.

The case study provides the basis for application of the service modularity function within a specific empiric context through decomposing the service process architecture and identifying the relevant concepts for measurement. The thesis thus provides the basis for further estimation and evaluation of the degree of modularity embedded in the service process architecture. Such measurement will provide the basis for more elaborate comparative assessment of processes within the process architecture.

Through future research I hope to gain further insights into how management and researchers can conceptualize the complexities of service processes into measures so that they can be monitored and controlled. Assessment based on the service modularity function may thus provide managers and process designers with information for evaluating the degree of standardization and reuse across the process architecture. Such information together with simulation and analysis could prove to be useful for the design decisions involved with process development.

The service modularity function assumes that all nodes are free to communicate with other nodes. While this provides a valid assumption in the case of services it could nevertheless be interesting to apply actual interactions between components in an effort to estimate degrees of coupling. With empirical data from the transactions of service processes it would be possible

to connect components through the use of network analysis and estimate degrees of coupling to provide a measure which both take the characteristics of components and their structural composition into consideration.

References

- Akkermans, H., & Vos, B. 2003. Amplification in service supply chains: An exploratory case study from the telecom industry. *Production and Operations Management*, 12(2): 204-223.
- Alexander, C. 1964. *Notes on the synthesis of form*. Cambridge, Mass: Harvard University Press.
- Ali, M. S., Babar, M. A., Chen, L. P., & Stol, K. J. 2010. A systematic review of comparative evidence of aspect-oriented programming. *Information and Software Technology*, 52(9): 871-887.
- Alvesson, M., & Kärreman, D. 2007. Constructing mystery: Empirical matters in theory development. *Academy of Management Review*, 32(4): 1265-1281.
- Anthony, R. N. 1965. *Planning and Control Systems: A Framework for Analysis*. Boston: Graduate School of Business Administration, Harvard University.
- Antonio, K. W. L., Richard, C. M. Y., & Tang, E. 2009. The complementarity of internal integration and product modularity: An empirical study of their interaction effect on competitive capabilities. *Journal of Engineering and Technology Management*, 26(4): 305-326.
- Antonio, K. W. L., Yam, R. C. M., & Tang, E. 2007. The impacts of product modularity on competitive capabilities and performance: An empirical study. *International Journal of Production Economics*, 105(1): 1-20.
- Apte, U., Maglaras, C., & Pinedo, M. 2008. Operations in the Service Industries: Introduction to the Special Issue. *Production & Operations Management*, 17(3): 235-237.
- Arbos, L. C. 2002. Design of a rapid response and high efficiency service by lean production principles: Methodology and evaluation of variability of performance. *International Journal of Production Economics*, 80(2): 169-183.
- Argyres, N., & Bigelow, L. 2010. Innovation, Modularity, and Vertical Deintegration: Evidence from the Early US Auto Industry. *Organization Science*, 21(4): 842-853.
- Arikan, A. T. 2009. Interfirm Knowledge Exchanges and the Knowledge Creation Capability of Clusters. *Academy of Management Review*, 34(4): 658-676.
- Augier, M., & Teece, David J. 2008. Strategy as Evolution with Design: The Foundations of Dynamic Capabilities and the Role of Managers in the Economic System. *Organization Studies*, 29(8&9): 1187-1208.
- Baldwin, C. Y. 2008. Where do transactions come from? Modularity, transactions, and the boundaries of firms. *Industrial and Corporate Change*, 17(1): 155-195.
- Baldwin, C. Y. 2010. When Open Architecture Beats Closed: The Entrepreneurial Use of Architectural Knowledge. *Harvard Business School Working Paper*, 10-063.

- Baldwin, C. Y., & Clark, Kim B. 1997. Managing in an age of modularity. *Harvard Business Review*, 75(5): 84-93.
- Baldwin, C. Y., & Clark, Kim B. 2000. *Design rules*. Cambridge, Mass: MIT Press.
- Baldwin, R. 2006. Globalisation: the great unbundling(s). *Challenges of globalisation for Europe and Finland*.
- Barney, J. 1991. Firm Resources and Sustained Competitive Advantage. *Journal of Management*, 17(1): 99-120.
- Batista, L., Smart, A., & Maull, R. 2008. The systemic perspective of service processes: underlying theory, architecture and approach. *Production Planning & Control*, 19(5): 535-544.
- Beguín, P. 2003. Design as a mutual learning process between users and designers. *Interacting with Computers*, 15(5): 709-730.
- Ben Mahmoud-Jouini, S., & Lenfle, S. 2010. Platform re-use lessons from the automotive industry. *International Journal of Operations & Production Management*, 30(1): 98-124.
- Bhaskar, R. 2009. *Scientific realism and human emancipation*. London: Routledge
- Blecker, Thorsten, & Abdeikafi, N. 2007. The Development of a Component Commonality Metric for Mass Customization. *IEEE Transactions on Engineering Management*, 54(1): 70-85.
- de Blok, C., Luijckx, K., Beijboom, B., & Schols, J. 2010. Modular care and service packages for independently living elderly. *International Journal of Operations & Production Management*, 30(1): 75-97.
- Boland, R., & Collopy, F. 2004. *Managing as designing*. Stanford, CA: Stanford Business Books.
- Brown, S. L., & Eisenhardt, K. 1995. Product development - past research, present findings, and future-directions. *Academy of Management Review*, 20(2): 343-378.
- Browning, T. R. 2001. Applying the design structure matrix to system decomposition and integration problems: A review and new directions. *IEEE Transactions on Engineering Management*, 48(3): 292-306.
- Brusoni, S. 2005. The limits to specialization: Problem solving and coordination in "Modular Networks." *Organization Studies*, 26(12): 1885-1907.
- Brusoni, S., & Prencipe, A. 2001. Unpacking the Black Box of Modularity: Technologies, Products and Organizations. *Industrial and Corporate Change*, 10(1): 179-205.
- Brusoni, S., & Prencipe, A. 2006. Making design rules: A multidomain perspective. *Organization Science*, 17(2): 179-189.

- Brusoni, S., Marengo, L., Prencipe, A., & Valente, M. 2007. The value and costs of modularity: a problem-solving perspective. *European Management Review*, 4(2): 121-132.
- Buganza, T., & Verganti, R. 2006. Life-cycle flexibility: How to measure and improve the innovative capability in turbulent environments. *Journal of Product Innovation Management*, 23(5): 393-407.
- Burzagli, L., Emiliani, P. L., & Gabbanini, F. 2009. Design for All in action: An example of analysis and implementation. *Expert Systems with Applications*, 36(2): 985-994.
- Buzacott, J. A. 2000. Service system structure. *International Journal of Production Economics*, 68(1): 15-27.
- Callon, M., Méadel, C., & Rabeharisoa, V. 2002. The economy of qualities. *Economy & Society*, 31(2): 194.
- Caminati, M. 2006. Knowledge growth, complexity and the returns to R&D. *Journal of Evolutionary Economics*, 16(3): 207-229.
- Campagnolo, D., & Camuffo, A. 2009. What Really Drives the Adoption of Modular Organizational Forms? An Institutional Perspective from Italian Industry-Level Data. *Industry and Innovation*, 16(3): 291-314.
- Campagnolo, D., & Camuffo, A. 2010. The Concept of Modularity in Management Studies: A Literature Review. *International Journal of Management Reviews*, 12(3): 259-283.
- Cases, M., Bodner, D. A., & Mutnury, B. 2010. Architecture of Service Organizations. In G. Salvendy & W. Karwowski (Eds.), **Introduction to service engineering**: 109-134. Hoboken N.J.: John Wiley & Sons.
- Castells, M. 2010. *The information age : economy, society and culture* (2nd ed.). Oxford England: Wiley-Blackwell.
- Cebon, P., Hauptman, O., & Shekhar, C. 2008. Product modularity and the product life cycle: new dynamics in the interactions of product and process technologies. *International Journal of Technology Management*, 42(4): 365-386.
- Ceci, F., & Masciarelli, F. 2010. A Matter of Coherence: The Effects of Offshoring of Intangibles on Firm Performance. *Industry and Innovation*, 17(4): 373-392.
- Chandler, A. 1962. *Strategy and structure: chapters in the history of the industrial enterprise*. Cambridge: M.I.T. Press.
- Chase, R.B. 1978. Where Does Customer Fit in A Service Operation. *Harvard Business Review*, 56(6): 137-142.
- Chase, R.B., & Apte, U. M. 2007. A history of research in service operations: What's the big idea? *Journal of Operations Management*, 25(2): 375-386.
- Chen, K. M., & Liu, R. J. 2005. Interface strategies in modular product innovation.

Technovation, 25(7): 771-782.

Chenhall, R. H. 2003. Management control systems design within its organizational context: findings from contingency-based research and directions for the future. *Accounting, Organizations and Society*, 28(2-3): 127-168.

Chesbrough, H., & Prencipe, A. 2008. Networks of innovation and modularity: a dynamic perspective. *International Journal of Technology Management*, 42(4): 414-425.

Christensen, C., & Rosenbloom, R. 1995. Explaining the attackers advantage - technological paradigms, organizational dynamics and the value network. *Research Policy*, 24(2): 233-257.

Clark, K.B. 1985. The Interaction of Design Hierarchies and Market Concepts in Technological Evolution. *Research Policy*, 14(5): 235-251.

Coase, R. H. 1937. The Nature of the Firm. *Economica*, 4(16): 386-405.

Coase, R. H. 1960. The Problem of Social Cost. *Journal of Law & Economics*, 3(OCT): 1-44.

Cohen, W. M., & Levinthal, D. A. 1990. Absorptive-Capacity - A New Perspective on Learning and Innovation. *Administrative Science Quarterly*, 35(1): 128-152.

Cook, L. S., Bowen, D. E., Chase, Richard B., Dasu, S., Stewart, D. M., & Tansik, D. A. 2002. Human issues in service design. *Journal of Operations Management*, 20(2): 159-174.

Danese, P., & Filippini, R. 2010. Modularity and the impact on new product development time performance Investigating the moderating effects of supplier involvement and interfunctional integration. *International Journal of Operations & Production Management*, 30(11): 1191-1209.

Danese, P., & Romano, P. 2004. Improving inter-functional coordination to face high product variety and frequent modifications. *International Journal of Operations & Production Management*, 24(9-10): 863-885.

Demirkan, H., Kauffman, R. J., Vayghan, J. A., Fill, H. G., Karagiannis, D., & Maglio, P. P. 2008. Service-oriented technology and management: Perspectives on research and practice for the coming decade. *Electronic Commerce Research and Applications*, 7(4): 356-376.

Desanctis, G., & Poole, M. S. 1994. Capturing the Complexity in Advanced Technology Use - Adaptive Structuration Theory. *Organization Science*, 5(2): 121-147.

Doran, D., & Hill, A. 2009. A review of modular strategies and architecture within manufacturing operations. *Proceedings of the Institution of Mechanical Engineers Part D-Journal of Automobile Engineering*, 223(D1): 65-75.

Droege, H., Hildebrand, D., & Forcada, M. A. H. 2009. Innovation in services: present findings, and future pathways. *Journal of Service Management*, 20(2): 131-155.

Du, X. H., Jiao, J. X., & Tseng, M. M. 2001. Architecture of product family: Fundamentals

- and methodology. *Concurrent Engineering-Research and Applications*, 9(4): 309-325.
- Duray, R., Ward, P. T., Milligan, G. W., & Berry, W. L. 2000. Approaches to mass customization: configurations and empirical validation. *Journal of Operations Management*, 18(6): 605-625.
- Eisenhardt, K. M. 1989. Building Theories from Case-Study Research. *Academy of Management Review*, 14(4): 532-550.
- Eisenhardt, K. M., & Graebner, M. E. 2007. Theory building from cases: Opportunities and challenges. *Academy of Management Journal*, 50(1): 25-32.
- Eisenhardt, K. M., & Martin, J. A. 2000. Dynamic capabilities: What are they? *Strategic Management Journal*, 21(10-11): 1105-1121.
- Eppinger, Steven D., Whitney, D. E., Smith, R. P., & Gebala, D. A. 1994. A model-based method for organizing tasks in product development. *Research in Engineering Design*, 6(1): 1-13.
- Ethiraj, S. K., & Levinthal, D. 2004. Modularity and innovation in complex systems. *Management Science*, 50(2): 159-173.
- Ethiraj, S. K., & Levinthal, D. 2009. Hoping for A to Z While Rewarding Only A: Complex Organizations and Multiple Goals. *Organization Science*, 20(1): 4-21.
- Ethiraj, S. K., Levinthal, D., & Roy, R. R. 2008. The dual role of modularity: Innovation and imitation. *Management Science*, 54(5): v.
- Fairclough, N. 2005. Peripheral Vision: Discourse Analysis in Organization Studies: The Case for Critical Realism. *Organization Studies*, 26(6): 915-939.
- Feitzinger, E., & Lee, H. 1997. Mass customization at Hewlett-Packard: The power of postponement. *Harvard Business Review*, 75(1): 116-&.
- Ferreira, A., & Otley, D. 2009. The design and use of performance management systems: An extended framework for analysis. *Management Accounting Research*, 20(4): 263-282.
- Fine, C. 1998. *Clockspeed: winning industry control in the age of temporary advantage*. Reading Mass.: Perseus Books.
- Fisher, M., Ramdas, K., & Ulrich, K. 1999. Component sharing in the management of product variety: A study of automotive braking systems. *Management Science*, 45(3): 297-315.
- Fitzsimmons, J. A., & Fitzsimmons, M. J. 2008. *Service management: operations, strategy, and information technology*. Boston, Mass: McGraw-Hill.
- Fixson, S. K. 2005. Product architecture assessment: a tool to link product, process, and supply chain design decisions. *Journal of Operations Management*, 23(3-4): 345-369.

- Fixson, S. K. 2007. Modularity and commonality research: past developments and future opportunities. *Concurrent Engineering-Research and Applications*, 15(2): 85-111.
- Fixson, S. K., & Park, J. K. 2008. The power of integrality: Linkages between product architecture, innovation, and industry structure. *Research Policy*, 37(8): 1296-1316.
- Fleming, L., & Sorenson, O. 2001. Technology as a complex adaptive system: evidence from patent data. *Research Policy*, 30(7): 1019-1039.
- Foss, Nicolai J. 2005. *Strategy, economic organization, and the knowledge economy - the coordination of firms and resources*. Oxford: Oxford University Press.
- Foss, Nicolai Juul. 1994. The two Coasian traditions. *Review of Political Economy*, 6(1): 37.
- Fredriksson, P. 2006. Mechanisms and rationales for the coordination of a modular assembly system - The case of Volvo cars. *International Journal of Operations & Production Management*, 26(3-4): 350-370.
- Fredriksson, P., & Gadde, L. E. 2005. Flexibility and rigidity in customization and build-to-order production. *Industrial Marketing Management*, 34(7): 695-705.
- Frigant, V. 2007. The impact of modular production on the international fragmentation of production. *Revue D Economie Politique*, 117(6): 937-961.
- Funk, J. L. 2008. Systems, components and modular design: the case of the US semiconductor industry. *International Journal of Technology Management*, 42(4): 387-413.
- Gadrey, J. 2000. The Characterization of Goods and Services: An Alternative Approach. *Review of Income & Wealth*, 46(3): 369-387.
- Gadrey, J. 2002. The misuse of productivity concepts in services: lessons from a comparison between France and the United States. In J. Gadrey & F. Gallouj (Eds.), *Productivity, innovation, and knowledge in services : new economic and socio-economic approaches*: 26-53. Cheltenham: Edward Elgar Publishing Limited.
- Garud, R., & Kumaraswamy, A. 1993. Changing competitive dynamics in network industries - an exploration of Sun Microsystems open systems strategy. *Strategic Management Journal*, 14(5): 351-369.
- Garud, R., & Kumaraswamy, A. 1995. Technological and Organizational Designs for Realizing Economies of Substitution. *Strategic Management Journal*, 16: 93-109.
- Garud, R., & Kumaraswamy, A. 1996. Technological designs for retention and reuse. *International Journal of Technology Management*, 11(7-8): 883-891.
- Garud, R., & Munir, K. 2008. From transaction to transformation costs: The case of Polaroid's SX-70 camera. *Research Policy*, 37(4): 690-705.
- Garud, R., Jain, S., & Tuertscher, P. 2008. Incomplete by design and designing for incompleteness. *Organization Studies*, 29(3): 351-371.

- Garvin, D. A. 1998. The processes of organization and management. *Sloan Management Review*, 39(4): 33-50.
- Gatignon, H., Tushman, M. L., Smith, W., & Anderson, P. 2002. A structural approach to assessing innovation: Construct development of innovation locus, type, and characteristics. *Management Science*, 48(9): 1103-1122.
- Gavetti, G., Levinthal, D. A., & Rivkin, J. W. 2005. Strategy making in novel and complex worlds: The power of analogy. *Strategic Management Journal*, 26(8): 691-712.
- Geisendorf, S. 2010. Searching NK Fitness Landscapes: On the Trade Off Between Speed and Quality in Complex Problem Solving. *Computational Economics*, 35(4): 395-406.
- Gentry, R. J., & Elms, H. 2009. Firm Partial Modularity and Performance in the Electronic Manufacturing Services Industry. *Industry and Innovation*, 16(6): 575-592.
- Giddens, A. 1979. *Central problems in social theory: action, structure and contradiction in social analysis*. London: Macmillan.
- Giddens, A. 1984. *The constitution of society - outline of the theory of structuration*. Oxford: Polity.
- Gokpinar, B., Hopp, W. J., & Iravani, S. M. R. 2010. The Impact of Misalignment of Organizational Structure and Product Architecture on Quality in Complex Product Development. *Management Science*, 56(3): 468-484.
- Gomes, P. J., & Dahab, S. 2010. Bundling resources across supply chain dyads The role of modularity and coordination capabilities. *International Journal of Operations & Production Management*, 30(1): 57-74.
- Grote, M. H., & Taube, F. A. 2007. When outsourcing is not an option: International relocation of investment bank research - Or isn't it? *Journal of International Management*, 13(1): 57-77.
- Grunwald, R., & Kieser, A. 2007. Learning to reduce interorganizational learning: An analysis of architectural product innovation in strategic alliances. *Journal of Product Innovation Management*, 24(4): 369-391.
- Gunasekaran, A., & Ngai, E. W. T. 2005. Build-to-order supply chain management: a literature review and framework for development. *Journal of Operations Management*, 23(5): 423-451.
- Helfat, C.E., & Eisenhardt, K. M. 2004. Inter-temporal economies of scope, organizational modularity, and the dynamics of diversification. *Strategic Management Journal*, 25(13): 1217-1232.
- Helfat, Constance E. 2007. *Dynamic capabilities - understanding strategic change in organizations*. Malden, Mass: Blackwell.

- Henderson, R. M., & Clark, Kim B. 1990. Architectural Innovation - the Reconfiguration of Existing Product Technologies and the Failure of Established Firms. *Administrative Science Quarterly*, 35(1): 9-30.
- Hill, A. V., Collier, D. A., Froehle, C. M., Goodale, J. C., Metters, R. D., & Verma, R. 2002. Research opportunities in service process design. *Journal of Operations Management*, 20(2): 189-202.
- Hill, P. 1999. Tangibles, intangibles and services: A new taxonomy for the classification of output. *Canadian Journal of Economics*, 32(2): 426.
- Von Hippel, E. 1990. Task Partitioning - An Innovation Process Variable. *Research Policy*, 19(5): 407-418.
- Hoetker, G. 2006. Do modular products lead to modular organizations? *Strategic Management Journal*, 27(6): 501-518.
- Holmstrom, B., & Milgrom, P. 1991. Multitask Principal Agent Analyses - Incentive Contracts, Asset Ownership, and Job Design. *Journal of Law Economics & Organization*, 7: 24-52.
- Howard, M., & Squire, B. 2007. Modularization and the impact on supply relationships. *International Journal of Operations & Production Management*, 27(11): 1192-1212.
- Huang, G. Q., Xin Yan Zhang, & Lo, V. H. Y. 2007. Integrated Configuration of Platform Products and Supply Chains for Mass Customization: A Game-Theoretic Approach. *IEEE Transactions on Engineering Management*, 54(1): 156-171.
- Huang, G. Q., Zhang, X. Y., & Liang, L. 2005. Towards integrated optimal configuration of platform products, manufacturing processes, and supply chains. *Journal of Operations Management*, 23(3-4): 267-290.
- Huberman, B. A., & Wilkinson, D. M. 2010. Fluctuating Efforts and Interdependencies in Collaborative Work. *Group Decision and Negotiation*, 19(2): 169-191.
- Israelsen, P., & Jørgensen, B. 2011. Decentralizing decision making in modularization strategies: Overcoming barriers from dysfunctional accounting systems. *International Journal of Production Economics*, 131(2): 453-462.
- Jacobides, M. G. 2006. The architecture and design of organizational capabilities. *Industrial and Corporate Change*, 15(1): 151-171.
- Jacobides, M. G., & Billinger, S. 2006. Designing the boundaries of the firm: From “make, buy, or ally” to the dynamic benefits of vertical architecture. *Organization Science*, 17(2): 249-261.
- Jacobides, M. G., & Winter, S.G. 2005. The co-evolution of capabilities and transaction costs: Explaining the institutional structure of production. *Strategic Management Journal*, 26(5): 395-413.

- Jacobs, M., Droge, C., Vickery, S. K., & Calantone, R. 2011. Product and Process Modularity's Effects on Manufacturing Agility and Firm Growth Performance. *Journal of Product Innovation Management*, 28(1): 123-137.
- Jacobs, M., Vickery, S. K., & Droge, C. 2007. The effects of product modularity on competitive performance - Do integration strategies mediate the relationship? *International Journal of Operations & Production Management*, 27(9-10): 1046-1068.
- Jaspers, F., & van den Ende, J. 2010. Open innovation and systems integration: how and why firms know more than they make. *International Journal of Technology Management*, 52(3-4): 275-294.
- Jørgensen, B., & Messner, M. 2010. Accounting and strategising: A case study from new product development. *Accounting, Organizations and Society*, 35(2): 184-204.
- Karim, S. 2006. Modularity in organizational structure: The reconfiguration of internally developed and acquired business units. *Strategic Management Journal*, 27(9): 799-823.
- Kauffman, S. 1993. *The origins of order : self-organization and selection in evolution*. New York: Oxford University Press.
- Kong, F. B., Ming, X. G., Wang, L., Wang, X. H., & Wang, P. P. 2009. On Modular Products Development. *Concurrent Engineering-Research and Applications*, 17(4): 291-300.
- Konnola, T., Ahlqvist, T., Eerola, A., Kivisaari, S., & Koivisto, R. 2009. Management of foresight portfolio: analysis of modular foresight projects at contract research organisation. *Technology Analysis & Strategic Management*, 21(3): 381-405.
- von Krogh, G., & Haefliger, S. 2010. Opening up design science: The challenge of designing for reuse and joint development. *The Journal of Strategic Information Systems*, 19(4): 232-241.
- Krueger, C. W. 1992. Software reuse. *ACM Comput. Surv.*, 24(2): 131-183.
- Kumar, A. 2004. Mass customization: Metrics and modularity. *International Journal of Flexible Manufacturing Systems*, 16(4): 287-311.
- Kusunoki, K., Nonaka, I., & Nagata, A. 1998. Organizational capabilities in product development of Japanese firms: A conceptual framework and empirical findings. *Organization Science*, 9(6): 699-718.
- Langlois, R. N. 2002. Modularity in technology and organization. *Journal of Economic Behavior & Organization*, 49(1): 19-37.
- Langlois, R. N. 2006. The secret life of mundane transaction costs. *Organization Studies*, 27(9): 1389-1410.
- Langlois, R. N., & Robertson, P. L. 1995. *Firms, markets, and economic change - A dynamic theory of business institutions*. London: Routledge.

- Langlois, R. N., & Robertson, P. L. 1992. Networks and innovations in a modular system - lessons from the microcomputer and stereo component industries. *Research Policy*, 21(4): 297-313.
- Langlois, R. N., & Garzarelli, G. 2008. Of Hackers and Hairdressers: Modularity and the Organizational Economics of Open-source Collaboration. *Industry and Innovation*, 15(2): 125-143.
- Lau, A. K. W., Yam, R. C. M., & Tang, E. P. Y. 2010. Supply chain integration and product modularity An empirical study of product performance for selected Hong Kong manufacturing industries. *International Journal of Operations & Production Management*, 30(1): 20-56.
- Lehrer, M., & Behnam, M. 2009. Modularity vs programmability in design of international products: Beyond the standardization-adaptation tradeoff? *European Management Journal*, 27(4): 281-292.
- Lei, D. 2003. Competition, cooperation and learning: the new dynamics of strategy and organisation design for the innovation net. *International Journal of Technology Management*, 26(7): 694-716.
- Lei, D. T. 2000. Industry evolution and competence development: the imperatives of technological convergence. *International Journal of Technology Management*, 19(7-8): 699-738.
- Lei, D., Hitt, M. A., & Goldhar, J. D. 1996. Advanced manufacturing technology: Organizational design and strategic flexibility. *Organization Studies*, 17(3): 501-523.
- Leonard-Barton, D. 1992. Core Capabilities and Core Rigidities - A Paradox in Managing New Product Development. *Strategic Management Journal*, 13: 111-125.
- Levinthal, D. A. 1997. Adaptation on rugged landscapes. *Management Science*, 43(7): 934-950.
- Lillrank, P. 2010. Service Processes. In G. Salvendy & W. Karwowski (Eds.), *Introduction to Service Engineering*: 338-364. Hoboken N.J.: John Wiley & Sons.
- Lin, Y., Zhou, L., Shi, Y. J., & Ma, S. H. 2009. 3C framework for modular supply networks in the Chinese automotive industry. *International Journal of Logistics Management*, 20(3): 322-341.
- Liu, Z., Wong, Y. S., & Lee, K. S. 2010. Modularity analysis and commonality design: a framework for the top-down platform and product family design. *International Journal of Production Research*, 48(12): 3657-3680.
- Loch, C. H., Terwiesch, C., & Thomke, S. 2001. Parallel and sequential testing of design alternatives. *Management Science*, 47(5): 663-678.
- Loch, C., Mihm, J., & Huchzermeier, A. 2003. Concurrent engineering and design

- oscillations in complex engineering projects. *Concurrent Engineering-Research and Applications*, 11(3): 187-199.
- Lovelock, C. H., & Wright, L. 1999. *Principles of service marketing and management*. Upper Saddle River, N.J: Prentice Hall.
- Lovelock, C., & Gummesson, E. 2004. Whither Services Marketing? In Search of a New Paradigm and Fresh Perspectives. *Journal of Service Research*, 7(1): 20 -41.
- MacCormack, A., Verganti, R., & Iansiti, M. 2001. Developing products on “Internet time”: The anatomy of a flexible development process. *Management Science*, 47(1): 133-150.
- MacCormack, A., Rusnak, J., & Baldwin, C. Y. 2006. Exploring the Structure of Complex Software Designs: An Empirical Study of Open Source and Proprietary Code. *Management Science*, 52(7): 1015-1030.
- Malhotra, A., Gosain, S., & El Sawy, O. A. 2005. Absorptive capacity configurations in supply chains: Gearing for partner-enabled market knowledge creation. *MIS Quarterly*, 29(1): 145-187.
- Malmi, T., & Brown, D. A. 2008. Management control systems as a package—Opportunities, challenges and research directions. *Management Accounting Research*, 19(4): 287-300.
- March, J. G. 1991. Exploration and Exploitation in Organizational Learning. *Organization Science*, 2(1): 71-87.
- Martin, J. A., & Eisenhardt, K. M. 2004. Coping with decline in dynamic markets: Corporate entrepreneurship and the recombinative organizational form. In J. A. C. Baum & A. M. McGahan (Eds.), *Business Strategy over the Industry Life Cycle (Advances in strategic management, Volume 21)*: 357-382. Bingley: Emerald Group Publishing Limited.
- Merchant, K., & Van der Stede, W. A. 2007. *Management control systems performance measurement, evaluation, and incentives*. Harlow, Financial Times/Prentice Hall.
- Meyer, M. H., & Lehnerd, A. P. 1997. *The power of product platforms : building value and cost leadership*. New York: Free Press.
- Meyer, M., Tertzakian, P., & Utterback, J. 1997. Metrics for managing research and development in the context of the product family. *Management Science*, 43(1): 88-111.
- Meyer, M. H., & DeTore, A. 2001. PERSPECTIVE: Creating a platform-based approach for developing new services. *Journal of Product Innovation Management*, 18(3): 188-204.
- Mihm, J., Loch, C., & Huchzermeier, A. 2003. Problem-solving oscillations in complex engineering projects. *Management Science*, 49(6): 733-750.
- Mikkola, J. H. 2006. Capturing the Degree of Modularity Embedded in Product Architectures. *Journal of Product Innovation Management*, 23(2): 128-146.
- Mikkola, J. H. 2003. Modularity, component outsourcing, and inter-firm learning. *R & D*

Management, 33(4): 439-454.

Mikkola, J. H. 2007. Management of product architecture modularity for mass customization: Modeling and theoretical considerations. *IEEE Transactions on Engineering Management*, 54(1): 57-69.

Mikkola, J. H., & Gassmann, O. 2003. Managing Modularity of Product Architectures: Toward an Integrated Theory. *IEEE Transactions on Engineering Management*, 50(2): 204.

Mikkola, J. H., & Skjøtt-Larsen, T. 2004. Supply-chain integration: implications for mass customization, modularization and postponement strategies. *Production Planning & Control*, 15(4): 352-361.

Milgrom, P. R., & Roberts, J. 1992. *Economics, organization, and management*. Englewood Cliffs, N.J: Prentice-Hall.

Milgrom, P., & Roberts, J. 1995. Complementarities and Fit - Strategy, Structure, and Organizational-Change in Manufacturing. *Journal of Accounting & Economics*, 19(2-3): 179-208.

Milgrom, P., & Roberts, J. 1990. The economics of modern manufacturing: Technology,.. *American Economic Review*, 80(3): 511.

Miozzo, M., & Grimshaw, D. 2005. Modularity and innovation in knowledge-intensive business services: IT outsourcing in Germany and the UK. *Research Policy*, 34(9): 1419-1439.

Murmann, J. P., & Frenken, K. 2006. Toward a systematic framework for research on dominant designs, technological innovations, and industrial change. *Research Policy*, 35(7): 925-952.

Neaga, E. I., & Harding, J. A. 2005. An enterprise modeling and integration framework based on knowledge discovery and data mining. *International Journal of Production Research*, 43(6): 1089-1108.

Nelson, R., & Winter, Sidney G. 1982. *An evolutionary theory of economic change*. Cambridge Mass.: Belknap Press of Harvard University Press.

Nepal, B., Monplaisir, L., & Singh, N. 2005. Integrated fuzzy logic-based model for product modularization during concept development phase. *International Journal of Production Economics*, 96(2): 157-174.

Newcomer, E., & Lomow, G. 2005. *Understanding SOA with Web services*. Upper Saddle River, NJ: Addison-Wesley.

Newman, M. 2010. *Networks : an introduction*. Oxford; New York: Oxford University Press.

Nonaka, I. 1994. A Dynamic Theory of Organizational Knowledge Creation. *Organization Science*, 5(1): 14-37.

- O'Grady, P., & Liang, W. Y. 1998. An object oriented approach to design with modules. *Computer Integrated Manufacturing Systems*, 11(4): 267-283.
- O'Reilly, C. A., & Tushman, M. L. 2008. Ambidexterity as a dynamic capability: Resolving the innovator's dilemma. *Research in Organizational Behavior*, 28: 185-206.
- Oliva, R., & Sterman, J. D. 2001. Cutting corners and working overtime: Quality erosion in the service industry. *Management Science*, 47(7): 894-914.
- Orlikowski, W. J. 2010. The sociomateriality of organisational life: considering technology in management research. *Cambridge Journal of Economics*, 34(1): 125 -141.
- Orlikowski, W. J. 2000. Using technology and constituting structures: A practice lens for studying technology in organizations. *Organization Science*, 11(4): 404-428.
- Orlikowski, W. J., & Barley, S. R. 2001. Technology and institutions: What can research on information technology and research on organizations learn from each other? *MIS Quarterly*, 25(2): 145-165.
- Orlikowski, W. J. 2004. Managing and Designing, Attending to Reflexiveness and Enactment. In R. Boland & F. Collopy (Eds.), *Managing as designing*: 90-95. Stanford, CA: Stanford Business Books.
- Orton, J. D., & Weick, K.E. 1990. Loosely Coupled Systems - A Reconceptualization. *Academy of Management Review*, 15(2): 203-223.
- Pahl, G. 1996. *Engineering design : a systematic approach* (2nd ed.). London [u.a.]: Springer.
- Pan, S. L., Pan, G., Chen, A. J. W., & Hsieh, M. H. 2007. The Dynamics of Implementing and Managing Modularity of Organizational Routines During Capability Development: Insights From a Process Model. *Ieee Transactions on Engineering Management*, 54(4): 800-813.
- Parmigiani, A., & Mitchell, W. 2009. Complementarity, Capabilities, and the Boundaries of the Firm: the Impact of Within-Firm and Interfirm Expertise on Concurrent Sourcing of Complementary Components. *Strategic Management Journal*, 30(10): 1065-1091.
- Parnas D. L. 1972. On the criteria to be used in decomposing systems into modules. *Communications of the Acm*, 15(12): 1053-1058.
- Peltokorpi, V. 2008. Synthesising the paradox of organisational routine flexibility and stability: a processual view. *International Journal of Technology Management*, 41(1-2): 7-21.
- Penrose, E. 1959. *The theory of the growth in the firm*. Oxford [Eng.]: Blackwell.
- Pentland, B. T., & Feldman, M. S. 2005. Organizational routines as a unit of analysis. *Industrial and Corporate Change*, 14(5): 793-815.

- Pentland, B. T., & Feldman, M. S. 2008. Designing routines: On the folly of designing artifacts, while hoping for patterns of action. *Information and Organization*, 18(4): 235-250.
- Pero, M., Abdelkafi, N., Sianesi, A., & Blecker, T. 2010. A framework for the alignment of new product development and supply chains. *Supply Chain Management-An International Journal*, 15(2): 115-128.
- Pil, F. K., & Cohen, S. K. 2006. Modularity: Implications for imitation, innovation, and sustained advantage. *Academy of Management Review*, 31(4): 995-1011.
- Pilkington, A., & Fitzgerald, R. 2006. Operations management themes, concepts and relationships: a forward retrospective of IJOPM. *International Journal of Operations & Production Management*, 26(11-12): 1255-1275.
- Pilkington, A., & Meredith, J. 2009. The evolution of the intellectual structure of operations management-1980-2006: A citation/co-citation analysis. *Journal of Operations Management*, 27(3): 185-202.
- Pine, B. 1993. *Mass customization : the new frontier in business competition*. Boston Mass.: Harvard Business School Press.
- Pratten, S. 1997. The nature of transaction cost economics. *Journal of Economic Issues*, 31(3): 781-803.
- Quattrone, P. & Hopper, T. 2001. What does organizational change mean? Speculations on a taken for granted category. *Management Accounting Research*, 12 (4): 403-435.
- Rai, A., Venkatesh, V., Bala, H., & Lewis, M. 2010. Transitioning to A Modular Enterprise Architecture: Drivers, Constraints, and Actions. *Mis Quarterly Executive*, 9(2): 83-94.
- Rivkin, J. 2000. Imitation of complex strategies. *Management Science*, 46(6): 824-844.
- Ro, Y. K., Liker, J. K., & Fixson, S. K. 2007. Modularity as a strategy for supply chain coordination: The case of US auto. *IEEE Transactions on Engineering Management*, 54(1): 172-189.
- Roberts, J. 2007. *The modern firm - organizational design for performance and growth*. Oxford: Oxford University Press.
- Robertson, D., & Ulrich, K. 1998. Planning for product platforms. *Sloan Management Review*, 39(4): 19-+.
- Robertson, P. L., & Verona, G. 2006. Post-Chandlerian firms: Technological change and firm boundaries. *Australian Economic History Review*, 46(1): 70-94.
- Roth, A. V., & Menor, L. J. 2003. Insights into service operations management: A research agenda. *Production & Operations Management*, 12(2): 145-164.
- Sahaym, A., Steensma, H. K., & Schilling, M. A. 2007. The influence of information technology on the use of loosely coupled organizational forms: An industry-level analysis.

Organization Science, 18(5): 865-880.

Salvador, F. 2007. Toward a Product System Modularity Construct: Literature Review and Reconceptualization. *IEEE Transactions on Engineering Management*, 54(2): 219-240.

Salvador, F., Forza, C., & Rungtusanatham, M. 2002. Modularity, product variety, production volume, and component sourcing: theorizing beyond generic prescriptions. *Journal of Operations Management*, 20(5): 549-575.

Salvador, F., Rungtusanatham, M., & Forza, C. 2004. Supply-chain configurations for mass customization. *Production Planning & Control*, 15(4): 381-397.

Sampson, S. E., & Froehle, C. M. 2006. Foundations and implications of a proposed Unified Services Theory. *Production and Operations Management*, 15(2): 329-343.

Sanchez, R. 1995. Strategic Flexibility in Product Competition. *Strategic Management Journal*, 16: 135-159.

Sanchez, R. 1999. Modular architectures in the marketing process. *Journal of Marketing*, 63: 92-111.

Sanchez, R. 2000. Modular architectures, knowledge assets and organizational learning: new management processes for product creation. *International Journal of Technology Management*, 19(6): 610-629.

Sanchez, R. 2008. Modularity in the mediation of market and technology change. *International Journal of Technology Management*, 42(4): 331-364.

Sanchez, R., & Mahoney, J. T. 1996. Modularity, flexibility, and knowledge management in product and organization design. *Strategic Management Journal*, 17: 63-76.

Schilling, M. A. 2000. Toward a general modular systems theory and its application to interfirm product modularity. *Academy of Management Review*, 25(2): 312-334.

Schilling, M. A., & Steensma, H. K. 2001. The use of modular organizational forms: An industry-level analysis. *Academy of Management Journal*, 44(6): 1149-1168.

Schmickl, C., & Kieser, A. 2008. How much do specialists have to learn from each other when they jointly develop radical product innovations? *Research Policy*, 37(3): 473-491.

Schön, D. 1983. *The reflective practitioner : how professionals think in action*. New York: Basic Books.

Schön, D. 2000. *The Reflective practitioner : How Professionals think in action*. Aldershot: Ashgate/ARENA.

Sheu, C., McHaney, R., & Babbar, S. 2003. Service process design flexibility and customer waiting time. *International Journal of Operations & Production Management*, 23(7-8): 901-917.

- Siggelkow, N., & Levinthal, D. A. 2003. Temporarily divide to conquer: Centralized, decentralized, and reintegrated organizational approaches to exploration and adaptation. *Organization Science*, 14(6): 650-669.
- Siggelkow, N., & Rivkin, J. W. 2005. Speed and search: Designing organizations for turbulence and complexity. *Organization Science*, 16(2): 101-122.
- Silvestro, R., Fitzgerald, L., Johnston, R., & Voss, C. 1992. Towards a Classification of Service Processes. *International Journal of Service Industry Management*, 3(3): 62-75.
- Simon, H. A. 1996. *The sciences of the artificial*. Cambridge, Mass: MIT Press.
- Simon, H. A. 1962. The Architecture of Complexity. *Proceedings of the American Philosophical Society*, 102(6): 467-482.
- Simon, Herbert A. 1962. The architecture of complexity. *Proceedings of the American Philosophical Society*, 106(6): 467-482.
- Slack, N., & Lewis, Michael. 2008. *Operations strategy*. Harlow: Financial Times Prentice Hall.
- Slack, N., Chambers, S., & Johnston, R. 2010. *Operations management*. Harlow: Prentice Hall/Financial Times.
- Smart, P. A., Maddern, H., & Maull, R. S. 2009. Understanding Business Process Management: Implications for Theory and Practice. *British Journal of Management*, 20(4): 491-507.
- Smith, A. 1776. *An Inquiry into the Nature and Causes of the Wealth of Nations*. New York: Random House.
- Smith, R., & Eppinger, S. 1997. Identifying controlling features of engineering design iteration. *Management Science*, 43(3): 276-293.
- Sosa, M. E., Eppinger, S.D., & Rowles, C. M. 2004. The misalignment of product architecture and organizational structure in complex product development. *Management Science*, 50(12): 1674-1689.
- Spring, M. & Araujo, L. 2009. Service, services and products: rethinking operations strategy. *International Journal of Operations & Production Management*, 29 (5): 444-467.
- Squire, B., Cousins, P. D., Lawson, B., & Brown, S. 2009. The effect of supplier manufacturing capabilities on buyer responsiveness The role of collaboration. *International Journal of Operations & Production Management*, 29(7-8): 766-788.
- Starr, M. K. 1965. Modular Production - A New Concept. *Harvard Business Review*, 43(6): 131-&.
- Starr, M. K. 2010. Modular production - a 45-year-old concept. *International Journal of Operations & Production Management*, 30(1): 7-19.

- Staudenmayer, N., Tripsas, M., & Tucci, C. L. 2005. Interfirm modularity and its implications for product development. *Journal of Product Innovation Management*, 22(4): 303-321.
- Susarla, A., Barua, A., & Whinston, A. B. 2010. Multitask Agency, Modular Architecture, and Task Disaggregation in SaaS. *Journal of Management Information Systems*, 26(4): 87-117.
- Sydsaeter, K., & Hammond, P. J. 1995. *Mathematics for Economic Analysis* (International edition.). New Jersey: Prentice-Hall.
- Takeishi, A. 2002. Knowledge Partitioning in the Interfirm Division of Labor: The Case of Automotive Product Development. *Organization Science*, 13(3): 321-338.
- Tanriverdi, H., Konana, P., & Ge, L. 2007. The choice of sourcing mechanisms for business processes. *Information Systems Research*, 18(3): 280-299.
- Teece, D. J. 1986. Profiting from Technological Innovation - Implications for Integration, Collaboration, Licensing and Public-Policy. *Research Policy*, 15(6): 285-305.
- Teece, D. J. 2007. Explicating dynamic capabilities: The nature and microfoundations of (sustainable) enterprise performance. *Strategic Management Journal*, 28(13): 1319-1350.
- Teece, D. J., Pisano, G., & Shuen, A. 1997. Dynamic Capabilities and Strategic Management. *Strategic Management Journal*, 18(7): 509-533.
- Terwiesch, C., Loch, CH, & De Meyer, A. 2002. Exchanging preliminary information in concurrent engineering: Alternative coordination strategies. *Organization Science*, 13(4): 402-419.
- Thevenot, H. J., Alizon, F., Simpson, T. W., & Shooter, S. B. 2007. An index-based method to manage the tradeoff between diversity and commonality during product family design. *Concurrent Engineering-Research and Applications*, 15(2): 127-139.
- Thomke, S. H. 1997. The role of flexibility in the development of new products: An empirical study. *Research Policy*, 26(1): 105-119.
- Thompson, J. 1967. *Organizations in action : social science bases of administrative theory*. New York: McGraw-Hill.
- Thyssen, J., Israelsen, P., & Jorgensen, B. 2006. Activity-based costing as a method for assessing the economics of modularization - A case study and beyond. *International Journal of Production Economics*, 103(1): 252-270.
- Tiwana, A. 2008a. Does Interfirm Modularity Complement Ignorance? A Field Study of Software Outsourcing Alliances. *Strategic Management Journal*, 29(11): 1241-1252.
- Tiwana, A. 2008b. Does technological modularity substitute for control? A study of alliance performance in software outsourcing. *Strategic Management Journal*, 29(7): 769-780.
- Tiwana, A., & Konsynski, B. 2010. Complementarities Between Organizational IT

- Architecture and Governance Structure. *Information Systems Research*, 21(2): 288-304.
- Tiwana, A., Konsynski, B., & Bush, A. A. 2010. Platform Evolution: Coevolution of Platform Architecture, Governance, and Environmental Dynamics. *Information Systems Research*, 21(4): 675-687.
- Tseng, T. L., & Huang, C. C. 2008. Design support systems: A case study of modular design of the set-top box from design knowledge externalization perspective. *Decision Support Systems*, 44(4): 909-924.
- Tsoukas, H. 1989. The Validity of Idiographic Research Explanations. *Academy of Management Review*, 14(4): 551-561.
- Tu, Q., Vonderembse, M. A., Ragu-Nathan, T. S., & Ragu-Nathan, B. 2004. Measuring Modularity-Based Manufacturing Practices and Their Impact on Mass Customization Capability: A Customer-Driven Perspective. *Decision Sciences*, 35(2): 147-168.
- Tushman, M. L., & Anderson, P. 1986. Technological Discontinuities and Organizational Environments. *Administrative Science Quarterly*, 31(3): 439-465.
- Türtscher, P. 2008. *The Emergence of Architecture in Modular Systems: Coordination across Boundaries at ATLAS, CERN*. PhD Dissertation. St. Gallen: University of St. Gallen.
- Ulku, S., & Schmidt, G. M. 2011. Matching Product Architecture and Supply Chain Configuration. *Production and Operations Management*, 20(1): 16-31.
- Ulrich, K. 1995. The Role of Product Architecture in the Manufacturing Firm. *Research Policy*, 24(3): 419-440.
- Upton, D. M. 1994. The Management of Manufacturing Flexibility. *California Management Review*, 36(2): 72-89.
- Vargo, S. L., & Lusch, R. F. 2004. Evolving to a New Dominant Logic for Marketing. *Journal of Marketing*, 68(1): 1-17.
- Van de Ven, A. H. 2007. *Engaged scholarship - a guide for organizational and social research*. Oxford: Oxford University Press.
- Verganti, R., & Buganza, T. 2005. Designing for life-cycle flexibility in Internet-based service. *Journal of Product Innovation Management*, 22(3): 223-237.
- Voss, C. A. 2009. Case Research in Operations Management. In C. Karlsson (Ed.), *Researching operations management*: 162-195. New York: Routledge.
- Voss, C. A., & Hsuan, J. 2009. Service Architecture and Modularity. *Decision Sciences*, 40(3): 541-569.
- Wang, H. 2008. Innovation in product architecture - A study of the Chinese automobile industry. *Asia Pacific Journal of Management*, 25(3): 509-535.

- Weick, Karl E. 1976. Educational Organizations as Loosely Coupled Systems. *Administrative Science Quarterly*, 21(1): 1-19.
- Weick, K.E., Sutcliffe, K. M., & Obstfeld, D. 2005. Organizing and the process of sensemaking. *Organization Science*, 16(4): 409-421.
- Weick, Karl E. 1995. *Sensemaking in organizations*. Thousand Oaks: Sage Publications.
- Weiss, M., & Gangadharan, G. R. 2010. Modeling the mashup ecosystem: structure and growth. *R & D Management*, 40(1): 40-49.
- Wernerfelt, B. 1984. A Resource-Based View of the Firm. *Strategic Management Journal*, 5(2): 171-180.
- Williamson, Oliver E. 1985. *The economic institutions of capitalism firms, markets, relational contracting*. New York: Free Press.
- Williamson, O.E. 1979. Transaction-Cost Economics - Governance of Contractual Relations. *Journal of Law & Economics*, 22(2): 233-261.
- Williamson, Oliver E. 1975. *Markets and hierarchies, analysis and antitrust implications a study in the economics of internal organization*. New York: Free Press.
- Williamson, Oliver E. 1996. *The mechanisms of governance*. New York: Oxford University Press.
- Worren, N., Moore, K., & Cardona, P. 2002. Modularity, strategic flexibility, and firm performance: A study of the home appliance industry. *Strategic Management Journal*, 23(12): 1123-1140.
- Yassine, A. A., & Wissmann, L. A. 2007. The implications of product architecture on the firm. *Systems Engineering*, 10(2): 118-137.
- Yin, R. K. 1981. The Case-Study Crisis - Some Answers. *Administrative Science Quarterly*, 26(1): 58-65.
- Yin, R. K. 1994. *Case study research - design and methods*. Thousand Oaks, CA: Sage Publications.
- Zhang, X. Y., & Huang, G.Q. 2010. Game-theoretic approach to simultaneous configuration of platform products and supply chains with one manufacturing firm and multiple cooperative suppliers. *International Journal of Production Economics*, 124(1): 121-136.
- Zhang, X. Y., Huang, G.Q., & Rungtusanatham, M. J. 2008. Simultaneous configuration of platform products and manufacturing supply chains. *International Journal of Production Research*, 46(21): 6137-6162.
- Zirpoli, F., & Becker, M. C. 2011. The limits of design and engineering outsourcing: performance integration and the unfulfilled promises of modularity. *R & D Management*, 41(1): 21-43.

Zwerink, R., Wouters, M., Hissel, P., & Kerssens-Van Drongelen, I. 2007. Cost management and cross-functional communication through product architectures. *R & D Management*, 37(1): 49-64.

Appendix 1 List of journals from which articles were retrieved through Web of Science

| Journal | Articles | In Web of Science since |
|---|-----------------|--------------------------------|
| CONCURRENT ENGINEERING-RESEARCH AND APPLICATIONS | 16 | 1994 Vol. 2, issue 1 |
| INTERNATIONAL JOURNAL OF TECHNOLOGY MANAGEMENT | 14 | 1994 vol. 9, issue 5-7 |
| INTERNATIONAL JOURNAL OF PRODUCTION RESEARCH | 14 | 1977 Vol. 15, issue 1 |
| STRATEGIC MANAGEMENT JOURNAL | 12 | 1980 Vol. 1, issue 1 |
| INTERNATIONAL JOURNAL OF OPERATIONS & PRODUCTION MANAGEMENT | 12 | 1994 Vol. 14, issue 8 |
| MANAGEMENT SCIENCE | 10 | 1954 Vol. 1, issue 1 |
| RESEARCH POLICY | 9 | 1974 Vol. 3, issue 1 |
| IEEE TRANSACTIONS ON ENGINEERING MANAGEMENT | 9 | 1963 Vol. 10, issue 1 |
| ORGANIZATION SCIENCE | 7 | 1992 Vol. 3, issue 1 |
| INTERNATIONAL JOURNAL OF COMPUTER INTEGRATED MANUFACTURING | 7 | 1989 Vol. 2, issue 1 |
| JOURNAL OF OPERATIONS MANAGEMENT | 6 | 1999 Vol. 18, issue 1 |
| INFORMATION SYSTEMS RESEARCH | 6 | 1994 Vol. 5, issue 1 |
| JOURNAL OF PRODUCT INNOVATION MANAGEMENT | 5 | 1984 Vol. 1, issue 1 |
| PRODUCTION PLANNING & CONTROL | 5 | 1994 Vol. 5, issue 1 |
| ORGANIZATION STUDIES | 4 | 1981 Vol. 2, issue 1 |
| EUROPEAN JOURNAL OF OPERATIONAL RESEARCH | 4 | 1978 Vol. 2, issue 1 |
| CALIFORNIA MANAGEMENT REVIEW | 3 | 1958 Vol. 1, issue 1 |
| EXPERT SYSTEMS WITH APPLICATIONS | 3 | 1991 Vol. 2, issue 1 |
| INTERNATIONAL JOURNAL OF PRODUCTION ECONOMICS | 3 | 1991 Vol. 22, issue 1 |
| DECISION SCIENCES | 3 | 1984 Vol. 15, issue 2 |
| TECHNOVATION | 3 | 1981 Vol. 1, issue 1 |
| INDUSTRIAL AND CORPORATE CHANGE | 3 | 2002 Vol. 11, issue 2 |
| INDUSTRY AND INNOVATION | 3 | 2008 Vol. 15, issue 1* |
| JOURNAL OF INFORMATION TECHNOLOGY | 2 | 1993 Vol. 8, issue 1 |
| JOURNAL OF ECONOMIC BEHAVIOR & ORGANIZATION | 2 | 1980 Vol. 1, issue 1 |
| ACADEMY OF MANAGEMENT REVIEW | 2 | 1983 Vol. 8, issue 2 |
| SYSTEMS ENGINEERING | 2 | 2007 Vol. 10, issue 2† |
| ADMINISTRATIVE SCIENCE QUARTERLY | 2 | 1956 Vol. 1, issue 1 |

| Journal | Articles | In Web of Science since | |
|---|-----------------|--------------------------------|-------------------|
| TECHNOLOGICAL FORECASTING AND SOCIAL CHANGE | 2 | 1969 | Vol. 1, issue 1 |
| RELIABILITY ENGINEERING & SYSTEM SAFETY | 2 | 1981 | Vol. 2, issue 3 |
| HARVARD BUSINESS REVIEW | 2 | 1956 | Vol. 34, issue 1 |
| INFORMATION & MANAGEMENT | 2 | 1983 | Vol. 17, issue 1 |
| R & D MANAGEMENT | 2 | 1970 | Vol. 1, issue 1 |
| JOURNAL OF MANAGEMENT INFORMATION SYSTEMS | 2 | 1999 | Vol. 16, issue 2 |
| INDUSTRIAL MARKETING MANAGEMENT | 2 | 1971 | Vol. 1, issue 1 |
| INTERNATIONAL JOURNAL OF FLEXIBLE MANUFACTURING SYSTEMS | 2 | 1995 | Vol. 7, issue 1 |
| JOURNAL OF ENGINEERING AND TECHNOLOGY MANAGEMENT | 2 | 1994 | Vol. 11, issue 1 |
| COMPUTER INTEGRATED MANUFACTURING SYSTEMS | 1 | 1988 | Vol. 1, issue 1 |
| REVUE D ECONOMIE POLITIQUE | 1 | 1976 | Vol. 86, issue 1 |
| MIS QUARTERLY | 1 | 1984 | Vol. 8, issue 2 |
| ACADEMY OF MANAGEMENT JOURNAL | 1 | 1958 | Vol. 1, issue 1 |
| INFORMATION TECHNOLOGY & MANAGEMENT | 1 | 2008 | Vol. 9, issue 3* |
| AUSTRALIAN ECONOMIC HISTORY REVIEW | 1 | 1967 | Vol. 7, issue 1 |
| RESEARCH-TECHNOLOGY MANAGEMENT | 1 | 1988 | Vol. 31, issue 1 |
| JOURNAL OF COMPARATIVE ECONOMICS | 1 | 1981 | Vol. 5, issue 3 |
| SUPPLY CHAIN MANAGEMENT-AN INTERNATIONAL JOURNAL | 1 | 2003 | Vol. 8, issue 2* |
| IIE TRANSACTIONS | 1 | 1982 | Vol. 14, issue 1 |
| JOURNAL OF EVOLUTIONARY ECONOMICS | 1 | 1996 | Vol. 6, issue 1 |
| INFORMATION ECONOMICS AND POLICY | 1 | 2000 | Vol. 12, issue 4 |
| PRODUCTION AND OPERATIONS MANAGEMENT | 1 | 1999 | Vol. 8, issue 2 |
| JOURNAL OF INTERNATIONAL MANAGEMENT | 1 | 2007 | Vol. 13, issue 1* |
| INTERFACES | 1 | 1974 | Vol. 4, issue 2 |
| JOURNAL OF MANUFACTURING SYSTEMS | 1 | 1983 | Vol. 2, issue 1 |
| REVIEW OF INTERNATIONAL POLITICAL ECONOMY | 1 | 1997 | Vol. 4, issue 1 |
| JOURNAL OF MARKETING | 1 | 1956 | Vol. 20, issue 3 |
| BUSINESS STRATEGY OVER THE INDUSTRY LIFE CYCLE | 1 | 1995 | Vol. 11 |
| ASIA PACIFIC JOURNAL OF MANAGEMENT | 1 | 2008 | Vol. 25, issue 1* |

| Journal | Articles | In Web of Science since | |
|--|-----------------|--------------------------------|-------------------|
| M&SOM-MANUFACTURING & SERVICE OPERATIONS MANAGEMENT | 1 | 2006 | Vol. 8, issue 2 |
| JAPAN AND THE WORLD ECONOMY | 1 | 1993 | Vol. 5, issue 1 |
| SYSTEMIC PRACTICE AND ACTION RESEARCH | 1 | 1998 | Vol. 11, issue 1 |
| EUROPEAN MANAGEMENT JOURNAL | 1 | 2009 | Vol. 27, issue 1 |
| INTERNATIONAL JOURNAL OF LOGISTICS MANAGEMENT | 1 | 2009 | Vol. 20, issue 1 |
| INTERNATIONAL JOURNAL OF MANAGEMENT REVIEWS | 1 | 2003 | Vol. 3, issue 1 |
| ASIAN JOURNAL OF TECHNOLOGY INNOVATION | 1 | 2008 | Vol. 16, issue 1 |
| COMPUTATIONAL ECONOMICS | 1 | 2008 | Vol. 31, issue 1 |
| MIS QUARTERLY EXECUTIVE | 1 | 2008 | Vol. 7, issue 1 |
| JOURNAL OF MANAGEMENT & ORGANIZATION | 1 | 2007 | Vol. 13, issue 1† |
| DEFENCE AND PEACE ECONOMICS | 1 | 1994 | Vol. 5, issue 1† |
| DISCRETE EVENT DYNAMIC SYSTEMS-THEORY AND APPLICATIONS | 1 | 1995 | Vol. 5, issue 1† |
| JOURNAL OF WORLD BUSINESS | 1 | 1997 | Vol. 32, issue 1 |
| GROUP DECISION AND NEGOTIATION | 1 | 1995 | Vol. 4, issue 1 |
| TECHNOLOGY ANALYSIS & STRATEGIC MANAGEMENT | 1 | 1994 | Vol. 6, issue 1 |
| AFRICAN JOURNAL OF BUSINESS MANAGEMENT | 1 | 2007 | Vol. 1, issue 1 |
| Total relevant articles | 225 | | |

* Journal checked in EBSCO, SpringerLink, ScienceDirect or Emerald for relevant articles published outside the volume range included in Web of Science

† No electronic access to journal

Appendix 2 Factor analysis for bibliographic coupling

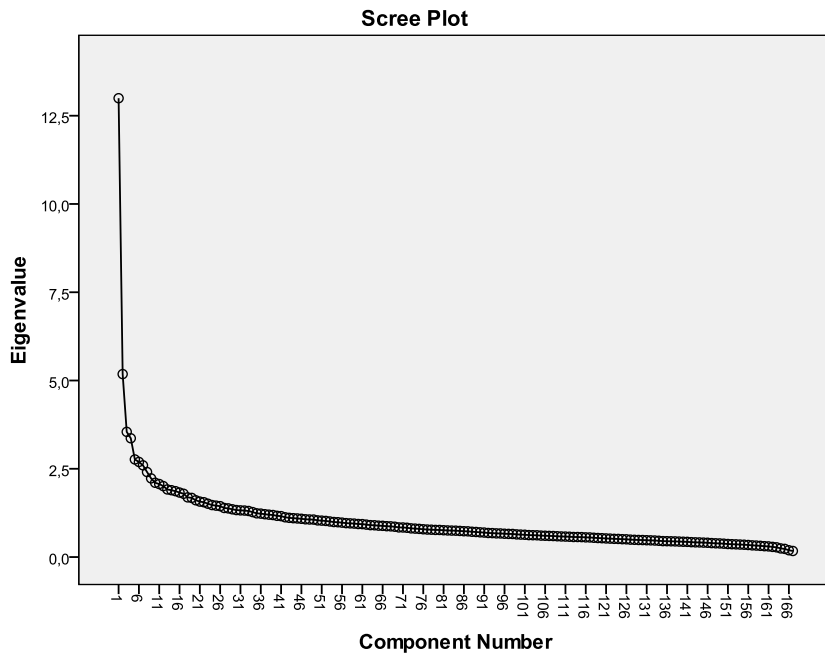

Eigenvalue cut-off point chosen: 1,75

Resulting number of components: 17

Rotated Component Matrix*

| | Component | | | | | | | | | | | | | | | | |
|--|--------------|-------|-------|-------|-------|-------|-------|-------|-------|-------|-------|-------|-------|-------|-------|-------|-------|
| | 1 | 2 | 3 | 4 | 5 | 6 | 7 | 8 | 9 | 10 | 11 | 12 | 13 | 14 | 15 | 16 | 17 |
| Frigant (2007) | -548 | .067 | .064 | .043 | -.142 | .059 | .093 | -.030 | .052 | .119 | .052 | .026 | -.174 | -.051 | -.023 | -.015 | -.003 |
| Brunson (2005) | -491 | .003 | .010 | .004 | -.031 | .032 | .083 | -.022 | .003 | .042 | -.005 | -.041 | .019 | .047 | .280 | .122 | -.092 |
| Chesbrough & Kamp; Prencipe (2008) | -483 | -.144 | -.054 | .035 | .029 | -.068 | -.076 | .010 | .074 | -.014 | .115 | .048 | -.057 | .047 | -.063 | -.042 | -.036 |
| Gentry & Kamp; Elms (2009) | -476 | -.070 | .086 | .025 | -.019 | .045 | .272 | -.019 | -.039 | -.009 | .047 | -.044 | -.110 | .163 | .071 | -.011 | .090 |
| Campagnolo & Camuffo (2009) | -465 | -.046 | .093 | .045 | -.016 | .034 | .164 | -.020 | -.073 | -.093 | .028 | .038 | -.027 | .119 | -.003 | -.149 | .000 |
| Mozzo & Kamp; Grimsaw (2005) | -431 | .100 | .037 | -.034 | -.156 | -.002 | -.004 | -.022 | -.051 | -.045 | .073 | .096 | .012 | .090 | .180 | -.144 | .000 |
| Brunson & Kamp; Prencipe (2006) | -426 | -.057 | .049 | .309 | -.039 | -.039 | .062 | -.001 | .178 | .030 | -.051 | .036 | -.067 | .043 | -.095 | .201 | -.002 |
| Campagnolo & Kamp; Camuffo (2010) | -412 | .007 | .083 | .057 | .092 | .156 | .282 | -.033 | -.094 | .008 | .063 | -.060 | .130 | .076 | .130 | .018 | -.043 |
| Zirpoli & Kamp; Becker (2011) | -404 | .046 | -.007 | .046 | .004 | .007 | -.091 | -.001 | .041 | .062 | .171 | .093 | .014 | -.123 | .308 | .076 | .008 |
| Fiscion & Kamp; Park (2008) | -403 | .154 | .135 | .008 | -.074 | .075 | .046 | -.013 | .037 | .083 | .025 | -.007 | .235 | .037 | .055 | -.089 | .010 |
| Funk (2008) | -391 | .303 | .014 | .075 | .284 | -.008 | .112 | .013 | -.023 | .102 | .023 | -.056 | -.023 | .035 | -.100 | .071 | .075 |
| Argyres & Kamp; Bigelow (2010) | -382 | .162 | .009 | .013 | .022 | -.023 | .087 | .009 | .133 | .014 | -.048 | -.011 | .130 | .152 | -.082 | -.091 | .189 |
| Wang (2008) | -344 | .220 | .068 | .065 | .057 | .235 | .077 | -.027 | -.085 | .074 | -.053 | .048 | .091 | .003 | .061 | .091 | .097 |
| Gomes & Kamp; Dahab (2010) | -340 | -.055 | .021 | .071 | .025 | -.029 | .034 | .048 | .174 | -.052 | .058 | -.033 | .112 | .115 | .213 | .076 | .163 |
| Jacobides & Kamp; Billinger (2006) | -327 | -.037 | -.015 | .034 | -.061 | -.033 | -.030 | .002 | .047 | .089 | -.033 | .023 | .219 | .152 | -.020 | .147 | .152 |
| Susarla et al. (2010) | -314 | .034 | .041 | .034 | .001 | -.006 | .284 | .002 | .163 | .135 | .136 | .051 | .132 | .093 | -.133 | -.052 | .160 |
| Jaspers & Kamp; van den Ende (2010) | -311 | .216 | -.051 | .055 | .059 | -.056 | .098 | .004 | -.018 | .097 | .123 | .136 | .073 | .054 | -.081 | -.005 | -.011 |
| Garud & Kamp; Munir (2008) | -302 | .172 | .068 | .091 | .233 | -.045 | .079 | .053 | .253 | .277 | .009 | .006 | .007 | -.017 | -.123 | -.091 | .073 |
| Ulku & Kamp; Schmidt (2011) | -294 | .045 | .148 | .034 | .024 | .213 | .271 | -.008 | .079 | .068 | .004 | -.033 | .112 | .082 | .243 | -.020 | .189 |
| Ceci & Kamp; Masciarelli (2010) | -291 | -.003 | -.025 | .035 | -.060 | .046 | .041 | .039 | .049 | -.105 | .154 | .089 | .224 | .160 | -.016 | -.020 | .151 |
| Schmickl & Kieser (2008) | -266 | .204 | -.016 | .051 | .027 | .034 | .058 | .026 | .122 | .221 | .236 | .214 | .016 | -.112 | .257 | .120 | .010 |
| Ehrijaj (2007) | -241 | .112 | .066 | .161 | .157 | .009 | .009 | .071 | .029 | -.109 | .027 | .095 | .057 | -.017 | .065 | -.006 | -.001 |
| Bierly et al. (2008) | -228 | .136 | .027 | .067 | .012 | .087 | .171 | .105 | -.092 | .147 | -.058 | .008 | -.136 | .016 | .130 | .003 | .104 |
| Hoetker (2006) | -187 | .052 | .046 | .090 | .094 | .000 | .201 | -.048 | -.060 | -.048 | -.120 | .007 | .138 | .056 | .165 | .104 | .000 |
| Buganza & Kamp; Verganti (2006) | -1035 | .673 | .056 | .008 | -.092 | .058 | -.040 | .004 | .085 | .005 | .067 | -.056 | .036 | .123 | .008 | .195 | .019 |
| Verganti & Kamp; Buganza (2005) | -036 | .661 | .049 | .023 | -.103 | .052 | -.020 | -.002 | .070 | -.031 | .083 | -.060 | .077 | .110 | .021 | .186 | .019 |
| Jones (2003) | -001 | .506 | .008 | .118 | .157 | .009 | -.009 | .071 | .029 | -.109 | .027 | .095 | .057 | -.017 | .065 | -.006 | -.001 |
| MacCormack & Kamp; Iansiti (2009) | -098 | .459 | -.015 | .028 | -.018 | .061 | .011 | -.012 | .167 | .091 | .109 | .123 | .034 | -.293 | .089 | .010 | .015 |
| Chen & Kamp; Liu (2005) | -046 | .436 | .102 | .081 | -.237 | .010 | .001 | -.019 | -.055 | .043 | .052 | .021 | -.038 | .000 | .167 | .009 | .049 |
| Murnann & Kamp; Frenken (2006) | -199 | .436 | .012 | .160 | .117 | .026 | .144 | -.023 | -.014 | .135 | -.046 | -.028 | .107 | -.001 | .048 | -.161 | -.014 |
| Cebon et al. (2008) | -184 | .401 | .169 | .024 | .332 | .015 | .082 | .024 | -.032 | .031 | -.102 | .018 | -.115 | .074 | .043 | -.090 | .135 |
| Galvignon et al. (2002) | -152 | .396 | .044 | .059 | .129 | -.028 | .144 | .024 | .143 | .034 | -.019 | .049 | -.053 | .105 | -.063 | -.155 | -.045 |
| Ehrijaj & Kamp; Rice (2008) | -152 | .301 | .125 | .048 | .266 | .120 | .194 | -.041 | .134 | .115 | -.019 | .105 | .112 | -.049 | -.073 | .051 | .106 |
| Stephan et al. (2008) | -085 | .261 | .041 | .097 | .147 | .003 | .142 | .008 | .024 | .161 | .124 | .006 | -.022 | .000 | .167 | .000 | .049 |
| Andersen (2006) | -128 | .130 | .092 | -.027 | -.041 | .099 | -.116 | -.061 | .015 | .054 | -.050 | .116 | .058 | .064 | .010 | .046 | -.038 |
| Tu (2004) | -120 | .099 | .542 | .039 | .039 | .090 | .197 | -.051 | -.013 | -.004 | .065 | -.018 | -.093 | .086 | .030 | .062 | .077 |
| Salvador et al. (2004) | -127 | .014 | .510 | -.022 | .067 | .186 | -.039 | .031 | .082 | .089 | -.032 | -.017 | -.034 | .052 | .011 | -.011 | -.039 |
| Fredriksson & Kamp; Gadde (2005) | -029 | .025 | .440 | -.023 | .005 | .107 | -.048 | .040 | .094 | -.087 | .030 | .022 | .039 | .063 | .014 | -.054 | -.049 |
| Nikola (2007) | -028 | .013 | .408 | -.008 | -.038 | -.003 | .112 | .040 | .080 | .177 | .040 | .080 | .177 | .040 | .080 | .177 | .040 |
| Kumar (2004) | -044 | -.046 | .425 | .015 | -.035 | -.042 | -.031 | -.049 | .031 | -.065 | .074 | -.008 | .011 | -.013 | -.082 | -.029 | .070 |
| Jacobs et al. (2011) | -088 | .024 | .425 | .058 | .060 | .234 | .172 | .003 | -.015 | .019 | .164 | -.087 | -.024 | .114 | -.010 | .092 | .011 |
| Lury et al. (2000) | -075 | -.041 | .412 | -.071 | .097 | -.074 | -.007 | .012 | .066 | -.057 | .097 | -.007 | .002 | .055 | -.012 | -.077 | -.028 |
| Din et al. (2009) | -107 | .084 | .404 | -.017 | .017 | .164 | .099 | -.067 | -.111 | .043 | -.028 | .014 | .072 | -.142 | .187 | .113 | .023 |
| Salvador et al. (2002) | -079 | .068 | .079 | -.068 | .035 | .237 | -.131 | .119 | -.037 | -.111 | .037 | -.088 | .060 | -.004 | .044 | -.004 | .044 |
| Jacobs et al. (2007) | -097 | .030 | .364 | -.066 | .034 | .251 | .176 | .079 | .021 | .028 | .216 | -.079 | .022 | .106 | -.070 | .099 | -.025 |
| de Blok et al. (2010) | -122 | .162 | .341 | -.017 | -.078 | .062 | .090 | -.087 | -.067 | .258 | .071 | .009 | -.032 | -.079 | .116 | .221 | .103 |
| Ro et al. (2007) | -150 | .110 | .332 | .022 | .048 | .069 | -.064 | -.039 | .102 | .247 | .055 | .102 | .166 | .044 | .136 | .281 | .103 |
| Pero et al. (2010) | -107 | .049 | .329 | -.029 | -.072 | .202 | .170 | .161 | -.021 | -.026 | .125 | .055 | .012 | -.079 | .215 | .106 | .104 |
| Fredriksson (2006) | -260 | .066 | .260 | -.066 | .020 | .020 | .020 | .020 | .020 | .020 | .020 | .020 | .020 | .020 | .020 | .020 | .020 |
| Voss & Kamp; Hsuan (2009) | -057 | .127 | .300 | .041 | .008 | .195 | .126 | -.024 | -.187 | .199 | .084 | .020 | -.006 | -.131 | .032 | .059 | .240 |
| Mikola (2003) | -065 | .178 | .299 | -.050 | .248 | .110 | .003 | .052 | .073 | -.062 | .119 | .136 | .080 | -.069 | .041 | .096 | .144 |
| Rungtusanatham & Kamp; Salvador (2008) | -067 | -.034 | .232 | .036 | -.006 | -.055 | -.019 | .054 | -.044 | .040 | .039 | -.011 | .000 | .011 | .020 | .029 | -.044 |
| Siggelkow & Kamp; Rivkin (2003) | -040 | -.013 | -.006 | .608 | -.008 | -.038 | -.003 | -.011 | .039 | -.005 | -.042 | .052 | .021 | -.038 | .088 | .161 | -.032 |
| Siggelkow & Kamp; Levinthal (2003) | -041 | -.012 | .041 | .588 | .024 | .015 | .150 | .006 | .069 | .071 | .033 | .024 | .093 | .115 | .073 | .131 | .100 |
| Gavetti et al. (2005) | -063 | .096 | .017 | .583 | .008 | .021 | -.091 | -.008 | .005 | .079 | .015 | .025 | .038 | .108 | -.019 | -.095 | -.066 |
| Ehrijaj & Kamp; Levinthal, D (2004) | -061 | .021 | .023 | .559 | .073 | .027 | .153 | .034 | .097 | .026 | .010 | -.053 | .030 | .156 | .189 | -.020 | -.004 |
| Ehrijaj & Kamp; Levinthal (2009) | -076 | -.086 | -.016 | .549 | -.010 | .091 | -.049 | -.019 | -.021 | .069 | .011 | -.110 | .102 | -.058 | -.009 | .021 | .056 |
| Ehrijaj & Kamp; Levinthal (2004) | -022 | .112 | -.011 | .487 | .047 | -.023 | -.013 | .021 | .132 | .034 | .111 | .049 | .057 | .052 | .033 | .017 | .039 |
| Sinha & Kamp; Van de Ven (2005) | -064 | .009 | .061 | .457 | -.035 | .019 | .029 | .004 | -.021 | -.175 | -.130 | -.026 | .041 | -.026 | -.008 | .268 | .078 |
| Yayavaram & Ahuja (2008) | -141 | .123 | -.004 | .455 | .062 | -.055 | .102 | .001 | .088 | .131 | .089 | .223 | .099 | .042 | .109 | -.091 | .007 |
| Ehrijaj et al. (2008) | -006 | -.099 | .014 | .420 | .043 | .146 | -.004 | -.044 | -.030 | .205 | -.014 | .083 | .203 | .140 | .078 | .011 | .076 |
| Geisendorf (2010) | -046 | .047 | .041 | .394 | -.035 | .030 | .076 | -.003 | -.055 | .026 | .028 | -.031 | -.006 | -.008 | .318 | .187 | -.067 |
| Fleming & Kamp; Sorenson (2001a) | -097 | .239 | .028 | .360 | .054 | .027 | -.063 | .009 | .123 | .025 | .008 | .058 | .099 | .053 | .214 | -.215 | -.071 |
| Caminati (2006) | -242 | .100 | -.038 | .324 | .052 | -.024 | .060 | .047 | -.025 | .125 | .093 | .026 | -.029 | -.064 | .069 | -.123 | .120 |
| Pil & Kamp; Cohen (2006) | -173 | .218 | .047 | .270 | .170 | .208 | .194 | .004 | -.038 | .047 | .085 | .109 | .012 | .169 | .118 | .034 | -.006 |
| Sanchez (199 | | | | | | | | | | | | | | | | | |

Rotated Component Matrix^a

| | Component | | | | | | | | | | | | | | | | |
|------------------------------|-----------|-------|-------|-------|-------|-------|-------------|-------------|-------------|-------------|-------------|-------------|-------------|-------------|-------------|-------------|-------|
| | 1 | 2 | 3 | 4 | 5 | 6 | 7 | 8 | 9 | 10 | 11 | 12 | 13 | 14 | 15 | 16 | 17 |
| Tiwana & Konsynski (2010) | .049 | -.001 | -.031 | .031 | -.005 | -.052 | .536 | -.022 | .075 | .061 | 0.10 | .031 | -.015 | -.056 | .151 | -.075 | -.049 |
| Bush et al. (2010) | .054 | .033 | .099 | 0.10 | 0.030 | .090 | .532 | .023 | -.056 | .038 | .13 | -.024 | .036 | -.002 | .230 | .103 | .013 |
| Tiwana (2008a) | -.208 | .018 | -.062 | -.032 | .013 | -.032 | .446 | .000 | .054 | .029 | .232 | .020 | .039 | -.025 | -.121 | .070 | -.027 |
| Taniguchi et al. (2007) | .107 | .049 | -.023 | .118 | .077 | -.002 | .364 | -.010 | -.115 | .011 | .026 | .164 | .085 | -.004 | .110 | .157 | .000 |
| Grote & Taube (2007) | .121 | .103 | -.014 | .110 | -.025 | -.032 | .293 | -.016 | .008 | .038 | .023 | .140 | .194 | .130 | -.057 | -.030 | .250 |
| Tiwana et al. (2010) | -.178 | .081 | .055 | .080 | -.016 | .086 | .286 | -.026 | .103 | .268 | .012 | .009 | -.003 | .018 | -.011 | -.045 | .080 |
| Eom (2008) | -.222 | .214 | .030 | .073 | .199 | .035 | .255 | -.028 | -.091 | .104 | .006 | .070 | .119 | -.062 | .020 | .006 | -.080 |
| Gossain et al. (2004) | .002 | .083 | .079 | .051 | .153 | -.070 | .247 | -.027 | -.055 | -.179 | .019 | .051 | -.030 | .156 | .098 | .201 | .109 |
| Huang et al. (2007) | -.047 | .000 | .074 | -.010 | .015 | .088 | .096 | .813 | -.008 | .004 | -.001 | -.027 | -.005 | -.009 | -.026 | .022 | -.021 |
| Zhang & Huang (2010) | -.020 | .000 | .030 | -.017 | -.008 | .099 | -.003 | .804 | .007 | -.015 | .017 | -.001 | .007 | .006 | .041 | .020 | -.018 |
| Huang et al. (2005) | -.033 | .010 | -.007 | -.016 | .010 | .083 | .011 | .803 | -.027 | .010 | -.040 | -.040 | -.019 | .003 | -.010 | .036 | -.018 |
| Zhang et al. (2008) | -.026 | -.007 | .038 | -.029 | -.025 | .124 | .017 | .799 | .012 | -.027 | .057 | -.038 | .011 | .000 | .065 | .029 | -.001 |
| Danese & Romano (2004) | -.062 | .049 | .270 | .114 | .027 | .108 | -.014 | .532 | .195 | -.058 | .065 | .082 | .014 | -.119 | -.074 | .056 | .024 |
| Soxa et al. (2004) | .104 | .050 | .019 | .091 | .019 | .200 | .089 | .010 | .596 | -.068 | .064 | .020 | .052 | -.011 | .019 | .007 | .086 |
| Browning (2001) | -.046 | .022 | .013 | .010 | .056 | .024 | -.026 | -.011 | .450 | .029 | -.037 | -.063 | -.012 | .060 | .010 | -.029 | -.067 |
| Loch et al. (2003) | -.124 | -.016 | -.026 | .256 | -.017 | -.003 | .002 | -.055 | .423 | -.055 | -.067 | -.009 | .010 | -.081 | .236 | .098 | .049 |
| Fixson (2005) | -.108 | .042 | .207 | .021 | .085 | .306 | .071 | .139 | .383 | .069 | .071 | .011 | .064 | -.004 | -.028 | -.007 | -.006 |
| Hulberman & Wilkinson (2010) | -.140 | .056 | -.033 | .070 | -.090 | .118 | .033 | -.076 | .378 | .000 | .006 | .004 | .079 | -.112 | .267 | .034 | .952 |
| Loch et al. (2001) | -.089 | .120 | .013 | -.001 | .090 | .074 | .024 | .030 | .307 | .009 | -.001 | .066 | -.011 | .033 | .276 | .041 | -.066 |
| MacCormack et al. (2006) | -.144 | .211 | .048 | .063 | .007 | .090 | .171 | -.036 | .353 | .128 | .036 | -.025 | .025 | .045 | -.085 | -.042 | -.004 |
| Staudenmayer et al. (2005) | .204 | .120 | .081 | .087 | .180 | .012 | .007 | .053 | .345 | .195 | -.031 | .092 | -.073 | -.002 | -.008 | .236 | .006 |
| Gokpinar et al. (2010) | .022 | .150 | .026 | .055 | -.055 | .137 | .256 | .020 | .321 | .181 | .127 | .189 | -.018 | -.032 | .133 | .074 | .991 |
| Hong et al. (2009) | .071 | -.036 | .043 | .095 | .072 | -.083 | .080 | .003 | .237 | .000 | .113 | .020 | .070 | .080 | -.085 | -.069 | .204 |
| Gnar et al. (2010) | -.098 | -.013 | -.068 | .051 | .071 | .012 | .129 | -.024 | -.158 | -.020 | .034 | .015 | .095 | .125 | .080 | .047 | -.144 |
| Gil (2009) | -.016 | -.001 | -.029 | .033 | -.038 | .053 | -.011 | -.036 | .034 | .697 | .069 | .002 | .078 | -.025 | .065 | .163 | .010 |
| Gil (2007) | -.025 | .000 | .007 | .040 | -.016 | .059 | .071 | -.010 | .096 | .600 | .000 | .009 | .052 | .041 | .040 | .084 | .039 |
| Garud et al. (2008) | .059 | -.045 | .028 | .138 | .201 | -.074 | .120 | .013 | .049 | .307 | -.079 | -.054 | .082 | .044 | .250 | .021 | -.136 |
| Marne & van de Kragt (2009) | .066 | -.069 | .016 | .066 | -.016 | -.002 | .082 | -.029 | .018 | -.028 | .029 | .018 | -.028 | -.028 | -.028 | -.028 | -.028 |
| Chies et al. (2010) | .179 | .050 | .046 | .115 | .044 | -.008 | .194 | -.006 | -.006 | .197 | -.022 | -.024 | .146 | .121 | .013 | .064 | .103 |
| Antonio et al. (2009) | .127 | .008 | .160 | .022 | .011 | .123 | .085 | .033 | -.046 | .071 | .669 | .053 | -.079 | .090 | .068 | .055 | .036 |
| Antonio et al. (2007) | .029 | .036 | .227 | .059 | .086 | .117 | .068 | -.020 | -.046 | .103 | .012 | -.060 | .014 | .058 | -.078 | -.008 | .010 |
| Lau, Yam & Tang (2010) | .094 | .025 | .209 | .057 | .105 | .142 | .031 | .060 | -.046 | .080 | .594 | -.034 | -.034 | -.013 | .001 | .032 | .012 |
| Lau et al. (2010) | .040 | .016 | .180 | .040 | .040 | .040 | .040 | .040 | .040 | .040 | .356 | .040 | .040 | .040 | .040 | .040 | .040 |
| Danese & Filippini (2010) | .020 | .034 | .129 | .014 | -.025 | .108 | .183 | -.027 | .162 | .007 | .340 | -.035 | -.025 | .075 | -.004 | .036 | .110 |
| Howard & Squire (2007) | .013 | .037 | .130 | .041 | .141 | -.038 | .093 | .019 | .143 | -.169 | .289 | .055 | .167 | .039 | -.008 | .196 | .053 |
| Squire et al. (2009) | -.002 | .059 | .062 | -.028 | .031 | -.083 | .072 | -.043 | .066 | -.145 | .263 | .067 | .049 | .076 | .026 | .118 | .065 |
| Lei (2000) | -.009 | .019 | -.051 | .018 | -.004 | .045 | -.052 | -.021 | -.062 | .013 | -.031 | .669 | .008 | .179 | -.050 | .049 | -.063 |
| Lei (2003) | .090 | .035 | .003 | .002 | .002 | .002 | .002 | .002 | .002 | .002 | .002 | .608 | .002 | .002 | .002 | .002 | .002 |
| Lei et al. (1996) | -.064 | -.085 | .087 | .025 | .077 | .009 | -.087 | -.010 | -.021 | -.008 | -.008 | .516 | .085 | .131 | -.009 | -.048 | .051 |
| Kusunoki et al. (1998) | .052 | .060 | -.002 | -.024 | .034 | -.027 | -.108 | .005 | .200 | -.055 | .026 | .417 | .013 | .086 | .084 | -.027 | -.017 |
| Arikun (2009) | .060 | .117 | .007 | .064 | .004 | -.013 | .235 | -.008 | -.080 | .003 | -.037 | .371 | .014 | -.020 | -.056 | .105 | -.052 |
| Grunwald & Kieser (2007) | .176 | .123 | -.045 | .033 | .067 | -.018 | .096 | -.001 | .035 | .076 | .172 | .363 | .115 | .136 | .156 | .107 | .043 |
| Mallotra et al. (2005) | -.014 | .000 | .090 | .092 | .046 | -.045 | .077 | .013 | .015 | .079 | .063 | .286 | .053 | .001 | .352 | .130 | .107 |
| Lombardi (2003) | -.005 | .108 | .092 | .219 | .023 | -.010 | .174 | .004 | -.055 | .098 | -.066 | .258 | .182 | .074 | -.106 | .052 | .025 |
| Djelic & Ainamo (1999) | .025 | -.075 | .021 | .074 | .046 | -.072 | .014 | .004 | .007 | -.031 | -.114 | .165 | .134 | .132 | .111 | .026 | -.054 |
| Langlois (2006) | .122 | .048 | -.036 | .071 | .039 | -.006 | .093 | .003 | -.057 | .011 | -.035 | -.005 | .603 | -.066 | -.028 | .015 | -.065 |
| Langlois (2002) | .078 | .119 | .043 | .029 | .182 | -.029 | .110 | .006 | .046 | .039 | -.060 | .017 | .554 | -.023 | -.074 | .041 | -.031 |
| Langlois & Garzarella (2008) | .205 | .086 | .054 | .027 | .159 | .090 | .006 | .030 | .024 | .178 | .060 | .047 | .409 | .051 | .025 | .106 | -.035 |
| Baldwin (2008) | .331 | -.001 | .001 | .208 | .069 | .003 | .018 | .011 | .116 | .021 | -.034 | -.027 | .378 | .119 | .215 | .005 | .043 |
| Press & Geipel (2010) | .278 | .117 | -.063 | .252 | .058 | .016 | .148 | -.014 | -.146 | -.094 | .006 | -.016 | .314 | .122 | .112 | .064 | -.171 |
| Helper & Sako (2010) | .241 | -.075 | .023 | .012 | .037 | -.033 | .034 | .052 | .060 | .105 | .118 | .045 | .311 | -.020 | .289 | -.018 | .025 |
| Christensen et al. (2002) | .256 | .234 | .129 | .046 | .066 | .143 | .077 | .027 | .122 | .015 | .054 | .094 | .290 | .043 | .096 | .022 | .060 |
| Spring & Araujo (2009) | .040 | -.020 | .072 | -.044 | -.047 | -.068 | -.040 | -.027 | -.014 | .039 | .004 | .040 | .154 | .080 | .013 | .040 | .069 |
| Karim (2006) | .152 | .100 | .059 | .103 | .184 | -.001 | .154 | -.008 | .040 | .037 | .044 | .101 | .001 | .573 | .078 | .058 | .043 |
| Martin & Eisenhardt (2004) | .077 | .173 | -.046 | .119 | -.038 | -.031 | -.047 | -.002 | .010 | -.020 | .043 | .178 | -.055 | .453 | .010 | .000 | -.044 |
| Hellat & Eisenhardt (2004) | .016 | .034 | -.043 | .023 | .067 | -.048 | -.062 | -.004 | .020 | .082 | .033 | .069 | -.024 | .395 | -.025 | -.016 | .034 |
| Schilling & Steensma (2001) | .098 | .017 | .023 | .043 | .185 | .022 | .156 | -.035 | -.060 | .008 | -.064 | .121 | .124 | .380 | -.033 | .251 | .044 |
| Schilling (2000) | .094 | .188 | .073 | .144 | .291 | .028 | .128 | -.013 | -.037 | .078 | -.026 | .086 | .099 | .322 | .074 | .112 | -.089 |
| Robertson & Verona (2006) | .259 | .258 | .020 | .054 | .001 | -.005 | .042 | -.016 | -.037 | -.009 | -.010 | .182 | .231 | .281 | -.007 | -.009 | .017 |
| Jacobides (2006) | .130 | .020 | .014 | .206 | .004 | -.027 | -.102 | .013 | -.008 | .040 | .000 | -.036 | .219 | .265 | .243 | .009 | .030 |
| Parmigiani & Mitchell (2009) | .255 | .087 | -.066 | .117 | -.029 | -.076 | -.017 | .006 | .024 | .010 | .102 | .105 | .184 | .261 | -.027 | .091 | .128 |
| Cerelli et al. (2005) | .204 | -.021 | .120 | -.018 | -.076 | .124 | -.022 | .030 | -.036 | .050 | .071 | .003 | .034 | .205 | .140 | .006 | .099 |
| Vaccaro et al. (2011) | .102 | .137 | -.021 | .156 | .038 | .007 | -.053 | -.028 | -.017 | .146 | .137 | .110 | .023 | -.056 | .341 | -.059 | -.088 |
| O'Sullivan (2003) | .083 | .160 | .047 | .016 | .097 | -.057 | .135 | .030 | .065 | -.103 | -.047 | .126 | -.061 | .021 | .299 | .099 | .084 |
| Bonjour & Miccelli (2010) | .024 | .024 | .061 | .029 | .007 | .195 | .048 | .025 | .277 | .057 | .057 | -.009 | .123 | .179 | .298 | -.083 | .008 |
| Voorórik et al. (2006) | .150 | .081 | .151 | -.056 | -.059 | .219 | -.058 | .077 | -.057 | .117 | -.025 | .067 | .039 | .014 | .282 | .257 | -.041 |
| Hanschi & Lyytinen (2010) | .075 | -.028 | .067 | .005 | .065 | -.101 | .025 | .006 | .024 | .155 | -.124 | -.039 | -.153 | .108 | .249 | .000 | .070 |
| Pentland & Feldman (2007) | -.018 | -.060 | .028 | .048 | .058 | -.106 | .022 | .009 | .071 | .034 | -.129 | .015 | -.076 | .012 | .206 | .035 | -.002 |
| Sapsed et al. (2002) | .145 | .027 | -.080 | .027 | .038 | -.113 | .100 | .015 | .076 | -.063 | .081 | -.02 | -.105 | -.049 | .157 | .095 | -.078 |
| Closs et al. (2008) | .131 | .071 | .132 | .080 | -.024 | .115 | -.068 | .198 | .028 | .098 | .033 | .010 | -.056 | .014 | .084 | .421 | .012 |
| Kotabe et al. (2007) | .103 | .079 | .087 | -.019 | -.140 | -.011 | .140 | .003 | -.012 | .163 | .034 | .018 | -.056 | .259 | -.009 | .417 | -.052 |
| Echardt (2011) | .133 | .001 | -.006 | .092 | -.010 | -.122 | .046 | .016 | .213 | .211 | .011 | .150 | -.104 | .062 | .071 | .362 | .055 |
| Pan et al. (2007) | -.051 | .042 | .026 | -.058 | .047 | .045 | .102 | .007 | .037 | .224 | .003 | .024 | .069 | .262 | .100 | .313 | -.089 |
| Worren et al. (2002) | -.053 | .100 | .078 | .020 | .207 | .091 | .024 | .069 | -.068 | -.034 | .223 | -.021 | -.042 | | | | |

Appendix 3 Factor analysis of co-occurrences

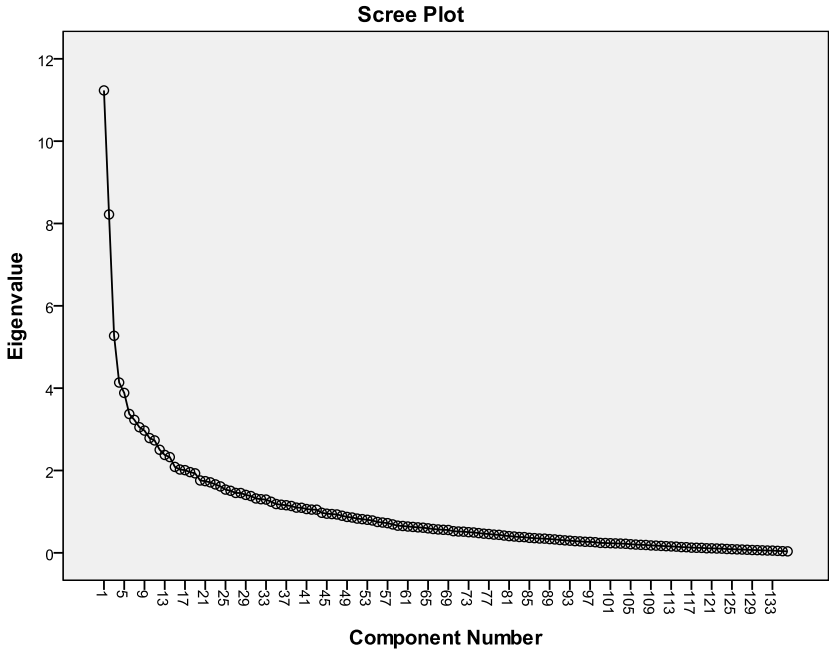

Eigenvalue cut-off point chosen: 1,75

Resulting number of components: 20

Rotated Component Matrix*

| | Component | | | | | | | | | | | | | | | | | | | |
|--|-----------|-------|-------|-------|-------|-------|-------|-------|-------|-------|-------|-------|-------|-------|-------|-------|-------|-------|-------|-------|
| | 1 | 2 | 3 | 4 | 5 | 6 | 7 | 8 | 9 | 10 | 11 | 12 | 13 | 14 | 15 | 16 | 17 | 18 | 19 | 20 |
| GERSHENSON JK, 2003, J ENG DESIGN, V14, P295, DOI 10.1080/095448203100091068 | .639 | .207 | .061 | .064 | .159 | .041 | -.009 | .163 | .135 | .103 | -.105 | -.021 | -.118 | -.017 | .010 | -.122 | .002 | -.078 | -.036 | -.114 |
| WORREN N, 2002, STRATEGIC MANAGE J, V23, P1123, DOI 10.1002/smj.276 | .622 | .252 | .056 | -.110 | .049 | .084 | -.079 | .107 | .024 | .023 | .057 | -.031 | .038 | .102 | .139 | .008 | -.003 | -.088 | .006 | -.009 |
| KIM K, 2000, EUR J OPER RES, V125, P602 | .611 | -.038 | .041 | -.012 | .032 | .012 | -.016 | .215 | .094 | .183 | -.028 | -.047 | -.085 | -.049 | -.060 | .197 | .040 | -.041 | .007 | -.037 |
| SOSA ME, 2004, MANAGE SCI, V50, P1674, DOI 10.1287/mnsc.1040.0289 | .557 | -.152 | -.008 | -.059 | .011 | -.039 | -.004 | -.044 | .022 | .067 | -.016 | -.014 | .158 | .005 | -.197 | -.099 | .066 | .017 | .128 | |
| MIKKOLA JH, 2003, IEEE T ENG MANAGE, V50, P204, DOI 10.1109/TEM.2003.810826 | .553 | -.125 | .119 | -.061 | .086 | -.027 | -.051 | .215 | -.084 | .119 | .063 | -.007 | .189 | -.089 | .070 | .019 | .022 | -.083 | -.043 | -.057 |
| FLEMING L, 2001, RES POLICY, V30, P1019 | .485 | -.004 | .075 | .298 | .053 | -.075 | .010 | -.020 | -.097 | .091 | -.020 | .010 | .015 | .038 | -.059 | -.035 | .166 | .158 | .046 | -.046 |
| SALVADOR F, 2002, J OPER MANAG, V20, P549 | .478 | .104 | -.097 | -.071 | .371 | .060 | -.063 | .242 | .116 | -.011 | -.057 | -.066 | .067 | .001 | .015 | -.129 | -.130 | -.055 | .163 | -.004 |
| SCHILLING MA, 2000, ACAD MANAGE REV, V25, P312 | .438 | .243 | .291 | .006 | .009 | -.001 | .136 | .138 | -.018 | -.140 | .009 | -.141 | .217 | .115 | .151 | -.090 | .238 | -.088 | -.090 | .160 |
| FIXSON SK, 2005, J OPER MANAG, V23, P345, DOI 10.1016/j.jom.2004.08.006 | .414 | .156 | .003 | -.046 | .140 | -.074 | .037 | .091 | -.095 | .154 | .139 | .048 | .014 | .004 | -.012 | -.295 | -.136 | -.113 | .031 | .076 |
| ULRICH K, 1995, RES POLICY, V24, P419 | .382 | .153 | .194 | .000 | .084 | -.053 | .212 | .161 | .254 | .142 | -.002 | -.030 | .267 | .054 | -.046 | .037 | -.040 | .036 | .154 | -.067 |
| PIL FK, 2006, ACAD MANAGE REV, V31, P995 | .337 | .280 | .060 | -.028 | -.038 | -.055 | -.011 | -.030 | .008 | -.141 | -.135 | -.115 | .013 | -.054 | -.072 | -.288 | .044 | .160 | .103 | .142 |
| STURGEON TJ, 2002, IND CORP CHANGE, V11, P451 | .027 | .684 | .074 | .031 | .008 | .003 | -.091 | .044 | -.062 | -.041 | .111 | .008 | .067 | -.008 | -.096 | -.102 | -.211 | -.033 | -.089 | -.024 |
| BRUSONI S, 2001, IND CORP CHANGE, V10, P179 | .170 | .664 | .058 | .095 | -.089 | -.085 | .119 | -.055 | .108 | .006 | .023 | .089 | .120 | -.078 | .118 | -.014 | .056 | .182 | .086 | .067 |
| BRUSONI S, 2001, ADMIN SCI QUART, V46, P597 | .020 | .622 | -.041 | -.052 | -.034 | -.001 | .103 | -.099 | -.124 | -.004 | .321 | .092 | .096 | .083 | .135 | .055 | .015 | .059 | .010 | .079 |
| PRENCIPE A, 2003, BUSINESS SYSTEMS INT | .116 | .611 | -.088 | -.044 | -.050 | .048 | .002 | -.043 | .003 | -.025 | .075 | -.024 | -.132 | -.028 | .117 | .147 | .181 | .017 | .127 | -.054 |
| LANGLOIS RN, 2003, IND CORP CHANGE, V12, P351 | -.063 | .587 | .104 | .043 | -.033 | .069 | .041 | -.044 | -.066 | -.018 | .411 | .001 | .056 | -.028 | -.163 | -.023 | -.092 | -.110 | -.082 | -.142 |
| GALVIN P, 2001, IND INNOV, V8, P31 | .186 | .540 | .154 | .061 | -.003 | .139 | -.071 | .177 | .147 | -.058 | -.181 | -.149 | .045 | -.065 | -.091 | -.131 | -.032 | .069 | .050 | .002 |
| TAKEISHI A, 2002, ORGAN SCI, V13, P321 | .033 | .521 | -.004 | .057 | -.030 | .039 | -.010 | -.076 | -.011 | -.001 | .058 | .125 | -.040 | .028 | .101 | -.030 | .191 | .053 | -.002 | .232 |
| LANGLOIS RN, 2002, J ECON BEHAV ORGAN, V49, P19 | .156 | .408 | .132 | .257 | -.035 | .102 | .037 | -.090 | -.048 | .054 | .194 | .131 | .120 | -.018 | .003 | -.200 | -.285 | .085 | -.103 | .159 |
| GARDU R, 2003, MANAGING MODULAR AGE | .372 | .391 | .125 | .005 | -.064 | .126 | -.004 | .047 | -.027 | -.097 | .078 | -.075 | -.123 | .074 | -.123 | .280 | -.015 | .083 | .016 | -.194 |
| CHESBROUGH HW, 1999, MANAGING IND KNOWLED, P202 | .011 | .376 | .083 | -.009 | .147 | -.178 | .147 | -.014 | -.095 | .010 | .173 | .016 | .003 | .101 | -.036 | .128 | .286 | -.069 | .065 | -.153 |
| SALVENDY R, 1996, STRATEGIC MANAGE J, V17, P63 | .254 | .366 | .267 | .146 | -.002 | .072 | .293 | .065 | .109 | -.113 | .031 | .128 | .209 | .149 | .354 | -.071 | .175 | .030 | -.040 | .045 |
| GARDU R, 1993, STRATEGIC MANAGE J, V14, P351 | .080 | -.106 | .580 | -.086 | .108 | -.016 | .069 | .100 | -.039 | -.041 | .083 | -.128 | -.085 | .069 | .334 | .174 | .075 | .141 | .217 | .065 |
| LANGLOIS RN, 1992, RES POLICY, V21, P297 | .064 | .172 | .570 | -.012 | .056 | .024 | .305 | -.006 | .003 | .104 | .171 | .032 | .154 | .075 | -.109 | .107 | .077 | .083 | .047 | .142 |
| HSUAN J, 1999, EUROPEAN J PURCHASIN, V5, P197 | .092 | .005 | .536 | .004 | .239 | -.049 | .045 | .146 | .015 | .204 | -.081 | -.007 | .004 | -.060 | .266 | .015 | .032 | .190 | -.096 | .137 |
| GARDU R, 1995, STRATEGIC MANAGE J, V16, P93 | .116 | .227 | .504 | .045 | .076 | .179 | -.004 | .197 | .190 | .062 | -.017 | -.070 | .094 | .032 | -.009 | -.098 | .151 | -.063 | -.074 | -.171 |
| ORTON JR, 1990, ACAD MANAGE REV, V15, P203 | .103 | -.113 | .477 | .044 | .077 | .253 | .018 | .071 | .156 | .041 | -.149 | .154 | -.108 | .004 | .154 | .161 | .238 | -.028 | .192 | .031 |
| SANDERSON SW, 1997, MANAGING PRODUCT FAM | -.170 | -.057 | .476 | -.030 | .168 | -.098 | .051 | .014 | .419 | .047 | .002 | .072 | -.056 | -.005 | .067 | -.025 | .010 | -.017 | .139 | -.178 |
| SANCHEZ R, 1995, STRATEGIC MANAGE J, V16, P135 | -.265 | .086 | .472 | -.029 | -.147 | .166 | -.041 | .013 | .171 | -.080 | -.089 | .065 | -.036 | .017 | .238 | -.032 | -.012 | -.057 | .131 | .093 |
| LANGLOIS RN, 1995, FIRMS MARKETS EC CHA | .162 | .619 | .419 | .029 | .101 | .144 | .127 | .020 | -.035 | -.029 | .155 | -.105 | .044 | -.115 | .041 | -.193 | .080 | -.096 | -.086 | -.117 |
| SIMON HA, 1962, P AM PHILOS SOC, V106, P467 | .281 | .056 | .404 | .346 | -.054 | -.040 | .002 | -.066 | -.009 | -.071 | .229 | .167 | .072 | .104 | -.073 | .234 | -.073 | .082 | .076 | .066 |
| SANCHEZ R, 1999, J MARKETING, V63, P92 | .289 | -.031 | .381 | .046 | .051 | -.034 | .170 | .204 | .175 | .113 | -.081 | .023 | .022 | .013 | .196 | -.039 | .014 | -.091 | .226 | -.022 |
| BALDWIN CY, 1997, HARVARD BUS REV, V75, P84 | .158 | .204 | .367 | -.019 | -.007 | -.022 | .226 | .162 | .139 | .053 | -.027 | .197 | .105 | -.139 | .141 | -.063 | .074 | -.026 | -.175 | .079 |
| LEVINTHAL DA, 1997, MANAGE SCI, V43, P934 | .000 | -.026 | -.019 | .884 | -.022 | .007 | .025 | -.015 | -.002 | -.058 | -.050 | -.020 | -.050 | .079 | -.042 | .015 | .026 | -.067 | .001 | -.013 |
| KAUFFMAN SA, 1993, ORIGINS ORDER SELF O | .039 | -.029 | .032 | .802 | -.055 | .045 | .061 | -.055 | .005 | -.058 | -.076 | -.001 | .078 | .045 | -.073 | .051 | .124 | -.023 | -.037 | .029 |
| RIVKIN JW, 2000, MANAGE SCI, V46, P24 | -.051 | .136 | .074 | .742 | -.028 | -.040 | -.007 | -.051 | .062 | -.049 | .002 | -.048 | .005 | .063 | -.055 | -.038 | -.013 | .073 | -.116 | .006 |
| MARCH JG, 1958, ORGANIZATIONS THOMPSON JD, 1967, ORG ACTION | -.050 | .015 | -.041 | .606 | -.014 | -.009 | .031 | .042 | -.036 | -.013 | .168 | -.050 | .011 | -.027 | .073 | .031 | -.128 | -.049 | .060 | -.045 |
| CYERT RM, 1963, BEHAV THEORY FIRM | -.042 | .055 | -.065 | .527 | .042 | -.006 | -.116 | .037 | -.067 | .038 | .038 | .165 | .144 | -.259 | .144 | -.081 | .070 | .108 | .123 | -.152 |
| ETHIRAK SK, 2004, MANAGE SCI, V50, P159, DOI 10.1287/mnsc.1030.0145 | -.042 | -.093 | -.028 | .460 | .015 | .148 | -.032 | .005 | -.079 | .025 | .171 | .049 | .043 | -.099 | .044 | .072 | -.062 | .121 | .362 | .085 |
| CHANDLER AD, 1962, STRATEGY STRUCTURE C | .357 | .104 | -.019 | .428 | -.036 | -.107 | .050 | -.116 | .045 | -.105 | .110 | .096 | .192 | -.063 | .029 | -.082 | -.033 | .042 | -.082 | .242 |
| SIMON HA, 1969, SCI ARTIFICIAL COLLIER DA, 1982, MANAGE SCI, V28, P126 | -.077 | .034 | -.026 | .395 | -.008 | .335 | -.021 | -.018 | -.015 | -.026 | .333 | -.044 | -.082 | -.015 | .114 | .087 | -.094 | .010 | .005 | .087 |
| SIMON HA, 1969, SCI ARTIFICIAL COLLIER DA, 1982, MANAGE SCI, V28, P126 | .012 | .004 | .032 | .293 | -.079 | .002 | .139 | -.068 | -.041 | -.055 | .119 | -.014 | .014 | .167 | -.008 | -.064 | -.108 | -.092 | .162 | .231 |
| COLLIER DA, 1981, DECISION SCI, V12, P85 | .049 | -.057 | .025 | .044 | .825 | -.049 | -.010 | -.041 | .094 | -.063 | .005 | .009 | -.083 | .039 | -.008 | .063 | -.005 | -.035 | -.047 | -.033 |
| DOGRAMACI A, 1979, AIIE T, V11, P129 | -.019 | .028 | .000 | -.014 | .788 | -.009 | -.014 | .110 | .170 | .003 | -.033 | -.023 | -.018 | -.050 | -.011 | .019 | .004 | -.041 | -.001 | .009 |
| BAKER KR, 1986, MANAGE SCI, V32, P92 | .139 | -.036 | .185 | .007 | .758 | .004 | -.019 | .007 | .008 | .025 | -.036 | .006 | -.087 | .005 | .028 | .029 | .048 | .013 | .069 | -.119 |
| GUPTA S, 1999, PROD OPER MANAG, V8, P163 | .050 | -.048 | .119 | -.042 | .825 | -.068 | .019 | .048 | .061 | .120 | .006 | -.029 | .005 | .059 | -.007 | .068 | .077 | -.033 | -.081 | .063 |
| PENROSE ET, 1959, THEORY GROWTH FIRM | .179 | -.019 | -.105 | -.014 | .577 | .060 | -.048 | -.004 | .221 | .210 | -.026 | -.033 | .105 | .030 | -.063 | -.220 | -.075 | .049 | .138 | .098 |
| LEONARDBARTON D, 1992, STRATEGIC MANAGE J, V13, P111 | -.083 | .098 | .021 | -.048 | -.008 | .696 | .061 | -.036 | -.074 | -.010 | .020 | .021 | -.040 | .022 | .039 | .074 | -.061 | .131 | .029 | .043 |
| | -.082 | .023 | .052 | .085 | -.012 | .587 | .290 | -.051 | -.021 | .013 | .174 | .035 | .035 | .002 | -.074 | -.061 | .037 | -.111 | -.102 | -.145 |

Rotated Component Matrix*

| | Component | | | | | | | | | | | | | | | | | | | |
|--|-----------|-------|-------|-------|-------|-------------|-------------|-------------|-------------|-------------|-------------|-------------|-------|-------|-------|-------|-------|-------|-------|-------|
| | 1 | 2 | 3 | 4 | 5 | 6 | 7 | 8 | 9 | 10 | 11 | 12 | 13 | 14 | 15 | 16 | 17 | 18 | 19 | 20 |
| APRAHALAD CK, 1990, HARVARD BUS REV, V68, P79 | -0.47 | .018 | .077 | -.089 | -.020 | .583 | -.024 | .131 | -.074 | -.059 | -.126 | -.408 | -.038 | -.014 | -.163 | -.119 | .009 | -.042 | -.042 | -.104 |
| WERNERFELT B, 1984, STRATEGIC MANAGE J, V5, P171 | -.036 | -.022 | -.003 | -.048 | -.004 | .564 | -.058 | -.044 | -.047 | -.006 | .046 | -.144 | .034 | .107 | .261 | -.010 | .030 | .157 | .052 | .080 |
| TEECE DI, 1997, STRATEGIC MANAGE J, V18, P509 | -.016 | .001 | .011 | .221 | -.039 | .549 | .281 | .009 | .207 | -.010 | .115 | -.185 | .195 | -.108 | .047 | .001 | -.009 | -.126 | -.132 | .081 |
| BARNEY J, 1991, J MANAGE, V17, P99 | .119 | -.112 | .044 | .037 | -.076 | .539 | -.096 | .043 | .022 | -.071 | .011 | .226 | .065 | .000 | .028 | -.092 | .247 | .039 | .133 | .022 |
| EISENHARDT KM, 2000, STRATEGIC MANAGE J, V21, P1105 | .180 | .035 | -.041 | .001 | -.080 | .523 | -.314 | -.091 | .093 | -.029 | -.051 | -.104 | .145 | -.095 | .213 | .141 | -.055 | .117 | -.196 | .062 |
| HAMEL G, 1994, COMPETING FUTURE | .140 | -.049 | -.060 | .147 | -.018 | .391 | .285 | .038 | -.054 | .002 | -.096 | .124 | .013 | -.005 | -.090 | .030 | -.084 | .197 | .066 | -.324 |
| ABERNATHY YW, 1978, TECHNOL REV, V80, P40 | -.075 | .081 | -.036 | .004 | -.087 | -.008 | .719 | .031 | .175 | .009 | .014 | -.111 | -.087 | .020 | .085 | -.052 | .063 | -.127 | .093 | -.021 |
| TUSHMAN ML, 1986, ADMIN SCI QUART, V31, P439 | -.064 | -.031 | .089 | -.034 | -.033 | .204 | .679 | .025 | -.089 | -.059 | -.070 | -.017 | -.069 | .010 | .117 | .111 | -.091 | .072 | .111 | .021 |
| CHRISTENSEN CM, 1995, RES POLICY, V24, P233 | -.078 | -.016 | .290 | .005 | .165 | -.021 | .559 | .008 | .075 | -.026 | -.017 | -.071 | .070 | -.083 | -.004 | .006 | .201 | .301 | -.135 | -.087 |
| ANDERSON P, 1990, ADMIN SCI QUART, V35, P664 | .000 | -.015 | .061 | -.030 | -.029 | .180 | .555 | -.003 | -.080 | -.051 | .140 | .242 | -.058 | -.017 | -.196 | -.246 | .169 | -.116 | .032 | -.075 |
| CLARR KB, 1985, RES POLICY, V14, P235 | .025 | -.090 | .460 | -.032 | .047 | .024 | .500 | -.062 | .044 | .037 | .043 | .111 | -.009 | .073 | -.017 | .005 | -.026 | .990 | .151 | .085 |
| UTTERBACK JM, 1994, MASTERING DYNAMICS I | -.065 | .175 | .353 | .059 | .178 | -.111 | .462 | .025 | -.009 | -.057 | .040 | .075 | -.028 | -.039 | -.085 | -.024 | -.100 | -.161 | .145 | .236 |
| HENDERSON RM, 1990, ADMIN SCI QUART, V35, P99 | .123 | .105 | .297 | .087 | .050 | .173 | .458 | .072 | .043 | -.012 | .230 | .274 | .071 | .178 | .061 | .171 | .059 | .057 | -.068 | -.011 |
| NELSON RR, 1982, EVOLUTIONARY THEORY | .042 | -.244 | .064 | .414 | -.023 | .139 | .443 | -.121 | -.115 | .056 | .050 | .154 | .018 | -.090 | .070 | .068 | .609 | .122 | .014 | .028 |
| SANDERSON S, 1995, RES POLICY, V24, P761 | .330 | -.057 | .002 | -.004 | -.133 | .113 | .440 | -.026 | .229 | -.056 | -.131 | -.112 | .048 | -.038 | -.043 | .260 | -.052 | .059 | -.227 | .014 |
| CHRISTENSEN CM, 1997, INNOVATORS DILEMMA | .040 | .017 | .206 | .021 | -.038 | -.041 | .317 | -.100 | -.123 | -.090 | .024 | .092 | .083 | .093 | -.146 | -.215 | .312 | .147 | -.034 | -.007 |
| WHEELWRIGHT SC, 1992, REVOLUTIONIZING PROD | .183 | -.087 | -.029 | -.053 | .163 | .088 | .223 | -.073 | .119 | -.168 | -.024 | .059 | .061 | .106 | .047 | .065 | .195 | .176 | .150 | -.054 |
| FEITZINGER E, 1997, HARVARD BUS REV, V75, P116 | .117 | .051 | .021 | -.019 | .149 | -.037 | -.032 | .705 | .111 | .024 | -.054 | -.046 | -.036 | .001 | -.021 | .185 | .091 | .003 | -.031 | -.018 |
| DURAY R, 2000, J OPER MANAG, V18, P605 | .340 | -.017 | .033 | .048 | .109 | -.016 | -.010 | .668 | .001 | .138 | .052 | .006 | .106 | .033 | .074 | .004 | .028 | .022 | .024 | -.007 |
| KOTHA S, 1995, STRATEGIC MANAGE J, V16, P21 | .242 | -.085 | .078 | -.051 | -.111 | .157 | -.001 | .632 | .067 | -.152 | .024 | .108 | -.087 | -.044 | -.082 | .138 | -.035 | .255 | .048 | -.037 |
| PINE BI, 1993, MASS CUSTOMIZATION N | .174 | -.113 | .231 | -.073 | .197 | .033 | .058 | .578 | .106 | .112 | .017 | .059 | .034 | -.004 | .016 | .001 | .000 | .998 | .070 | -.099 |
| PINE BI, 1993, HARVARD BUS REV, V71, P108 | -.075 | -.006 | .016 | -.022 | -.136 | .044 | -.024 | .548 | .377 | -.036 | .006 | -.140 | -.130 | .045 | .073 | -.089 | .048 | .030 | -.056 | .009 |
| DAVIS SM, 1987, FUTURE PERFECT | -.111 | -.046 | -.018 | -.006 | -.112 | -.059 | -.025 | .521 | -.075 | -.013 | -.068 | -.044 | .004 | .004 | -.006 | -.072 | -.017 | .033 | -.047 | -.023 |
| STARBUCK MK, 1965, HARVARD BUS REV, V43, P131 | .235 | -.009 | .080 | .001 | .159 | -.014 | -.021 | .508 | -.019 | .144 | -.043 | -.072 | .070 | -.081 | .015 | -.047 | .014 | -.010 | .037 | -.051 |
| FINE CH, 1998, CLOCKSPPEED WINNING I | .243 | .309 | .100 | .049 | .295 | .049 | -.012 | .352 | .122 | .052 | .219 | -.075 | .087 | -.001 | -.020 | .071 | .125 | .031 | .051 | .020 |
| MEYER MH, 1997, MANAGE SCI, V43, P88 | -.091 | .056 | .212 | .052 | .105 | -.007 | .003 | .070 | .694 | .133 | -.099 | .006 | .195 | -.044 | -.059 | .003 | .019 | .148 | -.031 | .093 |
| MEYER MH, 1997, POWER PRODUCT PLATFORM | .003 | -.025 | .039 | -.062 | .397 | .004 | .211 | .031 | .592 | -.067 | -.066 | -.007 | .096 | .025 | -.024 | .017 | -.052 | .113 | -.108 | .031 |
| ROBERTSON D, 1998, SLOAN MANAGE REV, V39, P19 | .232 | -.056 | .153 | -.054 | .414 | -.019 | .015 | -.002 | .575 | -.078 | -.037 | .018 | .067 | -.075 | .014 | .015 | -.003 | .123 | -.040 | -.099 |
| FISHER M, 1999, MANAGE SCI, V45, P297 | .295 | -.026 | .041 | -.034 | .289 | -.045 | -.024 | .204 | .513 | .140 | -.016 | -.018 | .056 | -.123 | -.047 | .154 | .060 | -.059 | .032 | -.056 |
| LEE HL, 1997, MANAGE SCI, V43, P40 | .014 | -.012 | .042 | .006 | .044 | -.018 | -.084 | .097 | .432 | .421 | .006 | .041 | -.044 | .013 | -.017 | .063 | .025 | -.014 | .049 | -.005 |
| KRISHNAN V, 2001, MANAGE SCI, V47, P1 | .365 | .026 | -.195 | -.052 | .354 | -.042 | .033 | .062 | .424 | -.120 | -.014 | .054 | .023 | .148 | -.028 | -.012 | -.047 | -.031 | .159 | -.081 |
| NOVAK S, 2001, MANAGE SCI, V47, P189 | .177 | .114 | -.173 | -.041 | .183 | .061 | -.034 | .290 | .355 | .049 | .076 | -.015 | .110 | .013 | .144 | -.183 | .022 | .013 | .229 | .063 |
| KUSIAK A, 1996, IEEE T COMPON PACK A, V19, P2523 | .027 | -.040 | .003 | -.035 | .031 | -.004 | -.014 | .003 | -.032 | .729 | -.039 | -.031 | .008 | .024 | -.036 | .037 | -.013 | .035 | -.060 | .046 |
| JIAO JX, 1999, J INTELL MANUF, V10, P33 | .127 | -.061 | .001 | -.014 | .113 | .018 | -.021 | .080 | -.057 | .726 | -.018 | -.024 | .010 | .025 | -.002 | -.047 | .005 | .022 | -.066 | .071 |
| NUH NP, 1990, PRINCIPLES DESIGN | .028 | -.055 | .049 | -.033 | -.069 | .009 | .000 | .227 | .621 | .002 | -.018 | .005 | .132 | -.056 | -.024 | -.035 | -.047 | .139 | -.011 | |
| PAHL G, 1996, ENG DESIGN SYSTEMATI | .107 | -.071 | -.022 | -.090 | -.032 | -.065 | .001 | .009 | .347 | .555 | .013 | .079 | -.035 | .189 | -.023 | .065 | .042 | -.070 | .003 | -.061 |
| EVANS D, 1996, OPER RES, V11, P637 | .128 | -.034 | .254 | .001 | .398 | -.041 | -.003 | .157 | -.010 | .483 | -.019 | -.040 | -.023 | -.022 | .024 | -.038 | .069 | .028 | -.104 | .075 |
| HUANG CC, 1998, IEEE T SYST MAN CY A, V28, P66 | .013 | .128 | -.016 | -.024 | .025 | -.032 | -.036 | -.038 | -.109 | .419 | -.043 | -.033 | -.057 | -.094 | -.019 | .081 | -.042 | -.049 | .021 | -.067 |
| SANCHEZ R, 2000, INT J TECHNOL MANAGE, V19, P610 | .239 | -.088 | .222 | -.032 | -.041 | -.006 | .119 | .043 | .120 | .379 | .042 | .076 | -.121 | .221 | .084 | -.272 | -.070 | -.098 | .140 | -.156 |
| CHANDLER AD, 1977, VISIBLE HAND MANAGER | -.041 | .067 | .043 | .097 | -.004 | .116 | .146 | .011 | -.040 | -.010 | .692 | .024 | -.011 | -.036 | -.109 | .014 | -.041 | .065 | -.029 | .073 |
| WILLIAMSON OE, 1985, EC I CAPITALISM | .045 | .133 | .099 | .049 | -.074 | .189 | .007 | -.024 | -.070 | -.057 | .598 | .019 | .037 | -.019 | .263 | -.101 | .193 | .255 | .078 | -.004 |
| JACOBIDES MG, 2005, STRATEG MANAGE J, V26, P395, DOI 10.1002/smj.460 | .026 | .121 | -.146 | .020 | -.016 | .045 | .049 | .078 | .015 | -.044 | .551 | -.052 | .035 | .051 | .192 | -.160 | .225 | -.026 | .027 | .163 |
| COASE RH, 1937, ECONOMIC-NEW SER, V4, P386 | -.036 | .130 | -.008 | .075 | -.027 | .006 | -.081 | -.088 | -.003 | -.008 | .522 | -.011 | .044 | -.051 | .135 | .159 | .170 | .139 | -.116 | -.031 |
| JACOBIDES MG, 2005, ACAD MANAGE J, V48, P465 | .078 | .318 | .180 | .050 | -.047 | -.060 | .074 | -.094 | -.031 | -.042 | .422 | -.117 | .068 | .012 | -.078 | .110 | .133 | -.039 | .141 | -.056 |
| NONAKA I, 1994, ORGAN SCI, V5, P14 | -.044 | -.002 | .010 | -.044 | -.068 | .095 | .016 | .021 | .150 | .004 | .493 | -.702 | .006 | .070 | -.014 | .030 | .102 | -.081 | -.069 | -.009 |
| VONHIPPEL E, 1994, MANAGE SCI, V40, P429 | -.040 | -.113 | .240 | -.061 | -.028 | .119 | -.023 | .072 | -.092 | -.080 | .078 | .486 | -.037 | -.005 | .072 | .135 | -.227 | .197 | .135 | -.026 |
| COHEN WM, 1990, ADMIN SCI QUART, V35, P238 | -.084 | .116 | -.052 | .173 | .017 | .274 | .204 | -.053 | -.153 | .003 | -.169 | .459 | .127 | -.052 | .070 | .006 | .154 | .027 | .136 | .158 |
| PORTER ME, 1985, COMPETITIVE ADVANTAGE | .000 | .048 | .010 | .056 | .028 | .322 | -.012 | -.083 | .078 | .001 | -.029 | .446 | -.094 | .017 | -.157 | .073 | .225 | .182 | .137 | -.280 |
| MEYER MH, 1993, SLOAN MANAGE REV, V34, P29 | .030 | -.110 | .202 | -.044 | .066 | .082 | .069 | -.097 | .310 | .178 | .049 | .406 | -.162 | .029 | -.060 | -.037 | -.037 | .020 | .008 | -.001 |
| DIERCKX I, 1989, MANAGE SCI, V35, P1504 | .019 | -.027 | .161 | -.001 | .106 | .376 | .050 | .118 | -.020 | -.099 | .115 | .392 | -.023 | -.064 | .059 | -.063 | .125 | .012 | -.140 | .186 |
| MARCH JG, 1991, ORGAN SCI, V2, P71 | -.031 | .034 | -.011 | .245 | -.025 | .122 | .102 | -.053 | -.031 | -.037 | -.216 | .389 | .010 | .024 | -.028 | .068 | .165 | -.168 | .114 | .301 |
| DOSI G, 1982, RES POLICY, V11, P147 | -.004 | .090 | .042 | .054 | -.033 | -.040 | .239 | -.084 | -.091 | .025 | .039 | .386 | .038 | -.066 | .010 | .005 | .287 | .033 | -.053 | -.053 |
| MORRIS CR, 1993, HARVARD BUS REV, V71, P86 | -.037 | -.095 | .179 | -.069 | -.133 | -.035 | .074 | .140 | .264 | .012 | .128 | .362 | -.077 | -.029 | -.129 | .151 | -.017 | .040 | .234 | .224 |
| NONAKA I, 1995, KNOWLEDGE CREATING C | .050 | .070 | -.059 | .088 | -.021 | -.011 | .004 | -.106 | -.041 | -.022 | -.050 | .344 | .256 | -.100 | .326 | .108 | -.107 | -.010 | -.121 | .105 |

Rotated Component Matrix*

| | Component | | | | | | | | | | | | | | | | | | | |
|---|-----------|-------|-------|-------|-------|-------|-------|-------|-------|-------|-------|-------|-------------|-------------|-------------|--------------|-------------|-------------|-------------|-------------|
| | 1 | 2 | 3 | 4 | 5 | 6 | 7 | 8 | 9 | 10 | 11 | 12 | 13 | 14 | 15 | 16 | 17 | 18 | 19 | 20 |
| MILES M, 1984, QUALITATIVE DATA ANA | .156 | -.118 | .045 | -.066 | -.082 | -.012 | -.070 | -.109 | -.007 | -.078 | .056 | .101 | .702 | -.018 | .046 | .064 | .089 | -.056 | -.036 | -.010 |
| YIN RK, 1984, CASE STUDY RES DESIG | -.029 | .193 | -.001 | -.059 | .001 | .043 | .111 | .048 | .133 | .042 | -.024 | -.053 | .668 | -.025 | -.036 | -.131 | .039 | .146 | -.007 | -.116 |
| GLASER BG, 1967, DISCOVERY GROUNDED T | .055 | -.047 | .054 | .031 | -.037 | -.002 | -.089 | -.034 | .040 | -.096 | .026 | -.047 | .650 | .189 | -.065 | .066 | -.039 | -.083 | .003 | -.053 |
| EISENHARDT KM, 1989, ACAD MANAGE REV, V14, P532 | -.008 | .119 | -.073 | -.066 | .064 | .057 | .007 | .322 | .045 | .020 | .095 | .045 | .576 | -.009 | -.092 | -.166 | -.121 | -.192 | .090 | .140 |
| GRANT RM, 1996, STRATEGIC MANAGE J, V17, P109 | -.051 | .106 | -.032 | .155 | .001 | .167 | -.040 | -.120 | .009 | .047 | -.068 | .054 | .431 | -.113 | .240 | .050 | .075 | .113 | .149 | .114 |
| BALDWIN CY, 2000, DESIGN RULES POWER M | .295 | .272 | .190 | .207 | -.054 | .134 | .119 | .005 | .125 | -.018 | .147 | -.134 | .299 | .297 | -.103 | -.100 | .164 | .004 | .080 | .053 |
| CLARK KB, 1991, PRODUCT DEV PERFORMA | .048 | .008 | .023 | .076 | .109 | .065 | .106 | .101 | .139 | -.163 | .087 | .152 | .235 | .188 | .182 | .164 | .019 | .073 | .023 | -.026 |
| EPPIINGER SD, 1984, RES ENG DES, V6, P1 | -.003 | -.056 | .013 | .049 | .004 | -.028 | -.006 | -.039 | -.043 | -.072 | -.056 | -.089 | .071 | .752 | -.089 | .069 | .055 | -.027 | -.042 | -.032 |
| STEWART DV, 1981, IEEE T ENG MANAGE, V28, P71 | .074 | -.033 | .001 | .015 | -.010 | .012 | -.037 | -.044 | -.042 | .181 | -.029 | -.082 | -.065 | .630 | .024 | -.087 | -.012 | .097 | -.077 | .033 |
| ALLEN TI, 1977, MANAGING FLOW TECHN | -.139 | .078 | -.091 | .263 | .011 | .016 | .046 | .026 | -.055 | -.038 | -.171 | .076 | .142 | .466 | .000 | .098 | -.030 | -.079 | .033 | -.098 |
| BROWNING TR, 2001, IEEE T ENG MANAGE, V48, P292 | .242 | -.064 | -.031 | -.056 | .053 | -.028 | .015 | -.055 | .153 | .283 | .092 | .053 | -.111 | .450 | .070 | -.165 | -.038 | .066 | .026 | -.002 |
| VONHIPPPEL E, 1990, RES POLICY, V19, P407 | -.110 | .073 | .049 | -.017 | .076 | -.024 | .061 | .134 | -.015 | .041 | .116 | .074 | .175 | .404 | .033 | .331 | .009 | .105 | -.006 | .194 |
| ALEXANDER C, 1964, NOTES SYNTHESIS FORM | .217 | .070 | .210 | .151 | -.006 | .247 | -.066 | -.044 | -.034 | .050 | .153 | -.006 | .033 | .397 | -.070 | .113 | -.141 | -.037 | .054 | .182 |
| ULRICH KT, 1995, PRODUCT DESIGN DEV | .310 | -.023 | .077 | .059 | .256 | -.088 | .119 | .095 | .267 | .076 | -.078 | .104 | .104 | .352 | .138 | .164 | -.025 | .089 | .015 | -.037 |
| WILLIAMSON OE, 1991, ADM SCI Q, V36, P269 | -.058 | .041 | .116 | -.013 | -.032 | .062 | -.022 | -.033 | -.038 | -.032 | .156 | -.062 | -.030 | -.016 | .569 | -.021 | .028 | -.076 | -.040 | .007 |
| WILLIAMSON OE, 1975, MARKETS HIERARCHIES | -.056 | .050 | -.026 | -.021 | -.024 | .228 | .115 | -.062 | -.090 | -.024 | .114 | -.050 | -.041 | .041 | .569 | .184 | .033 | .152 | .209 | .098 |
| MIKKOLA JH, 2003, R&D MANAGE, V33, P439 | .228 | -.108 | .153 | -.012 | .104 | -.063 | -.027 | .110 | .194 | -.011 | .072 | .185 | .107 | -.088 | .484 | -.083 | .041 | -.060 | .018 | -.144 |
| NUNNALLY JC, 1978, PSYCHOMETRIC THEORY | .071 | .016 | .039 | -.062 | .027 | .005 | .159 | -.134 | -.072 | -.133 | .024 | -.071 | .019 | .379 | .227 | -.024 | .132 | .022 | .011 | .011 |
| WEICK KE, 1976, ADM SCI Q, V21, P1 | .172 | -.006 | .115 | .112 | -.018 | .383 | .077 | .070 | -.076 | -.054 | -.062 | .087 | -.101 | .007 | -.005 | .447 | .083 | .089 | .278 | .085 |
| SCHILLING MA, 2001, ACAD MANAGE J, V44, P1149 | .289 | -.256 | .241 | .111 | .042 | .124 | .099 | .079 | .010 | -.086 | .011 | .021 | -.125 | .036 | .265 | -.406 | .145 | -.111 | -.098 | .243 |
| NEVINS JL, 1989, CONCURRENT DESIGN PR | .010 | -.026 | .147 | -.072 | .165 | -.078 | .053 | .028 | -.014 | .032 | -.045 | .030 | -.046 | .132 | -.035 | .378 | -.014 | -.099 | .212 | .043 |
| CHESBROUGH HW, 1996, HARVARD BUS REV, V74, P65 | -.067 | .066 | .073 | -.058 | -.031 | .057 | -.035 | .082 | .008 | -.039 | .149 | .138 | .060 | -.016 | .018 | -.018 | .606 | -.045 | -.063 | .014 |
| TEECE DJ, 1986, RES POLICY, V15, P285 | .090 | .081 | .024 | -.002 | .042 | .137 | .173 | .087 | .050 | -.065 | .348 | -.034 | -.043 | -.050 | .098 | .093 | .595 | -.041 | -.003 | .068 |
| WOMACK JP, 1990, MACHINE CHANGED WORL | -.079 | .056 | .049 | -.041 | -.041 | .011 | .108 | .117 | .108 | -.078 | .111 | .009 | -.039 | .059 | .064 | -.023 | -.076 | .653 | -.013 | .098 |
| RICHARDSON GB, 1972, ECON J, V82, P83 | -.062 | .137 | .013 | -.007 | -.046 | .056 | -.049 | .158 | -.001 | -.020 | .172 | .104 | -.036 | .083 | .053 | .075 | -.136 | .572 | -.020 | .076 |
| PORTER ME, 1980, COMPETITIVE STRATEGY | -.014 | -.001 | .025 | .174 | .002 | .276 | -.012 | -.085 | .033 | .006 | -.022 | .113 | .033 | -.093 | -.125 | -.115 | .245 | .525 | .114 | -.197 |
| VONHIPPPEL E, 1983, SOURCES INNOVATION | .014 | .081 | .112 | .079 | -.011 | -.024 | .104 | .043 | -.038 | -.010 | -.038 | -.022 | .049 | -.058 | .052 | .058 | .000 | .056 | .717 | .019 |
| SANCHEZ R, 1996, EUROPEAN MANAGEMENT, V14, P121 | .062 | .068 | .374 | -.038 | .002 | -.019 | .042 | -.084 | .239 | .038 | -.035 | .061 | .067 | -.063 | .025 | .117 | -.082 | -.102 | .541 | -.101 |
| PARNAS DL, 1972, COMMUN ACM, V15, P1053 | .130 | .024 | .230 | .163 | -.045 | .069 | -.104 | -.099 | -.035 | .070 | .242 | .074 | .005 | .022 | -.056 | .116 | -.216 | .113 | .012 | .423 |
| HOETKER G, 2006, STRATEGIC MANAGE J, V27, P501, DOI 10.1002/smj.528 | .188 | .370 | -.087 | .067 | .068 | .027 | .071 | -.060 | .046 | .031 | .078 | -.027 | -.058 | .091 | .248 | -.114 | .092 | .136 | .027 | .422 |
| GALBRAITH JR, 1973, DESIGNING COMPLEX OR | -.085 | .081 | .021 | .186 | .006 | -.080 | -.047 | .045 | .118 | -.004 | .006 | .156 | .019 | .313 | .317 | .017 | -.130 | -.118 | .062 | -.409 |
| KOGUT B, 1992, ORGAN SCI, V3, P383 | -.014 | .103 | .127 | .179 | -.045 | .371 | -.064 | -.049 | .018 | -.051 | .214 | .047 | -.074 | .028 | .183 | .234 | .052 | .202 | .148 | .389 |
| GALUNIC DC, 2001, ACAD MANAGE J, V44, P1229 | .136 | .177 | .172 | .246 | -.053 | .245 | -.008 | -.019 | .002 | .056 | -.128 | .098 | -.101 | .024 | .156 | -.151 | .127 | -.196 | -.098 | .247 |

Extraction Method: Principal Component Analysis.
Rotation Method: Varimax with Kaiser Normalization.
a. Rotation converged in 25 iterations.

TITLER I PH.D.SERIEN:**2004**

1. Martin Grieger
Internet-based Electronic Marketplaces and Supply Chain Management
2. Thomas Basbøll
*LIKENESS
A Philosophical Investigation*
3. Morten Knudsen
*Beslutningens vaklen
En systemteoretisk analyse af moderniseringen af et amtskommunalt sundhedsvæsen 1980-2000*
4. Lars Bo Jeppesen
*Organizing Consumer Innovation
A product development strategy that is based on online communities and allows some firms to benefit from a distributed process of innovation by consumers*
5. Barbara Dragsted
*SEGMENTATION IN TRANSLATION AND TRANSLATION MEMORY SYSTEMS
An empirical investigation of cognitive segmentation and effects of integrating a TM system into the translation process*
6. Jeanet Hardis
*Sociale partnerskaber
Et socialkonstruktivistisk casestudie af partnerskabsaktørers virkelighedsopfattelse mellem identitet og legitimitet*
7. Henriette Hallberg Thygesen
System Dynamics in Action
8. Carsten Mejer Plath
Strategisk Økonomistyring
9. Annemette Kjærgaard
Knowledge Management as Internal Corporate Venturing
10. Knut Arne Hovdal
*De professionelle i endring
Norsk ph.d., ej til salg gennem Samfundslitteratur*
11. Søren Jeppesen
*Environmental Practices and Greening Strategies in Small Manufacturing Enterprises in South Africa
– A Critical Realist Approach*
12. Lars Frode Frederiksen
*Industriel forskningsledelse
– på sporet af mønstre og samarbejde i danske forskningsintensive virksomheder*
13. Martin Jes Iversen
*The Governance of GN Great Nordic
– in an age of strategic and structural transitions 1939-1988*
14. Lars Pynt Andersen
*The Rhetorical Strategies of Danish TV Advertising
A study of the first fifteen years with special emphasis on genre and irony*
15. Jakob Rasmussen
Business Perspectives on E-learning
16. Sof Thrane
*The Social and Economic Dynamics of Networks
– a Weberian Analysis of Three Formalised Horizontal Networks*
17. Lene Nielsen
Engaging Personas and Narrative Scenarios – a study on how a user-centered approach influenced the perception of the design process in the e-business group at AstraZeneca
18. S.J Valstad
*Organisationsidentitet
Norsk ph.d., ej til salg gennem Samfundslitteratur*

19. Thomas Lyse Hansen
Six Essays on Pricing and Weather risk in Energy Markets
20. Sabine Madsen
Emerging Methods – An Interpretive Study of ISD Methods in Practice
21. Evis Sinani
The Impact of Foreign Direct Investment on Efficiency, Productivity Growth and Trade: An Empirical Investigation
22. Bent Meier Sørensen
Making Events Work Or, How to Multiply Your Crisis
23. Pernille Schnoor
*Brand Ethos
Om troværdige brand- og virksomhedsidentiteter i et retorisk og diskursteoretisk perspektiv*
24. Sidsel Fabech
*Von welchem Österreich ist hier die Rede?
Diskursive forhandlinger og magtkampe mellem rivaliserende nationale identitetskonstruktioner i østrigske pressediskurser*
25. Klavs Odgaard Christensen
*Sprogpolitik og identitetsdannelse i flersprogede forbundsstater
Et komparativt studie af Schweiz og Canada*
26. Dana B. Minbaeva
Human Resource Practices and Knowledge Transfer in Multinational Corporations
27. Holger Højlund
*Markedets politiske fornuft
Et studie af velfærdens organisering i perioden 1990-2003*
28. Christine Mølgaard Frandsen
*A.s erfaring
Om mellemværendets praktik i en transformation af mennesket og subjektiviteten*
29. Sine Nørholm Just
The Constitution of Meaning – A Meaningful Constitution? Legitimacy, identity, and public opinion in the debate on the future of Europe
- 2005**
1. Claus J. Varnes
Managing product innovation through rules – The role of formal and structured methods in product development
2. Helle Hedegaard Hein
Mellem konflikt og konsensus – Dialogudvikling på hospitalsklinikker
3. Axel Rosenø
Customer Value Driven Product Innovation – A Study of Market Learning in New Product Development
4. Søren Buhl Pedersen
*Making space
An outline of place branding*
5. Camilla Funck Ellehave
*Differences that Matter
An analysis of practices of gender and organizing in contemporary work-places*
6. Rigmor Madeleine Lond
Styring af kommunale forvaltninger
7. Mette Aagaard Andreassen
Supply Chain versus Supply Chain Benchmarking as a Means to Managing Supply Chains
8. Caroline Aggestam-Pontoppidan
*From an idea to a standard
The UN and the global governance of accountants' competence*
9. Norsk ph.d.
10. Vivienne Heng Ker-ni
An Experimental Field Study on the

- Effectiveness of Grocer Media Advertising*
Measuring Ad Recall and Recognition, Purchase Intentions and Short-Term Sales
11. Allan Mortensen
Essays on the Pricing of Corporate Bonds and Credit Derivatives
12. Remo Stefano Chiari
Figure che fanno conoscere
Itinerario sull'idea del valore cognitivo e espressivo della metafora e di altri tropi da Aristotele e da Vico fino al cognitivismo contemporaneo
13. Anders McIlquham-Schmidt
Strategic Planning and Corporate Performance
An integrative research review and a meta-analysis of the strategic planning and corporate performance literature from 1956 to 2003
14. Jens Geersbro
The TDF – PMI Case
Making Sense of the Dynamics of Business Relationships and Networks
15. Mette Andersen
Corporate Social Responsibility in Global Supply Chains
Understanding the uniqueness of firm behaviour
16. Eva Boxenbaum
Institutional Genesis: Micro – Dynamic Foundations of Institutional Change
17. Peter Lund-Thomsen
Capacity Development, Environmental Justice NGOs, and Governance: The Case of South Africa
18. Signe Jarlov
Konstruktioner af offentlig ledelse
19. Lars Stæhr Jensen
Vocabulary Knowledge and Listening Comprehension in English as a Foreign Language
- An empirical study employing data elicited from Danish EFL learners*
20. Christian Nielsen
Essays on Business Reporting
Production and consumption of strategic information in the market for information
21. Marianne Thejls Fischer
Egos and Ethics of Management Consultants
22. Annie Bekke Kjær
Performance management i Process-innovation
– belyst i et social-konstruktivistisk perspektiv
23. Suzanne Dee Pedersen
GENTAGELSENS METAMORFOSE
Om organisering af den kreative gørem i den kunstneriske arbejdspraksis
24. Benedikte Dorte Rosenbrink
Revenue Management
Økonomiske, konkurrencemæssige & organisatoriske konsekvenser
25. Thomas Riise Johansen
Written Accounts and Verbal Accounts
The Danish Case of Accounting and Accountability to Employees
26. Ann Fogelgren-Pedersen
The Mobile Internet: Pioneering Users' Adoption Decisions
27. Birgitte Rasmussen
Ledelse i fællesskab – de tillidsvalgte fornyende rolle
28. Gitte Thit Nielsen
Remerger
– skabende ledelseskrafter i fusion og opkøb
29. Carmine Gioia
A MICROECONOMETRIC ANALYSIS OF MERGERS AND ACQUISITIONS

30. Ole Hinz
Den effektive forandringsleder: pilot, pædagog eller politiker?
Et studie i arbejdslederes meningstilskrivninger i forbindelse med vellykket gennemførelse af ledelsesinitierede forandringsprojekter
31. Kjell-Åge Gotvassli
Et praksisbasert perspektiv på dynamiske læringsnettverk i toppidretten
Norsk ph.d., ej til salg gennem Samfundslitteratur
32. Henriette Langstrup Nielsen
Linking Healthcare
An inquiry into the changing performances of web-based technology for asthma monitoring
33. Karin Tweddell Levinsen
Virtuel Uddannelsespraksis
Master i IKT og Læring – et casestudie i hvordan proaktiv proceshåndtering kan forbedre praksis i virtuelle læringsmiljøer
34. Anika Liversage
Finding a Path
Labour Market Life Stories of Immigrant Professionals
35. Kasper Elmquist Jørgensen
Studier i samspillet mellem stat og erhvervsliv i Danmark under 1. verdenskrig
36. Finn Janning
A DIFFERENT STORY
Seduction, Conquest and Discovery
37. Patricia Ann Plackett
Strategic Management of the Radical Innovation Process
Leveraging Social Capital for Market Uncertainty Management
2. Niels Rom-Poulsen
Essays in Computational Finance
3. Tina Brandt Husman
Organisational Capabilities, Competitive Advantage & Project-Based Organisations
The Case of Advertising and Creative Good Production
4. Mette Rosenkrands Johansen
Practice at the top
– how top managers mobilise and use non-financial performance measures
5. Eva Parum
Corporate governance som strategisk kommunikations- og ledelsesværktøj
6. Susan Aagaard Petersen
Culture's Influence on Performance Management: The Case of a Danish Company in China
7. Thomas Nicolai Pedersen
The Discursive Constitution of Organizational Governance – Between unity and differentiation
The Case of the governance of environmental risks by World Bank environmental staff
8. Cynthia Selin
Volatile Visions: Transactions in Anticipatory Knowledge
9. Jesper Banghøj
Financial Accounting Information and Compensation in Danish Companies
10. Mikkel Lucas Overby
Strategic Alliances in Emerging High-Tech Markets: What's the Difference and does it Matter?
11. Tine Aage
External Information Acquisition of Industrial Districts and the Impact of Different Knowledge Creation Dimensions

2006

1. Christian Vintergaard
Early Phases of Corporate Venturing

- A case study of the Fashion and Design Branch of the Industrial District of Montebelluna, NE Italy*
12. Mikkel Flyverbom
*Making the Global Information Society Governable
On the Governmentality of Multi-Stakeholder Networks*
 13. Anette Grønning
*Personen bag
Tilstedevær i e-mail som interaktionsform mellem kunde og medarbejder i dansk forsikringskontekst*
 14. Jørn Helder
*One Company – One Language?
The NN-case*
 15. Lars Bjerregaard Mikkelsen
*Differing perceptions of customer value
Development and application of a tool for mapping perceptions of customer value at both ends of customer-supplier dyads in industrial markets*
 16. Lise Granerud
*Exploring Learning
Technological learning within small manufacturers in South Africa*
 17. Esben Rahbek Pedersen
*Between Hopes and Realities:
Reflections on the Promises and Practices of Corporate Social Responsibility (CSR)*
 18. Ramona Samson
*The Cultural Integration Model and European Transformation.
The Case of Romania*
- 2007**
1. Jakob Vestergaard
*Discipline in The Global Economy
Panopticism and the Post-Washington Consensus*
 2. Heidi Lund Hansen
*Spaces for learning and working
A qualitative study of change of work, management, vehicles of power and social practices in open offices*
 3. Sudhanshu Rai
*Exploring the internal dynamics of software development teams during user analysis
A tension enabled Institutionalization Model; "Where process becomes the objective"*
 4. Norsk ph.d.
Ej til salg gennem Samfundslitteratur
 5. Serden Ozcan
*EXPLORING HETEROGENEITY IN ORGANIZATIONAL ACTIONS AND OUTCOMES
A Behavioural Perspective*
 6. Kim Sundtoft Hald
*Inter-organizational Performance Measurement and Management in Action
– An Ethnography on the Construction of Management, Identity and Relationships*
 7. Tobias Lindeberg
*Evaluative Technologies
Quality and the Multiplicity of Performance*
 8. Merete Wedell-Wedellsborg
*Den globale soldat
Identitetsdannelse og identitetsledelse i multinationale militære organisationer*
 9. Lars Frederiksen
*Open Innovation Business Models
Innovation in firm-hosted online user communities and inter-firm project ventures in the music industry
– A collection of essays*
 10. Jonas Gabrielsen
Retorisk toposlære – fra statisk 'sted' til persuasiv aktivitet

11. Christian Moldt-Jørgensen
Fra meningsløs til meningsfuld evaluering.
Anvendelsen af studentertilfredsheds-målinger på de korte og mellemlange videregående uddannelser set fra et psykodynamisk systemperspektiv
12. Ping Gao
Extending the application of actor-network theory
Cases of innovation in the telecommunications industry
13. Peter Mejlby
Frihed og fængsel, en del af den samme drøm?
Et phronetisk baseret casestudie af frigørelsens og kontrollens sam-eksistens i værdibaseret ledelse!
14. Kristina Birch
Statistical Modelling in Marketing
15. Signe Poulsen
Sense and sensibility:
The language of emotional appeals in insurance marketing
16. Anders Bjerre Trolle
Essays on derivatives pricing and dynamic asset allocation
17. Peter Feldhütter
Empirical Studies of Bond and Credit Markets
18. Jens Henrik Eggert Christensen
Default and Recovery Risk Modeling and Estimation
19. Maria Theresa Larsen
Academic Enterprise: A New Mission for Universities or a Contradiction in Terms?
Four papers on the long-term implications of increasing industry involvement and commercialization in academia
20. Morten Wellendorf
Postimplementering af teknologi i den offentlige forvaltning
Analysen af en organisations kontinuerlige arbejde med informations-teknologi
21. Ekaterina Mhaanna
Concept Relations for Terminological Process Analysis
22. Stefan Ring Thorbjørnsen
Forsvaret i forandring
Et studie i officerers kapabiliteter under påvirkning af omverdenens forandringspres mod øget styring og læring
23. Christa Breum Amhøj
Det selvskabte medlemskab om managementsstaten, dens styringsteknologier og indbyggere
24. Karoline Bromose
Between Technological Turbulence and Operational Stability
– An empirical case study of corporate venturing in TDC
25. Susanne Justesen
Navigating the Paradoxes of Diversity in Innovation Practice
– A Longitudinal study of six very different innovation processes – in practice
26. Luise Noring Henler
Conceptualising successful supply chain partnerships
– Viewing supply chain partnerships from an organisational culture perspective
27. Mark Mau
Kampen om telefonen
Det danske telefonvæsen under den tyske besættelse 1940-45
28. Jakob Halskov
The semiautomatic expansion of existing terminological ontologies using knowledge patterns discovered

- on the WWW – an implementation and evaluation*
29. Gergana Koleva
European Policy Instruments Beyond Networks and Structure: The Innovative Medicines Initiative
 30. Christian Geisler Asmussen
Global Strategy and International Diversity: A Double-Edged Sword?
 31. Christina Holm-Petersen
*Stolthed og fordom
Kultur- og identitetsarbejde ved skabelsen af en ny sengeafdeling gennem fusion*
 32. Hans Peter Olsen
*Hybrid Governance of Standardized States
Causes and Contours of the Global Regulation of Government Auditing*
 33. Lars Bøge Sørensen
Risk Management in the Supply Chain
 34. Peter Aagaard
*Det unikkes dynamikker
De institutionelle mulighedsbetingelser bag den individuelle udforskning i professionelt og frivilligt arbejde*
 35. Yun Mi Antorini
*Brand Community Innovation
An Intrinsic Case Study of the Adult Fans of LEGO Community*
 36. Joachim Lynggaard Boll
*Labor Related Corporate Social Performance in Denmark
Organizational and Institutional Perspectives*
- 2008**
1. Frederik Christian Vinten
Essays on Private Equity
 2. Jesper Clement
Visual Influence of Packaging Design on In-Store Buying Decisions
 3. Marius Brostrøm Kousgaard
*Tid til kvalitetsmåling?
– Studier af indrulleringsprocesser i forbindelse med introduktionen af kliniske kvalitetsdatabaser i speciallægepraksissektoren*
 4. Irene Skovgaard Smith
*Management Consulting in Action
Value creation and ambiguity in client-consultant relations*
 5. Anders Rom
*Management accounting and integrated information systems
How to exploit the potential for management accounting of information technology*
 6. Marina Candi
Aesthetic Design as an Element of Service Innovation in New Technology-based Firms
 7. Morten Schnack
*Teknologi og tværfaglighed
– en analyse af diskussionen omkring indførelse af EPJ på en hospitalsafdeling*
 8. Helene Balslev Clausen
Juntos pero no revueltos – un estudio sobre emigrantes norteamericanos en un pueblo mexicano
 9. Lise Justesen
*Kunsten at skrive revisionsrapporter.
En beretning om forvaltningsrevisionsens beretninger*
 10. Michael E. Hansen
The politics of corporate responsibility: CSR and the governance of child labor and core labor rights in the 1990s
 11. Anne Roepstorff
Holdning for handling – en etnologisk undersøgelse af Virksomheders Sociale Ansvar/CSR

12. Claus Bajlum
Essays on Credit Risk and Credit Derivatives
13. Anders Bojesen
The Performative Power of Competence – an Inquiry into Subjectivity and Social Technologies at Work
14. Satu Reijonen
*Green and Fragile
A Study on Markets and the Natural Environment*
15. Ilduara Busta
*Corporate Governance in Banking
A European Study*
16. Kristian Anders Hvass
*A Boolean Analysis Predicting Industry Change: Innovation, Imitation & Business Models
The Winning Hybrid: A case study of isomorphism in the airline industry*
17. Trine Paludan
De uvidende og de udviklingsparate Identitet som mulighed og restriktion blandt fabriksarbejdere på det aftayloriserede fabriksgulv
18. Kristian Jakobsen
Foreign market entry in transition economies: Entry timing and mode choice
19. Jakob Elming
Syntactic reordering in statistical machine translation
20. Lars Brømsøe Termansen
*Regional Computable General Equilibrium Models for Denmark
Three papers laying the foundation for regional CGE models with agglomeration characteristics*
21. Mia Reinholdt
The Motivational Foundations of Knowledge Sharing
22. Frederikke Krogh-Meibom
*The Co-Evolution of Institutions and Technology
– A Neo-Institutional Understanding of Change Processes within the Business Press – the Case Study of Financial Times*
23. Peter D. Ørberg Jensen
OFFSHORING OF ADVANCED AND HIGH-VALUE TECHNICAL SERVICES: ANTECEDENTS, PROCESS DYNAMICS AND FIRMLEVEL IMPACTS
24. Pham Thi Song Hanh
Functional Upgrading, Relational Capability and Export Performance of Vietnamese Wood Furniture Producers
25. Mads Vangkilde
*Why wait?
An Exploration of first-mover advantages among Danish e-grocers through a resource perspective*
26. Hubert Buch-Hansen
*Rethinking the History of European Level Merger Control
A Critical Political Economy Perspective*
- 2009**
1. Vivian Lindhardsen
From Independent Ratings to Communal Ratings: A Study of CWA Raters' Decision-Making Behaviours
2. Guðrið Weihe
Public-Private Partnerships: Meaning and Practice
3. Chris Nøkkentved
*Enabling Supply Networks with Collaborative Information Infrastructures
An Empirical Investigation of Business Model Innovation in Supplier Relationship Management*
4. Sara Louise Muhr
Wound, Interrupted – On the Vulnerability of Diversity Management

5. Christine Sestoft
Forbrugeradfærd i et Stats- og Livsformsteoretisk perspektiv
6. Michael Pedersen
Tune in, Breakdown, and Reboot: On the production of the stress-fit self-managing employee
7. Salla Lutz
Position and Reposition in Networks – Exemplified by the Transformation of the Danish Pine Furniture Manufacturers
8. Jens Forssbæck
Essays on market discipline in commercial and central banking
9. Tine Murphy
Sense from Silence – A Basis for Organised Action
How do Sensemaking Processes with Minimal Sharing Relate to the Reproduction of Organised Action?
10. Sara Malou Strandvad
Inspirations for a new sociology of art: A sociomaterial study of development processes in the Danish film industry
11. Nicolaas Mouton
On the evolution of social scientific metaphors: A cognitive-historical enquiry into the divergent trajectories of the idea that collective entities – states and societies, cities and corporations – are biological organisms.
12. Lars Andreas Knutsen
Mobile Data Services: Shaping of user engagements
13. Nikolaos Theodoros Korfiatis
Information Exchange and Behavior
A Multi-method Inquiry on Online Communities
14. Jens Albæk
Forestillinger om kvalitet og tværfaglighed på sygehuse
– skabelse af forestillinger i læge- og plejegrupperne angående relevans af nye idéer om kvalitetsudvikling gennem tolkningsprocesser
15. Maja Lotz
The Business of Co-Creation – and the Co-Creation of Business
16. Gitte P. Jakobsen
Narrative Construction of Leader Identity in a Leader Development Program Context
17. Dorte Hermansen
“Living the brand” som en brandorienteret dialogisk praksis: Om udvikling af medarbejdernes brandorienterede dømmekraft
18. Aseem Kinra
Supply Chain (logistics) Environmental Complexity
19. Michael Nørager
How to manage SMEs through the transformation from non innovative to innovative?
20. Kristin Wallevik
Corporate Governance in Family Firms
The Norwegian Maritime Sector
21. Bo Hansen Hansen
Beyond the Process
Enriching Software Process Improvement with Knowledge Management
22. Annemette Skot-Hansen
Franske adjektivisk afledte adverbier, der tager præpositionssyntagmer indledt med præpositionen à som argumenter
En valensgrammatisk undersøgelse
23. Line Gry Knudsen
Collaborative R&D Capabilities
In Search of Micro-Foundations

24. Christian Scheuer
*Employers meet employees
Essays on sorting and globalization*
25. Rasmus Johnsen
*The Great Health of Melancholy
A Study of the Pathologies of Performativity*
26. Ha Thi Van Pham
*Internationalization, Competitiveness
Enhancement and Export Performance
of Emerging Market Firms:
Evidence from Vietnam*
27. Henriette Balieu
*Kontrollbegrebets betydning for kausalalternationen i spansk
En kognitiv-typologisk analyse*
- 2010**
1. Yen Tran
*Organizing Innovation in Turbulent
Fashion Market
Four papers on how fashion firms create and appropriate innovation value*
2. Anders Raastrup Kristensen
*Metaphysical Labour
Flexibility, Performance and Commitment in Work-Life Management*
3. Margrét Sigrún Sigurdardóttir
*Dependently independent
Co-existence of institutional logics in the recorded music industry*
4. Ásta Dis Óladóttir
*Internationalization from a small domestic base:
An empirical analysis of Economics and Management*
5. Christine Secher
E-deltagelse i praksis – politikernes og forvaltningens medkonstruktion og konsekvenserne heraf
6. Marianne Stang Våland
What we talk about when we talk about space:
7. Rex Degnegaard
*Strategic Change Management
Change Management Challenges in the Danish Police Reform*
8. Ulrik Schultz Brix
*Værdi i rekruttering – den sikre beslutning
En pragmatisk analyse af perception og synliggørelse af værdi i rekrutterings- og udvælgelsesarbejdet*
9. Jan Ole Similå
*Kontraktsledelse
Relasjonen mellom virksomhetsledelse og kontraktshåndtering, belyst via fire norske virksomheter*
10. Susanne Boch Waldorff
Emerging Organizations: In between local translation, institutional logics and discourse
11. Brian Kane
*Performance Talk
Next Generation Management of Organizational Performance*
12. Lars Ohnemus
*Brand Thrust: Strategic Branding and Shareholder Value
An Empirical Reconciliation of two Critical Concepts*
13. Jesper Schlamovitz
Håndtering af usikkerhed i film- og byggeprojekter
14. Tommy Moesby-Jensen
*Det faktiske livs forbindtlighed
Føroskratisk informeret, ny-aristotelisk ἦθος-tænkning hos Martin Heidegger*
15. Christian Fich
*Two Nations Divided by Common Values
French National Habitus and the Rejection of American Power*

16. Peter Beyer
Processer, sammenhængskraft og fleksibilitet
Et empirisk casestudie af omstillingsforløb i fire virksomheder
17. Adam Buchhorn
Markets of Good Intentions
Constructing and Organizing Biogas Markets Amid Fragility and Controversy
18. Cecilie K. Moesby-Jensen
Social læring og fælles praksis
Et mixed method studie, der belyser læringskonsekvenser af et lederkursus for et praksisfællesskab af offentlige mellemledere
19. Heidi Boye
Fødevarer og sundhed i sen-modernismen
– En indsigt i hyggefænomenet og de relaterede fødevarerpraksisser
20. Kristine Munkgård Pedersen
Flygtige forbindelser og midlertidige mobiliseringer
Om kulturel produktion på Roskilde Festival
21. Oliver Jacob Weber
Causes of Intercompany Harmony in Business Markets – An Empirical Investigation from a Dyad Perspective
22. Susanne Ekman
Authority and Autonomy
Paradoxes of Modern Knowledge Work
23. Anette Frey Larsen
Kvalitetsledelse på danske hospitaler
– Ledelsernes indflydelse på introduktion og vedligeholdelse af kvalitetsstrategier i det danske sundhedsvæsen
24. Toyoko Sato
Performativity and Discourse: Japanese Advertisements on the Aesthetic Education of Desire
25. Kenneth Brinch Jensen
Identifying the Last Planner System
Lean management in the construction industry
26. Javier Busquets
Orchestrating Network Behavior for Innovation
27. Luke Patey
The Power of Resistance: India's National Oil Company and International Activism in Sudan
28. Mette Vedel
Value Creation in Triadic Business Relationships. Interaction, Interconnection and Position
29. Kristian Tørning
Knowledge Management Systems in Practice – A Work Place Study
30. Qingxin Shi
An Empirical Study of Thinking Aloud
Usability Testing from a Cultural Perspective
31. Tanja Juul Christiansen
Corporate blogging: Medarbejderes kommunikative handlekraft
32. Malgorzata Ciesielska
Hybrid Organisations.
A study of the Open Source – business setting
33. Jens Dick-Nielsen
Three Essays on Corporate Bond Market Liquidity
34. Sabrina Speiermann
Modstandens Politik
Kampagnestyling i Velfærdsstaten.
En diskussion af trafikcampagners styringspotentiale
35. Julie Uldam
Fickle Commitment. Fostering political engagement in 'the flighty world of online activism'

36. Annegrete Juul Nielsen
Traveling technologies and transformations in health care
37. Athur Mühlen-Schulte
Organising Development Power and Organisational Reform in the United Nations Development Programme
38. Louise Rygaard Jonas
Branding på butiksgulvet Et case-studie af kultur- og identitetsarbejdet i Kvickly
8. Ole Helby Petersen
Public-Private Partnerships: Policy and Regulation – With Comparative and Multi-level Case Studies from Denmark and Ireland
9. Morten Krogh Petersen
'Good' Outcomes. Handling Multiplicity in Government Communication
10. Kristian Tangsgaard Hvelplund
Allocation of cognitive resources in translation - an eye-tracking and key-logging study

2011

1. Stefan Fraenkel
Key Success Factors for Sales Force Readiness during New Product Launch A Study of Product Launches in the Swedish Pharmaceutical Industry
2. Christian Plesner Rossing
International Transfer Pricing in Theory and Practice
3. Tobias Dam Hede
Samtalekunst og ledelsesdisciplin – en analyse af coachingsdiskursens genealogi og governmentality
4. Kim Pettersson
Essays on Audit Quality, Auditor Choice, and Equity Valuation
5. Henrik Merkelsen
The expert-lay controversy in risk research and management. Effects of institutional distances. Studies of risk definitions, perceptions, management and communication
6. Simon S. Torp
Employee Stock Ownership: Effect on Strategic Management and Performance
7. Mie Harder
Internal Antecedents of Management Innovation
11. Moshe Yonatany
The Internationalization Process of Digital Service Providers
12. Anne Vestergaard
Distance and Suffering Humanitarian Discourse in the age of Mediatization
13. Thorsten Mikkelsen
Personlighedens indflydelse på forretningsrelationer
14. Jane Thostrup Jagd
Hvorfor fortsætter fusionsbølgen udover "the tipping point"? – en empirisk analyse af information og kognitioner om fusioner
15. Gregory Gimpel
Value-driven Adoption and Consumption of Technology: Understanding Technology Decision Making
16. Thomas Stengade Sønderskov
Den nye mulighed Social innovation i en forretningsmæssig kontekst
17. Jeppe Christoffersen
Donor supported strategic alliances in developing countries
18. Vibeke Vad Baunsgaard
Dominant Ideological Modes of Rationality: Cross functional

- integration in the process of product innovation*
19. Throstur Olaf Sigurjonsson
Governance Failure and Iceland's Financial Collapse
 20. Allan Sall Tang Andersen
Essays on the modeling of risks in interest-rate and inflation markets
 21. Heidi Tscherning
Mobile Devices in Social Contexts
 22. Birgitte Gorm Hansen
Adapting in the Knowledge Economy Lateral Strategies for Scientists and Those Who Study Them
 23. Kristina Vaarst Andersen
Optimal Levels of Embeddedness The Contingent Value of Networked Collaboration
 24. Justine Grøn bæk Pors
Noisy Management A History of Danish School Governing from 1970-2010
 25. Stefan Linder
Micro-foundations of Strategic Entrepreneurship Essays on Autonomous Strategic Action
 26. Xin Li
Toward an Integrative Framework of National Competitiveness An application to China
 27. Rune Thorbjørn Clausen
Værdifuld arkitektur Et eksplorativt studie af bygningers rolle i virksomheders værdiskabelse
 28. Monica Viken
Markedsundersøkelser som bevis i varemerke- og markedsføringsrett
 29. Christian Wymann
Tattooing The Economic and Artistic Constitution of a Social Phenomenon
 30. Sanne Frandsen
Productive Incoherence A Case Study of Branding and Identity Struggles in a Low-Prestige Organization
 31. Mads Stenbo Nielsen
Essays on Correlation Modelling
 32. Ivan Häuser
Følelse og sprog Etablering af en ekspressiv kategori, eksemplificeret på russisk
 33. Sebastian Schwenen
Security of Supply in Electricity Markets
- 2012**
1. Peter Holm Andreasen
The Dynamics of Procurement Management - A Complexity Approach
 2. Martin Haulrich
Data-Driven Bitext Dependency Parsing and Alignment
 3. Line Kirkegaard
Konsulenten i den anden nat En undersøgelse af det intense arbejdsliv
 4. Tonny Stenheim
Decision usefulness of goodwill under IFRS
 5. Morten Lind Larsen
Produktivitet, vækst og velfærd Industrirådet og efterkrigstidens Danmark 1945 - 1958
 6. Petter Berg
Cartel Damages and Cost Asymmetries
 7. Lynn Kahle
Experiential Discourse in Marketing A methodical inquiry into practice and theory
 8. Anne Roelsgaard Obling
Management of Emotions in Accelerated Medical Relationships

9. Thomas Frandsen
*Managing Modularity of
Service Processes Architecture*

TITLER I ATV PH.D.-SERIEN

1992

1. Niels Kornum
Servicesamkørsel – organisation, økonomi og planlægningsmetode

1995

2. Verner Worm
*Nordiske virksomheder i Kina
Kulturspecifikke interaktionsrelationer
ved nordiske virksomhedsetableringer i Kina*

1999

3. Mogens Bjerre
*Key Account Management of Complex
Strategic Relationships
An Empirical Study of the Fast Moving
Consumer Goods Industry*

2000

4. Lotte Darsø
*Innovation in the Making
Interaction Research with heterogeneous
Groups of Knowledge Workers
creating new Knowledge and new
Leads*

2001

5. Peter Hobolt Jensen
*Managing Strategic Design Identities
The case of the Lego Developer
Network*

2002

6. Peter Lohmann
*The Deleuzian Other of Organizational
Change – Moving Perspectives of the
Human*
7. Anne Marie Jess Hansen
*To lead from a distance: The dynamic
interplay between strategy and
strategizing – A case study of the
strategic management process*

2003

8. Lotte Henriksen
*Videndeling
– om organisatoriske og ledelsesmæssige
udfordringer ved videndeling i
praksis*
9. Niels Christian Nickelsen
*Arrangements of Knowing: Coordinating
Procedures Tools and Bodies in
Industrial Production – a case study of
the collective making of new products*

2005

10. Carsten Ørts Hansen
*Konstruktion af ledelsesteknologier og
effektivitet*

TITLER I DBA PH.D.-SERIEN

2007

1. Peter Kastrup-Misir
*Endeavoring to Understand Market
Orientation – and the concomitant
co-mutation of the researched, the
researcher, the research itself and the
truth*

2009

1. Torild Leo Thellefsen
*Fundamental Signs and Significance
effects
A Semeiotic outline of Fundamental
Signs, Significance-effects, Knowledge
Profiling and their use in Knowledge
Organization and Branding*
2. Daniel Ronzani
*When Bits Learn to Walk Don't Make
Them Trip. Technological Innovation
and the Role of Regulation by Law
in Information Systems Research: the
Case of Radio Frequency Identification
(RFID)*

2010

1. Alexander Carnera
*Magten over livet og livet som magt
Studier i den bipolitiske ambivalens*