

Saarenheimo, Tuomas

**Working Paper**

## The equilibrium exchange rate for the Finnish Markka

Bank of Finland Discussion Papers, No. 29/1995

**Provided in Cooperation with:**

Bank of Finland, Helsinki

*Suggested Citation:* Saarenheimo, Tuomas (1995) : The equilibrium exchange rate for the Finnish Markka, Bank of Finland Discussion Papers, No. 29/1995, ISBN 951-686-472-4, Bank of Finland, Helsinki,  
<https://nbn-resolving.de/urn:nbn:fi:bof-20140807263>

This Version is available at:

<https://hdl.handle.net/10419/211742>

**Standard-Nutzungsbedingungen:**

Die Dokumente auf EconStor dürfen zu eigenen wissenschaftlichen Zwecken und zum Privatgebrauch gespeichert und kopiert werden.

Sie dürfen die Dokumente nicht für öffentliche oder kommerzielle Zwecke vervielfältigen, öffentlich ausstellen, öffentlich zugänglich machen, vertreiben oder anderweitig nutzen.

Sofern die Verfasser die Dokumente unter Open-Content-Lizenzen (insbesondere CC-Lizenzen) zur Verfügung gestellt haben sollten, gelten abweichend von diesen Nutzungsbedingungen die in der dort genannten Lizenz gewährten Nutzungsrechte.

**Terms of use:**

*Documents in EconStor may be saved and copied for your personal and scholarly purposes.*

*You are not to copy documents for public or commercial purposes, to exhibit the documents publicly, to make them publicly available on the internet, or to distribute or otherwise use the documents in public.*

*If the documents have been made available under an Open Content Licence (especially Creative Commons Licences), you may exercise further usage rights as specified in the indicated licence.*

---

# BANK OF FINLAND DISCUSSION PAPERS

---

29/95

**Tuomas Saarenheimo**

Economics Department  
31.10.1995

## The Equilibrium Exchange Rate for the Finnish Markka

**Suomen Pankki**  
**Bank of Finland**  
**P.O.Box 160, SF-00101 HELSINKI, Finland**  
**☎ + 358 0 1831**

**Tuomas Saarenheimo**

31.10.1995

**The Equilibrium Exchange Rate  
for the Finnish Markka**

ISBN 951-686-472-4  
ISSN 0785-3572

Suomen Pankin monistuskeskus  
Helsinki 1995

# The Equilibrium Exchange Rate for the Finnish Markka

Bank of Finland Discussion Papers 29/95

Tuomas Saarenheimo  
Economics Department

## Abstract

The purpose of this paper is to analyze the behavior of the equilibrium exchange rate for the Finnish markka in the final years of this century. We construct a small – but relatively self contained – dynamic macro model that seeks to capture the most essential interdependencies of the Finnish economy. This model is used in calculating the equilibrium paths for nominal exchange rate and domestic activity.

The simulations show that with the projected development of foreign demand, trade prices, and domestic wages, the equilibrium exchange rate remains virtually constant over the next four years, at a level very close to the current (mid-1995) exchange rate. That allows for an approximate 4.5 percent non-inflationary average rate of growth. Changes in trade prices and foreign demand only have a modest effect on the equilibrium exchange rate; due to the combination of a non-accommodative inflation constraint and rigid wages, equilibrium is restored primarily by adjusting domestic demand, and hence, the growth rate of the domestic economy.

The importance of wage moderation is emphasized most dramatically in a scenario in which the rate of wage increases is assumed to exceed the baseline projection by one percent a year. In this scenario, keeping inflation at the target level requires a steady appreciation of the markka and a reduction in the average growth rate to 2.8 percent.

## Tiivistelmä

Tutkimuksessa hahmotellaan Suomen markan tasapainovaluuttakurssin kehitystä vuosituhaten vaihteeseen saakka. Tutkimuksessa rakennetaan tätä tarkoitusta varten pieni makromalli, jolla pyritään mallittamaan Suomen talouden keskeisimmät riippuvuussuhteet. Mallin avulla lasketaan tasapainourat nimelliselle valuuttakurssille sekä kotimaiselle kysynnälle.

Mallisimuloinnit osoittavat, että ulkomaisen kysynnän, vaihtosuhteen ja kotimaisen palkkatason kehittyessä odotetulla tavalla nimellinen tasapainovaluuttakurssi pysyy seuraavan neljän vuoden ajan käytännössä vakaana tasolla, joka on lähellä nykyistä (vuoden 1995 puolivälin) tasoa. Tällainen valuuttakurssikehitys sallii noin 4.5 prosentin keskimääräisen talouden kasvuvauhdin ilman inflaatiopaineiden kasautumista. Muutokset ulkomaankaupan hinnoissa ja kysynnässä vaikuttavat tasapainovaluuttakurssin uraan suhteellisen vähän; tiukan inflaatorajoitteen ja joustamattomien palkkojen takia uusi tasapaino joudutaan hakemaan sopeuttamalla ensisijaisesti kotimaista kysyntää ja kasvua.

Maltillisen palkkakehityksen merkitys näkyy selkeimmin skenaariossa, jossa kotimaisten palkkojen vuosittaista nousuvauhtia on nostettu perusuraan verrattuna yhdellä prosenttiyksiköllä. Tällöin inflaatiotavoitteen saavuttaminen edellyttää markan tasaista revalvoitumista ja talouden kasvuvauhdin hidastumista keskimäärin 2.8 prosentin tasolle.

# Contents

	page
Abstract	3
1 Introduction	7
2 External balance	10
2.1 Trends and developments in the current account	10
2.2 An econometric model for the elements of the current account	11
2.2.1 The volume of trade in goods	12
2.2.2 Services balance	14
2.2.3 Current transfers and other items	14
2.2.4 Property and entrepreneurial income	14
3 Simulation exercises for external balance	15
3.1 Four scenarios	15
3.2 Simulations for the external balance	15
4 Internal balance	18
5 Simulation exercises with the complete model	18
5.1 The simulation model	18
5.2 Simulation results	19
5.3 Discussion and interpretations	21
6 Conclusions	23
References	24
Appendix	25

# 1 Introduction

After three years with a floating Finnish markka, the question has again begun to surface with increasing frequency: should the exchange rate of the markka be fixed and, if so, at what level. The immediate question relates to the possible entry of Finland into the Exchange Rate Mechanism (ERM). Eventually, the question will have to be answered in connection with the third stage of EMU. Once the decision to fix the exchange rate is made, then in order to avoid creating pressures from the beginning, it is vital that the exchange rate be fixed at a level that is sustainable in the long run. Too weak an exchange rate would bring about overheating of the economy and inflationary pressures. On the other hand, too high an initial rate would most likely produce a period of recession and deflation. In short, we need to find equilibrium exchange rate for the Finnish markka.

At the surface, "equilibrium exchange rate" is a rather straightforward concept; it is understood as the exchange rate that is consistent with economic fundamentals. Such a definition, however, hardly provides an operational concept. As noted in Bayoumi, Clark, Symansky and Taylor (1993) and Frenkel and Goldstein (1986), there are at least three broad approaches to determining the equilibrium exchange rate: the portfolio balance approach of exchange rate determination, the purchasing power parity approach, and the "macroeconomic balance" or "fundamental equilibrium exchange rate" (FEER) approach, outlined by Swan (1963), refined at the IMF in the 1970s and modified further by Williamson (1985, 1991).

This paper focuses on the last of these approaches. This tradition defines the equilibrium exchange rate as the real exchange rate that is consistent with medium-term internal and external macroeconomic balance. External macroeconomic balance is defined as a sustainable current account, i.e. a current account that corresponds to equilibrium levels of national saving and investment. In practice, this is usually taken to mean a zero current account deficit, but it may mean surplus or deficit, depending on the initial circumstances. The definition of internal balance varies more. In the original IMF tradition, internal balance was defined as potential, or full employment, output, which was modeled as being independent of the real exchange rate. Recently, internal balance has more often been defined as the combination of real exchange rate and output at which no inflationary or deflationary pressures exist. This is the version we will refer to as the FEER approach.

Figure 1 illustrates this approach. CA is the locus of combinations of output and competitiveness (inverse of the real exchange rate) for which the desired current account balance is obtained. The curve slopes upwards, since increasing output tends to weaken current account, which needs to be offset by an increase in competitiveness. At a point above locus CA, the current account is stronger than desired and vice versa.

For internal balance, the two alternative definitions are plotted. The vertical line  $Y^*$  denotes the full employment output used in the IMF approach. Locus N is the NAIRU (or NAWRU) locus. It is downward sloping since as domestic demand expands, competitiveness must weaken so as to stem inflationary pressures. Above the NAIRU locus, competitiveness is too high, which pushes up inflation until the real exchange rate returns to its equilibrium locus.

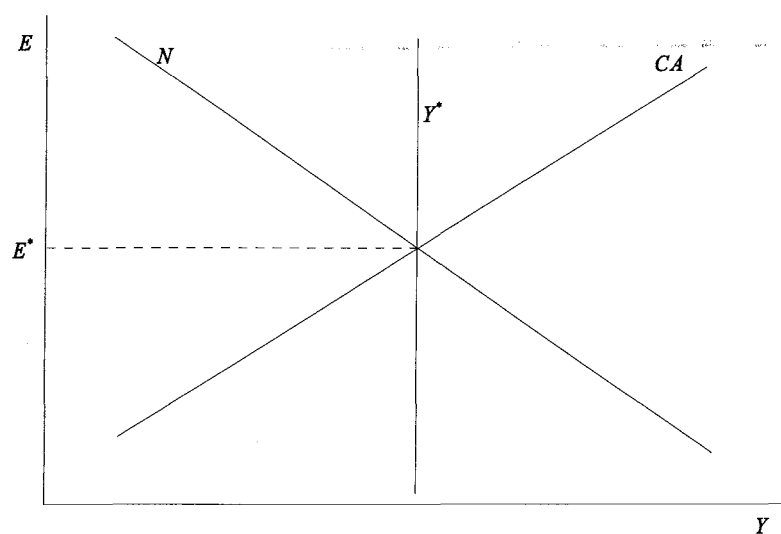

Figure 1.

**The FEER approach**

If  $Y^*$  is defined, as it should be, as the highest level of activity consistent with stable prices, all three locuses intersect at the same point. This serves to demonstrate that there is really no issue about which definition of internal balance is more correct. The non-accelerating-inflation level of activity, or potential output, cannot be defined without reference to competitiveness. It is to be seen as a reduced form representation of the intersection of the CA and N locuses. As the locuses shift, so does potential output. In what follows, the analysis is carried out using the latter two relations directly.

There are two polar operational approaches to the modeling of the macroeconomic balance. The first approach is to directly apply the comparative static structure of the analytical model illustrated in Figure 1. Hence, the comparative static approach comprises the estimation of a small set of static equations, minimally consisting of one equation each for internal and external balance. Although the comparative static model provides a valuable analytical tool and has the benefit of high transparency, it has obvious shortcomings when applied in an empirical model of a fundamentally dynamic phenomenon. Most importantly, time lags do play a considerable role in the transmission of the effects of exchange rate and activity changes to the current account and inflation. The time lags are likely to be long enough that the equilibrium exchange rate itself has already changed (as a result of changes in net foreign asset position or terms of trade) before the pass-through is complete. Therefore, in most cases, the primary focus of the papers that have employed this approach has been more on methodological issues than on producing estimates of equilibrium exchange rates.

Alternatively, one may obtain an estimate of the FEER directly from simulation of a macroeconomic model. This approach accounts for the dynamic aspects involved, but at the same time sacrifices much of the transparency. Finally, between these two polar approaches, there is a wide spectrum of combinations of the two. Much of the previous work has either used both approaches (as Bayoumi, Clark, Symansky, and Taylor, 1993), or calculated the reduced form steady state estimates of the comparative static equations from full scale dynamic macro models (e.g.

Williamson 1991, Barrel and in't Veld 1991, and Church 1992). Barrel and Wren-Lewis (1989) and Hoj (1994) estimate the comparative static equations directly.

The model in this paper lies somewhere around the midpoint between these two traditions. Our approach departs from both of them in that we do not seek to find out how much the past and present exchange rates deviate from their equilibrium values. Instead, we try to ask how to get from where Finland is now to where we think it ought to be over the next several years, given what we think about the future development of the international environment and what we see as the goals of economic policy. From this point of view, it is not very useful to assess that a currency is, for example, presently 10 percent overvalued – particularly if the country has a floating exchange rate regime. Instead, one would like to know what path of the exchange rate would bring the economy smoothly back onto its equilibrium path. The answer is not likely to be an immediate 10 percent devaluation, but a more gradual process instead.

The modeling strategy was chosen from a practical and policy-oriented point of view to attain the highest possible operational applicability to the present situation in Finland. External balance is modeled with a dynamic macro model, small enough to be transparent and to be estimated as a system but big enough to capture what we consider the most crucial interdependencies between the key Finnish macroeconomic variables and foreign trade flows. Internal balance consists of a single dynamic equation for the rate of consumer price inflation as a function of wages, productivity, exchange rate, foreign prices, and domestic activity. Wages are exogenous in the model. This choice is somewhat unfortunate, since it breaks an important link between the exchange rate and price formation; namely, the link from competitiveness to wages. This part of the model calls for further work.

The model produces equilibrium paths for the domestic demand and the exchange rate of the markka. These equilibrium paths are calculated by minimizing a loss function. The loss function heavily penalizes deviations of inflation and the current account balance from their desired values. Those degrees of freedom that are left after attaining the desired external and internal balances are used to maximize the average growth rate of GDP and to smooth exchange rate fluctuations. The intuition behind the loss function approach can be set out as follows. Domestic policymakers have a primary preference for low and stable inflation, and a secondary preference for high GDP growth. They can manipulate inflation and GDP through domestic demand, over which they have full control. The exchange rate is determined in the market so as to balance the current account at a given level. Both the policymakers and the market have rational expectations or, in the deterministic setting, complete information over the future development of all variables. Knowing the full structure of the model economy, policymakers can factor the market reaction (that is, the behavior of the exchange rate) into their objective function. The policymakers' problem then becomes one of choosing the path for domestic demand that produces the highest GDP growth for the given values of the current account balance and the rate of inflation.

As is customary in this tradition of literature, it is well to stress that calculating the FEER is basically a normative exercise. The results depend crucially on the choice of the desired values for the rate of inflation and the current account balance. Also, in the present exercise these desired values are adhered to strictly: for example, even when faced with wage rises that are extremely costly to combine with the desired rate of inflation, policymakers will not accommodate their target. Instead, domestic

demand is cut by the full amount necessary to comply with the inflation target. The choices of the target values and their strictness are all normative choices which carry a direct effect on the results.

## 2 External balance

### 2.1 Trends and developments in the current account

During recent decades, Finnish current account has been mostly in deficit. A surplus was recorded only in three of the last 25 years, the most recent of those in 1994. In the 1970s the deficit was mostly due to a sizable deficit in the trade of goods resulting from a rapid rate of domestic investment. Partly as a consequence of the increased capacity, the goods balance improved considerably in the late 1970s and has stayed slightly positive for most of the 1980s. Despite the improved trade balance in goods, the current account remained somewhat negative in the 1980s, mainly due to a rapidly weakening services balance, and because of the increasing costs of servicing the external debt.

As a contrast to the relatively serene development of the current account in the early and mid 1980's, the years since 1986 have been characterized by much more dramatic movements in the external balance. From a slight deficit of FIM 3.6 billion (less than one percent of GDP) in 1984 the current account plummeted to about FIM 25 billion in the red (five percent of GDP) in 1989, and stayed at that level for the next four years. In 1992 the current account began to recover and it has since that improved by nearly FIM 35 billion annually to reach a surplus on the order of more than two percent of GDP.

Several mutually offsetting trends underlie these rapid movements. The most prominent of those are depicted in Figure 2. A particularly striking trend has been the dramatic improvement in the trade balance, which climbed from a deficit in 1989 – a short slump caused by the collapse of Soviet union and the consequent drying up of Finnish bilateral trade – to a surplus of about 8 percent of GDP at present. The improvement is primarily the result of a rapid increase in exports, set off by strong competitiveness and a recovery in the world economy, but also partly due to low domestic demand and consequently low imports of goods.

The minor slump in the trade balance in the turn of the decade says little about the deep deficit in the current account at that time. The most obvious single element that weakened the current account was the explosion in net interest payments on external debt, from FIM 8.3 billion in 1988 to a peak of FIM 27 billion in 1993. Falling interest rates and a current account surplus have been pushing interest payments down in the last couple of years.

Although less often noticed than the increase in interest payments, the deterioration in the services balance was no less important in explaining the current account slump. In fact, the services balance was the biggest single contributor to the plunge of the current account balance in the ten years from 1981 to the bottom of the slump in 1991. From a peak surplus of FIM 4.9 billion (2.3 percent of GDP) in late

Figure 2.

### Current account and subbalances Four quarter moving sum

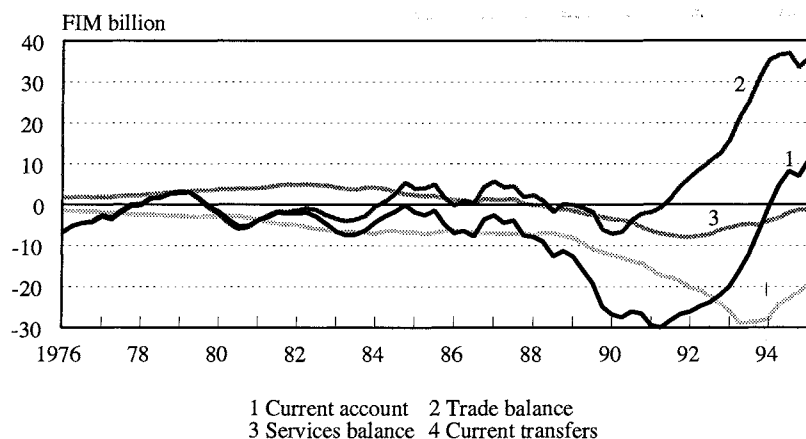

1981, services tumbled to a deficit of FIM 7.9 billion (1.6 percent of GDP) in 1991, accounting for more than half of the total deterioration of the current account over that period. The biggest contributors to the poor performance within the services balance were the weakening of travel balance (due to a rapid increase in travel imports), the balance on insurance services, and the balance on mixed services.

Presently, the trade balance surplus still looks robust, while the negative trends in interest payments and the services balance appear to have ended. Overall, this shows up as a continuing strengthening of the current account. In the years 1994–1995, for the first time since late 1960s, Finland will record a current account surplus in two consequent years.

## 2.2 An econometric model for the elements of the current account

The econometric model constructed for the current account consists of seven behavioral equations and a number of identities. As exogenous variables the model requires paths for domestic and foreign demand, Finnish exports of goods to Russia and Eastern Europe, some small current account items (as current transfers and the balance of services other than transportation and travel) several prices, and the nominal exchange rate. As output, the model produces the current account and its major sub-balances, industrial production, and the GDP. As it is, the model is rather Keynesian; production is demand driven and supply side issues, such as capital formation and capacity constraints do not enter the picture explicitly. The effect of these omissions should be greatest for a scenario in which Finnish export volume grows so fast that the capacity constraint could be expected to become binding. This is not the case in any of the scenarios considered in this paper. In the home market sector, production capital is not scarce and the assumption of demand driven development seems plausible. In what follows, the details and assumptions of the model are discussed.

Figure 3.

**The model schematics for trade in goods**

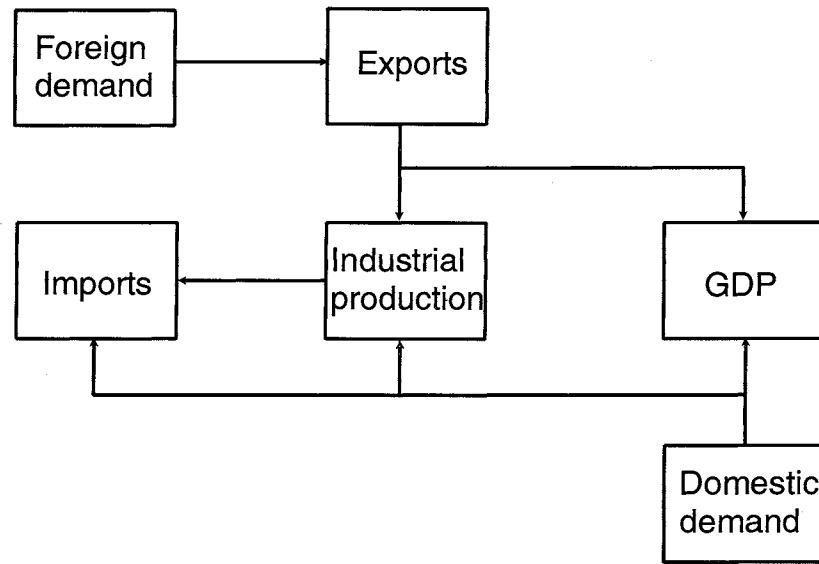

2.2.1 The volume of trade in goods

A pivotal feature of Finnish external trade in goods is the dependency of imports on exports. Approximately 60 percent of Finnish imports are raw materials and production equipment serving the immediate needs of Finnish industry. Of Finnish industrial production, on the other hand, almost 60 percent is either directly or indirectly (i.e. through subcontracting) exported. Hence, even in the short run, some 35 percent of goods imports depend on exports. In the long run, the contribution of exports is presumably still considerably larger.<sup>1</sup>

The model seeks to capture this feature by modeling trade in goods with a three equation structural model, consisting of equations for (the volumes of) industrial production, imports of goods, and exports of goods to countries other than Russia (Soviet union) and its former allies. Exports to the latter group of countries was – until the collapse of Soviet union – negotiated on a bilateral basis. The history of this series therefore carries little information about its future development and hence the series is treated as exogenous.

The most important exogenous activity variables in the model are foreign imports (i.e. the import demand of Finland's trading partners) and domestic demand. World prices of goods are treated as exogenous to Finland. This assumption is, in most cases, justifiable. The biggest problem probably arises in connection with the paper and pulp industry, where Finnish exporters do have some market power, at least in the short run. For the long run, we still find the assumption defensible.

---

<sup>1</sup> If one adds the imports of investment goods and fuels for industrial production purposes, the contribution of industrial production to goods imports rises to well over two-thirds of total goods imports.

The logic of the model is illustrated in Figure 3. Foreign imports (together with competitiveness) determine Finnish exports of goods. Exports, together with domestic demand determine industrial production and GDP. Finally, industrial production and the growth rate of domestic demand together with relative prices determine imports of goods.

The model is estimated using the Maximum Likelihood method with quarterly data over the period from 1971Q1 to 1994Q4. The resulting equations are reported in the Appendix. Table 1 summarizes the system-level results. The reported elasticities are reduced form elasticities, not the elasticities of individual equations. In other words, immediate elasticity is the within-period response of the system to a shock in an exogenous variable. Long-run elasticity measures the impulse response of the system in an infinite horizon. To provide sensible long-run implications, all long-run activity elasticities were restricted to unity.<sup>2</sup> In calculating exchange-rate elasticities it is assumed that import prices in domestic currency adjust fully and immediately to reflect changes in the exchange rate. This is clearly an extreme assumption – in reality, short-term rigidities and pricing-to-market behavior are likely to generate considerable lags in the pass-through of exchange rate to import prices. However, since no reliable estimates of the pass-through in Finland exist and such an analysis was well beyond the scope of this paper, no obvious alternative was available. For the long run, we find the assumption of a complete pass-through reasonable.

Table 1. **Elasticities of row variables with respect to column variables**

	Exchange rate		Foreign imports		Domestic demand	
	immediate elasticity	long-run elasticity	immediate elasticity	long-run elasticity	immediate elasticity	long-run elasticity
GDP	0.024	0.16	0.028	0.18	0.13	0.78
Industrial product	0.057	0.45	0.065	0.52	0.30	0.39
Exports (to west)	0.096	0.88	0.11	1.0	0	0
Imports	0.015	-0.07	0.054	0.52	0.28	0.39

According to Table 1, the long-run exchange rate elasticity of export volume is 0.88, which is quite well in line with previous estimates. The dependence of imports on exports shows up well in the exchange-rate elasticity of imports. The long-run price elasticity of imports in its own equation is estimated to be -0.46. However, when one accounts for the indirect effect of exchange-rate changes, relayed through domestic activity, the reduced-form long-run exchange-rate elasticity of imports shrinks virtually to zero.

<sup>2</sup> The unrestricted activity elasticities fell in the range 0.989 for goods imports to 1.023 to exports of goods. The restriction to unity was overwhelmingly approved by the data: the likelihood ratio test yields the value 0.96, which is to be compared to the 5 percent critical value 9.49 (Chi-square distribution with four degrees of freedom).

### 2.2.2 Services balance

There is a serious data problem in estimating the trade flows in services. For most elements of the services balance, no reliable decomposition of the value of trade into quantity and price exists. In some cases, a reasonable measure of prices can be constructed on an *a priori* basis. For example, the CPI is probably a decent estimate for the price of tourism and travel services exports, which in the balance of payments statistics includes the expenditures of foreigners in Finland. In cases where a reasonable estimate is available, it has been used. For transportation services, no obvious candidate was available and hence values were used in estimating the model.

Econometric models were constructed for tourism and travel services and transportation services. The resulting equations are presented in the Appendix. Trade in mixed services was judged to be too heterogenous as a class of transactions for econometric analysis, so a path for it was produced by heuristic methods. Hence, the balance of mixed services was predicted to first improve by FIM 1.5 billion annually and then to stay at that level. The reason for the predicted improvement is that the losses of Finnish insurance companies from international reinsurance (FIM 1.5–2.0 billion annually) are expected to level out – due either to better business performance or exit from the market.

### 2.2.3 Current transfers and other items

The transfers balance is determined mostly by politics, not by market forces. Hence, no formal forecast model is constructed. Starting from the beginning of 1995, transfer payments related to Finnish membership in the European Union brings a new ingredient to the transfers balance. Finland is assumed to be a net receiver in the first year of membership and a net payer from year 1997 onwards. Foreign aid expenses have decreased sharply during the recession and no rapid recovery is foreseen. Together, these items bring the transfers balance to a deficit of FIM 2.5 billion in the first year. The deficit is expected to grow as net payments to the EU increase.

A group of unclassified items in the current account is merged into the transfers balance. The deficit on these items is expected to stay constant at FIM 1.3 billion, bringing the total (broad concept) transfers deficit to FIM 3.8 billion in 1995.

### 2.2.4 Property and entrepreneurial income

The net balance on this item consists of net interest payments on the external debt. Its future is predicted by multiplying the outstanding net external debt by the average interest rate (assumed to be 8.1 percent per annum). Each period's net external debt is calculated by adding the current account to the previous period's debt and correcting for changes in the exchange rate.

## 3 Simulation exercises for external balance

### 3.1 Four scenarios

In this section, the properties of the external balance module are illustrated by simulations. Prices and wages are taken as exogenous, so the dynamics of internal balance do not enter these simulations. The growth of domestic demand is fixed as well. The simulations are primarily intended to illustrate the sensitivity of the current account balance and the trade balance to changes in prices and exchange rates. The secondary outcome is a forecast of the level of the current account, conditional on the exogenous variables. In the baseline scenario, the general trends for the exogenous variables are based partly on the Bank of Finland forecast, partly on the forecasts of several other major institutions. In the alternative scenarios, the paths of the key exogenous variables are varied.

- A. *Baseline scenario.* In the reference scenario, the total import demand of Finland's trade partners is assumed to grow at a fairly brisk annual rate of 5.5 percent. Both export and import prices are assumed to rise at a 2.2 percent annual rate until the end of 1996, after which the Finnish terms of trade are assumed to weaken as import prices start to increase at 2.7 percent and the rate of increase in export prices drops to 1.1 percent. Finnish domestic demand grows at a rate of 3.9 percent. Domestic and foreign unit costs in national currencies are assumed to increase at the same rate, so that changes in competitiveness stem only from changes in the nominal exchange rate.
- B. *Domestic overheating scenario.* Domestic demand is assumed to rise at the rate of 5 percent a year (instead of 3.9 percent). Increased demand boosts the growth rate of domestic wages and consequently of unit costs to one percentage point above the foreign rate.
- C. *Strong export market scenario.* Import demand in the Finnish export market grows at a rate of 6 percent. Finland's terms of trade improve two percent by the end of 1996 and thereafter remain unchanged.
- D. *Weak export market scenario.* Import demand in the Finnish export market grows at 5 percent. Finland's terms of trade decline by two percent by the end of 1996 and by two percent each year after that.

### 3.2 Simulations for the external balance

Figure 4 illustrates the behavior of the current account for these scenarios when the nominal exchange rate is kept at its 1995 second quarter level. Figure 5 plots, for the corresponding scenarios, the exchange rate path that brings the current account



surplus to FIM 12 billion annually by the end of 1996 and then keeps it constant from that on.<sup>3</sup>

*Baseline scenario A.* With an unchanged exchange rate, the current account surplus peaks in the beginning of 1996, and starts to decline thereafter, due to weakening terms of trade. In the beginning of 1998, the current account bottoms out at a surplus of about FIM 12 billion and increases slowly from then on. At the end of the 1999 the annual surplus reaches FIM 13.2 billion, or about 2 percent of GDP. To keep the current account constant, the nominal exchange rate needs to vary within a band of approximately  $\pm 1$  percent around the initial rate. By the end of 1999, the equilibrium exchange rate is about one percent stronger than in 1995Q2.

*Overheating scenario B.* Rapidly growing domestic demand and a weakening of competitiveness due to relatively high wage increases pushes the current account into deficit in 1998. By the end of 1999, the current account deficit reaches about FIM 9.1 billion. To keep the current account positive at the desired level, a steady depreciation of the currency is necessary. The total depreciation from the initial situation reaches more than seven percent by the end of 1999.

*Strong export market scenario C.* Both the quantities and prices of exports rise rapidly and, after a slight initial dip, the current account surplus increases rapidly, reaching FIM 31 billion by the end of the decade. An appreciation of the markka of more than eight percent by the end of the decade is required to keep the current account at FIM 12 billion.

*Weak export market scenario D.* Slower growth of foreign demand together with a more rapid weakening of the terms of trade reduces the current account surplus. In 1999 the surplus declines to FIM 2.4 billion. To balance the effect of weaker exports on the current account balance, a total depreciation of the markka by more than three percent from its initial level is necessary.

To sum up, it appears that the present (1995Q2) exchange rate is a good approximation of the equilibrium rate, as far as external balance is concerned. Changes in the terms of trade or domestic demand conditions may, however, necessitate sizable changes in the equilibrium rate. Since in the present simulations, domestic demand is not allowed to react to changes in terms of trade, i.e. decline when the terms of trade worsen and vice versa, the results most likely overstate the need for exchange rate adjustment. Section 5, in which domestic demand is a policy variable, offers a contrasting picture.

---

<sup>3</sup> The path is calculated by an algorithm that chooses the nominal exchange rate from the third quarter of 1995 on to minimize the sum of squared deviations of the annual current account balance from FIM 12 billion from the end of 1996 onwards. Generally, there is more than one possible path that keeps the current account virtually constant. Therefore, in the algorithm, some weight was given to obtaining as smooth a path as possible for the exchange rate. Loosely speaking, the algorithm chooses the smoothest path for the exchange rate that keeps the current account surplus close to FIM 12 billion.

Figure 4.

**Current account balance**  
with exchange rate constant at 1995Q2 level

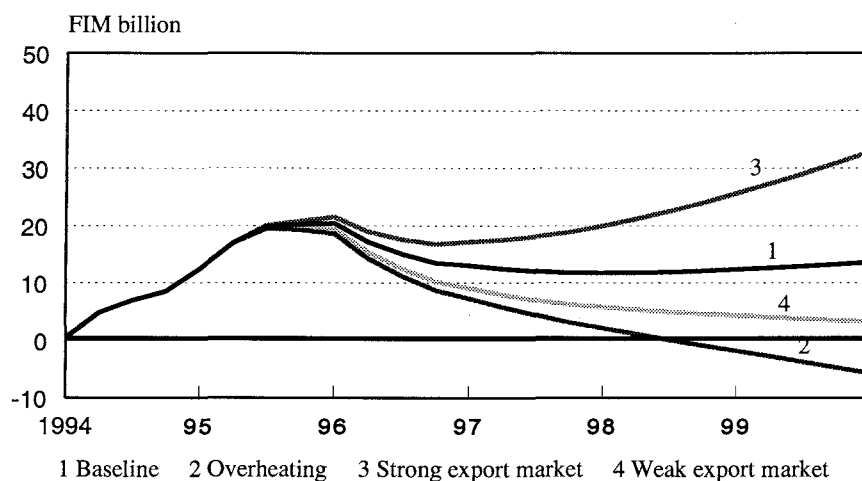
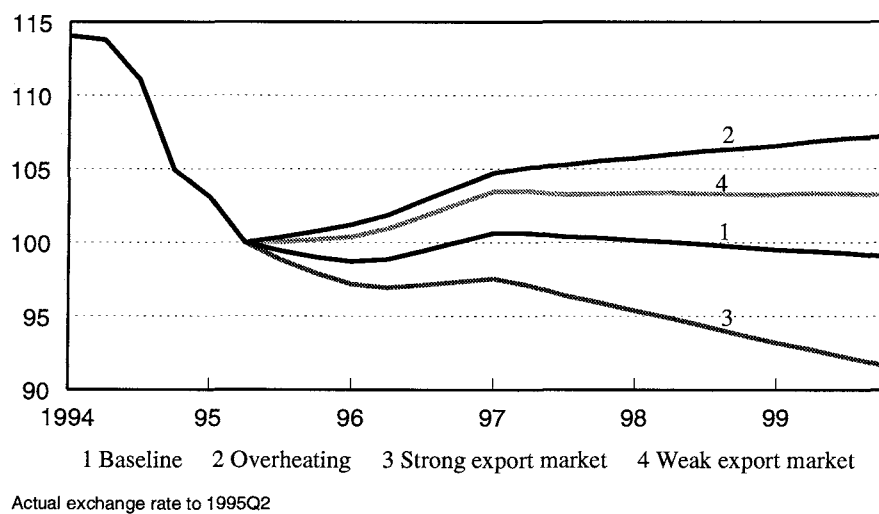

Figure 5.

**Equilibrium nominal exchange rate**  
trade weighted, 1995Q2 = 100



## 4 Internal balance

Modeling the present role of the real exchange rate in the Finnish inflation process is a formidable task. It is almost certain that several regime changes and the new economic situation prevailing in Finland have crucially affected the mechanisms underlying the internal balance scheme depicted in figure 1. Wage formation and the inflation process are very likely to depend on regime shifts such as the liberalization of the financial markets and the abandoning of the fixed exchange rate. On the other hand, it is uncertain to what extent the unparalleled level of unemployment is going to stem wage pressures. Econometric methods do not seem to be able to yield a statistically satisfactory and plausible model linking the real exchange rate to wage formation. Hence, wages are treated as exogenous in the model.

In its present form, the internal balance part of the model consists of a single equation with the rate of underlying inflation (consumer inflation without taxes, subsidies, and housing expenses) as the endogenous variable. Inflation is explained by unit labor costs and consumer goods import prices, with aggregate demand conditions causing short-term price variations. The index of underlying inflation is modeled as being cointegrated with, and homogenous of degree one in, unit labor costs and import prices, with coefficients of 0.64 and 0.36 respectively. The deviation from the cointegration equilibrium enters the short-run equation together with the lagged growth rate of GDP.

Unit costs were calculated by deducting an assumed 2.5 percent annual improvement in domestic productivity from the wage increases. The price of imported goods in the consumer price index basket was assumed to increase by 2 percent a year in foreign currency terms. Foreign unit costs in manufacturing were assumed to increase by 1.5 percent per annum. Hence, with the assumed productivity improvement and a constant exchange rate, annual wage increases of 4 percent keep the competitiveness of the Finnish manufacturing sector unchanged.

As wages – and hence unit labor costs – are exogenous, the exchange rate affects inflation only through import prices and export demand. This is clearly not a complete picture of the effects of exchange rate and future research is needed to incorporate the role of the exchange rate and competitiveness in wage formation.

## 5 Simulation exercises with the complete model

### 5.1 The simulation model

For the purpose of simulating with the complete model, the loss function needs to be reformulated. The heuristic picture behind the chosen formulation is the following. In the model, the policymakers have a strong commitment to low and stable inflation and full control over domestic demand through monetary and fiscal policies. In line with the announced target of the Bank of Finland and the Finnish government, the inflation target is chosen to be 2 percent per annum. The nominal exchange rate is assumed to be determined in the market to stabilize the current account to a sustainable level. Considering the still heavy external indebtedness of the Finnish economy, balancing the current account was not seen to be a sufficient target. Instead,

to bring the level of the debt down to a normal level, a sustained current account surplus was seen as necessary. Hence, the exchange rate was assumed to adjust to provide a stable current account surplus of FIM 12 billion annually.

By controlling domestic demand, the policymakers directly influence the inflation pressures caused by high demand. They also affect inflation by two additional routes: first, increasing domestic demand weakens the current account, to which the market reacts by depreciating the markka. Depreciation increases import prices and thereby consumer prices. On the other hand, depreciation increases export demand for Finnish goods and thus adds to the demand pressures on inflation. Knowing the full workings of the model, the policymakers' problem is to choose the paths for domestic demand and the exchange rate so as to satisfy simultaneously the inflation target and the current account target – the latter set by the market. If there is still room for policy choices after closely satisfying these targets, then as a secondary target, the policymakers maximize the growth rate of GDP.

These mechanisms are incorporated in the loss function as follows: the minimizing algorithm chooses the paths for domestic demand and the nominal exchange rate by giving the greatest weight to deviations from target of the rate of inflation and the current account balance. To incorporate the policymakers' secondary preference for high growth, the growth rate of GDP also has a small negative weight in the loss function. Finally, to exclude oscillating solutions, measures of volatility of the control variables were included in the loss function. To allow for the lags in the effects of economic policies, inflation and the current account enter the loss function from 1996Q4 onwards. For the exact form of the objective function, see the appendix.

## 5.2 Simulation results

Simulations were run for four scenarios. Scenarios A, C, and D are the same as described in section 4. However, since in this section domestic demand is a control variable, the exogenous variables in the domestic overheating scenario B differ from the baseline scenario only in that wage increases are higher by one percentage point. Therefore, in this section scenario B is renamed the *high wage increases* scenario. The simulation results are illustrated in Figures 6 and 7 and Table 2.

Baseline scenario A. The equilibrium nominal exchange rate depreciates by approximately 1.5 percent from its initial (1995Q2) level by mid-1996, and remains relatively stable thereafter. The real exchange rate remains almost unchanged at its initial level. To damp the effect of the relatively high wage increases in the first half of 1995, the growth rate of domestic demand has to fall below 3.5 percent in 1996. From then on the more modest wage development creates room for considerably faster growth. The average growth rate of domestic demand reaches 4.7 percent over the period 1994–1999, bringing the average growth rate of real GDP to 4.5 percent.

Figure 6.

**Equilibrium growth of real GDP**  
Change from the year-earlier quarter

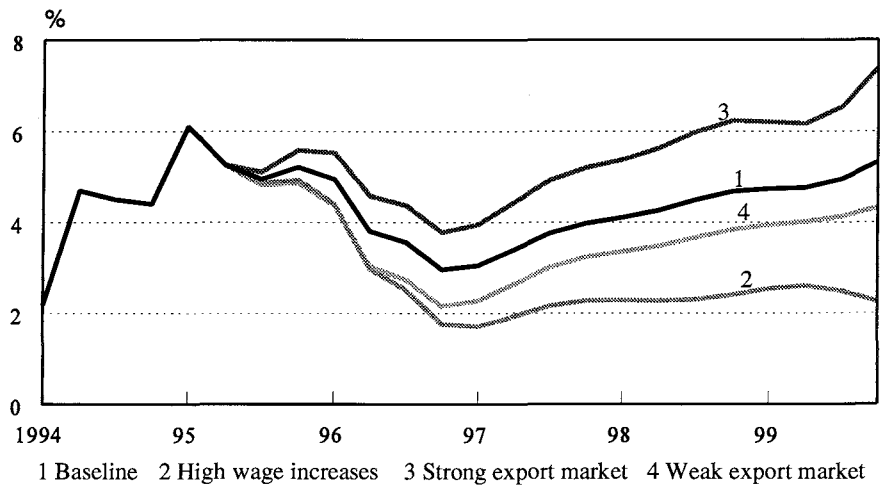
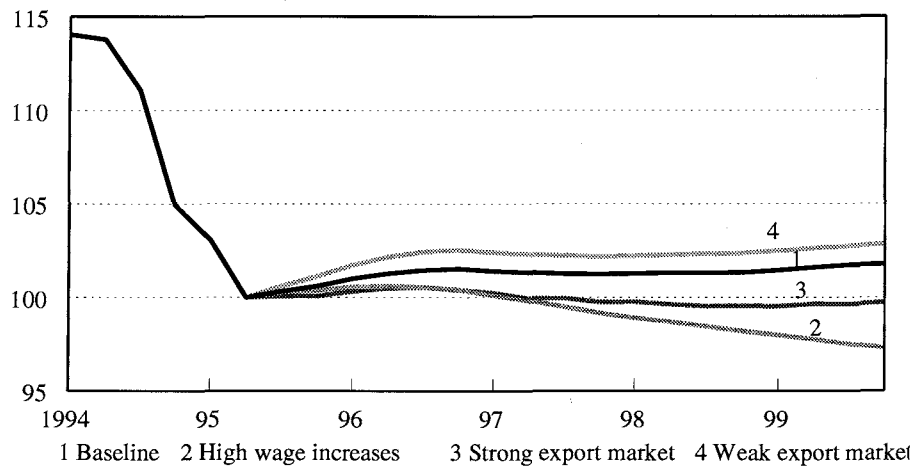

Figure 7.

**Equilibrium nominal exchange rate**  
Trade weighted, 1995Q2 = 100



Actual exchange rate to 1995Q2

*High wage increases scenario B.* The rate of wage increases is clearly out of line with the inflation target and developments in foreign trade, and hence the welfare cost of achieving the inflation target is considerable. To balance the inflationary effect of increasing domestic unit costs, policymakers need to reduce the average growth rate of domestic demand to 2.7 percent. This induces an appreciation of the markka – and a decrease in import prices – by 3 percent. Rising unit costs together with the appreciation strengthens the real exchange rate by almost 10 percent by the end of the

decade, which reduces export volume by almost six percent from the level of the baseline scenario. As a result, the average growth for GDP drops to 2.8 percent.

*Strong export market scenario C.* High export revenues allow for a nominal exchange rate approximately 2 percent stronger than in the baseline scenario. This dampens the rate of inflation and allows for faster growth of domestic demand. Over the rest of the decade, the growth of domestic demand averages 6.5 percent. Together with export growth of 3.9 percent, this brings the average growth rate of GDP to 5.8 percent.

*Weak export market scenario D.* Low export demand induces a depreciation of the markka by approximately 2.5 percent. To counterbalance the inflationary effect, the average growth of domestic demand – as well as the growth rate of real GDP – is brought down to 3.5 percent from its baseline level of 4.6 percent.

Table 2. **Average growth rates for key variables from 1995Q2 to 1999Q4**

	Baseline	High wages	Strong export market	Weak export market
GDP	0.044	0.024	0.058	0.035
Domestic demand	0.046	0.023	0.065	0.035
Exports, vol.	0.038	0.025	0.039	0.036
Imports, vol.	0.054	0.034	0.072	0.043
Industrial production	0.039	0.022	0.047	0.033

### 5.3 Discussion and interpretations

The overall profile of the growth path carries some apparent similarities across the scenarios. One is that the equilibrium growth rate exhibits a marked dip, bottoming at the end of 1996. Even in the most positive scenario (scenario C), the annual growth rate is below four percent at that time. In the baseline scenario, the equilibrium rate is three percent. The reason for this is the high wage increases for 1995, which push up the prices of domestic goods in 1996. During the pass-through of the wage increases, attaining the inflation target requires that domestic demand be kept down.

It may appear peculiar that, except for the high wages scenario, the growth rate of exports varies very little from one scenario to the next. In particular, the growth rate of exports is virtually the same in the baseline scenario as in the strong export market scenario (3.8 percent versus 3.9 percent annually). This result is explained by the role imposed by the model on the currency market. Remember that the market adjusts the exchange rate to bring the yearly current account surplus to FIM 12 billion. In the strong export market scenario, high foreign demand and rising export prices tend to push the current account surplus well above this level. Part of the excess surplus is eliminated by higher imports as the equilibrium level of domestic demand rises. The rest of it must be absorbed by reducing the increase in the quantity of exports. This is taken care of by the currency market which appreciates the markka until the desired current account is restored. Similarly, in the weak export market scenario the effect of the deterioration in the terms of trade on the current account is partially

offset by depreciation of the currency and therefore the decline in the growth rate of exports – compared to the baseline scenario – is smaller than the fall in foreign import demand.

Perhaps the most characteristic overall feature of the above calculations is that the path for the equilibrium exchange rate varies relatively little over the scenarios. Even reasonably large changes in foreign trade conditions induce only modest changes in the exchange rate. The maximum difference between the equilibrium rates in the positive and negative exports scenarios is about three percentage points. Only the high wage increases scenario produces a more tangible appreciation in the equilibrium rate. This result underlines the fact that once the path for domestic unit costs is fixed, then the strict inflation target leaves very little room for exchange rate adjustments. Instead, adjustment takes place through domestic activity.

The role of a strict inflation target shows up also in what is perhaps the most counterintuitive result of the simulations, namely, that high wage increases necessitate an appreciation of the currency, which further hurts the country's competitiveness. The explanation is, naturally, that to combine the high unit costs with the inflation target, both modest increases in import prices and low aggregate demand are required. Appreciation of the currency serves both purposes. In terms of Figure 1, higher wage increases involve a shift of the internal balance locus N to the left: at any given level of activity, inflation will be higher. At the new intersection point, the real exchange rate is stronger and domestic activity lower.

To illustrate the role played by the stringency of the inflation target, another simulation for the high wage increases scenario was run, this time with the weight of the inflation target deviation reduced (by a factor of four) and the weight of the growth target increased (by a factor of ten). The result was that instead of appreciating, the equilibrium nominal exchange rate depreciated by 2–3 percent from its initial level and the average growth rate of GDP increased from 2.8 percent to 3.3 percent. With the looser inflation target, the average rate of inflation for 1995–1999 climbs to 2.5 percent.

These simulations serve to illustrate the high cost of attaining low inflation if wage increases are not consistent with the target level: to balance a mere one percentage point increase in the rate of wage increases, the average real rate of growth has to be slashed by 1.7 percentage points. The model no doubt exaggerates the harshness of the measures necessary to fight inflation. Wages are not exogenous – at least not over a four-year horizon – and a 1.7 percentage point reduction in the growth rate certainly affects wage increases. Similarly, if wage formation reacts to aggregate demand, then the effects of foreign trade conditions should show up more in the exchange rate and less in the domestic demand.

The main wisdom is that without the means to either directly or indirectly affect wage formation, the policymakers' ability to control inflation is seriously hampered. Particularly, if the credibility of the inflation target is low and wage increases reflect high inflation expectations, then building up the reputation *ex post* will involve a very high sacrifice in terms of growth. Furthermore, the existence of a high sacrifice ratio – the welfare cost of reducing inflation – tends to undermine the credibility of the inflation target and to keep inflation expectations high. Since direct control of wage formation is, in most cases, not an option, in order to gain a better control over inflation, the goal of policymakers should be to increase the flexibility of the labor market and thereby increase the responsiveness of wage formation to overall economic conditions.

## 6 Conclusions

This paper has examined the future path of the equilibrium exchange rate for the Finnish markka. The results indicate that with the projected development of foreign trade and domestic costs, there should be little pressure on the external value of the markka. The present exchange rate seems to deliver both satisfactory export development and low inflation. With the baseline projection, internal and external balance would allow an average growth rate of approximately 4.5 percent to the end of the decade. The equilibrium nominal exchange rate was calculated to remain stable at a value less than two percent weaker than its initial value for the rest of the decade. This is quite well in line with current projections.

With a strict inflation target and inflexible wages, changes in foreign trade conditions (terms of trade and foreign demand) have relatively little effect on the equilibrium exchange rate, but a more tangible effect on the equilibrium rate of growth. A moderate improvement in foreign trade conditions induced only a two percent appreciation of the equilibrium exchange rate from its baseline value, whereas the corresponding effect on the level of GDP was estimated to reach six percent by 1999.

The simulations underline the pivotal role played by wage formation in determining inflation. If the rate of wage increases is not in line with the inflation target, then delivering the target inflation will involve a very high welfare cost. With completely inflexible wages, a mere one percentage point increase in the growth rate of real wages reduces the average equilibrium growth rate for 1995–1999 by almost two percentage points. The more sensitive wage formation is to changes in growth, the smaller is this welfare cost.



## References

- Barrell, R. and in't Veldt, J.W. (1991) **FEERs and the Path to EMU**, National Institute Economic Review, August 1991.
- Barrell, R. and Wren-Lewis, S. (1989) **Fundamental Equilibrium Exchange Rates for the G7**, CEPR Discussion Paper No. 323.
- Bayoumi, T., Clark, P., Symansky, S. and Taylor, M. (1993) **Robustness of Equilibrium Exchange rate Calculations to Alternative Assumptions and Methodologies**, Manuscript, IMF 1993.
- Church, K. (1992) **Properties of the Fundamental Equilibrium Exchange Rate in Models of the UK Economy**, National Institute Economic Review, No. 141.
- Clark, P., Bartolini, L., Bayoumi, T. and Symansky, S. (1994) **Exchange Rates and Economic Fundamentals**, IMF Occasional Papers 115.
- Frenkel, J.A. and Goldstein, M. (1986) **A Guide to Target Zones**, IMF Staff Papers, Vol. 33.
- Høj, L. (1995) **Fundamental Equilibrium Exchange rate – A Case Study of the Finnish Markka**, Bank of Finland Discussion Papers 2/95.
- MacDonald, R. (1995) **Long Run Exchange Rate Modeling: A Survey of the Recent Evidence**, IMF Working Paper 14/95.
- Swan, T.W., (1963) **Longer Run Problems of the Balance of Payments**, in *Readings in International Economics*, ed. By R.E. Caves and H.G. Johnson, 1968.
- Williamson, J. (1985) **The Exchange Rate System**, Institute for International Economics, 2nd ed., 1985.
- Williamson, J. (1991) **FEERs and the ERM**, National Institute Economic Review, August 1991.

## Appendix

### Econometric model for external balance

*Trade volumes:* The model was estimated as a system of four equations using the Maximum Likelihood method over the period 1971Q1–1994Q4. All long-run activity elasticities are constrained to unity. Hence, in each equation, the number of estimated parameters is one less than the number of independent variables. All variables are in logarithms.

$$\text{LXGW} = 0.303*\text{LXGW}_{-1} + 0.336*\text{LXGW}_{-2} + 0.360*\text{LMFOR} + 0.317*\text{LRERULC} + 0.364$$

(3.98)                      (4.80)                      ( - )                      (5.72)

$$\sigma = 0.0638$$

$$\text{LMG} = 0.218*\text{LMG}_{-1} + 0.278*\text{LMG}_{-2} + 0.217*\text{LMG}_{-3} - 0.149*(\text{LPMG} - \text{LWPID}) + 0.681*\text{LIP}$$

( - )                      (3.36)                      (2.50)                      (2.11)                      (4.40)

$$- 0.394*\text{LIP}_{-3} + 0.560*\Delta^4 \text{LDDEM} - 0.201*\text{D86Q2} + 1.572$$

(2.26)                      (4.26)                      (3.95)

$$\sigma = 0.0479$$

$$\text{LIP} = 0.627*\text{LIP}_{-1} + 0.227*\text{LGX} + 0.478*\text{LDDEM} - 0.331*\text{LDDEM}_{-1} - 0.075*\text{D71Q1}$$

( - )                      (8.98)                      (5.57)                      (3.94)                      (5.44)

$$+ 0.052*\text{D71Q2} - 2.28$$

(3.21)

$$\sigma = 0.0157$$

$$\text{LGDP} = 0.208*\text{LGDP}_{-1} + 0.171*\text{LXG} + 0.622*\text{DDEM} + 0.085$$

( - )                      (14.1)                      (17.0)

$$\sigma = 0.0116$$

*Services:* Each equation was estimated as a single equation by OLS over varying periods of time. Seasonal dummies are averaged in the constant term and not reported.

$$\text{LRTOXV} = 0.480*\text{LRTOXV}_{-1} + 0.675*\text{LRTOXV}_{-4} - 0.452*\text{LRTOXV}_{-5} + 0.139*\text{LMFOR}$$

(5.67)                      (10.1)                      (6.02)                      (3.02)

$$+ 1.56*\text{LRERCPI}_{-1} - 1.22*\text{LRERCPI}_{-2} - 1.46$$

(4.77)                      (3.61)

Estimation period: 70Q–94Q4,  $\sigma = 0.067$

$$\begin{aligned}
\text{LTOMV} = & 0.376*\text{LTOMV}_{-1} + 0.671*\text{LTOMV}_{-4} - 0.311*\text{LTOMV}_{-5} + 0.317*\text{LDDEM} \\
& (3.57) \qquad (7.84) \qquad (2.99) \qquad (4.00) \\
& - 0.349*\text{RERCPI}_{-1} - 0.047 \\
& (3.27)
\end{aligned}$$

Estimation period: 75Q1-94Q4,  $\sigma = 0.052$

$$\begin{aligned}
\text{LRTRXV} = & 0.597*\text{LRTRXV}_{-1} + 0.202*\text{LRTRXV}_{-4} - 0.235*\text{LRTRXV}_{-5} + 0.274*\text{LXG} \\
& (3.51) \qquad (2.25) \qquad (2.87) \qquad (5.27) \\
& + 0.185*\text{LRERULC} - 0.253*\text{D80Q2} + 0.116*\text{D80Q3} - 2.30 \\
& (3.13) \qquad (4.27) \qquad (1.89)
\end{aligned}$$

Estimation period: 70Q2-94Q4,  $\sigma = 0.056$

$$\begin{aligned}
\text{LTRMV} = & 0.539*\text{LTRMV}_{-1} + 0.483*\text{LTRMV}_{-4} - 0.279*\text{LTRMV}_{-5} + 0.277*\text{LRERULC} \\
& (3.49) \qquad (5.81) \qquad (3.13) \qquad (2.85) \\
& + 0.260*\text{LXV} - 0.244*(\text{LPMG} - \text{LWPID}) - 2.16 \\
& (3.55) \qquad (1.90)
\end{aligned}$$

Estimation period: 70Q2-94Q4,  $\sigma = 0.093$

*Inflation:* Estimated with OLS over the period 1980Q1-1994Q4.

$$\begin{aligned}
\Delta \text{LIUI} = & 0.568*\Delta \text{LIUI}_{-4} + 0.0984*\Delta^4 \text{LGDP}_{-1} - 0.225*\text{VLIUI}_{-1} + 0.00295 \\
& (6.75) \qquad (4.27) \qquad (4.74)
\end{aligned}$$

where  $\text{VLIUI} = 0.644*\text{LULC} + 0.356*\text{LPMCONS} + 2.06$

### Variables:

First letter L indicates log of the variable

LDDEM	domestic demand
LDDEM <sub>V</sub>	domestic demand, value
LGDP	GDP, 1990 prices
LIP	index of industrial production
LIUI	index of underlying inflation
LMFOR	index of imports of Finlands export countries
LMG	goods imports
LPMCONS	index of consumer goods import prices
LPMG	import prices
LRERCPI	real exchange rate, consumer prices, import weighted
LRERULC	real exchange rate, unit labor costs, export weighted
LRTOXV	exports of tourism and travel services, value, divided by the CPI
LRTRXV	exports of transportation services, value, divided by the CPI
LTOMV	imports of tourism services, value
LTRMV	imports of transportation services, value
LULC	unit labor costs in manufacturing
LWPID	wholesale price index of domestic goods

## Loss functions

*Simulations with the external balance module:*

Choose the path of exchange rate to minimize:

$$\sum_{t=1995Q3}^{2000Q4} (\Delta E(t))^2 + \sum_{t=1996Q4}^{2000Q4} (CA_{12}(t) - 12000)^2$$

where  $E$  is the nominal exchange rate and  $CA_{12}$  is the four-quarter current account balance.

*Simulations with the complete model:*

Choose the paths of exchange rate and domestic demand to minimize:

$$\begin{aligned} & \sum_{t=1995Q3}^{2000Q4} 10 * (\Delta E(t))^2 + \sum_{t=1996Q4}^{2000Q4} \left( \frac{CA_{12}(t) - 12000}{16000} \right)^2 \\ & + \sum_{t=1996Q4}^{2000Q4} 400 * (LIUI(t) - LIUI(t-4) - \ln 1.02) + \sum_{t=1995Q3}^{2000Q4} 10 * \Delta^2 LDDEM(t) \\ & - \left( \frac{LGDP(2000Q4) - LGDP(1995Q3)}{6} \right) \end{aligned}$$

where  $E$  and  $CA_{12}$  are as above,  $LIUI$  is the log of the underlying rate of inflation,  $LDDEM$  is the log of domestic demand and  $LGDP$  is the log of domestic GDP.

## BANK OF FINLAND DISCUSSION PAPERS

ISSN 0785-3572

- 1/95 Olavi Rantala **Valuuttakurssimuutosten vaikutus yritysten kannattavuuteen** (Effects of Exchange Rate Changes on Corporate Profitability). 1995. 51 p. ISBN 951-686-439-2. (KT)
- 2/95 Liselotte Høj **Fundamental Equilibrium Exchange Rate — A Case Study of the Finnish Markka**. 1995. 30 p. ISBN 951-686-440-6. (TU)
- 3/95 Jean-Marie Viaene — Itzhak Zilcha **Multiple Uncertainty, Forward-Futures Markets and International Trade**. 1995. 23 p. ISBN 951-686-441-4. (TU)
- 4/95 Jorma Hilpinen **Analysis on the Errors and Omissions in the Finnish Balance of Payments: Restless Capital Movements, Floating Exchange Rate and Errors Since 1991**. 1995. 31 p. ISBN 951-686-442-2. (TP)
- 5/95 Juhana Hukkinen — Matti Virén **Assessing the Performance of a Macroeconomic Model**. 1995. 48 p. ISBN 951-686-443-0. (TU)
- 6/95 Tuomas Saarenheimo **Credit Crunch Caused Investment Slump? An Empirical Analysis Using Finnish Data**. 1995. 26 p. ISBN 951-686-444-9. (KT)
- 7/95 Sinimaaria Ranki **On the Role of the Single Currency ECU**. 1995. 37 p. ISBN 951-686-445-7. (TU)
- 8/95 Juhana Hukkinen — Erkki Koskela **Voidaanko Suomen pitkien korkojen tasoa selittää talouden perustekijöillä, vai onko kyse jostain muusta?** (Can the Level of Long-Term Interest Rates in Finland Be Explained by Economic Fundamentals, or Must an Explanation be Sought Somewhere Else? 1995. 27 p. ISBN 951-686-446-5. (KT)
- 9/95 Kari Takala — Matti Virén **Testing Nonlinear Dynamics, Long Memory and Chaotic Behaviour with Macroeconomic Data**. 1995. 55 p. ISBN 951-686-448-1. (TU)
- 10/95 Lauri Kajanoja **Aggregate Investment and Corporate Indebtedness: Some Empirical Evidence from Finland**. 1995. 28 p. ISBN 951-686-449-X. (KT)
- 11/95 Kari Takala **The Interest Rate Sensitivity of Output in Finland**. 1995. 49 p. ISBN 951-686-450-3. (KT)
- 12/95 Timo Tyrväinen **Wage Determination in the Long Run, Real Wage Resistance and Unemployment: Multivariate Analysis of Cointegrating Relations in 10 OECD Economies**. 1995. 94 p. ISBN 951-686-451-1. (KT)
- 13/95 Eddie George **Inflation Targeting in the UK Monetary Policy Framework**. 1995. 12 p. ISBN 951-686-452-X. (TIE)
- 14/95 Risto Murto **The Banking Crisis, Banking Policy Regimes and the Value of a Bank**. 1995. 27 p. ISBN 951-686-453-8. (TU)
- 15/95 Kari Takala **Permanent Income Hypothesis and Saving in Finland**. 1995. 53 p. ISBN 951-686-454-6. (KT)
- 16/95 Heikki Koskenkylä — Jaana Rantama **Pankkien korkomarginaalit ja korkokatteet Pohjoismaissa** (Banks' Interest Rate Margins and Net Interest Income in the Nordic Countries). 1995. 27 p. ISBN 951-686-455-4. (RM)

- 17/95      Mika Kuismanen **Exchange Rates and Import Prices in Finland: Estimation of Exchange Rate Pass-Through**. 1995. 33 p. ISBN 951-686-458-9. (KT)
- 18/95      Johnny Åkerholm – Timo Hämäläinen – Mika Kuismanen **Employment and the Structure of the Finnish Economy. A Model for Evaluating Scenarios**. 1995. 56 p. ISBN 951-686-460-0. (KT)
- 19/95      Kaare G. Andersen **Inflation Targeting: Analyzing Indicators of Inflation in Finland**. 1995. 32 p. ISBN 951-686-461-9. (KT)
- 20/95      Kari Takala **The Consumption Function Revisited: An Error-Correction Model for Finnish Consumption**. 1995. 44 p. ISBN 951-686-462-7. (KT)
- 21/95      Jouni Timonen **Nominal Income as an Intermediate Target for Monetary Policy**. 1995. 56 p. ISBN 951-686-463-5. (RP)
- 22/95      Maaria Kettunen **Korkojen aikarakenne, inflaatio-odotukset ja inflaatio** (Term Structure of Interest Rates, Inflation Expectations and Inflation). 1995. 81 p. ISBN 951-686-464-3. (RP)
- 23/95      Dan Kovenock – Casper G. de Vries **Fiat Exchange in Finite Economies**. 1995. 27 p. ISBN 951-686-465-1. (TU)
- 24/95      Antti Ripatti **Leading Inflation Indicators in Finland: Pairwise Analysis of Granger-Causality and Cointegration**. 1995. 45 p. ISBN 951-686-466-X. (RP)
- 25/95      Jorma Hilpinen **Compilation of Early Warning Indicators for Foreign Trade Employing a Cut-Off Survey**. 1995. 17 p. ISBN 951-686-467-8. (TP)
- 26/95      Vappu Ikonen **Suomen Pankin kotimainen luotonanto 1868–1992** (The Bank of Finland's Domestic Lending, 1868–1992). 1995. 131 p. ISBN 951-686-468-6. (TU)
- 27/95      Kaare Guttorm Andersen – Hanna-Leena Männistö **Output Gaps and the Government Budget Balance: The Case of Finland**. 1995. 27 p. ISBN 951-686-470-8. (KT)
- 28/95      Kari Takala – Matti Virén **Bankruptcies, Indebtedness and the Credit Crunch**. 1995. 28 p. ISBN 951-686-471-6. (TU)
- 29/95      Tuomas Saarenheimo **The Equilibrium Exchange Rate for the Finnish Markka**. 1995. 27 p. ISBN 951-686-472-4. (KT)