

Zarzecki, Dariusz (Ed.); Jabłoński, Marek (Ed.)

**Book — Published Version**

## Sustainable value management - New concepts and contemporary trends

**Provided in Cooperation with:**

MDPI – Multidisciplinary Digital Publishing Institute, Basel

*Suggested Citation:* Zarzecki, Dariusz (Ed.); Jabłoński, Marek (Ed.) (2020) : Sustainable value management - New concepts and contemporary trends, ISBN 978-3-03936-554-8, MDPI, Basel, <https://doi.org/10.3390/books978-3-03936-554-8>

This Version is available at:

<https://hdl.handle.net/10419/230558>

**Standard-Nutzungsbedingungen:**

Die Dokumente auf EconStor dürfen zu eigenen wissenschaftlichen Zwecken und zum Privatgebrauch gespeichert und kopiert werden.

Sie dürfen die Dokumente nicht für öffentliche oder kommerzielle Zwecke vervielfältigen, öffentlich ausstellen, öffentlich zugänglich machen, vertreiben oder anderweitig nutzen.

Sofern die Verfasser die Dokumente unter Open-Content-Lizenzen (insbesondere CC-Lizenzen) zur Verfügung gestellt haben sollten, gelten abweichend von diesen Nutzungsbedingungen die in der dort genannten Lizenz gewährten Nutzungsrechte.

**Terms of use:**

*Documents in EconStor may be saved and copied for your personal and scholarly purposes.*

*You are not to copy documents for public or commercial purposes, to exhibit the documents publicly, to make them publicly available on the internet, or to distribute or otherwise use the documents in public.*

*If the documents have been made available under an Open Content Licence (especially Creative Commons Licences), you may exercise further usage rights as specified in the indicated licence.*



<https://creativecommons.org/licenses/by-nc-nd/4.0/>



*sustainability*

# Sustainable Value Management— New Concepts and Contemporary Trends

---

Edited by

Dariusz Zarzecki and Marek Jabłoński

Printed Edition of the Special Issue Published in *Sustainability*

# **Sustainable Value Management–New Concepts and Contemporary Trends**



# Sustainable Value Management—New Concepts and Contemporary Trends

Special Issue Editors

**Dariusz Zarzecki**

**Marek Jabłoński**

MDPI • Basel • Beijing • Wuhan • Barcelona • Belgrade • Manchester • Tokyo • Cluj • Tianjin



*Special Issue Editors*

Dariusz Zarzecki  
University of Szczecin  
Poland

Marek Jabłoński WSB  
University in Poznań  
Poland

*Editorial Office*

MDPI  
St. Alban-Anlage 66  
4052 Basel, Switzerland

This is a reprint of articles from the Special Issue published online in the open access journal *Sustainability* (ISSN 2071-1050) (available at: <https://www.mdpi.com/journal/sustainability/special.issues/Sustainable.Value.Management>).

For citation purposes, cite each article independently as indicated on the article page online and as indicated below:

LastName, A.A.; LastName, B.B.; LastName, C.C. Article Title. <i>Journal Name</i> <b>Year</b> , Article Number, Page Range.
---

**ISBN 978-3-03936-553-1 (Hbk)**

**ISBN 978-3-03936-554-8 (PDF)**

© 2020 by the authors. Articles in this book are Open Access and distributed under the Creative Commons Attribution (CC BY) license, which allows users to download, copy and build upon published articles, as long as the author and publisher are properly credited, which ensures maximum dissemination and a wider impact of our publications.

The book as a whole is distributed by MDPI under the terms and conditions of the Creative Commons license CC BY-NC-ND.

# Contents

About the Special Issue Editors . . . . .	vii
Preface to “Sustainable Value Management–New Concepts and Contemporary Trends” . . . .	ix
<b>Małgorzata Baran and Barbara Sypniewska</b> The Impact of Management Methods on Employee Engagement Reprinted from: <i>Sustainability</i> 2020, 12, 426, doi:10.3390/su12010426 . . . . .	1
<b>Andrea Cardoni, Evgeniia Kiseleva and Paolo Taticchi</b> In Search of Sustainable Value: A Structured Literature Review Reprinted from: <i>Sustainability</i> 2020, 12, 615, doi:10.3390/su12020615 . . . . .	17
<b>Daniel Cupriak, Katarzyna Kuziak and Tomasz Popczyk</b> Risk Management Opportunities between Socially Responsible Investments and Selected Commodities Reprinted from: <i>Sustainability</i> 2020, 12, 2003, doi:10.3390/su12052003 . . . . .	35
<b>Jan Fazlagić and Elżbieta Izabela Szczepankiewicz</b> The Role of Local Governments in Supporting Creative Industries—A Conceptual Model Reprinted from: <i>Sustainability</i> 2020, 12, 438, doi:10.3390/su12010438 . . . . .	57
<b>Vanja Grozdić, Branislav Marić, Mladen Radišić, Jarmila Šebestová and Marcin Lis</b> Capital Investments and Manufacturing Firms’ Performance: Panel-Data Analysis Reprinted from: <i>Sustainability</i> 2020, 12, 1689, doi:10.3390/su12041689 . . . . .	81
<b>Romeo Victor Ionescu, Monica Laura Zlati, Valentin Marian Antohi, Silviu Stanciu, Florina Oana Virlanuta and Cristina (Băcanu) Serban</b> New Agricultural Model of Economic Sustainability for Wheat Seed Production in Romania Reprinted from: <i>Sustainability</i> 2020, 12, 4182, doi:10.3390/su12104182 . . . . .	99
<b>Adam Jabłoński and Marek Jabłoński</b> Trust as a Key Factor in Shaping the Social Business Model of Water Supply Companies Reprinted from: <i>Sustainability</i> 2019, 11, 5805, doi:10.3390/su11205805 . . . . .	121
<b>Jarosław Kaczmarek</b> The Mechanisms of Creating Value vs. Financial Security of Going Concern—Sustainable Management Reprinted from: <i>Sustainability</i> 2019, 11, 2278, doi:10.3390/su11082278 . . . . .	169
<b>Renata Karkowska</b> Business Model as a Concept of Sustainability in the Banking Sector Reprinted from: <i>Sustainability</i> 2020, 12, 111, doi:10.3390/su12010111 . . . . .	193
<b>Emilia Koper and Andrzej Kochan</b> Testing the Smooth Driving of a Train Using a Neural Network Reprinted from: <i>Sustainability</i> 2020, 12, 4622, doi:10.3390/su12114622 . . . . .	205
<b>Dorota Korenik and Maria Wegrzyn</b> Public Policy Timing in a Sustainable Approach to Shaping Public Policy Reprinted from: <i>Sustainability</i> 2020, 12, 2677, doi:10.3390/su12072677 . . . . .	219

<b>Hongjia Ma, Qing Sun, Yang Gao and Yuan Gao</b> Resource Integration, Reconfiguration, and Sustainable Competitive Advantages: The Differences between Traditional and Emerging Industries Reprinted from: <i>Sustainability</i> 2019, 11, 551, doi:10.3390/su11020551 . . . . .	237
<b>Ireneusz Miciuła, Marta Kadłubek and Paweł Stepień</b> Modern Methods of Business Valuation—Case Study and New Concepts Reprinted from: <i>Sustainability</i> 2020, 12, 2699, doi:10.3390/su12072699 . . . . .	257
<b>Arnold Pabian, Aleksander Pabian and Andrzej Brzeziński</b> Young People Collecting Natural Souvenirs: A Perspective of Sustainability and Marketing Reprinted from: <i>Sustainability</i> 2020, 12, 514, doi:10.3390/su12020514 . . . . .	279
<b>Sebastian Saniuk, Sandra Grabowska and Bożena Gajdzik</b> Social Expectations and Market Changes in the Context of Developing the Industry 4.0 Concept Reprinted from: <i>Sustainability</i> 2020, 12, 1362, doi:10.3390/su12041362 . . . . .	291
<b>Aldona Standar and Agnieszka Kozera</b> Identifying the Financial Risk Factors of Excessive Indebtedness of Rural Communes in Poland Reprinted from: <i>Sustainability</i> 2020, 12, 794, doi:10.3390/su12030794 . . . . .	313
<b>Aldona Standar and Agnieszka Kozera</b> The Role of Local Finance in Overcoming Socioeconomic Inequalities in Polish Rural Areas Reprinted from: <i>Sustainability</i> 2019, 11, 5848, doi:10.3390/su11205848 . . . . .	339
<b>Piotr Staszkiwicz</b> Search for Measure of the Value of Baltic Sustainability Development: A Meta-Review Reprinted from: <i>Sustainability</i> 2019, 11, 6640, doi:10.3390/su11236640 . . . . .	367
<b>Anna Stankiewicz-Mróz</b> Influence of Interlocking Directorates on Integration after the Acquisition of Warsaw Stock Exchange—Listed Companies Reprinted from: <i>Sustainability</i> 2019, 11, 6955, doi:10.3390/su11246955 . . . . .	379
<b>Agata Sudolska, Andrzej Lis and Monika Chodorek</b> Research Profiling for Responsible and Sustainable Innovations Reprinted from: <i>Sustainability</i> 2019, 11, 6553, doi:10.3390/su11236553 . . . . .	401
<b>Dariusz Szmel, Wiesław Zabłocki, Przemysław Ilczuk and Andrzej Kochan</b> Method for Selecting the Safety Integrity Level for the Control-Command and Signaling Functions Reprinted from: <i>Sustainability</i> 2019, 11, 7062, doi:10.3390/su11247062 . . . . .	433



## About the Special Issue Editors

**Dariusz Zarzecki** Expert in the field of business valuation. Over 30 years of experience in business and intellectual property valuation. Full professor, Department of Finance and Banking at the University of Szczecin. Author of over 300 publications, including books awarded with the award of the Minister of National Education and recommended for managers, scientists and students, brokers, investment advisors and candidates for statutory auditors. Teamleader in many research projects (e.g., “Control premium in the Polish capital market”, “Business Valuation Standards”, “Lack of Marketability Discounts in Business Valuation”). Lecturer at numerous courses and conferences, including MBA studies. Co-founder and chairman of The Association of Business Appraisers in Poland (SBWPwP).

**Marek Jabłoński** is an Associate Professor at WSB University in Poznan, Faculty in Chorzow. He is also the Vice President of the Board of “OTTIMA Plus” Ltd. of Katowice, a reputable management consulting company, and President of the “Southern Railway Cluster” Association in Katowice, which supports development in railway transport and the transfer of innovation, as well as cooperation with European railway clusters (as a member of the European Railway Cluster Initiative). He holds a postdoctoral degree in Economic Science, specializing in Management Science in the following range of topics: value-based management, performance management, and business models. He has written and co-written several monographs and over 100 scientific articles in the fields of strategic management, performance management, and business models. Marek’s academic interests focus on the issues of strategic value, sustainable business models, measurement systems of results, including companies listed on the stock exchange and the principles of creating stakeholders value, and new trends in this area.



# Preface to “Sustainable Value Management–New Concepts and Contemporary Trends”

Nowadays, sustainable value is an important determinant of the development of modern organizations. It has become an increasingly important element not only of the survival strategy but also of long-term success. The contemporary approach to value management is evolving. Previous work on the value-based management concept was focused on creating value for shareholders, the primary beneficiaries of the value created. This approach met with wide criticism, especially after the experience of the global economic crisis in the financial and banking markets, which peaked in 2008–2009, triggered by the collapse of the high-risk mortgage loan market in the United States. Concepts of a more balanced approach to management and investment appeared. The trend of a sustainability approach to management based on the assumptions of the triple bottom line, corporate social responsibility, sustainable business models and other concepts has been growing for many years. There is evidence that the concept of sustainability has become a paradigm. In this respect, there is a need to understand the new approach to the concept of value not only in the context of investment processes but also in the value exchange approach. The value literature has evolved from a focus on resource exchange and value in exchange to an emphasis on resource integration and value in use. This changing perspective triggered a fresh view of the customer value proposition, understood as a strategic tool for communicating how a company aims to propose value to customers. If an organization’s success is dependent on conducting a dialogue with all key stakeholders, then the value provided should be sustained. Value should provide reasons for the monetization of the business model and should create a social effect that will prevent factors that could hinder the capture of value from the market. Creating sustainable value is a process that takes into account the factors resulting not only from the contractual approach but also, in particular, from the relational approach. The purpose of this book is to present the results of research into the current trends and challenges related to the sustainable value management concept. This issue requires extensive research and analysis. On the basis of the above-mentioned assumptions, the key issues to answer are the following: How should enterprises, including their business models, be shaped so that they are able to generate sustainable value? How should sustainable value be defined? Which scientific concepts and practical experience should form the basis of a theory of sustainable value? How can the creation of sustainable value influence the success of enterprises? Can sustainable value be created, delivered, captured and appropriated to a similar degree? How does co-creating value affect sustainable value? How should sustainable value be interpreted in capital markets? Can creating sustainable value affect the migration of values to capital/financial markets? How can sustainable value be effectively managed? Can sustainable value also exist in the public sector? If so, how should it be defined there? How is sustainable value understood in various sectors of the economy? The work in this book answers these questions, taking into account the various approaches and contexts of the global economy. We are grateful to the authors of individual chapters for their commitment in answering this range of important questions for the development of sustainability issues.

**Dariusz Zarzecki, Marek Jabłoński**  
*Special Issue Editors*



Article

# The Impact of Management Methods on Employee Engagement

Małgorzata Baran <sup>1,\*</sup> and Barbara Sypniewska <sup>2,\*</sup>

<sup>1</sup> The Faculty of Management, Collegium Civitas, 00-901 Warsaw, Poland

<sup>2</sup> The Faculty of Finance and Management, The University of Economics and Human Sciences in Warsaw, 01-043 Warsaw, Poland

\* Correspondence: malgorzata.baran@civitas.edu.pl (M.B.); agata.sypni@op.pl (B.S.)

Received: 2 December 2019; Accepted: 2 January 2020; Published: 6 January 2020

**Abstract:** The aim of the paper is to present the findings of our own questionnaire-based quantitative study carried out in 2018. The research questionnaire was sent to companies in the databases of two universities (the database of enterprises cooperating with each university), which were selected according to the criterion of the number of employees (micro, small, medium, and large companies). The study attempted to identify the correlations among the following variables: people-oriented management, non-people-oriented management, direct active and passive participation, and engagement in work. Two research questions drove the research process: (RQ1) What are the links between people-oriented management and non-people-oriented management, direct (active and passive) participation, and work engagement? (RQ2) Does direct participation (active and passive) mediate the relationship between people and non-people-oriented management and employees' engagement? To this end, 1037 employees of companies operating in Poland reported the intensity of people-oriented management, non-people-oriented management, and direct (active and passive) participation. Research findings revealed that people-oriented management and active participation (i.e., co-deciding) are the most significant for work engagement. Not only does non-people-oriented management entail a low level of engagement but a lower level of direct participation as well. As far as the dimensions of engagement are concerned (i.e., vigour, dedication, and absorption), if one of them is more intense, the other are intense as well. People-oriented management translates into active participation and the latter into engagement in all the three dimensions. A structural equation model demonstrated that perceived people-oriented management and active participation were strong, positive, and significant predictors of work engagement.

**Keywords:** people-oriented management; non-people-oriented management; active participation; passive participation; employee engagement

---

## 1. Introduction

The dynamically changing reality in which numerous companies operate constantly produces new challenges, forcing organisations to introduce changes while having no opportunity to prepare a strategy and preventive systems quickly enough. Companies striving for a competitive advantage while simultaneously struggling with an increasing global influence are prompted to seek answers to the question as to what they can do to increase the effectiveness of their employees and hence the organisation's effectiveness as well. The leading concern in this case is management. What management method is the most effective? Should employees be empowered in decision-making processes? Is it the way to enhance engagement?

Meeting the challenges mentioned above requires a reorientation of Human Resource Management (HRM) policies and practices towards sustainable human resource management [1], which refers to the idea of sustainable development [2]. Characteristics of sustainable human resource management

include people-oriented management in the work process, activity in the area of corporate social responsibility, presentation of environmental awareness in personnel policy, development of highly effective work systems, participation, and strengthening of trust as the basis for shaping social relations in work processes [3,4].

It is still a widespread concern as to how to adjust management methods so that they will stimulate employee effectiveness. Respecting the individuality of an employee creates conditions for building an organisational culture that encourages cooperation and openness, which is reflected with participation and fosters full employee engagement. People-oriented management may manifest itself with allowing employees to have direct influence over organisational decisions. However, it extends beyond passively waiting for the employee to have initiative.

Our aim in this paper is to untangle the links between people-oriented management, non-people-oriented management, direct active and passive participation, and engagement in work. The literature review (e.g., CITE) shows that the above correlations between the variables have not been studied among Polish companies so far. Although there are studies examining selected variables (e.g., CITE), to the best of our knowledge, the more complex model of the relationships between people-versus-non-people-oriented management and employees' engagement as mediated by their participation has not been tested so far.

## **2. Literature Review**

### *2.1. People-Oriented and Non-People-Oriented Management*

Analysing the classic approach to management, Mahmood, Basharat, and Bashir defined management as a "process that includes strategic planning, setting objectives, managing resources, developing the human and financial asset needed to achieve objectives and measuring results" [5] (p. 513). Traditional management models are based on a Taylor's concept of "homo economicus", according to which employees are supposed to work using the maximum of their physical and mental capabilities in order to obtain the highest possible remuneration [6] (p. 36). The main goal to achieve is "to change the system of management, so that the interests of the workmen and the management should become the same" [7] (p. 52). A company operating using this model is usually closed and formalized: A manager has the authority to give orders and expect complete obedience, and motivation is being built mainly through economic incentives or coercion. The role of the employee comes down to passive following of the managers' orders [8]. Striving for raising employee effectiveness without taking into consideration their expectations or needs puts this form of management into the non-people-oriented management method category.

A modern approach to management, however, tends to focus on employees' individuality, with an emphasis placed on cooperation based on partnership [9]. This is reflected in classic psychosocial management trends (Mayo, Likert, Argiris, and Herzberg). Organisations working accordingly with this model create conditions that encourage positive interpersonal relations and cooperation at all possible levels [10]. Employees are treated as a human capital and an important and necessary factor contributing to achieving good results and gaining a competitive edge [11,12].

As Blikle [13] highlights, the leader in people-oriented management controls the behaviours of the team members by referring to their need for virtue; he or she is not an arbitrary administrator of tangible benefits, but endeavours not to allow the 'rat race' to commence by stressing that there are no better and worse employees and that each worker is endowed with a specific talent. On the contrary, the leader in non-people-oriented management primarily administers the benefits and decides who deserves them. Thus, the members of the team are compared to one another, are being divided into better and worse—all the way to the atmosphere of rivalry and competition. In addition, Blikle identified supervisor's behaviour and company practices, in which he specifically included: being arrogant, insulting and accusing, ignoring, being rough and liconic, job rotation, broadening the scope

of work, and work enrichment. Whereas to supervisor's behaviour he included: being arrogant, insulting and accusing, ignoring, and being rough and liconic [13].

Empirical findings confirm that treating employees as partners and adopting the people-oriented approach to employees not only addresses their need for dignity and respect, but also builds their sense of agency and purposefulness of their actions, and their identification with the company [14].

## *2.2. Active and Passive Participation*

There is a rich history of the scholarly interest in workers' participation. Trends in management that are formed under the influence of economic, political, and legal factors are reflected in various participation practices. A common ground for those practices is creating space for employees to undertake initiative in their respective fields [15], and the central idea of participation is to give employees' more authority but also greater responsibility. Consequently, both employee work satisfaction as well as organisational effectiveness improve [16].

Participation is defined in various ways, from a broad perspective to any form of delegating tasks to and consulting matters with employees; through a set of activities and tools that allow employees to take part in the process of decision-making in an organisation [17], to a very narrow perspective focusing on direct communication [18]. Considering various forms of participation, one may not leave out the way employees take part in the decision-making process. It may be achieved indirectly—i.e., through representatives/selected people—or directly, with employees being involved personally.

Participation is related to active soliciting for worker participation in organisation management and empowering them to take part in solving work-related problems [19]. It is considered to be a progressive method that brings about universal benefits in terms of rising effectiveness [20].

Predominantly, the range of solutions in participative management stems from four practices: sharing information, sharing knowledge, sharing power, and sharing responsibility [21]. It should be consistent with the desired extent of employee cooperation in business management. Marchington and Wilkinson [22] describe this extent with two dimensions: degree and level of participation; building a model extending from a small degree and narrow participation of employees when they are merely informed about decisions, through consultation and cooperation to the greatest degree and widest worker participation, where they personally exercise power.

Intensity of direct employee participation is addressed by Tegtmeier [23]. He created two categories: direct passive participation and direct active participation. Passive participation is employee cooperation described as the right to access information, the right to voice complaints, the right to speak up (give opinions), and the right to give advice. Active participation pertains to the right to object, expressing consent, and the right to resolve matters jointly. According to Tegtmeier, cooperation means that workers may affect the operation of the management, but only if the management finds their contribution relevant. Co-deciding, on the other hand, offers employees more real possibilities of exerting influence over organisation management [24–27].

Not every form of participation improves an organisation's functioning. Positive impact is possible, if authentic influence on management is ensured by way of e.g., defining objectives [28] or offering solution variants, planning changes, and evaluating the effects [29]. It is important to note that mere creation of formal structures for employee participation does not guarantee positive results. Thus, the managers' role is of crucial significance here as they are responsible for implementing and supporting those structures concerning participation [30]. Neither is introduction of direct participation dependent on a company's size or character. Although more formalized forms of direct employee participation are more common in large companies [31], small companies are not left behind in terms of the level of employee satisfaction with the degree of influence that they are able to exert on their work, and the quality of communication with their superior is often higher [32,33]. The flat structure of many small companies fosters effective communication between employees and their superiors. As Edwards and Ram [34] demonstrated, even in enterprises that operate under conditions marked by

fierce market competition (such as small restaurants), employees use influence to have their needs taken into consideration.

### *2.3. Employee Engagement*

Employee engagement serves as a predictor of a company's ability to cope effectively with difficult situations [35]. Engagement pertains to building an emotional relationship between an employee and an organisation [36], which is reflected by identification with the objectives and values of the organisation on different levels [37]. In their everyday functioning, more engaged employees are more efficient, creative, more likely to provide constructive criticism and question the status quo (CITE). Such employees are also more open to initiate change, enjoy work and find it easier to adjust to new conditions, show willingness to produce good results at work [38]. Studies stress the motivational aspect of engagement [39,40] and show that employee engagement increases productivity and overall performance, creates a productive work environment, reduces non-attendance and employees leaving [41,42].

Shuck [43] described four main trends in defining and approaching engagement. The first was initiated in 1990 by Kahn, who defined engagement as "the simultaneous employment and expression of a person's 'preferred self' in task behaviours that promote connections to work and to others, personal presence, and active full role performances" [44] (p. 700). Further research confirmed the relevance of three psychological antecedents of engagement as proposed by Kahn [44,45], namely: meaningfulness, safety, and availability [46,47]. A slightly different approach was proposed by Maslach, Schaufeli, and Leiter [48], who defined engagement in contrast to burnout, highlighting that it is "a persistent positive affective state ( . . . ) characterized by high level of activation and pleasure" [48] (p. 417). In line with this approach, engagement was described as the opposite of the three burnout dimensions: exhaustion, cynicism, and ineffectiveness [49]. Over time, engagement was recognised as a separate psychological condition comprising three components: vigour, dedication, and absorption. Schaufeli's and Bakker's concept of engagement [50], which describes the three components, has recently become very popular. Schaufeli, Salanova and colleagues [51] developed an instrument to measure engagement and assess the three components [52]. According to these authors, vigour is high energy and psychological resilience as well as readiness to make effort at times of difficulty. Dedication is related to a high level of commitment to work accompanied by pride, the sense of significance, inspiration, and challenge; and absorption is involvement in work to the point of complete immersion. Work engagement is defined as a positive state of mind that brings satisfaction with one's work.

The third trend in defining engagement stems from positive psychology movement (see e.g., Harter, Schmid, and Hayes) [53]. Based on the data retrieved from the database of Gallup Organisation, Harter, and colleagues [53] (p. 269), they defined engagement as: an "individual's involvement and satisfaction with as well as enthusiasm for work". This model was used, among others, to determine the relationship between employee engagement and managerial self-efficacy and the perception of effective management practices [54]. Luthans and Peterson's [54] (p. 376) conclusion that "the most profitable work units of companies have people doing what they do best, with people they like, and with a strong sense of psychological ownership" reinforced the manner of thinking about the role of a manager, which is creating a supportive psychological climate [55].

The last trend represents the multidimensional perspective of employee engagement. In his definition, Saks [56] (p. 602) describes engagement as "distinct and unique construct consisting of cognitive, emotional and behavioural components ( . . . ) associated with individual role performance". Research by Saks [56] develops further the model by Schaufeli, Salanova et al. [51], considering engagement in three dimensions: cognitive, emotional, and behavioural and treating development of engagement as absorption of an employee resources into the work.



### 3. Research Methodology

The objective of the study was to examine the relationship between people-oriented and non-people-oriented management with direct active and passive participation in company management, and engagement in work. The following research questions driven the research process:

RQ1: What are the links between people-oriented management and non-people-oriented management, direct (active and passive) participation, and work engagement?

RQ2: Does direct participation (active and passive) mediate the relationship between people- and non-people-oriented management and employees' engagement?

#### 3.1. Method

In 2018, a questionnaire-based quantitative study was carried out on a group of 1037 people. The respondents were selected by way of non-random sampling. The research questionnaire was sent to companies in the databases of two of our universities (the database of enterprises cooperating with each university), which were selected according to the criterion of the number of employees (micro, small, medium, and large companies). The authors adopted the company size criterion according to the distribution reflecting the structure of companies in the population of enterprises in Poland (divided into micro, small, medium, and large companies). Employees of companies that took part in the survey are a group of 1037 people. The self-employed persons were excluded from the research.

#### 3.2. Participants

The participants were 1037 employees (665 women and 372 men), of whom two-thirds (63.6%) were aged 20–29 and one-fourth (21.9%) 30–39, while older participants: aged 40–49 (11.8%), 50–60 (2.4%), and over 60 formed a minority in the sample.

A majority of participants ( $n = 526$ , 50.7%) hold a university or college diploma, while 506 participants (48.8%) declared having graduated from secondary education. One-third of participants held expert positions (30.2%), with a similar group (28.8%) of white-collar workers and slightly smaller (19.3%) group of managers. There were also 9.2% blue-collar workers and 8.2% traders. The largest group of the participants was employed in service companies (39.3%) and others in trade (21.6%), mixed (16.2%) and manufacturing (9.5%) companies, and in enterprises other than the options provided in the questionnaire (11.7%), which were not specified by the respondents. Most people worked in companies in the Polish capital (65.9%), while there were also people who worked for companies in a foreign (21.9%) or mixed capital (11.8%). Table 1 presents the frequency distribution for the type of company size in which the respondents worked.

**Table 1.** Size of Companies that Participants Work in.

Number of Employees	n	%
1–9	142	13.7
10–49	267	25.7
50–249	233	22.5
>250	395	38.1
In total	1037	100

N-number of participants.

The biggest group (38.1%) of the participants worked for companies employing over 250 workers while 22.5% worked in companies employing between 50 and 249 people and 25.7% were employed in companies employing between 10 and 49 workers. The smallest number of the respondents worked for companies employing up to nine workers (13.7%).

### 3.3. Measures

The study was carried out with the use of an especially designed questionnaire. People-oriented management and non-people-oriented management were operationalized with 17 research statements, while direct (active and passive) participation were measured using eight items. People-oriented and non-people-oriented management were analysed using statements in the questionnaire, which reflected the way employees are treated in a company. As far as people-oriented management is concerned, the ten statements pertained to: treating workers as a value in itself and as partners; preference for cooperation in performing tasks as a team; placing trust in employees and respecting them; treating workers as creative and entrepreneurial individuals; the superiors' ethical conduct; stirring the willingness to act and supporting employees; appreciation of employees' work by the superiors and superiors delegating tasks, decision-making, and responsibility eagerly. Whereas non-people-oriented management referred to the following seven statements: treating employees in line with the rule that a man is worth as much as he or she earns for the business; holding a view that employees are generally lazy and dishonest so they must be controlled; treating employees as 'cogs in a machine'; ignoring workers; disregarding even small successes; dividing workers into better and worse ones by creating the atmosphere of the rat race; and superiors avoiding talking to employees. Supervisor's behaviour and company practices were operationalized with 7 research statements (due to Blikle's concept [13]). They were related to being arrogant, insulting and accusing, ignoring, being rough and liconic, job rotation, broadening the scope of work and work enrichment.

Reliability of the measurement was measured with the use of Cronbach's alpha coefficients and it was high for people-oriented management ( $\alpha = 0.85$ ) and for non-people-oriented management ( $\alpha = 0.82$ ). To assess the validity of the questionnaire correlations between the results acquired on both scales and supervisor's behaviour, job rotation, broadening the scope of work and work enrichment were computed. It was expected that both non-people-oriented management would correlate positively with such supervisor's as being arrogant, insulting and accusing, ignoring, being rough and liconic, while that people-oriented management would be correlated negatively. Correlations between non-people-oriented management and job rotation, broadening the scope of work and work enriching were supposed to be negative, while correlations between people-oriented management and these variables were supposed to be positive. The acquired correlation coefficients presented in Table 2 confirmed these assumptions.

**Table 2.** Correlation Coefficients between People-Oriented Management and Non-People-Oriented Management, Supervisor's Behaviour and Company Growth Practices.

Supervisor's Behaviour/Company Practices	People-Oriented Management	Non-People-Oriented Management
Being arrogant	-0.612 **	0.655 **
Insulting and accusing	-0.599 **	0.624 **
Ignoring	-0.649 **	0.651 **
Being rough and liconic	-0.616 **	0.640 **
Job rotation	0.461 **	-0.391 **
Broadening the scope of work	0.403 **	-0.365 **
Work enriching	0.496 **	-0.408 **

\*\*  $p < 0.01$ .

The questionnaire asked the respondents about direct participation (with eight statements). Participants reported their passive and active participation on four items each. Statements about passive participation were concerned with the possibilities that employees have for making complaints; giving advice in problematic situations, expressing one's opinion about the circumstances surrounding

the company and the department or decisions to be reached; and whether the superior informs employees about problems that a company or department is experiencing. While active participation was concerned with the statements about the possibilities of objecting to the proposed or reached decisions; expressing permission to the proposed or reached decisions; and solving problems or making decisions jointly. The statements pertaining to passive and active participation are based on the concept proposed by Tegtmeier [23] (p. 83). The reliability of the measurement was also measured with the use of Cronbach's alpha coefficients and it was high for active participation ( $\alpha = 0.74$ ) and for passive participation ( $\alpha = 0.86$ ). To assess the validity of the questionnaire, correlations between the results were also acquired on both scales and supervisor's behaviour, job rotation, broadening the scope of work and work enrichment were computed. It was expected that both active and passive participation would correlate negatively with such supervisor's as being arrogant, insulting and accusing, ignoring, being rough and liconic. The acquired correlation coefficients presented in Table 3 confirmed these assumptions. Correlations between active participation and job rotation, broadening the scope of work and work enriching were higher than between passive participation and these variables. The Pearson correlation coefficient between job rotation and passive participation was equal to  $r = 0.543$ ,  $p < 0.001$ , while the correlation between job rotation and active participation was equal to  $r = 0.810$ ,  $p < 0.001$ . The difference was statistically significant,  $Z = -15.19$ ,  $p < 0.001$ . The Pearson correlation coefficient between broadening the scope of work and passive participation was equal to  $r = 0.487$ ,  $p < 0.001$ , while the correlation between broadening the scope of work and active participation was equal to  $r = 0.830$ ,  $p < 0.001$ . The difference was statistically significant,  $Z = -19.66$ ,  $p < 0.001$ . The Pearson correlation coefficient between work enriching and passive participation was equal to  $r = 0.533$ ,  $p < 0.001$ , while the correlation between work enriching and active participation was equal to  $r = 0.849$ ,  $p < 0.001$ . The difference was statistically significant,  $Z = -19.20$ ,  $p < 0.001$ .

**Table 3.** Correlation Coefficients between Passive and Active Participation and Supervisor's Behaviour.

Supervisor's Behaviour	Passive Participation	Active Participation
Being arrogant	-0.363 **	-0.379 **
Insulting and accusing	-0.357 **	-0.347 **
Ignoring	-0.405 **	-0.402 **
Being rough and liconic	-0.378 **	-0.368 **

\*\*  $p < 0.01$ .

Work engagement was measured accordingly with the theoretical concept of Schaufeli and Bakker [50], who define work engagement as a positive, fulfilling feeling towards work, which is connected with the state of mind comprised of three dimensions: the sense of vigour experienced by an employee, dedication to work, and absorption. The authors of the above concept define these dimensions as:

- vigour—experiencing a high level of energy and mental endurance at work, willingness to go the extra mile, resilience, especially in the face of adversities;
- dedication—working with enthusiasm, with the sense that one's work is important, taking pride in being able to do one's job, being enthusiastic, and welcoming challenges;
- absorption—the sense of full concentration on and involvement in work accompanied by experiencing unnatural passing of the time and with difficulty to stop working.

Work Engagement was operationalized with the Polish version of the Utrecht Work Engagement Scale (UWES) containing nine statements.

#### **4. Plan of Statistical Analysis**

The description of the people under examination was drawn up based on frequency distributions of the responses to survey questions.

The first stage of the study was analysis of the correlations among all the variables, i.e., the level of people-oriented management, the level of non-people-oriented management, the level of direct participation and its two forms—active and passive participation, and the level of engagement and its three dimensions—vigour, dedication, and absorption.

The second stage of the study was regression analysis conducted in order to establish which form of direct participation, i.e., the active or passive one, was correlated with the level of work engagement to a larger extent.

The final stage was verification of the expected model of correlations between the variables, which was carried out with path analysis based on the highest probability method and carried out with the use of fit indices CFI, GFI, and RMSEA.

#### **5. Results**

Statistically significant positive correlations were observed between people-oriented management and direct (passive and active) participation; whereas statistically significant negative correlations were found between non-people-oriented management and direct (passive and active) participation (see Table 4). People-oriented management was also positively correlated with all the dimensions of work engagement and non-people-oriented management—negatively correlated with all the dimensions of work engagement. Direct (passive and active) participation was positively correlated with all the dimensions of work engagement (i.e., vigour, dedication, and absorption).

Subsequently, hierarchical regression analysis was carried out in order to examine which form of direct participation—active or passive and what type of management—people- versus non-people-oriented better predict employees' engagement. In the first block, the levels of people-oriented and non-people-oriented management were introduced, while in the second block, passive and active participations were added to the model (see Table 5). The dependent variables analysed in the next three models were the three dimensions of work engagement—vigour, dedication, and absorption.

Statistically significant positive effects of people-oriented management and negative effects of non-people-oriented management were obtained in all the three models. Active participation—but not passive participation—served as a positive predictor of engagement in all regression models. It should be noted that with management controlled, active participation only accounts for about 1% of the variance. It is thus only a weak predictor of engagement, especially if separated from management that accounts for between 13% and 23% of engagement's variability.

A model was analysed in which active participation was modelled as a mediator of the link between management and work engagement.

Out of the two forms of direct participation—active and passive—only the active one was entered into the model since this form of participation was indicated by the results of regression analysis as the one that is most strongly correlated with engagement.

The path analysis was performed with the maximum likelihood method. The model is presented in Figure 1.

**Table 4.** A Matrix of Correlations among the Variables under Analysis, i.e., Management Methods, Types of Participation, and the Dimensions of Work Engagement.

	Passive Participation	Active Participation	Direct Participation	People-Oriented Management	Non-People-Oriented Management	Vigour	Dedication	Absorption	Engagement
Passive participation	-	0.597 **	0.901 **	0.497 **	-0.426 **	0.289 **	0.261 **	0.218 **	0.282 **
Active participation		-	0.886 **	0.538 **	-0.453 **	0.344 **	0.326 **	0.252 **	0.339 **
Direct participation			-	0.578 **	-0.491 **	0.353 **	0.327 **	0.263 **	0.346 **
People-oriented management				-	-0.673 **	0.478 **	0.443 **	0.362 **	0.471 **
Non-people-oriented management					-	-0.373 **	-0.346 **	-0.252 **	-0.357 **
Vigour						-	0.774 **	0.673 **	0.898 **
Dedication							-	0.756 **	0.930 **
Absorption								-	0.893 **
Engagement									-

\*\*  $p < 0.01$ . Source: Work based on our own study.

**Table 5.** Dimensions of Engagement Regressed on Participation and Management.

		Beta	T	P	ΔR <sup>2</sup>
Vigour	People-oriented management	0.41	11.25	0.000	0.23
	Non-people-oriented management	−0.09	−2.57	0.010	
	People-oriented management	0.36	9.15	0.000	0.01
	Non-people-oriented management	−0.07	−2.01	0.045	
	+Passive participation	0.01	0.36	0.720	
	Active participation	0.11	2.95	0.003	
Dedication	People-oriented management	0.38	10.18	0.000	0.20
	Non-people-oriented management	−0.09	−2.36	0.019	
	People-oriented management	0.33	8.24	0.000	0.01
	Non-people-oriented management	−0.07	−1.85	0.065	
	+Passive participation	−0.01	−0.18	0.857	
	Active participation	0.12	3.19	0.001	
Absorption	People-oriented management	0.35	8.95	0.000	0.13
	Non-people-oriented management	−0.02	−0.41	0.684	
	People-oriented management	0.31	7.36	0.000	0.01
	Non-people-oriented management	0.00	−0.02	0.985	
	+Passive participation	0.02	0.51	0.609	
	Active participation	0.07	1.88	0.061	

Beta—standardized regression coefficients; t—statistical significance test value; p—statistical significance; ΔR<sup>2</sup>—percentage change of variance. Source: Work based on our own study.

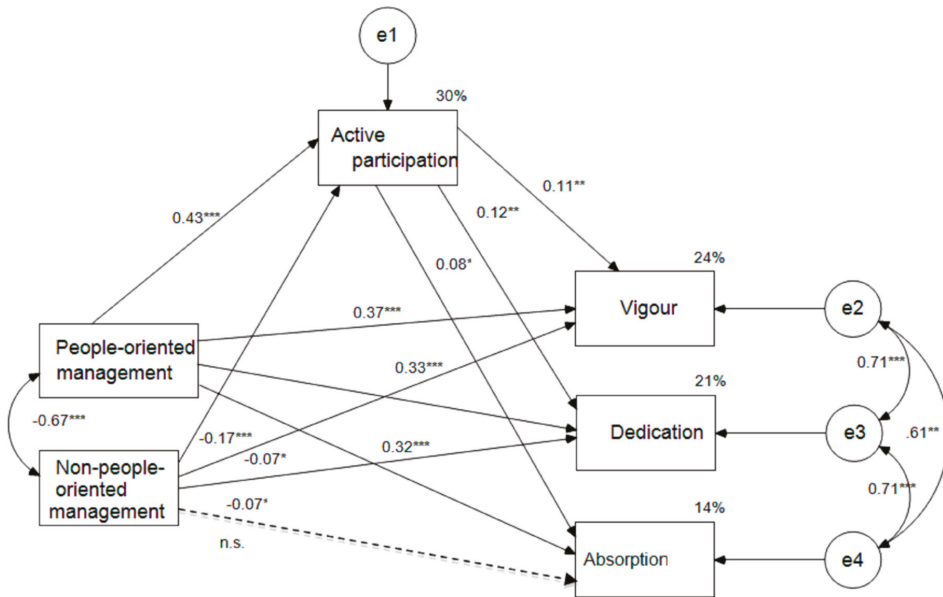

**Figure 1.** Model analysed with path analysis. \*  $p < 0.05$ ; \*\*  $p < 0.01$ ; n.s.—statistically insignificant. Source: Our work based on our own study.

The obtained model was characterized by a very good fit, according to usually applied criteria, so not-significant  $\chi^2$  test ( $\chi^2(1) = 0.01, p = 0.950$ ), high comparative fit index (CFI) = 0.99 and low root mean square error of approximation (RMSEA) = 0.01.

As demonstrated at Figure 1, people-oriented management was positively related with active participation and the latter was in turn positively linked to all three dimensions of engagement. People-oriented management was also directly and positively related with the dimensions of

engagement. Active participation is a partial mediator of the correlation between people-oriented management and engagement. Indirect effect confidence interval acquired with the use of bootstrap method was  $0.01 \div 0.05$  for absorption,  $0.02 \div 0.06$  for dedication to work and  $0.02 \div 0.06$  for vigour. Hence people-oriented management may have a direct effect on work engagement in all the three dimensions, although this effect may also occur indirectly through active participation. What is more, people-oriented management translates into active participation and the latter into engagement in all the three dimensions.

Whereas non-people-oriented management was negatively correlated with active participation, though the strength of this correlation was significantly weaker than the strength of the correlation between people-oriented management and active participation. The bootstrap confidence interval for the association between non-people-oriented management and active participation was  $-0.23 \div -0.17$ , while the bootstrap confidence interval for the association between people-oriented management and active participation was  $0.37 \div 0.43$ . Non-people-oriented management was also directly negatively linked with two of the three dimensions of engagement, i.e., vigour and dedication. The direct correlation between non-people-oriented management and absorption was not statistically significant. Thus, active participation was also a partial mediator of the correlation between non-people-oriented management and vigour and dedication. Indirect effect confidence interval acquired with the use of bootstrap method was  $-0.02 \div -0.01$  for absorption,  $-0.03 \div -0.01$  for dedication to work and  $-0.03 \div -0.01$  for vigour. What is more, the model under analysis accounted for 24% of the variance of vigour, 21% of the variance of dedication, and 14% of the variance of absorption. As the results demonstrate, the situation is completely different, if non-people-oriented management is considered. Non-people-oriented management is negatively correlated with active participation, which means that the more intense non-people-oriented management in an organisation, the lower the active participation and consequently, work engagement is also lower since as Figure 1 shows, the presence of active participation influences work engagement. It is also worth noting that in contrast to people-oriented management, there is no direct correlation between non-people-oriented management and absorption, which is one of the dimensions of work engagement. While people-oriented management influences engagement in three dimensions (i.e., vigour, dedication, and absorption), non-people-oriented management only exerts influence on two dimensions (vigour and dedication).

## **6. Discussion and Conclusions**

As demonstrated by the findings of the study, people-oriented management seems to play very relevant role for work engagement. Hence, if an organisation treats employees as partners, pays attention to cooperation in teamwork, places trust in employees, and shows respect towards them as well as treats them as creative and enterprising people while cultivating their willingness to act, make decisions and take responsibility, and at the same time acts ethically, employees will be engaged in work. Such engagement should be understood in line with the accepted model of the three dimensions: vigour, dedication, and absorption. It may thus be assumed that if people-oriented management is present in a company, employees are more eager to put in effort into their work, showing high energy levels and psychological resilience to adversity. Moreover, they show enthusiasm in work, have the sense of importance and purposefulness, take pride in what they do, and do not see challenges as barriers or problems. They concentrate fully and become absorbed by their work paying no attention to the passing time.

Whereas if the non-people-oriented management style is preferred in an organisation, i.e., when employees are treated only as a source of profit and seen as mere 'cogs in a machine' that need to be constantly supervised, their successes, even the smallest ones, are being ignored and overlooked in an atmosphere of fierce competition, while being baselessly convinced that employees are lazy and dishonest, the level of engagement will be considerably smaller. Active participation is also important in building work engagement in contrast to passive participation that pays no role whatsoever. Thus, engagement is influenced by the presence of active participation (i.e., co-deciding) pertaining to

the possibility of objecting to the proposed or reached decisions; expressing permission to the proposed or reached decisions; and solving problems or making decisions jointly. Passive participation does not have such importance for engagement. This form of direct participation (i.e., cooperation) is only concerned with the employees' right to make complaints, give advice in problematic situations, express their opinions about the circumstances surrounding the company and the department or decisions to be reached, and to be informed by the superior about problems that a company or department is experiencing—and as demonstrated by the results of this study, it does not influence work engagement in any of its three dimensions.

It should also be added that non-people-oriented management not only entails a low level of engagement but direct participation in such a company is also lower.

Moreover, work engagement seems to be directly predicted by people-oriented management, but it may also be strengthened indirectly through active participation. Thus, whether an employee is engaged or not depends on both people-oriented management and active participation. It is, therefore, appropriate to assume that the mere presence of active participation in a company does not influence work engagement in all its three dimensions, if unaccompanied by people-oriented management. Part of the correlation between management and engagement exists through the agency of active participation and part of it occurs directly. People-oriented management translates into active participation and the latter into engagement in all the three dimensions.

Furthermore, a sense of return on investments can come from external rewards and recognition in addition to meaningful work. Therefore, one might expect that employees' will be more likely to engage themselves at work to the extent that they perceive a greater amount of rewards and recognition for their role performance. Maslach and colleagues [48] (pp. 397–422) also suggested that while a lack of rewards and recognition can lead to burnout, appropriate recognition and reward is important for engagement. When employees receive rewards and recognition from their organisation, they will feel obliged to respond with higher levels of engagement.

If non-people-oriented management is preferred in a company and it is intense, active participation will definitely be weaker and it does influence work engagement. As demonstrated by research results, if there is non-people-oriented management style exercised in an organisation, it may only exert influence on two dimensions of engagement (i.e., vigour and dedication) but not on absorption. This means that in such a situation the employee does not fully concentrate on or engage in work, possibly controls the time, and awaits the end of a working day.

It should also be noted that according to research results, the two management methods are not concurrent in an organisation. If people-oriented management is more intense, then non-people-oriented management is less intense, and the other way around—if non-people-oriented management is more intense, then people-oriented management is less intense. Moreover, it has been demonstrated that as far as the dimensions of engagement are concerned (i.e., vigour, dedication, and absorption)—if one of them is more intense, then the others are intense as well. Hence if employees put in a lot of effort and energy in doing their job, they are resilient, especially in the face of adversity—they are more enthusiastic about their work, it is more important to them, carries sense and is a source of pride; thus they focus more strongly on the work and become absorbed by it, paying no attention to the time passing by. Work engagement by Schaufeli is embedded in Hobfoll's theory of resources. There is a positive relationship between resources and commitment regarding aspects such as: help in achieving goals, reduction of requirements and control, support from superiors [57]. Demerouti found that job resources (such as performance feedback, supervisor support) were predictors of engagement [58] (pp. 499–512).

In conclusion, managers should pay attention to the way the human capital is managed in an organisation and prefer the people-oriented management style that gives the employee the right to co-decide. An important practical implication for managers is the need for them to understand the importance of social exchange for employee engagement. In particular, managers need to provide employees with resources and benefits that will oblige them to reciprocate in kind with higher levels



of engagement. Although the results of this study highlight the importance of job characteristics and social support, there might be other factors that are more important for different employees. Thus, a “one size fits all” approach to employee engagement might not be the most effective. Managers should find out what resources and benefits are most desired by employees and most likely to create a sense of obligation that is returned with greater levels of engagement.

The findings of this study should be read in light of its limitations that should be addressed by future studies. First, this study relied heavily on self-report measures and was conducted on a convenience sample. It may have inflated the associations among the study variables due to common method variance or the wish to answer consistently. The studied sample, although quite numerous, cannot be considered representative of the general population of Polish employees. Therefore, the generalizability of the findings obtained is not without questions. Despite this, however, the findings obtained may bring some new insights for practitioners, since they widen managerial knowledge about the approach to the human capital [26]. The authors are well aware of the fact that the paper does not exhaust the research problem and is merely a trigger for further research on the complex issue of human capital management processes in organisations.

**Author Contributions:** Conceptualization, B.S., M.B.; methodology, B.S., M.B.; software, M.B.; validation, B.S., M.B.; formal analysis, B.S., M.B.; investigation, B.S., M.B.; resources, B.S.; writing—original draft preparation, B.S., M.B.; writing—review and editing, B.S., M.B.; visualization, B.S., M.B. All authors have read and agreed to the published version of the manuscript.

**Funding:** The research received no external funding.

**Conflicts of Interest:** The authors declare no conflict of interest.

## References

1. Ehnert, I. Sustainable Human Resource Management. In *A Conceptual and Exploratory Analysis from a Paradox Perspective*; Springer: Berlin/Heidelberg, Germany, 2009.
2. Muller-Camen, M.; Croucher, R.; Leigh, S. *Human Resource Management: A Case Study Approach*; CIPD: London, UK, 2008.
3. Ulrich, D.; Brockbank, W. *The HR Value Proposition*; Harvard Business School Press: Boston, MA, USA, 2005.
4. Pochtowski, A. Zrównoważone zarządzanie zasobami ludzkimi w teorii i praktyce. *Zarządzanie Finans. J. Manag. Financ.* **2016**, *14*, 303–314.
5. Mahmood, Z.; Basharat, M.; Bashir, Z. Review of Classical Management Theories. *Int. J. Sci. Educ.* **2012**, *2*, 512–522.
6. Cascio, W.F. *Managing Human Resources. Productivity, Quality of Work Life Profis*; McGraw-Hill Education: New York, NY, USA, 1992.
7. Taylor, F.W. *The Principles of Scientific Management*; Harper: New York, NY, USA, 1917.
8. Robbins, S.P.; Coulter, M. *Management*; Pearson Prentice Hall: Upper Saddle River, NJ, USA, 2012.
9. Gableta, M. *Człowiek i Praca w Zmieniającym się Przedsiębiorstwie*; [The Human Being and Work in a Changing Company]; WAE im. Oskara Langego we Wrocławiu: Wrocław, Poland, 2004.
10. Robbins, S.P.; DeCenzo, D.A. *Fundamentals of Management*; Pearson Prentice Hall: Upper Saddle River, NJ, USA, 2002.
11. Hsu, I.C.; Lin, Y.Y.; Lawler, J.J.; Wu, S.H. Toward a model of organizational human capital development: Preliminary evidence from Taiwan. *Asia Pac. Bus. Rev.* **2007**, *13*, 251–275. [[CrossRef](#)]
12. Wang, D.; Chen, S. Does Intellectual Capital Matter? High-Performance Work Systems and Bilateral Innovative Capabilities. *Int. J. Manpow.* **2013**, *34*, 861–879. [[CrossRef](#)]
13. Blikle, A. *Doktryna Jakości. Rzecz o Turkusowej Samoorganizacji*; [The Quality Doctrine. Turquoise Self-Organization]; Wydawnictwo Helion: Gliwice, Poland, 2017.
14. Sypniewska, B.A. Godnościowa satysfakcja pracownicza. [Dignity-related Employee Satisfaction]. In *Zarządzanie Zasobami Ludzkimi. Refleksje Teoretyczne, Kwestie Praktyczne*; [Human Resources Management. Theoretical Reflections, Practical Issues]; Oleksyn, T., Sypniewska, B.A., Eds.; WSFiZ: Warszawa, Poland, 2016; pp. 359–374.

15. Guest, D.; Fatchett, D. *Worker Participation: Individual Control and Performance*; Institute of Personnel Management: London, UK, 1974.
16. Appelbaum, S.H.; Abdallah, C.; Shapiro, B.T. The Self-directed Team: A Conflict Resolution Analysis. *Team Perform. Manag.* **1999**, *5*, 60–77. [[CrossRef](#)]
17. Bhatti, K.K.; Nawab, S.; Akbar, A. Effect of Direct Participation on Organizational Commitment. *Int. J. Business Soc. Sci.* **2011**, *2*, 15–23.
18. Wilkinson, A.; Gollan, P.J.; Marchingto, M. *The Oxford Handbook of Participation in Organizations*; University Press: Oxford, UK, 2010.
19. Maisela, T. Participative Management Facilitates a Productive Workplace. *Hum. Resour. Manag.* **1995**, *11*, 20–22.
20. Delaney, J.T.; Huselid, M.A. The Impact of Human Resource Management Practices on Perceptions of Organizational Performance. *Acad. Manag. J.* **1996**, *39*, 949–969. [[CrossRef](#)]
21. Ang, A. An Eclectic Review of the Multidimensional Perspectives of Employee Involvement. *TQM Mag.* **2002**, *14*, 192–200. [[CrossRef](#)]
22. Marchington, M.; Wilkinson, A. Direct participation. In *Personnel Management: A Comprehensive Guide to Theory and Practice*, 4th ed.; Bach, S., Ed.; Blackwell: Oxford, UK, 2005; pp. 340–364.
23. Tegtmeier, W. *Wirkungen der Mitbestimmung der Arbeitnehmer*; Vandenhoeck und Ruprecht: Göttingen, Germany, 1973.
24. Ignys, A. Analiza wykorzystania bezpośredniej partycypacji pracowniczej jako formy zaangażowania pracowników w zarządzaniu współczesnymi organizacjami. [Analysis of the Use of Direct Employee Participation as a Form of Employee Engagement in Management of Contemporary Organisations]. *Studia Oeconomica Posnaniensia* **2014**, *2*, 141–157.
25. Mikula, B. Diagnozowanie stopnia partycypacji bezpośredniej pracowników. [Diagnosing the Level of Direct Employee Participation]. *Zesz. Nauk. Akad. Ekon. Krakowie* **2001**, *564*, 25–38.
26. Piotrowski, K.; Świątkowski, M. *Kierowanie Zespołami Ludzi*; [Managing Teams]; Bellona: Warszawa, Poland, 2000.
27. Ziemienczyk, K. *Techniki Zarządzania*; [Management Techniques]; PWE: Warszawa, Poland, 1991.
28. Latham, G.P.; Winters, D.C.; Locke, E.A. Cognitive and Motivational Effects of Participation: A Mediator Study. *J. Organ. Behav.* **1994**, *1*, 49–63. [[CrossRef](#)]
29. Black, J.S.; Gregersen, H.B. Participative Decision – Making: An Integration of Multiple Dimensions. *Hum. Relat.* **1997**, *50*, 859–878. [[CrossRef](#)]
30. Boxall, P.; Purcell, J. *Strategy and Human Resource Management*; Palgrave Macmillan: New York, NY, USA, 2008.
31. Kersley, B.; Alpin, C.; Forth, J.; Bryson, A.; Bewley, H.; Dix, G.; Oxenbridge, S. *Inside the Workplace: Findings from the 2004 Workplace Employment Relations Survey*; Routledge: London, UK, 2006.
32. Forth, J.; Bewley, H.; Bryson, A. *Small and Medium-Sized Enterprises: Findings from the 2004 Workplace Employment Relations Survey*; Department of Trade and Industry: London, UK, 2006.
33. Macky, K.; Boxall, P. The Relationship between High-Performance Work Practices and Employee Attitudes: An Investigation of Additive and Interaction Effects. *Int. J. Hum. Resour. Manag.* **2007**, *18*, 537–567. [[CrossRef](#)]
34. Edwards, P.; Ram, M. Surviving on the Margins of the Economy: Working Relationships in Small, Low-Wage Firms. *J. Manag. Stud.* **2006**, *43*, 895–916. [[CrossRef](#)]
35. Marchington, M.; Kynighou, A. The dynamics of employee involvement and participation during turbulent times. *Int. J. Hum. Resour. Manag.* **2012**, *23*, 3336–3354. [[CrossRef](#)]
36. Vance, R.J. *Employee Engagement and Commitment. A Guide to Understanding, Measuring and Increasing Engagement in Your Company*; SHRM Fundation: Alexandria, Egypt, 2006.
37. Shuck, B. Four Emerging Perspectives of Employee Engagement: An Integrative Literature Review. *Hum. Resour. Dev. Rev.* **2011**, *20*, 1–25. [[CrossRef](#)]
38. Smythe, J. *The CEO: The Chief Engagement Officer: Turning Hierarchy Upside Down to Drive Performance*; Gower: Burlington, NJ, USA, 2011.
39. Bakker, A.B.; Demerouti, E.; Schaufeli, W.B. The crossover of burnout and work engagement among working couples. *Hum. Relat.* **2005**, *58*, 661–689. [[CrossRef](#)]
40. Salanova, M.; Llorens, S.; Cifre, E.; Martinez, I.; Schaufeli, W.B. Perceived collective efficacy, subjective well-being and task performance among electronic work groups: An experimental study. *Small Group Res.* **2003**, *34*, 43–73. [[CrossRef](#)]

41. Caplan, J. *Strategic Talent Development. Develop and Engage All Your People for Business Success*; Kogan Page: London, UK, 2013.
42. Fleming, J.H.; Asplund, J. *Human Sigma*; Gallup Press: New York, NY, USA, 2007.
43. Shuck, B.; Wollard, K. Employee Engagement and HRD: A Seminal Review of the Foundations. *Hum. Resour. Dev. Rev.* **2010**, *9*, 89–110. [[CrossRef](#)]
44. Kahn, W. Psychological conditions of personal engagement and disengagement at work. *Acad. Manag. J.* **1990**, *33*, 692–724.
45. Kahn, W. To be fully there: Psychological presence at work. *Hum. Relat.* **1992**, *45*, 321–349. [[CrossRef](#)]
46. May, D.R.; Gilson, R.L.; Harter, L.M. The psychological conditions of meaningfulness, safety, and availability and the engagement of the human spirit at work. *J. Occup. Psychol.* **2004**, *77*, 11–37. [[CrossRef](#)]
47. Rich, B.L.; Lepine, J.A.; Crawford, E.R. Job engagement: Antecedents and effects on job performance. *Acad. Manag. J.* **2010**, *53*, 617–635. [[CrossRef](#)]
48. Maslach, C.; Schaufeli, W.B.; Leiter, M.P. Job burnout. *Annu. Rev. Psychol.* **2001**, *52*, 397–422. [[CrossRef](#)]
49. Maslach, C.; Leiter, M.P. *The Truth about Burnout: How Organizations Cause Personal Stress and What to do about It*; Jossey-Bass: San Francisco, CA, USA, 1997.
50. Schaufeli, W.; Bakker, A.B. *Utrecht Work Engagement Scale. Preliminary Manual; Version 1*; Occupational Health Psychology Unit, Utrecht University: Utrecht, The Netherlands, 2003; Available online: [http://www.beanmanaged.eu/pdf/articles/arnoldbakker/article\\_arnold\\_bakker\\_87.pdf](http://www.beanmanaged.eu/pdf/articles/arnoldbakker/article_arnold_bakker_87.pdf) (accessed on 20 November 2019).
51. Schaufeli, W.B.; Salanova, M.; Gonzalez-Roma, V.; Bakker, A.B. The measurement of engagement and burnout: A two sample confirmatory factor analytic approach. *J. Happiness Stud.* **2002**, *3*, 71–92. [[CrossRef](#)]
52. Schaufeli, W.B.; Bakker, A.B. *UWES—Utrecht Work Engagement Scale: Test Manual, Unpublished manuscript, Occupational Health Psychology Unit*; Utrecht University: Utrecht, The Netherlands, 2003.
53. Harter, J.K.; Schmidt, F.L.; Hayes, T.L. Business-unit-level relationship between employee satisfaction, employee engagement, and business outcomes: A meta-analysis. *J. Appl. Psychol.* **2002**, *87*, 268–279. [[CrossRef](#)]
54. Luthans, F.; Peterson, S.J. Employee engagement and manager self-efficacy: Implications for managerial effectiveness and development. *J. Manag. Dev.* **2001**, *21*, 376–387. [[CrossRef](#)]
55. Brown, S.P.; Leigh, T.W. A new look at psychological climate and its relationship to job involvement, effort, and performance. *J. Appl. Psychol.* **1996**, *81*, 359–368. [[CrossRef](#)]
56. Saks, A.M. Antecedents and consequences of employee engagement. *J. Manag. Psychol.* **2006**, *21*, 600–619. [[CrossRef](#)]
57. Schaufeli, W.B.; Salanova, M. Enhancing work engagement through the management of human resources. In *The Individual in the Changing Working Life*; Naswall, K., Sverke, M., Hellgren, J., Eds.; Cambridge University Press: Cambridge, UK, 2008.
58. Demerouti, E.; Bakker, A.B.; Nachreiner, F.; Schaufeli, W.B. The job demands–resources model of burnout. *J. Appl. Psychol.* **2001**, *86*, 499–512. [[CrossRef](#)] [[PubMed](#)]





Article

# In Search of Sustainable Value: A Structured Literature Review

Andrea Cardoni <sup>1,\*</sup>, Evgeniia Kiseleva <sup>1</sup> and Paolo Taticchi <sup>2</sup>

<sup>1</sup> Department of Economics, University of Perugia, Via Alessandro Pascoli, 20, 06123 Perugia, Italy; evgeniia.kiseleva@studenti.unipg.it

<sup>2</sup> Business Schools, Imperial College London, 457 ACE Extension, South Kensington Campus, London SW7 2AZ, UK; p.taticchi@imperial.ac.uk

\* Correspondence: andrea.cardoni@unipg.it; Tel.: +39-75-585-52-53

Received: 11 December 2019; Accepted: 10 January 2020; Published: 14 January 2020

**Abstract:** The concept of value, where shareholders are the main recipients of the created value, is changing towards more comprehensive models, which respond to the increased stakeholder awareness and urgent sustainability agenda. Hart and Milstein (2003) elaborated the widely used sustainable value concept in which they characterize temporal and spatial dimensions of value, and suggest strategic drivers for sustainability. Although the framework is highly cited, there is no review on the changes over more than ten years. In this paper, we adopted a structured literature review methodology to discover how the concept of sustainable value has been used by researchers and how it has been developed. Our findings show that sustainable value has mainly been used as the general phrase to describe positive business results instead of using it as a concept. Scholars, who make an in-depth analysis of sustainable value do not emphasize the time horizon of sustainable value as its peculiar characteristic while broad stakeholder surrounding is called to be an important feature of sustainable value. Additionally, strategic drivers for sustainability have moved from being purely environmental as in Hart and Milstein's (2003) concept: globalization, economic fluctuations, and knowledge innovation have become as important as green technologies and carbon-reduction policies.

**Keywords:** sustainable value; sustainability; environment; CSR; stakeholders; structured literature review

---

## 1. Introduction

The need for a better-definition of “value” in the modern world is becoming increasingly pressing [1]. The multidisciplinary nature of management literature means that there is considerable disagreement on for whose benefit value should be created, and how that value will be generated. The increased importance of stakeholders in business processes has changed the perception of business goals and of the beneficiaries of created value. Before, an organization was considered a black box that uses resources and generates economic profits for shareholders. Today, attention has been turned towards sustainable value creation, or co-creation with stakeholders over a longer period of time [2].

The clearest definition of sustainable value is proposed by Hart and Milstein (2003) in the much-cited “Creating sustainable value”. Hart and Milstein (2003) defined sustainable value as “strategies and practices that contribute to a more sustainable world while simultaneously driving shareholder value” [3]. We used Hart and Milstein's framework, as it contains fixed measures to define sustainable value, and is the most influential in the scientific field. The authors' measurement of sustainable value along two indices—spatial (internal and external stakeholders) and temporal (short, medium, and long-term orientation)—is of particular value.

However, this model was introduced more than a decade-and-a-half ago, in 2003. The sustainability agenda has changed dramatically since then. In 2015, the United Nations issued the 2030 Sustainable

Development Goals (SDGs) that have come to define the international sustainability agenda [4]. The SDGs cover everything pertaining to the triple bottom-line, not just the environment: poverty, inequality, climate change, environmental degradation, peace, and justice.

Another dramatic change in the intervening period was the financial crisis of 2008, which laid bare the dangers of short-termism focused on profit maximization. The consequences, many irrevocable, included drops in stock indices, the collapse of financial institutions, unemployment, poverty, and increased inequality [5]. The financial crisis served to raise the question of whether corporate social responsibility (CSR) was a threat to businesses or an opportunity [6].

Finally, what have been called the “Fourth Industrial Revolution” and “Industry 4.0” have disrupted our understanding of business and the value creation process. Digitization has been identified as the main driver of change in all sectors of the new economy [7]. In this context, intangible assets, such as patents, knowledge, human resource capabilities, etc., have become the main part of a company’s value [8]. The scale of economic value alone is not adequate in measuring the growing contribution of intangible assets.

Although the concept of value—and sustainable value in particular—is widely discussed, we did not find any reviews on sustainable value that summarized changes in the sustainability agenda which modified Hart and Milstein’s definition and framework. In our paper, we undertake structured literature review [9] aiming to bring understanding of up-to-date sustainable value concept use and development.

The paper is organized as follows. After the Introduction Section, Section 2 proposes existing literature and research gap. Section 3 presents the research methodology. Section 4 shows our results and discussion. The last section proposes conclusions, implications and future research.

## 2. Literature Analysis and Research Gaps

Although the term “sustainable value” occurs frequently in the literature, the concept itself is not well defined. Common synonyms are “co-creation value”, “shared value”, “social value”, “environmental value”, and “stakeholder value”. The terms which appear with the highest frequency are “shared value” and “sustainable value”. Porter and Kramer’s shared value concept [10] is generally accepted as being underdeveloped from a theoretical point of view [11,12]. Consequently, this research focuses on sustainable value.

Precise definitions of sustainable value vary throughout the literature (Table 1).

**Table 1.** Authors about sustainable value creation.

Author/s	Number of Citations (Google Scholar as of 25.12.19)	Definition of Sustainable Value
Hart and Milstein (2003) [3]	1.874	“The global challenge associated with sustainable development, viewed through the appropriate set of business lenses, can help to identify strategies and practices that contribute to a more sustainable world while simultaneously driving shareholder value: this we define as the creation of sustainable value for the firm”.
Wheeler et al. (2003) [13]	562	“... economic, social and ecological value”.
Adams et al. (2016) [14]	369	“The context [of innovation activities of Systems Building] is characterized by a shift toward networks of relations in which sustainability value is created collaboratively rather than individually”.
Figge and Hahn (2005) [15]	233	“... sustainable value, that is, the value created by a hyper-efficient use of all forms of capital. A positive (negative) sustainable value indicates that a company uses its capital base more (less) efficiently than the benchmark”.

Table 1. Cont.

Author/s	Number of Citations (Google Scholar as of 25.12.19)	Definition of Sustainable Value
Beattie and Smith (2013) [16]	232	“Value is no longer created by firms acting autonomously, but by firms acting together with parties external to the firm through informal arrangements or formal alliances”.
Bocken et al. (2015) [17]	174	“For sustainability thinking, [there is] the need for a more holistic view of value that integrates social and environmental goals, to ensure balancing or ideally alignment of all stakeholder interests to deliver “sustainable value” creation”.

Many literature reviews (LRs) on sustainability management have been carried out in recent years. With the help of *Wiley Online Library*, *SAGE Journals*, *JSTOR*, *Academy of Management and Elsevier* databases, we encountered 71 LRs carried out over the last decade, which we have classified according to the object of research (Appendix A Table A1). No LRs on sustainable value were found.

All LRs state that gaps exist in CSR research. A number of authors highlight that research is mostly at the organizational level, ignoring the wider ecosystem in which a company operates [18,19] while behavioral analysis at an individual level is largely neglected as well [1,20–22]. Thus, there is a need for multilevel research that is capable of integrating separate levels of analysis: institutional, organizational, and individual [23,24]. A second research gap is a lack of investigation into the underlying mechanisms which link CSR with outcomes [23,24]. A third is the absence of a standardized definitional framework and accepted theories [18,21,25–27].

Our paper claims that sustainable value is able to bridge the gaps in the literature, as it represents:

- A central concept for both microlevel (individual, group) and macrolevel (organization theory, strategic management) research [28];
- An umbrella concept for all other topics about sustainability, which explains the links between them;
- A concept that has been viewed from a number of different theoretical perspectives (stakeholder theory, ethical theories, resource-based views, institutional theory, agency theory, network theory, and others).

In this research, we use Hart and Milstein’s (2003) definition of sustainable value, by virtue of its being the most frequently cited. This framework also offers a very precise structure which enables us to develop objective criteria for sustainable value research. As shown below (Figure 1), the framework is developed across two axes: temporal and spatial. In combination, the vertical (temporal) and horizontal (spatial) axes map a framework divided into four strategic dimensions and their related sustainability drivers: (I) pollution prevention, considering the environmental consequences of industrialization; (II) product stewardship, taking into account proliferation and interconnections with civil society and stakeholders; (III) clean technology, with respect to the emergence of new green technologies; (IV) sustainability vision, as a strategic orientation to counteract the negative effects of population growth, poverty, and inequity.

According to Hart and Milstein (2003), the four quadrants, and the strategies and drivers related to each, are of equal importance. They state that programs in pollution prevention (quadrant I) and product stewardship (quadrant II) were already institutionalized within most multinational companies by the point at which their paper was published. In the intervening 15 years, we expect that portfolios have become more balanced, and that CSR-related research has been spread more evenly across each of the framework’s four quadrants. Thus, our paper formulates the following research question: “How is the concept of sustainable value used in the literature, and how has it developed?”

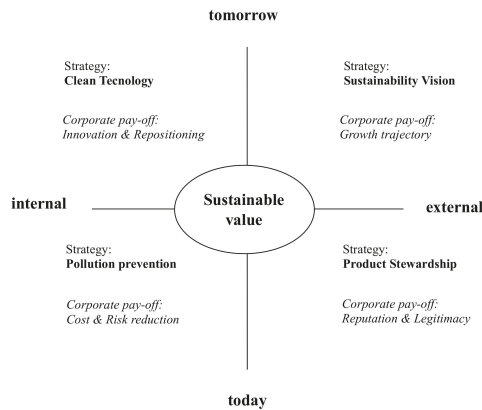

**Figure 1.** Sustainable value framework (adapted from Hart and Milstein, 2003) [3].

### 3. Research Methodology

The most common technique among 71 literature reviews on sustainability topics is systematic literature review that is mentioned in 56% of papers. Notably, 32% of papers, or 68% of systematic literature reviews, are undertaken in accordance to the Tranfield methodology [29,30].

Unlike previous researchers, we used a structured literature review methodology (SLR) proposed by Massaro et al. (2016) [9]. According to this, literature review includes ten steps: (1) writing a protocol, (2) posing questions to answer, (3) a literature search, (4) measuring article impact, (5) defining analytical framework, (6) checking reliability and (7) validity, (8) data codification, (9) getting insights from data and (10) developing future paths [9]. The steps are common with widely used systematic reviews, however, they are more detailed, which makes the approach the most precise and rigorous one [9]. The SLR framework of Massaro et al. (2016) is novel comparing to systematic review methodology of Tranfield et al. (2003) and coincides with up-to-date research tools [9,30]. Additionally, it is accepted to be effective when researching under-investigated topics, such as sustainable value, facilitating the development of new knowledge areas and research approaches [31].

We built the research protocol (Table 2), which represents our research work on each SLR step from Massaro et al. (2016) methodology.

Moving forward according to the predetermined protocol, we built a database of articles. Firstly, we found 30 top journals from the ABS-list (Appendix A Table A2). ABS includes not only citations as criteria but also editorial and expert judgements, which makes rating scientifically reliable [32]. The management thematic blocks (with “management” or “strategy” in their names) were chosen in order to enhance homogeneity in understanding the sustainable value terminology. Practitioners’ oriented journals (Harvard Business Review and MIT Sloan Management Review) were excluded in order to enhance scientific rigor.

Next, we selected articles, which have the phrase “sustainable value” in the texts, from the predetermined journals. A total of 106 articles were found for a ten-year period from 2008 to 2018 with the help of databases such as Wiley Online Library, SAGE Journals, JSTOR, Academy of Management and Elsevier.



Table 2. Literature review protocol.

<b>Question</b>	"How Is the Concept of Sustainable Value Used in the Literature, and How Has It Developed?"	
<b>Search</b>	<p>Journals:</p> <ul style="list-style-type: none"> <li>• high rank in ABS-list ("3"–"4**")</li> <li>• scientific</li> <li>• blocks with "management" or "strategy" in their names (only general management or strategy topics, international)</li> </ul> <p>Articles:</p> <ul style="list-style-type: none"> <li>• management field</li> <li>• 2008–2018</li> <li>• Key words: "sustainable value", search in all the text of the paper (excluding author info and references)</li> </ul>	
<b>Article Impact</b>	Average citation per article	
<b>Analytical Framework</b>	<ul style="list-style-type: none"> <li>• Content analysis based on Hart and Milstein (2003) sustainable value concept</li> <li>• Word frequency analysis with R (<a href="https://www.r-project.org">https://www.r-project.org</a>)</li> </ul>	
<b>Reliability</b>	Codification is undertaken with selective cross-check, work is saved at Microsoft Excel™	
<b>Validity</b>	<p>Internal</p> <p>An empirically based pattern is expected to coincide with predicted one made on the basis of Hart and Milstein (2003) concept</p>	<p>External</p> <p>106 articles are analyzed. Results are proved by 71 literature reviews from cross-related fields</p>
<b>Code</b>	<p>Formal:</p> <ul style="list-style-type: none"> <li>• Name of the article</li> <li>• Journal and its Rating</li> <li>• Authors</li> <li>• Citations</li> </ul> <p>Methodology:</p> <ul style="list-style-type: none"> <li>• Type of the study: qualitative/quantitative/both</li> <li>• Type of the questions in the study: exploratory/descriptive (what?where?when?)/explanatory (why?how?)</li> <li>• Research design: case study/literature review/survey research/secondary data analysis/ethnography/several</li> <li>• Theories applied</li> </ul>	<p>Construct</p> <p>Journals are from management field</p> <p>The use of "sustainable value":</p> <ul style="list-style-type: none"> <li>• Year of publication</li> <li>• Number of appearances of the phrase "sustainable value"</li> <li>• The role of "sustainable value" and its synonyms: framework/variable/concept to site/none</li> </ul> <p>The development of sustainable value concept (Hart and Milstein (2003):</p> <ul style="list-style-type: none"> <li>• Sustainability drivers</li> <li>• Spatial dimension (stakeholders)</li> <li>• Temporal dimension</li> </ul>
<b>Expected Insights</b>	<ul style="list-style-type: none"> <li>• Increased prominence of the concept of sustainable value over time, with growing application of different theories and a shift from qualitative to quantitative research</li> <li>• Focus to become more long-term, with a wider list of external stakeholders taken into consideration, moving toward greater balance across the four quadrants of Hart and Milstein's (2003) framework</li> </ul>	
<b>Future Research</b>	<ul style="list-style-type: none"> <li>• Empirical research on sustainable value</li> <li>• Elaboration of statistical tools</li> <li>• Investigation of top managers' new role</li> </ul>	

We performed a content analysis with *Microsoft Excel<sup>TM</sup>*, and word frequency analysis (text mining) with *R* program to gather data.

The codification criteria can be divided into four categories. The first (formal) part was to build general statistics about the papers (name, authors, citations, journal information, etc.). The second set of criteria analyzed methodology trends, according to Bhattacharjee [33]. The third, measuring usage of the concept, looked at the year of publication, the number of appearances, and the role of sustainable value in the paper.

The development of the concept of sustainable value was gauged using Hart and Milstein's [3] sustainable value framework. First, the strategic drivers of sustainability strategies were classified according to the four groupings suggested by the framework (environmental consequences of industrialization; the emergence of new green technologies; fighting poverty and inequity; and interconnection with civil society and stakeholders). We operationalized the analysis of the spatial and temporal perspectives along the following scales. For the former, we assigned a conventional score depending on the explicit beneficiary mentioned in the article: -3 (= nobody); -2 (= shareholder only); -1 (= internal stakeholders; e.g., employees); 0 (= not disclosed); 1 (= limited group of external stakeholders; e.g., customers); 2 (= all stakeholders); 3 (= society at large or environment at large). For the latter, the classification was: -1 (= short term); 0 (= both or not mentioned); 1 (= long-term).

The reliability of our research was supported by selective cross-checking; the validity through the usage of high-ranked ABS journals, and strong theoretical support of our expected results. Average citation (Crossref metric) per article was used for impact check as it is a strong signaling tool which shows what is important from the knowledge consumers' points of view [9].

## 4. Results and Discussion

### 4.1. Overview on Formal Characteristics and Methodological Aspects

The articles are not spread evenly between journals (Table 3). The majority of papers are from two journals: *Journal of Business Ethics* (38.6%) and *Business Strategy and the Environment* (14.1%). Notably, *Journal of Business Ethics* focuses on human resource development, which leads to the assumption that sustainable value in this journal most likely pertains to an ethical management mindset. Taking this into account, the quantity of journals that develop the framework of sustainable value is very limited. The papers are actively discussed in the scientific community (Table 3): only 7.5% of articles are uncited. In total, 47.0% of papers have 1–19 citations, and 45.5% of articles are highly cited, with more than 20 citations.

**Table 3.** Formal characteristics of papers.

Journal	<i>n</i>	%	N of Citations	<i>n</i>	%
Journal of Business Ethics	41	38.6	0	8	7.5
Business Strategy and the Environment	15	14.1	From 1 to 19	50	47.0
Journal of Business Research	8	7.5	From 20 to 39	17	16.0
Long Range Planning	7	6.6	From 40 to 59	8	7.5
California Management Review	5	4.7	From 60 to 79	8	7.5
Business and Society	4	3.8	From 80 to 99	3	2.8
Journal of Management	3	2.8	Over 100	12	11.3
Journal of Management Inquiry	3	2.8	<b>Total</b>	<b>106</b>	<b>100.0</b>
Strategic Management Journal	3	2.8			
Other journals (with less than 2 articles)	17	16.0			
<b>Total</b>	<b>106</b>	<b>100.0</b>			

Assuming the methodology employed, explanatory qualitative studies prevail (Table 4). Qualitative design is focused on “sense making” or understanding the phenomenon [33]. This shows that the concept of sustainable value is still underdeveloped, with further investigation required. Such explanatory research addresses “why” and “how”-type questions in an attempt to “connect the

dots” and identify causal factors and outcomes related to the phenomenon in question [33]. Articles in our dataset try to answer questions such as “How can firms create different types of value for different stakeholders?” [34], “Why are some firms more effective than others at addressing stakeholder concerns?” [35], “How can value logic thinking be applied to organizations?” [36], etc.

**Table 4.** Methodological features of the papers.

Type of the Study	n	%	Type of Question	n	%
Qualitative	81	76.4	Explanatory (why? how?)	50	47.2
Quantitative	22	20.8	Descriptive (what? where? when?)	31	29.2
Both	3	2.8	Exploratory	25	23.6
<b>Total</b>	<b>106</b>	<b>100.0</b>	<b>Total</b>	<b>106</b>	<b>100.0</b>
Research Design	n	%	Theories Applied	n	%
Literature review	43	40.6	Stakeholder theory	18	17.0
Case study	27	25.5	Ethical theories	17	16.0
Survey research	16	15.1	Resource-based view	15	14.2
Secondary data analysis	10	9.4	Institutional theory	5	4.7
Several	7	6.6	Agency theory	3	2.8
Ethnography	3	2.8	Not specified	48	45.3
<b>Total</b>	<b>106</b>	<b>100.0</b>	<b>Total</b>	<b>106</b>	<b>100.0</b>

The most commonly employed research design used in these studies is a literature review, used in 40.6% of articles (Table 4). These LRs respond to the need to classify the growing amount of literature on sustainable business models, sustainable innovation, product innovation, and sustainable leadership. Case study research also accounts for a significant share of articles (25.5%). These case studies aim at providing more in-depth analysis [37]. Unlike literature reviews, they have a close connection with empirical reality, which allows us to the development of testable, relevant, and valid theories [38].

Authors investigate sustainable value using a variety of different theoretical approaches (Table 4). Stakeholder theory (17.0%), ethical theories (16.0%), and resource-based views (14.2%) are the most common. This explains why the most widespread definitions of sustainable value relate to the creation of value for stakeholders (stakeholder theory) or to the efficient use of resources/capitals (resource-based). Ethical theories derive from *Journal of Business Ethics* papers, where sustainable value is used as a general term or in reference to an individual’s ethical standards.

#### 4.2. Usage and Development of the Concept of Sustainable Value

We first analyzed the dynamic over time, looking at the frequency with which the concept of sustainable value is cited, and the role it plays in each paper (Table 5).

**Table 5.** The use of sustainable value: year of publication, appearance and role.

Year of Publication	n	%	N of Appearance	n	%
2008	6	5.7	1	70	66.0
2009	7	6.6	2	16	15.1
2010	9	8.5	3	8	7.5
2011	9	8.5	4	4	3.8
2012	12	11.3	>5	8	7.5
2013	8	7.5	<b>Total</b>	<b>106</b>	<b>100.0</b>
2014	11	10.4	Role of Sustainable Value	n	%
2015	11	10.4	Framework	6	5.7
2016	9	8.5	Variable	5	4.7
2017	9	8.5	Concept to cite	26	24.5
2018	15	14.2	No specific role	69	65.1
<b>Total</b>	<b>106</b>	<b>100.0</b>	<b>Total</b>	<b>106</b>	<b>100.0</b>

There is a growing body of literature which refers to the concept of sustainable value. The number of papers has been stably increasing by 7–15 papers per year, with a higher quantity of papers in more recent years. The final year of our analysis, 2018, was the most productive. Very few papers, however, are devoted to an in-depth analysis of sustainable value. This is shown by the number of appearances of “sustainable value” in the text of the papers. Authors generally use the term infrequently, with most papers (66.0%) mentioning it only once, usually in reference to the outcomes of CSR activities.

The role the concept plays is in line with the aforementioned trend: 65.1% of articles use sustainable value in a very broad sense, to mean everything good, long-lasting, profitable, low-risk, neutral, or positive, connected with society and/or the environment. Nearly a quarter of authors (24.5%) cite sustainable value as a defined concept in their papers, while only 10% of papers treat sustainable value as a framework (5.7%) or variable (4.7%).

All the 106 papers were then classified according to the most relevant management topics (Table 6).

**Table 6.** The use of sustainable value inside the most relevant management topics.

Conceptual Blocks Related to Sustainable Value Management	n	%
1. Sustainability in Environment and Industries	10	9.4
2. Sustainable Strategy and Innovation	38	35.8
3. Sustainable Business models and Supply chains	18	17.0
4. CSR, Performance and Management	40	37.7
<b>Total</b>	<b>106</b>	<b>100.0</b>

The blocks are not equally represented. The largest block is “CSR, Performance and Management” (37.7% of papers) as it is driven by the interest of practitioners to gain the competitive advantage from implementing CSR. The next block by popularity is “Sustainable Strategy and Innovation” (35.8%). Consequently, two most popular blocks cover short-term operational and long-term strategic approach to CSR, which means that CSR is equally implemented at different levels of decision-making in the company. However, the use of the sustainable value concept in the blocks of “Sustainable Business Models and Supply Chains” and “Sustainability in Environment and Industry” is not developed (17.0% and 9.4% respectively) which leads to the fact that the underlying principles and mechanisms of corporate sustainability are not deeply studied. It confirms the call for a more system-thinking approach to CSR and the development of generalized framework for corporate sustainability [23,24].

Supported by these results, the SLR reveals different levels of analysis and conceptual blocks of sustainable value management that could be represented through the integrated view showed below (Figure 2).

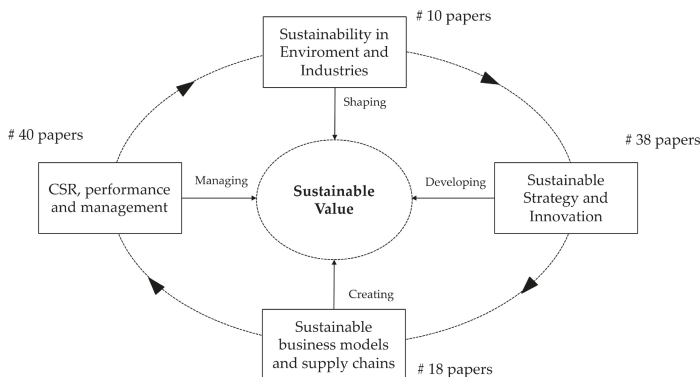

**Figure 2.** Integrated view of sustainable value management.

Firstly, papers dealing with external environment and industry specifications (10 papers) are treating the stakeholder surrounding, which, in turn, determines CSR issues relevant to the company and shapes the way company generates sustainable value for its stakeholders. Such a proposition correlates with the stakeholder model of management theory [39]. The second block includes the papers related to strategic and innovative response to stakeholders’ inquiries (38 papers), which are accepted to be vital for gaining competitive advantage [40,41]. The third block includes the literature related to Sustainable Business Models and Supply Chains (18 papers), able to operationalize the predetermined strategy: describes different archetypes of business models for sustainability [42], searches for the tools to keep the balance between for-profit and social or environmental purposes [43], finds how to establish traceability of the sustainability norms across business partners [44]. The connection between CSR and performance, that is, the fourth block, includes the papers (40 papers) using the sustainable value to investigate how to manage day-to-day CSR activities successfully, how to control the results, how to measure CSR effectiveness and what is the influence of CSR on financial performance.

Moving forward, the analysis of the development of the concept was implemented only for the papers that treated sustainable value as a framework (6 papers), variable (5 papers), or concept (26 papers)—a total of 37 articles—to avoid tangents. Articles were analyzed through the lens of Hart and Milstein’s (2003) framework, using the criteria outlined in the methodology section (Table 7).

Table 7. The development of sustainable value concept: strategic drivers.

Strategic Orientation and Drivers of Sustainable Value	n	%
1. Environmental consequences of industrialization	2	5.4
2. New green technologies	9	24.3
3. Increase in population, poverty and inequity	6	16.2
4. Proliferation and interconnection of civil society stakeholders	12	32.5
5. ND or all drivers together	8	21.6
<b>Total</b>	<b>37</b>	<b>100.0</b>

We see two main trends: a move from internal to external stakeholders, and from short-termism to long-range planning (see Figure 3). Moreover, drivers for sustainability have transformed, becoming more comprehensive and taking the triple bottom-line into account.

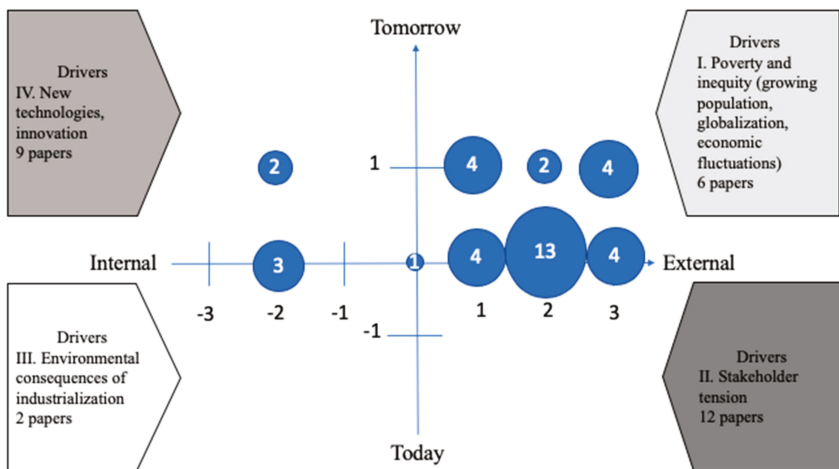

Figure 3. The development of sustainable value concept: spatial and temporal dimensions.

We see a dramatic shift taking place across the spatial dimension, with a palpable shift from an internal to an external conception of value creation. A large share of papers (41%) refer to a wide range of stakeholders. Some authors even talk about the fashionableness of sustainability [45]. Stakeholders are no longer defined solely as parties that influence and/or are influenced by the company; they are society as a whole [46–49]. This even extends as far as labelling the environment a non-human stakeholder [36,50–52].

“Long-term” and “sustainable” are often used synonymously, and we see a rejection of short-termism (0 papers for short-term). Despite this, most authors (68%) describe sustainable value without strict reference to the time period, or state that short as well as long-term results should be taken into account.

Looking at sustainability drivers, a similar dynamic can be traced—again, more significantly along the spatial than the temporal axis. Several factors push companies to include more stakeholders in their value creation model, and to take a longer-term approach. Drivers in the upper (tomorrow) section receive only slightly more attention; however, 15 papers, against 14 in the bottom (today) section. This confirms a certain indifference to the temporal character of sustainable value. As far as the spatial dimension is concerned, movement from the left side of the framework (11 papers) to the right side (18 papers)—from internal to external—is more significant. The classification aside, 21.6% of researchers mention multiple drivers, moving beyond environmental issues to a more comprehensive agenda. This is linked to the increasing value of intangible assets (for example, intellectual capital) in comparison with the tangible [53]. The owners of intangible assets are employees [54]; thus, they become the main driver for adopting sustainability, as well as managers’ commitment to ethical values [53–56]. Consequently, today, topics such as human resources [53,55,56], organizational learning [57,58], and social innovation [59] have become part of the discourse. This compares with the early days of the CSR-movement, in which the focus was trained principally on the environmental consequences of industrialization [60].

## **5. Conclusions, Implications and Future Research**

Assuming the sustainable value as key concept for integrating sustainability issues in the environment, both business strategies and management literature must actively integrate sustainable development into long-established assumptions and frameworks, reframing the theoretical foundations and practice of business [50]. Sustainability is seen as an urgent issue in top-level strategic management journals. A variety of topics are commonly discussed, from sustainable value chains to sustainable innovation, to sustainable strategies, to CSR performance and disclosure. Nevertheless, authors highlight a lack of research explaining the link between CSR and outcomes, a need for multilevel research, and the importance of establishing a standardized definitional framework. We argue that research into sustainable value has the potential to overcome these gaps in the existing literature.

Alongside the theoretical and practical implications of this paper, the concept “sustainable value” is still underdeveloped. This evidence is retrieved by the prevalence of explanatory qualitative studies. Moreover, it has not been updated to reflect the modern sustainability paradigm since Hart and Milstein in 2003. Authors frequently cite the concept without developing it. Hence, our work aimed to chart the usage and development of the concept of sustainable value, as described by Hart and Milstein (2003).

The first result of this research is a measurement of usage of the concept. It has become more popular over time, being mentioned in a greater quantity of research papers in recent years. It has not been analyzed in any sort of depth, however, and is mainly used as a general phrase for describing positive business results and thus, tends to be mentioned only once, at the end of the paper.

The second result is the construction of an integrated view of sustainable value management macro-topics. Research on sustainable value is undertaken at different levels of decision-making in the company, showing the great role of sustainable value concept in management field. Nevertheless, the lack of studies explaining underlying principles and mechanisms of corporate sustainability still exists, and can be solved by further research on sustainable value.

The third result of the research is an analysis of how the concept has developed. As the basis for analysis, Hart and Milstein's (2003) concept was chosen by virtue of its status as by far the most-commonly cited definition and framework. According to Hart and Milstein (2003), relatively few companies established by 2003 were exploiting the opportunities that would come from a focus on outside stakeholders and long-term perspective. Modern scientific research is generally focused on both short-term and long-term value creation for a wide range of internal and external stakeholders. Literature analysis shows that scholars usually do not emphasize the time horizon of sustainable value, or that they equate short-term and long-term profitability/outcomes. The majority of Scholars assume creating sustainable value for a wide range of stakeholders.

Another finding from the research is that sustainable value is increasingly perceived as being derived equally from all three elements of the triple bottom-line. Sustainability drivers are moving from being purely environmental, as per the Hart and Milstein (2003) model: globalization, economic fluctuations, knowledge innovations, etc., are becoming as important as green technologies and carbon reduction policies.

The results of this study make a theoretical contribution to the management literature with the first SLR in this field, and the first literature review on sustainable value. Our literature review on sustainable value may help to overcome the lack in terminological heterogeneity of sustainable value concept by defining the time horizon, stakeholder orientation and topic preferences of sustainable value concept.

From a practical point of view, our research is useful to gain a holistic picture to elaborate and implement sustainable value strategy. Top managers can assess their company's CSR activities using the concept of sustainable value and measure where they stand in relation to recent sustainability trends. Such an analysis may help to build sustainable strategies.

Particularly, the integrated view presented in Figure 2 could be very helpful to gain a holistic understanding and provide a framework to operationalize in practice the main pillars of sustainable value management. The sustainability agenda of external environment and industries shapes the value that the company may create for its stakeholders. Sustainable strategy and innovation for sustainability are determining what is the future value that the company will create and deliver to its stakeholders. Creation of the value is undertaken at the business model and supply chain level. Ongoing CSR management and control ensure day-to-day work on sustainable value generation. The conceptual blocks are linked with a circular flow that can help managers to assure the needed consistency for an integrated and holistic management, keeping the central role of sustainable value.

In terms of future research, while working with a significant body of literature, we identified essential blocks for further analysis. First, there is a lack of empirical studies on sustainable value. This corresponds with the call for empirical studies in different fields of closely related research: value, balance and accountability research; business model research; sustainability innovation, etc. [48,49,61]. Hart states that "[The field needs more] 'future-creative' research that helps us develop the sustainable enterprise practices of tomorrow, and less 'hypothesis-testing' practices from the past, using large-scale data sets" [62]. The second call is to operationalize the concept and find statistical tools and measurable indicators for analyzing model implementation [50,63–65]. Apart from theoretical gaps, there is a gap in our understanding of the role senior managers must play in generating sustainable value [34]. With the beneficiaries of value creation expanded from shareholders to a wider range of external stakeholders, managers' roles increase in significance and complexity. This calls for new approaches, tools, capabilities, and personal skills. Thus, a new approach to sustainable value creation is needed in management.

Concerning the limitations of the research, we can mention that the analysis is limited in the scope to the part of literature on sustainable value available in the journals selected for the SLR.

**Author Contributions:** A.C.: Conceptualization, writing and review; E.K.: data analysis, investigation, and writing the draft; P.T.: methodology, review. All authors have read and agreed to the published version of the manuscript.

**Funding:** This research received no external funding.

**Acknowledgments:** One of the authors (E.K.) is attending the program I.Ph.D.@UNIPG.

**Conflicts of Interest:** The authors declare no conflicts of interest.

## Appendix A

**Table A1.** Existing literature reviews (LRs) on sustainability and related topics.

References	Number of Articles	Topics of the Research
[66–74]	9	Sustainable supply chain
[1,19,20,23–25,27,75,76]	9	Sustainability at large (review and roadmap for future research), including stakeholder theory
[14,77–83]	8	Sustainability-oriented innovation, including eco-innovation
[84–91]	8	Sustainable performance measurement
[92–97]	6	CSR and corporate financial performance
[98–103]	6	Environmental management
[104–108]	5	Disclosure
[43,56,109,110].	4	Sustainable entrepreneurship
[18,42,111]	3	Sustainable business model
[21,26,112]	3	Sustainable strategy
[22,113]	2	CSR standards
[114,115].	2	Industry from sustainability point of view
[116,117].	2	Sustainability drivers in the company
[12,118–120]	4	Other
	71	Total

**Table A2.** Journal list.

No.	Journal Name	Field (from ABS)	Rating (from ABS)
1	Strategic Management Journal	Strategy	5
2	Global Strategy Journal	Strategy	3
3	Long Range Planning	Strategy	3
4	Strategic Organization	Strategy	3
5	Academy of Management Journal	General Management, Ethics, Gender and Social Responsibility	5
6	Academy of Management Review	General Management, Ethics, Gender and Social Responsibility	5
7	Administrative Science Quarterly	General Management, Ethics, Gender and Social Responsibility	5
8	Journal of Management	General Management, Ethics, Gender and Social Responsibility	5
9	Academy of Management Annals	General Management, Ethics, Gender and Social Responsibility	4
10	British Journal of Management	General Management, Ethics, Gender and Social Responsibility	4
11	Business Ethics Quarterly	General Management, Ethics, Gender and Social Responsibility	4
12	Journal of Management Studies	General Management, Ethics, Gender and Social Responsibility	4
13	Academy of Management Perspectives	General Management, Ethics, Gender and Social Responsibility	3



Table A2. Cont.

No.	Journal Name	Field (from ABS)	Rating (from ABS)
14	Business and Society	General Management, Ethics, Gender and Social Responsibility	3
15	California Management Review	General Management, Ethics, Gender and Social Responsibility	3
16	European Management Review	General Management, Ethics, Gender and Social Responsibility	3
17	Gender and Society	General Management, Ethics, Gender and Social Responsibility	3
18	Gender, Work and Organization	General Management, Ethics, Gender and Social Responsibility	3
19	International Journal of Management Reviews	General Management, Ethics, Gender and Social Responsibility	3
20	Journal of Business Ethics	General Management, Ethics, Gender and Social Responsibility	3
21	Journal of Business Research	General Management, Ethics, Gender and Social Responsibility	3
22	Journal of Management Inquiry	General Management, Ethics, Gender and Social Responsibility	3
23	Management Science	Operations Research and Management Science	5
24	Management and Organization Review	International Business and Area Studies	3
25	Management International Review	International Business and Area Studies	3
26	Omega: The International Journal of Management Science	Operations Research and Management Science	3
27	Group and Organization Management	Organisation Studies Regional Studies,	3
28	Business Strategy and The Environment	Planning and Environment	3

## References

- Freeman, R.E.; Phillips, R.; Sisodia, R. Tensions in Stakeholder Theory. *Bus. Soc.* **2018**, *1*–19. [CrossRef]
- Chandler, D. *Strategic Corporate Social Responsibility: Sustainable Value Creation*, 4th ed.; SAGE Publications, Inc.: Los Angeles, CA, USA, 2016; ISBN 978-1-5063-1099-2.
- Hart, S.L.; Milstein, M.B. Creating sustainable value. *AMP* **2003**, *17*, 56–67. [CrossRef]
- Transforming Our World: The 2030 Agenda for Sustainable Development*; Resolution adopted by the General Assembly on 25 September 2015; United Nations: New York, NY, USA, 2015; Available online: [http://www.un.org/ga/search/view\\_doc.asp?symbol=A/RES/70/1&Lang=E](http://www.un.org/ga/search/view_doc.asp?symbol=A/RES/70/1&Lang=E) (accessed on 11 December 2019).
- Heyzer, N. The Impact of the Financial and Economic Crisis on Sustainable Development, Particularly their Social Implications. *ECOSOC*. 2011. Available online: <https://www.unescap.org/speeches/impact-financial-and-economic-crisis-sustainable-development-particularly-their-social> (accessed on 11 December 2019).
- Giannarakis, G.; Theotokas, I. The Effect of Financial Crisis in Corporate Social Responsibility Performance. *IJMS* **2011**, *3*, 2. [CrossRef]
- Kagermann, H. Change Through Digitization—Value Creation in the Age of Industry 4.0. In *Management of Permanent Change*; Albach, H., Meffert, H., Pinkwart, A., Reichwald, R., Eds.; Springer Fachmedien: Wiesbaden, Germany, 2015; pp. 23–45. ISBN 978-3-658-05014-6.
- The Future of Corporate Reporting—Creating the Dynamics for Change*; Cogito Series; Federation of European Accountants FEE: Brussels, Belgium, 2015; Available online: [https://www.accountancyeurope.eu/wp-content/uploads/FEECogitoPaper\\_-\\_TheFutureofCorporateReporting.pdf](https://www.accountancyeurope.eu/wp-content/uploads/FEECogitoPaper_-_TheFutureofCorporateReporting.pdf) (accessed on 11 December 2019).
- Massaro, M.; Dumay, J.; Guthrie, J. On the shoulders of giants: Undertaking a structured literature review in accounting. *Account. Aud. Account. J.* **2016**, *29*, 767–801. [CrossRef]

10. Porter, M.E.; Kramer, M.R. The Big Idea: Creating Shared Value. How to Reinvent Capitalism. *Harv. Bus. Rev.* **2011**, *89*, 62–77.
11. Crane, A.; Palazzo, G.; Spence, L.J.; Matten, D. Contesting the Value of “Creating Shared Value”. *Calif. Manag. Rev.* **2014**, *56*, 130–153. [CrossRef]
12. Dembek, K.; Singh, P.; Bhakoo, V. Literature Review of Shared Value: A Theoretical Concept or a Management Buzzword? *J. Bus. Eth.* **2016**, *137*, 231–267. [CrossRef]
13. Wheeler, D.; Colbert, B.; Freeman, R.E. Focusing on Value: Reconciling Corporate Social Responsibility, Sustainability and a Stakeholder Approach in a Network World. *J. Gen. Manag.* **2003**, *30*, 1–28. [CrossRef]
14. Adams, R.; Jeanrenaud, S.; Bessant, J.; Denyer, D.; Overy, P. Sustainability-oriented Innovation: A Systematic Review: Sustainability-oriented Innovation. *Int. J. Manag. Rev.* **2016**, *18*, 180–205. [CrossRef]
15. Figge, F.; Hahn, T. The Cost of Sustainability Capital and the Creation of Sustainable Value by Companies. *J. Ind. Ecol.* **2005**, *9*, 47–58. [CrossRef]
16. Beattie, V.; Smith, S.J. Value creation and business models: Refocusing the intellectual capital debate. *Br. Account. Rev.* **2013**, *45*, 243–254. [CrossRef]
17. Bocken, N.M.P.; Rana, P.; Short, S.W. Value mapping for sustainable business thinking. *J. Ind. Prod. Eng.* **2015**, *32*, 67–81. [CrossRef]
18. Pieroni, M.P.P.; McAloone, T.C.; Pigosso, D.C.A. Business model innovation for circular economy and sustainability: A review of approaches. *J. Clean. Prod.* **2019**, *215*, 198–216. [CrossRef]
19. Williams, A.; Kennedy, S.; Philipp, F.; Whiteman, G. Systems thinking: A review of sustainability management research. *J. Clean. Prod.* **2017**, *148*, 866–881. [CrossRef]
20. Frynas, J.G.; Yamahaki, C. Corporate social responsibility: Review and roadmap of theoretical perspectives. *Bus. Eth. A Eur. Rev.* **2016**, *25*, 258–285. [CrossRef]
21. Ortiz-Avram, D.; Domnanovich, J.; Kronenberg, C.; Scholz, M. Exploring the integration of corporate social responsibility into the strategies of small- and medium-sized enterprises: A systematic literature review. *J. Clean. Prod.* **2018**, *201*, 254–271. [CrossRef]
22. Tröster, R.; Hiete, M. Success of voluntary sustainability certification schemes—A comprehensive review. *J. Clean. Prod.* **2018**, *196*, 1034–1043. [CrossRef]
23. Aguinis, H.; Glavas, A. What We Know and Don’t Know About Corporate Social Responsibility: A Review and Research Agenda. *J. Manag.* **2012**, *38*, 932–968. [CrossRef]
24. Griffin, J.J. Tracing stakeholder terminology then and now: Convergence and new pathways. *Bus. Eth. Eur. Rev.* **2017**, *26*, 326–346. [CrossRef]
25. Latapí Agudelo, M.A.; Jóhannsdóttir, L.; Davídsdóttir, B. A literature review of the history and evolution of corporate social responsibility. *Int. J. Corp. Soc. Responsib.* **2019**, *4*, 1–23. [CrossRef]
26. Orlitzky, M.; Siegel, D.S.; Waldman, D.A. Strategic Corporate Social Responsibility and Environmental Sustainability. *Bus. Soc.* **2011**, *50*, 6–27. [CrossRef]
27. Taneja, S.S.; Taneja, P.K.; Gupta, R.K. Researches in Corporate Social Responsibility: A Review of Shifting Focus, Paradigms, and Methodologies. *J. Bus. Eth.* **2011**, *101*, 343–364. [CrossRef]
28. Lepak, D.P.; Smith, K.G.; Taylor, M.S. Value Creation and Value Capture: A Multilevel Perspective. *AMR* **2007**, *32*, 180–194. [CrossRef]
29. Denyer, D.; Tranfield, D. Producing a systematic review. In *The Sage Handbook of Organizational Research Methods*; Buchanan, D., Bryman, A., Eds.; Sage: London, UK, 2009; pp. 671–689.
30. Tranfield, D.; Denyer, D.; Smart, P. Towards a methodology for developing evidence-informed management knowledge by means of systematic review. *Br. J. Manag.* **2003**, *14*, 207–222. [CrossRef]
31. Dumay, J.; Bernardi, C.; Guthrie, J.; Demartini, P. Integrated reporting: A structured literature review. *Account. Forum* **2016**, *40*, 166–185. [CrossRef]
32. Chartered Association of Business Schools. Available online: <https://charteredabs.org/academic-journal-guide-2018/> (accessed on 27 October 2019).
33. Bhattacharjee, A. *Social Science Research Principles, Methods and Practices*; Creative Commons Attribution 3.0 License: Leipzig, Germany, 2012; ISBN 978-1-4751-4612-7.
34. Tantalo, C.; Priem, R.L. Value creation through stakeholder synergy: Stakeholder Synergy. *Strateg. Manag. J.* **2016**, *37*, 314–329. [CrossRef]
35. Crilly, D.; Sloan, P. Enterprise logic: Explaining corporate attention to stakeholders from the ‘inside-out’. *Strateg. Manag. J.* **2012**, *33*, 1174–1193. [CrossRef]

36. Laasch, O. Beyond the purely commercial business model: Organizational value logics and the heterogeneity of sustainability business models. *Long Range Plan.* **2018**, *51*, 158–183. [CrossRef]
37. Yin, R.K. *The Case Study Anthology*; Sage: Thousand Oaks, CA, USA, 2004; ISBN 978-0-7619-2926-0.
38. Eisenhardt, K.M. Building Theories from Case Study Research. *Acad. Manag. Rev.* **1989**, *14*, 532–550. [CrossRef]
39. Edward Freeman, R.; Harris, J.D. Creating Ties That Bind. *J. Bus. Eth.* **2009**, *88*, 685–692. [CrossRef]
40. Ioannou, I.; Serafeim, G. Corporate Sustainability: A Strategy? *SSRN J.* **2019**. [CrossRef]
41. Porter, M.E.; Kramer, M.R. Strategy and society: The link between competitive advantage and corporate social responsibility. *HBR* **2006**, *23*, 76–94.
42. Geissdoerfer, M.; Vladimirova, D.; Evans, S. Sustainable business model innovation: A review. *J. Clean. Prod.* **2018**, *198*, 401–416. [CrossRef]
43. Muñoz, P.; Cohen, B. Sustainable Entrepreneurship Research: Taking Stock and looking ahead. *Bus. Strategy Environ.* **2018**, *27*, 300–322. [CrossRef]
44. Taticchi, P.; Tonelli, F.; Pasqualino, R. Performance measurement of sustainable supply chains: A literature review and a research agenda. *Int. J. Product. Perform. Manag.* **2013**, *62*, 782–804. [CrossRef]
45. Gond, J.-P.; Igalens, J.; Swaen, V.; El Akremi, A. The Human Resources Contribution to Responsible Leadership: An Exploration of the CSR–HR Interface. *J. Bus. Eth.* **2011**, *98*, 115–132. [CrossRef]
46. Boulouta, I.; Pitelis, C.N. Who Needs CSR? The Impact of Corporate Social Responsibility on National Competitiveness. *J. Bus. Eth.* **2014**, *119*, 349–364. [CrossRef]
47. Brennan, G.; Tennant, M. Sustainable value and trade-offs: Exploring situational logics and power relations in a UK brewery's malt supply network business model. *Bus. Strategy Environ.* **2018**, *27*, 621–630. [CrossRef]
48. O'Riordan, L.; Fairbrass, J. Managing CSR Stakeholder Engagement: A New Conceptual Framework. *J. Bus. Eth.* **2014**, *125*, 121–145. [CrossRef]
49. Schwartz, M.S.; Carroll, A.B. Integrating and Unifying Competing and Complementary Frameworks: The Search for a Common Core in the Business and Society Field. *Bus. Soc.* **2008**, *47*, 148–186. [CrossRef]
50. Evans, S.; Vladimirova, D.; Holgado, M.; Van Fossen, K.; Yang, M.; Silva, E.A.; Barlow, C.Y. Business Model Innovation for Sustainability: Towards a Unified Perspective for Creation of Sustainable Business Models. *Bus. Strategy Environ.* **2017**, *26*, 597–608. [CrossRef]
51. Panapanaan, V.; Bruce, T.; Virkki-Hatakka, T.; Linnanen, L. Analysis of Shared and Sustainable Value Creation of Companies Providing Energy Solutions at the Base of the Pyramid (BoP): SSVc by Energy Enterprises. *Bus. Strategy Environ.* **2016**, *25*, 293–309. [CrossRef]
52. Pedersen, E.R.G.; Gwozdz, W.; Hvass, K.K. Exploring the Relationship Between Business Model Innovation, Corporate Sustainability, and Organisational Values within the Fashion Industry. *J. Bus. Eth.* **2018**, *149*, 267–284. [CrossRef]
53. López-Gamero, M.D.; Zaragoza-Sáez, P.; Claver-Cortés, E.; Molina-Azorin, J.F. Sustainable development and intangibles: Building sustainable intellectual capital. *Bus. Strategy Environ.* **2011**, *20*, 18–37. [CrossRef]
54. Rajan, R.G.; Zingales, L. *The Governance of the New Enterprise*; NBER Working Paper Series, No. 7598; NBER: Cambridge, MA, USA, 2000; Available online: [https://papers.ssrn.com/sol3/papers.cfm?abstract\\_id=245587](https://papers.ssrn.com/sol3/papers.cfm?abstract_id=245587) (accessed on 11 December 2019).
55. Eberhardt-Toth, E.; Wasieleski, D.M. A Cognitive Elaboration Model of Sustainability Decision Making: Investigating Financial Managers' Orientation Toward Environmental Issues. *J. Bus. Eth.* **2013**, *117*, 735–751. [CrossRef]
56. Saebi, T.; Foss, N.J.; Linder, S. Social Entrepreneurship Research: Past Achievements and Future Promises. *J. Manag.* **2019**, *45*, 70–95. [CrossRef]
57. Chen, H.; Lee, P.; Lay, T. Drivers of dynamic learning and dynamic competitive capabilities in international strategic alliances. *J. Bus. Res.* **2009**, *62*, 1289–1295. [CrossRef]
58. Le Pennec, M.; Raufflet, E. Value Creation in Inter-Organizational Collaboration: An Empirical Study. *J. Bus. Eth.* **2018**, *148*, 817–834. [CrossRef]
59. Phillips, W.; Lee, H.; Ghobadian, A.; O'Regan, N.; James, P. Social Innovation and Social Entrepreneurship: A Systematic Review. *Group Organ. Manag.* **2015**, *40*, 428–461. [CrossRef]
60. Asif, M.; Searcy, C.; Zutshi, A.; Ahmad, N. An integrated management systems approach to corporate sustainability. *Eur. Bus. Rev.* **2011**, *23*, 353–367. [CrossRef]

61. Cassimon, D.; Engelen, P.-J.; Van Liedekerke, L. When do Firms Invest in Corporate Social Responsibility? A Real Option Framework. *J. Bus. Eth.* **2016**, *137*, 15–29. [\[CrossRef\]](#)
62. Sharma, A.; Lee, M.-D.P. Sustainable Global Enterprise: Perspectives of Stuart Hart, Ans Kolk, Sanjay Sharma, and Sandra Waddock. *J. Manag. Inq.* **2012**, *21*, 161–178. [\[CrossRef\]](#)
63. Cubas-Díaz, M.; Martínez Sedano, M.Á. Measures for Sustainable Investment Decisions and Business Strategy—A Triple Bottom Line Approach. *Bus. Strategy Environ.* **2018**, *27*, 16–38. [\[CrossRef\]](#)
64. Goranova, M.; Abouk, R.; Nystrom, P.C.; Soofi, E.S. Corporate governance antecedents to shareholder activism: A zero-inflated process: Corporate Governance Antecedents to Shareholder Activism. *Strateg. Manag. J.* **2017**, *38*, 415–435. [\[CrossRef\]](#)
65. Kleine, A.; von Hauff, M. Sustainability-Driven Implementation of Corporate Social Responsibility: Application of the Integrative Sustainability Triangle. *J. Bus. Eth.* **2009**, *85*, 517–533. [\[CrossRef\]](#)
66. Gold, S.; Seuring, S.; Beske, P. Sustainable supply chain management and inter-organizational resources: A literature review. *Corp. Soc. Responsib. Environ. Manag.* **2010**, *17*, 230–245. [\[CrossRef\]](#)
67. Rajeev, A.; Pati, R.K.; Padhi, S.S.; Govindan, K. Evolution of sustainability in supply chain management: A literature review. *J. Clean. Prod.* **2017**, *162*, 299–314. [\[CrossRef\]](#)
68. Gao, D.; Xu, Z.; Ruan, Y.Z.; Lu, H. From a systematic literature review to integrated definition for sustainable supply chain innovation (SSCI). *J. Clean. Prod.* **2017**, *142*, 1518–1538. [\[CrossRef\]](#)
69. Feng, Y.; Zhu, Q.; Lai, K.-H. Corporate social responsibility for supply chain management: A literature review and bibliometric analysis. *J. Clean. Prod.* **2017**, *158*, 296–307. [\[CrossRef\]](#)
70. De Oliveira, U.R.; Espindola, L.S.; da Silva, I.R.; da Silva, I.N.; Rocha, H.M. A systematic literature review on green supply chain management: Research implications and future perspectives. *J. Clean. Prod.* **2018**, *187*, 537–561. [\[CrossRef\]](#)
71. Ciccullo, F.; Pero, M.; Caridi, M.; Gosling, J.; Purvis, L. Integrating the environmental and social sustainability pillars into the lean and agile supply chain management paradigms: A literature review and future research directions. *J. Clean. Prod.* **2018**, *172*, 2336–2350. [\[CrossRef\]](#)
72. Martins, C.L.; Pato, M.V. Supply chain sustainability: A tertiary literature review. *J. Clean. Prod.* **2019**, *225*, 995–1016. [\[CrossRef\]](#)
73. Farooque, M.; Zhang, A.; Thurer, M.; Qu, T.; Huisingh, D. Circular supply chain management: A definition and structured literature review. *J. Clean. Prod.* **2019**, *228*, 82–900. [\[CrossRef\]](#)
74. Koberg, E.; Longoni, A. A systematic review of sustainable supply chain management in global supply chains. *J. Clean. Prod.* **2019**, *207*, 1084–1098. [\[CrossRef\]](#)
75. White, C.L.; Nielsen, A.E.; Valentini, C. CSR research in the apparel industry: A quantitative and qualitative review of existing literature. *Corp. Soc. Responsib. Environ. Manag.* **2017**, *24*, 382–394. [\[CrossRef\]](#)
76. Isil, O.; Hernke, M.T. The Triple Bottom Line: A Critical Review from a Transdisciplinary Perspective. *Bus. Strategy Environ.* **2017**, *26*, 1235–1251. [\[CrossRef\]](#)
77. Szutowski, D.; Ratajczak, P. Exploring the relationship between CSR and innovation. *Sustainability* **2016**, *7*, 295–318.
78. Klewitz, J.; Hansen, E.G. Sustainability-oriented innovation of SMEs: A systematic review. *J. Clean. Prod.* **2014**, *65*, 57–75. [\[CrossRef\]](#)
79. Fu, Y.; Kok, R.A.W.; Dankbaar, B.; Ligthart, P.E.M.; van Riel, A.C.R. Factors affecting sustainable process technology adoption: A systematic literature review. *J. Clean. Prod.* **2018**, *205*, 226–251. [\[CrossRef\]](#)
80. Bossle, M.B.; Dutra de Barcellos, M.; Vieira, L.M.; Sauvée, L. The drivers for adoption of eco-innovation. *J. Clean. Prod.* **2016**, *113*, 861–872. [\[CrossRef\]](#)
81. Xavier, A.F.; Naveiro, R.M.; Aoussat, A.; Reyes, T. Systematic literature review of eco-innovation models: Opportunities and recommendations for future research. *J. Clean. Prod.* **2017**, *149*, 1278–1302. [\[CrossRef\]](#)
82. Salim, N.; Ab Rahman, M.N.; Abd Wahab, D. A systematic literature review of internal capabilities for enhancing eco-innovation performance of manufacturing firms. *J. Clean. Prod.* **2019**, *209*, 1445–1460. [\[CrossRef\]](#)
83. Pham, D.D.T.; Paillé, P.; Halilem, N. Systematic review on environmental innovativeness: A knowledge-based resource view. *J. Clean. Prod.* **2019**, *211*, 1088–1099. [\[CrossRef\]](#)
84. Mura, M.; Longo, M.; Micheli, P.; Bolzani, D. The Evolution of Sustainability Measurement Research. *Int. J. Manag. Rev.* **2018**, *20*, 661–695. [\[CrossRef\]](#)

85. Searcy, C. Corporate Sustainability Performance Measurement Systems: A Review and Research Agenda. *J. Bus. Eth.* **2012**, *107*, 239–253. [[CrossRef](#)]
86. Hansen, E.G.; Schaltegger, S. The Sustainability Balanced Scorecard: A Systematic Review of Architectures. *J. Bus. Eth.* **2016**, *133*, 193–221. [[CrossRef](#)]
87. Ahi, P.; Searcy, C. An analysis of metrics used to measure performance in green and sustainable supply chains. *J. Clean. Prod.* **2015**, *86*, 360–377. [[CrossRef](#)]
88. Rahdari, A.H.; Anvary Rostamy, A.A. Designing a general set of sustainability indicators at the corporate level. *J. Clean. Prod.* **2015**, *108*, 757–771. [[CrossRef](#)]
89. Kühnen, M.; Hahn, R. Systemic social performance measurement: Systematic literature review and explanations on the academic status quo from a product life-cycle perspective. *J. Clean. Prod.* **2018**, *205*, 690–705. [[CrossRef](#)]
90. Dragomir, V.D. How do we measure corporate environmental performance? A critical review. *J. Clean. Prod.* **2018**, *196*, 1124–1157. [[CrossRef](#)]
91. Silva, S.; Nuzum, A.-K.; Schaltegger, S. Stakeholder expectations on sustainability performance measurement and assessment. A systematic literature review. *J. Clean. Prod.* **2019**, *217*, 204–215. [[CrossRef](#)]
92. Rost, K.; Ehrmann, T. Reporting Biases in Empirical Management Research: The Example of Win-Win Corporate Social Responsibility. *Bus. Soc.* **2017**, *56*, 840–888. [[CrossRef](#)]
93. Mattingly, J.E. Corporate Social Performance: A Review of Empirical Research Examining the Corporation–Society Relationship Using Kinder, Lydenberg, Domini Social Ratings Data. *Bus. Soc.* **2017**, *56*, 796–839.
94. Faller, C.M.; zu Knyphausen-Aufseß, D. Does Equity Ownership Matter for Corporate Social Responsibility? A Literature Review of Theories and Recent Empirical Findings. *J. Bus. Eth.* **2018**, *150*, 15–40. [[CrossRef](#)]
95. Grewatsch, S.; Kleindienst, I. When Does It Pay to be Good? Moderators and Mediators in the Corporate Sustainability–Corporate Financial Performance Relationship: A Critical Review. *J. Bus. Eth.* **2017**, *145*, 383–416. [[CrossRef](#)]
96. Hinze, A.-K.; Sump, F. Corporate social responsibility and financial analysts: A review of the literature. *Sustainability* **2019**, *10*, 183–207. [[CrossRef](#)]
97. Wood, D.J.; Logsdon, J.M. Social Issues in Management as a Distinct Field: Corporate Social Responsibility and Performance. *Bus. Soc.* **2016**. [[CrossRef](#)]
98. Daddi, T.; Todaro, N.M.; Giacomo, M.R.D.; Frey, M. A Systematic Review of the Use of Organization and Management Theories in Climate Change Studies. *Bus. Strategy Environ.* **2018**, *27*, 456–474.
99. Rotzek, J.N.; Scope, C.; Günther, E. What energy management practice can learn from research on energy culture? *Sustain. Account. Manag. Policy J.* **2018**. [[CrossRef](#)]
100. May, G.; Stahl, B.; Taisch, M.; Kiritsis, D. Energy management in manufacturing: From literature review to a conceptual framework. *J. Clean. Prod.* **2017**, *167*, 1464–1489.
101. Slowak, A.P.; Taticchi, P. Technology, policy and management for carbon reduction: A critical and global review with insights on the role played by the Chinese Academy. *J. Clean. Prod.* **2015**, *103*, 601–619. [[CrossRef](#)]
102. Bartolini, M.; Bottani, E.; Grosse, E.H. Green warehousing: Systematic literature review and bibliometric analysis. *J. Clean. Prod.* **2019**, *226*, 242–258. [[CrossRef](#)]
103. Tuokuu, F.X.D.; Idemudia, U.; Gruber, J.S.; Kayira, J. Identifying and clarifying environmental policy best practices for the mining industry—A systematic review. *J. Clean. Prod.* **2019**, *222*, 922–933. [[CrossRef](#)]
104. Dienes, D.; Sassen, R.; Fischer, J. What are the drivers of sustainability reporting? A systematic review. *Sustainability* **2016**, *7*, 154–189. [[CrossRef](#)]
105. Asif, M.; Searcy, C.; dos Santos, P.; Kensah, D. A Review of Dutch Corporate Sustainable Development Reports: Trends in Dutch sustainability reporting. *Corp. Soc. Responsib. Environ. Manag.* **2013**, *20*, 321–339.
106. Vitolla, F.; Raimo, N.; Rubino, M. Appreciations, criticisms, determinants, and effects of integrated reporting: A systematic literature review. *Corp. Soc. Responsib. Environ. Manag.* **2019**, *26*, 518–528.
107. Ali, W.; Frynas, J.G.; Mahmood, Z. Determinants of Corporate Social Responsibility (CSR) Disclosure in Developed and Developing Countries: A Literature Review. *Corp. Soc. Responsib. Environ. Manag.* **2017**, *24*, 273–294. [[CrossRef](#)]
108. Fifka, M.S. Corporate Responsibility Reporting and its Determinants in Comparative Perspective—A Review of the Empirical Literature and a Meta-analysis. *Bus. Strategy Environ.* **2013**, *22*, 1–35.

109. Tiba, S.; Rijnsoever, F.J.; van Hekkert, M.P. Firms with benefits: A systematic review of responsible entrepreneurship and corporate social responsibility literature. *Corp. Soc. Responsib. Environ. Manag.* **2019**, *26*, 265–284.
110. Gast, J.; Gundolf, K.; Cesinger, B. Doing business in a green way: A systematic review of the ecological sustainability entrepreneurship literature and future research directions. *J. Clean. Prod.* **2017**, *147*, 44–56. [[CrossRef](#)]
111. Bocken, N.M.P.; Short, S.W.; Rana, P.; Evans, S. A literature and practice review to develop sustainable business model archetypes. *J. Clean. Prod.* **2014**, *65*, 42–56.
112. Nave, A.; Ferreira, J. Corporate social responsibility strategies: Past research and future challenges. *Corp. Soc. Responsib. Environ. Manag.* **2019**. [[CrossRef](#)]
113. Liston-Heyes, C.; Heyes, A. Is There Evidence for Export-Led Adoption of ISO 14001? A Review of the Literature Using Meta-Regression. *Bus. Soc.* **2019**. [[CrossRef](#)]
114. García-Pérez, I.; Muñoz-Torres, M.-J.; Fernández-Izquierdo, M.-Á. Microfinance literature: A sustainability level perspective survey. *J. Clean. Prod.* **2017**, *142*, 3382–3395.
115. Rodrigues, M.; Mendes, L. Mapping of the literature on social responsibility in the mining industry: A systematic literature review. *J. Clean. Prod.* **2018**, *181*, 88–101. [[CrossRef](#)]
116. Broccardo, L.; Truant, E.; Zicari, A. Internal corporate sustainability drivers: What evidence from family firms? A literature review and research agenda. *Corp. Soc. Responsib. Environ. Manag.* **2019**, *26*, 1–18.
117. González-Benito, J.; González-Benito, Ó. A review of determinant factors of environmental proactivity. *Bus. Strategy Environ.* **2006**, *15*, 87–102.
118. Jaramillo, J.Á.; Sossa, J.W.Z.; Mendoza, G.L.O. Barriers to sustainability for small and medium enterprises in the framework of sustainable development—Literature review. *Bus. Strategy Environ.* **2019**, *28*, 512–524.
119. Orzes, G.; Moretto, A.M.; Ebrahimpour, M.; Sartor, M.; Moro, M.; Rossi, M. United Nations Global Compact: Literature review and theory-based research agenda. *J. Clean. Prod.* **2018**, *177*, 633–654.
120. Zarte, M.; Pechmann, A.; Nunes, I.L. Decision support systems for sustainable manufacturing surrounding the product and production life cycle—A literature review. *J. Clean. Prod.* **2019**, *219*, 336–349. [[CrossRef](#)]



© 2020 by the authors. Licensee MDPI, Basel, Switzerland. This article is an open access article distributed under the terms and conditions of the Creative Commons Attribution (CC BY) license (<http://creativecommons.org/licenses/by/4.0/>).

Article

# Risk Management Opportunities between Socially Responsible Investments and Selected Commodities

Daniel Cupriak, Katarzyna Kuziak \* and Tomasz Popczyk

Department of Financial Investments and Risk Management, Wrocław University of Economics and Business, 53-345 Wrocław, Poland; 165524@student.ue.wroc.pl (D.C.); 165660@student.ue.wroc.pl (T.P.)

\* Correspondence: katarzyna.kuziak@ue.wroc.pl

Received: 30 January 2020; Accepted: 2 March 2020; Published: 5 March 2020

**Abstract:** Socially responsible investing (SRI) or sustainable, responsible, and impact investing is growing fast. The net total of SRI assets at the beginning of 2018 was USD 12.0 trillion. There is extensive literature on SRI, but very little of it relates to portfolio construction and risk management combining SRI and commodities. In this paper, the authors pay attention to model volatility and dynamic conditional correlations between SRI investment and selected representative of commodities. We state the following hypothesis: the potential to create portfolio and risk management opportunities exists between SRI and commodities such as grain, precious metals, and industrial metals. To verify this, modeling of volatility and dynamic conditional correlation (DCC) between pair of elements is necessary. Empirical research conducted for the global market based on selected indices for SRI and commodities confirms this hypothesis. These results can improve asset selection in portfolio construction and allow investors to make more reasonable decisions.

**Keywords:** socially responsible investing (SRI), sustainable; responsible and impact (SRI) investing; DCC; GARCH; risk diversification

---

## 1. Introduction

Socially responsible investing (SRI) has become increasingly popular over the past decade. Sustainable and impact investing in the United States continues to grow and to make a difference. Investors now consider environmental, social, and governance (ESG) factors across USD 12 trillion worth of professionally managed assets. Compared to value of USD 639 billion in 1995 (when the US SIF Foundation first measured the size of the US sustainable and responsible investment universe), these assets have increased more than 18-times with a compound annual growth rate of 13.6 percent [1].

Socially responsible investing started to grow during the 1960s among the rising concerns about equality and the ongoing war. Within the next decades, as new social problems arose, the definition of social responsibility has been expanded to include human rights, global warming, working conditions, and environmental protection [2]. The selection of SRI assets may occur either through positive or negative screening [3]. The first is based on rating stocks by various criteria (e.g., CO<sub>2</sub> emission, energy reduction target, percentage of women on the board, percentage of independent directors, strict policies against child labor), and then selecting companies with the highest scores. Investors may also apply a balance across sectors. Contrastingly, negative screening simply excludes controversial sectors (e.g., coal mining, alcohol, tobacco, gambling, military).

The theoretical approach shows that although socially responsible behavior does not maximize the present value of cash flows, it maximizes the market value of the firm. This phenomenon occurs with investors having maximization interests other than wealth, causing an imbalance in demand and supply of SRI. Incorrect timing of employing SRI might also reduce market value [4]. Market-based research leads to the opposite conclusions. Applying an ESG screen to a stock portfolio provides high returns of up to 8.7% yearly. The best effect is obtained by avoiding both extremely high and extremely

low ESG scores while applying various screens and the best-in-class approach [3]. Another paper investigating the influence of ESG screens on investment performance shows that in the United States and Asia-Pacific region, choosing companies with high or low ESG scores does not affect the rates of return, whereas in Europe, picking socially responsible companies leads to lower rates of return [5].

In this paper, SRI is classified as a traditional investment (like investing in common stocks), as opposed to alternative ones. Such investments may include, e.g., private equity or venture capital, real estate, commodities, art and antiques, distressed securities, and hedge funds. Despite the unique risks, alternative investments can be useful tools to improve the risk-return characteristics of an investment portfolio. Generally, alternative investments may have higher volatility than traditional investments, and they typically have low correlations with conventional asset classes. Furthermore, the specific benefit of investing in alternatives is the increased portfolio diversification and enhanced returns. However alternative investments do not have some of the same investment constraints and they have the potential for higher long-term performance compared to traditional investments. Therefore, including them in an investment portfolio results in lower volatility and a higher rate of return. In this sense, alternative investments are important in risk management, especially in the area of risk reduction.

Some authors take socially responsible investment as part of portfolio construction [6,7]. Markowitz [8] developed the mean-variance framework, which is used in calculation of a portfolio's risk, but also in its risk optimization. To calculate the risk of a portfolio, standard deviations and pairwise correlations are necessary (they are the elements of covariance construction). Nonetheless, unconditional standard deviations and constant correlations used to estimate the covariance matrix are questionable. Yet, the time-varying variances and correlations proposed by Engle [9] and GARCH(1,1), introduced by Bollerslev [10], solve this problem. The problem of constant correlation was also solved by the dynamic conditional correlation—GARCH (DCC–GARCH) proposed by Engle [11].

Because commodities have shown low or even negative correlation with equities, they are useful in hedging and portfolio diversification. Ibbotson Associates [12] found that including commodities in the portfolio opportunity set results in an increased efficient frontier. This supports the hypothesis that investing in different asset classes is desirable to diversify risk and finally leads to its reduction. This brings up an interesting question regarding what risk management opportunities exist between the SRI and popular commodities like metals and grain. Answers to this can help investors make more informed investment decisions.

The remainder of the paper is organized as follows: Section 2 presents the literature review and develops the research hypothesis, Section 3 outlines the methods and data, Section 4 discusses the findings, and the last section comprises the conclusions.

## **2. Literature Review**

This section presents a short literature review of papers that focus directly on the volatility dynamics between SRI and other commodities like grain and metals.

Typical investors focus on the optimal risk-return portfolio through constantly analyzing information and using diversification, finally making the market more efficient. However, there has been little attention paid to the impact of their behavior on society. For a sustainable economy, there is a need to invest in assets that compromise social and environmental stability. Sustainable investment means the integration of environmental, social, and governance factors in the investment decision-making process [13]. Markowitz portfolio theory does not take into consideration the role played by the investment community in managing global risks. It uses risk and return as sole criteria, with the assumption that investors are rational and seek the highest return at the lowest level of risk [8]. However, research has shown that ethical (socially responsible) investors are willing to give up a portion of their financial returns for the increased utility provided by investments in assets that increase the social and environmental stability [14,15]. Moreover, various studies have highlighted better rates of return and reduced risk for socially responsible investments [16–19]. SRI aims at long-term rates of



return by investing in companies that meet certain baseline standards of ESG responsibilities. Beal, Goyen, and Phillips consider three potential motives for SRI—superior financial returns, non-wealth returns, and social change. These motivations are neither exclusive nor exhaustive. In their proposal, an additional argument called the ‘degree of ethicalness’ must be inserted into the utility function of the investment [20]. Therefore, the classical portfolio theory may be inadequate for making socially responsible investments, and there is a need to search for other solutions.

There is a lot of literature which compares SRI and conventional investments. Some researchers confirmed no statistically significant difference [21–23] between the risk-adjusted return of SRI and conventional investments, while others proved similarities [24]. The correlations between SRI indices and conventional indices are high [25].

On the other hand, many authors study whether including commodities in a portfolio really improves the diversification effect and, finally, the risk-return performance. Some papers, such as Skiadopoulos [26], investigate this topic. Most papers empirically confirmed the existence of diversification benefit [27–29], while others drew different conclusions [30–33].

There is very little research on the volatility dynamics of socially responsible investments and correlations between the stock prices of socially responsible companies and commodities like grain, precious metals, and industrial metals. Sadorsky [34] investigated volatility and correlations between DJSI, S&P 500, and two commodities: gold and oil. His findings indicate, from a risk management perspective, that SRI offers very similar results in terms of dynamic correlations, hedge ratios, and optimal portfolio weights as investing in the S&P 500.

Hoti et al. [35,36] empirically analyze the conditional volatility (conditional variance) associated with investing in ESG companies. They estimate univariate GARCH(1,1) models to model time-varying risks for a number of different ESG indices and find that GARCH(1,1) models adequately capture the volatility dynamics in ESG indices. They find strong evidence of volatility clustering, with both short- and long-run persistence of shocks to the index rates of return. However, they do not investigate the dynamic correlation between the ESG indices and other assets.

In this paper, the following hypothesis was tested: risk management opportunities exist between the SRI and commodities such as grain, precious metals, and industrial metals.

The paper contributes to the literature in two areas. Firstly, it provides an extension to a number of indices—regional, global socially responsible, and commodity indices (grain, precious and industrial metals)—by taking into account current events in modeling volatility and dynamic conditional correlations. Table A1 (Appendix A) describes the indices selected for empirical investigation. Secondly, the paper fills the existing gap in the studies combining SRI and grain or industrial metals. To refine our analysis, we show how correlations evolved during the observed period. To this effect, we use the dynamic conditional correlation method (DCC–GARCH) developed by Engle [11] and its extension, the copula–DCC–GARCH approach.

Analysis of the states of the sustainable investments and commodity market based on the conditional dependence structure using DCC–GARCH and the copula–DCC–GARCH methodology allows addressing the question of whether the dependence between sustainable investments and commodity market is stable or if it undergoes changes.

### **3. Materials and Methods**

In this paper, a GARCH model is used to model volatility and dynamic conditional correlations between a stock price index comprised of socially responsible companies and the grain index, precious metals index, and industrial metals index. Following the research of Sadorsky [34], who found that the dynamic conditional correlation model fits the data best, this model is also used in this paper to verify the potential of portfolio diversification.

Two-stage empirical research was necessary to verify the research hypothesis. The DCC model is a dynamic specification based on conditional correlations within such models as, e.g., GARCH (developed by Engle [11], Engle and Sheppard [37], and Tse and Tsui [38]). It allows simultaneous

modeling of the variances and conditional correlations of several series. The estimation consists of two steps. Firstly, the conditional variance of each variable using, e.g., GARCH procedure is estimated. Secondly, the time-varying correlations are modeled relying on lagged values of residuals and covariance matrices. After that, conditional covariance matrix is found by using conditional standard deviations and dynamic correlations.

The conditional variances for an individual asset can be obtained from the univariate GARCH(1,1) model.

$$r_t = \mu + \varepsilon_t = \mu + \sqrt{h_t}z_t \dots z_t \sim N(0,1) \tag{1}$$

Under GARCH specification, the time-varying conditional volatility is a function of its own past lag: one term plus the past innovations, and using GARCH(1,1) it can be modeled as

$$h_t = \omega + \alpha\varepsilon_{t-1}^2 + \beta h_{t-1} \dots \tag{2}$$

$$V_L = \frac{\omega}{1 - \alpha - \beta} \tag{3}$$

$$\omega > 0, \alpha \geq 0, \beta \geq 0, \alpha + \beta < 1. \tag{4}$$

In Equation (1),  $r_t$  is the return and  $z_t$  is the random error term with conditional variance  $h_t$ . Equation (2) specifies the GARCH(1,1) process. In Equation (3), the long-term variance ( $V_L$ ) is defined. The usual GARCH restrictions of non-negativity and imposed stationarity, such as non-negativity of variances (Equation (4)) are applied. The sum of  $\alpha$  and  $\beta$  coefficients is a measure of persistence of volatility shocks and is expected to be less than 1. A sum of coefficients higher than 1 means the shock has an explosive effect.

$$\dots X_t = \mu + \varepsilon_t \dots \dots \dots \varepsilon_t | F_{t-1} \sim N(0, D_t R_t D_t) \tag{5}$$

$$\dots D_t^2 = \text{diag}\{H_t\} \tag{6}$$

$$H_{i,t} = \omega_i + \alpha_i \varepsilon_{i,t-1}^2 + \beta_i H_{i,t-1} \tag{7}$$

$$z_t = D_t^{-1} \varepsilon_t \tag{8}$$

$$R_t = \text{diag}\{Q_t\}^{-1/2} Q_t \text{diag}\{Q_t\}^{-1/2} \tag{9}$$

$$Q_t = \Omega + \alpha z_{t-1} z'_{t-1} + \beta Q_{t-1}, \quad \Omega = \bar{R}(1 - \alpha - \beta) \tag{10}$$

where  $D_t = \text{diag}\{\}$  in Equation (6),  $\text{diag}\{\}$  is a matrix operator creating a diagonal matrix with the vector along the main diagonal, and  $R_t$  in Equation (5) is a dynamic correlation matrix.  $R$  in Equation (10) is the unconditional covariance of the standardized residuals resulting from the univariate GARCH equation. The parameters  $\alpha$  and  $\beta$  are non-negative with a sum of less than unity.

In this study, the authors considered GARCH(2,1); GARCH(1,2) and GARCH(1,1) with normal and Student’s  $t$ -distributions; and the DCC with multivariate normal, Laplace and Student’s  $t$ -distributions. The following combinations were analyzed:

- normal—multivariate Student’s  $t$ ,
- Student’s  $t$ —multivariate normal,
- Student’s  $t$ —multivariate Student’s  $t$ ,
- normal—multivariate Laplace,
- Student’s  $t$ —multivariate Laplace.

Since the differences in results were not significant, we decided to present only the results of the standard model DCC(1,1)–GARCH model with normal and multivariate normal distribution.

However, this assumption is still unrealistic because we observed that asset returns are skewed, leptokurtic, and asymmetrically dependent. These difficulties can be treated as a problem of copulas.

The copula functions were introduced for the first time by Sklar in 1959 in the article Fonctions de repartition à  $n$  dimensions et leurs marges. A copula is a function that links univariate marginals to their multivariate distribution.

The process of identifying the states of financial and commodity market and analyzing their temporal evolution was based also on the conditional dependence structure using a copula–DCC–GARCH methodology with normal and Student’s  $t$ -distributions. In this approach, multivariate joint distributions of the return vector  $\mathbf{r}$  conditional on the information set available at time  $t - 1$  are modeled using the conditional copulas introduced by Patton [39,40]. The model parameters were estimated through maximum likelihood method in two steps. In the first step, univariate rates of return  $r_t$  are modeled using a GARCH process, and the conditional variance is estimated. The dependence structure of the margins is then assumed to follow a Gaussian and Student’s  $t$  copula with conditional correlation matrix  $R_t$ . In the second step, the dynamics of  $R_t$  are modeled with the use of the dynamic conditional correlation model DCC, and the parameters for the conditional correlation, given by the parameters of the first stage, are estimated. The copula–DCC–GARCH approach allows flexibility in the choice of marginal distributions and dependence structures. To validate the model, we used the Jarque Bera test statistic for residuals and squared residuals in order to test the null hypothesis that the data are normal against the alternative of non-normality.

Estimation of the parameters of the DCC–GARCH and copula–DCC–GARCH models was executed using the maximum likelihood method. All calculations were completed using R environment with the rmgarch package ([cran.r-project.org/web/packages/rmgarch](http://cran.r-project.org/web/packages/rmgarch)).

## 4. Results

### 4.1. Dataset

The data used in this study comprise weekly logarithmic rates of return of selected indices from 12 October 2012, through 4 October 2019. It is a compromise between the availability of data (some ESG indices were introduced to the market only recently) and the requirements of the estimation procedure. To eliminate any errors in daily data, weekly returns were used. The weekly rate of return was calculated as a logarithmic rate by comparison of the Friday–Friday values. The following indices were analyzed (for a description, see Table A1 (Appendix A)):

- 2 ESG indices for the global market—Stoxx Global ESG Impact, Dow Jones Sustainability World Index;
- 3 ESG indices for the European market—Stoxx Europe Industry Neutral, Stoxx Europe ESG Leaders Select 30, Dow Jones Sustainability Europe;
- 2 ESG indices for the US market—Dow Jones Sustainability US Composite Index, S&P 500 ESG Index;
- 2 non-ESG indices—Euro Stoxx Select Dividend 30, SP 500;
- 3 commodity indices (Dow Jones Commodity Index Industrial Metals, Dow Jones Precious Metals Index, Dow Jones Commodity Grains Index).

The data for ESG indices and the Stoxx Europe Leaders Index was obtained from Reuters Datastream ([datastream.thomsonreuters.com/](http://datastream.thomsonreuters.com/)). The data for commodity indices was gathered from S&P Dow Jones Indices website ([us.spindices.com](http://us.spindices.com)) and the time series for SP 500 was downloaded from `stooq.pl`.

The descriptive analysis and graphics of the used data based on the results presented in Table 1 show that standard deviations of commodity indices are higher than these of the stock indices and the mean rate of return for commodities is negative. It is observed that skewness is negative for almost all the analyzed indices except for the industrial metal index and positive excess kurtosis values, which are generally higher than 0. This suggests that the distributions of the index returns are leptokurtic (the presence of fat tails). Since skewness is different from zero and there is high excess kurtosis, the

data distribution shows the characteristics of non-normality. This is supported by the results of the Jarque–Bera test. Since the probability values of Jarque–Bera test are lower than 0.01 (99%, confidence level) for almost all the indices except the industrial metals index, it shows non-normality. The results indicate the varying volatility (higher for commodities, lower for stock indices) and the non-normality of weekly logarithmic rates of return of the indices selected for the study.

**Table 1.** Descriptive statistics.

	Mean	Std. Dev.	Skewness	Kurtosis	Jarque–Bera stat. ( <i>p</i> -Value)
DJS Europe	0.0011	0.0206	−0.3496	2.4	96.05 (0)
DJS US	0.0019	0.0179	−0.6971	2.462	123 (0)
DJ Commodity Index Grains	−0.0015	0.0251	−0.047	1.098	18.66 (0.0025)
DJ Commodity Index Industrial Metals	−0.0005	0.0221	0.1484	0.4838	4.954 (0.0745)
DJ Commodity Index Precious Metals	−0.0017	0.0474	−0.1853	1.402	32.35 (0.0005)
GSLI	0.0012	0.0183	−0.4127	1.231	33.79 (0)
S&P500	0.0019	0.0176	−0.7726	2.619	142.2 (0)
S&P500 ESG	0.0019	0.0175	−0.7964	2.773	157.3 (0)
Stoxx Europe IN	0.0009	0.0209	−0.33	2.241	83.94 (0)
Stoxx Europe ESG Leaders	0.0006	0.0189	−0.3271	2.253	84.66 (0)
Euro Stoxx Select Dividend 30	0.0008	0.022	−0.1131	1.369	29.6 (0)
Stoxx Global ESG Impact	0.0013	0.0174	−0.6521	1.772	74.45 (0)

Before estimation of the volatility model, the stationarity, autocorrelation, and ARCH effect for the time series were tested. Testing indicated that the time series of the weekly logarithmic rates of return are (detailed results are presented in Table A2 (Appendix A))

- Stationary;
- For most indices, autocorrelation exists in returns and in squared returns—only for commodity indices is the null hypothesis not rejected (there is no autocorrelation in returns and in squared returns present);
- For most indices, the ARCH effect is present—only for metals is the null hypothesis not rejected (there is no ARCH effect).

#### 4.2. Volatility and Dynamic Conditional Correlation

To model volatility and persistence of selected indices, we apply the GARCH(1,1) model. Table 2 presents the estimation results.

The estimation of the GARCH(1,1) model shows that both the ARCH term alpha (short-run persistency of shocks) and the GARCH term beta (long-run persistency of shocks) are significant for most indices, indicating the impact of shocks on volatility. This means that conditional variance has correlation with lagged conditional variance and lagged squared disturbance. The sum of ARCH and GARCH terms,  $\alpha + \beta$ , is less than one, indicating that the volatility shocks are quite persistent. The financial implication of these coefficients for investors is that the volatility of the index's rate of return exhibits clustering.

The alpha parameter indicates the sensitivity of the index  $j$  following a volatility shock of the index  $i$ , whereas beta indicates the persistence of the index  $j$  following a volatility shock of the index  $i$ . Interpretation of the results presented in Table 2 is as follows. The volatility of the ESG indices are, on average, close to zero (0.001–0.002), while for the commodity indices, they are also negative (−0.002 to −0.0004). In addition, the ESG indices are more sensitive to their own volatility shocks compared to the volatility shocks of the commodity indices. Regarding the persistence of shocks, we find that the impact of volatility of the commodity indices on themselves is more persistent and amounts to around 88–99% compared to the persistence of volatility shocks of the ESG indices on themselves, which amounts to around 69–80%.

Before we start the analysis of the evolution of conditional correlations, we removed all statistically insignificant pairs of indices (see Table A6 (Appendix B)).

Table 2. GARCH(1,1) parameters.

	Estimate	Std. Error	t Value	Pr (> t )
DJS Europe				
$\mu$	0.001355	0.000923	1.4688	0.141900
$\omega$	0.000025	0.000016	1.5587	0.119068
$\alpha$	0.128621	0.052574	2.4465	0.014427
$\beta$	0.813363	0.076869	10.5812	0.000000
DJS US				
$\mu$	0.002344	0.000964	2.43118	0.015050
$\omega$	0.000056	0.000075	0.75441	0.450604
$\alpha$	0.186019	0.160194	1.16121	0.245556
$\beta$	0.646293	0.365139	1.76999	0.076729
Euro Stoxx Select Dividend 30				
$\mu$	0.000902	0.001049	0.86019	0.389684
$\omega$	0.000024	0.000019	1.26074	0.207403
$\alpha$	0.079084	0.038602	2.04869	0.040492
$\beta$	0.870998	0.068637	12.68989	0.000000
Stoxx Europe Industry Neutral				
$\mu$	0.001219	0.000940	1.2976	0.194438
$\omega$	0.000031	0.000020	1.4955	0.134774
$\alpha$	0.138452	0.057707	2.3992	0.016431
$\beta$	0.794510	0.088570	8.9704	0.000000
Stoxx Europe ESG Leaders				
$\mu$	0.001032	0.000890	1.1599	0.246087
$\omega$	0.000051	0.000030	1.6804	0.092889
$\alpha$	0.187059	0.071726	2.6080	0.009108
$\beta$	0.681275	0.126732	5.3757	0.000000
S&P 500 ESG				
$\mu$	0.002266	0.000879	2.57832	0.009928
$\omega$	0.000047	0.000044	1.07133	0.284021
$\alpha$	0.154973	0.084964	1.82399	0.068154
$\beta$	0.696988	0.204795	3.40335	0.000666
Dow Jones Commodity Index Precious Metals				
$\mu$	-0.002108	0.002130	-0.98957	19.82116
$\omega$	0.000082	0.000058	1.40912	0.158798
$\alpha$	0.079973	0.033522	2.38567	0.017048
$\beta$	0.887014	0.044751	19.82116	0.000000
Dow Jones Commodity Index Industrial Metals				
$\mu$	-0.000455	0.001146	-0.39734	0.691118
$\omega$	0.000024	0.000030	0.80580	0.420360
$\alpha$	0.034342	0.027151	1.26486	0.205923
$\beta$	0.917218	0.072335	12.68016	0.000000
Dow Jones Commodity Index Grains				
$\mu$	-0.001260	0.001358	-0.928406	0.353197
$\omega$	0.000005	0.000000	182.297927	0.000000
$\alpha$	0.000024	0.001117	0.021198	0.983088
$\beta$	0.992316	0.000829	1196.821063	0.000000

In the last ten years for commodities and the financial market, three main periods may be observed:

- January 2010–July 2011 (economic growth);
- August 2011–December 2015 (a collapse in the metals market);
- January 2016–December 2017 (economic growth in metals and financial markets).

Figure 1 shows the evolution of conditional correlations for statistically significant pairs of indices.

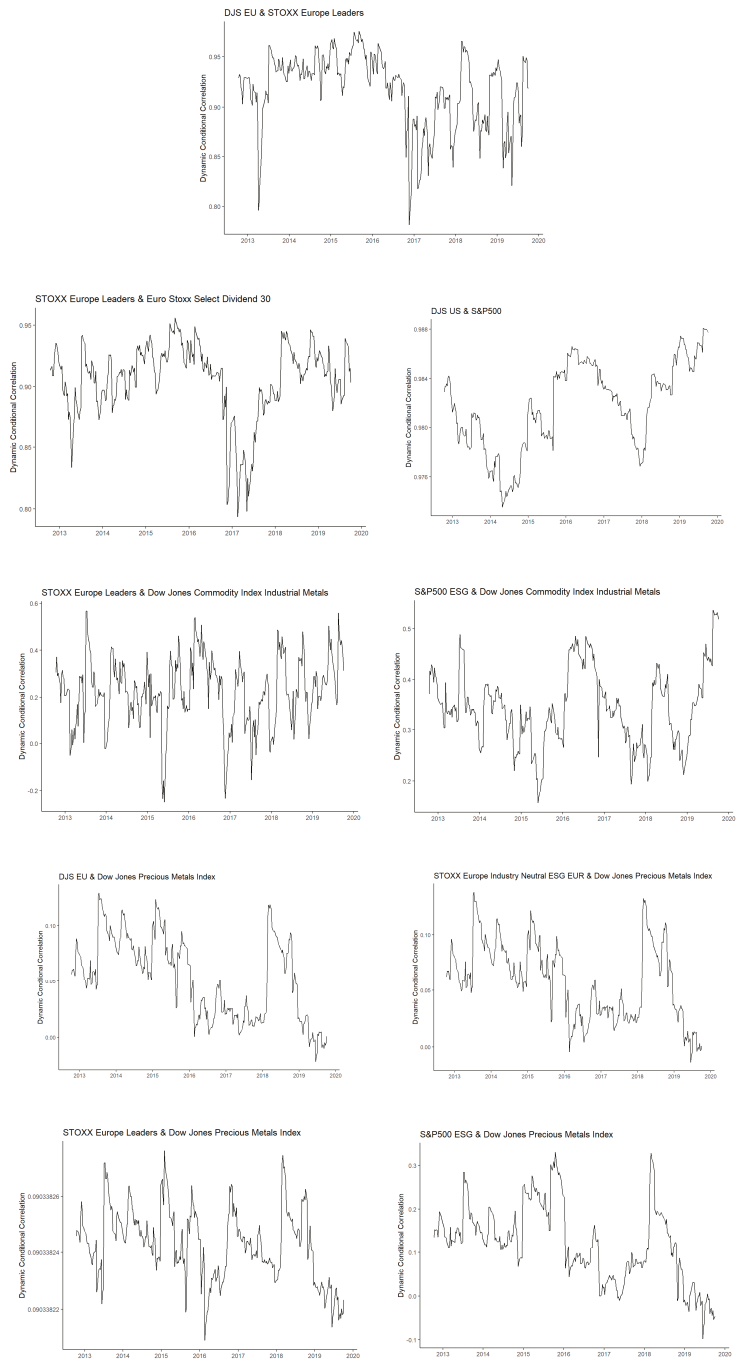
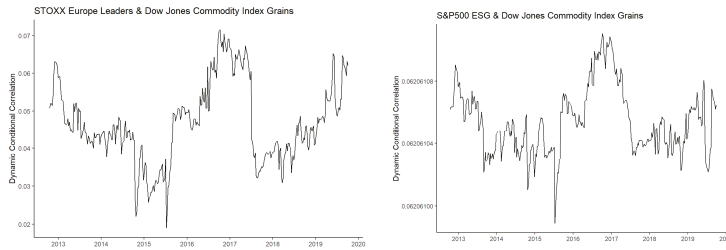

Figure 1. Cont.



**Figure 1.** Dynamic conditional correlation (DCC) evolution results.

In most cases (Figure 1), we observe a statistically significant increase in correlation for a pair of indices for the first period (after 2010). A detailed analysis is as follows:

1. For the ESG–ESG relationship, one pair of indices (out of 5) showed statistically significant high conditional correlation. In the last year, this correlation has been weakening, but still remains close to 1.
2. In the case of the ESG–non-ESG relationship, two pairs of indices (out of 5) show statistically significant high conditional correlation (close to 1). For the European market, we observed two periods where the correlation was weakening considerably, mainly in the years 2013—a drop to 0.4 (the problem of the banking sector in the EU)—and in 2016/2017, a drop by  $-0.2$  (the start of economic growth). For the American market, there were few periods where correlation was weakening but still remained high. The level of correlation is higher for the American market comparing to the European one.
3. Eight pairs of indices (out of a total of 21) for the ESG–commodities relationship showed statistically significant low and medium (lower than 0.5) conditional correlation.
  - a. The ESG—precious metals relationship is characterized by low correlation (less than 0.15). Four pairs of indices (out of seven) showed a growth in correlation in 2013–2015 (the beginning and the end of the downturn period on the metals market) and also in 2018, but of not more than around 0.1. The evolution of conditional correlations for the European market as represented by three indices looks very similar. For the American market, the level of correlation is higher—even more than 0.3.
  - b. For the ESG—industrial metals relationship, two pairs of indices (out of seven) behave similarly for the European and American markets, but there are substantial differences. For the European indices, we observed three periods where the correlation is higher than 0.5, mainly in 2013 (the collapse period of the metals market), 2016 (the economic growth period in the metals and financial markets), and 2019, and also lower than 0 ( $-0.5$ ) in 2015 and 2016–2017 (two drops). For the American indices, we observed one period where the correlation is higher than 0.5, mainly in 2019. Moreover, the volatility is higher in the case of European market.
  - c. The ESG—grains relationship is weaker compared to two earlier described relationships, around 0.06. Two pairs of indices out of seven behave similarly for the European and American markets, but there are substantial differences in some subperiods. For both markets, we observed one period where the correlation is higher than 0.06, mainly in 2013 (one pick) and 2016–2017 (the economic growth period on metals market and financial markets), and also lower than 0.02 in 2015 (the collapse period on metals market). Moreover, volatility is considerably lower in the case of the American market.

Detailed results of DCC estimation are presented in Tables 3–5.

Table 3. DCC estimation results.

	Estimate	Std. Error	t Value	Pr (> t )
DJS Europe and Stoxx Europe ESG Leaders				
Dcca	0.092053	0.024236	3.7982	0.000146
Dccb	0.820905	0.046229	17.7574	0.000000
Stoxx Europe ESG Leaders and Euro Stoxx Select Dividend 30				
Dcca	0.060171	0.018470	3.25775	0.001123
Dccb	0.849697	0.039364	21.58559	0.000000
DJS US and S&P 500				
Dcca	0.013889	0.006376	2.1782	0.029388
Dccb	0.974591	0.017620	55.3116	0.000000
Stoxx Europe ESG Leaders and DJ Commodity Index Industrial Metals				
Dcca	0.098396	0.033519	2.93555	0.003330
Dccb	0.713455	0.067294	10.60204	0.000000
S&P500 ESG and DJ Commodity Index Industrial Metals				
Dcca	0.030847	0.022086	1.39668	0.162511
Dccb	0.929136	0.033460	27.76848	0.000000
DJS Europe and DJ Commodity Index Precious Metals				
Dcca	0.008395	0.019347	0.43394	0.664332
Dccb	0.958185	0.063344	15.12664	0.000000
Stoxx Europe Industry Neutral and DJ Index Precious Metals				
Dcca	0.008955	0.021058	0.42525	0.670653
Dccb	0.948135	0.061708	15.36486	0.000000
Stoxx Europe Leaders and DJ Index Precious Metals				
Dcca	0.000000	0.000059	0.000075	0.999940
Dccb	0.918458	0.357601	2.568391	0.010217
S&P500 ESG and DJ Index Precious Metals				
Dcca	0.022400	0.017380	1.28885	0.197449
Dccb	0.932937	0.065525	14.23785	0.000000
Stoxx Europe Leaders and DJ Commodity Index Grains				
Dcca	0.003321	0.018948	0.175273	0.860865
Dccb	0.953796	0.020143	47.351902	0.000000
S&P500 ESG and DJ Commodity Index Grains				
Dcca	0.000000	0.000202	0.000043	0.999966
Dccb	0.946848	0.759758	1.246250	0.212673

Table 4. Copula–DCC–GARCH (Gaussian) estimation results.

	Estimate	Std. Error	t Value	Pr (> t )
DJS Europe and Stoxx Europe ESG Leaders				
Dcca	0.092053	0.024227	3.7996	0.000145
Dccb	0.820905	0.046120	17.7992	0.000000
Stoxx Europe ESG Leaders and Euro Stoxx Select Dividend 30				
Dcca	0.060171	0.018632	3.22950	0.001240
Dccb	0.849697	0.039899	21.29618	0.000000
DJS US and S&P 500				
Dcca	0.013889	0.006312	2.20026	0.027789
Dccb	0.974591	0.017345	56.18803	0.000000
Stoxx Europe ESG Leaders and DJ Commodity Index Industrial Metals				
Dcca	0.098396	0.033597	2.92869	0.003404
Dccb	0.713455	0.067675	10.54240	0.000000
S&P500 ESG and DJ Commodity Index Industrial Metals				
Dcca	0.030847	0.022175	1.39109	0.164198
Dccb	0.929136	0.033097	28.07300	0.000000
DJS Europe and DJ Commodity Index Precious Metals				
Dcca	0.008395	0.020666	0.40625	0.684559
Dccb	0.958185	0.058471	16.38735	0.000000
Stoxx Europe Industry Neutral and DJ Index Precious Metals				
Dcca	0.008955	0.021913	0.40866	0.682792
Dccb	0.948135	0.055833	16.98148	0.000000
Stoxx Europe Leaders and DJ Index Precious Metals				
Dcca	0.000000	0.000000	0.39360	0.693875
Dccb	0.918457	0.350274	2.62211	0.008739
S&P500 ESG and DJ Index Precious Metals				
Dcca	0.022400	0.017505	1.27968	0.200658
Dccb	0.932936	0.063356	14.72519	0.000000
Stoxx Europe Leaders and DJ Commodity Index Grains				
Dcca	0.003321	0.018598	0.178575	0.858271
Dccb	0.953796	0.019704	48.405075	0.000000
S&P500 ESG and DJ Commodity Index Grains				
Dcca	0.000000	0.000059	0.000003	0.999997
Dccb	0.946849	0.597310	1.585190	0.112923



**Table 5.** Copula DCC GARCH (Student's *t*) estimation results.

	Estimate	Std. Error	<i>t</i> Value	Pr (>  <i>t</i>  )
DJS Europe and Stoxx Europe ESG Leaders				
Dcca	0.089614	0.028287	3.1680	0.001535
Dccb	0.833153	0.064187	12.9802	0.000000
shape	10.291252	7.848614	1.3112	0.189784
Stoxx Europe ESG Leaders and Euro Stoxx Select Dividend 30				
Dcca	0.060536	0.020564	2.94381	0.003242
Dccb	0.851205	0.046137	18.44954	0.000000
shape	21.961475	16.823304	1.30542	0.191750
DJS US and S&P 500				
Dcca	0.012786	0.005962	2.14477	0.031971
Dccb	0.981967	0.012947	75.84782	0.000000
shape	21.060808	8.035996	2.62081	0.008772
Stoxx Europe ESG Leaders and DJ Commodity Index Industrial Metals				
Dcca	0.102885	0.035039	2.93633	0.003321
Dccb	0.720513	0.064630	11.14828	0.000000
shape	14.396227	7.333689	1.96303	0.049643
S&P500 ESG and DJ Commodity Index Industrial Metals				
Dcca	0.034528	0.023747	1.45402	0.145942
Dccb	0.924289	0.036495	25.32642	0.000000
shape	49.999997	39.914116	1.25269	0.210319
DJS Europe and DJ Commodity Index Precious Metals				
Dcca	0.016588	0.020351	30.93940	0.415015
Dccb	0.955769	0.030892	2.57255	0.000000
shape	7.765412	3.018562	2.57255	0.010095
Stoxx Europe Industry Neutral and DJ Index Precious Metals				
Dcca	0.016491	0.022330	0.73851	0.460207
Dccb	0.948290	0.034365	27.59473	0.000000
shape	7.833953	3.175421	2.46706	0.013623
Stoxx Europe Leaders and DJ Index Precious Metals				
Dcca	0.000604	0.025593	0.023594	0.981176
Dccb	0.935939	0.072982	12.824212	0.000000
shape	7.547719	2.674170	2.822453	0.004766
S&P500 ESG and DJ Index Precious Metals				
Dcca	0.029924	0.018557	1.61250	0.106854
Dccb	0.940486	0.025153	37.39083	0.000000
shape	8.268864	3.516566	2.35140	0.018703
S&P500 ESG and DJ Commodity Index Grains				
Dcca	0.000000	0.000000	0.040853	0.967413
Dccb	0.998961	0.010566	94.546781	0.000000
shape	49.999924	6.762795	7.393381	0.000000

The results in Table 3 indicate that the values of Dccb parameters generally range from 0.94 to 0.97, which indicates high volatility of conditional correlation. With slightly lower Dccb values in the range 0.71–0.85, a lower volatility of conditional correlation may be noticed compared to the previous case, but it seems that a relationship between the correlation values in different periods still exists. These estimated Dcca and Dccb parameters sum to a value which is less than 1, indicating that the dynamic conditional correlations are undergoing mean reversion process.

In order to test the validity of the GARCH model, we ensured that the standardized residuals and squared standardized residuals were normally distributed. Tables A4–A6 of the residual normality Jarque–Bera test were included in the Appendix.

Results of the copula–DCC–GARCH (Gaussian distribution) in Table 4 are similar to DCC–GARCH. The results of copula–DCC–GARCH (Student's *t*-distribution) in Table 5 are more promising—they need further deep investigation. Residual diagnostic tests on the standardized residuals and squared

standardized residuals for the DCC models presented in Tables A5 and A6 show no statistically significant evidence of normality in most cases.

## 5. Discussion

Most financial time series exhibit autocorrelation and volatility clustering. In this study, a standard GARCH model was used to analyze the volatility of the rates of return of the selected indices. This model captures symmetric dynamics and the volatility clustering of the return series.

The results show that indices' returns exhibit volatility clustering with time-varying variance in the residuals. These findings show the nonlinear structure in the conditional variance of the returns. This dynamic may be modeled with the GARCH(1,1) model which is consistent with the literature.

Regarding the financial market, changing correlations are not a new phenomenon. Indeed, correlations among the asset classes have never been fixed; however, the pace of change varies over time for different reasons. Globalization and market integration is one key factor.

As the IMF showed, the correlations between the US equities (S&P 500) and other asset classes were growing in the post-crisis era: from a pre-crisis (1988–2007) cross-asset median correlation of 0.44 to a post-crisis (2010–2015) median of 0.702 [41].

There are several possible factors that have contributed to the change of the correlation between the assets:

- Synchronized monetary policy: the evidence suggests elevated correlations [42,43];
- Financial innovation: the analysis shows increased correlations between commodities and equities [44,45];
- Market trading strategies: the research suggests increased cross-asset correlations [46,47].

The results of this study are not surprising in the case of conditional correlation between ESG indices, which are high. From the point of view of risk reduction, including the same type of assets in a portfolio is not effective. Since only one pair of indices showed statistically significant correlation, the results are difficult to generalize in terms of evolution of the conditional correlation in time, and further studies are necessary.

Combining the ESG assets and the non-ESG assets in one portfolio is also not effective from a risk reduction perspective as the conditional correlation is also high (close to 1). Likewise, in this case, we find only two pairs of indices with statistically significant correlation, therefore further studies are necessary.

Even if the correlation between commodities and equities is growing over time, it is still possible to use commodities as diversifiers in a portfolio. This study confirmed that there exists an opportunity for socially responsible investments to include precious and industrial metals and grains in order to reduce the risk of the portfolio.

## 6. Conclusions

This study focused on the modeling of volatility and conditional correlation in order to find opportunities of risk reduction in the case of socially responsible investing. The hypothesis that there is a potential to create a portfolio by adding to SRI commodities and that risk management opportunities exist between SRI and commodities like grain, precious metals, and industrial metals was positively verified. The results show that all the considered commodity indices had low correlation with the ESG indices. Including particular commodities (e.g., gold, silver, copper, wheat) in a portfolio of particular ESG assets could be developed with further studies.

Conditional correlations evolve in time, but we were not able to find any tendencies of correspondence to observed market cycles (periods of growth and collapse).

Many studies analyze socially responsible investments as a potential diversifier of a traditional portfolio, e.g., stocks portfolio. In this paper, a different approach was adopted—SRI are treated as traditional investments and commodities as a diversifier. There is little research on portfolio

construction using SRI. Mostly, mutual funds invested in ESG companies are analyzed. The existing selective studies concern the indices of ESG stocks or commodities like gold and oil (there is no research considering grain). Thus, the paper fills an existing gap in the current research.

This study provides robust evidence on socially responsible investments and commodities as portfolio diversifiers (based on the indices), which might be a starting point for a discussion on the practical application of a set of ESG companies and selected representatives of commodities.

From an investor's point of view, it seems important to notice that the correlation between the two securities can change, sometimes in a rather violent way. Considering this fact seems necessary, e.g., when constructing a portfolio. For ethical (socially responsible) investors, modified utility function is also essential. Therefore, the aim of further research will be to use the DCC model in portfolio construction and risk analysis assuming a modified utility function.

Investors in sustainable investment funds generally have a long-term investment horizon [45]. It was found by Talan and Deep Sharma [48] that only around 8% of the reviewed papers considered a period of more than 10 years in their research [46]. The authors of this paper studied SRIs over a period of 8 years, which is longer compared to most of the other studies.

This study is not free of limitations. Firstly, we used indices, while a more detailed analysis would be advantageous, including ESG companies from different markets (developed and developing) and particular commodities (e.g., gold, silver, copper, corn). Secondly, we analyzed diversification possibilities by using commodities, and deeper studies would be beneficial (e.g., involving hedge ratio calculations, optimal weights).

**Author Contributions:** Conceptualization, K.K.; methodology, K.K.; software, D.C.; validation, D.C.; formal analysis K.K., D.C.; investigation, K.K., D.C.; resources, D.C., T.P.; data curation, D.C., T.P.; writing—original draft preparation, K.K., T.P., D.C.; writing—review and editing, K.K.; visualization, D.C., T.P.; supervision, K.K.; project administration, K.K.; funding acquisition, K.K. All authors have read and agreed to the published version of the manuscript.

**Funding:** The project is financed by the Ministry of Science and Higher Education in Poland under the programme "Regional Initiative of Excellence" 2019–2022 project number 015/RID/2018/19 total funding amount 10 721 040,00 PLN.

**Conflicts of Interest:** The authors declare no conflicts of interest.

## Appendix A

Table A1. Description of selected indices.

Index	Ticker	Number of Constituents	Criteria	Sectors	Weights	First Value
Stoxx Global ESG Impact	SXEMGGR	889	Stoxx Global 1800 without excluded sectors and high ESG scores in every sector	1. Technology 2. Banks 3. Health Care	Free-float	Sep 17, 2010
Stoxx Europe Industry Neutral	SXIEN	471	Stoxx Global 1800 without excluded sectors, and Sustainability score above 50	1. Health Care 2. Industrial Goods and Services 3. Banks	Free-float	Sep 24, 2012
Stoxx Europe ESG Leaders Select 30	SEESSEG	30	Dividend-paying, high liquidity European companies included in Global ESG Index	1. Utilities 2. Insurance 3. Telecommunications	Inverted volatility	Jun 21, 2004
Euro Stoxx Select Dividend 30	SD3E	30	High-dividend-yielding companies across the 11 Eurozone countries	Insurance Banks	Annual net dividend yield	Dec 30, 1998
Global Sustainability Leader Index	GSLI	Top 100 representative group of companies	Companies selected on the basis of their ESG performance, excluding companies involved in tobacco	x	Free Float Market Cap	Oct 1st, 2012
Dow Jones Sustainability US Composite Index	AAASGI	126	The top 20% of 600 largest in the Dow Jones Sustainability North America Index	x	Modified market cap	Dec 31, 1998
Dow Jones Sustainability Europe	DJSEUR	126	The top 20% of the largest 600 European companies in the S&P Global BMI based on long-term economic, environmental and social criteria	Health care Consumer staples Financials	float-adjusted market capitalization	Aug 4, 2010
S&P 500 ESG Index	SPXESUP	315	S&P 500 companies without excluded sectors, without low 5% in terms of UNCC score and without 25% of ESG score	1. Information technology 2. Health Care 3. Financials	Float-adjusted market cap	April 30, 2010
Dow Jones Commodity Index Industrial Metals	DJCIIM	x	Industrial Metals based through futures contracts	x	Capped	July 1, 2014
Dow Jones Precious Metals Index	DJCSPP	30	US companies engaged in the exploration and production of gold, silver and platinum-group metals	x	Float-adjusted market cap	December 30, 2000
Dow Jones Commodity Index Grains	DJCIGR	-	Grains sector through futures contracts	x	Capped	Jan 17, 2006

Table A2. Time series tests results.

Index	ADF Stat and (p-Value)	Ljung-Box r Stat and (p-Value)	Ljung-Box $r^2$ Stat and (p-Value)	ARCH-LM Test and (p-Value)
DJS Europe	-7.564 (0.01)	6.979 (0.0082)	14.32 (0.0002)	45.09 (0)
DJS US	-7.495 (0.01)	8.532 (0.0035)	7.559 (0.006)	27.44 (0.0067)
DJ Commodity Index Grains	-7.423 (0.01)	0.1851 (0.6671)	1.141 (0.2855)	26.47 (0.0092)
DJ Commodity Index Industrial Metals	-6.892 (0.01)	1.114 (0.2911)	2.011 (0.1562)	18.29 (0.1071)
DJ Commodity Index Precious Metals	-6.629 (0.01)	0 (0.9875)	1.28 (0.258)	30.98 (0.002)
GSLI	-7.74 (0.01)	6.436 (0.0112)	3.468 (0.0626)	17.88 (0.1193)
S&P500	-7.738 (0.01)	6.788 (0.0092)	7.72 (0.0055)	25.3 (0.0135)
S&P500 ESG	-7.605 (0.01)	7.7 (0.0055)	7.578 (0.0059)	24.52 (0.0173)
Stoxx Europe IN	-7.7 (0.01)	6.415 (0.0113)	16.05 (0.0001)	42.16 (0)
Stoxx Europe ESG Leaders	-8.135 (0.01)	-4.619 (0.0316)	18.97 (0)	38.41 (0.0001)
Euro Stoxx Select Dividend 30	-8.297 (0.01)	7.859 (0.0051)	18.01 (0)	37.02 (0.0002)
Stoxx Global ESG Impact	-7.828 (0.01)	6.796 (0.0091)	5.492 (0.0191)	22.62 (0.0311)

Table A3. Test results for residuals from DCC-GARCH.

	JB Test Stat	JB Test p-value	Stat (Squared Residuals)	JB Test Stat (Squared Residuals)	p-VALUE (Squared Residuals)	JB Test Residuals)
	DJS Europe and Stoxx Europe ESG Leaders					
DJS Europe	8.715	0.0175		1212		0
Stoxx Europe ESG Leaders	25.14	0.002		14,072		0
	Stoxx Europe ESG Leaders and Euro Stoxx Select Dividend 30					
Stoxx Europe ESG Leaders	44.22	0		26,708		0
Euro Stoxx Select Dividend 30	0.4084	0.81		1399		0
	DJS US and S&P 500					
DJS US	3.611	0.142		2386		0
S&P 500	27.83	0.0005		5921		0
	Stoxx Europe ESG Leaders and DJ Commodity Index Industrial Metals					
Stoxx Europe ESG Leaders	45	0		6131		0
DJ Commodity Index Industrial Metals	4.912	0.0805		6465		0
	S&P500 ESG and DJ Commodity Index Industrial Metals					
S&P500 ESG	157.6	0		38,957		0
DJ Commodity Index Industrial Metals	4.316	0.0975		4121		0
	DJS Europe and DJ Commodity Index Precious Metals					
DJS Europe	40.66	0		3628		0
DJ Commodity Index Precious Metals	38.42	0		8879		0
	Stoxx Europe Industry Neutral and DJ Index Precious Metals					
Stoxx Europe Industry Neutral	41.13	0.0005		5657		0
DJ Index Precious Metals	38.26	0		8919		0
	Stoxx Europe Leaders and DJ Index Precious Metals					
Stoxx Europe Leaders	37.59	0		7340		0
DJ Index Precious Metals	29.23	0.0005		9142		0
	S&P500 ESG and DJ Index Precious Metals					
S&P500 ESG	184.1	0		23,099		0
DJ Index Precious Metals	37.51	0.0005		8839		0
	Stoxx Europe Leaders and DJ Commodity Index Grains					
Stoxx Europe Leaders	48.51	0		6892		0
DJ Commodity Index Grains	16.53	0.0025		9747		0
	S&P500 ESG and DJ Commodity Index Grains					
S&P500 ESG	184.4	0		30,952		0
DJ Commodity Index Grains	17.1	0.002		9933		0

Table A4. Test results for residuals from copula–DCC–GARCH (Gaussian).

	JB Test Stat	JB Test p-value	Stat (Squared Residuals)	JB Test p-value (Squared Residuals)
DJS Europe	8.752	0.018	1216	0
Stoxx Europe ESG Leaders	25.16	0	14,128	0
Stoxx Europe ESG Leaders and Euro Stoxx Select Dividend 30	44.26	0.001	26,716	0
Euro Stoxx Select Dividend 30	0.4151	0.7995	1402	0
DJS US	3.643	0.148	2396	0
S&P 500	27.99	0.0005	5954	0
Stoxx Europe ESG Leaders	44.89	0.0005	6135	0
DJ Commodity Index Industrial Metals	4.924	0.072	6463	0
S&P500 ESG	157.8	0	38975	0
DJ Commodity Index Industrial Metals	4.321	0.0905	4123	0
DJS Europe	40.7	0	3637	0
DJ Commodity Index Precious Metals	38.41	0	8865	0
Stoxx Europe Industry Neutral and DJ Index Precious Metals	41.15	0	5660	0
DJ Index Precious Metals	38.25	0	8906	0
Stoxx Europe Leaders and DJ Index Precious Metals	74.35	0	13,870	0
Stoxx Europe Leaders	29.23	0.0005	2673	0
DJ Index Precious Metals	184.1	0	23,089	0
DJ Index Precious Metals	37.5	0.0005	8832	0
Stoxx Europe Leaders and DJ Commodity Index Grains	48.5	0	6891	0
DJ Commodity Index Grains	16.52	0.0055	9748	0
S&P500 ESG	184.4	0	30,952	0
DJ Commodity Index Grains	17.1	0.0035	9933	0

Table A5. Test results for residuals from copula–DCC–GARCH (Student's t).

	JB Test Stat	JB Test p-Value	Stat (Squared Residuals)	JB Test p-Value (Squared Residuals)
DJS Europe	8.607	0.019	DJS Europe and Stoxx Europe ESG Leaders	1192
Stoxx Europe ESG Leaders	24.24	0		14,448
Stoxx Europe ESG Leaders	43.69	0	Stoxx Europe ESG Leaders and Euro Stoxx Select Dividend 30	27,212
Euro Stoxx Select Dividend 30	0.4202	0.8155		1437
DJS US	2.998	0.1885	DJS US and S&P 500	2058
S&P 500	25.56	0		5475
Stoxx Europe ESG Leaders	44.99	0	Stoxx Europe ESG Leaders and DJ Commodity Index Industrial Metals	6143
DJ Commodity Index Industrial Metals	5.004	0.081		6429
S&P500 ESG	157.8	0	S&P500 ESG and DJ Commodity Index Industrial Metals	38,991
DJ Commodity Index Industrial Metals	4.39	0.097		4160
DJS Europe	41.47	0	DJS Europe and DJ Commodity Index Precious Metals	3692
DJ Commodity Index Precious Metals	38.32	0		9018
Stoxx Europe Industry Neutral	41.75	0	Stoxx Europe Industry Neutral and DJ Index Precious Metals	5617
DJ Index Precious Metals	38.13	0.0005		9050
Stoxx Europe Leaders	46.19	0	Stoxx Europe Leaders and DJ Index Precious Metals	7400
DJ Index Precious Metals	37.42	0.0005		9218
S&P500 ESG	191.1	0	S&P500 ESG and DJ Index Precious Metals	22,555
DJ Index Precious Metals	37.36	0		8814
S&P500 ESG	184.5	0	S&P500 ESG and DJ Commodity Index Grains	30,978
DJ Commodity Index Grains	17.08	0.0035		9927



## Appendix B

Table A6. Statistical significance/insignificance of dynamic conditional correlations for pair of indices.

Europe—ESG Indices		
DJS Europe	Stoxx Europe ESG Leaders	Insignificant
DJS Europe	Stoxx Europe IN	Significant
Stoxx Europe IN	Stoxx Europe ESG Leaders	Insignificant
ESG indices and non-ESG indices		
DJS Europe	Euro Stoxx Select Dividend 30	Insignificant
Stoxx Europe IN	Euro Stoxx Select Dividend 30	Significant
Stoxx Europe ESG Leaders	Euro Stoxx Select Dividend 30	Significant
ESG Indices and Commodity indices		
DJS Europe	Dow Jones Commodity Index Industrial Metals	Insignificant
DJS Europe	Dow Jones Commodity Index Precious Metals	Significant
DJS Europe	Dow Jones Commodity Index Grains	Insignificant
Stoxx Europe IN	Dow Jones Commodity Index Industrial Metals	Insignificant
Stoxx Europe IN	Dow Jones Commodity Index Precious Metals	Significant at 0.1
Stoxx Europe IN	Dow Jones Commodity Index Grains	Insignificant
Stoxx Europe ESG Leaders	Dow Jones Commodity Industrial Index Metals	Significant
Stoxx Europe ESG Leaders	Dow Jones Commodity Index Precious Metals	Significant
Stoxx Europe ESG Leaders	Dow Jones Commodity Index Grains	Significant
USA—ESG indices		
DJS US	S&P 500 ESG	Insignificant
ESG indices and non-ESG indices		
DJS US	S&P 500	Significant
S&P 500 ESG	S&P 500	Insignificant
ESG Indices and Commodity indices		
DJS US	Dow Jones Commodity Index Industrial Metals	Insignificant
DJS US	Dow Jones Commodity Index Precious Metals	Insignificant
DJS US	Dow Jones Commodity Index Grains	Insignificant
SP 500 ESG	Dow Jones Commodity Index Industrial Metals	Significant
SP 500 ESG	Dow Jones Commodity Index Precious Metals	Significant at 0.06
SP 500 ESG	Dow Jones Commodity Index Grains	Significant
Global—ESG indices		
GSLI	Stoxx Global ESG Impact	Insignificant
ESG Indices and Commodity indices		
Stoxx Global ESG Impact	Dow Jones Commodity Index Industrial Metals	Insignificant
Stoxx Global ESG Impact	Dow Jones Commodity Index Precious Metals	Insignificant
Stoxx Global ESG Impact	Dow Jones Commodity Index Grains	Insignificant
GSLI	Dow Jones Commodity Index Industrial Metals	Insignificant
GSLI	Dow Jones Commodity Index Precious Metals	Insignificant
GSLI	Dow Jones Commodity Index Grains	Insignificant

## References

1. Report on US Sustainable Responsible and Impact Investing Trends 2018, US SIF Foundation. Available online: <https://www.ussif.org/files/Trends/Trends%202018%20executive%20summary%20FINAL.pdf> (accessed on 3 November 2019).
2. Schueth, S. Socially Responsible Investing in the United States. *J. Bus. Ethics* **2003**, *43*, 189–194. [CrossRef]
3. Kempf, A.; Osthoff, P. The Effect of Socially Responsible Investing on Portfolio Performance. Centre for Financial Research (CFR), Working Paper, No. 06-10, University of Cologne. 2007. Available online: <http://hdl.handle.net/10419/57725> (accessed on 3 November 2019).
4. Mackey, A.; Mackey, T.B.; Barney, J.B. Corporate Social Responsibility and Firm Performance: Investor Preferences and Corporate Strategies. *Acad. Manag. Rev.* **2007**, *32*, 817–835. [CrossRef]
5. Auer, B.R.; Schuhmacher, F. Do socially (ir)responsible investments pay? New evidence from international ESG data. *Q. Rev. Econ. Financ.* **2016**, *59*, 51–62. [CrossRef]
6. Fritz, T.M.; von Schnurbein, G. Beyond Socially Responsible Investing: Effects of Mission-Driven Portfolio Selection. *Sustainability* **2019**, *11*, 6812. [CrossRef]

7. Biasin, M.; Cerqueti, R.; Giacomini, E.; Marinelli, N.; Quaranta, A.G.; Riccetti, L. Macro Asset Allocation with Social Impact Investments. *Sustainability* **2019**, *11*, 3140. [[CrossRef](#)]
8. Markowitz, H. Portfolio Selection. *J. Financ.* **1952**, *7*, 77–91.
9. Engle, R.F. Autoregressive Conditional Heteroscedasticity with Estimates of the Variance of United Kingdom Inflation. *Econometrica* **1982**, *50*, 987–1007. [[CrossRef](#)]
10. Bollerslev, T. Generalized autoregressive conditional heteroscedasticity. *J. Econom.* **1986**, *31*, 307–327. [[CrossRef](#)]
11. Engle, R.F. Dynamic conditional correlation: A simple class of multivariate generalized autoregressive conditional heteroskedasticity models. *J. Bus. Econ. Stat.* **2002**, *20*, 339–350. [[CrossRef](#)]
12. Ibbotson Associates. *Strategic Asset Allocation and Commodities*; Ibbotson Associates: Chicago, IL, USA, 2006.
13. Global Sustainable Investment Alliance. *Global Sustainable Investment Review*; Global Sustainable Investment Alliance: Washington, DC, USA, 2014.
14. Webley, P.; Lewis, A.; Mackenzie, C. Commitment among Ethical Investors: An Experimental Approach. *J. Econ. Psychol.* **2001**, *22*, 27–42. [[CrossRef](#)]
15. Ariely, D.; Bracha, A.; Meier, S. Doing Good or Doing Well? Image Motivation and Monetary Incentives in Behaving Prosocially. *Am. Econ. Rev.* **2009**, *99*, 544–555. [[CrossRef](#)]
16. Ortas, E.; Burritt, R.L.; Moneva, J.M. Socially responsible investment and cleaner production in the Asia Pacific: Does it pay to be good? *J. Clean. Prod.* **2013**, *52*, 272–280. [[CrossRef](#)]
17. Goyal, M.M.; Aggarwal, K. ESG Index is Good for Socially Responsible Investor in India. *Asian J. Multidiscip. Stud.* **2014**, *2*, 92–96.
18. Sudha, S. Risk-Return and Volatility Analysis of Sustainability Index in India. *Environ. Dev. Sustain.* **2015**, *17*, 1329–1342. [[CrossRef](#)]
19. Fatemi, A.; Glaum, M.; Kaiser, S. ESG Performance and Firm Value: The Moderating Role of Disclosure. *Glob. Financ. J.* **2017**, *38*, 45–64. [[CrossRef](#)]
20. Beal, D.J.; Goyen, M.; Phillips, P. Why Do We Invest Ethically? *J. Invest.* **2005**, *14*, 66–77. [[CrossRef](#)]
21. Bello, Z. Socially responsible investing and portfolio diversification. *J. Financ. Res.* **2005**, *28*, 41–57. [[CrossRef](#)]
22. Benson, K.L.; Brailsford, T.J.; Humphrey, J.E. Do socially responsible fund managers really invest differently? *J. Bus. Ethics* **2006**, *65*, 337–357. [[CrossRef](#)]
23. Cortez, M.C.; Silva, F.; Areal, N. Socially responsible investing in the global market: The performance of US and European funds. *Int. J. Financ. Econ.* **2012**, *17*, 254–271. [[CrossRef](#)]
24. Bauer, R.; Otten, R.; Rad, A. Ethical investing in Australia: Is there a financial penalty? *Pac. Basin Financ. J.* **2006**, *14*, 33–48. [[CrossRef](#)]
25. Statman, M. Socially responsible indexes: Composition, performance, and tracking error. *J. Portf. Manag.* **2006**, *32*, 100–109. [[CrossRef](#)]
26. Skiadopoulos, G. Advances in the commodity futures literature: A review. *J. Deriv.* **2013**, *20*, 85–96. [[CrossRef](#)]
27. Cheung, C.S.; Miu, P. Diversification benefits of commodity futures. *J. Int. Financ. Mark. Inst. Money* **2010**, *20*, 451–474. [[CrossRef](#)]
28. Belousova, J.; Dorfleitner, G. On the diversification benefits of commodities from the perspective of euro investors. *J. Bank. Financ.* **2012**, *36*, 2455–2472. [[CrossRef](#)]
29. Daskalaki, C.; Skiadopoulos, G.; Topaloglou, N. Diversification benefits of commodities: A stochastic dominance efficiency approach. *J. Empir. Financ.* **2017**, *44*, 250–269. [[CrossRef](#)]
30. Cao, B.; Jayasuriya, S.; Shambora, W. Holding a commodity futures index fund in a globally diversified portfolio: A place effect? *Econ. Bull.* **2010**, *30*, 1842–1851.
31. Daskalaki, C.; Skiadopoulos, G. Should investors include commodities in their portfolios after all? New evidence. *J. Bank. Financ.* **2011**, *25*, 2606–2626. [[CrossRef](#)]
32. Bessler, W.; Wolff, D. Do Commodities add Value in Multi-Asset Portfolios? An Out-of-Sample Analysis for different Investment Strategies. *J. Bank. Financ.* **2015**, *60*, 1–20. [[CrossRef](#)]
33. Lombardi, M.J.; Ravazzolo, F. On the correlation between commodity and equity returns: Implications for portfolio allocation. *J. Commod. Market.* **2016**, *2*, 45–57. [[CrossRef](#)]
34. Sadorsky, P. Modeling volatility and conditional correlations between socially responsible investments, gold and oil. *Econ. Model.* **2014**, *38*, 609–618. [[CrossRef](#)]
35. Hoti, S.; McAleer, M.; Pauwels, L. Modelling environmental risk. *Environ. Model. Softw.* **2005**, *20*, 1289–1298. [[CrossRef](#)]

36. Hoti, S.; McAleer, M.; Pauwels, L.L. Measuring risk in environmental finance. *J. Econ. Surv.* **2007**, *21*, 970–998. [CrossRef]
37. Engle, R.F.; Sheppard, K. Theoretical and Empirical Properties of Dynamic Conditional Correlation Multivariate GARCH. NBER Working Paper No. 8554. 2001. Available online: [https://www.researchgate.net/publication/46441088\\_Theoretical\\_and\\_Empirical\\_Properties\\_of\\_Dynamic\\_Conditional\\_Correlation\\_Multivariate\\_GARCH](https://www.researchgate.net/publication/46441088_Theoretical_and_Empirical_Properties_of_Dynamic_Conditional_Correlation_Multivariate_GARCH) (accessed on 3 November 2019).
38. Tse, Y.K.; Tsui, A. A Multivariate Generalized Autoregressive Conditional Heteroscedasticity Model with Time-Varying Correlations. *J. Bus. Econ. Stat.* **2002**, *20*, 351–362. [CrossRef]
39. Patton, A.J. Modelling Asymmetric Exchange Rate. *Int. Econ. Rev.* **2006**, *47*, 527–556. [CrossRef]
40. Patton, A.J. A Review of Copula Models for Economic Time Series. *J. Multivar. Anal.* **2012**, *110*, 4–18. [CrossRef]
41. IMF. Global Financial Stability Report. 2015. Available online: <https://www.imf.org/en/Publications/GFSR/Issues/2016/12/31/Global-Financial-Stability-Report-April-2015-Navigating-Monetary-Policy-Challenges-and-42422> (accessed on 3 November 2019).
42. Rogers, J.; Scotti, C.; Wright, J. Evaluating Asset Market Effects of Unconventional Market Policy: A Cross Country Comparison, Board of Governors of the Federal Reserve System. International Finance Discussion Papers No 1101; 2014. Available online: <https://www.federalreserve.gov/PUBS/ifdp/2014/1101/ifdp1101.pdf> (accessed on 3 November 2019).
43. Bank of International Settlements. Available online: <https://www.bis.org/publ/arpdf/ar2017e.pdf> (accessed on 15 February 2020).
44. Tang, K.; Xiong, W. Index investment and the financialization of commodities. *Financ. Anal. J.* **2012**, *68*, 54–74. [CrossRef]
45. Lombardi, M.; Ravazzolo, F. On the correlation between commodity and equity returns: Implications for portfolio allocation. BIS Working Papers No 420. Available online: <https://www.bis.org/publ/work420.pdf> (accessed on 3 November 2019).
46. Bicchetti, D.; Maystre, N. *The Synchronized and Long-Lasting Structural Change on Commodity Markets: Evidence from High-Frequency Data*; United Nations Conference on Trade and Development (UNCTAD): Geneva, Switzerland, 2012; Available online: [https://unctad.org/en/PublicationsLibrary/osgdp2012d2\\_en.pdf](https://unctad.org/en/PublicationsLibrary/osgdp2012d2_en.pdf) (accessed on 3 November 2019).
47. Paul, K. The effect of business cycle, market return and momentum on financial performance of socially responsible investing mutual funds. *Soc. Responsib. J.* **2017**, *13*, 513–528. [CrossRef]
48. Talan, G.; Deep Sharma, G. Doing Well by Doing Good: A Systematic Review and Research Agenda for Sustainable Investment. *Sustainability* **2019**, *11*, 353. [CrossRef]





Article

# The Role of Local Governments in Supporting Creative Industries—A Conceptual Model

Jan Fazlagić <sup>1,\*</sup> and Elżbieta Izabela Szczepankiewicz <sup>2</sup>

<sup>1</sup> Department of Services and Market Research, Poznań University of Economics and Business, Al. Niepodległości 10, 61-875 Poznań, Poland

<sup>2</sup> Department of Accounting and Financial Revision, Poznań University of Economics and Business, Al. Niepodległości 10, 61-875 Poznań, Poland; elzbieta.szczepankiewicz@ue.poznan.pl

\* Correspondence: jan.fazlagic@ue.poznan.pl

Received: 29 October 2019; Accepted: 3 January 2020; Published: 6 January 2020

**Abstract:** Local government relates to the public administration of towns, cities, counties, and districts. One of the key responsibilities of local government is the administrative purpose of supplying goods and services. Local governments should also represent and involve citizens in determining specific local public needs and how these local needs can be met. As the structure of gross domestic product (GDP) in many countries across the world changes, so do the expectations towards the role of local governments as far as supporting local economic growth is concerned. The administrative purpose involves creating conducive conditions for economic development. Statistical figures show that the share of the creative economy in the GDP of the most developed countries is steadily increasing. New economic sectors such as “creative industries” pose a challenge to local governments. In this paper, we present a conceptual model for measuring the efforts of local governments in developing and supporting the creative industries. The model proposed by the authors allows for the comparison of smaller administrative units such as counties regarding their advancement and commitment to supporting creative industries.

**Keywords:** local government; sustainable development in counties in Poland; sustainable development model; NTS-4; creative economy; creative industries

## 1. Introduction

The issue of economic development has been at the centre of economics since its very beginnings [1]. The question about the factors that lead to the wealth of nations, which occupied the attention of Adam Smith, is still valid. Smith concluded that low taxes, peace, and a workable system of justice would lead to economic growth [1]. Over the course of history, mankind has gone through several stages of economic development, which are usually referred to as ‘revolutions’. The most rapid changes in economic development took place in the last 250 years and are called industrial revolutions. The industrial model of economic development requires a constant supply of natural resources, such as coal and iron ores, as well as oil and gas. The last 40 years of economic development have proved that rapid economic progress can be achieved through service industries and knowledge economies. Depending on their perspective, different scholars highlight different distinguishing features of those changes, for example, knowledge-based economy, weightless economy [2], The Digital Era, or Industry 4.0. Today the economies and societies of the most industrialised countries of the world are changing at a rapid pace. Intangible assets play a crucial role; among them, special attention is devoted to knowledge as a driver of economic growth. Knowledge may appear both as an input (competence) and output (innovation) in the production process [3]. In a similar vein, knowledge is both an input (creative thinking, creative insights, creative persons, creative press) (see also the work of [4]) and an output of economic processes (innovation). Knowledge, like many other intangible assets, is immaterial.

We believe that the scarcity of intangible resources in the 21st century will be just as important as the scarcity of natural resources—a common theme in the literature on sustainability.

The concept of the ‘creative economy’ [5–9] is another perspective describing the directions of current economic development and is a broader term to describe “creative industries” [10]. Here, the main focus is on the role of creativity of people in economic outputs. According to Howkins, a creative economy is “economic systems where value is based on imaginative qualities rather than the traditional resources of land, labour and capital”. Compared with creative industries, which are limited to specific sectors, the term “creative economy” is used to describe creativity throughout a whole economy [11–13]. Originally, the focus of policymakers regarding the creative economy was on its economic value, but now it has shifted towards its social and cultural value [12,14,15]. According to the United Nations [16,17], creative economy sectors include arts and crafts, books, films, paintings, festivals, songs, designs, digital animation, and video games. They generate income through trade (exports) and intellectual property rights, as well as create new jobs in knowledge-intensive positions in all types of enterprises. In the United Kingdom, a country considered to be one of the world leaders in the creative industries development, the creative industries contribute considerably more to the economy than financial services (employing 2 million people, compared with the financial sector’s 1 million—which contributes just 1 percent more than the creative sector to the U.K. gross domestic product (GDP)) [12]. Thus, the (potential) role of local government in supporting their growth is relatively greater than in the case of other industries, which may be more prone to national level interventions. Creative industries are one of the most unevenly spread sectors, behind only agriculture, finance, and insurance [18]. Creative economies are predominantly concentrated in towns, cities, and metropolitan areas (which correspond with the county NTS-4 (Nomenclature of Territorial Units for Statistics) level in regional development analysis), and consequently their development heavily depends on the scale of support from the local governments. Possession of state-of-the-art knowledge has to be supplemented with the ability to create knowledge. Creation is considered the highest level of the cognitive domain [19], above understanding and applying knowledge. If we apply this statement to the domain of economics, we can conclude that creative industries should in fact produce more economic added-value than “knowledge-intensive (or knowledge-rich) industries”. Consequently, they should garner even more attention from the policy-makers than knowledge-intensive industries. The subtle difference lies in the fact that creativity is positioned higher than knowledge in the hierarchy of cognitive skills. The Industrial Revolution of late 18th-century Britain exploited significant amounts of new scientific and engineering knowledge in steam engines, textiles manufacture, new methods of mining, and other production processes. The emergence of creative industries (within the knowledge-intensive sectors) is marked by success stories such as CD PROJEKT, a player on the global digital entertainment market. The company is active on the global market. Its main products are *The Witcher*, *The Witcher 2*, *The Witcher 3*, and *Cyberpunk 2077*. CD PROJEKT’s market capitalization is approximately 23 billion Polish Zloties (approximately USD 6.0 billion) and exceeds the market value of Polish giant KGHM (Kombinat Górniczo-Hutniczy Miedzi, which describes itself as a “high-tech geological, mining, and metallurgy business”), the largest silver producer and eighth largest copper producer in the world. The intensive application of knowledge is not the only feature of today’s successful businesses. The potential role of public administration in supporting creativity is substantial.

Creative economies do not rely heavily on natural resources, which implies that their negative impact on the climate is relatively lower than that of other industries. “Creative economy” is a broader term for “creative industries”. The creative economy encompasses people with creative occupations working in the creative industries, as well as workers with creative occupations working in another industry and people in non-creative jobs working in a creative industry [10,20]. This definition should also include workers working in the public sector and non-government organizations. Not much academic research has been published so far on the role of local governments in promoting creative industries. Even though many cities and regions across the world publish white papers and analyses

describing their role in developing creative industries, there is a deficit of larger-scale comparative studies and conceptual models.

The goal of our research was to propose a new model for measuring the efficiency of local governments in supporting creative industries locally. We will investigate the possible areas of intervention of local government in providing socio-economic stimuli at local level for the growth and proliferation of creative economy and creative industries. We used data collected from a survey conducted on a sample of Polish counties.

This research fits within the 2030 Agenda for Sustainable Development (SDA), which was adopted at the United Nations Summit (UNS) in New York. On 25 September 2015, the Member States of the United Nations agreed on the 17 Sustainable Development Goals (SDGs) of the Post-2015 Development Agenda. The SDGs build on the Millennium Development Goals, the global agenda that was pursued from 2000 to 2015, and will guide global action on sustainable development until 2030 [21].

In Section 2, we discuss the concepts of creative industries, sustainability, and local governments. Section 3 contains a description of our research approach and the research sample. In Section 4, we present the research findings from the empirical study, which we conducted in Polish counties. In Section 5, we propose a conceptual model for measuring the contribution of local governments in supporting creative industries and describe its possible application in counties (regions). The last section of the paper sums up the research findings, discusses potential study limitations, and presents limitations of the study.

## **2. Creative Industries, Sustainability, and Local Governments**

The rapid increase of creative industries makes them an important focus for economic studies, including regional economic development, but so far, not many regional studies on sustainable development have been conducted [18,22]. The United Nations' SDG Fund runs a number of initiatives to bring creative industries leaders to the forefront of sustainable development [12,16]. When the creative sector becomes part of an overall development and growth strategy, it can contribute to the revitalization of the national economy, where hybrid and dynamic economic and cultural exchanges take place [15,23]. Investing in culture, social capital, and creative industries as drivers of social development can also lead to results that contribute to the overall wellbeing of communities, individual self-esteem and quality of life, dialogue, and cohesion [24].

Sustainability is defined here as a means of meeting our needs today without compromising the ability of future generations to meet their own needs [25]. Those future needs may be endangered by the exploitation of natural resources (including fossil fuels). There is also another danger to economic growth, especially at a local level: running out of ideas. Every year brings new challenges, and we are not able to envisage the answers to all those ideas ahead of us. What we can do, however, is to prepare future generations by equipping them with an environment that will support the creation of new ideas and solutions. Here, we refer to sustainability not only as a concept for preserving the planet's environmental assets, but also caring for the preservation of creative potential. The original use of the term "sustainable development" was intended to place a higher priority on directly meeting human needs, while considering environmental and ecological implications of development [26–28]. The creative industries link traditional knowledge to the ultimate consumer in their capacity to serve both cultural and economic objectives [15,29]. In this regard, the cultural and creative industries can be seen as consistent with the sustainable development paradigm [18]. According to Satterthwaite [27,30], governance structures play a vital role in decision-making processes and implementing appropriate measures. Creative industries require blended technical and creative skills, collaborative interdisciplinary working, entrepreneurialism, and enterprise [31,32]. It is human creativity that drives the success of this sector [10].

The support for regional growth can be prioritized through various measures applied by the local government. Local government could increase the support offered to businesses to protect and exploit intellectual property, but in many countries, including Poland, it is the competence of the

central government. Local governments can, however, implement supportive measures. For example, Bazalgette [10] proposes the Creative Clusters Fund, which aims to protect and manage intellectual property (IP). Another important role of local government is matching private and public investment, which will deliver a 'ladder of growth' [10] to the local economy. According to the United Nations Educational, Scientific, and Cultural Organization (UNESCO), policies are important for fostering growth of culture and creative industries in support of inclusive development, and partnerships and international cooperation are an essential complement [30]. Local governments can be also active in the field of co-financing project with the private investors.

The highly diversified sector of creative industries is an important element of the Polish economy, which has an ambition to catch-up with the most industrialised countries in the world, but it requires particular concern and care for its development [24–28,30,32–36]. According to the European Commission statistics, the sector of cultural and creative industries in countries such as, among others, Poland, the Czech Republic, Hungary, or Slovakia, produces on average 2% GDP altogether [34]. The macroeconomic context of Poland is an important factor that brought our attention to the position of local governments in supporting the development of creative industries. The Polish economy has been growing steadily over the last three decades since the first democratic elections in the Eastern Bloc, which were held in Poland in 1989. Poland's annual GDP growth rate mostly stayed between 3% and 7% from 1993 to 2018. One of the main drivers of growth was the low labour costs. In 2019, Poland's purchasing power parity basis per capita income reached \$27,000 per person, which is about the same as Portugal. The continuation of economic growth requires investments in high value-added sectors, including the creative industries. Poland is looking for new drivers of sustainable economic growth. According to the World Bank estimates, only 13 of 101 middle-income economies in 1960 had become high-income economies by 2008 [37]. The so-called 'middle-income trap' is frequently mentioned in Poland as a threat to economic prosperity. According to the Polish law, local governments are not obliged to release annual reports on their performance in the field of sustainable development. It has to be noted that sustainable development is not a synonym for fast economic growth. The effect of higher preference for intellectual capital compared with material capital may appear with a time lag and appear in such economic factors as a structure of employment and structure of GDP.

Currently in the world, many different city, country, and regional rankings are being used to present various kinds of information about sustainable development and corporate social responsibility (CSR) [21,38–46]. However, these rankings concentrate on the NTS-3 level or higher, or exclusively on metropolitan areas. Their main focus is not, however, on the sustainability of the local creative industries.

### **3. The Research Approach**

The general perspective for our research approach was defined by the necessity to direct the attention of decision makers towards the role of public administration in sustaining economic growth in middle-income countries such as Poland. Our specific research goal was to discover the possible relationships between higher-level indicators of the creative economy at the local level and the actions and attitudes of local governments. On the basis of those relationships, we envisaged to propose a conceptual model for local governments. Local governments, especially in larger cities, dispose of substantial budgets for stimulating local economic development. It would be wise to provide them with direction and highlight opportunities for more efficient investments of public funds into sustainable development. The funds could also be channelled to support preconditions for the development of creative industries. As the outputs of the creative industries are associated with the ability of people to think creatively or metaphorically, to challenge conventionalists and to call for symbolic and affective communication [47], we believe that the emotional and social aspects of the local environment's interventions play a crucial role in determining the proliferation of creativity at the local level. In our research, we aimed to utilise the empirical results from our study conducted in 2017 concerning Polish counties in the form of a conceptual model. The research sample consisted of 826 responses obtained



from the representatives of 80% of Polish counties. There were two main reasons for choosing to research the NTS-4 units (counties) rather than regions (NTS-2) or sub regions (NTS-3):

1. Scarcity of data on NTS-4 units. Many national and European Union (EU) statistics limit their scope of research on the creative industries to regions neglecting smaller entities.
2. Many predictions say that it will be the cities that will be the key players in economic development of the future (NTS-4 level includes cities and towns). Cities play an increasing role in overall economic development as 55% of the world's population lives in urban areas, a proportion that is expected to increase to 68% by 2050 [48]. There are 39 large and middle-sized towns with population 100,000+ inhabitants in Poland. Creative economies are predominantly concentrated in towns, cities, and metropolitan areas (which correspond with the county NTS-4 level in regional development analysis), and consequently their development heavily depends on the scale of support from the local governments.

In Poland, public administration is divided into central government structures and local government structures. The local government administration includes inter alia counties and cities that function as and have the tasks of counties. A county always covers a few municipalities (smaller territorial units, *gmina* in Polish) and does not necessarily have to be a city. In Poland, every county is comprised of several communes (*gminy*). Efficient cooperation between the authorities of the county and the authorities of the communes is crucial for sustainable development. Simultaneously, big cities (owing to their significant area and population) may constitute a local government unit in their own right, enjoying the rights of a county. The authors are of the opinion that sustainable development of a county that is not a city and sustainable development of cities enjoying the rights of a county can be measured using the same model.

In the years 2014–2015, we conducted exploratory research in the form of in-depth interviews with representatives of 105 Polish counties. They included councilors and mid-level administrative staff from county offices. Our research was conducted for a problem that has not been studied more clearly, intended to establish priorities, develop operational definitions, and improve the final research design. Interviews concerned on the role of intellectual capital and the other drivers of development of Polish counties. Another field of research was hindrances to sustainable development. Exploratory research helps determine the best research design, data-collection method, and selection of subjects. The exploratory research allowed us to fine-tune the research questions (RQ) for the main national research.

Afterwards, we launched the national survey, aiming to reach the representatives of all 380 Polish counties (including 69 Polish cities and towns). The recruitment process for the online survey was conducted by means of sending a total of 7000 e-mail requests to potential participants of the study. We used several databases and the websites of individual counties to identify prospective informants. Over half of the participants of the survey (52.9%) were employees of municipalities. The remainder were experts on local governments, including scholars. Nearly one-quarter of the respondents (23.5%) were from the eastern macro-region (NTS-3), 20.2% from the north-west macro-region, 15.9% from the southern macro-region, 16.1% from the north macro-region, and 7.7% from the southwestern macro-region (which is the smallest macro-region of Poland in terms of population). The highest response rate of the counties came from the Warmińsko-Mazurskie region of 95.2% and Podlaskie region of 94.1%. The smallest response rate was achieved from the Lubuskie region (64.3% of all counties).

The research consisted of four parts. In the first part, we evaluated the current state of sustainable development in Polish cities. Among the different factors related to the sustainable development, both positive and negative factors were identified. We also analysed the quality of leadership in the counties. The research also looked at the future prospects of sustainable development in the counties, based on the opinions of respondents.

On the basis of our exploratory research, we postulated the following research questions, which will be discussed in Sections 4.1–4.4:

- **Research Question 1 (RQ 1).** What were the drivers of sustainable development in county local governments in the past, as well as what will be the drivers in the future?
- **Research Question 2 (RQ 2).** What were the hindrances to sustainable development in the economies in the past?
- **Research Question 3 (RQ 3).** What was the role of the business climate and the conditions for the development of a creative economy?
- **Research Question 4 (RQ 4).** What was the role of public management in counties (including the business climate and climate for the creative class, as well as the quality of local leadership in counties)?
- **Research Question 5 (RQ 5).** Which elements of intellectual/human capital as a driver of sustainable development in counties played the most important role?

The ranking factors will be based on the above-mentioned research findings. The highest positions will be assigned to those factors that have the highest values. Thus, the most important factors for sustainable development in counties will be identified.

While developing the model of sustainable development measurement for counties, we drew heavily on existing models of intangible asset measurement. Specifically, we took under consideration the renowned balanced scorecard model (BSC) [49–57] and concept of the intellectual capital statement (InCaS) [58–64].

Although research focusing explicitly on sustainable development is not an entirely new field, there does not exist a substantial body of work that combines economic growth models with sustainability issues and the creative economies perspective. Our model was developed based on the empirical results gleaned from a survey among the representatives of 80% Polish counties (826 respondents).

On the basis of the research findings, a model for the sustainable development of a county will be proposed (in Section 5). We believe that our model may contribute to strengthening the environmental, economic, and social dimensions of sustainable development in county local governments, as proposed by the United Nations.

The model proposed by the authors will make it possible to make local level comparisons between smaller administrative units across the world. The model offers an opportunity to create a global context for information about the sustainable development and intellectual capital (IC) in counties.

## **4. Research Findings**

### *4.1. Drivers and Hindrances for Sustainable Development in County Local Governments*

On the basis of the world’s literature review, a series of 105 interviews with experts, and the online survey on sustainable development in county local governments, we identified the following 15 factors (FC1–FC15) related to sustainable development.

Table 1 illustrates the list of factors that were especially important for the development of the analysed counties in the last 10 years (2005–2014) and those factors that will, according to the participants of the study, be the most important in the next 10 years (2016–2025). A ranking of factors is also included in the table.

FC1 remained the most important factor in the case of both past and future perspectives. Surprisingly, FC2 lost its position in the ranking, falling from 2 to 5. FC7 may be of a twofold nature. Firstly, the fast expansion of the Polish road system allows for higher mobility of people in many parts of Poland, which used to be excluded from easy access to main economic centres. Another explanation may be the growth of service industries, which is supported by online services and communication.

Nonetheless, the top three most important factors of sustainable development of counties in the future are as follows: ‘engagement of local authorities’ (FC1 = 45.9%); ‘good accessibility by airplane, train, and road’ (FC3 = 41.4%); and ‘well-developed SMEs (small to medium-sized enterprise) sector’ (FC5 = 35.4%).

**Table 1.** Drivers for sustainable development of county in the past (2005–2014) and future (2015–2020).

Factors Conducive for Sustainable Development (FC)	Especially Important for the Development of Our County in the Last 10 Years		Especially Important for the Development of Our County in the Next 10 Years	
	Past		Present	
	%	Rank	%	Rank
FC1. Engagement of local authorities	38.6	1	45.9	1
FC2. Green environment	38.1	2	33.1	5
FC3. Good accessibility by airplane, train, and road	35.5	3	41.4	2
FC7. Proximity of a metropolitan area	27.0	7	22.0	12
FC8. Existence of large enterprises and reputable employers in the local community	26.5	8	25.5	10
FC9. Commitment and passion of local leaders	24.6	9	29.2	6
FC10. High-level of civic engagement (high voter turnout, participation in associations)	23.0	10	27.7	8
FC11. Quality of the cultural offer	22.0	11	22.2	11
FC12. Well-educated citizens	21.7	12	26.5	9
FC13. Professional staff employed at the county offices	21.2	13	21.2	13
FC14. Convenient location and connections with the capital city	17.2	14	18.0	15
FC15. R&D (research and development) activities in the county (knowledge-intensive businesses, universities, R&D centres)	9.8	15	20.9	14

Source: authors' calculations.

The following positions relating to the future were occupied: “existence attractions drawing in the visitors” (FC4 = 33.5%), “green environment” (FC2 = 33.1%), “commitment and passion of local leaders” (FC9 = 29.2%), and “quality of the local system of education (system of primary, secondary, and tertiary education)” (FC6 = 27.8%). The results reveal that FC9 in the past perspective occupied the remote 9th position, but in the future perspective, it took the higher 6th place. Thus, FC9 appeared to be more important for the future development compared with the past.

The position of the majority of factors was unchanged (e.g., FC4, FC11, FC13), or only slightly changed (e.g., FC14). The least important factors both in the past and in the future were the following: FC7, FC11, FC13, FC14, and FC15. The results obtained allow to state that most of representatives of the counties expect that the factors of development of the counties that were important in the past would also be important in the future. Only some of them see the change of importance of factors conducive for sustainable development in the future.

In a like manner, ten factors hindering (FH1–FH10) sustainable development in county local governments were identified. Table 2 includes the list of factors with the strongest negative impact on sustainable development in the Polish counties in the 10 years prior to the survey (2005–2014). A ranking of factors is also included in the table.

**Table 2.** Hindrances for sustainable development of county in the past (2005–2014).

Factors Hindering the Sustainable Development of County (FH)	Especially Important for the Development of Our County in the Past (2005–2014)	
	%	Rank
FH1. Poor quality of environment	47.0	1
FH2. Resentment towards strangers	42.9	2
FH3. Lack of tourist attractions	34.3	3
FH4. Poor quality or insufficient provision of higher education	30.2	4
FH5. Low access to cultural goods and institutions	26.9	5
FH6. Poor accessibility by road, train, and airplane	25.1	6
FH7. A deficit of agents of change and local leaders (e.g., social workers, civic leaders, volunteers, and so on, as well as socially conscious people)	22.3	7
FH8. Low entrepreneurship levels	17.8	8
FH9. Social exclusion (cause of poverty, conflict, and effect of unemployment)	9.6	9
FH10. Talent migration to other counties in Poland	6.5	10

Source: authors' calculations.

According to the participants of the study, the top five factors hindering sustainable development in the past were FH1–FH5. All of them can be considered creative economy-related factors. For example, tolerance and homophobia are explicitly mentioned in the 3T model of creative economy developed by Florida [5,6]. According to the participants of the study, the following factors were least impactful for sustainable development: FH8, FH9, and FH10. The results show that, in the counties, only rarely were talent migration to other countries and social exclusion the important factors hindering the sustainable development. In the case of those counties, it is necessary to change the priorities of local public management in order to retain talented citizens and improve the social situation of the poorest people.

Table 2 reveals that the most important factor hindering the sustainable development of a county is a poor quality of environment.

Table 2 reveals a real problem with the environment and puts great importance on regulations that ensure improvement of the environment. As it appears, the natural environment plays a key role in the opinions of the participants of the study. The high priority attached to the natural environment reflects favourable conditions in Polish counties for energy transition policy, which is a challenge for the Polish economy (in 2017, Poland’s greenhouse gas emissions increased by 4 % compared with 2016). According to the Agora Energiewende experts between 2020 and 2035, about 60 power plants constructed in the 1970s are expected to retire. This accounts for more than 50 percent of currently installed capacity. It presents a major modernization and investment challenge that is discussed against the backdrop of concerns about energy supply security, clean air—particularly in cities—climate change, and rapidly declining costs for renewable energy. Thus, Poland aims to gradually increase renewable energies like solar, wind, and hydroelectric power. Local governments are now involved in the recently launched programme by the Polish government “Mój Prąd” (My energy), distributing government subsidies for the purchase of PV panels [65].

Resentment towards strangers is the second most important factor hindering the sustainable development of a county. It displays problems with accepting people coming from other regions of a country by citizens of the county. The abovementioned factor means that, very often, entrepreneurs as well as employees from other counties face some more difficulties than the local citizens of the county.

#### 4.2. Evaluation of the Local Business Climate and Conditions for the Development of Creative Economy

On the basis of the main themes recurring in the literature on creative economy development, one can identify some factors that describe the strength and vitality of a creative economy. They would include overall tolerance and a variety of freedoms, for example, freedom of speech, political freedom, education and skills of local citizens, well-developed knowledge-intensive services, entrepreneurship, efficient institutions and public administration, and others. In our survey, the respondents were asked to evaluate the following six propositions (business climate and creative class (BC1–BC6)).

Table 3 presents the distribution of answers related to entrepreneurship and creative economy. A ranking of factors is also included in the table. The highest positions in the ranking are occupied by the results that obtained the highest number of the ‘Strongly agree’ and ‘Agree’ answers.

The respondents indicated the following factors as the most impactful for sustainable development of the county in the future:

1. A climate conducive for success-driven, creative businesspersons (BC1 = 66.7%);
2. Friendliness of local government to entrepreneurs (BC2 = 65.6%);
3. Opportunities for talent development for well-educated and creative citizens (BC3 = 59.4%).

Over 46% of respondents are of the opinion that all entrepreneurs get equal opportunities for success in their own county (BC5 = 46.4%). Over 22% of respondents are of the opinion that talented and creative people will emigrate from their county/municipality in search for better opportunities (BC6). At the same time, however, over 68% of respondents are of the opinion that talented and creative people will not emigrate (BC6). Only 17.6% of the respondents believe that foreign entrepreneurs willing to start a business in the municipality or county could not encounter obstacles and hostility (BC4).

**Table 3.** Business climate and climate for creative class (BC).

Prospects for Entrepreneurs and Creative People	Rank	1. Strongly Agree	2. Agree	3. Undecided	4. Disagree	5. Strongly Disagree
BC1. A highly-motivated entrepreneur is likely to succeed with his business	1	22.4	44.3	14.9	14.2	4.2
BC2. County officials support and assist the local entrepreneurs	2	22.9	42.7	15.5	13.1	5.8
BC3. All entrepreneurs are getting equal opportunities	3	15.6	43.8	13.3	21.5	5.7
BC4. Foreign entrepreneurs wanting to establish a business in the city-county could face obstacles and hostility	4	20.2	35.8	26.4	12.6	5.0
BC5. Well-educated and creative citizens may develop their talents	5	10.8	35.8	18.6	24.9	9.8
BC6. Well-educated and creative citizens emigrate from our county in search for better opportunities	6	6.1	16.2	9.6	37.7	30.4

Source: authors' calculations.

#### 4.3. The Quality of Public Management in Counties

In the following section of our survey, we asked about those factors that, according to the respondents, would spur economic growth in their county in the future by means of increased financial investments and non-financial interventions. Possible areas of intervention included the two following groups of factors (IP) (see Table 4):

1. Directly involving financial expenditure, for example, hard infrastructure (road, water resources), public transport, healthcare, public security, pre-school education, and cultural institutions.
2. Requiring organizational support or changing the directions of intervention, for example, marketing of the county as a site for home and foreign investment.

**Table 4.** Investment priorities for the future (IP).

Investment Priorities for the Future	%	Rank
IP1. Preventing brain drain	45.3	1
IP2. Hard infrastructure (road, water resources)	43.5	2
IP3. Marketing of the county as a site for home and foreign investment	43.2	3
IP4. Vocational education	34.6	4
IP5. Support for grass-roots initiatives of citizens	32.2	5
IP6. Development of civic society	31.2	6
IP7. Public transport	27.8	7
IP8. Healthcare	27.7	8
IP9. Pre-school education	24.3	9
IP10. Tourist infrastructure	22.9	10
IP11. Marketing of the county as a tourist destination	20.0	11
IP12. Support for talented students	19.2	12
IP13. Cooperation with other local-government offices	17.7	13
IP14. Sports and cultural events	15.1	14
IP15. Municipal administration and environmental protection	14.4	15
IP16. Public security	13.7	16
IP17. Cultural institutions	9.2	17
IP18. Training for municipal staff	6.8	18
IP19. Increase of Internet accessibility	6.5	19
IP20. Support for organizations and lobbying groups working in the interest of the county on the national scene	5.6	20
IP21. Countermeasures for intolerance, racism, and homophobia	4.0	21

Source: authors' calculations.

The results show that the most preferred areas of intervention in the future are the following:

- "Preventing brain drain" (investment perspective (IP)1 = 45.3%);
- "Hard infrastructure (road, water resources)" (IP2 = 43.5%);

- “Marketing of the county as a site for home and foreign investment” (IP3 = 43.2%);
- “Vocational education” (IP4 = 34.6%);
- “Support for grass-roots initiatives of citizens” (IP5 = 32.2%).

The areas that require the highest financial investments include the following: “Hard infrastructure” (IP2 = 43.5%), “Vocational education” (IP4 = 34.6%), “Public transport” (IP7 = 27.8%), “Healthcare” (IP8 = 27.7%), “Pre-school education” (IP9 = 24.3%), “Tourist infrastructure” (IP10 = 22.9%), “Municipal administration and environmental protection” (IP15 = 14.4%), and “Public security” (IP16 = 13.8%).

The non-financial interventions are the following: “Preventing brain drain” (IP1 = 45.3%), “Marketing of the county” (IP3 = 43.2%), “Support for grass-roots initiatives of citizens” (IP5 = 32.2%), “Development of civic society” (IP6 = 31.2%), “Marketing of the county as a tourist destination” (IP11 = 20%), “Support for talented students” (IP12 = 19.2%), and “Cooperation with other local-government offices” (IP13 = 17.7%).

Those factors that are directly related to the creative economy—such as “Sports and cultural events” (IP14); “Cultural institutions” (IP17); “Increase of Internet accessibility” (IP19); or “Countermeasures for intolerance, racism, homophobia” (IP21)—are not preferred areas of intervention. IP21 describes extremely negative attitudes, especially towards foreigners or homosexual people. On the basis of our research results, we conclude that such attitudes and behaviours do not pose a serious problem. IP21 should not be associated with resentment towards strangers. In this case, “strangers” include inhabitants of other counties and other regions, as well as foreigners. Resentment manifests itself in lower propensity to collaborate and lower trust. It is a passive attitude, whereas IP21 is an active attitude. “Development of civic society” (31.2%) may be one of the measures aimed at the reduction of resentment towards strangers.

Another aspect of sustainable development that was subject to our research was the quality of local leadership. Good quality leadership is considered one of the key attributes of effective organisations. The quality of leadership may also explain the differences in the rate of growth among counties. The participants of our survey were requested to evaluate the quality of leadership in 12 factors (QL1–QL12) characterising the local leader (the city mayor or district foreman (starosta)). The highest values were attributed to the following factors:

- The city mayor/district foreman (starosta) supports the cooperation between the local government and NGOs (non-government organization) (QL1 = 63.0%);
- The city mayor/district foreman (starosta) cooperates with other counties (QL2 = 64.5%);
- The city mayor/district foreman (starosta) efficiently cooperates with the communes belonging to the county (QL3 = 61.8%);
- The city mayor/district foreman (starosta) cares about entrepreneurship (QL4 = 59.3%);
- The city mayor/district foreman (starosta) well represents the county on national level (QL5 = 59.1%);
- The city mayor/district foreman (starosta) is a competent leader (QL6 = 57.5%).

Slightly more than 31.0% of respondents expressed negative opinions about the leader who was holding the position of the city mayor/district foreman (starosta). A total of 32.3% of respondents were of the opinion that the leader favours some interest groups, and 31.2% of respondents agreed with the statement that the leader avoids making important for the country decisions.

Table 5 presents the opinions of the respondents regarding the local leader who was serving his/her tenure in 2015.

**Table 5.** The quality of local leadership in counties (QL).

Opinions on the Local Leader	Rank	1. Strongly Agree	2. Agree	3. Undecided	4. Disagree	5. Strongly Disagree
QL1. Supports the cooperation between the local government and NGOs	1	23.4	39.6	21.2	10.7	5.1
QL2. Cooperates with other counties	2	26.3	38.2	24.6	9.2	3.7
QL3. Efficiently cooperates with the communes belonging to the county	3	27.1	34.7	19.5	12.9	5.8
QL4. Cares about entrepreneurship	4	22.2	37.1	20.6	16.0	4.0
QL5. Well represents the county on national level	5	28.9	30.2	23.5	11.7	5.7
QL6. Is a competent leader	6	26.8	30.7	19.1	15.3	8.1
QL7. Is respected by the citizens	7	15.0	38.1	26.5	13.6	6.8
QL8. Supports trust-building among citizens	8	17.9	31.8	26.4	16.8	7.2
QL9. Supports persons who have original ideas	9	16.6	29.1	33.0	14.3	6.9
QL10. Fights against xenophobia and hostility against minorities	10	17.5	24.4	44.9	9.0	4.1
QL11. Favours the interests of selected interest groups and institutions	11	10.8	21.5	23.5	25.3	19.0
QL12. Avoids making important, but unpopular decisions	12	9.5	21.7	23.6	29.2	16.0

Source: authors' calculations.

#### 4.4. Intellectual/Human Capital as a Driver of Sustainable Development in Counties

It is generally agreed that intellectual/human capital (IC/HC) has a stronger positive impact on the pace of development of public entities than material assets [35,37,49,60–64]. In order to verify this popularly expressed in the literature conviction, we were interested in the identification of those factors that could have a positive impact on the development of a county. We divided those factors into two groups. One was related to intangible/intellectual capital, and the other to immaterial/traditional/"brick-and-mortar" factors. We were interested in the actual perception of the relative importance of the two groups of factors. Do IC-related factors indeed play a more important role in sustainable development in the 21st century than the old-economy factors? The group of IC/HC-related factors included the following:

1. Engagement of local authorities;
2. Well-developed system of education;
3. Commitment and enthusiasm of local leaders;
4. Civic engagement;
5. Quality and quantity of the cultural offers;
6. Well-educated citizens;
7. Competent municipal staff;
8. R&D activities in the county.

Contrary to our expectations, the research findings did not reveal the prevailing role of intangible assets in the sustainable development of Polish counties. Only 5% of respondents, who could be dubbed "IC/HC proponents", placed 100% of their indications on IC/HC-related factors. Further, 50% of the respondents mentioned not more than 40% of IC-related factors among their top-five most important factors for sustainable development.

The aim of the analysis was to verify the following two hypotheses:

**Hypothesis 1 (H1).** *If the authorities of a county give higher priority to the IC/HC development than to material infrastructure, the county achieves higher long-term results in its socio-economic development.*

**Hypothesis 2 (H2).** *Investments in IC/HC are more profitable to the county than investments in the material infrastructure.*

In order to test the H1 hypothesis, a correlation analysis between the set of indices calculated for the variables related to the socio-economic development of counties in the long period (2015 vs. 2006) and the indices for the preference of IC/HC was conducted. The data on socioeconomic development were obtained from Bank of Local Data (BDL) of the Polish Statistical Office (GUS). The indicators for the preference of IC/HC were based on our survey's results.

We selected the following indices calculated on the basis of the available statistical data on Polish counties:

- Number of registered companies;
- Unemployment rate (%);
- Average gross monthly salary (PLN);
- Population;
- Change in GDP per capita (PLN);
- Migration balance between counties (2006–2015) versus population in 2015.

In the case of three variables—number of registered companies, average gross monthly salary, and change in GDP per capita—the Pearson correlation coefficient, which is the measure of the linear correlation, was very low and indicated no correlation with the IC/HC-preference index in counties.

In the case of the unemployment index, a positive moderate relationship was observed with the IC/HC-preference index ( $r = 0.510$ ), which means that the higher preferences for IC/HC, the higher the value of the unemployment rate. The relationship between these variables may be bi-directional or indirect relationship may even occur. It is possible that the analysed period is too short to find the positive impact of IC/HC on the labour market. The higher preference in the county for IC/HC may result also from insufficient material infrastructure and insufficient funds to change the situation in these areas.

The indices of population of counties and the migration balance between counties (2006–2015) versus population in 2015 reveal a moderate negative relationship with the IC/HC-preference index in counties (the Pearson correlation coefficient amounts to  $-0.429$  and  $-0.672$ , respectively), which means that, as the preference for IC/HC increases, the dynamics of growth in population in counties decreased, and additionally, the cumulative balance of cross-county migrations (2006–2015) decreased in relation to the total population in the county in 2015. It is worth emphasising that the higher the IC/HC-preference, index the lower the preference for material infrastructure.

Our findings reveal that those counties that prefer material infrastructure investments to IC/HC-related investments (based on our survey) achieve better long-term results in socio-economic development (on the basis of statistical data from the Polish Statistical Office (GUS)). As a positive relationship was expected, Hypothesis H1 is thus rejected.

In order to verify the Hypothesis H2, a correlation analysis between the IC-preference indicator (based on the survey results) and the variable describing the dynamics of changes in the period 2006–2015 and the per capita budget income in a county in 2015 achieved by counties (add communes belonging to them) and city-counties (derived from the Polish Statistical Office) was conducted. Hypothesis H2 stated that investments in IC/HC are more profitable to the county than investments in the material infrastructure. The budget revenues index per capita in a county in the period 2006–2015 does not reveal a relationship with the IC/HC-preference index in counties ( $r = -0.048$ ). The results indicate that higher preferences for IC/HC do not result in higher long-term dynamics of budgetary incomes for counties in the years 2006–2015. On the contrary, the budgetary income per capita in counties in 2015 reveals a strong negative relationship with the IC/HC-preference index ( $r = -0.711$ ). The higher the preference for IC/HC, the lower the budgetary income for counties and city-counties (including the communes belonging to the county) in 2015. The results report a negative relationship.



Thus, Hypothesis H2 is also rejected. One of the possible explanations for the rejection of H2 is the fact that the economic situation of a county is the result of interaction of a number of different factors, which vary in importance in different locations, and is the combined effect of processes at regional, national, and international level. Many counties benefit from public investments from regional and central government funds, which may have a substantial impact on the overall economic situation of a county. Many of those investments are determined by the geographical location of a county. The rejection of H2 may be explained by lower relative importance of IC/HC in shaping the income of the county compared with other factors.

The factors that were the most important in explaining the prospects for future development of a county in the years 2016–2025 include the following: “engagement of local authorities”, “transport accessibility”, “large number of SMEs”, “tourist attractions in the county”, and “good quality of the natural environment”. The share of respondents who indicated those factors ranged from 33.1% to 45.9%. The set of the top five most important determinants of sustainable development in counties for the future was identical with the set of indicators for the years 2005–2014. However, there was a difference in the hierarchy of those factors and the share of respondents indicating the following factors: “engagement of local authorities” (increase by 7.3 points), “large number of SMEs” (increase by 5.9 points), and “transport accessibility” (increase by 4.4 points). In the case of the two remaining factors, the share of respondents who indicated them was lower by  $-0.6$  and  $-5.1$  points.

## **5. A Conceptual Model for Sustainable Development in Counties**

The conceptual model presented further in the text is based on the review of world literature, and our empirical findings from a survey conducted in Polish counties in 2017. The model emphasises the need for looking at creativity as a (potentially) sustainable resource to be cared for and looked after by the local government. The application of our model offers the following opportunities for local governments:

1. Developing benchmarking scorecards for comparing local government units using a set collection of metrics. This can be applied to measure the performance of a local government and compare it to that of other local governments over time. Such an approach will often include looking at the practice behind individual metrics as well. Local governments will be able to define “good practices” for specific metrics and compare them to their own approaches and practices.
2. Answering the needs of increasingly environment-concerned citizens who expect from municipalities greater engagement in the climate issues.
3. Supporting cooperation between municipalities regarding sustainable development, including international cooperation and cross-border cooperation.
4. Aligning local strategies for development with the global priorities, including the Sustainable Development Goals as described by the UN [17].

While developing a conceptual model for measurement of the balanced development, we drew on the concept of the balanced scorecard (BSC) developed by Norton and Kaplan [50,52,53]. The first publication on using indicators in management practice should be attributed to Drucker [51]. In a similar vein, we argue that, for the purpose of a sustainable economy, public entities should use certain variations of scorecards. We believe that our model is an applicable and relevant concept in strategic management of counties because any local government can use it. The original concept of the BSC was adapted for non-profit and municipal entities. Today, in Poland, a wide variety of non-for profit and for-profit organisations use it.

The core elements of the BSC by Norton and Kaplan are four perspectives [50,52–57]:

- The financial perspective, which concentrates on such issues as cost savings and efficiencies, profit margins, and revenue sources;
- The customer perspective, which concentrates on such issues as customer service and satisfaction, brand awareness, and market share;

- The internal process perspective, which concentrates on such issues as process improvements or quality optimisation;
- The learning and growth perspective, which concentrates on such issues as IC (HC—talent, skills, and knowledge and organisational capital (OC)—culture, information assets, employee alignment, leadership, knowledge management, and teamwork).

On the basis of the literature review and the research findings presented in Sections 4.1–4.4, we developed a conceptual model for counties. Our conceptual model consists of four perspectives important for the development of counties and highlights the factors that are of importance for sustainable development:

- The citizens’ perspective, including the quality of local leadership in counties and responsiveness to the citizens’ needs in the past and the future. This perspective refers to the FC factors in Table 1.
- Business climate and creative class perspective, including the financial and non-financial incentives for companies and for the creative class in the past and the future. We consider talented citizens as a special sub-category of citizens in a county, which is a crucial part of the local workforce. This perspective refers to the BC factors in Table 3.
- Investment perspective, including financial and non-financial investments of the county in the past and the future. This perspective refers to the IP factors in Table 4.
- The good governance perspective, including management competences of public administration in the past and the future, implementation of management models, and quality assurance. This perspective refers to the QL factors in Table 5.

Vision and mission are the starting point for strategic planning and corporate objectives. For each of the perspectives a set of strategic objectives, indicators and measurement units related to the vision and mission statement should be developed. They have to be well balanced, which means that none of the perspectives dominates over the other three. The balanced scorecard includes both tangible and intangible elements of the total assets of an organisation. According to the philosophy of the BSC, attention is focused on what is achieved and not how it is achieved. The balanced view of the organisation means that both qualitative and quantitative results are reviewed [50,52–57].

In our model, we applied the philosophy for the purpose of local government management as presented in Figure 1.

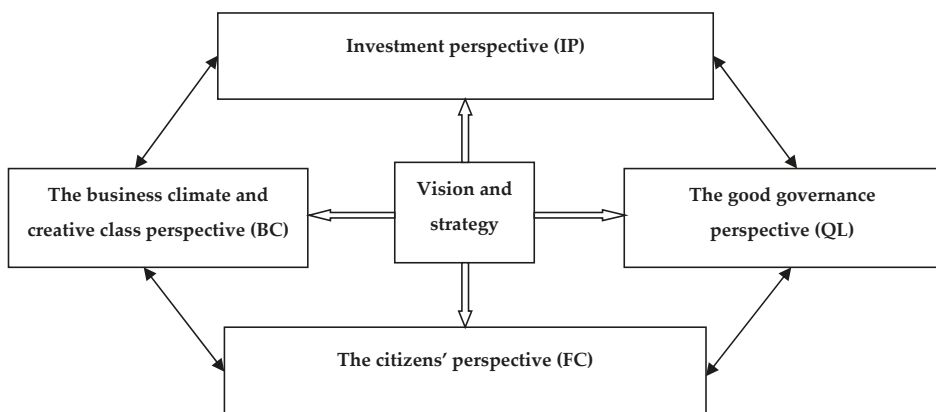

Figure 1. A sustainable development model for counties. Source: authors.

Our model examines the four perspectives of creative economy development:

1. Positive factors for sustainable development (FC);

2. Business climate and climate for talented citizens in counties (BC);
3. Financial investment into tangible and intangible assets in the future (IP);
4. The quality of local leadership in counties (QL).

The model draws heavily on the previous work done by a number of researchers, who have looked more closely at patterns in the use of the BSC in practice [66]. We made an assumption that the vision and strategy statements have an impact on each of the four management perspectives in the BSC. We did, however, analyze the relationships between the four perspectives.

In order to adapt the BSC concept to the context of sustainable development, we also applied the intellectual capital statement (InCaS) approach [59–63]. The InCaS consists of five stages that can be adopted for the purpose of sustainable development measurement.

Figure 2 presents the stages of the balanced development model for counties based on the intellectual capital measurement concept according to InCaS. In our opinion, following the InCaS procedure enables an efficient implementation of our conceptual model in counties (regions). The management of a municipality should consider the following steps:

- (1) define the most important factors for sustainable development of a county (region);
- (2) establish the current value for each factor;
- (3) estimate the planned value;
- (4) propose the expected progress rate (%);
- (5) establish the improvement potential (%) (100% minus progress rate).

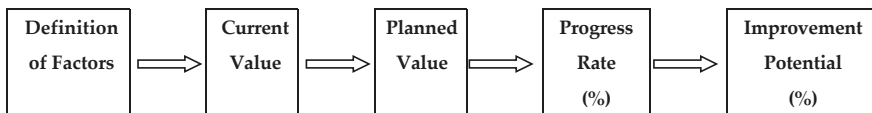

**Figure 2.** The stages of the balanced development model for counties based on the intellectual capital statement (InCaS). Source: authors.

Our model of balanced development of creative economy consists of four perspectives, and a number of indicators and measurement units related to the vision and mission statement should be developed and attributed to each of them. We selected the most important factors, which were identified based on our empirical study described in Sections 4.1–4.4.

Table 6 presents the proposed indicators or measurement units for a sustainable development model in counties.

The conceptual model presented here may be adjusted to the local context of each individual county. As new technologies, concepts of sustainable development, and methods of production emerge (e.g., artificial intelligence, zero-emission cities, sharing economy), the indices describing each of the perspectives should evolve. As a matter of fact, the selection of indicators is by itself a strategic decision. Regular measurement and reporting of the selected indicators will keep the local government focused. The data needed to implement the model may be collected from the following:

- General statistical information released on regular basis by the National Statistical Office;
- Local surveys conducted by county staff among local organizations;
- Content and sentiment analysis on online social networks;
- Surveys commissioned by the county administration.

**Table 6.** Proposed indicators or measurement units for the sustainable development model in counties.

Key Elements of Creative Economy	Factors	A Proposed Measure
<b>The Citizens' Perspective (FC)</b>		
<b>Positive factors for sustainable development (FC)</b>	Existence attractions drawing in the visitors	<ul style="list-style-type: none"> <li>• Number of new tourist attractions</li> <li>• Number of bed nights, or beds/night (a measure of occupancy of one person (assigned to one bed) for one night)</li> <li>• Number of tourists visiting tourist attractions in the county</li> </ul>
	Good accessibility by airplane, train, and road	<ul style="list-style-type: none"> <li>• Density of road network in the country</li> <li>• Network connectivity [60]</li> </ul>
	Proximity of a metropolitan area	<ul style="list-style-type: none"> <li>• Distance from a metropolitan area</li> </ul>
	Convenient location and connections with the capital city	<ul style="list-style-type: none"> <li>• Number of direct train and flight connections with the capital city</li> <li>• Total time of travel by road to the capital city</li> </ul>
	Quality of the local system of education	<ul style="list-style-type: none"> <li>• Number of students per school</li> <li>• Impact factor (IF) achieved by local higher education institutions</li> <li>• Number of students per 10,000 population</li> <li>• Share of international students</li> </ul>
	Commitment and passion of local leaders	<ul style="list-style-type: none"> <li>• Reputation of local leaders among citizens (results from opinion polls, social media sentiment analysis)</li> </ul>
	Engagement of local authorities	<ul style="list-style-type: none"> <li>• Popularity among citizens (results from opinion polls, social media sentiment analysis)</li> <li>• Position in national ranking of counties (results from opinion polls, social media sentiment analysis)</li> <li>• Image among citizens of the county</li> <li>• Majority margin achieved in local elections</li> </ul>
<b>Positive factors for sustainable development (FC)</b>	Existence of large enterprises and reputable employers in the local community	<ul style="list-style-type: none"> <li>• Number of large-scale enterprises</li> <li>• Number of companies listed on the stock exchange</li> <li>• Number of companies with 500+ employees</li> </ul>
	Professional staff employed at the county offices	<ul style="list-style-type: none"> <li>• Share of employees with a higher education degree</li> <li>• Participation in life-long learning (LLL) among employees</li> <li>• Participation in LLL—number of training hours</li> <li>• Share of councillors with higher education degree in the county council</li> </ul>
	Well-educated citizens	<ul style="list-style-type: none"> <li>• Expenditure on education per capita</li> <li>• Share of citizens with higher education degree</li> <li>• Share of citizens with PhD degree</li> </ul>
	Civic engagement	<ul style="list-style-type: none"> <li>• Regular volunteer for non-electoral organization</li> <li>• Worked with others to solve community problem</li> <li>• Active membership in a group</li> </ul>
	Well-developed SMEs sector	<ul style="list-style-type: none"> <li>• Number of SMEs per 10,000 inhabitants</li> <li>• Number of newly registered companies</li> <li>• Credit availability for SMEs</li> <li>• Employment growth</li> </ul>
	R&D activities in the county	<ul style="list-style-type: none"> <li>• R&amp;D expenditure</li> <li>• Number of R&amp;D centres</li> <li>• Number of higher education institutions located in the county</li> <li>• Number of patents filed originating from the county</li> <li>• Impact factor (IF) of publications published in the county</li> <li>• Number of knowledge-intensive companies</li> <li>• Private R&amp;D expenditure in the county</li> </ul>

Table 6. Cont.

Key Elements of Creative Economy	Factors	A Proposed Measure
	Quality of the cultural offer	<ul style="list-style-type: none"> <li>• Number of concerts</li> <li>• Number of festivals</li> <li>• Number of theatres</li> <li>• Number of museums</li> <li>• Public expenditure on culture</li> </ul>
	Green environment	<ul style="list-style-type: none"> <li>• Public expenditure on environment protection</li> <li>• Investments in green energy</li> <li>• Size of green economy in the county</li> <li>• Share of green jobs</li> </ul>
<b>The Business Climate and Creative Class Perspective (BC)</b>		
<b>Business climate and creative class (BC)</b>	A highly motivated entrepreneur is likely to succeed with his business	<ul style="list-style-type: none"> <li>• Number of success stories (“from zero-to-hero”)</li> <li>• Local gross domestic product (GDP) growth vs. regional and national benchmark</li> <li>• Employment growth in innovative businesses</li> </ul>
	County officials support and assist the local entrepreneurs	<ul style="list-style-type: none"> <li>• Average time from approaching the local authorities to launching a full-time business</li> <li>• Venture capital investments in the county</li> <li>• Reputation among foreign investors</li> </ul>
<b>Investment Perspective (IP)</b>		
<b>Financial investment into tangible and intangible assets in the future (IP)</b>	Vocational education (VET)	<ul style="list-style-type: none"> <li>• Number of VET schools in the county</li> <li>• Engagement of local employers in VET</li> <li>• European Union (EU) funding for VET-education</li> </ul>
	Support for grass-roots initiatives of citizens	<ul style="list-style-type: none"> <li>• Size of citizens’ budget</li> <li>• Responsiveness of authorities to local initiatives and demands</li> </ul>
	Development of civic society	<ul style="list-style-type: none"> <li>• The civil society index (CSI) (55)</li> </ul>
	Public transport	<ul style="list-style-type: none"> <li>• Share of population with a (very) high access to public transport</li> <li>• Population-weighted median number of hourly departures in urban centres</li> <li>• Share of low-emission public transport</li> </ul>
	Healthcare	<ul style="list-style-type: none"> <li>• Density of physicians (total number per 1000 population)</li> <li>• Overall age-adjusted mortality rate per 100,000 population</li> <li>• Wait times for specialist visits</li> <li>• Number of beds and the types of services available</li> <li>• Patient mortality rates by type of condition</li> <li>• Patients’ reports on the timeliness of care and service they received from the hospital</li> <li>• Percentage of patients receiving recommended hospital care for specific conditions</li> <li>• Rates at which patients fall and incur injury during a hospital stay</li> </ul>
	Pre-school education	<ul style="list-style-type: none"> <li>• Share of children aged between 4 and the age of starting compulsory education in early childhood education</li> </ul>
<b>Financial investment into tangible and intangible assets in the future (IP)</b>	Tourist infrastructure	<ul style="list-style-type: none"> <li>• Hosting infrastructure</li> <li>• Gastronomy facilities</li> <li>• Accessibility by air, train, and road</li> <li>• Development of tourist trails</li> <li>• Provision of tourist information</li> <li>• Number of tourist attractions</li> </ul>
	Marketing of the county as a tourist destination	<ul style="list-style-type: none"> <li>• Share of marketing expenditure in the totals budget of a county</li> </ul>

Table 6. Cont.

Key Elements of Creative Economy	Factors	A Proposed Measure
	Support for talented students	<ul style="list-style-type: none"> <li>Scholarship opportunities for talented youth</li> <li>Total expenditure (including private funds) on supporting the youth</li> </ul>
	Cooperation with other local-government offices	<ul style="list-style-type: none"> <li>Number of joint projects</li> <li>Size of co-financed projects</li> </ul>
	Sports and cultural events	<ul style="list-style-type: none"> <li>Total local government expenditure on sport events</li> <li>Number of sport events held in the county</li> <li>Number of sports clubs supported by the county</li> </ul>
	Municipal administration and environmental protection	<ul style="list-style-type: none"> <li>Expenditure on environmental issues</li> </ul>
	Public security	<ul style="list-style-type: none"> <li>Expenditure on public security</li> </ul>
	Cultural institutions	<ul style="list-style-type: none"> <li>Expenditure on cultural events and institutions</li> </ul>
	Competent municipal staff	<ul style="list-style-type: none"> <li>Spending per employee on training and personal development</li> </ul>
	Increase of Internet accessibility	<ul style="list-style-type: none"> <li>Public expenditure on public Internet access</li> <li>Support for private businesses for Internet access</li> </ul>
	Support for organisations and lobbying groups working in the interest of the county on the national scene	<ul style="list-style-type: none"> <li>Financial support for lobbying groups at national level</li> <li>Rewards and competitions for individuals and organisations promoting the county's interests at national level</li> </ul>
<b>The good governance perspective (QL)</b>		
<b>Quality of local leadership in counties (QL)</b>	Supports the cooperation between the local government and NGOs	<ul style="list-style-type: none"> <li>Results of opinion polls</li> <li>Activity of local councils and other platforms of communication with NGOs</li> <li>Number of active NGOs</li> <li>Share of the budget for NGOs in the total budget</li> </ul>
	Cooperates with other counties	<ul style="list-style-type: none"> <li>Number of international programmes and projects</li> </ul>
	Efficiently cooperates with the communes belonging to the county	<ul style="list-style-type: none"> <li>Number of investment projects co-financed by communities and the county</li> <li>Share of co-financed projects with communes in the total county budget</li> </ul>
	Cares about entrepreneurship	<ul style="list-style-type: none"> <li>Tax exempts and reliefs</li> <li>Financial support for hiring disabled persons in enterprises</li> </ul>
	Well represents the county on national level	<ul style="list-style-type: none"> <li>Appearance on national media (in positive context)</li> <li>Participation in national level consulting groups, think-tanks, and so on</li> <li>Ability to attract state funded projects to the county</li> </ul>
	Is a competent leader	<ul style="list-style-type: none"> <li>Ability to solve conflicts</li> <li>Participation in national level consulting groups, think-tanks, and so on</li> <li>Ability to attract state funded projects to the county</li> <li>Results of employee satisfaction surveys in the county office</li> </ul>
	Is respected by the citizens	<ul style="list-style-type: none"> <li>Results of opinion polls</li> </ul>
	Supports persons who have original ideas	<ul style="list-style-type: none"> <li>Grants and competitions for NGOs and individuals supporting creativity and local innovations</li> </ul>

Table 6. Cont.

Key Elements of Creative Economy	Factors	A Proposed Measure
	Fights against xenophobia and hostility against minorities	<ul style="list-style-type: none"> <li>• Number of public statements, interviews, and speeches against discrimination</li> <li>• Number of initiatives and programmers supporting minorities and underprivileged groups</li> </ul>
	Unfairly favours the interests of selected interest groups and institutions	<ul style="list-style-type: none"> <li>• Survey results among local citizens</li> </ul>
	Avoids making important, but unpopular decisions	<ul style="list-style-type: none"> <li>• Case-studies analysis</li> </ul>

Source: authors.

## 6. Conclusions

We based our research on the assumption that, although knowledge is strongly associated with creativity, the conditions and environments supporting creativity are similar, but *not equal*. Support for the creative industries deserves more attention from the policy-makers and local authorities. On the basis of our findings, we proposed a new model for measuring the efficiency of local governments in supporting creative industries locally.

In our research, we analysed the relative importance of the factors that were potentially important for the development of counties in the past and in the future. Engagement of local authorities remained the most important factor in the case of both past and future perspectives. Another important factor was the proximity of a metropolitan area. Generally speaking, most of the representatives of the counties expect that the factors of development of the counties that were important in the past would also be important in the future. According to the participants of the study, the top five factors hindering sustainable development in the past were as follows: poor quality of environment, resentment towards strangers, lack of tourist attractions, poor quality or insufficient provision of higher education, and low access to cultural goods and institutions. The respondents indicated the following factors as the most impactful for sustainable development of the county in the future: (a) a climate conducive for success-driven, creative businesspersons; (b) friendliness of local government to entrepreneurs; and (c) opportunities for talent development for well-educated and creative citizens. The factors that would spur economic growth in their county in the future by means of increased financial investments and non-financial interventions included the following: preventing brain drain, good quality of hard infrastructure, marketing of the county as a site for home and foreign investment, vocational education, and support for grass-roots initiatives of citizens. Those factors that are directly related to the creative economy—such as sports and cultural events; cultural institutions; increase of Internet accessibility; or countermeasures for intolerance, racism, and homophobia—are not preferred areas of intervention. This may be explained by a low level of economic development in many Polish counties, where lower-level needs of citizens play a more important role compared with the higher-level needs. Resentment towards strangers is the second most important factor hindering the sustainable development of a county. It displays problems with accepting people coming from other regions of a country by citizens of the county.

Good quality leadership is considered one of the key attributes of effective organisations. The highest values were attributed to the following factors: (a) the city mayor/district foreman (starosta) supports the cooperation between the local government and NGOs; (b) the city mayor/district foreman (starosta) cooperates with other counties, and (c) the city mayor/district foreman (starosta) efficiently cooperates with the communes belonging to the county.

On the basis of the results from 826 Polish counties, a new model for the sustainable development of a county was proposed. It is based on the balanced scorecard model (BSC) and the concept of

the intellectual capital statement (InCaS). Although the conceptual model was developed in Poland, it was based on the review of world literature on the topic and offers opportunities for application in other countries as well. The possible directions of future research are related to developing an international clearing house for statistical data related to sustainable development at local government levels. As the global economy becomes more and more dominated by metropolitan areas, so should follow the initiatives to collect statistical data. Local governments should take a more holistic view while developing their strategies and key performance indicators. The concept of sustainability in a knowledge-based economy should be extended to include social aspects of economic development related to tolerance, climate for doing business, social capital, and local leadership, which are also very important for the growth of local creative industries. Every local government is a facilitator of change, an employer, and a purchaser of goods and services, so it should be looked upon as an important element of the local creative economy.

Although research focusing explicitly on sustainable development is not an entirely new field, there does not exist a substantial body of work on combining economic growth models with sustainability issues and the creative economies perspective. In our paper, we aimed to combine the creative industries perspective with the challenges of the sustainable economy and the local governments' perspective.

Our research has certain limitations. Further research should aim to analyze the relationships between the four key areas. Therefore, our model provides a basis for further studies combining sustainable development and creative economy regarding the role of local governments in supporting creative industries. The limitations of this research derive from the fact that the research was conducted only on a national sample of Polish counties. Similar research studies conducted in other countries should be able to provide more reliable conclusions.

The model proposed by the authors will enable local level comparisons between smaller administrative units across the world. The model offers an opportunity to create a global context for information about the sustainable development and intellectual capital in counties. The model can be further developed by analyzing the horizontal relationships between the four main perspectives.

**Author Contributions:** This paper is the output from the dissertation on which both authors have worked (conceptualization, methodology, validation, formal analysis, investigation, resources, data curation, writing—original draft preparation, writing-review and editing and visualization: E.I.S. and J.F.). All authors have read and agreed to the published version of the manuscript.

**Funding:** This paper was funded by Polish National Science Centre (grant number: 2013/09/B/H54/00476; “*Kapitał intelektualny powiatów polskich*” (*Intellectual Capital of Polish County Counties*). The project is carried out by the University of Economics and Business in Poznań.

**Conflicts of Interest:** The authors declare no conflict of interest.

## References

1. Coyne, C.J.; Boettke, P. The Role of the Economist in Economic Development. *Q. J. Aust. Econ.* **2006**, *9*, 47–68. [[CrossRef](#)]
2. Quah, D. *The Weightless Economy in Economic Development*; C.E.P.R. Discussion, Papers; LSE Economics Department, 1999. Available online: [http://eprints.lse.ac.uk/2291/1/The\\_Weightless\\_Economy\\_in\\_Economic\\_Development.pdf](http://eprints.lse.ac.uk/2291/1/The_Weightless_Economy_in_Economic_Development.pdf) (accessed on 20 September 2019).
3. Lundvall, B.A. *Knowledge Management in the Learning Economy*; OECD: Paris, France, 2000.
4. Rhodes, M. An Analysis of Creativity. *Phi Delta Kappan* **1961**, *42*, 305–310.
5. Florida, R. *Cities and the Creative Class*; American Sociological Association: New York, NY, USA, 2003.
6. Florida, R. *The Rise of the Creative Class*; Basic Books: New York, NY, USA, 2004.
7. Howkins, J. *The Creative Economy*, 2nd ed.; Penguin: New York, NY, USA, 2013.
8. Bakhshi, H.; Hargreaves, I.; Mateos-Garcia, J. *A Manifesto for the Creative Economy*; NESTA: London, UK, 2013.
9. Burger-Helmchen, T. (Ed.) *The Economics of Creativity: Ideas, Firms and Markets*; Routledge: London, UK; New York, NY, USA, 2013.



10. Bazalgette, P. Independent Review of the Creative Industries. 2017. Available online: [https://assets.publishing.service.gov.uk/government/uploads/system/uploads/attachment\\_data/file/649980/Independent\\_Review\\_of\\_the\\_Creative\\_Industries.pdf](https://assets.publishing.service.gov.uk/government/uploads/system/uploads/attachment_data/file/649980/Independent_Review_of_the_Creative_Industries.pdf) (accessed on 20 September 2019).
11. OECD. *The Measurement of Scientific and Technological Activities: Guidelines for Collecting and Interpreting Innovation Data: Oslo Manual*, 3rd ed.; Working Party of National Experts on Scientific and Technology Indicators: Paris, France, 2005.
12. Howkins, J. *The Creative Economy, How People Make Money from Ideas*; Penguin Group: London, UK, 2001.
13. Markusen, A.; Wassall, G.H.; DeNatale, D.; Cohen, R. Defining the Creative Economy: Industry and Occupational Approaches. *Econ. Dev. Q.* **2008**, *22*, 24–45. [CrossRef]
14. Newbirgin, J. What Is the Creative Economy? Available online: <https://creativeeconomy.britishcouncil.org/guide/what-creative-economy/> (accessed on 20 September 2019).
15. O'Connor, J. *The Cultural and Creative Industries: A Literature Review*, 2nd ed.; Creativity, Culture and Education Series; Creativity, Culture and Education: London, UK, 2010.
16. United Nations. *The Creative Economy Report*; The United Nations Development Programme: New York, NY, USA, 2013.
17. United Nations. Department of Economic and Social Affairs. 2018. Available online: <https://www.un.org/development/desa/en/news/population/2018-revision-of-world-urbanization-prospects.html> (accessed on 19 January 2019).
18. UNCTAD. Creative Economy Outlook and Country Profiles: Trends in International Trade in Creative Industries. UNCTAD/WEB/DITC/TED/2016/5. 2015. Available online: <https://unctad.org/en/pages/PublicationWebflyer.aspx?publicationid=2328>, (accessed on 20 September 2019).
19. Bloom, B.S.; Engelhart, M.D.; Furst, E.J.; Hill, W.H. *Taxonomy of Educational Objectives: The Classification of Educational Goals. Handbook I: Cognitive Domain*; David McKay Company: New York, NY, USA, 1956.
20. Rocks, C. *London's Creative Industries—2017 Update*; GLA Economics, Working Paper 89; 2017. Available online: [https://www.london.gov.uk/sites/default/files/working\\_paper\\_89-creative-industries-2017.pdf](https://www.london.gov.uk/sites/default/files/working_paper_89-creative-industries-2017.pdf) (accessed on 20 September 2019).
21. UCLG. The Sustainable Development Goals. In *What Local Governments Need to Know*; United Cities and Local Governments, World Secretariat Barcelona: Barcelona, Spain, 2019.
22. Aghion, P.; Howitt, P. *Endogenous Growth Theory*; MIT Press: Cambridge, MA, USA, 1998.
23. Yang, J.; Černevičiūtė, J. Cultural and Creative Industries (CCI) and sustainable development: China's cultural industries clusters. *Entrep. Sustain. Issues* **2017**, *5*, 231–242. [CrossRef]
24. Fazlagić, J.; Skikiewicz, R. Measuring sustainable development—The creative economy perspective. *Int. J. Sustain. Dev. World Ecol.* **2019**, *26*, 635–645. [CrossRef]
25. Gorica, K.; Kripa, D.; Zenelaj, E. The Role of Local Government in Sustainable Development. *Acta Univ. Danubius. Econ.* **2012**, *8*, 139–155.
26. Montgomery, A. What Should Government Do to Support the Creative Industries? *DesignWeek*, 2 January 2014. Available online: <https://www.designweek.co.uk/issues/january-2014/what-should-government-do-to-support-the-creative-industries/> (accessed on 20 September 2019).
27. Satterthwaite, D. The Role of Cities in Sustainable Development. In *Sustainable Development Insights*; 2010; pp. 1–8. Available online: <https://www.bu.edu/pardee/files/2010/04/UNsdkp004fsingle.pdf> (accessed on 20 September 2019).
28. Wheeler, S.M. Constructing sustainable development/safeguarding our common future: Rethinking sustainable development. *J. Am. Plan. Assoc.* **2002**, *68*, 110–111.
29. Public-Private Partnerships. In *Culture and Creative Industries*; UNESCO: London, UK, 2013. Available online: [http://www.unesco.org/new/fileadmin/MULTIMEDIA/HQ/CLT/images/Bonapas\\_Onguglo\\_Hangzhou\\_Congress.pdf](http://www.unesco.org/new/fileadmin/MULTIMEDIA/HQ/CLT/images/Bonapas_Onguglo_Hangzhou_Congress.pdf) (accessed on 21 September 2019).
30. Fazlagić, J.; Szczepankiewicz, E.I. Intellectual Capital Statement Model for Counties in Poland. *Amfiteatru Econ.* **2018**, *20*, 732–752. [CrossRef]
31. Störmer, E.; Patscha, C.; Prendergast, J.; Daheim, C. *The Future of Work Jobs and Skills in 2030*; UK Commission for Employment and Skills: London, UK, 2014; Available online: [www.ukces.org.uk](http://www.ukces.org.uk) (accessed on 20 September 2019).
32. Strzelecka, E. The Creative Sector in Rural Areas in the Policy of Balanced Regional Development. *Barom. Reg.* **2016**, *14*, 15–21.

33. Kasprzak, R. Creative Industries in The Polish Economy. *Quaest. Geogr.* **2015**, *34*, 35–43. [CrossRef]
34. Wróblewski, L. The Influence of Creative Industries on the Socioeconomic Development of Regions in Poland. *Int. J. Entrep. Knowl. Issue* **2014**, *2*, 45–57. [CrossRef]
35. Danish Government. *Structural Monitoring—International Copenhagen*; Danish Government: Copenhagen, Denmark, 2000.
36. Agénor, P.R.; Canuto, O.; Jelenic, M. Avoiding Middle-Income Growth Traps. In *Economic Premise*; World Bank: Washington, DC, USA, 2012; Volume 98. Available online: <http://documents.worldbank.org/curated/en/422121468155111398/Avoiding-middle-income-growth-traps> (accessed on 21 November 2019).
37. Daley, J. The Intangible Economy and Australia. *Aust. J. Manag.* **2001**, *26*, 3–19. [CrossRef]
38. Iammarino, S.; Rodríguez-Pose, A.; Storper, M. *Why Regional Development Matters for Europe's Economic Future*; Working Papers WP 07/2017; Publications Office of the European Union: Luxembourg, 2017. Available online: [https://ec.europa.eu/regional\\_policy/sources/docgener/work/201707\\_regional\\_development\\_matters.pdf](https://ec.europa.eu/regional_policy/sources/docgener/work/201707_regional_development_matters.pdf) (accessed on 21 September 2019).
39. UNICAD. *Creative Economy Report 2013*. UNESCO, 2013. Available online: <http://www.unesco.org/culture/pdf/creative-economy-report-2013.pdf> (accessed on 21 September 2019).
40. Dobbs, R.; Smit, S.; Remes, J.; Manyika, J.; Roxburgh, C.; Restrepo, A. *Urban World: Mapping the Economic Power of Cities*; McKinsey Global Institute: New York, NY, USA, 2010.
41. Stelk, M. *The Role of the Creative Economy in Sustainability Planning and Development*; Muskie School Capstones, 2013; Available online: [http://digitalcommons.usm.maine.edu/muskie\\_capstones/27](http://digitalcommons.usm.maine.edu/muskie_capstones/27) (accessed on 21 September 2019).
42. The Civil Society Index (CSI). Available online: <https://www.odi.org/publications/5389-mapping-political-context-civil-society-index> (accessed on 26 June 2019).
43. Berglund, T.; Gericke, N. Exploring the Role of the Economy in Young Adults' Understanding of Sustainable Development. *Sustainability* **2018**, *10*, 2738. [CrossRef]
44. Xiong, L.; Teng, C.-L.; Zhu, B.-W.; Tzeng, G.-H.; Huang, S.-L. Using the D-DANP-mV Model to Explore the Continuous System Improvement Strategy for Sustainable Development of Creative Communities. *Int. J. Environ. Res. Public Health* **2017**, *14*, 1309. [CrossRef] [PubMed]
45. Standar, A.; Kozera, A. The Role of Local Finance in Overcoming Socioeconomic Inequalities in Polish Rural Areas. *Sustainability* **2019**, *11*, 5848. [CrossRef]
46. Kim, D.; Lim, U. Social Enterprise as a Catalyst for Sustainable Local and Regional Development. *Sustainability* **2017**, *9*, 1427. [CrossRef]
47. Mirza, M. *Culture Vultures: Is UK Arts Policy Damaging the Arts*; Policy Exchange: London, UK, 2006.
48. Romer, P. Increasing Returns and Long-run Growth. *J. Political Econ.* **1986**, *94*, 1002–1037. [CrossRef]
49. Fazlagić, J. Gospodarka Wiedzy. *Problemy Jakości* **2001**, *2*, 4–8.
50. Kaplan, R.S.; Norton, D.P. *The Balanced Scorecard—Measures That Drive Performance*; Harvard Business Review: Brighton, MA, USA, 1992.
51. Drucker, P. *The Practice of Management*; HarperCollins: New York, NY, USA, 1954.
52. Kaplan, R.S.; Norton, D.P. *The Balanced Scorecard: Translating Strategy into Action*; Harvard Business School Press: Boston, MA, USA, 1996.
53. Kaplan, R.S.; Norton, D.P. *The Strategy—Focused Organization: How Balanced Scorecard Companies Thrive in the New Business Environment*; Harvard Business School Press: Boston, MA, USA, 2000.
54. Rampersad, H.D. *Total Performance Scorecard: Een Speurtocht Naar Zelf Kennis en Competentie-Ontwikkeling van Lerende Organisaties*; Scriptum Management: Chiedam, The Netherlands, 2002.
55. Rampersad, H.D. *Total Performance Scorecard: Reinventing Management to Achieve Performance with Integrity by Dr Hubert K. Rampersad*; Scriptum Management: Chiedam, The Netherlands, 2004.
56. Marciniak, M.; Krwawicz, M. Zrównoważona karta wyników jako narzędzie controllingu strategicznego. *Controlling i Rachunkowość Zarządcza* **2000**, *7*, 7–14.
57. Horvath, P. Balanced Scorecard, Wie Sie Strategien erfolgreich umsetzen. *Gablers Mag.* **1998**, *4*, 22–24.
58. Yeh-Yun Lin, C.; Edvinsson, L. National Intellectual Capital: Comparison of the Nordic Countries. *J. Intellect. Cap.* **2008**, *9*, 525–545. [CrossRef]
59. InCaS. *Intellectual Capital Statement—Made in Europe, European Intellectual Capital Statement Guideline Developed by the InCaS Consortium*; European Commission: Brussels, Belgium, 2008.

60. Szczepankiewicz, E.I. The Use of ICS Model for Estimating the Value of Intellectual Capital within an Organization. *Management* **2011**, *2*, 183–197.
61. Szczepankiewicz, E.I. The use of ICS model for estimating the value of human capital in future-oriented organizations. *Hum. Resour. Manag. Ergon.* **2012**, *6*, 79–90. Available online: [http://frcatel.fri.uniza.sk/hrme/files/2012/2012\\_1\\_07.pdf](http://frcatel.fri.uniza.sk/hrme/files/2012/2012_1_07.pdf) (accessed on 20 December 2012).
62. Szczepankiewicz, E.I. The use of ICS model to identification and measuring of structural capital in small and medium enterprises. *Management* **2012**, *2*, 102–116.
63. Szczepankiewicz, E.I. Concept of using the ICS model to identification, measuring and presenting relational capital of a network enterprises. *Management* **2013**, *1*, 136–153. [[CrossRef](#)]
64. Vandebussche, J.; Aghion, P.; Meghir, C. Growth, distance to frontier and composition of human capital. *J. Econ. Growth* **2006**, *11*, 97–127. [[CrossRef](#)]
65. RAP. *Report on the Polish Power System; Version 2.0 Study* Commissioned by Agora Energiewende; Agora Energiewende: Berlin, Germany, 2018.
66. Madsen, D.O.; Stenheim, T. The Balanced Scorecard: A Review of Five Research Areas. *Am. J. Manag.* **2015**, *15*, 24–41.



© 2020 by the authors. Licensee MDPI, Basel, Switzerland. This article is an open access article distributed under the terms and conditions of the Creative Commons Attribution (CC BY) license (<http://creativecommons.org/licenses/by/4.0/>).



Article

# Capital Investments and Manufacturing Firms' Performance: Panel-Data Analysis

Vanja Grozdić <sup>1,\*</sup>, Branislav Marić <sup>1</sup>, Mladen Radišić <sup>1</sup>, Jarmila Šebestová <sup>2</sup> and Marcin Lis <sup>3</sup>

<sup>1</sup> Department of Industrial Engineering and Management, Faculty of Technical Sciences, University of Novi Sad, 21000 Novi Sad, Serbia; bmaric@uns.ac.rs (B.M.); mladenr@uns.ac.rs (M.R.)

<sup>2</sup> Department of Business Economics and Management, School of Business Administration in Karvina, Silesian University in Opava, 746 01 Opava, Czech Republic; sebestova@opf.slu.cz

<sup>3</sup> Faculty of Applied Sciences, WSB University, 41-300 Dąbrowa Górnicza, Poland; mlis@wsb.edu.pl

\* Correspondence: vanja.grozdic@protonmail.com; Tel.: +381-63-7677-089

Received: 9 December 2019; Accepted: 21 February 2020; Published: 24 February 2020

**Abstract:** The main goal of this study was to examine the effects of capital investments on firm performance, using panel-data analysis. For this purpose, financial data were gathered for 60 manufacturing firms based in Serbia, in the period from 2004 to 2016. The main research hypotheses were developed in accordance with the definition, nature, and time aspect of capital investments. Therefore, empirical expectation of this study was that the relationship between capital investments and firm performance should be positive—they probably bring losses to the firm in the short term, but they should increase firm performance in the long term. Finally, the results have indeed shown that capital investments have statistically significant negative effect on the short-term performance, but positive effect on the long-term performance of the analyzed firms, while controlling for time-fixed effects and certain internal factors.

**Keywords:** capital investments; firm performance; profitability; sustainability; panel data

## 1. Introduction

Today, Serbia is technologically lagging behind European industries and needs strong domestic industry to ensure economic sustainability. Serbian industry was largely devastated due to sanctions and wars in the 1990s. During that period, separated from foreign markets, it was impossible for Serbian industry to keep track of technological development. Isolation, as well as the lack of financial resources, made fixed assets technologically obsolete and poorly maintained. Foreign direct investments (FDI) are important, especially those with high technological intensity—bringing in new technologies and new knowledge, and employing domestic labor, but profitable domestic investments in fixed assets—which are not just the path to unjustified and excessive borrowing, represent one of the most important factors for abandoning a perennial economic stagnation. Figure 1 shows investments in fixed assets as percentage of gross domestic product (GDP) [1], where we can see that these investments in Serbia are mainly below European average.

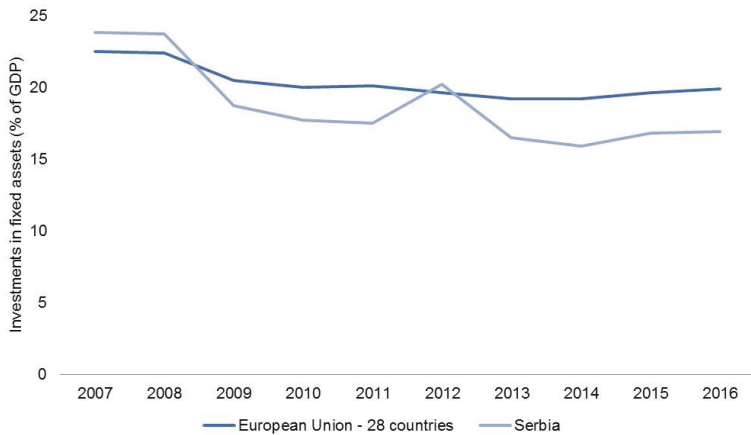

**Figure 1.** Investments in fixed assets as percentage of GDP (2007–2016). Source: Eurostat.

Capital investments, i.e., investments in fixed assets, represent an important factor that can serve as a signal in predicting the future profitability of the firm and stock returns [2]. Assessing the impact of investment at the level of the firm has not always been a viable research topic because, for many years, it was hindered by the lack of observed investment data and it is only recently that scholars have started to document the nature of firms' investment behavior [3]. Since most of the research regarding investment impact analysis focuses on the macroeconomic level, such as the impact of FDI on GDP growth, this paper attempts to fill the gap at the microeconomic level, i.e., the level of the firm.

Capital investments are necessary for growth and economic development, which implies that growth, beside other factors, is a function of investments. However, since accumulation depends on growth, we can also say that investments are function of growth. Therefore, theoretically, there is a clear interdependence between growth and capital investments.

Sustainable development of the manufacturing firms is closely related to the selection and realization of the capital investments, or investment projects, regardless of whether it is a replacement, modernization, expansion, or some other type of investments. Moreover, sustainable manufacturing largely depends on the process of selection and realization of investment projects, since they have to be selected and implemented based on their environmental and social impact evaluation, beside the assessment of other associated risks—that can be systematized as investment, financial, organizational, technical, technological, operational and informational risk [4]. As a consequence, manufactured products should use processes that minimize negative environmental impacts, should conserve energy and natural resources, should be safe for employees, communities, and consumers and should be economically sound [5]. Managing physical assets and technologies, or investment—capital intensive—projects, lead to the accumulation of capabilities in the firm, associated with continuous improvement and process innovations, as well as with corporate sustainable development [6]. Hence, capital investments are crucial link for manufacturing firms to create a long-term economic value, as well as to achieve sustainable development, having in mind their social and environmental impacts.

At the firm level, we can say that capital investments, in one hand, have a short-term character, since they represent the firm expense, but in the other hand, capital investments have a long-term nature, since they should bring some benefits to the firm in the future. Accordingly, the main goal of this study was to analyze this relationship between capital investments and firm performance, or more precisely, to examine the effect of capital investments on the firm performance, including both short-term and long-term aspects. Establishing the relationship between capital investments and firm performance, and confirming or disconfirming the effectiveness of capital investments, will contribute

to the knowledge accumulation in this area and provide an insight for future capital investments of manufacturing firms.

The rest of the paper is organized as follows. Literature review of the relationship between capital investments and firm performance is presented in Section 2. Section 3 describes research methodology. Data analysis, including descriptive statistics, general model, and preliminary assumptions tests for panel data, is presented in Section 4. Section 5 analyzes regression results. Section 6 concludes.

## **2. Literature Review**

There is a certain number of studies that examine the relationship between firm performance, using different measures of performance, and capital investments, while employing different statistical tests and econometric approaches. The findings are divided, resulting in negative or positive relationship between capital investments and firm performance. Our empirical expectation is that there is a positive relationship between capital investments and firm performance because of the definition, nature, and time aspect of capital investments—although they probably bring losses to the firm in the short term, they should increase the firm performance in the long term.

Power [7], on the case of US manufacturing firms, finds no evidence of a strong positive relationship between productivity and tangible investments which cautions against the efficacy of fiscal policy that is based on the premise that investment causes high productivity. Author, also, concludes that reason for the weak relationship between productivity and investment is that higher productivity is simply not the primary motivation for investments and quotes Grabowski and Mueller [8] that overinvestment, poor-quality investments, and low productivity can result if managers are maximizing their own utility rather than firm profits. Nilsen et al. [9], on the case of Norwegian firms, while examining the relationship between productivity and investments in fixed assets, found that productivity improvements are not related to these investments, more precisely they found significant effect of tangible investment on productivity, but this effect vanishes over time. Shima [10] investigates the impact of capital investments on productivity at the firm level using data of Japanese manufacturing industries and find also a negative relationship which, according to the author, predicts that firms face sunk costs.

Titman et al. [11] showed that US non-financial firms with substantially increase in capital investments subsequently achieve negative benchmark-adjusted returns and that the negative capital investments-return relationship is stronger for firms with higher cash flows and/or lower debt ratios, which probably have a greater tendency to overinvest. Jovanovic et al. [12], again on the case of US manufacturing firms, found that capital investments of established firms—“intensive” investments—are negatively related with Tobin’s Q, compared to the new firms, because a high Q is a signal of low compatibility of old capital with the new and, hence, of high implementation costs specific to incumbents. According to Yao et al. [13] there is a pervasive negative relationship between asset growth and subsequent stock returns of Asian firms, suggesting potential inefficiencies of the region’s financial systems in allocating capitals and valuing investment opportunities. Using data from 624 firms in the United States, Sircar et al. [14], found that both IT and corporate investments have a strong positive relationship with sales, assets, and equity, but not with net income. Singh et al. [15], using data from 120 firms in 30 countries, showed that environmental technology investments have a negative impact on profitability, i.e., return on assets, through pollution prevention capability and that firms should relocate their environmental expenditures to enhance firms’ economic performance.

Aktas et al. [16], while examining the relationship between working capital management and firm performance, on the case of US firms, found that fixed asset growth is negatively associated with firm performance, measured by return on assets, and also statistically insignificant. Similar, Alipour et al. [17], while examining the relationship between working capital management and firm performance, on the case of UK firms, showed that tangible fixed assets have a negative and statistically significant impact on their return on assets. Jindrichovska et al. [18], on the case of 260 Czech firms, also found a negative relationship between growth of tangible assets, as a share of total assets, and return on assets

of those firms. Fernández-Rodríguez et al. [19], while examining the influence of ownership structure on tax rates of Spanish firms, found that growth of fixed assets, expressed by capital intensity, has a negative and significant relationship with effective tax rate of the state owned companies, expressed as a relationship between tax expense and pretax income. Aljinović Barać and Muminović [20], on the case of dairy processing industry in Slovenia, Croatia, and Serbia found that companies with higher level of capital investments per employee obtain lower financial performance, expressed by return on assets, and that possible explanation for that can be found in the time lag between the moment of investment and the moment in the future when investment will generate the profit.

On the other hand, Grazzi et al. [3], on the case of French and Italian manufacturing firm-level data, using econometric approach that allows disentangling of the repair and maintenance episodes from large tangible investments, and after controlling for firm characteristics, found that tangible investments are associated with higher productivity, profitability, and employment. Ching-Hai et al. [21], while examining relationship between capital expenditures and corporate earnings of manufacturing firms listed on the Taiwan Stock Exchange, and after controlling for current corporate earnings, found a significantly positive association between capital expenditures and future corporate earnings. Aw et al. [22], also on the sample of Taiwanese electronics producers, found that firm future profitability is improved by investments in both R&D and physical capital. Gradzewicz [23] showed that productivity of Polish firms falls after investment and slowly recovers thereafter, which is consistent with learning-by-doing effects, and that investments are also associated with subsequent significant sales increase. Namiotko et al. [24], on the case of Lithuanian farms, found that the farms showed lower inefficiency in the presence of the investment spikes, which indicates that the farms, operating in the region of increasing returns to scale, could increase productivity by increasing their inputs and investments.

Fama and French [25] studied the relationship between firm investments and profitability for the aggregate non-financial US corporations and found that corporate investments lead to higher profitability. Yu et al. [26], while examining China's manufacturing firm-level dataset, showed that the only visible profitability–growth relationship is mediated via capital investments and that capital investments have a positive and significant effect on firms' productivity, both in levels and growth rates, and the effect on sales growth is even bigger. Lööf and Heshmati [27] examined the relationship between performance and tangible, as well as R&D investments of Swedish firms, and found that profitability is strongly associated with physical investments, but not with R&D investments. Johansson and Lööf [28], also on the case of Swedish manufacturing firms, found that the impact of physical capital (investment) on profitability is significant, positive, and systematically larger than for the comparable labor productivity estimations.

Licandro et al. [29] in their study showed that sales and productivity of innovative Spanish firms rise as a result of large tangible investment episodes and, hence, that they substantially improve their market shares, which is not the case for the non-innovative firms. Kapelko et al. [30], also on the case of Spanish manufacturing firms, found that capital investments produce a significant productivity change loss in the first year after investment, but thereafter productivity improves, resulting in the U-shape pattern of relationship. Amoroso et al. [31], on the case of EU firms, while making distinction between R&D and physical investments, showed that both R&D and physical investments, have a positive effect on the performance, expressed by the operating profit, and that larger firms also get higher returns in the presence of risk. Curtis et al. [32], using financial data on mergers and acquisitions, found that capital expenditures, as well as R&D expenditures, have a positive effect on the net profit and future earnings volatility of analyzed firms. Taipi and Ballkoci [33], on a sample of 30 construction firms in Albania, showed that capital investments have a positive effect on their future profitability, expressed by return on assets. Sudiyatno et al. [34] and Pandya [35] also found that capital investments have a positive effect on profitability, i.e., return on assets, on the case of manufacturing companies in Indonesia and infrastructure companies in India, respectively.



There are many researchers who examined the relationship between technology investments and performance, such as, for example, Mithas et al. [36], who found, on a sample of 400 global firms, that technology investments have a positive impact on revenue growth and profitability. Similar, Arvanitis et al. [37], on the case of Swiss firms, investigated the effects of energy-related technologies on economic performance at firm level and found a positive direct effect of investment expenditures for energy-related technologies on labor productivity, and a positive indirect effect of energy taxes via investment in energy-related technologies. Also, Bostian et al. [38], using plant-level production data for Swedish manufacturing firms, showed that environmental technology investments have a positive effect on the firm performance, measured by the productivity changes. Lee et al. [39], on the case of Korean biotechnology firms, while examining the relationship between R&D intensity and firm value, found that total asset investments and asset tangibility have a positive effect on the firm value, measured by Tobin's Q.

Although the literature covers a wide variety of firm performance measures, mainly expressed through productivity and profitability, this study will focus on profitability as a final component of the chain: capital investments—improved productivity—increased profitability. Tables 1 and 2 summarize literature review.

**Table 1.** Summary of literature review—part I.

Author(s)	Year	Region	Dependent Variable (DV)	Relationship between Capital Investments and DV
Power, L.	1998	United States	Productivity	Negative
Nilsen, Ø. A.; Raknerud, A.; Rybalka, M.; & Skjerpen, T.	2008	Norway	Productivity	Negative
Shima, K.	2010	Japan	Productivity	Negative
Singh, Nitish; Jieqiong Ma; and Jie Yang	2016	Global	Profitability (ROA)	Negative
Aktas, Nihat; Ettore Croci; and Dimitris Petmezas	2015	United States	Profitability (ROA)	Negative
Alipour, Mohammad; Mir Farhad Seddigh Mohammadi; and Hojjatollah Derakhshan	2015	United Kingdom	Profitability (ROA)	Negative
Jindrichovska, Irena; Erginbay Ugurlu, and Dana Kubickova	2013	Czech Republic	Profitability (ROA)	Negative
Aljinović Barać, Željana, and Saša Muminović	2013	Slovenia, Croatia, Serbia	Profitability (ROA)	Negative
Fernández-Rodríguez, Elena; Roberto García-Fernández; and Antonio Martínez-Arias	2019	Spain	Tax expense, Pretax Income	Negative
Titman, Sheridan; KC John Wei; and Feixue Xie	2004	United States	Benchmark-Adjusted Returns	Negative
Jovanovic, Boyan; and Peter L. Rousseau	2014	United States	Tobin's Q	Negative
Yao, Tong; Tong Yu; Ting Zhang; and Shaw Chen	2011	Asia	Stock Returns	Negative
Sircar, Sumit; Joe L. Turnbow; and Bijoy Bordoloi	2000	United States	Net income	Negative

Table 2. Summary of literature review—part II.

Author(s)	Year	Region	Dependent Variable (DV)	Relationship between Capital Investments and DV
Grazzi, Marco; Nadia Jacoby; and Tania Treibich	2016	Italy, France	Productivity, Profitability, Employment	Positive
Namiotko, Virginia; and Tomas Baležentis	2017	Lithuania	Productivity	Positive
Kapelko, Magdalena; Alfons Oude Lansink; and Spiro E. Stefanou	2015	Spain	Productivity	Positive
Arvanitis, Spyros; Michael Penede; Christian Rammer; Tobias Stucki; and Martin Woerter	2017	Switzerland	Productivity	Positive
Bostian, Moriah; Rolf Färe; Shawna Grosskopf; and Tommy Lundgren	2016	Sweden	Productivity	Positive
Fama, Eugene F.; and Kenneth R. French	1999	United States	Profitability	Positive
Aw, Bee Yan; Mark J. Roberts; and Daniel Yi Xu	2008	Taiwan	Profitability	Positive
Lööf, Hans; and Almas Heshmati	2008	Sweden	Profitability	Positive
Johansson, Börje; and Hans Lööf	2008	Sweden	Profitability, Productivity	Positive
Yu, X.; Dosi, G.; Grazzi, M.; & Lei, J.	2017	China	Profitability, Sales	Positive
Mithas, Sunil; Ali R. Tafti; Indranil Bardhan; and Jie Mein Goh	2012	Global	Profitability, Revenue	Positive
Ester Taipi; Valbona Ballkoci	2017	Albania	Profitability (ROA)	Positive
Sudiyatno, Bambang; Elen Puspitasari; and Andi Kartika	2012	Indonesia	Profitability (ROA)	Positive
Pandya, Bhargav	2017	India	Profitability (ROA)	Positive
Gradzewicz, Michal	2018	Poland	Sales	Positive
Licandro, Omar; Reyes Maroto; and Luis A. Puch	2004	Spain	Sales, Productivity	Positive
Ching-Hai, Jiang; Chen Hsiang-Lan; and Huang Yen-Sheng	2006	Taiwan	Corporate Earnings	Positive
Amoroso, Sara; Pietro Moncada-Paternò-Castello; and Antonio Vezzani	2017	EU	Operating profit	Positive
Curtis, Asher; Sarah E. McVay; and Sara Toynebee	2018	Global	Net profit, Earnings	Positive
Lee, Namyoung; and Jaehong Lee	2019	Korea	Tobin's Q	Positive

### 3. Methodology and Hypotheses Development

Capital investment, or investment project, theoretically can be defined as a series of cash inflows and outflows, which typically begins with cash outflows (initial investment), followed by cash inflows and/or cash outflows in subsequent years of the project [40], or simply as a series of outflows that can bring some inflows in the future. Capital investment in a manufacturing firm can be realized in one year, or in more than one year, in case of large projects, while benefits are usually collected through several upcoming years after realization. In accordance with this long-term nature of capital investments, theoretical definition, and also assumption that capital investments from previous year should affect the firm performance in the next year, we can say that capital investments can have negative effect on firm performance in the short term (during the one year, i.e., the year of investment), but they should have positive effect on firm performance in the long term (year after investment). Accordingly, we can define our main research hypotheses as follows:

**Hypothesis 1:** *Capital investments have a negative effect on the short-term performance of manufacturing firms.*

**Hypothesis 2:** *Capital investments have a positive effect on the long-term performance of manufacturing firms.*

For this study we have chosen manufacturing firms, i.e., capital intensive firms that require large amount of capital investments to produce goods. Sixty manufacturing firms from Serbia, selected based on financial data availability, with historical data from 2004–2016 (total of 600 available observations with some missing data), were analyzed. As a proxy for firm performance we have used profitability–growth, expressed by ROA (Return on Assets), since ROA, according to Hagel et al. [41], represent better metric of financial performance than income statement profitability measures—it takes into account the assets used to support business activities and determines whether the company is able to generate an adequate return on these assets rather than simply showing robust return on sales. As for capital investments, as a proxy we have used capital investment rate.

There are several procedures for choosing the lag length in finite distributed lag models (in which the effect of a regressor  $X$  on  $Y$  occurs over time rather than all at once), but there is no perfect answer which lag length to choose, especially in panel models. Having in mind the statistical problems that can occur, especially in short panels (less than 20–30 years), such as multicollinearity and sample reduction (each time we lengthen the lag by one period, we lose two degrees of freedom), we have chosen one year as a lag length of the regressor. More precisely, for the purpose of this study, to capture the long-term effect of capital investments on performance, we have used one-year lag of capital investment rate.

While examining the relationship between these growth rates, we have controlled time-fixed effects using year dummies, and certain internal factors, such as firm size, leverage, total asset turnover, and asset tangibility. Financial data for the manufacturing firms were obtained from the Serbian Business Registers Agency database [42].

Panel data describes the behavior of individuals/entities, both across individuals/entities and over time—they have both cross-sectional and time-series dimensions. Panel data can be balanced when all individuals/entities are observed in all time periods or, as in our case, unbalanced when individuals/entities are not observed in all time periods, i.e., there are missing data points because of the occasional panel attrition. The main three types of panel-data models are pooled Ordinary Least Squares (OLS) model (assumes constant coefficients), fixed effects model (assumes that the individual specific effects are correlated with the regressors), and random effects model (assumes that the individual specific effects are not correlated with the regressors). To choose appropriate panel model, Hausman test and Breusch–Pagan Lagrange multiplier have been employed, as well as appropriate tests regarding assumptions of serial correlation, heteroscedasticity, and cross-sectional dependence presence in analyzed panel data.

## 4. Data Analysis

### 4.1. Descriptive Statistics

Results for overall descriptive statistics, as well as descriptive statistics with decomposition in between and within standard deviation, for main variables of interest, firm performance expressed with ROA and firm capital investments CI, are presented in Table 3. On one hand, Table 3 shows overall descriptive statistics of main variables, where we can see that 60 firms (ID), analyzed over period from 2004–2016, have mean ROA (−0.054) with standard deviation (1.087) and mean CI (0.093) with standard deviation (0.595). On the other hand, Table 3 shows descriptive statistics with decomposition in between firms and within firms over time variation. First, it is obviously that firm (ID) does not vary over time (Year), but since we have unbalanced panel, we can see that time (Year) do vary between firms (ID). The interesting part is that both variables, ROA and CI for manufacturing firms, have more variation within firms over time (1.037 and 0.559, respectively for ROA and CI), than variation between firms (0.441 and 0.204, respectively for ROA and CI). Also, in Table 3 we can see overall, between and

within descriptive statistics for all control variables included in the model. Figure 2 shows bar charts of mean ROA and CI, grouped by firms and by time, and, if we look at the graphs (b) and (d), we already have an indication that CI will probably have a negative effect on the short-term ROA.

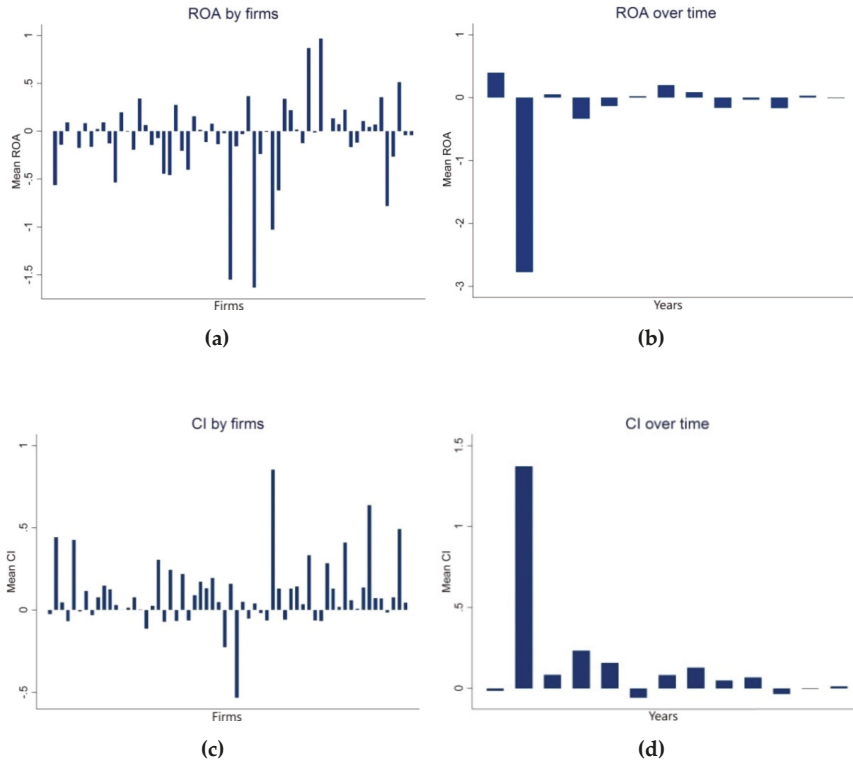

**Figure 2.** Bar charts of mean ROA and CI, by 60 firms and over time (2004–2016): (a) Mean ROA by firms; (b) Mean ROA over time; (c) Mean CI by firms; (d) Mean CI over time.

**Table 3.** Descriptive statistics.

Variable		Mean	St. Dv.	Min	Max	Observations
ID	overall	30	17.318	1	60	N = 600
	between		17.464	1	60	n = 60
	within		0	30	30	T-bar = 10
Year	overall	2010.568	2.966	2004	2016	N = 600
	between		0.576	2009	2012	n = 60
	within		2.911	2005.068	2016.068	T-bar = 10
ROA	overall	-0.054	1.087	-5.495	4.286	N = 434
	between		0.441	-1.636	0.969	n = 58
	within		1.037	-4.930	3.875	T-bar = 7.483
CI	overall	0.093	0.595	-6.406	9.167	N = 589
	between		0.204	-0.533	0.854	n = 60
	within		0.559	-5.780	8.406	T-bar = 9.817
CI_LAG	overall	0.106	0.624	-6.406	9.167	N = 529
	between		0.224	-0.584	0.932	n = 60
	within		0.582	-5.716	8.341	T-bar = 8.817

Table 3. Cont.

Variable		Mean	St. Dv.	Min	Max	Observations
SIZE	overall	9.423	1.666	5.732	15.584	N = 556
	between		1.584	6.496	14.562	n = 60
	within		0.468	7.867	14.599	T-bar = 9.267
LEV	overall	0.198	1.360	-4.186	5.902	N = 487
	between		1.276	-2.627	3.290	n = 59
	within		0.578	-1.848	4.206	T-bar = 8.254
TAT	overall	1.009	0.086	0.232	1.378	N = 556
	between		0.074	0.769	1.182	n = 60
	within		0.045	0.472	1.250	T-bar = 9.267
TANG	overall	-1.036	0.741	-6.073	-0.137	N = 556
	between		0.676	-4.189	-0.303	n = 60
	within		0.391	-4.001	1.046	T-bar = 9.267

#### 4.2. Pooled OLS vs Fixed Effects vs Random Effects

First, we must choose between three types of panel models: the pooled OLS model, the fixed effects model (FE), and the random effects model (RE). To choose between these model types, first step would be to decide between FE and RE model using Hausman test. If we conclude that FE model is the better one, then we can use F-test for fixed effects to decide between FE and OLS model. However, if we conclude that RE is the better one, then we should choose between RE and OLS model, using Breusch-Pagan Lagrange multiplier (LM).

Hence, to decide between FE and RE model, first we should perform Hausman test (Appendix A, Table A1). Table A1, Appendix A, shows that Prob > chi2 (0.473) is higher than 0.05, so we cannot reject the null hypothesis, which implies that there is no correlation between the error term and the regressors, and we can conclude that RE is preferred model.

Given that Hausman test showed that between FE and RE model, RE model is the better one, now we need to compare RE and OLS model. We will do this by employing Breusch-Pagan LM for random effects testing shown in Appendix A, Table A2. Table A2, Appendix A, shows that Prob > chibar2 (1.000) is higher than 0.05, so we cannot reject the null hypothesis, which implies that the variances across firms are zero, and we can conclude that pooled OLS is preferred model.

In accordance with this model selection procedure, the rest of the paper will focus on the pooled OLS as preferred model. However, we will also present the results for fixed effects and random effects regressions. These results can be found in Appendix B, Tables A5 and A6, respectively.

#### 4.3. General Model

The estimating equation for pooled OLS model can be presented as follows:

$$Y_{it} = \alpha + \beta X_{it} + \mu_{it} \quad (1)$$

In Equation (1),  $Y_{it}$  is the dependent variable of entity (i) in time (t),  $\alpha$  is the constant intercept,  $X_{it}$  represents independent and / or control variable of entity (i) in time (t),  $\beta$  is the coefficient for that variable and  $\mu_{it}$  is the error term.

Equation for capital investment, measured as capital investment rate, can be presented as follows:

$$CI_{it} = I_{it} / K_{i,t-1} \quad (2)$$

In Equation (2),  $CI_{it}$  is capital investment rate of firm (i) in year (t),  $I_{it}$  is investment of firm (i) in year (t), or flow variable, and  $K_{i,t-1}$  is tangible fixed assets of firm (i) at the end of the previous year, or stock variable.

The empirical model, summarized by Equations (1) and (2), is shown in Equation (3), where  $ROA_{it}$  is the dependent variable that represent performance measure Return on Assets, calculated as

ratio of Net Income and Total Assets of firm (i) during year (t),  $\alpha$  represents the constant,  $CI_{it}$  is the first independent variable that represent Capital Investment, calculated as difference between firms' Fixed Assets in year (t) and Fixed Assets in year (t-1), divided by Fixed Assets in year (t-1),  $CI\_LAG_{it}$  is the second independent variable that represent one year lagged CI variable for firm (i), used for capturing the effect of capital investments on firm performance in the long term,  $SIZE_{it}$  is the first internal control variable that represent firm's size, calculated as a Natural Log of Total Assets of firm (i) in year (t),  $LEV_{it}$  is the second internal control variable that represent firm's Leverage, calculated as a Debt to Equity ratio of firm (i) in year (t),  $TAT_{it}$  is the third internal control variable that represent firm's Total Asset Turnover, calculated as Net Sales to Total Assets ratio of firm (i) in year (t), TANG is the fourth internal control variable that represent firm's Asset Tangibility, calculated as Fixed Assets to Total Assets ratio of firm (i) in year (t),  $YEAR_t$  is the year dummy variable, used for controlling time-fixed effects, and  $\mu_{it}$  is the standard error term in regression analysis. To ensure normality of the data, natural logs have been used for all variables. Table 4 summarizes model variables and their calculations.

$$ROA_{it} = \alpha + \beta_1 CI_{it} + \beta_2 CI\_LAG_{it} + \beta_3 SIZE_{it} + \beta_4 LEV_{it} + \beta_5 TAT_{it} + \beta_6 TANG_{it} + YEAR_t + \mu_{it} \quad (3)$$

**Table 4.** Summary of model variables.

Type of Variable	Variable	Calculation
Dependent (DV)	Return on Assets (ROA)	Net Income/Total Assets
Independent (IV)	Capital Investment (CI)	Fixed Assets (t)—Fixed Assets (t-1)/ Fixed Assets (t-1)
	Lagged Capital Investment (CI_LAG)	One-year lagged CI
Control (CV)	Firm's size (SIZE)	Natural Log of Total Assets
	Leverage (LEV)	Debt/Equity
	Total Assets Turnover (TAT)	Net Sales/Total Assets
	Tangibility (TANG)	Fixed Assets/Total Assets

#### 4.4. Pooled OLS Preliminary Assumptions

For pooled OLS model to be accurate, there are some assumptions which needs to be tested. The most important ones are no serial correlation, homoscedasticity, and no cross-sectional dependence.

In longitudinal data, subjects are measured repeatedly over time and repeated measurements of a subject tend to be related to one another [43]. Because serial correlation in linear panel-data models biases the standard errors and causes the results to be less efficient, researchers need to identify serial correlation in the idiosyncratic error term in a panel-data model, and a Wooldridge test is very attractive because it requires relatively few assumptions and is easy to implement [44]. Serial correlation refers to the situation in which residuals are correlated across time and ignoring serial correlation where it exists, causes consistent but inefficient estimates, biased standard errors and inference about the significance of regressors may be incorrect under serial correlation conditions [45]. Even though the serial correlation can be ignored in short panels (less than 20-30 years), we will employ Wooldridge test which examine the serial correlation in panel data. These results are presented in Table A3, Appendix A.

When fitting regression models to data, an important assumption is that the variability is common among all observations, which is called homoscedasticity (this means "same scatter", or constant variance), but when the scatter varies by observation, the data are said to be heteroscedastic, which affects the efficiency of the regression coefficient estimators although these estimators remain unbiased even in the presence of heteroscedasticity [43]. Homoscedastic assumption that the variability is common among all observations, according to Baltagi [46], may be a restrictive assumption for data panels, where cross-sectional units may often be a different size and as a result exhibit different variations. Assuming homoscedastic disturbances when heteroscedasticity is present will yield consistent estimation results of coefficients that are not efficient, the standard errors of the estimates will be biased and the inference about the significance of regressors may be incorrect [45]. To test for

heteroscedasticity in panel data, we will use Breusch-Pagan / Cook-Weisberg test. The results regarding heteroscedasticity are also presented in Table A3, Appendix A.

In Table A3, Appendix A, regarding serial correlation, we can see that the Prob > F (0.045) is less than 0.05, so we can reject the null hypothesis and conclude that there is a presence of serial correlation in our panel data. Also, in Table A3, Appendix A, regarding heteroscedasticity, we can see that the Prob > chi2 (0.0016) is less than 0.05, so again we can reject the null hypothesis and conclude that there is presence of heteroscedasticity in our panel data.

A growing body of the panel-data literature comes to the conclusion that panel datasets are likely to exhibit substantial cross-sectional dependence, which may arise due to the presence of common shocks and unobserved components that become part of the error term ultimately, due to spatial dependence, as well as due to idiosyncratic pair-wise dependence in the disturbances with no particular pattern of common components or spatial dependence [47]. Ignoring cross-sectional dependence may affect the first-order properties (unbiasedness, consistency) of standard panel estimators and even if the first-order properties of these estimators remain unaffected, the presence of error cross-sectional dependence may largely reduce the extent to which they can provide efficiency gains over estimating using, say, OLS for each individual [48]. According to De Hoyos and Sarafidis [47], if assume standard panel model, under the null hypothesis  $\mu_{it}$  is assumed to be independent and identically distributed over time periods and across cross-sectional units, and under the alternative  $\mu_{it}$  may be correlated across cross-sections but the assumption of no serial correlation remains. To test cross-sectional dependence in panel data, we will employ CD-test, as described in Pesaran [49] and Pesaran [50] for a varlist of any length. The results are presented in Table A4, Appendix A.

In Table A4, Appendix A, regarding cross-sectional dependence, we can see that the  $p$ -values are less than 0.05, so we can reject the null hypothesis and we can conclude that there is presence of cross-sectional dependence in our panel data.

## 5. Results and Discussion

Since all three assumptions for pooled OLS model to be accurate (no serial correlation, homoscedasticity, and no cross-sectional dependence) are violated, we will use robust standard errors (Driscoll–Kraay standard errors), which will help us to deal with these violations.

According to Hoechle [51], in order to ensure valid statistical inference when some of the underlying regression model's assumptions are violated, it is common to rely on robust standard errors. Following Hoechle [51], we will run pooled OLS regression with Driscoll–Kraay standard errors, which deals with heteroscedasticity, autocorrelation, and cross-sectional dependence assumptions violations.

Regression is performed according to the general model equation described in Section 4.3, as well as preliminary performed Hausman test, Breusch-Pagan LM, serial correlation, heteroscedasticity, and cross-sectional dependence test. Table 5 shows the results from hierarchical pooled OLS regression testing hypotheses that capital investments probably have negative effect on the firm performance in the short term, but positive effect on the firm performance in the long term, while controlling for time-fixed effects and certain internal factors, such as firm size, leverage, total asset turnover, and asset tangibility. We will now present the results concerning our four models.

**Result 1:** Model 1 provides evidence that CI has a negative, statistically insignificant, effect on ROA (−0.272) and CI\_LAG has a positive, statistically significant, effect on ROA (0.101), at level 0.001. This model confirms our second hypothesis and indicates that for certain increase in capital investments, ROA of manufacturing firms is expected to increase in the year after investment, while holding firm size constant. We can see that firm size (SIZE), as a control variable, has a negative effect on ROA (−0.044) and statistically significant, at level 0.001. Larger firms should have a larger profitability, since they can achieve lower cost per unit, which is in line with the economies of scale. Although most studies reports a positive relationship between firm size and profitability, there are also researchers who found a negative relationship between these two variables (see, e.g., Kartikasari et al. [52]). According to Pervan et al. [53], a conceptual framework that advocates a negative relationship

between firm size and profitability is noted in the alternative theories of the firm, which suggest that large firms come under the control of managers pursuing self-interested goals and therefore profit maximization as the firm's objective function may be replaced by managerial utility maximization function. This can imply that managers of large manufacturing firms in Serbia put their own goals in front of the companies' goals.

**Result 2:** Model 2 provides evidence that CI has a negative effect on ROA ( $-0.815$ ) and CI\_LAG has a positive effect on ROA ( $0.086$ ), with statistically significant coefficients, at level  $0.001$ . This model confirms our both hypotheses and indicates that for certain increase in capital investments, ROA of manufacturing firms is expected to decrease in the year of investment, but to increase in the year after investment, while holding firm size and leverage constant. Also, leverage (LEV), as additional control variable, has a negative effect on ROA ( $-0.020$ ). This can be considered to be a reasonable result, since it is clear that greater borrowing implies a reduction of profitability. Obviously, this rule also applies to manufacturing firms in Serbia. There are many researchers who have examined capital structure and firms' performance and found a negative relationship between leverage and profitability (see, e.g., Ahmad et al. [54]). However, in our case the effect of leverage on profitability remain statistically insignificant. We can see that in this particular model, the effect of firm size, as a control variable, on profitability is still negative ( $-0.046$ ) and statistically significant, at level  $0.01$ . Moreover, in this particular model, the intercept is also statistically significant, at level  $0.01$ .

**Result 3:** Model 3 provides evidence that CI has a negative effect on ROA ( $-0.826$ ) and CI\_LAG has a positive effect on ROA ( $0.083$ ), again with statistically significant coefficients, at level  $0.001$ . This model also confirms our both hypotheses and indicates that for certain increase in capital investments, ROA of manufacturing firms is expected to decrease in the year of investment, but to increase in the year after investment, while holding firm size, leverage, and total asset turnover constant. We can see that total asset turnover (TAT), as additional control variable, has a positive effect on ROA ( $0.928$ ) and statistically significant, at level  $0.05$ . This also can be considered to be a reasonable result, since total asset turnover, as an efficiency measure, shows how firm uses its assets in generating revenue, where higher value of this ratio indicates a better managing of firm's assets. This can imply that manufacturing firms in Serbia manage their assets effectively. A positive relationship between total asset turnover and profitability has been proven in many studies (see, e.g., Dencic-Mihajlov [55]). In this particular model, the effect of firm size and leverage, as control variables, is statistically insignificant and still negative.

**Result 4:** Model 4 provides evidence that CI has a negative effect on ROA ( $-0.810$ ) and CI\_LAG has a positive effect on ROA ( $0.081$ ), also with statistically significant coefficients, at level  $0.001$ . This model again confirms our both hypotheses and indicates that for certain increase in capital investments, ROA of manufacturing firms is expected to decrease in the year of investment, but to increase in the year after investment, while holding firm size, leverage, total asset turnover, and asset tangibility constant. Tangibility (TANG), as additional control variable, has a positive effect on ROA ( $0.209$ ) and statistically significant, at level  $0.05$ . Although there are divided opinions how tangibility should affect profitability, considering the negative effects of amortization costs, this result can be reasonable, since, according to Bhuta et al. [56], firm with large amount of fixed asset tends to be more profitable because of increasing its future assets value. Similarly, Al-Jafari et al. [57], in their study found a positive relationship between tangibility and profitability. Moreover, we can see that in this particular model, the effect of total asset turnover, as a control variable, on profitability is still positive ( $1.969$ ) and statistically significant, at level  $0.05$ . The effect of firm size and leverage, as control variables, remain negative and statistically insignificant.

In addition to these regression results, we can also see that R-sqr becomes higher by adding a control variable, from  $0.067$  to  $0.114$ , but still remain very low. This does not instantly indicate that model is not good, but rather that a predictability of the model is low, which is a very common, especially in the cases where is hard to predict behavior of some entities, as in social and economic areas. According to Kutner et al. [58], there are three misunderstandings regarding R-sqr: (1) high coefficient of determination indicates that useful predictions can be made (arises because R-sqr measures only a



relative reduction from the total variation and provides no information about absolute precision for estimating a mean response or predicting a new observation), (2) high coefficient of determination indicates that the estimated regression line is a good fit, and (3) low coefficient of determination indicates that X and Y are not related (the last two arise because R-sqr measures the degree of linear association between X and Y, whereas the actual regression relationship may be curvilinear).

To summarize, all four models formed by hierarchical regression (adding internal control variables, one by one) and presented in Table 5 confirm our main research hypotheses, but with different statistical significance results. More precisely, the results in Table 5 provide evidence that for certain increase in capital investments, ROA of manufacturing firms is expected to decrease in the year of investment, but to increase in the year after investment, while holding firm size, leverage, total asset turnover, and asset tangibility constant, and controlling for time-fixed effects as well. Our results support the findings from researchers such as Taipi and Ballkoci [33], Sudiyatno et al. [34], Pandya [35], who found a positive effect of capital investments on profitability, measured by return on assets. Moreover, our results support and complement the findings from Aljinović Barać and Muminović [20], who found, on the case of dairy processing industry in Slovenia, Croatia, and Serbia, a negative effect of capital investments on the short-term profitability, also expressed by return on assets, for which, according to the authors, a possible explanation can be found in the time lag between the moment of investment and the moment in the future when investment will generate the profit. Although other researchers have used different measures of profitability in their studies, we can say that in general, the results of this study also support the findings from, for example, Grazzi et al. [3], Aw et al. [22], Fama and French [25], Yu et al. [26], Löf and Heshmati [27], Johansson and Löf [28], Amoroso et al. [31], Curtis et al. [32], who found a positive relationship between capital investments and profitability.

**Table 5.** Pooled OLS regression results.

Variable	Model 1 b/se	Model 2 b/se	Model 3 b/se	Model 4 b/se
CI	−0.272 (0.17)	−0.815 *** (0.10)	−0.826 *** (0.09)	−0.810 *** (0.10)
CI_LAG	0.101 *** (0.02)	0.086 *** (0.02)	0.083 *** (0.02)	0.081 *** (0.02)
SIZE	−0.044 *** (0.01)	−0.046 ** (0.01)	−0.033 (0.02)	−0.023 (0.02)
LEV		−0.020 (0.03)	−0.039 (0.03)	−0.046 (0.03)
TAT			0.928 * (0.43)	1.969 * (0.79)
TANG				0.209 * (0.10)
constant	0.354 (0.20)	0.711 ** (0.26)	−0.365 (0.66)	−1.257 (1.00)
YEAR dummies	Yes	Yes	Yes	Yes
N	58	56	56	56
R-sqr	0.067	0.101	0.104	0.114
df	57	55	55	55

**Notes:** Pooled OLS regression with Driscoll–Kraay standard errors. Four models formed by hierarchical regression (adding internal control variables, one by one). ROA as dependent variable. Standard errors in parentheses. Significance levels: \*  $p < 0.05$ , \*\*  $p < 0.01$ , \*\*\*  $p < 0.001$ .

## 6. Conclusions

The findings of this study confirmed our main research hypotheses and empirical expectation that relationship between capital investments and firm performance should be positive because of the definition, nature, and time aspect of capital investments—they probably bring losses to the firm in the short term, but they should increase firm performance in the long term. Accordingly, we have indeed shown that capital investments have a negative effect on the firm performance in the short term,

but positive effect on the firm performance in the long term. More precisely, we found, in our panel data set, using pooled OLS regression, statistically significant effect of capital investments on firm performance, measured by return on assets, and considering both short-term and long-term aspects, while controlling for time-fixed effects and certain internal factors, such as firm size, leverage, total asset turnover, and asset tangibility.

The results of this research can contribute to the benefit of manufacturing firms, considering that capital investments have an important role in their sustainable development. They can be used by managers of manufacturing firms as a helpful tool while making strategic and investment decisions. These results also support the general fiscal policy which assumes that capital investments have a central role in stimulating growth and that capital investments causes better performance. Generally, the implication of our research is that the state governments, and especially government in Serbia where all analyzed firms are from, should encourage and support capital investment activities to ensure economic sustainability, while manufacturing firms, especially in Serbia, should invest more in sustainable production projects—which should be profitable, not just the path to insolvent borrowing.

This research, however, has some limitations. First, because of the lack of data, this study does not include factors such as, for example, particular type of manufacturing industry, state, or private ownership of the firm, exporter or importer firm, or other firm characteristics, which would help us to understand the relationship between capital investments and firm performance in a more comprehensive way. Second, the measurement of capital investment should also include amortization costs, but again, lack of data prevented inclusion of this component. Since this topic is, in general, poorly covered by the literature concerning the regional aspects, it could also be interesting to expand the research and see how capital investments, in interaction with geographical characteristics, affect firms' performance in different regions and possibly over a longer period of time. However, most of these factors require a larger amount of data, which lead us to the sample size as a third limitation of this study. The results could be affected by sample size, and a larger one would, surely, decrease the likelihood of skewing the results, which would increase the power of the study. Nevertheless, these limitations can be a solid ground for the future research directions.

**Author Contributions:** Conceptualization, V.G.; Formal analysis, V.G. and B.M.; Methodology, V.G., B.M. and M.R.; Resources, V.G.; Software, V.G.; Supervision, B.M. and M.R.; Validation, B.M., M.R., J.Š. and M.L.; Visualization, V.G.; Writing—original draft, V.G.; Writing—review and editing, V.G., B.M., M.R., J.Š. and M.L. All authors have read and agreed to the published version of the manuscript.

**Funding:** This research received no external funding.

**Conflicts of Interest:** The authors declare no conflict of interest.

## Appendix A. Hausman, Breusch and Pagan Lagrangian multiplier, serial correlation, heteroscedasticity and cross-sectional dependence tests.

**Table A1.** Hausman test for fixed effects and random effects.

Variable	Coefficients			
	(b) fixed	(B) random	(b-B) Difference	sqrt(diag(V <sub>b</sub> -V <sub>B</sub> )) S.E.
CI	-0.796	-0.810	0.014	0.128
CI_LAG	0.074	0.081	-0.006	0.035
SIZE	-0.298	-0.023	-0.275	0.274
LEV	-0.172	-0.046	-0.127	0.096
TAT	6.418	1.969	4.449	2.418
TANG	0.317	0.209	0.108	0.207

b = consistent under  $H_0$  and  $H_a$ ; obtained from xtreg. B = inconsistent under  $H_a$ , efficient under  $H_0$ ; obtained from xtreg. Test:  $H_0$ : difference in coefficients not systematic.  $\chi^2(7) = (b-B)'[(V_b-V_B)^{-1}](b-B) = 14.71$ ; Prob> $\chi^2 = 0.4727$ .

**Table A2.** Breusch and Pagan Lagrangian multiplier test for random effects.

Variable	Var	sd = sqrt (Var)
ROA	1.000	1.000
e	0.946	0.973
u	0.000	0.000

ROA[ID,t] = Xb + u[ID] + e[ID,t]. Test: Var(u) = 0. chibar2(01) = 0.00. Prob > chibar2 = 1.0000.

**Table A3.** Test for serial correlation and heteroscedasticity in panel data.

Serial correlation/ Heteroscedasticity		Wooldrige test. H0: no first-order autocorrelation	Breusch-Pagan/Cook-Weisberg H0: Constant variance
Serial correlation	F (1,48) Prob > F	6.202 0.016	
Heteroscedasticity	chi2 (1) Prob > chi2		9.57 0.002

**Table A4.** CD-test for cross-sectional dependence in panel data.

Variable	CD-test	p-value	average joint T	Mean	mean abs
ROA	4.221	0	6.28	0.03	0.3
CI	22.525	0	8.93	0.18	0.32
CI_LAG	23.535	0	7.93	0.2	0.35
SIZE	23.716	0	8.11	0.19	0.56
LEV	3.059	0.002	6.83	0.03	0.42
TAT	2.724	0.006	8.11	0.02	0.41
TANG	6.474	0	8.11	0.05	0.48

Notes: Under the null hypothesis of cross-section independence, CD ~ N(0,1). P-values close to zero indicate data are correlated across panel groups.

## Appendix B. Fixed effects and random effects regression results.

**Table A5.** Fixed effects regression results.

Variable	Model 1 b/se	Model 2 b/se	Model 3 b/se	Model 4 b/se
CI	-0.196 (0.18)	-0.785 ** (0.25)	-0.749 ** (0.27)	-0.796 ** (0.27)
CI_LAG	0.089 * (0.03)	0.074 * (0.03)	0.072 (0.04)	0.074 (0.04)
SIZE	-0.288 (0.18)	-0.520 ** (0.15)	-0.267 (0.19)	-0.298 (0.19)
LEV		-0.172 (0.11)	-0.186 (0.11)	-0.172 (0.11)
TAT			5.973 * (2.58)	6.418 * (2.42)
TANG				0.317 (0.16)
constant	2.846 (1.65)	5.371 *** (1.43)	-3.177 (3.99)	-2.990 (3.94)
YEAR dummies	Yes	Yes	Yes	Yes
N	58	56	56	56
R-sqr	0.076	0.125	0.140	0.146
df	57	55	55	55

Notes: Fixed effects regression with Driscoll–Kraay standard errors. Four models formed by hierarchical regression (adding internal control variables, one by one). ROA as dependent variable. Standard errors in parentheses. Significance levels: \*  $p < 0.05$ , \*\*  $p < 0.01$ , \*\*\*  $p < 0.001$ .

Table A6. Random effects regression results.

Variable	Model 1 b/se	Model 2 b/se	Model 3 b/se	Model 4 b/se
CI	−0.272 (0.21)	−0.815 * (0.32)	−0.826 ** (0.32)	−0.810 * (0.33)
CI_LAG	0.101 * (0.04)	0.086 * (0.04)	0.083 * (0.04)	0.081 (0.04)
SIZE	−0.044 * (0.02)	−0.046 (0.02)	−0.033 (0.03)	−0.023 (0.03)
LEV		−0.020 (0.03)	−0.039 (0.03)	−0.046 (0.04)
TAT			0.928 (0.91)	1.969 (1.02)
TANG				0.209 ** (0.08)
constant	0.354 (0.47)	0.711 (0.45)	−0.365 (1.13)	−1.257 (1.22)
YEAR dummies	Yes	Yes	Yes	Yes
N	58	56	56	56
R-sqr	0.067	0.101	0.104	0.114
df	57	55	55	55

Notes: Random effects Generalized Least Squares (GLS) regression with clustered standard errors. Four models formed by hierarchical regression (adding internal control variables, one by one). ROA as dependent variable. Standard errors in parentheses. RE coefficients match with pooled OLS coefficients because “rho=0” (variability is mainly within firms, not between firms). Significance levels: \*  $p < 0.05$ , \*\*  $p < 0.01$ , \*\*\*  $p < 0.001$ .

## References

1. Eurostat. Available online: <https://ec.europa.eu/eurostat/home> (accessed on 28 October 2019).
2. Lev, B.; Thiagarajan, S.R. Fundamental information analysis. *J. Account. Res.* **1993**, *31*, 190–215. [CrossRef]
3. Grazzi, M.; Nadia, J.; Tania, T. Dynamics of investment and firm performance: Comparative evidence from manufacturing industries. *Empir. Econ.* **2016**, *51*, 125–179. [CrossRef]
4. Shpak, N.; Sorochak, O.; Hvoz, M.; Sroka, M. Risk evaluation of the reengineering projects: A case study analysis. *Sci. Ann. Econ. Bus.* **2018**, *65*, 215–226. [CrossRef]
5. US. Department of Commerce. Sustainable Manufacturing Initiatives (SMI): A True Public–Private Dialogue. 2010. Available online: <https://www.oecd.org/sti/ind/45010349.pdf> (accessed on 9 September 2019).
6. Bansal, P. Evolving sustainably: A longitudinal study of corporate sustainable development. *Strateg. Manag. J.* **2005**, *26*, 197–218. [CrossRef]
7. Power, L. The missing link: Technology, investment, and productivity. *Rev. Econ. Stat.* **1998**, *80*, 300–313. [CrossRef]
8. Grabowski, H.G.; Dennis, C.M. Managerial and stockholder welfare models of firm expenditures. *Rev. Econ. Stat.* **1972**, *54*, 9–24. [CrossRef]
9. Nilsen, Ø.A.; Raknerud, A.; Rybalka, M.; Skjerpen, T. Lumpy investments, factor adjustments, and labour productivity. *Oxf. Econ. Pap.* **2008**, *61*, 104–127. [CrossRef]
10. Shima, K. Lumpy capital adjustment and technical efficiency. *Econ. Bull.* **2010**, *30*, 2817–2824.
11. Titman, S.; Wei, K.J.; Feixue, X. Capital investments and stock returns. *J. Financ. Quant. Anal.* **2004**, *39*, 677–700. [CrossRef]
12. Jovanovic, B.; Peter, L. Rousseau. Extensive and intensive investment over the business cycle. *J. Political Econ.* **2014**, *122*, 863–908. [CrossRef]
13. Yao, T.; Yu, T.; Zhang, T.; Chen, S. Asset growth and stock returns: Evidence from Asian financial markets. *Pac. Basin Financ. J.* **2011**, *19*, 115–139. [CrossRef]
14. Sircar, S.; Turnbow, J.L.; Bordoloi, B. A framework for assessing the relationship between information technology investments and firm performance. *J. Manag. Inf. Syst.* **2000**, *16*, 69–97. [CrossRef]
15. Singh, N.; Ma, J.; Yang, J. Optimizing environmental expenditures for maximizing economic performance. *Manag. Decis.* **2016**, *54*, 2544–2561. [CrossRef]

16. Aktas, N.; Croci, E.; Petmezas, D. Is working capital management value-enhancing? Evidence from firm performance and investments. *J. Corp. Financ.* **2015**, *30*, 98–113. [[CrossRef](#)]
17. Alipour, M.; Mohammadi, M.F.S.; Derakhshan, H. Determinants of capital structure: An empirical study of firms in Iran. *Int. J. Law Manag.* **2015**, *57*, 53–83. [[CrossRef](#)]
18. Jindrichovska, I.; Ugurlu, E.; Kubickova, D. Changes in capital structure of Czech SMEs: A dynamic panel data approach. *Ekon. Manag.* **2013**, *3*, 19.
19. Fernández-Rodríguez, E.; García-Fernández, R.; Martínez-Arias, A. Influence of Ownership Structure on the Determinants of Effective Tax Rates of Spanish Companies. *Sustainability* **2019**, *11*, 1441. [[CrossRef](#)]
20. Aljinović Barać, Ž.; Muminović, S. The impact of capital investments on dairy processing industry features: Evidence from Slovenia, Croatia and Serbia. *Mljekarstvo Časopis Za Unapređenje Proizv. I Prerade Mlijeka* **2013**, *63*, 140–149.
21. Ching-Hai, J.; Hsiang-Lan, C.; Yen-Sheng, H. Capital expenditures and corporate earnings. *Manag. Financ.* **2006**, *32*, 853.
22. Aw, B.Y.; Mark, J.R.; Daniel, Y.X. R&D investments, exporting, and the evolution of firm productivity. *Am. Econ. Rev.* **2008**, *98*, 451–456.
23. Gradzewicz, M. What happens after an investment spike-investment events and firm performance. *J. Bus.* **2020**. [[CrossRef](#)]
24. Namiotko, V.; Baležentis, T. Dynamic Efficiency under Investment Spikes in Lithuanian Cereal and Dairy Farms. *Econ. Sociol.* **2017**, *10*, 33. [[CrossRef](#)]
25. Fama, E.F.; French, K.R. The corporate cost of capital and the return on corporate investment. *J. Financ.* **1999**, *54*, 1939–1967. [[CrossRef](#)]
26. Yu, X.; Dosi, G.; Grazzi, M.; Lei, J. Inside the virtuous circle between productivity, profitability, investment and corporate growth: An anatomy of Chinese industrialization. *Res. Policy* **2017**, *46*, 1020–1038. [[CrossRef](#)]
27. Löf, H.; Heshmati, A. Investment and performance of firms: Correlation or causality? *Corp. Ownersh. Control* **2008**, *6*, 268–282.
28. Johansson, B.; Löf, H. The impact of firm's R&D strategy on profit and productivity. *Work. Pap. Ser. Econ. Inst. Innov. R. Inst. Technol.* **2008**, *156*, 28.
29. Licandro, O.; Maroto, R.; Luis, A.P. Innovation, investment and productivity: Evidence from Spanish firms. *EUI Work. Pap. Eco* **2004**, *7*, 38.
30. Kapelko, M.; Lansink, A.O.; Stefanou, S.E. Analyzing the impact of investment spikes on dynamic productivity growth. *Omega* **2015**, *54*, 116–124. [[CrossRef](#)]
31. Amoroso, S.; Moncada-Paternò-Castello, P.; Vezzani, A. R&D profitability: The role of risk and Knightian uncertainty. *Small Bus. Econ.* **2017**, *48*, 331–343.
32. Curtis, A.; McVay, S.E.; Toynbee, S. The changing implications of research and development expenditures for future profitability. *Available SSRN* **2018**, *2402886*, 49.
33. Ester, T.; Ballkoci, V. Capital Expenditure and Firm Performance Evidence from Albanian Construction Sector. *Eur. Sci. J.* **2017**, *13*, 231–238.
34. Sudiyatno, B.; Puspitasari, E.; Kartika, A. The company's policy, firm performance, and firm Value: An empirical research on Indonesia Stock Exchange. *Am. Int. J. Contemp. Res.* **2012**, *2*, 30–40.
35. Pandya, B. Impact of capital expenditure on firm's financial performance: A Study of Select Infrastructure Companies in India. *NICE J. Bus.* **2017**, *12*, 75–83.
36. Mithas, S.; Ali, R.T.; Bardhan, I.; Goh, J.M. Information technology and firm profitability: Mechanisms and empirical evidence. *MIS Q.* **2012**, *36*, 205–224. [[CrossRef](#)]
37. Arvanitis, S.; Penede, M.; Rammer, C.; Stucki, T.; Woerter, M. Development and utilization of energy-related technologies, economic performance and the role of policy instruments. *J. Clean. Prod.* **2017**, *159*, 47–61. [[CrossRef](#)]
38. Bostian, M.; Färe, R.; Grosskopf, S.; Lundgren, T. Environmental investment and firm performance: A network approach. *Energy Econ.* **2016**, *57*, 243–255. [[CrossRef](#)]
39. Lee, N.; Lee, J. External Financing, R&D Intensity, and Firm Value in Biotechnology Companies. *Sustainability* **2019**, *11*, 4141.
40. Götzte, U.; Northcott, D.; Schuster, P. Investment Appraisal. In *Methods and Models*; Springer: Berlin/Heidelberg, Germany, 2008; p. 3.
41. Hagel, J.; Brown, J.S.; Davison, L. The best way to measure company performance. *Harv. Bus. Rev.* **2010**, *4*.

42. Serbian Busines Register Agency. Available online: <https://www.apr.gov.rs/home.1435.html> (accessed on 9 September 2019).
43. Frees, E.W. Fixed Effects Models. In *Longitudinal and Panel Data: Analysis and Applications in the Social Sciences*; Cambridge University Press: Cambridge, UK, 2004; pp. 20–22.
44. Drukker, D.M. Testing for serial correlation in linear panel-data models. *Stata J.* **2003**, *3*, 168–177. [[CrossRef](#)]
45. De Jager, P. Panel data techniques and accounting research. *Meditari Account. Res.* **2008**, *16*, 53–68. [[CrossRef](#)]
46. Baltagi, B.H. *Econometric Analysis of Panel Data*, 3rd ed.; John Wiley & Sons: Hoboken, NJ, USA, 2005; p. 79.
47. De Hoyos, R.E.; Sarafidis, V. Testing for cross-sectional dependence in panel-data models. *Stata J.* **2006**, *6*, 482–496. [[CrossRef](#)]
48. Sarafidis, V.; Wansbeek, T. Cross-sectional dependence in panel data analysis. *Econom. Rev.* **2012**, *31*, 483–531. [[CrossRef](#)]
49. Pesaran, M.H. General diagnostic tests for cross section dependence in panels. *IZA Discuss. Pap.* **2004**, *1240*, 41.
50. Pesaran, M.H. Testing weak cross-sectional dependence in large panels. *Econom. Rev.* **2015**, *34*, 1089–1117. [[CrossRef](#)]
51. Hoechle, D. Robust standard errors for panel regressions with cross-sectional dependence. *Stata J.* **2007**, *7*, 281–312. [[CrossRef](#)]
52. Kartikasari, D.; Merianti, M. The effect of leverage and firm size to profitability of public manufacturing companies in Indonesia. *Int. J. Econ. Financ. Issues* **2016**, *6*, 409–413.
53. Pervan, M.; Višić, J. Influence of firm size on its business success. *Croat. Oper. Res. Rev.* **2012**, *3*, 213–223.
54. Ahmad, N.; Salman, A.; Shamsi, A. Impact of financial leverage on firms' profitability: An investigation from cement sector of Pakistan. *Res. J. Financ. Account.* **2015**, *6*, 1697–2222.
55. Dencic-Mlihajlov, K. Profitability during the financial crisis: Evidence from the regulated capital market in Serbia. *South East. Eur. J. Econ.* **2015**, *12*, 7–33.
56. Bhutta, N.T.; Hasan, A. Impact of firm specific factors on profitability of firms in food sector. *Open J. Account.* **2013**, *2*, 19. [[CrossRef](#)]
57. Al-Jafari, M.K.; Samman, A.H. Determinants of profitability: Evidence from industrial companies listed on Muscat Securities Market. *Rev. Eur. Stud.* **2015**, *7*, 303. [[CrossRef](#)]
58. Kutner, M.H.; Nachtsheim, C.J.; Neter, J.; Li, W. *Applied Linear Statistical Models*; McGraw-Hill Irwin: New York, NY, USA, 2005.



© 2020 by the authors. Licensee MDPI, Basel, Switzerland. This article is an open access article distributed under the terms and conditions of the Creative Commons Attribution (CC BY) license (<http://creativecommons.org/licenses/by/4.0/>).

Article

# New Agricultural Model of Economic Sustainability for Wheat Seed Production in Romania

Romeo Victor Ionescu <sup>1</sup>, Monica Laura Zlati <sup>2</sup>, Valentin Marian Antohi <sup>3,\*</sup>, Silvius Stanciu <sup>4</sup>, Florina Oana Virlanuta <sup>5</sup> and Cristina (Băcanu) Serban <sup>4</sup>

<sup>1</sup> Department of Administrative Sciences and Regional Studies, Dunarea de Jos University, 111th Domneasca Street, 800201 Galati, Romania; ionescu\_v\_romeo@yahoo.com

<sup>2</sup> Department of Accounting, Audit and Finance, Stefan cel Mare University, 720229 Suceava, Romania; sorici.monica@usm.ro

<sup>3</sup> Department of Business Administration, Dunarea de Jos University, Nicolae Balcescu Street, no. 59–61, 800001 Galati, Romania

<sup>4</sup> Department of Applied Sciences, “Dunarea de Jos” University of Galați, 47 Domnească Street, 800001 Galați, Romania; sstanciu@ugal.ro (S.S.); serbancing@yahoo.com (C.B.S.)

<sup>5</sup> Department of Economics, Dunarea de Jos University, Nicolae Balcescu Street, no. 59–61, 800001 Galati, Romania; florina.virlanuta@ugal.ro

\* Correspondence: valentin\_antohi@yahoo.com; Tel.: +40-731-221-001

Received: 5 February 2020; Accepted: 18 May 2020; Published: 20 May 2020

**Abstract:** In the conditions of a digitalized and sustainable economy, a smart decision is focused on all demand aspects regarding: the product demand, the quality demand, and the elements of national and international bodies able to ensure the criteria of economic integrity on the European Markets. These aspects represent a set of challenges and indicate the smart component of the management decision assisted by reliable economic models. The present work aims to develop such a model applied to the wheat seed production starting from the study of the specialized literature and using empirical methods. The analysis covers 2016–2020. The main objective of the study is the combination of the information from the observational study to obtain the smart decision model. The study results in the smart model of managerial decision, which represents a real necessity for managers, considering the challenges to which they are subjected. The proposed model in the paper can be used for all types of seeds across the EU and not only. The implementation of the present study by the authors validates the proposed model.

**Keywords:** sustainable agriculture; efficiency; smart decision; agricultural production; economic model

## 1. Introduction

The European Union (EU) is implementing the 7th Environment Action Program (EAP) in order to support economic development under sustainability. The 7th EAP is coupled with the EU 2020 Biodiversity Strategy. This new document sets targets for 2020 and a European vision by 2050, when the current environmental and biodiversity challenges will be overcome. One of the main goals set by the EU 2020 Biodiversity Strategy is to increase the contribution of agriculture and forestry to maintaining and restoring biodiversity [1,2].

In addition, the European Commission has defined a roadmap for achieving a competitive and low-carbon economy by 2050. This document contains ambitious targets for reducing carbon dioxide emissions. One of these targets is focused on agriculture (see Table 1).

**Table 1.** EU-level pollution reduction in agriculture (compared to 1990).

	2005	2030	2050
Total	−7%	−40 to −44%	−79 to −82%
Agriculture (non-CO <sub>2</sub> )	−20%	−36 until −37%	−42 until −49%

Source: authors’ contribution using [3].

According to the above approach, the EU agriculture has a great importance in supporting sustainable development. European Union represents an important actor of the global agriculture nowadays. The crop production achieved a positive trend during the last three years across the EU (see Figure 1) [4].

In 2018, the EU crop production accounted for 56.3% of the value of total agricultural production. On the other hand, EU is an important player in the international market for agricultural products. During 2015–2019, the EU’s exports of wheat varied from 7.7 to 6.1 million tonnes, while the EU’s imports decreased from 17.3 to 8.6 million tonnes (see Figure 2) [3].

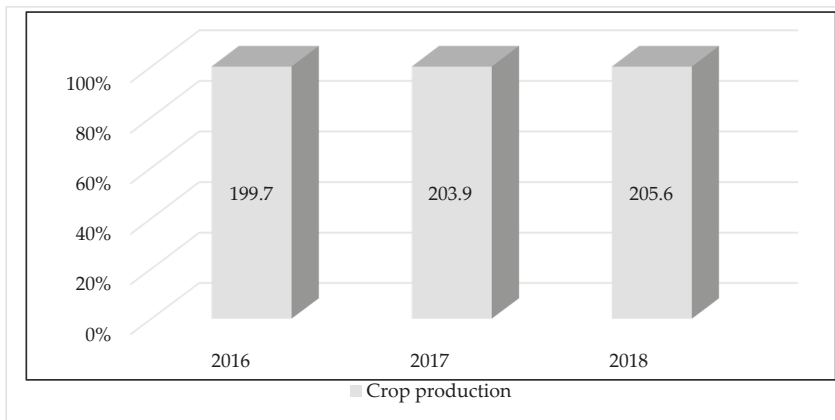

**Figure 1.** Evolution of the European crop production (billions euros). Source: authors’ contribution using [4].

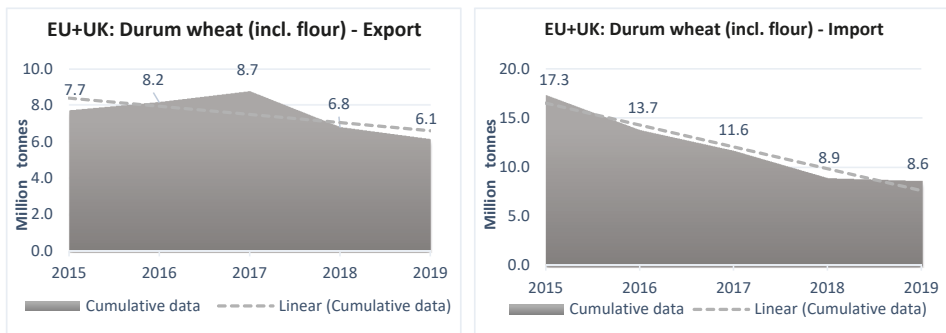

**Figure 2.** The EU foreign trade in wheat during 2015–2019 (million tonnes). Source: authors’ contribution using [3].

Romania has maintained its status as an important agricultural producer within the EU [5,6]. As a result, in 2016, Romania ranked first in the EU for sunflower production and second for wheat and corn production, after France, according to data from the National Institute of Statistics.



In 2018, Romanian agriculture ranked 3rd in the EU, after France and Germany, in cereal production (31.9 million tons). Romania achieved 4th rank in the EU, with 10.3 million tons of wheat production [3].

Our research puts into direct connection the EU implication in sustainable development and the agriculture's impact on it.

There is a great interest motivated by the objectives of the 2030 Joint Agenda [7] regarding the implementation of smart-sustainable solutions in the field of agricultural production, including the achievement of the maximum productive potential with the rational use of resources in order to prevent the degradation of the environment.

Starting from the EU's specific objectives on sustainability, the sustainable provision of food resources represents a pole of the Community interest, considering the degradation of the global climatic conditions and the impact of the cereal productions through the use of the traditional mechanisms of economically assisted decision. These mentioned premises clearly indicate the opportunity of a well-founded study on a new approach to the smart decision process for maximizing the positive ecological and economic effects related to the sustainable production assurance.

This opportunity can be achieved using and defining the following scientific objectives of the study:

Objective 1: conducting an experimental study on the opportunity to optimize the production decision of a wheat variety based on specific technical-productive indicators;

Objective 2: building a database for the preliminary processing of the smart decision-assisted model;

Objective 3: making a technical evaluation of the smart model based on the outputs resulted from the experimental study and the test conditions established by the authors through the working hypotheses;

Objective 4: quantifying the financial impact by introducing in the model of the economic variables to optimize the decision process;

Objective 5: making an evaluation of the model's results;

Objective 6: reconsidering the model from the sustainability indicators point of view.

The study of the specialized literature supports our scientific approach in building a new model applied to the sustainable agriculture development. During 2014–2019, many researchers studied the connection between the agriculture development, the final demand of the users for high quality products (bio products) and the world trade sustainability's condition. A short review of the most significant papers in this area is presented in Table 2.

From the analysis of the specialized literature in agriculture production and sustainability, resides the need to introduce and integrate the concepts of economic sustainability in the food field and to consolidate the economic practices with the productive practices in order to fulfill the social objectives (providing the necessary food for the population) with the economic objectives (obtaining a superior economic yield) and with the European objectives for the creation of the sustainable framework in accordance with the European Horizon 2030 Agenda. The sustainable development means concentrating the research on the best agricultural practices (high-performance technologies and seed material with productive genetic potential) and sustainability by protecting cultivated soils against the land degradation and utilizing the maximized resources. In agriculture, the sustainability is the guarantee of the large agricultural productions, without undermining the resources that depend on productivity.

The cultivation of wheat varieties with wide adaptability to the soil and climate conditions and technological conditions can reduce the risks of crop fluctuation in the unfavorable years. In order to minimize the harvest losses caused by unfavorable soil and climate conditions factors, it is necessary to promote in this area the wheat varieties with good adaptability to such conditions and the application of appropriate modern technologies.

In a world in which the highest yielding varieties are sought on the agricultural market to achieve the highest yields, however, there are constraints on resources, where ecosystems are degraded, due to intensive technologies, treatments and excess fertilizers. It is recommended to develop and apply technological measures that are as environmentally friendly as possible (optimization of the

quantities of chemical fertilizers, pesticides and herbicides, using of efficient agricultural machinery and equipment, precision seeders, low energy consumption and diesel), which reduce the negative impact on the environment and to conserve natural resources.

**Table 2.** Literature review.

No.	Authors	Link with Research Area	Model's Characteristics	Criticism
1.	Guerry, A.D. et al., 2015 [8].	High: strategic land development; the multinationals' impact on the agricultural production.	The administrative and limiting expansionary aspects, are confronted with limitations from the environmental issues on the following interest areas: safety/security of water resources; strategic land development; the multinationals' impact on the agricultural production; sustainable investments; food and economic security.	High impact, low adjustment need, missing similar model with the authors' study: The present study made clear the importance of assessing the ecosystems from the increasing of the need for food for a population point of view, population with a high demographic rate and the disconnection, against the background of the demand increase, the production from the principles of sustainability. Used criteria: novelty, research theme adhering, applicability.
2.	Speelman, E.N., García-Barrios, L.E., Groot, J.C.J., and Tittone, P. (2014) [9].	High: the technical aspects of the production generated by the implementation of the CAP.	The authors have focused on finding supportive decision-making tools to ensure the green economy as the main source of food supply in Europe. The presented model integrates the technical aspects of the production generated by the implementation of the CAP with the economic aspects, including for the calculation of the minimum need for subsidies in agriculture.	High impact, low adjustment need, missing similar model with the authors' study: The presented aspects in an interactive manner can be interesting and feasible only insofar as the financial projections would be treated in a non-linear manner, different from that of the authors mentioned above. Used criteria: novelty, research theme adhering, applicability.
3.	Cotidianul agricol, 2019 [10].	High: the direct effect of agricultural production; study on the agricultural policy decisions; dynamic model for integrating into the agricultural mechanism.	Another approach at European level concerns the direct effect of agricultural production on the greenhouse gas emissions level. The authors' study on the agricultural policy decisions in relation to limiting the greenhouse gases effects brings into question an integrated dynamic model from which the medium and long-term economic effects (2030) emerge for integrating into the agricultural mechanism effects of the circular economy, including the use of reverse cycle's fertilizer production, use of biomass and eco-agricultural practices.	High impact, low adjustment need, missing similar model with the authors' study: All these aspects are aimed at improving agricultural management and increasing agricultural production in sustainable terms. Used criteria: novelty, research theme adhering, applicability.
4.	Đurišová, M., Tokarčíková, E., Virlanuta, F.O., and Chodasová, Z., 2019 [11]. Aiello, G., Giovino, I., Vallone, M., Catania, P., and Argento, A., 2018. [12].	Average: sustainability agriculture, sustainability in agricultural production.	Other authors quantify the impact of transport on sustainability, agriculture being one of the economic sectors benefiting from transport services. Increasing the sustainability of transports is implicitly found in increasing sustainability in agricultural production, transport being considered in this case a resource used in the production process.	Average impact, medium adjustment need, missing similar model with the authors' study: The lack of an efficient infrastructure directly limits the sustainable development process of agriculture through inefficient use of resources and by supplementing the consumption of fossil fuel in agricultural production. This imbalance also affects the level of greenhouse gas emissions. Used criteria: novelty, research theme adhering, applicability.
5.	Florea, A.-M., Bercu, F., Radu, R.I., and Stanciu, S., 2019, [13].	High: fuzzy model for increasing regional cooperation of agricultural producers and ensuring long-term sustainability goals.	Some authors have focused on qualitative comparative analysis based on the fuzzy model for increasing regional cooperation of agricultural producers and ensuring long-term sustainability goals.	High impact, low adjustment need, missing similar model with the authors' study: The model presents in a dynamic approach the essential aspects of the agricultural cooperation with effect in increasing the regional cohesion and in improving the conditions necessary for a sustainable development in accordance with the 2030 Common Agenda. Used criteria: novelty, research theme adhering, applicability.

Table 2. Cont.

No.	Authors	Link with Research Area	Model's Characteristics	Criticism
6.	Antle, J.M. et al., 2017, [14]. Yan, B., Shi, S., Ye, B., Zhou, X., and Shi, P., 2015, [15].	High: decision to use the soils according to the determinable economic parameters; production management	A different perspective is offered by presenting a concept regarding the decision to use the soils according to the determinable economic parameters, such as consumption based on declared needs, followed by the optimization of the entire production chain based on technological inputs, production management, reuse of biomaterials, ensuring the distribution function and consumption through the integrated management resource.	High impact, low adjustment need, missing similar model with the authors' study: The authors propose the development of a model that has to be subsequently integrated into the industrialized agricultural systems assisted by IT resources. Used criteria: novelty, research theme adhering, applicability.
7.	Triste, L., Marchand, F., Debruyne, L., Meul, M., and Lauwers, L., 2014, [16].	High: multiplicative model of the relations between the managers of agricultural processes, the land use improvement and the social relations based on the consensual use of the resources.	An interesting approach based on game theory is presented from the perspective of the sustainability of land use increasing. The presented scheme is a multiplicative model of the relations between the managers of agricultural processes that generates through collective effort the land use improvement and the social relations based on the consensual use of the resources.	High impact, low adjustment need, missing similar model with the authors' study: The sustainable aspects lie in the creation of the collective decision-making process and in establishing the destinations of agricultural lands, including their short-term planning Used criteria: novelty, research theme adhering, applicability.
8.	Triste, L., Marchand, F., Debruyne, L., Meul, M., and Lauwers, L., 2017, [17].	High: a tool for implementing sustainable development under the conditions of the cluster approach.	Critics against the agriculture sustainability are scientifically fought in a paper that proposes a tool for implementing sustainable development under the conditions of the cluster approach.	High impact, low adjustment need, missing similar model with the authors' study: These clusters allow farmers to know the best practices from landowners and agricultural holding companies, to participate in catching processes and to structure the development of different types of sustainable agricultural instruments. Used criteria: novelty, research theme adhering, applicability.
9.	Cosmulese, C.G.; Socoliuc, M.; Ciubotariu, M.S. Mihailea, S.; Grosu, V., 2019, [18].	Average: sustainable development	Within the present-day economic situation ensuring sustainable development directly and implicitly contributes to the creation of value for all stakeholders, but the policies of environmental protection or social ones as well as those of promotion and intensification of the research-innovation activity should not be ignored.	Average impact, medium adjustment need, missing similar model with the authors' study: The approach is too theoretical. Used criteria: novelty, sustainability concept and applicability.
10.	Gocsik, É., Saatkamp, H.W., de Lauwere, C.C., and Oude Lansink, A.G.J.M., 2014, [19].	High: agriculture development; bio products; a structured model able to capture the sustainable aspect by sizing the supply according to the demand, thus being able to customize all the elements favorable to the sustainable production.	This is a reference article on managerial innovation in agriculture developed through the case study of Swedish agricultural companies. The study takes into account limited aspects of the exogenous barriers innovation, the technological over specialization (waste of resources), the exacerbation of land use and the inclination on the classic managerial approaches on the agricultural segment. The model addresses both the demand generating segment, which moves the area of understanding from the retailer to the small producers dedicated to a small group of consumers (bio products), the qualitative value of the offered product, the shortening of the distribution chain, the approach of a direct marketing and the personalization of the production according to the demand. The structured model captures the sustainable aspect by sizing the supply according to the demand, thus being able to customize all the elements favorable to the sustainable production.	High impact, low adjustment need, missing similar model with the authors' study: From the economic point of view, the efficiency of the approach is limited in time due to the change of the consumers which implies the model's flexibility. Used criteria: novelty, sustainability concept and applicability.

Table 2. Cont.

No.	Authors	Link with Research Area	Model's Characteristics	Criticism
11.	Sivertsson, O. and Tell, J., 2015, [20] Mates, D.; Grosu, V. 2008, [21].	Average: sustainability; consumers and farmers in the production process.	At the European level, the sustainability is considered as a major priority by consumers and farmers in the production process, being open to the use of innovative technologies for obtaining foods with higher nutritional value.	Average impact, medium adjustment need, missing similar model with the authors' study: The sustainability concept is not adequate presented in the models. Used criteria: novelty, sustainability concept and applicability.
12.	Đurišová, M., Tokarčíková, E., Kucharčíková, A., 2015, [22], Tadeu, P., Paiva, T., 2015, [23].	High: smart models of managerial decision.	In the actual economic context, the smart models of managerial decision offers innovative opportunities in all sectors, to increase the productivity and to support sustainable economic growth.	Average impact, medium adjustment need, missing similar model with the authors' study: The models are not able to quantify the sustainability development as a result of the insufficient number of analyzed indicators. Used criteria: novelty, sustainability concept and applicability.

This technical approach indicates the implementation of an assisted decision model under the conditions of using the selection of indicators based on the comparability of the actual performances with those ensured at certification.

## 2. Materials, Methods and Models

According to the above study's aims, the present research explains the sustainability approach based on developing, implementing and promoting sustainable practices in Romania. In this regard, eight varieties of autumn wheat, two indigenous and two French were analyzed (Glosa, FDL Miranda, Sorial, Solveig, Litera, Izvor, Apache and Avenue).

The Romanian wheat varieties Glosa and FDL Miranda belong to the maintainer of the National Agricultural Research and Development Institute Fundulea (NARDI Fundulea) and are listed in the Official Variety Catalog in 2005 and 2011 respectively. The wheat variety sown in the field should adapt better to the climatic conditions (to withstand drought and frost conditions) and to the soil on which it is cultivated, acclimating even on soils with low fertility, so that the obtained quality and yield to be as large as possible. The choice of these varieties of wheat must be made taking into account all these factors [24,25].

The research algorithm applied to this study is presented in Figure 3. The scheme respects a logical succession regarding the organization of the research process, considering the complexity of the studied phenomenon that combines the smart elements of the production decision with the smart elements of the economically sustainable decision. We define the smart decision as that decision based on practices and economics, delimited in time and space, by means of a probabilistic selection mechanism. This mechanism is based on the productive and economic efficiency. As a result, the economic agents can achieve the objectives of performance, sustainability and social compliance on the food segment. According to Figure 3, the study methodology covers the research of the models already implemented (but unable to quantify the sustainable development of the wheat production) and presented in Literature review (12 models debated analytically and critically according to Table 2). We can identify the current applicability for a smart decision model, define working hypotheses, the model and its testing through laboratory and field. The research covers the successive results during three calendar years regarding the qualitative yields of the 8 wheat varieties tested on 4 types of soil (soils). The qualitative characteristics of the soils are included in classes 2 and 3 of quality (good, respectively average) and whose PH, varies from neutral to alkaline on the interval 6.9–8.04, reaching differentiated values depending on the study year with the influence of pedoclimatic conditions. These type of lands can be found anywhere in Europe, not only in Romania, in areas with temperate climates. As a result, the analysis methodology is universally valid.

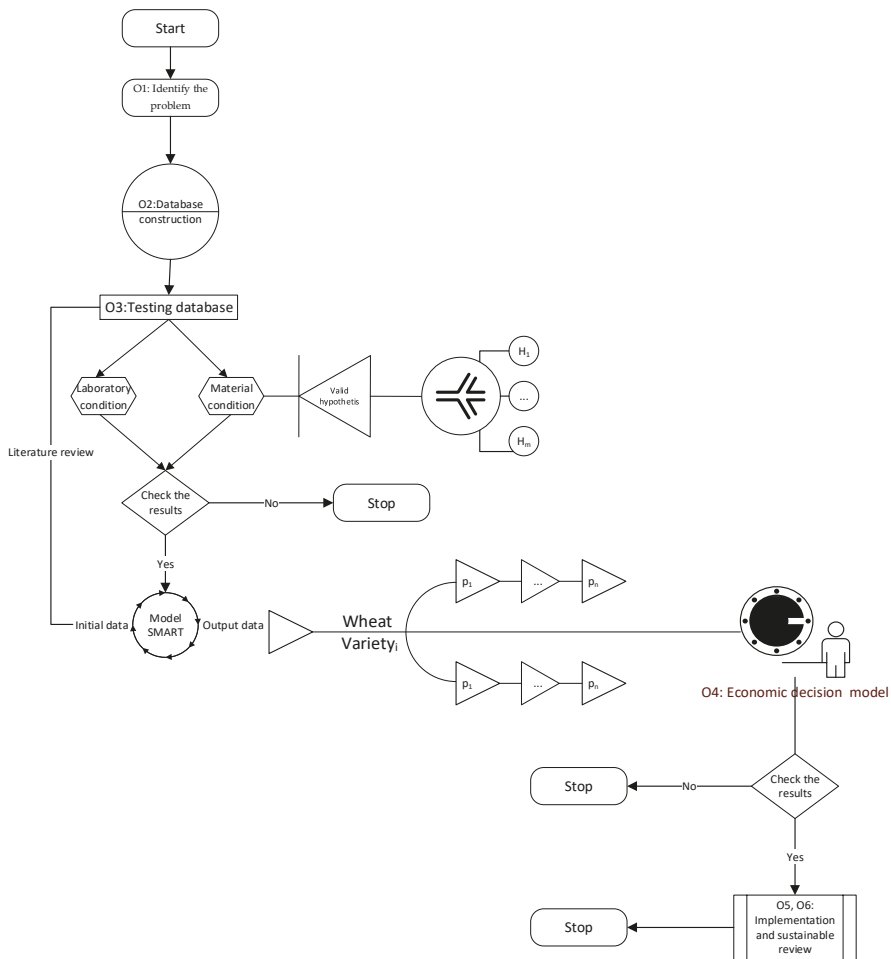

Figure 3. Scheme of the research algorithm.

The proposed model is completely new for which no precedents have been identified in the literature.

The logic scheme covers the six objectives of the research mentioned above by testing the following *working hypotheses*:

**Hypothes H1:** *The methods of determining the quantitative yield of the seed material are directly related to the technical properties specified in the variety accreditation standards.*

**Hypothes H2:** *The impact on the quantitative yield is even greater as the characteristics of the varieties are representative for the whole cultivated lot.*

**Hypothes H3:** *Qualitative factors (humidity and germination) have a high impact on the decision-making process, but the relationship of dependence is lessened by the changes of the soil and climate conditions.*

**Hypothes H4:** *The traceability of the productive yield differs between the indigenous and foreign varieties.*

**Hypothes H5:** *The economically assisted decision function is directly related to the managerial capacity to make decisions on the productive chain, the logistics chain and the distribution chain under sustainability conditions.*

**Hypothes H6:** *In order to ensure the smart optimization of the decision, it is necessary to ensure the traceability of the entire decision-making chain, from the selection of the variety to production, storage and marketing. The vulnerabilities registered in the primary stages propagate directly over the entire business cycle.*

In order to test the working hypotheses and to elaborate the SMART model, we define the following functions and parameters. The qualitative characteristics of the seed material with *high qualitative impact on the smart decision*:

1. Let  $U$  be the moisture function required to ensure the quality of the production. We can say that there is  $\lambda_t \neq 0$  so that  $U_t = \lambda_t U_0$ , where  $U_0$  = the recommended seasonal humidity reached by technical standards;  $\lambda$  = the impact of soil and climate conditions factors (air-soil temperature, air humidity, wind, precipitation and solar brightness).
2. Let  $G$  be the germination function necessary to ensure the quality of the production. We can say that there is  $\lambda_t \neq 0$  so that  $G_t = \lambda_t G_0$ , with the mention that for identical  $\lambda_t$ , the direct effect of the impact on the two qualitative characteristics is different ( $G_t - G_0 = I_G \neq I_U = U_t - U_0$ ).

The factors with *average quantitative impact on the smart decision* are the mass of 1000 grains in grams and the average of the grains per spice.

1. the mass of 1000 grains in grams: all other varieties are recognized as having higher values of 42 g/thousand grains, excepting the Avenue variety whose standard classifies it below 40 g/thousand grains. All selected varieties have humidity below 14% that is considered standard. In the study, the germination capacity exceeds 94% for all analyzed varieties. The mentioned above laboratory tests, respectively the analysis of the mass of 1000 grains, the humidity and the germination capacity were completed with field analyzes, which consisted in determining the average of the wheat per square meter, the average of the grain in the wheat and the production of wheat/ha, per varieties and by type of cultivated sole.
2. Average grain in wheat: it exceeds 30 grains for all analyzed varieties.

Indicators with high impact on output through the smart decision prism: these are the production in kg/ha and the average of the ears/m<sup>2</sup>.

1. production in kg/ha: The evaluation of the wheat seed production at the already established control points is done as follows: all the ears within the metric frame are counted; the percentage of large ears, medium ears and small ears is established; the average number of grains/wheat is calculated. Based on the average number of ears/m<sup>2</sup> and the average number of grains/spice, and having the mass of 1000 grains (MMB), the average wheat production per hectare can be calculated, using the following formula:

$$(\text{kg/ha}) = N_{\text{sp}} \times N_{\text{b}} \times \text{MMB} / 100 \quad (1)$$

where:  $Q$  (kg/ha) = average production;  $N_{\text{sp}}$  = average number of ears per square meter;  $N_{\text{b}}$  = average number of grains in wheat.

2. the average of the ears/m<sup>2</sup>: it varies between 400–500 ears/m<sup>2</sup> for the Romanian varieties depending on the density at sowing and the used technology; the average of the ears grows, offering a higher density located between 450–600 ears/m<sup>2</sup> the French varieties.

The above quantitative and qualitative indicators were calculated based on the tests carried out in 4 agricultural holding companies: Tudor Vladimirescu, Gemenele, Ramnicelu and Movila Miresii from the Romanian South-East NUTS2 region.

The model proposed in this paper is based on the following hypotheses. Let be:

$$f_i(Q_R) = \beta(S_{iu} \cap S_{ig}) = \beta\left(\max_{i \rightarrow \infty}(\overline{U_{STD} - S_{iu}}) \cap \max_{i \rightarrow \infty}(\overline{G_{STD} - S_{ig}})\right) \quad (2)$$

where:  $f_i$ —the wheat quality score function with high impact (coefficient 1,  $\beta = 1$ ) based on the quantifying of the standard deviations from the humidity and germination technical specifications of the catalog;

$S_{iu}$ —humidity recorded on varieties under different soil and climate conditions (time and space);  $S_{ig}$ —germination recorded on varieties under different soil and climate conditions (time and space);  $U_{STD}$ —the standard humidity recognized as 14%;  $G_{STD}$ —the standard germination recognized as 94%. And let be:

$$f_i(k_M) = \frac{\alpha_M * S_{MMB_i} + \alpha_M * S_{MBS_i}}{\alpha_M \frac{\sum_{i=1}^n S_{MMB_i}}{\sum_{i=1}^n i} + \alpha_M \frac{\sum_{i=1}^n S_{MBS_i}}{\sum_{i=1}^n i}} \tag{3}$$

where:  $f_i$ —the score quantity function of the wheat assumed to have average impact (coefficient 0.3,  $\alpha_M = 0.3$ ) based on the quantification of the deviations from the average evolution in the field of the indicators with average impact;  $S_{MMB_i}$ —the mass of a thousand grains;  $MBS_i$ —average grain in wheat. More, let be:

$$f_i(k_R) = \frac{\alpha_R * S_{qk_i} + \alpha_R * S_{MSP_i}}{\alpha_R \frac{\sum_{i=1}^n S_{qk_i}}{\sum_{i=1}^n i} + \alpha_R \frac{\sum_{i=1}^n S_{MSP_i}}{\sum_{i=1}^n i}} \tag{4}$$

$f_i$ —the score quantity function of the wheat assumed to have high impact (coefficient 1,  $\alpha_R = 1$ ) based on the quantification of the deviations from the average evolution in the field of the indicators with average impact;

$S_{qk_i}$ —production function in tones/ha;  $S_{MSP_i}$ —average spikes/sqm;

$$(\exists) i \neq 0, \text{ such that } f_i(X) = \max_{i \rightarrow \infty} f(X), \text{ where } f_i(X) = f_i(Q_R) \cap \max_{i \rightarrow \infty} [f_i(K_M) * f_i(K_M)],$$

where:  $f_i(X)$ —the general productivity coefficient applied to wheat varieties cultivated under different soil and climate conditions, depending on the productive and qualitative yield (assuming the marketability coefficient).

$(\exists) p > 0$ , such that  $(\forall) f_i(X) = \max_{i \rightarrow \infty} f(X) \Rightarrow \Delta_{SMART} = p * q * f_i(X)$ , for  $p$  = price at the grain exchange in Constanta (Romania) [26,27].

Based on the collected information through the field and laboratory observational study across the 4 distinct agricultural holding companies and for the 8 wheat varieties during 2016–2018 (see the Appendix A), taking into account the defined above equations, we used the Gretel 2018a software (developed by Alin Cottrell and Riccardo Lucchetti, Wake Forest University) into this new model. We used the function of the least squares method for the wheat variety dependent variable and the regression variables the productive yield ( $I = \eta(Q)$ ), the qualitative productive yield  $I_1 = \eta(Q, U, G)$  and the economic efficiency support of the smart decision ( $I_2 = \eta(Q * P, U, G)$ ).

$$\hat{Soy} = -0.00238 * I_2 + 54.8 * I - 46.4 * I_1$$

(0.00200) (12.1) (11.5)

$$n = 64, R\text{-squared} = 0.841$$

(Standard errors in parentheses)

According to the regression equation, it is found that the proposed model has a statistical representativeness of 84% for a number of iterations equal to 64 and a standard error of the regression for variable  $I_2$  (economic yield) which tends to 0.

In order to prove the validity of the model, the statistical tests presented below were performed (see Table 3).

Breusch-Pagan test for heteroskedasticity

Null hypothesis: heteroskedasticity is not present

Statistical test: LM = 2.35191

with  $p$ -value =  $P(\text{Hi}^2(3) > 2.35191) = 0.50265$

According to the Q-Q plot for the dependent variable (Figure 4), it is found that the model has a good statistical representativeness.

**Table 3.** Model: OLS, using observations 1–64; Dependent variable: Soy.

	<i>Coefficient</i>	<i>Std. Error</i>	<i>t-Ratio</i>	<i>p-Value</i>
I <sub>2</sub>	−0.00237777	0.00199792	−1.190	0.2386
I	54.7829	12.1212	4.520	<0.0001
I <sub>1</sub>	−46.4400	11.5260	−4.029	0.0002
Mean dependent var		4.500000	S.D. dependent var	2.309401
The sum of the squares of the residuals		258.8672	Standard regression error	2.060030
Un centered R-squared		0.841380	Centered R-squared	0.229562
F(3, 61)		107.8560	p-value(F)	2.37 × 10 <sup>−24</sup>
Log-likelihood		−135.5299	Akaike criterion	277.0598
Schwarz criterion		283.5364	Hannan-Quinn criterion	279.6113

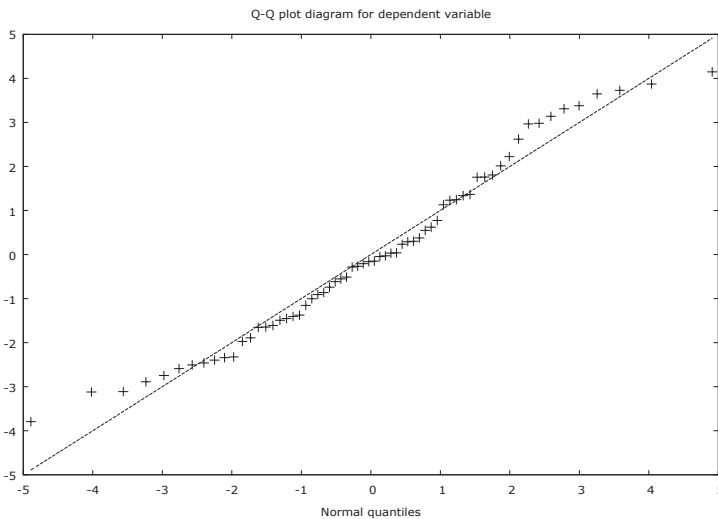

**Figure 4.** Q-Q plot diagram for the dependent variable.

The winding test around the trend line is valid, and the heterodesdaticity tested by the Breusch-Pagan test is absent for the proposed model. The *p*-value for the productive yield and qualitative productive yield regression variables is less than 0.01, which represents a strong dependence of the smart decision on the results of the two types of yield, with the mention that the productive yield is appreciated as more important by the manager than the yield productive quality, *p*-value being lower for the productive yield.

The forecasted distribution over the 95% confidence interval reveals an average error that extends via 0 (0.0098) and a regression bias that tends to 0 on the uncorrected variant of the standard error (Figure 5).

For the dependent variable, it is found that the preference over the forecast range is manifested for the 5–8 (French) varieties, with the exception of the Glosa variety, which shows the preference over the 30–50% ranges.

Forecast evaluation statistics

Average error	0.0098524
Root Mean Squared Error	2.0112
Absolute Mean Error	1.6426



Mean Percentage Error	-38.886
Mean Absolute Percentage Error	63.212
Theil's U	1.756
Bias proportion, UM	$2.3999 \times 10^{-5}$
Regression proportion, UR	0.00037398
Disturbance proportion, UD	0.9996

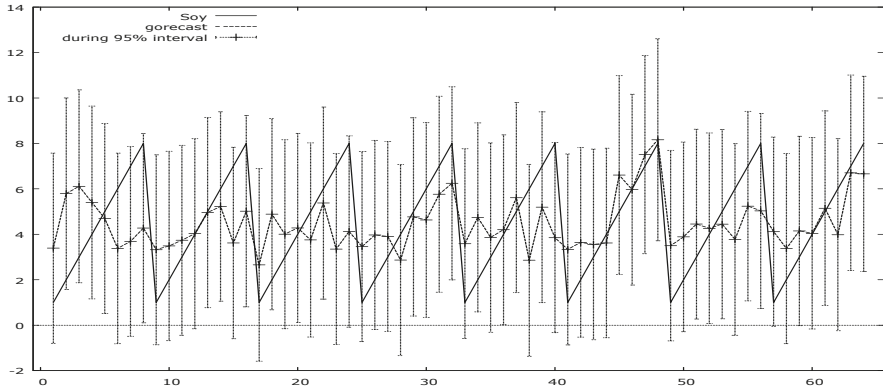

Figure 5. The forecasted distribution.

The application of the Gaussian rule for the evaluated sample, with a turning point on the maximum of the curve, at the beginning of the decreasing slope for a  $p$ -value less than 0.15 is noted (Figure 6).

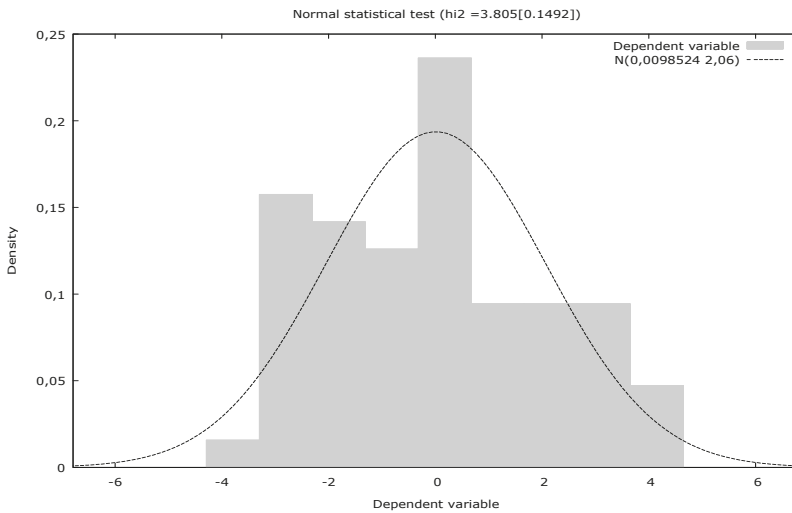

Figure 6. The Statistical test for normality.

Test for residual normality

The null hypothesis: the error is normally distributed

Statistical test:  $Hi^2(2) = 3.80462$

with  $p$ -value = 0.149223

The confidence ellipse for the qualitative productive yield compared to the economic yield reflects a Cartesian disturbance with respect to the level 0 of the intersection of the coordinate axes, determined by the point with the coordinates (0.002, -46.4) (see Figure 7).

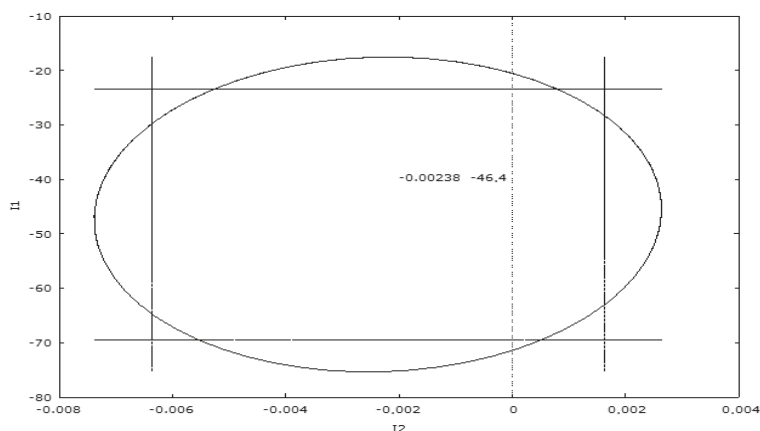

Figure 7. The Confidential ellipse.

This indicates a suboptimal value of the economic yield in relation to the productive yield, which motivates the managers to refine the markets in order to obtain the economic advantages on the quality gain obtained from the cultivation of the French varieties and the monitoring of the soil and climate conditions in order to ensure the optimum quality level. As a result, the distribution is suboptimal, the highly productive French varieties needing specific conditions to reach the maximum yield.

### 3. Results

The production technology of wheat seed lots and the results of laboratory analyzes concerned: number of ears/m<sup>2</sup>, number of grains/spike/, MMB (g), production kg/ha, moisture (%) and germination (%). Along the field research, during the wheat vegetation period, the observations were made on plant development, the degree of twinning, the number of ears/square meter, the number of grains in the ear for each variety, estimating the production.

Within the technology, the eight varieties were sown, with the SUP 29 seed drill in the second half of October. In these experiments, the precursor plant was corn for all varieties in the four areas Gemele, Tudor Vladimirescu, Rîmnicelu and Movila Miresii. The tillage was carried out immediately after the corn was harvested. Plowing was done with the plow in the aggregate with a star harrow at a depth of 18–22 cm, with the incorporation of plant debris and weeds.

Fertilization was performed uniformly with complex fertilizers containing nutrients, for plants N: P: K, (20-20-0) the most balanced ratio for wheat. The wheat seeds used for sowing belonged to the C1 Certified biological category, and were treated with the fungicide Celest Star 025FS, against pathogens that are transmitted through *Tilletia* sp. (malura), *Fusarium* sp. (fusariosis) and *Ustilago tritici* (embers). Special attention was paid to sowing the eight wheat genotypes Glosa, Litera, Izvor, FDL Miranda, Sorrial, Solveig, Apache, Avenue, in order to avoid mechanical contamination.

The weed control was carried out with the systemic herbicide Sekator Progress in a dose of 0.10 l/hectare, in the spring in post-emergence. Topsin 70 WDG (1kg/hectare) systemic fungicide with preventive and curative effect against and treating *Erysiphe graminis* (Wheat flour), *Puccinia* spp. (Wheat rust), *Fusarium* spp. (Fuzarioza), *Helminthori sativum* (Tearing of leaves) was treated against pathogens.

The systemic insecticide Mospilan 20SG s.a. was applied against the pests at a dose of 0.1 kg/hectare.

A very important work applied to seed lots is the biological purification, which involves responsibility and consists in removing all not typical plants of the variety from the seed culture, while maintaining the typicality of the variety. The wheat was harvested on varieties, with the Claas Tucano 320 combine, at a humidity of 14% and with great responsibility to avoid mechanical contamination.

The experimental methodology in the laboratory was complex. In the laboratory, each variety of wheat was researched, following the elements of productivity but also quality indices. The analyzes were performed on:

- mass of 1000 grains (MMB), which was determined using SR 6123-1/1999;
- production (kg);
- seed moisture expressed as a percentage (U%), which was determined using SR 6124-1/1999;
- filter germination (BP), expressed as a percentage (G%) determined using SR 1634/1999;
- germination of seeds in Lindhard pots, in a mixture (S) 1: 1 using soil from the four areas, expressed as a percentage (G%) which was determined using SR 1634/1999.

The results of the laboratory analyzes were processed and represented graphically.

The modeling of the obtained experimental data used the Anova analysis and the “t” Test, in which it was proposed to identify the existence of soil influences on some wheat varieties, in terms of number of ears/m<sup>2</sup>, number of grains/ear, mass of one thousand grains (MMB), germination (G%), humidity (U%) and production, by comparing the averages of several samples.

Statistical and graphical analyzes were performed based on the collected data, which highlighted the existence of differences regarding: number of ears/m<sup>2</sup>, number of grains/ear, mass of one thousand grains (MMB), germination (G%), humidity (U%) and production.

The performance projections were made based on the performed analyzes using the methodology of highlighting the dynamics of ears/m<sup>2</sup>, number of grains/ear, yields, mass of one thousand grains, humidity and germination in each period (2016–2018).

During 2016–2018, all wheat varieties were cultivated on 4 soils (Gemenele, Movila Miresii, Rimnicelu and Tudor Vladimirescu). The results of the qualitative and quantitative analysis are presented in Table 4.

From the ranking of the qualitative characteristics for the indicator of seed wheat moisture point of view can be build a specific diagram (see Figure 8).

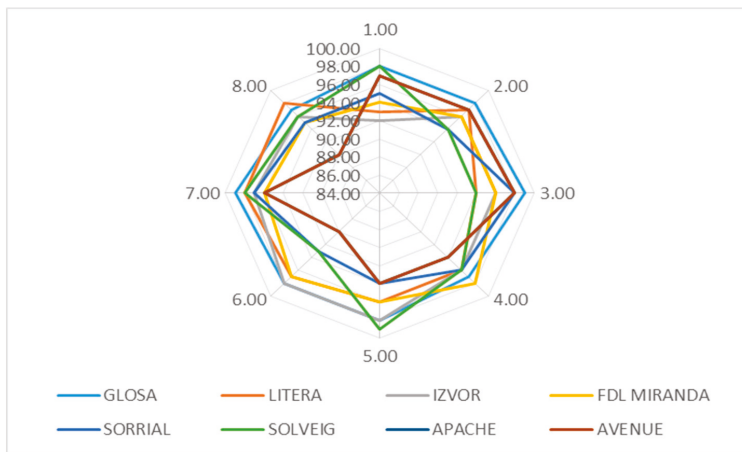

Figure 8. Diagram of the wheat grain’s humidity/moisture (%).

On the other hand, the seasonal variations influence the maximum production of the Wheat varieties. The disparities related to this indicator are presented in Table 5.

Table 4. Humidity variation.

Humidity (U%)/Year	Holding	Glosa	Litera	Izvor Miranda	FDL Miranda	Sorrial	Solveig	Apache	AVENUE	Average	Min	Max
2016–2017	Tudor Vladimi-rescu	12.90	13.00	12.7	14.00	13.00	13.20	12.80	12.80	13.05	FDL MIRANDA	IZVOR
2017–2018	Tudor Vladimi-rescu	13.00	12.40	11.7	13.00	11.80	12.60	12.40	12.40	12.41	GLOSA	IZVOR
2016–2017	Gemelele	12.40	12.80	12.7	13.00	13.40	13.80	12.80	12.80	12.90	SOLVEIG	IZVOR
2017–2018	Gemelele	12.20	12.20	12.00	12.00	13.20	13.00	12.80	12.80	12.53	SORRIAL	IZVOR
2016–2017	Rimnicelu	13.20	13.60	13.1	12.80	13.20	12.80	13.00	13.00	13.18	IZVOR	FDL MIRANDA
2017–2018	Rimnicelu	12.80	12.60	13.20	12.60	13.00	12.60	11.80	11.80	12.55	IZVOR	APACHE
2016–2017	Movila Miresii	13.80	13.60	14.1	12.80	13.40	13.80	13.80	13.80	13.63	IZVOR	FDL MIRANDA
2017–2018	Movila Miresii	13.20	12.80	12.60	12.00	13.00	12.80	12.20	12.20	12.60	GLOSA	FDL MIRANDA
Average		12.94	12.88	12.78	12.78	13.00	13.08	12.70	12.70	12.85		

Table 5. Productivity variation.

Productivity	Holding	GLOSA	LITERA	IZVOR	FDL MIRANDA	SORRIAL	SOLVEIG	APACHE	AVENUE	Average
2016–2017	Tudor Vladimirescu	108.64%	105.22%	103.60%	93.05%	97.93%	94.48%	98.54%	98.54%	100.00%
2017–2018	Tudor Vladimirescu	95.65%	92.98%	102.79%	82.18%	108.90%	102.57%	107.46%	107.46%	100.00%
2016–2017	Gemelele	98.58%	87.37%	99.48%	94.13%	118.09%	89.04%	106.66%	106.66%	100.00%
2017–2018	Gemelele	91.40%	92.62%	95.42%	85.31%	111.11%	106.65%	108.75%	108.75%	100.00%
2016–2017	Rimnicelu	104.20%	103.93%	103.06%	95.24%	106.61%	94.31%	96.33%	96.33%	100.00%
2017–2018	Rimnicelu	96.95%	87.83%	99.13%	85.82%	116.77%	97.59%	107.95%	107.95%	100.00%
2016–2017	Movila Miresii	102.62%	99.55%	92.30%	88.32%	108.33%	84.77%	112.06%	112.06%	100.00%
2017–2018	Movila Miresii	106.74%	99.64%	94.40%	83.28%	126.55%	79.74%	104.82%	104.82%	100.00%
Average		100.60%	96.14%	98.77%	88.42%	111.79%	93.64%	105.32%	105.32%	

Using the production indicator kg/ha, the dedicated diagram becomes (see Figure 9):

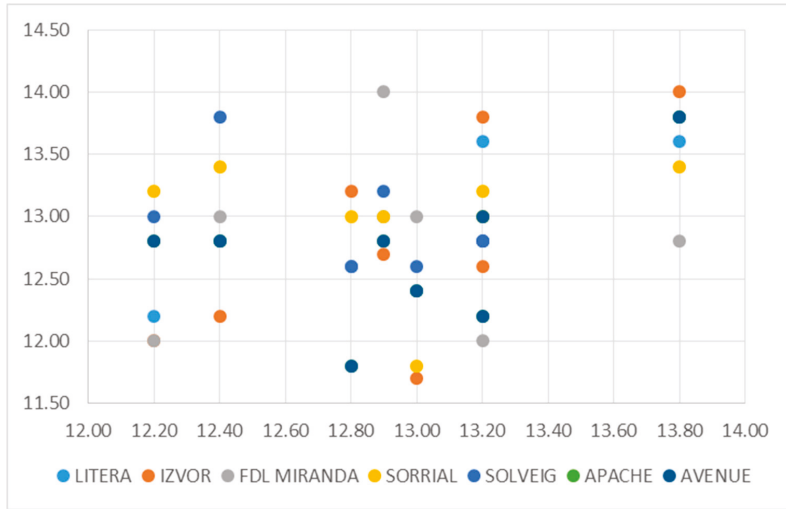

Figure 9. Productivity diagram (thousand kg per ha).

During the analyzed period 2016–2018, the total production related to the wheat varieties varied according to data in Table 6.

Using the productive classification for the production indicator (kg), the dedicated diagram will be (see Figure 10):

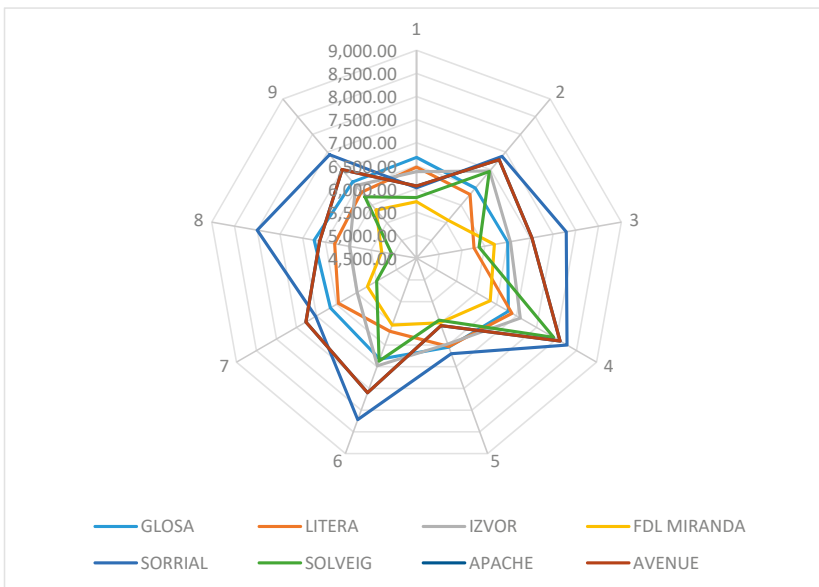

Figure 10. Production diagram (kg).

Table 6. Total production variation.

Production Kg/Year	Holding	GLOSA	LITERA	IZVQR	FDL MIRANDA	SORRIAL	SOLVEIG	APACHE	Average	Min	Max
2016–2017	Tudor Vladimirescu	6683.00	6473.00	6373.00	5724.00	6024.00	5812.00	6062.00	6151.63	FDL MIRANDA	GLOSA
2017–2018	Tudor Vladimirescu	6482.00	6301.00	6966.00	5569.00	7380.00	6951.00	7282.00	6776.63	FDL MIRANDA	SORRIAL
2016–2017	Gemenele	6505.00	5765.00	656	6211.00	7792.00	5875.00	7038.00	6598.50	LITERA	SORRIAL
2017–2018	Gemenele	6796.00	6887.00	709	6343.00	8262.00	7930.00	8086.00	7435.63	FDL MIRANDA	SORRIAL
2016–2017	Rimnicelu	6549.00	6532.00	647	5986.00	6700.00	5927.00	6054.00	6284.88	SOLVEIG	SORRIAL
2017–2018	Rimnicelu	6825.00	6183.00	697	6041.00	8220.00	6870.00	7599.00	7039.38	FDL MIRANDA	SORRIAL
2016–2017	Movila Miresii	6652.00	6453.00	5983.00	5725.00	7022.00	5495.00	7264.00	6482.25	SOLVEIG	APACHE
2017–2018	Movila Miresii	6749.00	6300.00	5969.00	5266.00	8002.00	5042.00	6628.00	6323.00	SOLVEIG	SORRIAL
Average		6655.13	6361.75	6550.63	5858.13	7425.25	6237.75	7001.63	6636.48		

The efficiency of the smart economic decision was tested on the marginal distribution of the maximum values calculated by the economic efficiency indicator  $I2 = \eta(Q * P, U, G)$  for each of the 8 analyzed varieties and is proved by the normal distribution test  $R^2 = 43\%$ . This is an asymmetric distribution of the Romanian varieties under the trend axis (type 2 polynomial):  $y = -5.6189x^2 + 114.35x + 986.05$  and of the French varieties above, with polarization at maximum point for the SORRIAL variety (see Figure 11).

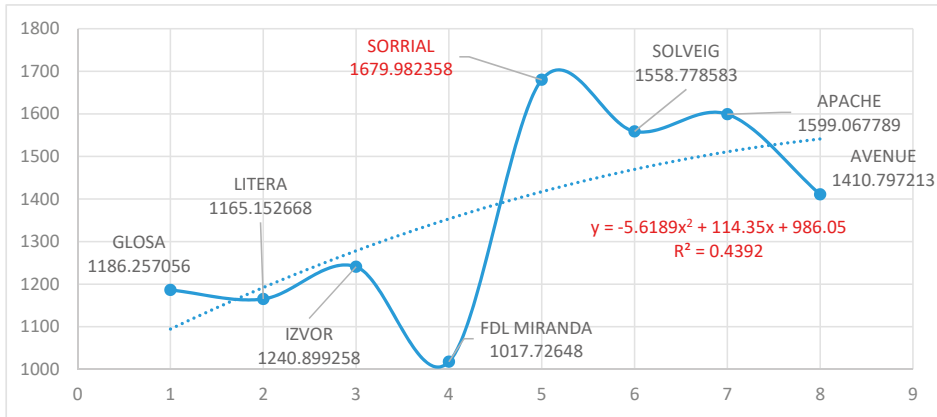

Figure 11. Economic efficiency diagram; Source: authors' contribution.

The standard deviation is 238.38, respectively 14% of the maximum value of the economic efficiency of the SORRIAL variety.

The above analysis supports the smart decision regarding the implementation of the economic sustainable model for wheat seed production not only in Romania.

#### 4. Discussion

The smart sustainable decision based on the above **presented algorithm** in the methodology chapter is based on all 3 main aspects: ensuring the market needs by optimizing the produced quantities; satisfying the demand by ensuring the quality of the delivered product; and maximizing the economic efficiency by obtaining the maximum possible economic efficiency under the competitive market's conditions.

The working hypotheses have shown that there is a direct dependence relation between the quantitative factor and the smart decision punctuated in the model by obtaining a minimum  $p$ -value quota (hypothesis H1), with the mention that the technical-productive baggage of the seed material represents the reference for obtaining a smart decisions. In this context, the satisfaction of the qualitative demand represents the basic component in the perpetual assurance of the demand, having a loyalty role, a role that the managers are obliged to take into consideration when building the smart decision.

The impact of soil and climate conditions indicators on the humidity and germination of the seed material is very high for the cereal productions. As a result, in some cases, there is a gap between the quantitative decision and the qualitative decision manifested by increasing the  $p$ -value amplitude and moving the decision point according to the soil and climate conditions and maximizing the yields from the Sorrial variety, cultivated on the 2nd class land with  $pH = 6.9$  neutral, to the Sorrial variety, cultivated on class AA land, with  $pH = 7.4$  weak alkaline but in more favorable soil and climate conditions (see the Appendix A). This gap demonstrates H2 and H3 hypotheses.

The aspects related to the production traceability reflect the fact that some indigenous varieties are tested for specific soil and climate conditions and are often easier to exploit than the imported

varieties that require monitoring of the soil and climate conditions and adjustments of the treatment during the storage period through specific storage maneuvers (H4).

The assisted economically smart decision moves the critical pole on the fruition of the competitive advantage and disseminates the managers' options for export to the markets where the price supports the quality of the product (H5).

Throughout the entire chain analyzed when this article was writing, it was found that ensuring the market demand represents the first objective of the managers in the sense of ensuring the production capacity and the adequate storage spaces, the subsequent decisions regarding the quality and the economic efficiency being assisted by specific operations. There are maneuvers performed during storage that maintain the quality of the product but increase costs. In order to ensure the economic efficiency, the Option and Future contracts are used on commodity exchanges to ensure the efficient distribution and sale of production (H6).

## 5. Conclusions

Following the analysis, there was a special interest expressed by the researchers and the business environment for obtaining a smart decision under sustainability conditions. Taking into consideration the analyzed process, namely the production process for cereals from indigenous and from imports varieties with high productive performances, we consider that the sustainable aspects target the entire production and the distribution chain because higher economic returns can be obtained by reusing cereal wastes (even that there are not quantified in the model) an aspect that complements optional smart decision based on a mix of productivity and economic efficiency.

The authors have developed a new model based on the principles of sustainable economy, which offers managers the option of a smart decision in variable socio-economic conditions, being all the more applicable as the current economic and social inflections generated by climate change and the global health crisis shows strong influence in the food sector and not only.

This study is necessary for the academic environment, because by economic modelling, the structure gives a smart decision model, starting from the already carried out in the domain research, which did not identify a similar model, but especially the business environment, which shows a real interest for optimizing managerial decisions in terms of productivity and economic efficiency on a sustainable basis.

The proposed model has no obvious limitations (other indicators can be added to this model, according to the economic reality). We believe this new indicators, especially economic ones, can be used in order to sustainably support the smart decision.

**Author Contributions:** Conceptualization, R.V.I., V.M.A., and S.S.; methodology, M.L.Z., R.V.I. and V.M.A.; software, F.O.V. and C.(B.)S.; validation, M.L.Z., V.M.A. and F.O.V. formal analysis, S.S.; investigation, F.O.V. and C.(B.)S.; resources, F.O.V. and C.(B.)S.; data curation M.L.Z.; writing—original draft preparation, M.L.Z. and R.V.I.; writing—review and editing, S.S.; visualization, V.M.A.; supervision, R.I.V.; project administration, S.S. All authors have read and agreed to the published version of the manuscript.

**Funding:** This work was supported by the project "Excellence, performance and competitiveness in the Research, Development and Innovation activities at "Dunarea de Jos" University of Galati", acronym "EXPERT", financed by the Romanian Ministry of Research and Innovation in the framework of Programme 1—Development of the national research and development system, Sub-programme 1.2—Institutional Performance—Projects for financing excellence in Research, Development and Innovation, Contract no. 14PFE/17.10.2018.

**Conflicts of Interest:** The authors declare no conflict of interest.



Appendix A

Year	Holding	Soil	PH	Soy	Nsp	Nb	Q	MMB	U	G	$\eta(Q)$	$\eta(Q,U,G)$	$\eta(Q^*P,U,G)$
2017	1	3	4	1	432	34	6683	45.5	12.9	98	1.00282683	1.053971	1091.77167
2017	1	3	4	2	424	34	6473	44.9	13	93	0.97229077	0.97229077	975.513912
2017	1	3	4	3	472	32	6373	42.2	12.7	92	0.96442481	0.95767384	946.004585
2017	1	3	4	4	430	32	5724	41.6	14	94	0.8669102	0.8669102	769.140065
2017	1	3	4	5	467	30	6024	43	13	95	0.91222687	0.93047141	868.799764
2017	1	3	4	6	410	32	5812	44.3	13.2	98	0.87345115	0.91537681	824.626349
2017	1	3	4	7	421	30	6062	48	12.8	97	0.90811416	0.94625496	889.110622
2017	1	3	4	8	456	34	6184	39.9	12	95	0.92843508	0.95628814	916.621304
2017	1	3	4	1	419	34	6482	45.5	13	98	0.96387719	1.01207105	1043.07888
2018	1	3	4	2	432	34	6301	42.9	12.4	97	0.93984301	0.98307579	984.903323
2018	1	3	4	3	489	34	6966	41.9	11.7	96	1.03916209	1.08384606	1200.46139
2018	1	3	4	4	470	30	5569	39.5	13	96	0.8428058	0.86808997	768.668493
2018	1	3	4	5	603	30	7380	40.8	11.8	94	1.10995887	1.13437797	1331.10179
2018	1	3	4	6	504	32	6951	43.1	12.6	94	1.03924064	1.05379001	1164.6582
2018	1	3	4	7	521	30	7282	46.6	12.4	97	1.0886145	1.13869077	1318.41945
2018	1	3	4	8	596	32	7590	39.8	11.8	94	1.14386507	1.1690301	1410.79721
2017	2	2	1	1	446	34	6505	42.9	12.4	99	0.97496033	1.03930771	1047.90799
2017	2	2	1	2	419	32	5765	43	12.8	94	0.86727108	0.87767833	784.271416
2017	2	2	1	3	477	32	6564	43	12.2	96	0.98427474	1.02167718	1039.47479
2017	2	2	1	4	461	32	6211	42.1	13	96	0.93257925	0.96055663	924.732667
2017	2	2	1	5	614	30	7792	42.3	13.4	98	1.17238209	1.22631167	1481.09018
2017	2	2	1	6	434	32	5875	42.3	13.8	94	0.88438046	0.88614922	806.949635
2017	2	2	1	7	460	34	7038	45	12.8	98	1.04788033	1.10237011	1202.56453
2017	2	2	1	8	408	32	5366	41.1	12.4	95	0.8084866	0.82950725	689.926065
2017	2	2	1	1	467	34	6796	42.8	12.2	97	1.01160332	1.06016027	1145.57103
2018	2	2	1	2	470	34	6887	43.1	12.2	96	1.02508121	1.0640343	1165.15267
2018	2	2	1	3	491	34	7095	42.5	12	96	1.05767846	1.0999856	1240.89926
2018	2	2	1	4	472	32	6343	42	12	98	0.95199216	1.00911169	1017.72648
2018	2	2	1	5	662	30	8262	41.6	13.2	96	1.24402553	1.27885824	1679.98236
2018	2	2	1	6	618	32	7930	40.1	13	96	1.20026431	1.23627224	1558.77858
2018	2	2	1	7	614	30	8086	43.9	12.8	94	1.22901024	1.24375836	1599.06779
2018	2	2	1	8	579	32	5758	40.9	11.8	92	1.1606627	1.16298403	1401.28178
2017	3	3	2	1	449	34	6549	42.9	13.2	98	1.00151488	1.0495876	1065.43112
2017	3	3	2	2	429	36	6532	42.3	13.6	96	0.99648335	1.02039895	1033.11312
2017	3	3	2	3	432	34	6477	44.1	13.8	98	0.98907924	1.03062057	1034.67606
2017	3	3	2	4	430	32	5986	43.5	12.8	96	0.91842317	0.879481272	879.409072
2017	3	3	2	5	477	32	6700	43.9	13.2	94	1.02416601	1.03235934	1072.10517
2017	3	3	2	6	444	30	5927	44.5	12.8	99	0.91041516	0.9668609	888.240606
2017	3	3	2	7	430	32	6054	44	13	94	0.9235459	0.93278136	875.294042
2017	3	3	2	8	513	34	7081	40.6	13.6	98	1.0779267	1.12535548	1235.13953
2017	3	3	2	1	469	34	6825	42.9	12.8	98	1.03911422	1.09314816	1186.25706
2018	3	3	2	2	434	34	6183	42.3	12.6	97	0.9447281	0.98629613	969.624771
2018	3	3	2	3	474	34	6978	44.1	13.2	98	1.06114653	1.11208156	1233.85672
2018	3	3	2	4	435	32	6041	43.5	12.6	97	0.92537896	0.96609563	927.953211
2018	3	3	2	5	654	30	8220	43.9	13	93	1.262339	1.262339	1649.85183
2018	3	3	2	6	580	30	6870	44.5	12.6	93	1.07539852	1.07970011	1179.38882
2018	3	3	2	7	551	32	7599	44	11.8	90	1.18144832	1.16018225	1401.77976
2018	3	3	2	8	526	34	7225	40.6	13.2	90	1.13613272	1.09977648	1263.39572
2017	4	3	3	1	419	36	6652	44.1	13.8	99	1.04615986	1.10056017	1134.74357
2017	4	3	3	2	413	36	6453	43.4	13.6	98	1.0193479	1.0641992	1064.42801
2017	4	3	3	3	415	34	5983	42.4	14	97	0.95159482	0.98014266	908.949997
2017	4	3	3	4	425	32	5725	42.1	12.8	96	0.91165235	0.94082522	834.86478
2017	4	3	3	5	560	30	7022	41.8	13.4	97	1.11525377	1.15540291	1257.55208
2017	4	3	3	6	430	30	5495	42.6	13.8	98	0.88183105	0.91886795	782.622808
2017	4	3	3	7	509	32	7264	44.6	13.8	96	1.14304188	1.1681888	1315.28714
2017	4	3	3	8	384	32	4927	40.1	12.6	93	0.79490515	0.79808477	609.485364
2017	4	3	3	1	435	36	6749	43.1	13.2	97	1.0480941	1.08792167	1167.43896
2018	4	3	3	2	407	36	6300	43	12.8	98	0.98612123	1.03739953	1039.16311
2018	4	3	3	3	417	34	5969	42.1	12.6	96	0.93748427	0.96935874	919.990269
2018	4	3	3	4	422	30	5266	41.6	12	95	0.82557282	0.85034001	711.984584
2018	4	3	3	5	552	32	8002	45.3	13	95	1.18961176	1.21340399	1543.83574
2018	4	3	3	6	435	28	5042	41.4	12.8	96	0.81524067	0.84132837	674.474442
2018	4	3	3	7	484	32	6628	42.8	12.2	90	0.97036846	0.94902035	1000.12699
2018	4	3	3	8	513	34	6977	40	12	90	0.99628657	0.97636084	1083.11906

Where: PH—soil acidity scale; Nsp—average number of ears per square meter; Nb—average number of grains in wheat; Q—production; MMB, U—moisture function; G—germination function;  $\eta(Q)$ —the productive yield;  $\eta(Q,U,G)$ —the qualitative productive yield;  $\eta(Q*P,U,G)$ —the economic efficiency.

## References

1. European Parliament. European Parliament resolution on our life insurance, our natural capital: An EU biodiversity strategy to 2020 (2011/2307(INI)). *Publ. Off. EU* **2011**, *2020*, 17.
2. Cosmulese, C.G.; Ciubotariu, M. An Overall Analysis on the Implementation of European Funds in Romania. In Proceedings of the International Business Information Management Conference 30th IBIMA, Madrid, Spain, 8–9 November 2017; pp. 5732–5742.
3. DG Agriculture and Rural Development. “Eurostat,” *Comext Data*. 2020. Available online: [https://ec.europa.eu/info/food-farming-fisheries/farming/facts-and-figures/markets/overviews/market-observatories/crops/cereals-statistics\\_en](https://ec.europa.eu/info/food-farming-fisheries/farming/facts-and-figures/markets/overviews/market-observatories/crops/cereals-statistics_en) (accessed on 19 May 2020).
4. Eurostat. Economic Accounts for Agriculture (Values at Current Producer Prices). 2019. Available online: [https://appsso.eurostat.ec.europa.eu/nui/show.do?dataset=aact\\_eaa01&lang=en](https://appsso.eurostat.ec.europa.eu/nui/show.do?dataset=aact_eaa01&lang=en) (accessed on 9 March 2020).
5. Bostan, I.; Mates, D.; Grosu, V.; Socoliuc, M. Implications Of Fiscality Over Accounting In Agriculture. *Bull. Univ. Agric. Sci. Vet. Med. Cluj-Napoca Hortic.* **2008**, *65*, 53–58.
6. Cosmulese, C.G. A literature review of articles assessing the extent of compliance with IAS 41. *Eur. J. Account. Financ. Bus.* **2019**, *20*. Available online: <http://accounting-management.ro/index.php?page=showcontent&issue=20&year=2019> (accessed on 19 May 2020).
7. United Nations. Transforming our world: The 2030 Agenda for Sustainable Development. United nations general assembly, A/70/L.1. 2015. Available online: [https://www.un.org/ga/search/view\\_doc.asp?symbol=A/RES/70/1&Lang=E](https://www.un.org/ga/search/view_doc.asp?symbol=A/RES/70/1&Lang=E) (accessed on 21 October 2015).
8. Guerry, A.D.; Polasky, S.; Lubchenco, J.; Chaplin-Kramer, R.; Daily, G.C.; Griffin, R.; Ruckelshaus, M.; Bateman, I.J.; Duraipapp, A.; Elmquist, T.; et al. Natural capital and ecosystem services informing decisions: From promise to practice. *Proc. Natl. Acad. Sci. USA* **2015**, *112*, 7348–7355. [[CrossRef](#)] [[PubMed](#)]
9. Dace, E.; Muizniece, I.; Blumberga, A.; Kaczala, F. Searching for solutions to mitigate greenhouse gas emissions by agricultural policy decisions—Application of system dynamics modeling for the case of Latvia. *Sci. Total Environ.* **2015**, *527–528*, 80–90. [[CrossRef](#)] [[PubMed](#)]
10. Wolfert, S.; Ge, L.; Verdouw, C.; Bogaardt, M.-J. Big Data in Smart Farming—A review. *Agric. Syst.* **2017**, *153*, 69–80. [[CrossRef](#)]
11. Ďurišová, M.; Tokarčíková, E.; Virlanuta, F.O.; Chodasová, Z. The Corporate Performance Measurement and Its Importance for the Pricing in a Transport Enterprise. *Sustainability* **2019**, *11*, 6164. [[CrossRef](#)]
12. Aiello, G.; Giovino, I.; Vallone, M.; Catania, P.; Argento, A. A decision support system based on multisensor data fusion for sustainable greenhouse management. *J. Clean. Prod.* **2018**, *172*, 4057–4065. [[CrossRef](#)]
13. Florea, A.-M.; Bercu, F.; Radu, R.I.; Stanciu, S. A Fuzzy Set Qualitative Comparative Analysis (fsQCA) of the Agricultural Cooperatives from South East Region of Romania. *Sustainability* **2019**, *11*, 5927. [[CrossRef](#)]
14. Antle, J.M.; Basso, B.; Conant, R.T.; Godfray, H.C.J.; Jones, J.W.; Herrero, M.; Howitt, R.E.; Keating, B.A.; Munoz-Carpena, R.; Rosenzweig, C.; et al. Towards a new generation of agricultural system data, models and knowledge products: Design and improvement. *Agric. Syst.* **2017**, *155*, 255–268. [[CrossRef](#)] [[PubMed](#)]
15. Yan, B.; Shi, S.; Ye, B.; Zhou, X.; Shi, P. Sustainable development of the fresh agricultural products supply chain through the application of RFID technology. *Inf. Technol. Manag.* **2015**, *16*, 67–78. [[CrossRef](#)]
16. Speelman, E.N.; García-Barrios, L.E.; Groot, J.C.J.; Tittone, P. Gaming for smallholder participation in the design of more sustainable agricultural landscapes. *Agric. Syst.* **2014**, *126*, 62–75. [[CrossRef](#)]
17. Triste, L.; Marchand, F.; Debruyne, L.; Meul, M.; Lauwers, L. Reflection on the development process of a sustainability assessment tool: Learning from a Flemish case. *Ecol. Soc.* **2014**, *19*, 47. [[CrossRef](#)]
18. Cosmulese, C.G.; Socoliuc, M.; Ciubotariu, M.S.; Mihaila, S.; Grosu, V. An empirical analysis of stakeholders’ expectations and integrated reporting quality. *Econ. Res. Ekon. Istraživanja* **2019**, *32*, 3963–3986. [[CrossRef](#)]
19. Gocsik, E.; Saatkamp, H.W.; De Lauwere, C.C.; Lansink, A.O. A Conceptual Approach for a Quantitative Economic Analysis of Farmers’ Decision-Making Regarding Animal Welfare. *J. Agric. Environ. Ethics* **2014**, *27*, 287–308. [[CrossRef](#)]

20. Sivertsson, O.; Tell, J. Barriers to business model innovation in Swedish agriculture. *Sustainability* **2015**, *7*, 1957–1969. [CrossRef]
21. Mateş, D.; Grosu, V. Evaluating and recognising biological assets and agricultural activities according to IAS 41. *Lucr. Stiintifice Seria Agron.* **2008**, *51*, 457–462.
22. Ďurišová, M.; Tokarčíková, E.; Kucharčíková, A. The Decomposition of the Result of the Business Transformation Process in the Value Terms. *Procedia Econ. Financ.* **2015**, *30*, 213–225, ISSN 2212-5671. [CrossRef]
23. Tadeu, P.; Paiva, T. Gamentship—An Innovative Project to Improve Entrepreneurship Competences. *Procedia Soc. Behav. Sci.* **2015**, *174*, 1829–1833, ISSN 1877-0428. [CrossRef]
24. BASF. BASF Agricultural Solutions România. In *Cultura Grâului—Când Semănăm Grâul, Tehnologiile, Tratamente și Îngrășăminte*; Available online: <https://www.agro.basf.ro/ro/stiri/fermier-in-romania/cultura-grauluicand-semanam-graul-tratamente-ingrasaminte.html> (accessed on 27 April 2017).
25. Cotidianul Agricol. Consumatorii și fermierii europeni doresc o producție de alimente mai sustenabi. In *Cotidianul Agricol*; 2019; Available online: <https://www.cotidianulagricol.ro/consumatorii-si-fermierii-europeni-doresc-o-productie-de-alimente-mai-sustenabila/> (accessed on 6 September 2019).
26. Elefterie, A. PREȚ GRĂU 2017. Ce oferte primesc fermierii și ce indică BURSELE! In *Agrointeligenta*; Available online: <https://agrointel.ro/85448/pret-grau-2017-ce-oferte-primesc-fermierii-si-ce-indica-bursele/> (accessed on 11 September 2017).
27. Agrointeligenta.ro. BURSA CEREALELOR 2018: Prețul grâului ÎN PORTUL CONSTANȚA, similar cu cel din Franța! Informațiile publicate de Agrointeligenta—AGROINTEL.RO pot fi preluate doar în limita a 500 de caractere și cu citarea în PRIMUL PARAGRAF a sursei cu LINK ACTIV. Orice. In *Agrointeligenta*; Available online: <https://agrointel.ro/99437/bursa-cerealelor-2018-pretul-graului-in-portul-constanta/> (accessed on 22 June 2018).



© 2020 by the authors. Licensee MDPI, Basel, Switzerland. This article is an open access article distributed under the terms and conditions of the Creative Commons Attribution (CC BY) license (<http://creativecommons.org/licenses/by/4.0/>).



Article

# Trust as a Key Factor in Shaping the Social Business Model of Water Supply Companies

Adam Jabłoński <sup>1,\*</sup> and Marek Jabłoński <sup>2</sup>

<sup>1</sup> Scientific Institute of Management, Faculty in Chorzów, WSB University in Poznań, Sportowa 29, 41-506 Chorzów, Poland

<sup>2</sup> Scientific Institute of Entrepreneurship and Innovation, Faculty in Chorzów, WSB University in Poznań, Sportowa 29, 41-506 Chorzów, Poland; marek.jablonski@ottima-plus.com.pl

\* Correspondence: adam.jablonski@ottima-plus.com.pl

Received: 23 August 2019; Accepted: 16 October 2019; Published: 18 October 2019

**Abstract:** The current principles of doing business differ radically from those that were applied a few years ago. Global economic crises have shown that business must have a more social character. This gave rise to the creation of management solutions that would guarantee the satisfaction of a wide range of corporate stakeholders. In this context, ideas based on social potential began to emerge. As a consequence, the concept of social business models was born, accompanied by an attempt to search for the best business models possible in order to build the appropriate configuration of their components. According to the authors, an attribute of trust may be such a component based on which effective social business models can be built. As water supply companies are social enterprises, they have become the object of scientific research in this case. The purpose of the article is to determine the position of trust in the construction and application of social business models of water supply companies. The scope of the article includes scientific research into water supply companies in the most industrial region of Poland, Upper Silesia, with the most extensive and dense water supply network in the country. In this article, the AHP (analytic hierarchy process) method was used to conduct research. The aim of the analysis was focusing on the issue of trust as a key factor in shaping the social business model of the company. In the questionnaires, respondents were asked to answer questions on the following issues: trust-based organizational behavior at the company; trust-based social capital at the company; trust-based relationships at the company; trust-based processes and activities at the company; trust-based risk at the company; and the trust-based business model at the company. The adopted logic of the scientific argument conducted indicates that trust and its place and role in the social business model of a water supply company have a significant impact on the social and economic performance of the water supply company, and as a consequence, on increased social responsibility towards stakeholders as well. Trust even stabilizes the organization and its business model; it is also a value catalyst and neutralizes the potentially negative impact of the organization on other entities gathered around it. Trust as a stabilizer can also affect the consistency and scalability of the social business model of a water supply company.

**Keywords:** trust; social aspects; business model; water supply industry

---

## 1. Introduction

Today's mechanisms of modern business are diametrically different than those of a few years ago. In modern management, so-called soft success factors have begun to play a special role. This approach was triggered by many aspects related to the change of approach to the economy, where on the one hand, social expectations began to be appreciated, and on the other hand, digital transformation started to dominate, which led to new perspectives for the development of modern companies. Companies wishing to achieve high performance had to open themselves up to being a

multidimensional cooperation. The principles of doing business such as total competition ceased to be the only determinants of organizational success. A strong need to build mutual relationships emerged so that transactions in which a wide range of stakeholders were the recipients could be concluded. Therefore, such business attributes that would make mutual business relationships credible and that would give value to various types of business actors were sought. As a consequence of such strategic thinking, the use of trust in business emerged. The concept of trust gained importance especially in sectors that were purely focused on relational links, of which the water supply industry is undoubtedly one such sector. Companies that create it, especially those that supply water to the inhabitants of cities and municipalities, are so-called hybrid companies, which simultaneously pursue economic and social goals. In order to be able to achieve them, water supply companies began to build social business models whose key objective is to achieve economic goals while fulfilling the social expectations of their main stakeholders. Thus, the social business model became a tool for generating value for stakeholders, a platform for logical, socially and economically justified business, and a conversion of payments into sustainable profits. From such a cognitive perspective of understanding this business, an important scientific problem has arisen to be solved; namely, what attribute or component of the social business model is most significant in terms of the achievement of high performance by water supply companies? Therefore, the authors decided to investigate whether trust is such a component of the social business model of water supply companies. As a result, the following question was asked: what is the place and role of trust in the conceptualization and operationalization of the social business models of water supply companies?

In view of the above, a significant scientific gap emerges, insofar as there is no extensive scientific research related to defining trust as an important component of the social business model of water supply companies. This applies above all to building a business model in terms of its configuration, where trust is one of its components. Interfaces between trust and other components of the social business model are also becoming crucial. The defined scientific gap also refers to determining the impact of trust embedded in the business model on the high performance of water supply companies.

In this case, the authors understand high performance as results achieved in both economic and social terms in accordance with the principles of responsibility and accountability. The social business model is understood as a specific combination of components that fill its canvas, which ensures the impact of the business model on social and economic aspects. Such a model is capable of monetizing and creating social values for key actors enjoying various benefits of this business model. From this perspective, a significant scientific problem needing to be solved emerges from the scientific gap; namely, determining the importance and hierarchy of trust in the social business model of water supply companies.

According to this interpretation, trust can be understood through the prism of different requirements for business and the economy. Trust can be used as a factor in organizational behavior; it can also be used to build social capital and mutual relationships between stakeholders. It can also be implemented as an element of processes, a risk-limiting factor and as a component of a business model.

The purpose of the article is to determine the position of trust in the construction and application of the social business models of water supply companies. The scope of the article includes scientific research into water supply companies in the most industrial region of Poland, Upper Silesia, with the most extensive and dense water supply network in the country.

## **2. Trust as an Important Attribute in Management: The Critical Literature Review**

The principles of today's strategic management of companies are changing dynamically in the eyes of many contemporary managers. Hard key success factors have become insufficient for the holistic, comprehensive system of making business decisions under the conditions of strong community pressure, their ever-increasing expectations in relation to the new business dimension, market pressures and risks. Hence, the questions arose of what attribute of import in the economy and business can be strengthened by a message the market of generating new value propositions, and how one is to build

mutual inter-organizational and interpersonal relationships in the sphere of modern management. It seems that trust can be an attribute that links many important areas of management. In attempting to review the scientific literature on trust, attention should be paid to the unambiguous definition of this concept, which can be viewed from many different economic, social, sociological, philosophical and other perspectives. It is also related to the fact that after entering the word “trust” in the Google search engine, there are as many as 1,870,000,000 results, which indicates the multidimensional use of this word in many areas of life and other spheres of existence [1]. The occurrence of “trust” keywords was analyzed by means of two huge databases provided by the Scopus and ProQuest portals. Scopus is a database of abstracts and citations from peer-reviewed publications, such as journals, scholarly books and conference proceedings. The analysis of the data available on the portal enables a comprehensive review of the global results of scientific research in the fields of exact sciences, technology, medicine, social sciences, art and the humanities. However, ProQuest’s extensive resources and tools support research and learning, publishing and dissemination, as well as the purchasing, management and discovery of library collections. At the beginning, the word “trust” was examined using a data set in the ProQuest database. The database contains the following peer-reviewed sources:

- Scholarly journals;
- Conference articles and materials;
- Journals;
- Trade journals;
- Scholarly works.

The rationale for choosing these two databases as the basis for keyword analysis was the fact that they are two of the largest scientific databases in the world. Scopus is the largest database of abstracts and citations from peer-reviewed publications: journals, scholarly books and post-conference proceedings. It provides a comprehensive overview of global research results in the fields of exact sciences, technology, medicine, social sciences, arts and humanities; it also offers intelligent tools for tracking, analyzing and visualizing research results [2]. ProQuest is involved in supporting researchers and librarians around the world. The company’s asset portfolio—including content, technology and thorough specialist knowledge—ensures better research results for users and greater efficiency for libraries and organizations that serve them [3]. In the opinion of the authors, they are representative for determining key issues and their development against the background of the concept of management sciences.

When analyzing bibliometrically collected results from 2010 to 2017, we found a cyclical increase in results that include the term “trust” (Figure 1). It was only in 2018 that the occurrence of the concept decreased (21,923 results).

Scopus also reported the increased occurrence of the term “trust” over the years. In 2010, it was used 8187 times, increasing in subsequent years to 13,692 in 2018. The data analysis took into account all the existing scientific fields and types of documents appearing in the database (articles, conference papers, reviews, chapters, notes, conference reviews, editions, books, surveys, letters, reports, etc.).

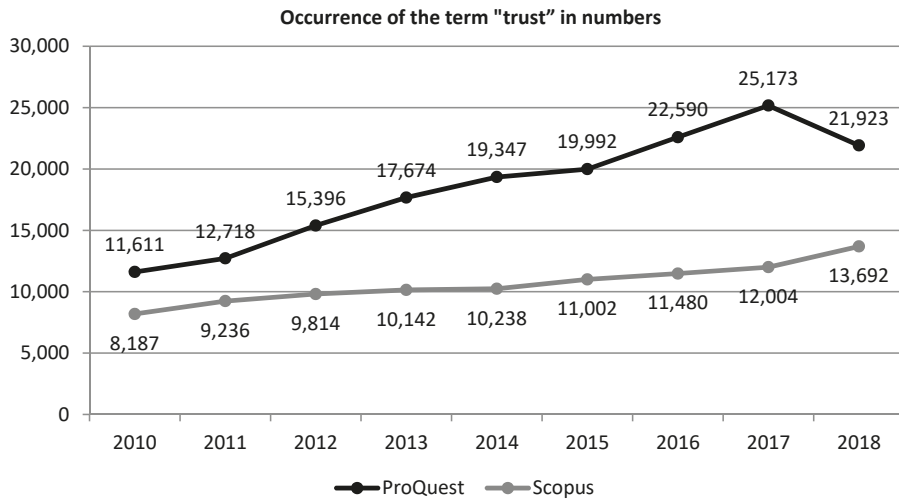

**Figure 1.** Number of occurrences of the word “trust” in the ProQuest and Scopus databases. Source: own study based on [4,5].

A critical review of the literature was used as a research method. The critical review of the literature should be treated as a synthetic, objective and reliable summary of a specific theoretical area [6]. The process of a critical review of the literature consists of: (1) the identification of published and unpublished papers on the subject of interest to the researcher (the process of collecting literature); (2) the evaluation of separate works in terms of the problems raised therein and the solutions; and (3) the documentation of the actions undertaken (research report) [7–9]. Such logic allows not only for the proper selection of the literature, but above all it reduces the risk of errors related to the correct inference resulting from the results of scientific research. This solution was adopted for the critical review of the literature in the field of trust.

It is important to note that trust can be viewed from many perspectives. However, there are various perspectives of the concept of trust in terms of the strategic business model component, which is particularly highlighted by the authors. Such consideration of trust gives it special significance in the context of creating social and economic values which affect the overall high performance of the organization.

Trust can be understood as a mechanism of social solidarity in post-industrial and network societies, based on monitoring the integrity of the other person in an open and continuous manner [10], among others. Trust can also be seen as a kind of calculation [11]. It is also defined as an “informal norm” that reduces the costs of economic transactions that supervise the conclusion of contracts, the settlement of disputes and the enforcement of formal agreements [12]. Trust is used to reduce conflicts and risk in transactions, strengthen satisfaction and increase partner involvement in exchange [13]. It is said that, in social sciences, trust is an infinite process [14]. Trust absorbs uncertainty and complexity, which are inherent in business and social relationships [15]. Trust is important in order to understand the world, the functioning of entities, decision-making processes and social relationships [16]. The positive opinions of other people are conducive to building trust [17]. Paliszkievicz sees trust as the belief that another party: (a) will not act in a way that is harmful to the trusting firm, (b) will act in such a way that is beneficial to the trusting firm, (c) will act reliably and (d) will behave or respond in a predictable and mutually acceptable manner. Trust can be seen as a bridge between past experiences and the anticipated future [18]. Trust is not static; it is a dynamic process that evolves according to the development of the relationship [19].

Knowledge-based trust relies on information rather than deterrence [20]. Trust alters the perceived risks of opportunistic behavior and the choice of a preferred governance structure, leading to a marginal,



substitutive effect of trust versus formal governance ex ante to the formation of an alliance [21]. Trust is the degree to which a person is willing to attribute good intentions to others and believe in the words and actions of other people [22]. Trust is also a mutual conviction that none of the parties will take advantage of the weaknesses of the other party [23]. Nowadays, trust is treated as a social aspect of a relationship that can be actively shaped by various entities [24]. According to F. Fukuyama, trust is a mechanism based on the assumption that other members of a given community are characterized by “honesty and cooperative behavior based on commonly shared norms” [25]. Trust is used to determine personality traits and beliefs, as well as in relation to social structures and behaviors [26]. Baier believes that “trust is reliance on others’ competence and willingness to look after, rather than harm, things one cares about which are entrusted to their care” [27]. Trust is a hybrid phenomenon that is somewhere between calculation, predictability, good will and voluntary exposure to risk that the trusting party may fail [28]. Trust can be regarded as an organizational principle; i.e., a way of solving the problem of interdependence and uncertainty, a kind of heuristic that allows for the interpretation and representation of information and a criterion for choosing appropriate behaviors and routines in coordinated activities [29]. Trust is the foundation of social interactions; it is a valuable resource in organizational and interpersonal relationships [30]. Trust is often a specific expectation. We want someone else to be an opportunist in words, deeds and decisions [31]. Trust is also “an attitude based on the past, but extending to the future” [32]. To trust means to believe and expect that a partner of a relation will act in support of the common interest [33]. Institutional trust concerns general organization and company management. It includes factors such as technologies, procedures, systems, resolutions, key goals and vision, competences, policy and justice [34]. Trust can be vertical or horizontal. Vertical trust refers to the relationship between the superior and the subordinate, characterized by asymmetry and dependence in terms of promotion, increased salary or work safety [35]. Horizontal trust is the belief that employees’ actions can be relied on [36].

To sum up the review of the concept of trust, it is important to pay attention to the multidimensional understanding of trust in management sciences and beyond. In this approach, the authors consider trust a key attribute of the social business model, and even state that it is a trust-based social business model. In this interpretation, trust is a component of the business model and is also its key attribute. Trust also interacts with other components of the social business model in many ways. Thus, trust is defined here as a component of the business model that enables and facilitates the construction of a social dialogue platform for determining the impact of the business model on achieving high social and economic performance. For this reason, an examination of trust and its significance in the configuration of the business model was undertaken.

In this context, an important element which justifies the adoption of such logic is a list of definitions of trust with reference to the attributes highlighted in its definitions, which ensure the possibility of determining the structure of scientific research. Table 1 (below) was a substantive platform for constructing the research model in this article.

**Table 1.** Presentation of selected definitions of trust in relation to its individual attributes.

No.	Author	Definition of Trust	Attribute
1.	Simmel, 1975 [37]	Trust falls between the knowledge and the ignorance of man. Thus, it is a hypothesis about his behavior.	Behavior
2.	Hardin, 1988 [38]	<ul style="list-style-type: none"> <li>- Trust consists of three elements:</li> <li>- a person who trusts,</li> <li>- a person who is trusted,</li> <li>- the relationship between these people, that is, A trusts B to do X.</li> </ul> Trust is a relational phenomenon, that is, it always refers to the relationship between specific entities. Trust is an alternative to credibility which, ensured by various social solutions, institutions or standards, allows one to take actions based on confidence rather than trust.	Relationships, Credibility

Table 1. Cont.

No.	Author	Definition of Trust	Attribute
3.	Putnam, 1995 [39]	Trust is an element of social capital that “refers to features of a social organization such as trust, norms and networks that can improve the efficiency of society by facilitating coordinated actions.”	Social capital
4.	Lewicki and Bunker, 1996 [20]	Trust is based on the calculation of costs and benefits, i.e., one of the parties will not pursue its own interest at the expense of the partner.	Benefit
5.	Fukuyama, 1997 [25]	Trust depends on the recognition of norms and values commonly shared by the group, as well as the sacrifice or postponement of satisfying your needs for the benefit of the group.	Sacrifice
6.	Inglehart, 1997 [40]; 1999 [12]	Social trust is examined in three dimensions: - vertical—public (in relation to various types of institutions)—it is rational, and changes quickly and in a predictable way as a result of new experiences - horizontal, private, - horizontal, generalized. Social trust, which is determined by expectations and feelings of a moral nature, is more difficult to achieve, because cultural changes are much slower.	Experiences
7.	Williams, 2000 [41]	Distributed trust occurs between people who are separated by relatively large social distance. Interpersonal trust occurs between specific individuals.	Relationships
8.	Putnam, 2000 [42]	General (generalized) trust is a second level of social capital, so-called bridging trust. It exists in external networks comprising people from different groups. Generalized trust is one of the dimensions of the so-called social trust, which is the basis of institutional trust.	Open group
9.	Szreter and Woolcoc, 2004 [43]	The first level of trust binding social capital presents strong social networks, connects people who already know each other and have personal (private) trust. They can be combined into closed groups, excluding other individuals.	Closed group
10.	Giddens, 2009 [44]	Passive trust is “based on the acceptance of symbols of power established by custom or tradition.” Active trust, which is a mechanism of social solidarity in post-industrial and network societies, is “based on monitoring the honesty of the other person in an open and continuous manner.”	Symbol, Honesty
11.	Botsman and Rogers, 2010 [45]	Trust which is present in the sharing economy is a specific counterpart to money in transactions within the sharing economy, because failure to perform the contract results in a loss of trust, which in turn will limit or even eliminate the possibility of participating.	Equivalent of money
12.	Tanz, 2014 [46]; Grabner-Kräuter and Kaluscha, 2008 [47]	Trust in the sharing economy is characterized by the following: - lack of interpersonal contacts at the initial stage, i.e., making decisions on sharing, - direct interactions do not accompany transactions, - indirect relationships play an important role in the virtual community, - includes actual participation.	Relationships
13.	Rifkin, 2016 [48]	Trust is a key feature of the sharing economy (...). The sharing economy functions more on social trust rather than anonymous market forces	Sharing
14.	Kamal and Chen, 2016 [17]	Trust in the sharing economy carries the risk of financial losses (e.g., in e-commerce transactions), but also the risk of physical harm or risk to one’s life. Trust in relation to users on internet platforms is built on the basis of opinions of other users, each additional piece of information and a complete profile of a given person.	Risk, Relationships
15.	Mazzella and Sundararajan, 2016 [49]	Trust (and credibility) built among Internet platform users includes a combination of several elements that make up the D. R. E. A. M. S. framework: - declaring personal information (name, surname or photo) in the profile (Declared); - rating and opinions of other users (Rated); - financial commitment ahead of the completion of the service (Engaged); - recording the level of user activity on the platform (Active); - content verification and limiting public change (Moderated) - connecting the profile with other accounts on social networks, e.g., Facebook, LinkedIn (Social).	Credibility

Source: own study.

When making a broad summary of the definitions presented, it is primarily important to look at them in a holistic manner, which ensures the development of one’s own cognitive thoughts, in turn creating descriptive factors that will also allow for the determination of the principles of scientific research into this issue. In addition, the scientific analysis of the content in these definitions should enable accurate scientific conclusions which synthesize this issue in strategic, tactical and operational terms. Therefore, the authors define trust as a key attribute of the social business model considered in two dimensions:

1. In terms of the object: as a factor which determines the structure of the social business model, which enables a configuration that ensures high performance in both social and economic terms.
2. In terms of the subject: as a platform for communication and mutual dialogue between organizational stakeholders

The scope of trust, therefore, includes these two dimensions, which should be considered and used simultaneously.

The critical review of the selected definitions of the concept of trust unambiguously shows that this concept is understood and interpreted in many ways. This definitely hinders the scientific processes of reasoning. However, some generalizations can be made by classifying key words describing the issue of trust.

### 3. A Business Model as a Key Ontological Entity in Strategic Management: Critical Literature Review

The concept of a business model in strategic management is currently one of the most frequently explored issues in the context of other areas, especially the high performance of companies and their competitive advantage in a very difficult economy. During the critical review of the literature on the concept of the business model, similar methodological solutions were used, as in the description of the concept of trust in the previous section of the article. When entering the term “business model” in the browser, this phrase appears in approximately 6,880,000,000 results [50]. Analyzing the occurrence of the term “business model” bibliometrically in the ProQuest database, it can be noted that, from 2010 to 2017, an increased occurrence of the above term was observed (Figure 2). It declined to only 37,122 items in 2018.

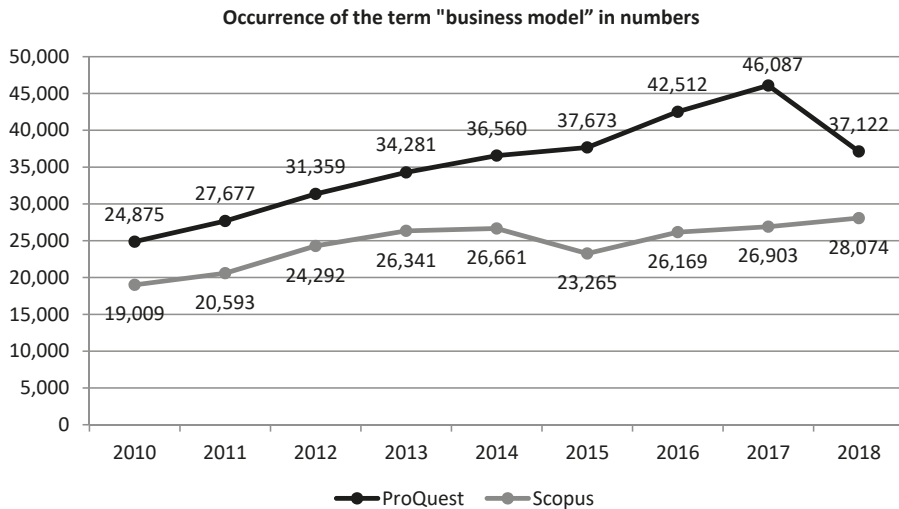

Figure 2. Number of occurrences of the phrase “business model” in the ProQuest and Scopus databases. Source: own study based on [4,5].

The situation is similar when it comes to the concept of the “business model” in the Scopus database. The occurrence of the term has increased over the years. For example, in 2010 there were 19,009 related search results, while in 2018 it was recorded in 28,074 search results.

In such an interpretation, a multidimensional and logically justified critical review of literature in the field of the concept of the business model should be undertaken, as there are many different definitions, approaches and perspectives.

It is related, among others, to high dynamics in strategic management mechanisms. Today, the success of an organization and its ability to operate continually is not only determined by strategy, but also the business model, its components and attributes and its ways of monetization and socialization. Monetization ensures the delivery of money streams to the organization and socialization ensures that its reputation and brand are built and maintained. The business model is, *inter alia*, “an architecture for the product, services and information flows, including a description of the various business actors and their roles; a description of the potential benefits for the various business actors; and a description of the sources of revenue” [51]. A business model “depicts the content, structure and governance of transactions designed so as to create value through the exploitation of business opportunities” [52]. A business model “creates a heuristic logic that connects technical potential with the realization of economic value” [53]. The business model “is a reflection of the company’s strategy” [54]. “A business model is a simplified and aggregated representation of the relevant activities of a company. It describes how marketable information, products and/or services are generated by means of a company’s value-added component. In addition to the architecture of value creation, strategic as well as customer and market components are taken into consideration, in order to achieve the superordinate goal of generating, or rather, securing the competitive advantage” [55]. The general business model consists of four components in the form of a “magic triangle”:

1. Customer—who are our target customers?
2. Value proposition—what do we offer our customers?
3. Value chain—how do we manufacture products?
4. Profit mechanism—why is it profitable? [56]

A business model is a simplified representation of a profit-aimed venture, consisting of its essential elements and their interconnections [57]. “[Business models] are, at heart, stories that explain how enterprises work [and answer the following questions]: Who is the customer? And what does the customer value? It also answers the fundamental questions every manager must ask: How to make money in this business? What is the underlying economic logic that explains how we can deliver value to customers at an appropriate cost?” [58]. At the most basic level, the business model is defined only in terms of the company’s economic model. The concern is with the logic of profit generation. “Relevant decision variables include revenue sources, pricing methodologies, cost structure, margins and expected volumes” [59]. “Business models have a multivalent character as models. They can be found as role models that might be copied or presented as nutshell descriptions of a business organization: simplified, short-hand descriptions equivalent to scale models. We can think of them not only as capturing the characteristics of observed kinds in the world (within a taxonomy), but also as abstract ideal types (in a typology)” [60]. “A business model describes the rationale of how an organization creates, delivers and captures value” [61]. The concept of the business model “generally refers to the articulation between different areas of a firm’s activity designed to produce a proposition of value to customers. Two different uses of the term can be noted. The first is the static approach—as a blueprint for the coherence between core business model components. The second refers to a more transformational approach, using the concept as a tool to address change and innovation in the organization, or in the model itself” [62]. “The business model expresses the logic, the data and other evidence that support a value proposition for the customer, and a viable structure of revenues and costs for the enterprise delivering that value” [63]. The business model “makes visible how the company acquires and uses different forms of capital (physical, financial and intellectual) to create value.” (p. 243)

“The concept is holistic, multi-level, boundary-spanning and dynamic” [64]. “In broad terms, a business model can be defined as having three constituent elements: the value proposition that defines how products and/or services are presented to consumers (i.e., how value is captured), the value network that defines how the business is articulated with other businesses and internally (i.e., how value is created) and the context of regulations, incentives, prices, government policy, etc. (i.e., how value is situated within the wider socio-economic framework)” [65]. “The business model is a description of an organization and how that organization functions in achieving its goals” (e.g., profitability, growth, and social impact [66].) The definitions of the business model presented above illustrate the complex nature of the issue that can be implemented in many areas and perspectives. They give, however, a certain form of interpretation allowing for the capture of those components that allow for proper scientific inference, as well as practical decision making in the real conditions of the economy.

The summary presented aimed primarily to demonstrate the dynamics of the development of the phenomenon of the business model in management sciences. This is particularly important in relation to the business model as an ontological entity, especially in strategic management. Due to the fact that the business model can be, among others, presented subjectively and objectively, the number of phrases which appear is very large. These dynamics are also important because of the demonstration of the strength of the business model’s impact on many areas of the organization’s functioning, as well as the degree of exploration and exploitation of this concept by management theorists and practitioners. It is also worth referring to the fact that currently the business model and its capabilities and ability to monetize and create social and economic value determine the dynamics of the organization which functions in a network environment.

#### **4. A Business Model and a Social Business Model: An Interpretive Approach**

In order to be able to better justify the logic of the adopted scientific argument pertaining to social business models, it is important to show selected approaches between the business model and its specific construction, which is the social business model.

The classical approach to business models classifies business models in static and dynamic terms. In static terms, it can be understood as the architecture of the flow of products, services and information [51]; it also depicts the content, structure and governance of transactions designed to create value through the exploitation of business opportunities [52], creates heuristic logic that connects technical potential with the realization of economic value” [53], a system of interdependent activities that transcends the focal firm and spans its boundaries [67], and a simplified and aggregated representation of the relevant activities of a company [55]. In dynamic terms, the business model can be understood as a change in the perceived logic of value creation by a corporation [68]; initiatives aimed at creating new value by questioning existing industry business models, roles and relationships in certain geographical market areas [69]; and a small adjustment process consisting of voluntary and emerging changes between permanently connected key components [62]. Business models can also be viewed from both a subjective and an objective perspective. In subjective terms, the key to choosing a business model is the way of embedding it in the value chain; e.g., as an operator, integrator, conductor and distributor. For example, a networked business model describes how a strategic business network creates value. The development of new technologies requires new skills and resources; therefore, in addition to innovators and manufacturers, many other actors, such as suppliers, users, distributors and others are linked together in a network of functions, activities and actors [70]. In objective terms, the key to interpretation is the configuration of the business model and its interfaces. Configuration is important when business models need to be modified. Very often, the change takes place at the level of the value chain, the modifications of which are forced by trends in the sector or industry [71].

Table 2 presents several types of business model decomposition using a component approach. They are essential for the process of the flexible design of business models [71].

**Table 2.** Examples of solutions in the sphere of business model decomposition.

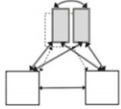
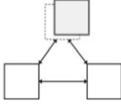
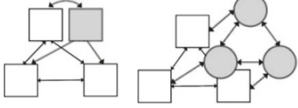
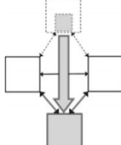
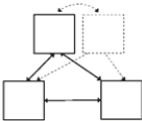
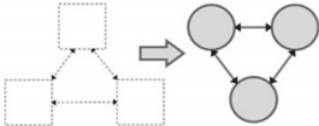
Operator	Graphical Representation	Definition
Splitting		Splitting the business model component into at least two new components of the model
Substituting		Substituting the business model element with another component performing the same tasks
Augmenting		Establishing a new component (new components) of the business model
Inverting		Changing certain features to features that are opposed to them
Porting		Removing a component to narrow down the business model function
Porting		Transferring a business model component (or the entire model) from one domain to another

Solid lines: components and connections  
 Dashed lines: components and connections removed from the model  
 Double lines and gray figures: new components and new links introduced to the model

Source: [72].

As part of the solution presented in Table 2, the examples of actions serving the decomposition of the business model can be distinguished. These include inserting new components into the business model architecture, replacing one component of the business model with another, and model reconfiguration (changing a larger number of components), as a result of which other options are also radically changed. In addition, the design and decomposition of the business model are based on the following formulas for shaping them: splitting, substituting, augmenting, inverting, excluding and porting [72].

As the configuration approach is particularly emphasized in relation to this article in particular, the key definitions of the business model are presented below in Table 3 with the main term in relation to configuration management.

**Table 3.** Key definitions of the business model together with the presentation of the main term in relation to configuration management.

Source	Definition of the Business Model	Main Term in Relation to Configuration Management
Timmers, 1998 [51]	The business model is the “architecture of products, services and information flows, including a description of the various business actors and their roles; description of potential benefits for various economic entities; description of sources of income” (p. 4)	Architecture
Amit and Zott, 2001 [52]	“A business model depicts the content, structure and governance of transactions designed so as to create value through the exploitation of business opportunities.” (p. 493)	Structure
Finnie, 2000 [73]	“The main components of the business model [are] customer interface, core strategy, strategic resources and value network. These basic components are linked by three, bridging components: customer benefits, configuration of activities and company boundaries” (p. 10)	Interface
Chesbrough and Rosenbloom, 2002 [53]	The business model is “heuristic logic that connects technical potential with the realization of economic value” (p. 529). “The business model provides a coherent framework that uses technological characteristics and potential as input and converts them through customers and markets into economic outputs” (p. 532)	Framework
Hawkins, 2002 [74]	“In other words, the business model describes how an enterprise gears up its resources, planning capabilities and processes to the revenue producing potential of a specific product or service. By focusing on this relationship to revenue producing potential, a new context is provided for assessing the planning and operational aspects of an enterprise, and for assessing the relationship between on-line and off-line trading environments” (p. 308)	Context, relationships
Knyphausen-Aufsess and Meinhardt, 2002 [57]	The business model is a simplified representation of a profit-aimed venture, consisting of its essential elements and their interconnections.	Simplification
Magretta, 2002 [58]	“[Business models] are, at heart, stories – stories that explain how enterprises work [and answer the following questions,] Who is the customer? And what does the customer value? It also answers the fundamental question that every manager must ask: How do we make money in this business? What is the underlying economic logic that explains how we can deliver value to customers at an appropriate cost?” (p. 87)	Logic
Mangematin et al., 2003 [75]	“A business model is a description of the commercial relationship between a business enterprise and the products and/or services it provides in the market.” (p. 299)	Description of the relationship
Mitchell and Coles, 2003 [76]	“A business model is a combination of “who,” “what,” “when,” “where,” “why,” “how” and “how much.” The organization uses them to provide its goods and services and developing resources to continue its efforts” (p. 17)	Combination
Pateli and Giaglis, 2004 [77]	“Business models are not conceived as a purely management-related concept, but embrace a broad spectrum of organisational activities, from the operational (processes) to the strategic level. Moreover, given the evolution of networked organisations and the growing adoption of eBusiness, the definition of business models has been extended to include inter-organisational activities, roles, and elements as well.” (p. 308)	Spectrum of activities
Rappa, 2004 [78]	“A business model is a method of doing business. All business models specify what a company does to create value, how it is situated among upstream and downstream partners in the value chain, and the type of arrangement it has with its customers to generate revenue” (p. 34)	Type of agreement
Downing, 2005 [79]	The business model “is a set of expectations about how the business will be successful in its environment” (p. 186)	Set of expectations
Morris et al., 2005 [59]	“At the most rudimentary level, the business model is defined solely in terms of the firm’s economic model. The concern is with the logic of profit generation. Relevant decision variables include revenue sources, pricing methodologies, cost structures, margins, and expected volumes.” (p. 727)	Logic
Johnson et al., 2008 [80]	“A business model, from our point of view, consists of four interlocking elements that, taken together, create and deliver value [ . . . ] Customer value proposition [ . . . ] Profit formula [ . . . ] Key resources [ . . . ] Key processes [ . . . ]”(p. 60f)	Related elements

Table 3. Cont.

Source	Definition of the Business Model	Main Term in Relation to Configuration Management
Richardson, 2008 [81]	A business model is a “conceptual framework that helps to link the firm’s strategy, or theory of how to compete, to its activities, or execution of the strategy. The business model framework can help to think strategically about the details of the way the firm does business.” (p. 135) “The three major components of the framework—the value proposition, the value creation and delivery system, and value capture—reflect the logic of strategic thinking about value. The essence of strategy is to create superior value for customers and capture a greater amount of that value than competitors. (p. 138)	Conceptual framework
Zott and Amit, 2008 [82]	““In this paper, we [ . . . ] introduc[e] the firm’s business model as a new contingency factor that captures the structure of a firm’s boundary spanning exchanges and [ask]: How do the firm’s business model and its product market strategy interact to impact firm performance?”(p. 1)	Structure
Doganova and Eyquem-Renault, 2009 [83]	The business model is a narrative and calculative device that allows entrepreneurs to explore a market and plays a performative role by contributing to the construction of the techno-economic network of an innovation.” (p. 1559)	Narrative and calculative device
Baden-Fuller and Morgan, 2010 [60]	“Business models have a multivalent character as models. They can be found as exemplar role models that might be copied or presented as nutshell descriptions of a business organisation: simplified, short-hand descriptions equivalent to scale models. We can think of them not only as capturing the characteristics of observed kinds in the world (within a taxonomy), but also as abstract ideal types (in a typology)”(p. 167)	Capturing characteristics
Casadesus-Masanell and Ricart, 2010 [54]	“A business model is [ . . . ] a reflection of the firm’s realized strategy” (p. 195) Reflection	Reflection
Dahan et al., 2010 [84]	“Firms [and] NGOs use business models to structure and map the mechanisms whereby they intend to deliver value [ . . . ] to their target public, and how the necessary costs and revenues will be structured.” (p. 329)	Structured and mapped mechanisms
Demil and Lecocq, 2010 [62]	“The business model concept generally refers to the articulation between different areas of a firm’s activity designed to produce a proposition of value to customers. Two different uses of the term can be noted. The first is the static approach—as a blueprint for the coherence between core business model components. The second refers to a more transformational approach, using the concept as a tool to address change and innovation in the organization, or in the model itself.” (p. 227)	Articulation
Osterwalder and Pigneur, 2010 [61]	“A business model describes the rationale of how an organization creates, delivers, and captures value.” (p. 14)	Rationale
Svejenova et al., 2010 [85]	Individual business models describe activities, the organisation, and the implication of strategic resources that organisational agents use to pursue their interests and motivations and create value and revenues in the process.	Implication of resources
Teece, 2010 [63]	“A business model articulates the logic and provides data and other evidence that demonstrates how a business creates and delivers value to customers. It also outlines the architecture of revenues, costs, and profits associated with the business enterprise delivering that economic value.”	Logic
Weiner et al., 2010 [86]	“A business model is a conceptual tool containing a set of objects, concepts and their relationships with the objective to express the business logic of a specific firm. Therefore, we must consider which concepts and relationships allow a simplified description and representation of what value is provided to whom, how this is done and with which financial consequences” (p. 23)	Conceptual tool, relationships, simplification
Wirtz et al., 2010 [87]	“A business model represents a strongly simplified and aggregated illustration of the relevant activities of a venture. It explains how the value creation component of a venture creates marketable information, products, and/or services. Besides the architecture of value creation, the strategic, as well as the customer and market component are considered to realise the superordinate goal objective of generating respectively securing the competitive advantage. The business model reflects the systemic output of an organisation, the way the organisation works and creates value.”	Simplified and aggregated illustration



Table 3. Cont.

Source	Definition of the Business Model	Main Term in Relation to Configuration Management
Yunus et al., 2010 [88]	"Among the plethora of definitions [of business models], three elements are usually distinguished: the product/service proposed to customers, the way the company is organized so as to deliver this product and service to its customers, and the revenue model." (p. 311)	Elements
Zott and Amit, 2010 [72] (pp. 216-226)	"We conceptualize a firm's business model as a system of interdependent activities that transcends the focal firm and spans its boundaries. The activity system enables the firm, in concert with its partners, to create value and also to appropriate a share of that value [and is defined by] design elements—content, structure and governance—that describe the architecture of an activity system; and design themes—novelty, lock-in, complementarities and efficiency – that describe the sources of the activity system's value creation." (p. 216)	System of independent activities
Bieger and Krys, 2011 [89]	A business model describes the basic logic of how an organisation creates value by defining 1) the organisation's value offering, 2) how the value is created within the organisational system, 3) how the created value is communicated and delivered to the customer, 4) how it is captured in the form of revenues by the company, 5) how the value is distributed within the organisation and to stakeholders, and 6) how the basic logic of value creation is refined to ensure the sustainability of the business model in the future.	Logic
Evans et al., 2012 [90]	"Business model is the way in which a business chooses to create, deliver, capture and exchange value" (p. 10)	Exchange
Beattie and Smith, 2013 [64]	The business model "makes visible how the company acquires and uses different forms of capital (physical, financial and intellectual) to create value." (p. 243) "The concept is holistic, multi-level, boundary-spanning and dynamic." (p. 244)	Concept
Schallmo, 2013 [91]	A business model is the underlying logic of a company that describes the value that is created for its customers and partners, how it is created, and how the created value flows back to the company as revenues. The created value allows for a differentiation from competitors, a consolidation of customer relations, and the realization of a competitive advantage.	Logic, consolidation of relations
Skarzynski and Gibson, 2013 [92]	"We define a business model as a conceptual framework for identifying how a company creates, delivers and extracts value. It typically includes a whole set of integrated components, all of which can be looked on as opportunities for innovation and competitive advantage" (p. 112)	Conceptual framework, a set of integrated components,
Geissdoerfer et al., 2016 [93]	"We describe business models as simplified representations of the elements and interactions between these elements that an organisational unit chooses in order to create, deliver, capture, and exchange value." (p. 1218)	Simplified representations of the elements, interactions
Wells, 2016 [65]	"In broad terms, a business model can be defined as having three constituent elements: the value network and product/service offering that defines how the business is articulated with other businesses and internally (i.e., how value is created); the value proposition that defines how products and/or services are presented to consumers in exchange for money (i.e., how value is captured); and the context of regulations, incentives, prices, government policy and so on (i.e., how value is situated within the wider socioeconomic framework)." (p. 37)	Constituent elements
Wirtz et al., 2016 [55]	"A business model is a simplified and aggregated representation of the relevant activities of a company. It describes how marketable information, products and/or services are generated by means of a company's value-added component. In addition to the architecture of value creation, strategic as well as customer and market components are taken into consideration, in order to achieve the superordinate goal of generating, or rather, securing the competitive advantage. To fulfil this latter purpose, a current business model should always be critically regarded from a dynamic perspective, thus within the consciousness that there may be the need for business model evolution or business model innovation, due to internal or external changes over time" (p. 41)	Simplified and aggregated representation, architecture
Massa et al., 2017 [66]	"A business model is a description of an organisation and how that organisation functions in achieving its goals (e.g., profitability, growth, social impact, ...)." (p.73)	Description

Source: [94].

The table above clearly indicates the interpretative importance of this approach. Therefore, searching for key components for the business model seems to be an important area of both scientific research and the applicable capabilities of business models.

The two most common approaches to the concept of the business model are:

1. A narrow approach, in which the business model is understood as a way of generating revenue.
2. A broad approach, in which the business model is understood as a way for the individual to create value [95].

The classification of business models by the criterion of the similarity of goals and the concept of model building can allow for their division into five groups:

- Models based on profitability determinants;
- Models shaping competitive advantage;
- Strategic models as a unique combination of assets creating value and competitiveness;
- Models focused on creating and using value;
- Models of an innovative business concept [96].

At present, the business model is used in a wide range of tasks, inter alia, to:

- Understand business logic;
- Design the forms of adaptation to external changes;
- Undertake strategic planning and business modeling, and conduct strategic experiments;
- Develop new conceptual solutions for the product line and form of business organization;
- Create a single communication space in relation to the logic of organization and business management;
- Train professional managers in the style of successful adopted organizations [97].

Referring to the above considerations, it is important to present the concepts of social business models against this background. The modern world dominated by information technologies evokes the need to stimulate social issues, not only in the sphere of interpersonal relations but also the implementation of assumptions and social economy solutions. A social factor in the economy of the new generation is important, and building communities and mutual relationships based on social media and expedient platforms for communication and service provision creates a new image of the economy. The social aspects of conducting business and public activity have created opportunities for developing the new forms of building social business models due to the dynamic development of the relational nature of market participants entering into multilateral interactions. If there is a social market economy, the mechanisms of social business models are revealed. A social enterprise is “a company that is cause-driven rather than profit-driven, with the potential to act as a change agent for the world” [98]. “Social enterprises” are a subset of such activities in which commercial models are used as the vehicle by which social objectives are achieved [99]. A social enterprise refers to an organization that conducts business activity, both to increase income and to further improve social missions [100]. Social and economic value management—the perspective of trying to find a balance in the context of the attributes of social business models—is an interdisciplinary issue. Social business models go beyond traditional economics, pointing to the intangible nature of value. Business models that create effective social value factors have a chance to be successful in the market. Social business models generate strategic value that in some cases turns into valuable products or services, and sometimes creates higher-level social value. The first attempts to conceptualize and operationalize social aspects in business models were related, for example, to the definition of sustainable business model archetypes [101]. Factors that drive social business models are the innovative ways of integrating social impact on the offer and creating company value [102]. Social business models are strongly linked to hybrid business models. Hybrid business models and hybrid strategies can be used by hybrid

organizations. Considering the importance of hybrid organizations in strategic management, selected elements of company hybridization can be defined:

1. The possibility of combining hierarchy and virtualization principles in the company structure.
2. The possibility of combining systemicity and networkedness principles in management.
3. The possibility of jointly structuralizing and blurring the boundaries of the company.
4. The possibility of achieving company goals as seen from a short, medium and long-term perspective.
5. The possibility of dichotomous confrontation of the various resources of the company to achieve competitive advantages in the market [103].

From this perspective, the issue of social business models takes on special significance, mainly in relation to the quest for high performance.

### **5. The Social Dimension of the Business Models of Companies and the Attributes of Trust**

The social conditions of today's business shape the strategic organizational behavior of companies in a significant way. The social dimension of business is gaining in importance due to the growing expectations on society from the economy, not only in the context of economic conditions but at the level of the dynamics of expectations in the social, environmental and ethical dimension. This involves a new look at the business and its key management tools and concepts, especially with reference to the place and role of business models in strategic management and its key attributes. In such a constructive comparison, a cause-and-effect relationship occurs between the way of building and implementing business models and their key components which determine the high performance of enterprises with such business models. As regards the economy, the link between the social business models of companies and the attribute of trust, as a component which becomes a platform for dialogue, relationships, transactions and the continuity of inter-organizational links in today's business, becomes important. In view of the above, it is important to define the concept of a social business model based on a critical review of the relevant literature. Social businesses are market-based businesses that explicitly focus on social goals, rather than the maximization of economic gains [98]. Wilson and Post (2013) mainly identify the requirements and provide recommendations for social business model design: (1) The development of social business models requires a holistic view. The integration of social and economic missions is associated with a new design, or a radical redesign of the activity system, including the value chain and the related stakeholder; (2) social business design and refinement require patience and time; (3) the social mission requires consistent alignment with capital and governance structures, such as the ownership status and the selection of investors [104]. A. Osterwalder and Y. Pigneur (2010) use the term "beyond-profit business models." This category is then divided into the third-party funded model and sustainable business models (triple bottom line model) [61]. Susanne Dohrmann, Matthias Raith and Nicole Siebold classify every social business model according to two characteristics: first by the degree to which it strategically monetizes social value creation, and second by the level of market revenue that it generates in excess of expenditures with the underlying social mission [105]. Social business models can be implemented by social enterprises, which are defined as any business venture created for a social purpose mitigating/reducing a social problem or a market failure and to generate social value while operating with the financial discipline, innovation and determination of a private sector business [106]. Social businesses in particular address a social need while generating profits typically reinvested into the business itself, but there is limited understanding of the ways through which social businesses achieve scale [107]. Data analysis methodology by Xaver Neumeier and Susana C. Santos combined individual (outdegree, indegree, out-twostep and betweenness centrality) and network-level metrics (multiplexity and density) to socially reconstruct an entrepreneurial ecosystem related to sustainable entrepreneurial ventures [108]. In this approach, the definition of a specific business ecosystem, in which trust-based social business models can be built and exploited, becomes more significant. This is a very important issue because, in this approach, not

only is economic capital created but, above all, specific social capital, which has large potential for the creation of proper organizational behaviors also associated with the positive intentions of management towards mutually cooperating business partners. Results in the ProQuest and Scopus databases, which were created as a result of combining the concepts of “trust” and the “business model,” were bibliometrically analyzed. By entering the concept of the “trust-based business model” in the Scopus database, the following results were obtained (Figure 3): 2010—137 items, 2011—133, 2012—again, 133, 2013 and 2014—143, 2015—157, 2016—148, 2017—170 and 2018—190, the most results for a single year during the research period. Taking into account the ProQuest database, those results are much higher. The minimum number appeared at the beginning of the analyzed period in 2010, amounting to 5904, and gradually increased until 2017. At that time 11,141 results were recorded in the database. However, in 2018 there was a decrease to 9122.

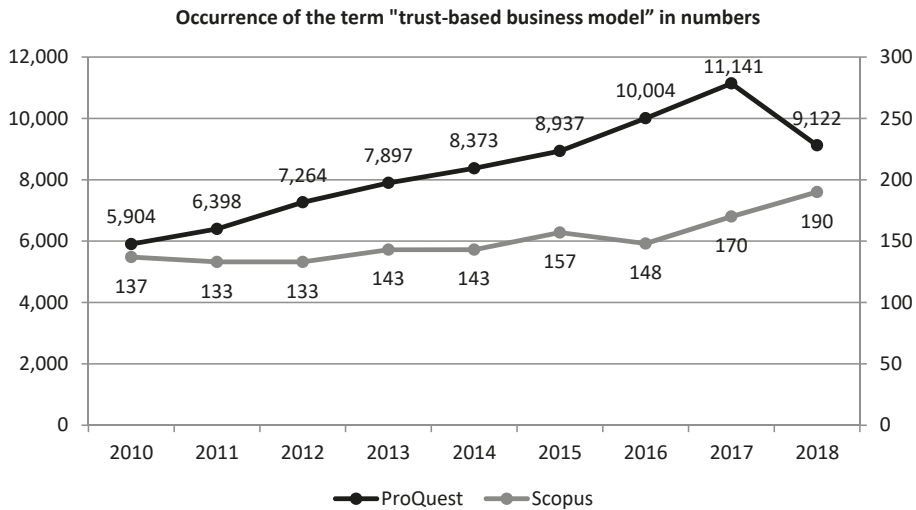

**Figure 3.** Number of occurrences of the phrase “trust-based business models” in the ProQuest database. Source: own study based on [4,5].

The summary presented of the phrase “trust-based business model” is particularly important in the context of the results of the scientific research discussed in the article. This phrase concerns a special construct which is a trust-based business model. Such a business model defined in terms of components can simultaneously enable the creation of social and economic values. This may particularly apply to hybrid enterprises, which include water supply companies. In addition, such a business model is becoming a social business model, which is particularly important in organizations focused on achieving sustainable, reasonable profit, while being open to a wide range of its stakeholders. It is also important that trust itself is firmly embedded in the context of the concept of the so-called “social impact business model;” i.e., a concept based on building and operationalizing business models that strongly affect society, or even cause changes in the behavior of entire groups or communities. Hence, the key is to define the very concept of a trust-based business model. According to the authors, such a model is one of which the key component that determines the ability to achieve a high level of economic and social efficiency in the long and short term alike—is trust. At the same time, trust is a source of building positive relationships and contributes to the mutual creation of positive intentions in business. In this case, trust is a factor that creates positive social interaction, especially for mutual relationships between various groups of these communities. Hence, the specific dynamics of the appearance of this phrase indicates the importance of this issue in management sciences and scientific trends in this area.

## **6. The Hybrid Nature of Water Supply Companies and Trust in Terms of Social Values**

Referring broadly to the entities studied and described in this article, it is particularly important to refer to the fact that water supply companies are in fact hybrid organizations. What does this mean for them and for their stakeholders? It is important that they pursue a variety of goals, which can often be mutually exclusive to some extent, while in other cases they complement one another. Everything depends on the adopted context of understanding and running this business. However, the most important thing is skillfully balancing economic and social goals in achieving the so-called reasonable profit and satisfying all the key stakeholder groups at the same time. From this perspective, hybrid enterprises also struggle at an ideological level with finance, concerned by the economic focus of lenders, and the tension this creates with social and environmental value capture [109].

In contrast to the literature on hybridity, the literature on sustainable business models suggests holistic models of sustainable entrepreneurship can exist, wherein the social, environmental and economic value can be mutually supportive [110]. There are many perspectives of the hybrid approach. A. Jabłoński and B. Kozuch draw attention to the fact that the following perspectives may occur.

- Hybridity in the criterion of an organization's goal;
- Hybridity in the criterion of methods and management concepts;
- Hybridity in the criterion of the regulated and business market;
- Hybridity in the criterion of the application of ontological entities [103].

Linking hybridization with business scalability is also an important issue. Hybrid organizations should have scalable business models [111]. This dependence is particularly visible through achieving the economic goals of water supply companies, while being able to create a social effect. The very notion of a reasonable profit, i.e., one that ensures investment opportunities as well as offering an acceptable price for sharing and the use of water by the residents of a given city or municipality, already creates the appropriate organizational behavior and management methods and concepts. Therefore, the incorporation of a scientific discussion on trust into such logic becomes obvious. In this case, trust is a kind of specific link between social dialogue and its outcome. Stakeholders of a water supply company buy trust in the product, service and organization, hoping that the organization will ensure the continuity of the product's use with an appropriate, acceptable price and quality. The profitability threshold of a water supply company within the framework of controlling solutions should shift towards an acceptable price and the achievement of a reasonable profit. This is also a hybrid perspective. Hence, trust becomes a factor in creating social values associated with economic values. The co-creation of value and its exchange is of particular importance in terms of social business models where the value network plays a leading role in the flow of this value between stakeholders. In this area, a social factor also develops, creating a new view of the assumptions of traditional economics, and in particular the identification of the overriding objective of company existence; namely, generating profit.

The hybrid nature of water supply companies has a significant impact on both the attributes of their business models and their configuration. Hence, it is important that these business models are social business models, because they are open to a wide range of stakeholders, while the product itself, i.e., water production, has an impact on society. In this approach, trust matters for the product itself and for references to the water supply company. Focusing strategic attention on trust as an important component of the business model seems justified. The authors are aware of the different interpretations of the concept of trust, but in this case they treat them as a strategic factor of a component nature, which is located in the canvas of the social business model of a water supply company. Interfaces between trust and other components of the business model create strategic decision-making processes related to the social and economic value generated. From this perspective, the following scientific research becomes significant in this area.

## **7. Research Methodology by Means of the AHP (Analytic Hierarchy Process) Method**

### *7.1. Introduction*

As part of the research presented in the article, water supply companies located in the Silesia province, which is the most industrialized area in Poland, with the largest and densest water supply network, were analyzed.

Water supply companies were selected for the research according to the following premises and assumptions:

- They pursue social and economic goals, thus being so-called hybrid organizations;
- Their fundamental product is water supply, and its customers must trust its quality and the continuity of supply;
- Local communities are their key customers;
- They must meet economic, social and environmental requirements;
- They are most often public, so-called high trust entities;
- Their profit is so-called reasonable profit and costs must be reasonable, which is strongly verified by the local community.

At the same time, it is worth noting that water supply companies are so-called civilian intervention services. This means that, in addition to proactive action related to water supply and water and wastewater management, their key social task is to respond to any crisis situation that could, for example, lead to a deterioration in the quality of water supplied, or no supply at all. Thus, the speed of responding to disturbances in this system is, among other things, a trust-building factor between the water supply company and the local community.

According to this interpretation, water supply companies are significantly different from other market players, which is also due to their public and missionary nature based on trust and sector and product specificity.

Trust in water supply companies also fills the space that strengthens inter-entity relationships, which results in the economic and social efficiency discussed herein. It is also worth noting that, by introducing the principles of reasonable profit in these organizations, political influence on price formation for services is eliminated. From this perspective, trust and the strengthening thereof becomes a strategic factor which influences the key ontological entities of organizations, which include the business model, strategy, business processes and strategic projects. It is important to find the strength of the influence of trust on the construction of these ontological entities by asking the question: to what extent does trust influence the decision-making mechanisms resulting from the formation of these ontological entities? Trust also shapes the dynamics and durability of relationships, which can translate into the achievement of social and economic efficiency.

In this context, attention should be paid to a certain uniqueness of the scientific research conducted. Until now, there has not been a great deal of scientific research undertaken into embedding trust in the configuration of the social business model, especially in relation to the conditions of water supply companies. The importance of this topic in management sciences is evidenced by the fact that the presented relationship between trust and the social business model seems to be expedient due to the increasing importance of management intentions in building business models. It is in this context where the soft elements of management, which include trust, play an increasingly important role in strategic management mechanisms. If we treat trust as an important component of the business model, it becomes, to some extent, an ontological entity that can be effectively managed to increase the effectiveness of the business model, and consequently the entire organization. It can be assumed that the scientific novelty of this article is primarily associated with the presentation of logic and the ranking of trust in the construction of the social business model of water supply companies. It is also important to determine the place and role of trust in the very conceptualization and operationalization of the social business model of water supply companies in relation to the search for a component that also

ensures the consistency and scalability of the social business model. Hence, according to the authors, a strong scientific gap arises, and the related scientific problem is the determination of the priority weight of trust in the configuration of the social business model of water supply companies, together with the definition of mutual interfaces with other potential components of this business model. The scientific problem is related to building social business models based on the trust of companies in the water supply sector. A cognitive gap is related to the lack of sufficient research into the construction of social business models, as well as their optimal and scalable configuration in terms of determining the place and role of trust, especially in water supply companies. Figure 4, below, shows the structure of the assumed research model used in the AHP study in relation to trust.

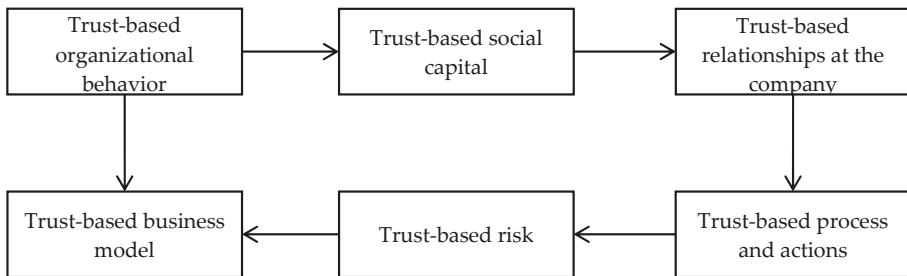

**Figure 4.** The structure of the assumed research model used in the AHP study in relation to trust. Source: own study.

The sample examined consisted of 10 surveys which were completed by water supply companies. The responses obtained were analyzed by means of the AHP method presented below.

The individual stages of the AHP analysis are presented in a structured manner as follows:

1. Building the hierarchical model: presenting a decision-making problem as individual hierarchy levels:
  - a. A superior goal: the highest level of the hierarchy.
  - b. Decision criteria or other factors: intermediate levels which affect the degree of achievement of the overall goal; the number of levels depends on the complexity of the problem.
  - c. Decision options: the lowest level of the hierarchy.
2. Evaluation by pairwise comparisons—elements at each level of the hierarchical model and the related element from the higher level are compared.
3. Determining global (selection criteria) and local (decision options considered) preferences and determining their mutual significance.
4. Arranging decision options, taking their share in the implementation of the overriding goal into account.

Decision options at the lowest level of the model hierarchy are subject to comparative assessment. Individual criteria are compared in pairs and the degree of their fulfillment is examined. A comparative assessment, which takes relative ratings into account, leads to the presentation of the matrix of the decision maker's local preferences. The result is the determination of a vector arising from the arrangement of options due to the degree of achievement of the assumed goal.

Local values form the basis for calculating global weights. The global value of an element from a given level is obtained by multiplying the value of its local weight by the value of the global weight of the element at the level immediately above.

Decision options, as the last level of the hierarchical structure, have priorities calculated similarly to what is described above. It proceeds as follows:

1. Comparing the importance of decision options in relation to individual sub-criteria. The result is the determination of the importance of individual decision options for the implementation of a given sub-criterion (i.e., local weights obtained).
2. In order to obtain partial global weights, the values of local weights obtained and the corresponding global weights for sub-criteria must be multiplied. These values show the share of a given decision option in achieving the main objective through the implementation of the sub-criterion under consideration.
3. The sum of the partial global weights of a given decision option is its global weight. The highest weight value is considered the best one and this decision option prevails.

The following is the algorithm for proceeding in the AHP method (Figure 5) for the purposes of presenting the structure of scientific research and the logic of further reasoning.

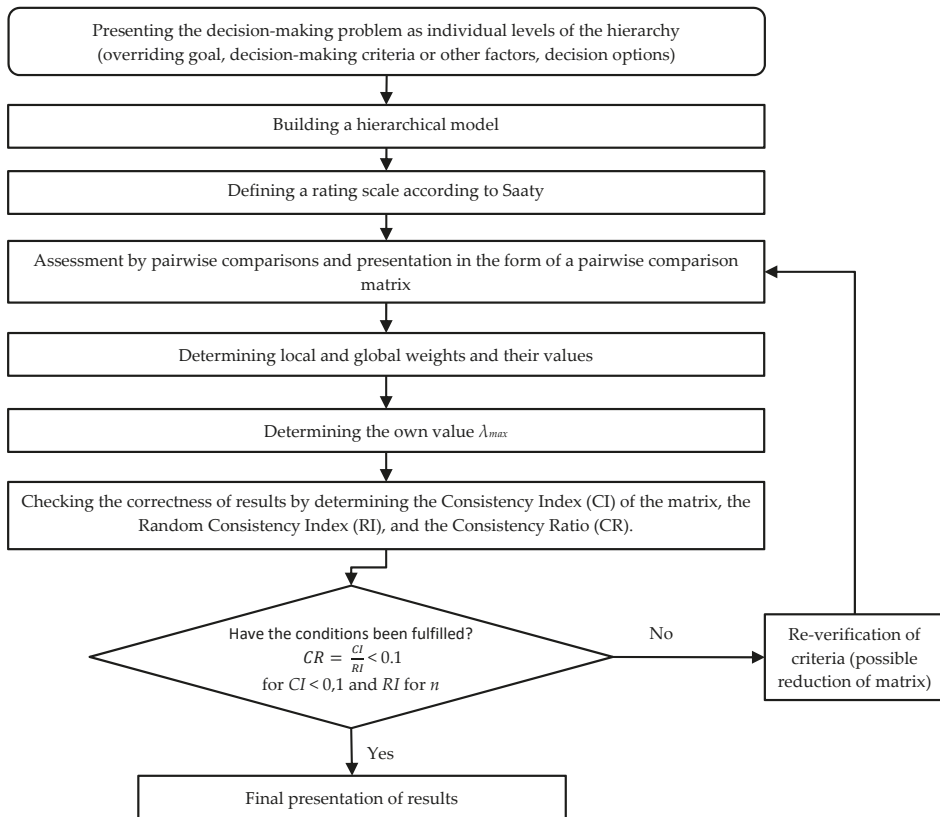

Figure 5. Algorithm for proceeding in the AHP method. Source: own study.

The aim of the analysis was the issue of trust as a key factor in shaping the social business model of the company. In the questionnaires, respondents were asked to answer questions on the following issues:

- Trust-based organizational behavior at the company;
- Trust-based social capital at the company;
- Trust-based relationships at the company;
- Trust-based processes and activities at the company;



- Trust-based risk at the company;
- The trust-based business model at the company.

The following scheme (Figure 6) of the hierarchical model was used in the study:

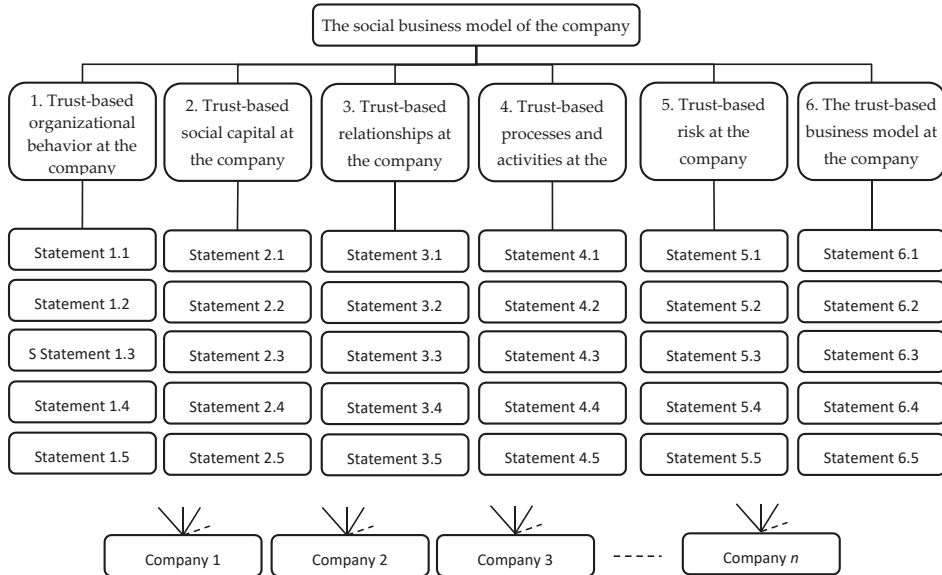

Figure 6. Scheme of the hierarchical model adopted for the study. Source: own study based on [112].

In the adopted AHP method, water supply companies were subject to a comparative analysis. These companies are decision options at the lowest level of the model hierarchy. Six problems were adopted for the analysis, in which the following survey statements were defined:

1. Trust-based organizational behavior at the company:
  - Statement 1.1. At our company, trust shapes positive organizational behavior.
  - Statement 1.2. At our company, trust creates positive managerial intentions.
  - Statement 1.3. At our company, employees are characterized by honest and cooperative behavior based on the expressed norms and values.
  - Statement 1.4. At our company, there is an appropriate climate of trust which shapes positive organizational behavior.
  - Statement 1.5. At our company, trust has a special impact on both strategic and tactical-operational behavior.
2. Trust-based social capital at the company:
  - Statement 2.1. At our company, trust positively affects the construction of social capital.
  - Statement 2.2. At our company, social capital is based on mutual trust between stakeholders.
  - Statement 2.3. At our company, trust is a key resource for building social capital.
  - Statement 2.4. At our company, trust positively affects the development of employees' social competences.
  - Statement 2.5. At our company, trust allows us to express the same values, which shape our social capital.

3. Trust-based relationships at the company:
  - Statement 3.1. At our company, trust creates mutual relationships.
  - Statement 3.2. At our company, trust improves communication between employees.
  - Statement 3.3. At our company, relationships allow us to apply the same norms of reciprocity.
  - Statement 3.4. At our company, there are continuous interactions and trust-based relationships between employees.
  - Statement 3.5. At our company, trust-based relationships allow us to implement common goals.
  
4. Trust-based processes and activities at the company:
  - Statement 4.1. At our company, trust triggers positive activities.
  - Statement 4.2. At our company, trust allows for less control of processes and activities.
  - Statement 4.3. At our company, trust enables more effective and efficient processes and activities.
  - Statement 4.4. At our company, trust strengthens mutual cooperation both at the level of processes and activities.
  - Statement 4.5. At our company, mutual trust accelerates decision-making processes.
  
5. Trust-based risk at the company:
  - Statement 5.1. At our company, trust is a factor which limits the risk of our activity.
  - Statement 5.2. At our company, thanks to mutual trust, its reputation is improved.
  - Statement 5.3. At our company, thanks to mutual trust, there are no behaviors that are different from those expected.
  - Statement 5.4. At our company, trust limits mutual distrust.
  - Statement 5.5. At our company, the risk is mitigated, limited by mutual trust between employees.
  
6. The trust-based business model at the company:
  - Statement 6.1. At our company, trust is a key attribute/component of the business model.
  - Statement 6.2. At our company, trust shapes the business model.
  - Statement 6.3. At our company, trust positively affects other attributes/components of the business model.
  - Statement 6.4. At our company, trust strengthens other components of the business model.
  - Statement 6.5. At our company, thanks to trust embedded in the business model, we achieve a high level of efficiency and effectiveness.

The above criteria and sub-criteria in the form of statements were compared in pairs. Their degrees of fulfillment were examined in the water supply companies surveyed. The criteria were formulated by the authors based on their knowledge of business management issues. The criteria were compared in pairs using the scale below, which is shown in Table 4:

**Table 4.** Saaty scale used to compare the pairs of criteria.

Significance Scale	Explanation
1	No criterion has an advantage over the other in terms of achieving the goal.
3	Criterion A has a moderate advantage over option B.
5	Criterion A has a strong advantage over option B.

Source: own study based on [113].

7.2. Analysis of Basic Data of Water Supply Companies

In addition to data collected in the field of trust as a key factor in shaping the social business model of the company, a brief description of the water supply companies surveyed was presented, so they were asked to respond in the scope of:

- Number of employees:
  - One to nine (micro-enterprise);
  - Ten to 49 (small enterprise);
  - Fifty to 249 (medium-sized enterprise);
  - Over 250 (large enterprise).
- Forms of ownership:
  - Private;
  - Public.

Among the respondents, 90% of water companies were public enterprises, and 10% were private enterprises (Figure 7). Given the number of employees employed in the enterprises surveyed, 30% of water supply companies employ 10–49 people (a small enterprise), 30% of companies employ from 50 to 249 employees (a medium-sized enterprise), and 40% of companies are large enterprises employing over 250 employees. No company surveyed was a micro-enterprise employing a maximum of nine employees.

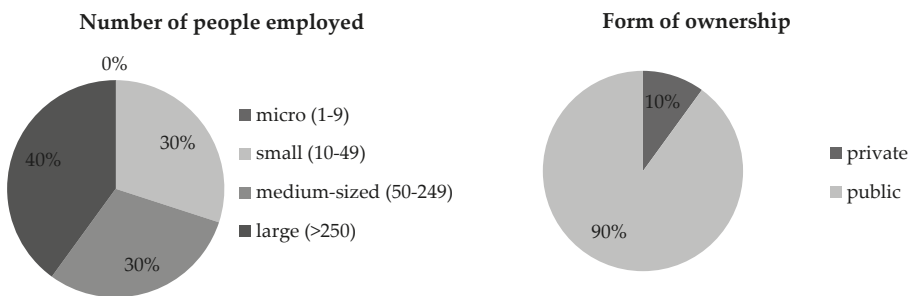

**Figure 7.** Basic data on water companies surveyed. Source: own study.

7.3. Determination of Global Weights for Given Criteria

Using the Saaty scale, a matrix of comparisons was constructed in pairs of criteria adopted for the study. The  $n \times n$  matrix was created, where  $n$  is the number of criteria. In this case  $n = 6$ , because six criteria were adopted. This matrix presents the advantage of one criterion over the other, and the final comparison gave the order of criteria in terms of final global weights.

Sub-criteria were compared in the same way, obtaining the local scales of sub-criteria. For this purpose, six separate sheets were created in which the comparison matrices were created. These matrices, in turn, were  $5 \times 5$ , because each group of criteria had a set of five statements (sub-criteria).

It should also be noted that in the AHP method, ratings are inverted. It means that the constructed matrix is consistent in pairs; i.e.,

$$w_{ij} \cdot \frac{1}{w_{ji}} = 1.$$

The comparison matrix, which presents the assessment of the significance of the criteria and the advantages of some criteria over others, was obtained thanks to the necessary knowledge of experts in the management industry. Their necessary participation contributed to obtaining knowledge about the processes taking place in the sphere of business management. Answers to the statements in the surveys show the approaches of managers in water supply companies, which are built based on experience, various priorities or value systems. The AHP method, by means of the comparison scale, directs the person who expresses their opinion on which of the two criteria has a greater advantage over the other. The following (Table 5) presents the matrix of pairwise comparisons:

**Table 5.** Matrix showing pairwise comparisons for particular groups of criteria.

Criteria	1. Trust-based Organizational Behavior at the Company	2. Trust-based Social Capital at the Company	3. Trust-based Relationships at the Company	4. Trust-based Processes and Activities at the Company	5. Trust-based Risk at the Company	6. The trust-based Business Model at the Company
1. Trust-based organizational behavior at the company	1.00	3.00	1.00	3.00	3.00	3.00
2. Trust-based social capital at the company	0.33	1.00	0.33	0.33	0.33	1.00
3. Trust-based relationships at the company	1.00	3.00	1.00	3.00	3.00	3.00
4. Trust-based processes and activities at the company	0.33	3.00	0.33	1.00	3.00	3.00
5. Trust-based risk at the company	0.33	3.00	0.33	0.33	1.00	3.00
6. The trust-based business model at the company	0.33	1.00	0.33	0.33	0.33	1.00
<b>Total</b>	3.33	14.00	3.33	8.00	10.67	14.00

Source: own study.

The above matrix of ratings was normalized by dividing the individual ratings from the criteria (in columns) by the sum of ratings for a given criterion (the sum of ratings from the column) and the W matrix was obtained:

$$W = \begin{bmatrix} 0.30 & 0.21 & 0.30 & 0.38 & 0.28 & 0.21 \\ 0.10 & 0.07 & 0.10 & 0.04 & 0.03 & 0.07 \\ 0.30 & 0.21 & 0.30 & 0.38 & 0.28 & 0.21 \\ 0.10 & 0.21 & 0.10 & 0.13 & 0.28 & 0.21 \\ 0.10 & 0.21 & 0.10 & 0.04 & 0.09 & 0.21 \\ 0.10 & 0.07 & 0.10 & 0.04 & 0.03 & 0.07 \end{bmatrix}$$

In the further part of the analysis, the notation of the criteria was shortened to improve the transparency of the entries in the tables:

- Criterion1: Trust-based organizational behavior at the company,
- Criterion2: Trust-based social capital at the company,
- Criterion3: Trust-based relationships at the company,
- Criterion4: Trust-based processes and activities at the company,
- Criterion5: Trust-based risk at the company,
- Criterion6: The trust-based business model at the company.

The values from individual rows of a normalized matrix were added up, and the values obtained were divided by the number of existing criteria (i.e., the number 6), as a results of which weights for each criterion were obtained (Table 6):

**Table 6.** Normalized pairwise comparison matrix and global weights obtained for the criteria.

Criteria	Criterion1	Criterion2	Criterion3	Criterion4	Criterion5	Criterion6	Weight
Criterion1	0.30	0.21	0.30	0.38	0.28	0.21	0.28
Criterion2	0.10	0.07	0.10	0.04	0.03	0.07	0.07
Criterion3	0.30	0.21	0.30	0.38	0.28	0.21	0.28
Criterion4	0.10	0.21	0.10	0.13	0.28	0.21	0.17
Criterion5	0.10	0.21	0.10	0.04	0.09	0.21	0.13
Criterion6	0.10	0.07	0.10	0.04	0.03	0.07	0.07
							Σ weight = 1

Source: own study.

The weights obtained were ranked from the highest to the lowest value, which were then classified in Table 7:

**Table 7.** Ranking of criteria together with global weights.

Ranking	Criterion	Criterion	Weight
1	Criterion1	Trust-based organizational behavior at the company	0.28
1	Criterion3	Trust-based relationships at the company	0.28
3	Criterion4	Trust-based processes and activities at the company	0.17
4	Criterion5	Trust-based risk at the company	0.13
5	Criterion2	Trust-based social capital at the company	0.07
5	Criterion6	The trust-based business model at the company	0.07

Source: own study.

The above table shows that the most important criteria in the analysis are Criterion 1, “Organizational behavior at the company” and Criterion 3, “Relationships at the company.” Both criteria obtained a global weight of 0.28. The lowest global weights were obtained by Criterion 2 and Criterion 6, at only 0.07. They refer to the subjects of social capital at the company and the business model of the company, respectively.

Finally, the correctness of the results was checked. The inconsistency index  $\lambda_{max}$  (i.e., the average of the matrix's own value) was calculated, which is shown in Table 8. The value of  $\lambda_{max}$  is a measure of the consistency of the comparisons reflecting the proportionality of the preferences. Pairwise comparisons are more consistent the closer  $\lambda_{max}$  is to  $n$  (the number of elements in the matrix = the number of rows = the number of columns). In the case of total consistency,  $\lambda_{max} = n$ .

**Table 8.** Inconsistency index  $\lambda_{max}$  for criteria.

Criteria	Total Rating of Individual Criteria (Columns)	Global Weights Obtained	Partial Values of the Inconsistency Index
Criterion1	3.33	0.28	0.94
Criterion2	14.00	0.07	0.97
Criterion3	3.33	0.28	0.94
Criterion4	8.00	0.17	1.38
Criterion5	10.67	0.13	1.36
Criterion6	14.00	0.07	0.97
			6.55

Source: own study.

After adding up partial values,  $\lambda_{max}$  was obtained, which was equal to 6.55. That value is similar to 6, the number of criteria tested.

The next step was to calculate the consistency index (CI), which gives the deviation from consistency, and the consistency ratio (CR), which determines the degree of inconsistency of the comparison of the significance of descriptions. These coefficients were calculated by means of the following formulas:

$$CI = \frac{\lambda_{max} - n}{n - 1}$$

$$CR = \frac{CI}{RI} \cdot 100\%$$

The consistency ratio (CR) was determined due to difficulties in the interpretation of the CI. To calculate the CR, the RI (random consistency index) value was determined, which was unchanged. Its value was checked in the book entitled, "Fundamentals of decision making and the priority theory with the Analytic Hierarchy Process," by T.L. Saaty. The value of the RI for the  $6 \times 6$  matrix was  $RI = 1.24$ . The random consistency index was calculated from a randomly generated matrix of  $n \times n$ . In contrast, RI values were generated from several thousand such matrices and presented by T.L. Saaty in his publication. This means that, for such a matrix dimension, the CR value should not exceed 10% ( $CR \leq 0.10$ ). This is due to the fact that the CR is accepted, and the comparisons are consistent. In this case, the CR value is 0.09, so this condition is met. If the comparisons were fully consistent, the value of coefficients would be:  $\lambda_{max} = n$ ,  $CI = 0$  and  $CR = 0$ .

#### 7.4. Determination of Local Weights for Sub-Criteria

Local weights for individual sub-criteria were determined in the same way as global weights. Six separate calculation sheets were developed. The matrices with the results of pairwise comparison are shown below in Tables 9–14.

Table 9. Pairwise comparison matrix for Criterion 1: Trust-based organizational behavior at the company.

Trust-based Organizational Behavior at the Company	Statement 1.1. At our Company, Trust Shapes Positive Organizational Behavior	Statement 1.2. At our Company, Trust Creates Positive Managerial Intentions	Statement 1.3. At our Company, Employees are Characterized by Honest and Cooperative Behavior based on the Expressed Norms and Values	Statement 1.4. At our Company, there is an Appropriate Climate of Trust which Shapes Positive Organizational Behavior	Statement 1.5. At our Company, Trust has a Special Impact on both Strategic and Tactical-Operational Behavior
Statement 1.1. At our company, trust shapes positive organizational behavior	1.00	0.20	1.00	1.00	1.00
Statement 1.2. At our company, trust creates positive managerial intentions	5.00	1.00	5.00	3.00	5.00
Statement 1.3. At our company, employees are characterized by honest and cooperative behavior based on the expressed norms and values	1.00	0.20	1.00	3.00	3.00
Statement 1.4. At our company, there is an appropriate climate of trust which shapes positive organizational behavior	1.00	0.33	0.33	1.00	3.00
Statement 1.5. At our company, trust has a special impact on both strategic and tactical-operational behavior	1.00	0.20	0.33	0.33	1.00

Source: own study.

Table 10. Pairwise comparison matrix for Criterion 2: Trust-based social capital at the company.

	Statement 2.1. At our Company, Trust Positively Affects the Construction of Social Capital	Statement 2.2. At our Company, Social Capital is based on Mutual Trust between Stakeholders	Statement 2.3. At our Company, Trust is a Key Resource for Building Social Capital	Statement 2.4. At our Company, Trust Positively Affects the Development of Employees' Social Competences	Statement 2.5. At our Company, Trust Allows Us to Express the Same Values, which Shape our Social Capital
Trust-based Social Capital at the Company					
Statement 2.1. At our company, trust positively affects the construction of social capital	1.00	5.00	1.00	3.00	0.33
Statement 2.2. At our company, social capital is based on mutual trust between stakeholders	0.20	1.00	0.20	0.33	0.33
Statement 2.3. At our company, trust is a key resource for building social capital	1.00	5.00	1.00	3.00	0.33
Statement 2.4. At our company, trust positively affects the development of employees' social competences	0.33	3.00	0.33	1.00	0.33
Statement 2.5. At our company, trust allows us to express the same values, which shape our social capital	3.00	3.00	3.00	3.00	1.00

Source: own study.



Table 11. Pairwise comparison matrix for Criterion 3: Trust-based relationships at the company.

Trust-based Relationships at the Company	Statement 3.1. At our Company, Trust Creates Mutual Relationships.	Statement 3.2. At our Company, Trust Improves Communication between Employees	Statement 3.3. At our Company, Relationships Allow us to Apply the Same Norms of Reciprocity	Statement 3.4. At our Company, there are Continuous Interaction and Trust-based Relationships between Employees	Statement 3.5. At our Company, Trust-based Relationships allow Us to Implement Common Goals
Statement 3.1. At our company, trust creates mutual relationships.	1.00	1.00	3.00	3.00	3.00
Statement 3.2. At our company, trust improves communication between employees	1.00	1.00	0.33	0.20	0.33
Statement 3.3. At our company, relationships allow us to apply the same norms of reciprocity	0.33	3.00	1.00	0.33	0.33
Statement 3.4. At our company, there are continuous interaction and trust-based relationships between employees	0.33	5.00	3.00	1.00	0.33
Statement 3.5. At our company, trust-based relationships allow us to implement common goals	0.33	3.00	3.00	3.00	1.00

Source: own study.

Table 12. Pairwise comparison matrix for Criterion 4: Trust-based processes and activities at the company.

Trust-based Processes and Activities at the Company	Statement 4.1. At our Company, Trust Triggers Positive Activities.	Statement 4.2. At our Company, Trust allows for less Control of Processes and Activities	Statement 4.3. At our Company, Trust Enables more Effective and Efficient Processes and Activities	Statement 4.4. At our Company, Trust Strengthens Mutual Cooperation both at the Level of Processes and Activities	Statement 4.5. At our Company, Mutual Trust Accelerates Decision-Making Processes
Statement 4.1. At our company, trust triggers positive activities.	1.00	3.00	5.00	3.00	5.00
Statement 4.2. At our company, trust allows for less control of processes and activities	0.33	1.00	3.00	0.33	0.33
Statement 4.3. At our company, trust enables more effective and efficient processes and activities.	0.20	0.33	1.00	0.20	0.33
Statement 4.4. At our company, trust strengthens mutual cooperation both at the level of processes and activities	0.33	3.00	5.00	1.00	1.00
Statement 4.5. At our company, mutual trust accelerates decision-making processes	0.20	3.00	3.00	1.00	1.00

Source: own study.

Table 13. Pairwise comparison matrix for Criterion 5: Trust-based risk at the company.

Trust-based Risk at the Company	Statement 5.1. At our Company; Trust is a Factor which Limits the Risk of our Activity	Statement 5.2. At our Company, Thanks to Mutual Trust, its Reputation is Improved	Statement 5.3. At our Company, Thanks to Mutual Trust, there are no Behaviors that are Different from those Expected	Statement 5.4. At our Company, Trust Limits Mutual Distrust	Statement 5.5. At our Company, the Risk is Mitigated, Limited by Mutual Trust between Employees
Statement 5.1. At our company, trust is a factor which limits the risk of our activity	1.00	5.00	3.00	3.00	3.00
Statement 5.2. At our company, thanks to mutual trust, its reputation is improved	0.20	1.00	0.33	0.33	3.00
Statement 5.3. At our company, thanks to mutual trust, there are no behaviors that are different from those expected	0.33	3.00	1.00	1.00	3.00
Statement 5.4. At our company; trust limits mutual distrust	0.33	3.00	1.00	1.00	3.00
Statement 5.5. At our company, the risk is mitigated, limited by mutual trust between employees	0.33	0.33	0.33	0.33	1.00

Source: own study.

Table 14. Pairwise comparison matrix for Criterion 6: The trust-based business model at the company.

	Statement 6.1. At our Company, Trust is a Key Attribute/Component of the Business Model	Statement 6.2. At our Company, Trust Shapes the Business Model.	Statement 6.3. At our Company, Trust Positively Affects other Attributes/Components of the Business Model	Statement 6.4. At our Company, Trust Strengthens other Components of the Business Model	Statement 6.5. At our Company, Thanks to Trust Embedded in the Business Model, We Achieve a High Level of Efficiency and Effectiveness
Statement 6.1. At our company, trust is a key attribute/component of the business model	1.00	1.00	3.00	5.00	3.00
Statement 6.2. At our company, trust shapes the business model.	1.00	1.00	5.00	3.00	3.00
Statement 6.3. At our company, trust positively affects other attributes/components of the business model	0.33	0.20	1.00	1.00	3.00
Statement 6.4. At our company, trust strengthens other components of the business model	0.20	0.33	1.00	1.00	3.00
Statement 6.5. At our company, thanks to trust embedded in the business model, we achieve a high level of efficiency and effectiveness	0.33	0.33	0.33	0.33	1.00

Source: own study.

Each of the matrices presented in Tables 9–14 was normalized and matrices were obtained, as shown in Tables 15–20 below. After adding up the data from the rows and dividing them by the number of sub-criteria present (i.e., five statements), the values of local weight were obtained, which were subsequently ranked.

**Table 15.** Normalized sub-criterion matrix for Criterion 1.

Normalized W-Matrix	Statement 1.1	Statement 1.2	Statement 1.3	Statement 1.4	Statement 1.5	Weights = Local Priorities	RANKING
Statement 1.1	0.11	0.10	0.13	0.12	0.08	0.11	4
Statement 1.2	0.56	0.52	0.65	0.36	0.38	0.49	1
Statement 1.3	0.11	0.10	0.13	0.36	0.23	0.19	2
Statement 1.4	0.11	0.17	0.04	0.12	0.23	0.14	3
Statement 1.5	0.11	0.10	0.04	0.04	0.08	0.07	5

Source: own study.

**Table 16.** Normalized sub-criterion matrix for Criterion 2.

Normalized W-matrix	Statement 2.1	Statement 2.2	Statement 2.3	Statement 2.4	Statement 2.5	Weights = Local Priorities	RANKING
Statement 2.1	0.18	0.29	0.18	0.29	0.14	0.22	2
Statement 2.2	0.04	0.06	0.04	0.03	0.14	0.06	5
Statement 2.3	0.18	0.29	0.18	0.29	0.14	0.22	2
Statement 2.4	0.06	0.18	0.06	0.10	0.14	0.11	4
Statement 2.5	0.54	0.18	0.54	0.29	0.43	0.40	1

Source: own study.

**Table 17.** Normalized sub-criterion matrix for Criterion 3.

Normalized W-Matrix	Statement 3.1	Statement 3.2	Statement 3.3	Statement 3.4	Statement 3.5	Weights = Local Priorities	RANKING
Statement 3.1	0.33	0.08	0.29	0.40	0.60	0.34	1
Statement 3.2	0.33	0.08	0.03	0.03	0.07	0.11	4
Statement 3.3	0.11	0.23	0.10	0.04	0.07	0.11	4
Statement 3.4	0.11	0.38	0.29	0.13	0.07	0.20	3
Statement 3.5	0.11	0.23	0.29	0.40	0.20	0.25	2

Source: own study.

**Table 18.** Normalized sub-criterion matrix for Criterion 4.

Normalized W-Matrix	Statement 4.1	Statement 4.2	Statement 4.3	Statement 4.4	Statement 4.5	Weights = Local Priorities	RANKING
Statement 4.1	0.48	0.29	0.29	0.54	0.65	0.45	1
Statement 4.2	0.16	0.10	0.18	0.06	0.04	0.11	4
Statement 4.3	0.10	0.03	0.06	0.04	0.04	0.05	5
Statement 4.4	0.16	0.29	0.29	0.18	0.13	0.21	2
Statement 4.5	0.10	0.29	0.18	0.18	0.13	0.17	3

Source: own study.

**Table 19.** Normalized sub-criterion matrix for Criterion 5.

Normalized W-Matrix	Statement 5.1	Statement 5.2	Statement 5.3	Statement 5.4	Statement 5.5	Weights = Local Priorities	RANKING
Statement 5.1	0.45	0.41	0.53	0.53	0.23	0.43	1
Statement 5.2	0.09	0.08	0.06	0.06	0.23	0.10	4
Statement 5.3	0.15	0.24	0.18	0.18	0.23	0.20	2
Statement 5.4	0.15	0.24	0.18	0.18	0.23	0.20	2
Statement 5.5	0.15	0.03	0.06	0.06	0.08	0.07	5

Source: own study.

**Table 20.** Normalized sub-criterion matrix for Criterion 6.

Normalized W-Matrix	Statement 6.1	Statement 6.2	Statement 6.3	Statement 6.4	Statement 6.5	Weights = Local Priorities	RANKING
Statement 6.1	0.35	0.35	0.29	0.48	0.23	0.34	1
Statement 6.2	0.35	0.35	0.48	0.29	0.23	0.34	1
Statement 6.3	0.12	0.07	0.10	0.10	0.23	0.12	3
Statement 6.4	0.07	0.12	0.10	0.10	0.23	0.12	3
Statement 6.5	0.12	0.12	0.03	0.03	0.08	0.07	5

Source: own study.

After ranking, Statement 1.2, “At our company, trust creates positive managerial intentions,” turned out to be the dominant sub-criterion (Table 15), obtaining a local weight of 0.49. Statement 1.3, “At our company, employees are characterized by honest and cooperative behavior based on the expressed norms and values,” was ranked second with a local weight of 0.19. Statement 1.5, “At our company, trust has a special impact on both strategic and tactical-operational behavior,” was at the bottom of the list with a local weight of only 0.07.

Among the sub-criteria of Criterion 2 (Table 16), Statement 2.5, “At our company, trust allows us to express the same values, which shape our social capital,” was ranked highest with a local weight of 0.40. It was followed by Statement 2.3: “At our company, trust is a key resource for building social capital” with a local weight of 0.22. Statement 2.2, “At our company, social capital is based on mutual trust between stakeholders,” was ranked fifth, with a local weight of 0.06.

As regards sub-criteria for Criterion 3 (Table 17.), Statement 3.1, “At our company, trust creates mutual relationships,” was ranked first, with a local weight of 0.34. Statement 3.5, “At our company, trust-based relationships allow us to implement common goals,” was also significant, with a local weight of 0.25. Statement 3.2, “At our company, trust improves communication between employees,” and Statement 3.3, “At our company, relationships allow us to apply the same norms of reciprocity,” were at the bottom of the ranking, both with a local weight of 0.11.

Among the sub-criteria of Criterion 4 (Table 18), the highest ranked was Statement 4.1: “At our company, trust triggers positive activities,” which obtained a local weight at the level of 0.45. Statement 4.4, “At our company, trust strengthens mutual cooperation both at the level of processes and activities,” was ranked second, with a local weight more than two times lower at 0.21. Statement 4.3, “At our company, trust enables more effective and efficient processes and activities,” was ranked last, with a local weight of only 0.05.

In the case of sub-criteria within Criterion 5 (Table 19), Statement 5.1, “At our company, trust is a factor limiting the risk of our operations,” was the most important, with a local weight of 0.43. It was followed by Statement 5.3 and Statement 5.4, which obtained the same local weight value of 0.20. The statements were, respectively: “At our company, thanks to mutual trust, there are no behaviors different from those expected,” and “At our company, confidence limits mutual distrust.” Statement

5.5, “At our company, the risk is mitigated, limited by mutual trust between employees,” was ranked lowest, with a local weight of 0.07.

As a result of the examination of the sub-criteria of Criterion 6 (Table 20), the most important statements turned out to be Statement 6.1 and Statement 6.2, which obtained an identical local weight value of 0.34 (“At our company, trust is a key attribute/component of the business model,” and “At our company, trust shapes the business model”). They were followed by Statements 6.3 and 6.4 with weights at the same level of 0.12 (“At our company, trust positively affects other attributes/components of the business model,” and “At our company, trust strengthens other components of the business model”). Statement 6.5, “At our company, thanks to trust embedded in the business model, we achieve a high level of efficiency and effectiveness,” was at the bottom of the ranking with a local weight of 0.07.

In order to verify the results obtained for the matrix normalized for sub-criteria, the values of the inconsistency index  $\lambda_{max}$ , the consistency ratio CR and the values of the random consistency index RI were calculated. The following results were obtained (Table 21):

**Table 21.** Values of the inconsistency index,  $\lambda_{max}$ , the consistency ratio, CR, and the values of the random consistency index RI for each criterion.

Criterion	Criterion1	Criterion2	Criterion3	Criterion4	Criterion5	Criterion6
$\lambda_{max}$	5.47	5.48	5.28	5.47	5.42	5.45
$n$	5	5	5	5	5	5
RI	1.12	1.12	1.12	1.12	1.12	1.12
CR	0.10	0.11	0.06	0.10	0.09	0.10

Source: own study.

The weight values obtained for each criterion and the local weights for sub-criteria are as follows (Table 22).

The total share is the result of multiplying the local weights of sub-criteria by the global weights of the criteria for which they occurred, which gave the global weights of the sub-criteria (Table 22). The assumption was that the above-percentages represented the ideal state, where trust is a key factor in shaping the business social model. Statement 1.2, “At our company, trust creates positive managerial intentions,” was the most important sub-criterion among all 30 sub-criteria, achieving a global weight of 0.14. It was followed by Statement 3.1, “At our company, trust creates mutual relationships,” with a global weight of 0.10. The statement 4.1, “At our company, trust triggers positive activities,” with a global weight of 0.08, was also significant. Important sub-criteria also include Statement 3.5, “At our company, trust-based relationships allow us to implement common goals,” with a global weight of 0.07.

**Table 22.** Matrix of local and global weights for criteria and sub-criteria for the issue of trust as a key factor in shaping the social business model of the company.

1. Trust-Based Organizational Behavior at the Company		2. Trust-Based Social Capital at the Company		3. Trust-Based Relationships at the Company		4. Trust-Based Processes and Activities at the Company		5. Trust-Based Risk at the Company		6. The Trust-Based Business Model at the Company	
Share in the group	Share in the total	Share in the group	Share in the total	Share in the group	Share in the total	Share in the group	Share in the total	Share in the group	Share in the total	Share in the group	Share in the total
0.28	0.07	0.28	0.10	0.17	0.08	0.13	0.05	0.07	0.05	0.07	0.02
Statement 1.1	Statement 2.1	Statement 3.1	Statement 4.1	Statement 5.1	Statement 6.1	Statement 5.1	Statement 6.1	Statement 5.1	Statement 6.1	Statement 6.1	Statement 6.1
0.49	0.14	0.06	0.03	0.11	0.02	0.10	0.01	0.10	0.01	0.10	0.02
Statement 1.2	Statement 2.2	Statement 3.2	Statement 4.2	Statement 5.2	Statement 6.2	Statement 5.2	Statement 6.2	Statement 5.2	Statement 6.2	Statement 6.2	Statement 6.2
0.19	0.05	0.22	0.02	0.05	0.01	0.20	0.02	0.20	0.02	0.20	0.01
Statement 1.3	Statement 2.3	Statement 3.3	Statement 4.3	Statement 5.3	Statement 6.3	Statement 5.3	Statement 6.3	Statement 5.3	Statement 6.3	Statement 6.3	Statement 6.3
0.14	0.04	0.11	0.01	0.21	0.04	0.20	0.02	0.20	0.02	0.20	0.01
Statement 1.4	Statement 2.4	Statement 3.4	Statement 4.4	Statement 5.4	Statement 6.4	Statement 5.4	Statement 6.4	Statement 5.4	Statement 6.4	Statement 6.4	Statement 6.4
0.07	0.02	0.40	0.03	0.17	0.03	0.07	0.01	0.07	0.01	0.07	0.01
Statement 1.5	Statement 2.5	Statement 3.5	Statement 4.5	Statement 5.5	Statement 6.5	Statement 5.5	Statement 6.5	Statement 5.5	Statement 6.5	Statement 6.5	Statement 6.5

Source: own study.



### 7.5. Analysis of Responses from Surveys Sent to Water Supply Companies

Having already defined criteria and sub-criteria, questionnaires in which the respondents had to refer to the statements were constructed and sent to the water supply companies. The scale of reference to given sub-criteria, which allowed respondents to assess consistency with the information on trust in their company, is presented in Table 23 below.

**Table 23.** The scale used to evaluate the company in terms of sub-criteria.

Scale	Statement
1	I strongly disagree
2	I somewhat disagree
3	I have no opinion
4	I somewhat agree
5	I strongly agree

Source: own study.

The sample used to collect the data set for the calculation was comprised of water supply companies. After collecting the data, i.e., ratings from surveys, calculations were made in order to obtain the appropriate global weights calculated for each company. After receiving the result for each criterion from the obtained ratings, considering previously calculated global weights, all results for a given company were added up. This combined result indicated the level of trust in a water supply company. In the case of an ideal company, the result would be 1.0. Maximum values in a given cell for a criterion are values of global weights calculated for six groups of criteria. Finally, the total results obtained were ranked and the ranking of water supply companies was obtained in terms of the level of trust. The following test results are presented in Table 24 below.

**Table 24.** The final matrix containing the results of the rating of companies in terms of social values together with the ranking.

Company	Criterion1	Criterion2	Criterion3	Criterion4	Criterion5	Criterion6	Total Result
The company with the highest result No. 1	0.28	0.07	0.25	0.17	0.13	0.06	0.96
The company with the highest result No. 2	0.27	0.06	0.27	0.15	0.11	0.07	0.94
The company with the lowest result	0.22	0.06	0.22	0.14	0.10	0.06	0.80

Source: own study.

The ratings within each group of criteria were also averaged (Table 25):

**Table 25.** The average values of the ratings obtained for each criterion along with the descriptions.

Criteria	Average Value of the Rating	Description Corresponding to the Rating
1. Trust-based organizational behavior at the company	4.4	I somewhat agree
2. Trust-based social capital at the company	4.6	I strongly agree
3. Trust-based relationships at the company	4.4	I somewhat agree
4. Trust-based processes and activities at the company	4.3	I somewhat agree
5. Trust-based risk at the company	4.0	I somewhat agree
6. The trust-based business model at the company	4.1	I somewhat agree

Source: own study.

This means that each criterion had an average rating above 4.0. The highest ranked statement in Criterion 2 was, “Trust-based social capital at the company,” which received a rating of 4.6; i.e., “I strongly agree.” The statement, “Trust-based risk at the company,” in Criterion 5 was rated the lowest; however, here the rating was also high. It is within the range covered by the answer, “I somewhat agree.”

The values of ratings obtained for individual statements from all questionnaires collected were averaged, which is presented as follows (Table 26):

**Table 26.** Average values of the declared ratings for each statement with the corresponding description.

	Statements	Average Value of the Rating	Description Corresponding to the Rating
1. Trust-based organizational behavior at the company	Statement 1.1. At our company, trust shapes positive organizational behavior	4.7	I strongly agree
	Statement 1.2. At our company, trust creates positive managerial intentions	4.7	I strongly agree
	Statement 1.3. At our company, employees are characterized by honest and cooperative behavior based on the expressed norms and values	4.1	I somewhat agree
	Statement 1.4. At our company, there is an appropriate climate of trust which shapes positive organizational behavior	4.3	I somewhat agree
	Statement 1.5. At our company, trust has a special impact on both strategic and tactical-operational behavior	4.3	I somewhat agree
2. Trust-based social capital at the company	Statement 2.1. At our company, trust positively affects the construction of social capital.	4.8	I strongly agree
	Statement 2.2. At our company, social capital is based on mutual trust between stakeholders.	4.7	I strongly agree
	Statement 2.3. At our company, trust is a key resource for building social capital.	4.7	I strongly agree
	Statement 2.4. At our company, trust positively affects the development of employees' social competences	4.5	I strongly agree
	Statement 2.5. At our company, trust allows us to express the same values, which shape our social capital.	4.5	I strongly agree
3. Trust-based relationships at the company	Statement 3.1. At our company, trust creates mutual relationships.	4.8	I strongly agree
	Statement 3.2. At our company, trust improves communication between employees	4.6	I strongly agree
	Statement 3.3. At our company, relationships allow us to apply the same norms of reciprocity	4.4	I somewhat agree
	Statement 3.4. At our company, there are continuous interaction and trust-based relationships between employees	4.0	I somewhat agree
	Statement 3.5. At our company, trust-based relationships allow us to implement common goals	4.3	I somewhat agree

Table 26. Cont.

	Statements	Average Value of the Rating	Description Corresponding to the Rating
4. Trust-based processes and activities at the company	Statement 4.1. At our company, trust triggers positive activities.	4.7	I strongly agree
	Statement 4.2. At our company, trust allows for less control of processes and activities.	3.8	I somewhat agree
	Statement 4.3. At our company, trust enables more effective and efficient processes and activities.	4.2	I somewhat agree
	Statement 4.4. At our company, trust strengthens mutual cooperation both at the level of processes and activities.	4.4	I somewhat agree
	Statement 4.5. At our company, mutual trust accelerates decision-making processes	4.5	I strongly agree
1. Trust-based risk at the company	Statement 5.1. At our company, trust is a factor which limits the risk of our activity.	4.0	I somewhat agree
	Statement 5.2. At our company, thanks to mutual trust, its reputation is improved.	4.7	I strongly agree
	Statement 5.3. At our company, thanks to mutual trust, there are no behaviors that are different from those expected.	3.7	I somewhat agree
	Statement 5.4. At our company, trust limits mutual distrust.	3.8	I somewhat agree
	Statement 5.5. At our company, the risk is mitigated, limited by mutual trust between employees.	3.9	I somewhat agree
6. The trust-based business model at the company	Statement 6.1. At our company, trust is a key attribute/component of the business model	3.7	I somewhat agree
	Statement 6.2. At our company, trust shapes the business model	3.5	I somewhat agree
	Statement 6.3. At our company, trust positively affects other attributes/components of the business model	4.4	I somewhat agree
	Statement 6.4. At our company, trust strengthens other components of the business model	4.4	I somewhat agree
	Statement 6.5. At our company, thanks to trust embedded in the business model, we achieve a high level of efficiency and effectiveness	4.3	I somewhat agree

Source: own study based on surveys conducted.

The above answers show that 18 statements were answered by the statement “I somewhat agree,” and 12 statements received a response of “I strongly agree.” In summary of the ratings of individual statements: they were below 4.0, but not lower than 3.5. The lowest-ranked statements were as follows (Table 27):

**Table 27.** Average values of declared ratings for each statement with the corresponding description—lowest values.

Criterion	Statement	Rating
6. The trust-based business model at the company	Statement 6.2. At our company, trust shapes the business model.	3.5
5. Trust-based risk at the company	Statement 5.3. At our company, thanks to mutual trust, there are no behaviors that are different from those expected.	3.7
6. The trust-based business model at the company	Statement 6.1. At our company, trust is a key attribute/component of the business model.	3.7
4. Trust-based processes and activities at the company	Statement 4.2. At our company, trust allows for less control of processes and activities.	3.8
5. Trust-based risk at the company	Statement 5.4. At our company, trust limits mutual distrust	3.8
5. Trust-based risk at the company	Statement 5.5. At our company, the risk is mitigated, limited by mutual trust between employees	3.9

Source: own study based on surveys conducted.

The highest-ranked statements were as follows (Table 28):

**Table 28.** Average values of declared ratings for each statement with the corresponding description—highest values.

Criterion	Statement	Rating
2. Trust-based social capital at the company	Statement 2.1. At our company, trust positively affects the construction of social capital.	4.8
3. Trust-based relationships at the company	Statement 3.1. At our company, trust creates mutual relationships.	4.8
1. Trust-based organizational behavior at the company	Statement 1.1. At our company, trust shapes positive organizational behavior	4.7
1. Trust-based organizational behavior at the company	Statement 1.2. At our company, trust creates positive managerial intentions	4.7
2. Trust-based social capital at the company	Statement 2.2. At our company, social capital is based on mutual trust between stakeholders	4.7
2. Trust-based social capital at the company	Statement 2.3. At our company, trust is a key resource for building social capital	4.7
4. Trust-based processes and activities at the company	Statement 4.1. At our company, trust triggers positive activities.	4.7
5. Trust-based risk at the company	Statement 5.2. At our company, thanks to mutual trust, its reputation is improved	4.7

Source: own study based on surveys conducted.

Due to the lack of significant deviations in the results obtained, it can be stated that the research conducted is a reliable sample which allowed for the obtainment of an image of the hierarchy of basic factors in building a trust-based water supply company.

The homogeneity of the scale was verified as well, thanks to Cronbach's alpha, a coefficient which says to what extent a set of variables is consistent. It takes values from [0; 1]. If all positions were perfectly reliable and measured the same thing, the coefficient  $\alpha = 1$ . In the case of  $\alpha > 0.7$ , the high reliability of the scale is demonstrated. Cronbach's alpha was estimated from the following formula:

$$\alpha = \frac{K}{K-1} \left( 1 - \frac{\sum_{i=1}^K \sigma_{\text{Statement } i}^2}{\sigma_{\text{set}}^2} \right)$$

where:

$K$ —number of statements;

Statement<sub>*i*</sub>—responses obtained for individual statements given by all companies;

$\sigma_{\text{Statement } i}^2$ —variance for the responses that were obtained for a given statement *i*;

$\sigma_{\text{set}}^2$ —variance from the sum of responses to all statements for individual companies.

Thus, the value of Cronbach's alpha was 0.85. The higher the value of the coefficient, the greater the reliability of the scale; therefore, the reliability of this study was very high. This means that there was a significant degree of similarity between individual responses, and the way in which individual responses were given was similar. Therefore, the statements examine a similar phenomenon, that is, the share of trust factors in water supply companies.

## 8. Discussion

When summarizing the research conducted, it should be noted that the aim of the analysis was the issue of trust as a key factor in shaping the social business model of the company. As part of the research, companies were asked to answer several questions related to the relationship between trust and the social business model of water supply companies. They included the following thematic areas:

- Trust-based organizational behavior at the company;
- Trust-based social capital at the company;
- Trust-based relationships at the company;
- Trust-based processes and activities at the company;
- Trust-based risk at the company;
- The trust-based business model at the company.

The research shows that an important element in using trust to build the social business models of water supply companies is organizational behaviors supported by social capital. In this approach, trust is mainly treated as a strategic resource for building social capital, and consequently, the social business model. When conducting a scientific discussion, it is worth paying attention to the complexity of this issue in the context of the results achieved by water supply companies. The hybrid nature of water supply companies indicates that it is necessary to constructively compare hard and soft factors that have an impact on building their social business models. Research findings confirm this interpretation of the discussion. In addition, it is important to properly configure these components for the consistency and scalability of the social business model. When analyzing scientific considerations synthetically, it is important to present the final interpretation of the results, which confirm the answers to the research questions posed. Based on the research results, key final conclusions can be formulated:

1. It can be assumed that trust itself is one of the important components of the business model, but other components have a strong impact in some cases (the result of the rating of the place and role of trust as a key component of the business model attribute is 3.7).
2. Due to the fact that it can be combined with other components, it expresses, among others, logical consistency with the social conditions of doing business (the result of the rating of trust as a factor that builds the social capital of an organization is 4.8).
3. In this context, trust supports the development of the organization's social capital and mutual business relationships (the result of the rating of trust as a factor which builds mutual relationships is 4.8).
4. Trust also supports the building of the organization's reputation and reduces its business risk (the result of the rating of trust as a factor which limits business risk is 3.9).
5. Trust also positively affects the activities of members of the organization and strongly affects the activity based on mutual cooperation (the result of the rating of trust as a factor which strongly affects activity is 3.8).

Such an analysis shows that trust is important in constructing the business model, but it cannot be separated from other components of the business model, between which cause-and-effect relationships occur. Thus, it is clear that the configuration approach of a business model along with its interfaces can be a platform for building trust-based social business models. The defined configuration of the business model, where trust is a model navigator, can work when building social business models. At the same time, it is worth adding that from this perspective, the consistency and scalability of this business model are important. Consistency ensures the appropriate use of individual components, thus creating a synergistic effect towards generating the maximum value of the business model. Moreover, scalability determines the use of this approach to create social and economic value.

To sum up, it is worth referring to the possible contribution of the article to the discipline of management sciences. The article pays special attention to embedding trust and its context in the construction and application of social business models. So far, trust has not been strongly emphasized as a component or attribute of a business model, especially from the configuration perspective. The place and role of trust in the social business model as a factor which determines the high performance of the organization, based on the case study of water supply companies, is also important. Trust then becomes an important element of the business model, which is also particularly important for ensuring business continuity while fulfilling economic and social requirements at the same time. Thus, by writing this article, the authors wished to add value to the identification, conceptualization, operationalization and implementation of trust-based social business models. In the relevant literature, the issues proposed are quite modest in such an approach. The value of creative input is related to the presentation of a comprehensive view of trust as a component of the social business model that ensures the high performance of water supply companies. The authors would like to draw attention to the need to build a new approach and a broader understanding of trust in the theory of business models, and to present utilitarian solutions that may act as a guide for managers interested in improving the performance of water supply companies.

## **9. Conclusions**

It can be assumed that the purpose of the article was achieved, because the study provided an answer to the question of which factors, divided into different categories, are important in building a trust-based water supply company. Due to the lack of significant deviations in the results obtained, it can be stated that the research conducted is a reliable sample which allowed for the obtainment of an image of the hierarchy of basic factors in building a trust-based water supply company.

In light of the above discussion, the authors formulated the following research conclusions:

1. By undertaking a comparative analysis according to individual factors, it was found that in the ranking of given criteria along with global weights, Criterion1: Trust-based organizational behaviors at the company and Criterion3: Trust-based relationships at the company, received the strongest weight. This means that trust is strongly related to organizational behaviors and relationships.
2. It can be assumed that the trust-based social business model should be supported by proper organizational behavior and efficient and effective relationships with water supply company stakeholders.
3. As regards the normalized sub-criterion matrix for Criterion 1, Statement 1.2, "At our company, trust creates positive managerial intentions," is the most important.
4. As regards the normalized sub-criterion matrix for Criterion 1, Statement 2.5, "At our company, trust allows us to express the same values, which shape our social capital," is the most important.
5. As regards the normalized sub-criterion matrix for Criterion 3, Statement 3.1, "At our company, trust creates mutual relationships," is the most important.
6. As regards the normalized sub-criterion matrix for Criterion 4, Statement 4.1, "At our company, trust triggers positive activities," is the most important.

7. As regards the normalized sub-criterion matrix for Criterion 5, Statement 5.1, “At our company, trust is a factor which limits the risk of our activity,” is the most important.
8. As regards the normalized sub-criterion matrix for Criterion 6, Statement 6.1, “At our company, trust is a key attribute/component of the business model,” and Statement 6.2, “At our company, trust shapes the business model,” are the most important.

When making inferences about points 1–8, strategic recommendations for building a trust-based social business model can be formulated. It can be built in such a way since research results confirm that trust shapes the business model and is a key attribute/component thereof. At the same time, the social business model should be based on appropriate organizational behaviors and appropriate relationships. Building positive managerial intentions and expressing the same values based on social capital is also important in building a social business model. At the same time, trust is a factor which limits the risk of a water supply company’s operation. In terms of application, such a structure allows for practical applications in the context of the conceptualization and operationalization of the social business models of water supply companies.

The authors present general conclusions which summarize the issue of building and applying the trust-based social business models of water supply companies.

1. The social business model is a key ontological entity for the achievement of high performance by water supply companies.
2. The social business model of water supply companies should be built in such a way that trust is its key attribute.
3. The social business model of water supply companies should be conceptualized and operationalized by means of various approaches related to the hybrid nature of this type of organization.
4. The social business model of water supply companies should be supported by proper relationships with stakeholders and their appropriate organizational behavior.
5. The social business model of water supply companies should be strongly supported by the positive intentions of their managers.
6. The social business model of water supply companies should direct the management stream towards the expression of the same values that shape their social capital.
7. The social business model of water supply companies should use trust as a factor which limits the risk of running the business.

From this perspective, it can be assumed that trust is the focal point of the social business model of a water supply company, where the business model itself is a kind of configuration of its strategic components. The relationship between trust and other components of the business model is of particular importance for decision-making processes aimed at meeting social and economic needs with a hybrid character. At the same time, trust becomes a platform for dialogue with various stakeholders of a water supply company in both the product and organizational spheres. In addition, the relational nature of trust also affects the construction of the water company’s strategy. On the one hand, trust also reduces the business risk of a water supply company, and on the other hand, it enables the exchange of values generated by the organization. Moreover, if one refers to the principles of assessing the impact of a water company business model on society, it seems logical that the impact itself could be measured by trust-building mechanisms between the company’s stakeholders. The adopted logic of the conducted scientific argument indicates that trust and its place and role in the social business model of a water supply company have a significant impact on the social and economic performances of the water supply company, and as a consequence, on increased social responsibility towards stakeholders as well. Trust even stabilizes the organization and its business model; it is also a value catalyst and neutralizes the potentially negative impacts of the organization on other entities gathered around it. Trust as a stabilizer can also affect the consistency and scalability of the social business model of a water supply

company. When analyzing the conclusions, it should also be noted that there is potential in these management areas for the further development of water supply companies. Water supply companies should intensify their efforts to improve the place and role of trust as an important component of their social business models. They should set strategic goals in this area and pursue them consistently. They should treat trust on the one hand as an attribute of the business model, and on the other hand as a key factor of their success as well, especially in terms of relationships with various stakeholders.

To sum up, in the face of changes regarding both the logic of the functioning of companies and the very construction of business models, trust may become, to some extent, a platform that neutralizes the possible oppositional behavior of the supporters of the theory of creating economic value, compared to the supporters of creating only social value. This specific balance of organizational goals and behavior is extremely necessary and advisable. Trust is a kind of neutralizer of potential mutual conflicts between the stakeholders of water supply companies, who may have different needs and expectations of the organization. Finally, trust becomes a strong link in the priority business model. It is as a social component of the business model that relationships and interfaces are created in the very structure of the business model. Therefore, it can be said that trust in the social business model is a strategic, hard component, which strongly affects other components. This strategic character is reflected in its strong impact on the high performance of water supply companies.

## 10. Limitations and Suggestions for Future Research

The authors are fully aware of the limitations resulting from the research. They result, among others, from the fact that the research was conducted in one region, albeit a very large one, as opposed to throughout the country. In addition, it is worth noting that a limitation may be the question of how different recipients understand both the concept of trust, which has been demonstrated in the critical review of the literature, and difficulties in interpretation related to the concept of social business models. As regards suggestions for future research, the authors hope that this research will open the way to further discussion on the place and role of trust in shaping the social business models of water supply companies. It is also important to understand and study the hybrid image of water supply companies, which is not an easy and unambiguously interpreted issue, as this hybridism strongly emphasizes the social character of these organizations.

**Author Contributions:** Conceptualization, A.J. and M.J.; methodology, M.J.; formal analysis, A.J.; investigation, A.J. and M.J.; data curation, A.J. and M.J.; writing—original draft preparation, M.J.; writing—review and editing, A.J.; visualization, A.J. and M.J.

**Funding:** This research received no external funding.

**Conflicts of Interest:** The authors declare no conflict of interest.

## References

1. Trust in Google. Available online: [https://www.google.pl/search?ei=1XALXe6KBNKtrgTdxKWIBg&q=Trust&oq=Trust&gs\\_l=psy-ab.3..35i39l2j0i67l4j0j0i67l2j0.163526.166137..167198...1.0..3.134.1707.6j10.....0...1.gws-wiz.....6..0i71j0i131j0i131i67.WFYiOGDZeC4](https://www.google.pl/search?ei=1XALXe6KBNKtrgTdxKWIBg&q=Trust&oq=Trust&gs_l=psy-ab.3..35i39l2j0i67l4j0j0i67l2j0.163526.166137..167198...1.0..3.134.1707.6j10.....0...1.gws-wiz.....6..0i71j0i131j0i131i67.WFYiOGDZeC4) (accessed on 20 June 2019).
2. Scopus—Website. Available online: <https://www.elsevier.com/pl-pl/solutions/scopus> (accessed on 20 June 2019).
3. ProQuest—Website. Available online: <https://www.proquest.com/about/who-we-are.html> (accessed on 20 June 2019).
4. ProQuest Database. Available online: <https://www.proquest.com/about/who-we-are.html> (accessed on 20 June 2019).
5. Scopus Database. Available online: <https://www.elsevier.com/pl-pl/solutions/scopus> (accessed on 20 June 2019).
6. Rowley, J.; Slack, F. Conducting a literature review. *Manag. Res. News* **2004**, *27*, 31–39. [CrossRef]
7. Levy, Y.; Ellis, T.J. A Systems Approach to Conduct an Effective Literature Review in Support of Information Systems Research. *Inf. Sci. J.* **2006**, *9*, 181–212. [CrossRef]



8. Sekaran, U.; Bougie, R. *Research Methods for Business. A Skill-Building Approach*; John Wiley & Sons Ltd.: West Sussex, UK, 2010; pp. 38–43.
9. Czakon, W. Metodyka systematycznego przeglądu literatury. *Przegląd Organizacji* **2011**, *3*, 57–61.
10. Giddens, A. *Europa w Epoce Globalnej*; Wydawnictwo Naukowe PWN: Warszawa, Poland, 2009.
11. Coleman, J.S. *Foundations of Social Theory*; Harvard University Press: Cambridge, MA, USA, 1990.
12. Inglehart, R. Trust, well-being and democracy. In *Democracy and Trust*; Warren, M.E., Ed.; Cambridge University Press: Cambridge, MA, USA, 1999.
13. Morgan, R.M.; Hunt, S.D. The commitment-trust theory of relationship marketing. *J. Mark.* **1994**, *58*, 20–38. [[CrossRef](#)]
14. Babbie, E. *Podstawy Badań Społecznych*; PWN: Warszawa, Poland, 2008; p. 150.
15. Bachmann, R. Trust, power and control in intra organizational relations. *Organ. Stud.* **2001**, *22*, 337–365. [[CrossRef](#)]
16. Stein, S.M.; Harper, T.L. Power, trust, and planning. *J. Plan. Educ. Res.* **2003**, *23*, 125–139. [[CrossRef](#)]
17. Kamal, P.; Chen, J.Q. Trust in sharing economy. In Proceedings of the 20th Pacific Asia Conference on Information Systems, Chiayi, Taiwan, 27 June–1 July 2016.
18. Paliszkievicz, J.O. Organizational Trust: A Critical Review of the Empirical Research. Paper Presented at the 2010 International Conference on Technology Innovation and Industrial Management, Pattaya, Thailand, 16–18 June 2010.
19. Porras, S.T. Trust as Networking Knowledge: Precedents from Australia. *Asia Pac. J. Manag.* **2004**, *21*, 345–363. [[CrossRef](#)]
20. Lewicki, R.J.; Bunker, B.B. Developing and Maintaining Trust in Work Relationships. In *Trust in Organizations*; Kramer, R.M., Tyler, T.R., Eds.; Frontiers of Theory and Research; Sage: Thousand Oaks, CA, USA, 1996; pp. 114–139.
21. Wallenburg, C.M.; Schäffler, T. The interplay of relational governance and formal control in horizontal alliances: A social contract perspective. *J. Supply Chain Manag.* **2014**, *50*, 41–58. [[CrossRef](#)]
22. Cook, J.; Wall, T. New Work Attitude Measures of Trust, Organizational Commitment and Personal Need Non-Fulfilment. *J. Occup. Psychol.* **1980**, *53*, 39–52. [[CrossRef](#)]
23. Sabel, C.F. Studied Trust: Building New Forms of Cooperation in a Volatile Economy. *Hum. Relat.* **1993**, *46*, 1133–1170. [[CrossRef](#)]
24. Schoorman, F.; Mayer, R.; Davis, J. An integrative model of organizational trust: Past, present, and future. *Acad. Manag. Rev.* **2007**, *32*, 344–354. [[CrossRef](#)]
25. Fukuyama, F. *Zaufanie. Kapitał Społeczny a Droga do Dobrobytu*; Wydawnictwo Naukowe PWN: Warszawa, Poland, 1997.
26. McKnight, D.H.; Chervany, N.L. Trust and Distrust Definitions: One Bite at a Time. In *Trust in Cyber-Societies*; Falcone, R., Singh, M., Tan, Y.-H., Eds.; Springer: Berlin/Heidelberg, Germany, 2001; p. 28.
27. Baier, A. Trust and Antitrust. *Ethics* **1986**, *96*, 231–260. [[CrossRef](#)]
28. Bachmann, R. Conclusion: Trust—Conceptual Aspects of a Complex Phenomenon. In *Trust within and between Organizations: Conceptual Issues and Empirical Applications*; Lane, C., Bachmann, R., Eds.; Oxford University Press: Oxford, UK, 2000; pp. 298–322.
29. McEvily, B.; Perrone, V.; Zaheer, A. Trust as an Organizing Principle. *Organ. Sci.* **2003**, *14*, 91–103. [[CrossRef](#)]
30. Weber, J.M.; Malhotra, D.; Murnighan, J.K. Normal acts of irrational trust: Motivated attributions and the trust development process. *Res. Organ. Behav.* **2004**, *26*, 75–101. [[CrossRef](#)]
31. Robbins, S.P.; DeCenzo, D.A. *Podstawy Zarządzania*; PWE: Warszawa, Poland, 2002.
32. Busch, S.J.; Hantusch, N. I don't trust you, but why don't you trust me? *Disput. Resolut. J.* **2000**, *55*, 3.
33. Gilson, L. Trust and the Development of Health Care as a Social Institution. *Soc. Sci. Med.* **2003**, *56*, 1453–1468. [[CrossRef](#)]
34. Ellonen, R.; Blomqvist, K.; Puumalainen, K. The Role of Trust in Organisational Innovativeness. *Eur. J. Innov. Manag.* **2008**, *11*, 160–181. [[CrossRef](#)]
35. Sitkin, S.B.; Roth, N.L. Explaining the Limited Effectiveness of Legalistic “Remedies” for Trust/Distrust. *Organ. Sci.* **1993**, *4*, 367–392. [[CrossRef](#)]
36. Hoe, S.L. Shared Vision: A Development Tool for Organizational Learning. *Dev. Learn. Organ. Int. J.* **2007**, *21*, 12–13.
37. Simmel, G. *Socjologia*; PWN: Warszawa, Poland, 1975.

38. Hardin, R. Trust in government. In *Trust and Governance*; Braithwaite, V., Levi, M., Eds.; Russell Sage Foundation: New York, NY, USA, 1988.
39. Putnam, R.D. *Demokracja w Działaniu. Tradycje Obywatelskie we Współczesnych Włoszech*; Społeczny Instytut Wydawniczy Znak: Kraków, Poland, 1995.
40. Inglehart, R. *Modernization and Postmodernization. Cultural, Economic and Political Change in 43 Societies*; Princeton University Press: Princeton, NJ, USA, 1997.
41. Williams, B. Formal structures and social reality. Trust: Making and breaking cooperative relations. In *Trust: Making and Breaking Cooperative Relations, Electronic Edition*; Gambetta, D., Ed.; Department of Sociology, University of Oxford Press: Oxford, UK, 2000.
42. Putnam, R.D. *Bowling alone: The Collapse and Revival of American Community*; Simon & Schuster: New York, NY, USA, 2000.
43. Szreter, S.; Woolcoc, M. Heath by Association? Social Capital, Social Theory, and the Political Economy of Public Health. *Int. Epidemiol. Assoc.* **2004**, *33*, 650–667. [\[CrossRef\]](#)
44. Giddens, A. *Europe in the Global Age*; Polity Press: Cambridge, UK, 2006.
45. Botsman, R.; Rogers, R. *What's Mine Is Yours. The Rise of Collaborative Consumption*; Harper Business: New York, NY, USA, 2010.
46. Tanz, J. How Airbnb and Lyft Finally Got Americans to Trust Each Other. 2014. Available online: <https://www.wired.com/2014/04/trust-in-the-share-economy/> (accessed on 23 January 2017).
47. Grabner-Kräuter, S.; Kaluscha, E.A. Consumer trust in electronic commerce: Conceptualization and classification of trust building measures. In *Trust and New Technologies: Marketing and Management on the Internet and Mobile Media*; du Preez, M., Ed.; Emerald Group Publishing Limited: Bingley, UK, 2009.
48. Rifkin, J. *Spółczesność Zerowych Kosztów Krańcowych. Internet Przedmiotów. Ekonomia Współdzielenia. Zmierzch Kapitalizmu*; Studio Emka: Warszawa, Poland, 2016.
49. Mazzella, F.; Sundararajan, A. Entering the Trust Age, BlaBlaCar. 2016. Available online: <https://www.blablacar.com/wp-content/uploads/2016/05/entering-the-trust-age.pdf> (accessed on 28 January 2017).
50. Search results phrase “Business Model” in Google. Available online: [https://www.google.pl/search?source=hp&ei=znALXYGWGLL1qwHjnb\\_ACw&q=Business+Model&oq=Business+Model&gs\\_l=psy-ab.3..35i39j0l9.1325.4910..6085..0.0..0.350.2283.0j14j0j1.....0....1..gws-wiz.....0..0i131j0i10.1t5EHjtTluw](https://www.google.pl/search?source=hp&ei=znALXYGWGLL1qwHjnb_ACw&q=Business+Model&oq=Business+Model&gs_l=psy-ab.3..35i39j0l9.1325.4910..6085..0.0..0.350.2283.0j14j0j1.....0....1..gws-wiz.....0..0i131j0i10.1t5EHjtTluw) (accessed on 20 June 2019).
51. Timmers, P. Business models for electronic markets. *Electron. Mark.* **1998**, *8*, 3–8. [\[CrossRef\]](#)
52. Amit, R.; Zott, C. Value creation in E-business. *Strateg. Manag. J.* **2001**, *22*, 493–520. [\[CrossRef\]](#)
53. Chesbrough, H.; Rosenbloom, R.S. The role of the business model in capturing value from innovation: Evidence from Xerox Corporation’s technology spin-off companies. *Ind. Corps Chang.* **2002**, *11*, 529–555. [\[CrossRef\]](#)
54. Casadesus-Masanell, R.; Ricart, J.E. From strategy to business models and onto tactics. *Long Range Plan.* **2010**, *43*. [\[CrossRef\]](#)
55. Wirtz, B.W.; Pistoia, A.; Ullrich, S.; Gittel, V. Business models: Origin, development and future research. *Long Range Plan.* **2016**, *49*, 36–54. [\[CrossRef\]](#)
56. Gassmann, O.; Frankenberger, K.; Csik, M. *Nawigator Modelu Biznesowego, 55 Modeli, które zrewolucjonizują Twój biznes*; Helion: Gliwice, Poland, 2017; pp. 22–23.
57. Zu Knyphausen-Aufseß, D.; Meinhardt, Y. Revisiting Strategy: Ein Ansatz zur Systematisierung von Geschäftsmodellen. In *Zukünftige Geschäftsmodelle*; Bieger, T., Bickhoff, N., Caspers, R., Knyphausen-Aufseß, D.Z., Reding, K., Eds.; Springer: Berlin/Heidelberg, Germany, 2002.
58. Magretta, J. Why business models matter. *Harv. Bus. Rev.* **2002**, *80*, 86–92.
59. Morris, M.; Schindehutte, M.; Allen, J. The entrepreneur’s business model: Toward a unified perspective. *J. Bus. Res.* **2005**, *58*, 726–735. [\[CrossRef\]](#)
60. Baden-Fuller, C.; Morgan, M.S. Business models as models. *Long Range Plan.* **2010**, *43*, 151–171. [\[CrossRef\]](#)
61. Osterwalder, A.; Pigneur, Y. *Business Model Generation*; Wiley & Sons: Hoboken, NJ, USA, 2010.
62. Demil, B.; Lecocq, X. Business model evolution: In search of dynamic consistency. *Long Range Plan.* **2010**, *43*, 227–246. [\[CrossRef\]](#)
63. Teece, D.J. Business models, business strategy and innovation. *Long Range Plan.* **2010**, *43*, 172–194. [\[CrossRef\]](#)
64. Beattie, V.; Smith, S.J. Value creation and business models: Refocusing the intellectual capital debate. *Br. Account. Rev.* **2013**, *45*, 243–254. [\[CrossRef\]](#)

65. Wells, P. Economies of scale versus small is beautiful: A business model approach based on architecture, principles and components in the beer industry. *Organ. Environ.* **2016**, *29*, 36–52. [[CrossRef](#)]
66. Massa, L.; Tucci, C.; Afuah, A. A critical assessment of business model research. *Acad. Manag. Ann.* **2017**, *11*, 73–104. [[CrossRef](#)]
67. Zott, C.; Amit, R. Business model design: An activity system perspective. *Long Range Plan.* **2010**, *43*, 216–226. [[CrossRef](#)]
68. Aspara, J.; Lamberg, J.-A.; Laukia, A.; Tikkanen, H. Corporate business model transformation and interorganisational cognition: The case of Nokia. *Long Range Plan.* **2013**, *46*, 459–474. [[CrossRef](#)]
69. Aspara, J.; Hietanen, J.; Tikkanen, H. Business model innovation vs. replication: Financial performance implications of strategic emphases. *J. Strateg. Mark.* **2010**, *18*, 39–56. [[CrossRef](#)]
70. Lundgren, A. *Technological Innovation and Network Evolution*; Routledge: London, UK, 1995.
71. Nogalski, B.; Szpitter, A.A.; Jabłoński, M. *Zarządzanie Projektami w Kształtowaniu Elastycznych Modeli Biznesu Operatorów Systemu Dystrybucyjnego*; Wydawnictwo Uniwersytetu Gdańskiego: Gdańsk, Poland, 2016; pp. 35, 99.
72. Aversa, P.; Haefliger, S.; Rossi, A.; Baden-Fuller, C. From business model to business modelling: Modularity and manipulation. *Bus. Models Model. Adv. Strateg. Manag.* **2015**, *33*, 151–185.
73. Finnie, W.C. Leading the revolution: An interview with Gary Hamel. *Strategy Leadersh.* **2000**, *29*, 4–10. [[CrossRef](#)]
74. Hawkins, R. The phantom of the marketplace: Searching for new e-commerce business models. *Commun. Strategy* **2002**, *46*, 297–329.
75. Mangematin, V.; Lemarie, S.; Boissin, J. Development of SMEs and heterogeneity of trajectories: The case of biotechnology in France. *Res. Policy* **2003**, *32*, 621–638. [[CrossRef](#)]
76. Mitchell, D.; Coles, C. The ultimate competitive advantage of continuing business model innovation. *J. Bus. Strategy* **2003**, *24*, 15–21. [[CrossRef](#)]
77. Pateli, A.G.; Giaglis, G.M. A research framework for analysing eBusiness models. *Eur. J. Inf. Syst.* **2004**, *13*, 302–314. [[CrossRef](#)]
78. Rappa, M.A. The utility business model and the future of computing services. *IBM Syst. J.* **2004**, *43*, 32–42. [[CrossRef](#)]
79. Downing, S. The social construction of entrepreneurship: Narrative and dramatic processes in the coproduction of organizations and identities. *Entrep. Theory Pract.* **2005**, *29*, 185–204. [[CrossRef](#)]
80. Johnson, M.W.; Christensen, C.M.; Kagermann, H. Reinventing your business model. (cover story). *Harv. Bus. Rev.* **2008**, *86*, 50–59.
81. Richardson, J. The business model: An integrative framework for strategy execution. *Strateg. Chang.* **2008**, *17*, 133–144. [[CrossRef](#)]
82. Zott, C.; Amit, R. The fit between product market strategy and business model: Implications for firm performance. *Strateg. Manag. J.* **2008**, *29*, 1–26. [[CrossRef](#)]
83. Doganova, L.; Eyquem-Renault, M. What do business models do? Innovation devices in technology entrepreneurship. *Res. Policy* **2009**, *38*, 1559–1570. [[CrossRef](#)]
84. Dahan, N.; Doh, J.; Oetzel, J.; Yaziji, M. Corporate-NGO collaboration: Cocreating new business models for developing markets. *Long Range Plan.* **2010**, *43*, 326–342. [[CrossRef](#)]
85. Svejenova, S.; Planellas, M.; Vives, L. An individual business model in the making: A chef's quest for creative freedom. *Long Range Plan.* **2010**, *43*, 408–430. [[CrossRef](#)]
86. Weiner, N.; Renner, T.; Kett, H. *Geschäftsmodelle im Internet der Dienste: Aktueller Stand in Forschung und Praxis*; Fraunhofer IAO: Stuttgart, Germany, 2010.
87. Wirtz, B.; Schilke, O.; Ullrich, S. Strategic development of business models: Implications of the Web 2.0 for creating value on the internet. *Long Range Plan.* **2010**, *43*, 272–290. [[CrossRef](#)]
88. Yunus, M.; Moingeon, B.; Lehmann-Ortega, L. Building social business models: Lessons from the Grameen experience. *Long. Range Plan.* **2010**, *43*, 308–325. [[CrossRef](#)]
89. Bieger, T.; Krys, C. Das wertbasierte geschäftsmodell—Ein aktualisierter strukturierungsansatz. In *Innovative Geschäftsmodell*; Bieger, T., Knyphausen-Aufseß, D., Krys, C., Eds.; Springer: Berlin, Germany, 2011.
90. Evans, S.; Rana, P.; Short, S.W. *State-of-Practice in Business Modelling and Value-Networks, Emphasising Potential Future Models That Could Deliver Sustainable Value*; University of Cambridge: Cambridge, UK, 2012.

91. Schallmo, D. *Geschäftsmodell-Innovation: Grundlagen, Bestehende Ansätze, Methodisches Vorgehen und B2B-Geschäftsmodelle*; Springer Fachmedien: Wiesbaden, Germany, 2013. [CrossRef]
92. Skarzynski, P.; Gibson, R. *Innovation to the Core: A Blueprint for Transforming the Way Your Company Innovates*. Harvard Business Press: Boston, MA, USA, 2013.
93. Geissdoerfer, M.; Bocken, N.M.P.; Hultink, E.J. Design thinking to enhance the sustainable business modelling process. *J. Clean. Prod.* **2016**, *135*, 1218–1232. [CrossRef]
94. Jabłoński, A.; Jabłoński, M. *Modele Biznesu, Perspektywy Rozwoju—Ujęcie Konceptyjne*; CeDeWu: Warszawa, Poland, 2019; pp. 43–48.
95. Michalak, J. *Modele Biznesu Przedsiębiorstw, Analiza i Raportowanie*; Akademia Zarządzania i Finansów, Wydawnictwo Uniwersytetu Łódzkiego: Łódź, Poland, 2016; p. 18.
96. Nogalski, B.; Szpitter, A.A.; Brzóska, J. *Modele i Strategie Biznesu w Obszarze Dystrybucji Energii Elektrycznej w Polsce*; Wydawnictwo Uniwersytetu Gdańskiego: Gdańsk, Poland, 2017; p. 27.
97. Gorevaya, E.; Khayrullina, M. Evolution of Business Models: Past and Present Trends. *Procedia Econ. Financ.* **2015**, *27*, 344–350. [CrossRef]
98. Yunus, M. *Creating a World without Poverty: Social Business and the Future of Capitalism*; Public Affairs: New York, NY, USA, 2007.
99. Nicholls, A. (Ed.) *Social Entrepreneurship. New Models of Sustainable Social Change*; Oxford University Press: Oxford, UK, 2006.
100. Roh, T.H. The sharing economy: Business cases of social enterprises using collaborative networks, Information Technology and Quantitative Management (ITQM). *Procedia Comput. Sci.* **2016**, *91*, 502–511. [CrossRef]
101. Bocken, N.M.P.; Short, S.W.; Rana, P.; Evans, S. A literature and practice review to develop sustainable business model archetypes. *J. Clean. Prod.* **2014**, *65*, 42–56. [CrossRef]
102. Spieth, P.; Schneider, S.; Clauß, T.; Eichenberg, D. Value drivers of social businesses: A business model perspective. *Long Range Plan.* **2018**. [CrossRef]
103. Koźuch, B.; Jabłoński, A. The Strategic Hybrids of Water Supply Companies as an Effective Management Tool. *Sustainability* **2018**, *10*, 4450. [CrossRef]
104. Wilson, F.; Post, J.E. Business models for people, planet (& profits): Exploring the phenomena of social business, a market-based approach to social value creation. *Small Bus. Econ.* **2013**, *40*, 715–737.
105. Dohrmann, S.; Raith, M.; Siebold, N. Monetizing Social Value Creation—A Business Model Approach. *Entrep. Res. J.* **2015**, *5*, 127–154. [CrossRef]
106. Website Virtue Ventures. Available online: [www.virtueventures.com](http://www.virtueventures.com) in Alter (accessed on 28 January 2007).
107. Bocken, N.M.P.; Fil, A.; Prabhu, J. Scaling up social businesses in developing markets. *J. Clean. Prod.* **2016**, *139*, 295–308. [CrossRef]
108. Neumeyer, X.; Santos, S.C. Sustainable business models, venture typologies, and entrepreneurial ecosystems: A social network perspective. *J. Clean. Prod.* **2018**, *172*, 4565–4579. [CrossRef]
109. Battilana, J.; Lee, M. Advancing research on hybrid organizing insights from the study of social enterprises. *Acad. Manag. Ann.* **2014**, *8*, 397–441. [CrossRef]
110. Schaltegger, S.; Lüdeke-Freund, F.; Hansen, E.G. Business models for sustainability: A co-evolutionary analysis of sustainable entrepreneurship, innovation, and transformation. *Organ. Environ.* **2016**, *29*, 264–289. [CrossRef]
111. Jabłoński, A. Scalability of Sustainable Business Models in Hybrid Organizations. *Sustainability* **2016**, *8*, 194. [CrossRef]
112. Saaty, T.L. *Fundamentals of Decision Making and Priority Theory with the Analytic Hierarchy Process*; RWS Publications: Pittsburgh, PA, USA, 1994.
113. Saaty, T.L. *Decision Making with Dependence and Feedback: The Analytic Network Process*; RWS Publications: Pittsburgh, PA, USA, 1996.



Article

# The Mechanisms of Creating Value vs. Financial Security of Going Concern—Sustainable Management

Jarosław Kaczmarek

Department of Economics and Organization of Enterprises; Faculty of Management; Cracow University of Economics, 27 Rakowicka St., 31–510 Cracow, Poland; kaczmaj@uek.krakow.pl

Received: 9 March 2019; Accepted: 11 April 2019; Published: 16 April 2019

**Abstract:** The subject of this research study is the quantification of corporate value creation in relation to the level of the financial security of a company's functioning. The research aims to compare the two mechanisms. Assessments concern the degree of the balancing of effects in the context of value creation and financial security sustainable management. The analysed entities comprise all the manufacturing enterprises in Poland in 2007–2018, included in public statistical data. In light of the above, the study is unique in character, comprising the broadest possible range of entities. The results support the main hypothesis—which is subordinated to the study's adopted main target—as well as five sub-hypotheses. The study employs a multifaceted logit model of financial security, and the multifaceted value measure. The paper examines value drivers as well as financial security explanatory variables. The study makes use of cause and effect analysis, object relocation analysis and an analysis of the variability and clustering of objects. On the basis of the detailed research findings, the following rule was demonstrated: there is a directly proportional relationship between the effects of the value creation process and the ensuring of financial security in manufacturing enterprises (compliance with the sustainable management principle).

**Keywords:** value creation; value-based management; financial security of going concern; sustainable management

---

## 1. Introduction

The subject of the paper is the quantification of corporate value creation in relation to the level of the financial security of corporate functioning—the balancing and assessment of the effects of value creation and financial security sustainable management.

The measurement (quantification) is carried out in the context of a company's financial performance: (1) its development, measured by two value creation processes—(a) for shareholders (internal value created), and (b) value added transferred to an economic system (external value created), which is close to the understanding of stakeholder value; and (2) financial security of going concern, assessed from the perspective of the threat of business failure.

The adoption of the financial perspective to assess the balanced effects of value creation and financial security of a going concern as the result of applying sustainable management is epistemologically justified. The article regards the achievement of a company's financial goals as the foundation of its existence. Benefits resulting from sustainable development and management are defined in various ways, but their key financial effects are the same—margin improvement, or revenue increase. These lead to gaining competitive advantage, and, consequently, to premium profits and sustainable value creation. It implies that the financial measures of creating this value provide a financial justification for adopting a sustainable development strategy and its implementation in the form of sustainable management.

The study analyses manufacturing enterprises in Poland—the entire population included in public statistics (being non-financial companies with more than 9 employees, included in statistical reporting, classified as a production activity, section C—Manufacturing. As at the end of the first half of 2018, this was 13,006 entities). The major empirical objective of the study is a comparative assessment of the two categories in manufacturing enterprises in 2007–2018, including:

- measurement and assessment of value creation and the degree of financial security,
- identification of the characteristics of the analysed population of companies, the classification of companies and a comparative analysis of profiles.

The assessment of the degree of threat is based on the multifaceted logit model, which reflects the likelihood of maintaining financial security (FSD) for a period of one year. The value creation mechanism is quantified using value drivers constituting MVM—the multifaceted value measure (the range of value measures is taken from the available data in public statistics).

The ordering and classification are based on the ranking and the variation measure, as well as normative patterns (also for the purpose of assessing the profiles of the analysed structures).

The following hypotheses will be investigated:

*main hypothesis:*

**Hypothesis 0.** *there is a directly proportional relationship between the effects of the value creation process and the ensuring of financial security in manufacturing enterprises—the confirmation of the principle of sustainable management,*

*partial hypotheses:*

**Hypothesis 1.** *The development of manufacturing enterprises, assessed on the basis of value creation, is marked by recurring cycles which are consistent with the factors which affect them,*

**Hypothesis 2.** *The value accruing to the owners is the main determinant of value creation, accompanied by an increased transmission of value to an economic system,*

**Hypothesis 3.** *Changes in financial security occur in recurring cycles, and are contrary to the level of its variation,*

**Hypothesis 4.** *The distribution of financial security determinants changes over time, with the lowest impact of asset productivity (capital circulation),*

**Hypothesis 5.** *The compatibility of the profile patterns of manufacturing enterprises' microstructures in the context of value creation and financial security is not strongly opposed to their considerable diversity.*

The results of the verification of the above hypotheses related to the research objectives are presented in the concluding remarks. They also point to the limitations of the conducted research, as well as to the trends of further studies and their implications for corporate management.

The use of the financial context as the sole criterion for assessing the balanced effects of value creation and financial security of going concern as the result of applying sustainable management is caused by several factors.

First, it results from the adopted epistemological approach—a company exists to obtain a financial effect (see: above remarks and detailed comments in “Literature Review”). The effects of a company's development can have various forms, being reflected in meeting stakeholders' expectations. In this context, shareholders and their financial objective—increasing their invested capital—are of key significance. Shareholder value also implies value created for other stakeholders. It corresponds to the

concept of “illuminated” value-based management (VBM), being a basis for the commonly accepted corporate value theory developed by A. Rappaport.

Secondly, the effects of a company’s development are assessed in this article on the basis of multifaceted value measure (MVM). This measure combines two processes—internal value creating (for shareholders, a microeconomic approach), and external value creating (a macroeconomic approach). The latter is value added transferred to an economic system—it creates value added (the main component of GDP), and is close to the concept of value for a company’s broadly understood stakeholders (environment, society). The combination of the measurement of shareholder value and stakeholders value corresponds to the concept of sustainable value creation.

Thirdly, the assessment of the effects of manufacturing enterprises’ development comprises the measurement of the financial security of going concern. This measurement, based on a prediction (logit) model, can be exclusively carried out for a company’s financial dimensions of its financial condition. To ensure the comparability of the measurement of the financial security of going concern and the measurement of value creation (the balancing of their effects), this value should also refer to the financial dimensions of a company’s development effects and corporate value creation.

Fourthly, the presented research comprises an entire population of manufacturing enterprises in Poland (13,006 entities, unique in character), and is based on public statistics data bases. The data refers exclusively to the characteristics of enterprises’ financial standing (external assessment, and statistical and econometric analysis). Undoubtedly, it implies certain limitations, but the inclusion of non-financial information is only possible in the case of individual research (internal assessment, qualitative analysis), which implies a small sample of enterprises and difficulties in ensuring a representative sample.

The results of this research and their interpretation constitute part of an extensive study of the population of institutional sector enterprises in Poland, and is a component of a series of publications.

## **2. Literature Review**

The essence of a company is described by the principles which govern its activities—the ability to generate profit, its functioning in the conditions of risk, and entrepreneurship [1]. The characteristics of a company’s activities, being its targets, include innovativeness, effectiveness, development and value creation. In the process of achieving these objectives, a company is subject to the influence of the environment and the internal processes which it consciously creates, i.e., how it manages them [2].

The idea of the purposefulness of a company’s activities and the definition of corporate objectives cause much controversy [3]. Undoubtedly, a company’s objectives determine development trends, affect the planning process, act as motivating factors, and constitute a basis for corporate functioning, but they do not always create a coherent system [4]. The most general objectives are a company’s survival and development. The former is a prerequisite to achieving other objectives, while the latter constitutes its essence.

A company’s survival and related threats, together with the company’s development—its measurement and assessment—represent the major focus of the paper. This research area focuses on two key issues: value creation (internal and external), and the financial security of going concern, which are discussed from the perspective of balancing their effects. Assessments refer solely to the meeting of balance requirements in their financial dimensions, but they certainly relate to a broader context comprising sustainable development (SD), sustainable management (SM), corporate social responsibility (CSR) and sustainable value creation (SVC).

### *2.1. Development, Effectiveness, Value*

Development is a process of structural change, and it cannot be implemented in a short period of time [5]. New phenomena and rules arise which have not occurred before. Development is a process which takes place over the course of time. It comprises consistently ordered phases and stages which constitute a company’s life cycle [6].

It is justified to say that growth enables companies to better adapt to the environment and its development [7], and that there is a feedback between these categories. However, treating development as a qualitative category and growth as a quantitative phenomenon is characteristic of a traditional approach.

Effectiveness is a quantitative characteristic of a company's development [8]. It best reflects the results of the rational manner of doing business, while entrepreneurship is the way in which effectiveness is achieved [9]. Effectiveness is the factor that determines the essence of a company's activities, its functioning and development [10].

The effects of a company's development can assume various forms, being achieved through meeting stakeholders' expectations. Such expectations mainly include the interests of shareholders and their financial goal—accumulating the value of invested capital [11]. Value created for company owners indicates value for other stakeholders [12]. Value created at a microeconomic level is transferred to a macroeconomic level—creating value added (the main component of GDP) [13].

Classical economics defines various sources, factors and types of value. Currently, value is understood in terms of outlays and effects, and it is no longer linked to real capital in favour of abstract capital. Consequently, a company's value is linked to its ability to accumulate invested capital [14] (pp. 293–308), also searching for a link with the business model [15].

A company's development and value creation are measured by several indicators [16–18]. An important measure is a quantitative analysis of their mutual relationships and value determinants. It provides insights into the value creation mechanism.

## *2.2. Sustainable Development*

Global, regional and local changes, affecting the existence and development of enterprises, have become an inspiration for developing the concept of a learning organization [19] and a new research area—sustainable science [20]. Sustainability is a company's ability to carry out its activities based on continuous learning, revitalization, reconstruction and reorientation, and, in the first place, adaptation and development [21].

There are several definitions of sustainable development, focusing on various aspects of this term [22]. Sustainable development is frequently confused with the concept of ecodevelopment—ecology is only one of its aspects. Sustainability is based on economic, social, environmental and political factors which determine an equilibrium between costs and profits [23]. Responsibility for maintaining a balance between sustainable development factors can be treated as a company's "silent stakeholder" [24].

Sustainable development expresses the idea of seeking the sources of a steady and safe market position based on a company's responsibility to its environment [25].

Sustainable development is characterised by three factors: sustainability—maintaining an equilibrium between company and stakeholder needs; stability—maintaining the accessibility of environmental resources; and self-support—the interdependence of economic, ecological and political factors in stimulating long-term growth [26].

Exploration shows that the business methods (strategies) of sustainability are different. Although these methods differ, many sustainability practices touch upon the same interfaces for company action. R.J. Orsato argues that companies must make efforts in order to pursue 'the right' type of sustainability strategy, which proposes a contingency perspective and should pursue return-on-investment (ROI) on environmental actions [27].

As S.L. Hart says, a few enterprises realise that environmental opportunities might actually become a major source of revenue growth—not just a source of cost savings. Thus, the strategy of eco-efficiency and social responsibility is the one to pursue as a first stage towards a sustainable company [28]. Moreover, they also provide profits for shareholders [29]. Going further, it is proven that innovation is a crucial element of sustainability, and vice versa—sustainability being a catalyst for innovation, the key driver of development [30].



### *2.3. Sustainable Management and Corporate Social Responsibility*

Sustainable development leads to the development of sustainable management [31,32]. This concept proves a close correlation between corporate development and stakeholder relationship management [33].

The tool for implementing this idea is corporate social responsibility (CSR) [34]. Presently, however, CSR is not aimed at “doing good” but is focused on creating shared value (CSV) [35].

The CSR concept is based on agency theory—a company’s (agent’s) commitment to satisfying the needs of its allies (principal) [36], and stakeholder theory—stakeholders’ right to intervene in company operations [37].

The CSR concept focuses on stakeholders’ objectives. They have legitimised “interests” in a company’s process-related and substantive activities, and each of these interests has its intrinsic value [38]. This leads to a conflict between CSR and shareholder concept. Its financial objective is shareholder value creation, which is achieved through value-based management (VBM).

However, achieving stakeholders’ objectives can have an adverse effect on corporate value creation. Hence the proposal to employ “illuminated VBM”, assuming the complementarity of stakeholder concept and VBM. According to “illuminated VBM”, shareholder value creation cannot be carried out without respecting stakeholders’ interests (which implies the absence of a conflict) [39], [40]. However, the assumption that care for the environment and society translates to greater corporate value is often criticised [41]. Moreover, a company’s performance is still measured mainly in its financial dimension. Environmental and social aspects are taken into account only from the perspective of their contribution to improving financial results [42,43].

### *2.4. Sustainable Value Creation*

Emphasising how sustainability creates value matches epistemological reasoning presented in this paper—a company exists to achieve a financial effect. This reinforces financial analysis as the main tool for assessing a company’s sustainable development and value creation.

The impact of sustainable management on financial results is confirmed by several research studies. However, financial results can be understood in different ways as, for example, company performance [44], premium profits [45], competitive advantage [46], sustainable value added [47], or long-term shareholder value [48].

Benefits resulting from sustainable development can be different, but the key financial effects are the same—margin improvement or revenue increase. Sustainable development leads to competitive advantage, which, in turn, results in premium profits [49]. These are the measures of value creation which provide a financial justification for implementing a sustainable development strategy.

S.L. Hart and M.B. Milstein are the creators of the sustainable value framework. It shows relationships between sustainable development and a company’s fundamental activities and functions understood as value drivers [50].

Sustainable value creation is defined as a business strategy focused on solving key social problems through identifying new scaled sources of competitive advantage, which generate measurable profits and lead to social benefits—shared value [51].

A review of the sustainability literature suggests a few key concepts and critical ways to understand sustainable value creation [52]. The first one is systems thinking, which potentially provides the scope to integrate multiple factors: economic, social and environmental [53,54]. Further proposals include whole systems design [55] and systems innovation [56]. The implementation of these concepts is supported by appropriate sustainable business models [57]. The new concepts for sustainable value creation form the framework for business models by considering value destroyed, value missed and value opportunities [58].

## 2.5. A Company's Crisis and Financial Threats

As already mentioned, a company's operations are characterised by and based on the principle of its functioning in the conditions of crisis, resulting from the uncertainty of specific events and future developments. Crisis represents a severe stage of such conditions.

A company's crisis can be understood in different ways [59]—frequently as a breakthrough process between two stages of a company's life cycle, which differ in terms of their quality. A company's crisis is marked by its complexity, resulting from a combination of various factors forming a sequence of events, resulting in cause–effect processes and a distinct escalation path [60].

A company's exposure and vulnerability to threats is diversified, which can be described using specific models [61], and Polish companies' vulnerability is very high [62]. A sudden, tangible crisis usually results from a long-lasting financial distress—a 'smouldering' crisis [63].

The symptoms of a company's crisis are caused by various factors and their combinations. The major sources of crisis result from a company's failures in corporate functioning, which can be quantified from the perspective of a company's financial standing [64].

Crisis is part of the area of risk management [65], hence the significance of the ability to predict it. This necessitates creating early warning systems (EWS) which diagnose the indications of crisis, but which should not be identified with bankruptcy prediction [66,67]. The quantification process is frequently based on discriminant analysis methods and logit models [68].

The most significant characteristics of threat prediction methods include their effectiveness and reference points. Attempts aimed to depart from the idea of a business failure and its legal and narrow sense (*bankrupcy*) have not been successful due to difficulties in offering a broad definition of failure referred to as *economic distress* and *financial distress* [69].

## 2.6. Financial Threat Prediction Models

Early warning systems (EWS) make use of several tools applied in financial analyses as well as statistical methods used in predicting financial threats of going concern. The identified measures quantify early warning signals, thus becoming threat predictors. Such systems make use of three types of information: alarm signals, deviations from standards and weak signals (weakly structured) [70].

EWS methods are usually classified on the basis of the character of the analysed factors (quantitative, qualitative and mixed methods) and the manner of formulating conclusions (logical deductive and empirical inductive methods) [71].

The first group includes scoring models, multi-criteria models and models based on EVA (Economic Value Added), SVA (Shareholders Value Added) and MVA (Market Value Added). Research studies conducted in the Polish business environment indicate the lack of statistically significant correlation between the above measures and the risk of business failure [72,73].

Logical deductive methods use financial analysis in assessing the risk of business failure. Empirical inductive methods are examples of comparative analyses based on statistical and econometric methods (an analysis of the groups of threatened and non-threatened companies). Depending on the number of variables, these methods are referred to as one—or multivariable methods [74].

The development of econometric modelling in the prediction of financial threats originates from (one–variable models) the first works of W. Rosendal and P.J. Fitzpatrick—they developed a pair-based comparative analysis (a threatened vs non-threatened entity). C.L. Merwin applied the methods of profile analysis and arithmetic mean for groups of objects, while W.H. Beaver verified the usefulness of financial ratios in threat prediction. This area of research was also undertaken by P. Weibel, who proved that an increased number of explanatory variables did not lead to significantly better results in risk assessment [75,76].

Currently, multi-variable models dominate, with a great contribution being made by the logit model. It allows for detecting not only a financial threat but also its probability. Multiple discriminant analysis was developed by E.I. Altman [77]. Other well-known creators of threat prediction methods include G. Weinrich, J. Fulmer, J. Legault, J. Ko, H. Koh, Killough, K. Beermann, G. Gebhardt and

E. Bleier [78]. The creators of prediction models in Poland include E. Mączyńska, D. Appenzeller, J. Gajdka and T. Stos, B. Prusak, M. Hamrol. B. Czajka, M. Piechocki, A. Hołda and D. Wędzki [79].

### 3. Methodology of Research

The subject of the research study (the first research area) is a mechanism of creating value determined by value creation processes attributable to company owners, and creating value added transferred to an economic system (value added: net financial result, compensation and social insurance, interest, income tax and quasi-fiscal charges).

The object of the study comprises 13,006 manufacturing enterprises (June 2018) in Poland in 2007–2018 (41.0% of value added in the enterprise sector with more than 9 employees). Data on the individual enterprises are held by the central statistical office in Warsaw (Statistics Poland) which may be made available on request. Disclosure relates to the results of analysis and aggregated data for PKD classes—the Polish Classification of Activities (microstructures, the protection of individual enterprises data necessary for reasons of statistical confidentiality and law).

The mechanism of value creation is quantified with the use of partial measures and value drivers interconnected within structural systems and merged into MVM (multifaceted value measure) with the use of statistical procedures including: standardization, change of destimulants into stimulants, elimination of their negative values by subtraction of the scalar (minimum value of the variable), determination of the Euclidean distance  $d_{i0}$  of individual objects from the coordinates of the anti-template (beginning of the coordinate system). The multifaceted value measure is therefore described by the formula:

$$d_{i0} = \sqrt{\sum_{j=1}^K (x_{ij} - x_{0j})^2} \quad (1)$$

where:  $x_0 = (0, \dots, 0)_K$ ,  $K$ —number of multifaceted value measure components ( $j = 1, \dots, K$ ).

The processes that affect MVM are defined as follows (Figure 1):

- creating value for company owners (internal process): return on assets (ROA) and financing structure (equity multiplier EM—total capital to equity), which determine return on equity (ROE),
- creating value added as a component of GDP (external process): net financial result referred to revenues from sales (ROR) and value added retention ratio (VAH—net financial result referred to value added), which determine the rate of value added (VAR—value added to revenue from sales).

The impact of the return on assets (ROA) and the financing structure (equity multiplier EM) on the return on equity (ROE) is the highest level of analysis generalisation using the relationships between profitability structural indicators (DuPont analysis). In this framework, ROA is formed by the net return on sales (ROS) and the asset productivity (AP)—total capital circulation. Thus, the analysis focused on changes in the dependent variable (ROE) and the nature of the impact of all defined explanatory variables (determinants)—ROA, ROS, EM and AP.

The second process investigated was the creation of added value (VAR). It is shaped by the net financial result referred to revenues from sales (ROR) and the value added retention ratio (VAH)—this is the part of the added value remaining in the company that creates it. Therefore, from the macroeconomic point of view, the ROR increase is stimulant, and the VAH increase is a destimulant of the value added rate (the increase in the share of the financial result in value added causes a decrease in the value added rate).

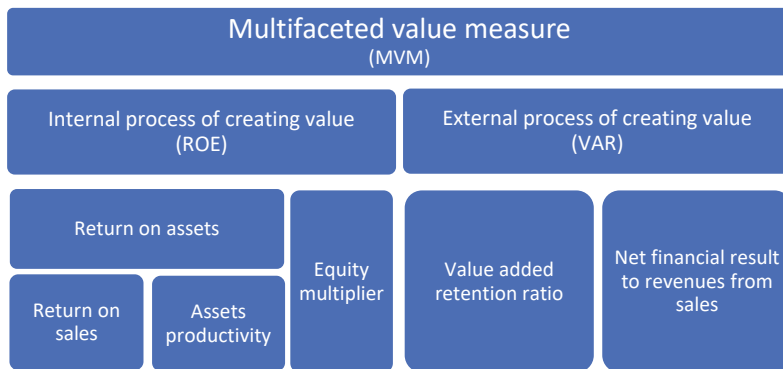

**Figure 1.** The design scheme of the multifaceted value measure components.

The measurement of financial security (the second research area) is based on an estimated logit model in response to the criticism of hitherto employed solutions. The basic deficiencies of the available models include: estimates from a long-term perspective before the 2008 crisis, limitations in their use in a dynamic analysis of threats, small numbers of learning sets, verification of prediction ability on learning sets, construction weaknesses, and the use of traditional estimation methods and techniques. The study is supplemented (details available in other publications) by the estimation of models scaled on the basis of the percentage of court insolvency proceedings [80].

To construct the model a set of 24 indicators was used from the following areas: productivity, liquidity, financing, profitability, debt and efficiency. These indicators were characterised by 426 bankrupt companies and 1936 non-bankrupt companies (training set, 47,240 object–observations). The applied method for matching companies (bankrupt/non-bankrupt) involves the case–control technique (matching up to “1 to 5”) [81]. In the next step, one-dimensional distributions and correlations of all 24 potential explanatory variables were analysed. The predictive capacity of decision rules was measured by taking into account their *sensitivity* and *specificity*. An assessment was next carried out of the parameters of the model (the best subset method, *Akaike Information Criterion*). The model applied was the Firth’s logistic regression model, which almost completely eliminates the disadvantages of classic models (parameter assessments in this model are barely burdened, confidence intervals are characterised by better probabilistic properties and modification of the original likelihood function contains interpretation from the Bayes point of view) [82,83]:

$$s^*(\theta) = \sum_{i=1}^n \left( y_i - F(x_i'\theta) + h_i \left( \frac{1}{2} - F(x_i'\theta) \right) \right) x_i \quad (2)$$

where  $h_i$  is the diagonal elements of matrix  $H = W^{\frac{1}{2}} X(X'WX)^{-1} X'W^{\frac{1}{2}}$ ,  $X$  is the data matrix, and  $W$  is the diagonal matrix with dimensions  $n \times n$ , whose  $i$ -th diagonal element is equal to  $F(x_i'\theta)(1 - F(x_i'\theta))$ , and  $F(x_i'\theta)$  is success likelihood by Bernoulli distribution.

Optimal cut-off points for level of financial security of going concern has been designated by means of the ROC (Receiver Operating Characteristic—a two-dimensional graph which presents *sensitivity* and  $1$ -*specificity* calculated for various values of the cut-off point). The predictive capacity of model was calculated with the use of *sensitivity* and *specificity*. Additionally, the quality of models has been measured with the use of the  $AUC = \int_0^1 y(x)dx$  (area under the ROC curve, where  $y(x)$  is a function defining the ROC curve) [84].

Bearing in mind the benefits of Firth’s model referred to, it is legitimate to presume that it should become one of the basic tools in the modelling of financial security of company going concern [85].

The measure resulting from the logit model reflects the financial security degree (FSD) as opposed to the threat of the financial distress of going concern and bankruptcy. This change aims to define FSD as a stimulant for the needs of a multidimensional assessment of changes in the enterprise sector.

In accordance with the adopted methodology, the FSD model takes the following form [86] (Figure 2):

$$FSD = \left( 1 - \frac{1}{1 + \exp\left[-\left(-0.70 - 0.42 \frac{AP - 1.89}{1.09} - 0.93 \frac{SF - 0.39}{0.31} + 0.65 \frac{STL - 0.47}{0.27} - 0.73 \frac{RoOA - 2.94}{13.46}\right)\right]} \right) \cdot 100\% \quad (3)$$

where: *AP*—asset productivity ratio, *SF*—self-financing ratio, *STL*—short-term liability ratio, *RoOA*—operating return on assets ratio.

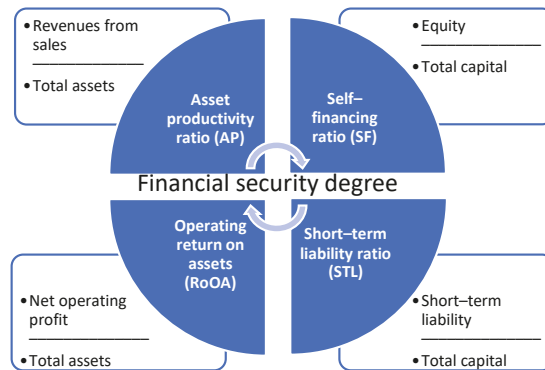

Figure 2. The design scheme of the financial security degree components.

This measure assumes values (0,100%), with higher values indicating higher probability of maintaining financial security from a one-year perspective (the model is characterised by: sensitivity 82.4%, specificity 82.1%, and AUC 0.894).

The analysis of the movement of objects in the identified structures is based on the ranking method. For this purpose, MVM and FSD measures are replaced by regular-type ranks. The average rank method is used, and the lowest rank is attributed to the highest value of a given measure. In combination with standard deviation (it’s treated as a measure of the variation/diversity of objects in relation to MVM and FSD), objects are classified as follows: pattern 1—high and stable position, pattern 2—high position with considerable variability, pattern 3—low and stable position, pattern 4—low position with considerable variability. These patterns and MVM and FSD measures, along with their explanatory variables, are used in analysing the profiles of the structures in question.

The degree of object density is analysed using the elliptical density measure:

$$DM = \sqrt{s_x^2 s_y^2 \cdot (1 - r_{xy}^2)} \quad (4)$$

where:  $s_x^2$ ,  $s_y^2$ —variance of variable  $x$ , variance of variable  $y$ ;  $r_{xy}^2$ —Pearson linear correlation coefficient between  $x$  and  $y$ . The density measure describes the surface area of the ellipse covering the set of objects.

To assess the changes in microstructures, a taxonomic measure of similarity of structures (TMS) was used [87]:

$$TMS = \sum_{i=1}^N \min (p_{ij}, p_{ik}) \quad (5)$$

where:  $p_{ij}, p_{ik}$ —share of the  $i$ -th object in structure  $j, k$ ;  $N$ —number of objects. This measure takes values from the range  $<0-1>$ ; however, a closer value is to the unity, the more similar the compared structures are.

Cause analysis is based on a deterministic approach and logarithm method. It allows for transforming the sequence of the product of dynamics of explanatory variables ( $D_{EV}$ ) into the sequence of the sum, which is followed by equating the dependent variable ( $D_{DV}$ ) dynamics logarithm to one. Thereby, the structure ratios are determined, which describe the impact of explanatory variables ( $R_{EV}$ ) on the dependent variable ( $R_{DV}$ ) [88]:

$$\begin{aligned}
 D_{DV} &= D_{EV1} \cdot D_{EV2} \cdot \dots \cdot D_{EVn} \\
 \log D_{DV} &= \log(D_{EV1} \cdot D_{EV2} \cdot \dots \cdot D_{EVn}) \\
 \frac{\log D_{DV}}{\log D_{DV}} &= \frac{\log D_{EV1} + \log D_{EV2} + \dots + \log D_{EVn}}{\log D_{DV}} \tag{6} \\
 R_{DV} &= \frac{\log D_{DV}}{\log D_{DV}} ; R_{EV1} = \frac{\log D_{EV1}}{\log D_{DV}} ; R_{EV2} = \frac{\log D_{EV2}}{\log D_{DV}} ; R_{EVn} = \frac{\log D_{EVn}}{\log D_{DV}} \\
 R_{DV} &= R_{EV1} + R_{EV2} + \dots + R_{EVn}
 \end{aligned}$$

The diagram of the problem of balancing and evaluation of the effects of value creation and financial security sustainable management analysed in the article is presented in Figure 3.

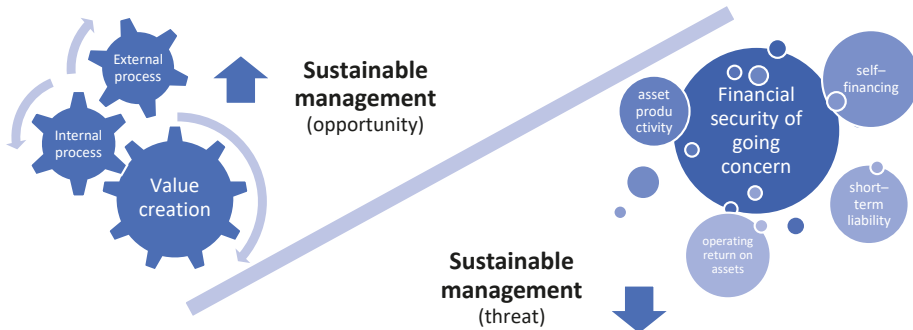

Figure 3. Value creation and financial security of going concern in terms of the concept of sustainable management—researching the balance of processes.

#### 4. Findings and Discussion

##### 4.1. Return on Equity (ROE) Determinants

In a wide range of results and conclusions regarding ROE determinants in manufacturing enterprises in 2007–2018, attention should be given to the following findings (Figure 4).

The first finding relates to a higher density of objects within a group of ROA–EM factors (an increase by 30.4%). Movements are relatively uniform towards the coordinate system. This indicates that objects become similar in terms of the obtained results: ROA, and financing structure (EM).

With regard to the values on the time axis, attention should be given on the contrary trend of changes in ROA–EM values – increases in one are accompanied by decreases in the other (and vice versa). The year 2015 marks the end of a longer and the beginning of a shorter phase of these contrary trends. A causal analysis indicates that the main determinant of ROE is ROA factor (an average of 72.7%). Its share rises steadily until 2009, and its dynamics declines in 2012–2013.

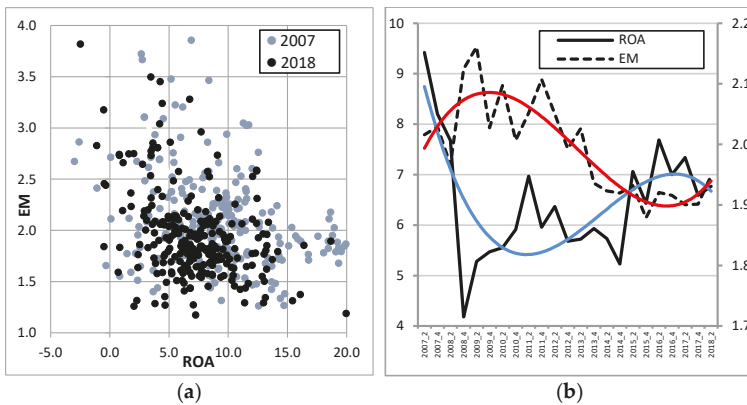

**Figure 4.** Location density (a), for the main part of the set, and trends of changes (b) of ROE determinants in manufacturing enterprises in 2007–2018 (6-month periodisation).

The path of the central point of the population shows numerous reversals, and average financing conditions are marked by an equilibrium between equity and foreign capital ( $EM = 1.99$ ), accompanied by the increased effectiveness of the use of total capital ( $ROA = 6.44\%$ ).

**Partial conclusions:** (a) There is an opposite direction of changes in ROA–EM values—the change of one corresponded on the contrary change of the other; (b) the key determinant of ROE is the ROA factor.

#### 4.2. Rate of Value Added (VAR) Drivers

With regard to VAR determinants in manufacturing enterprises in 2007–2018, attention should be given, in the first place (Figure 5), to the density of ROS–VAH objects (from 10.1 to 0.6). It is not quite uniform towards the system of coordinates but closer to the VAH axis. The increased density indicates a greater similarity of objects in terms of ROS values and the VAH coefficient.

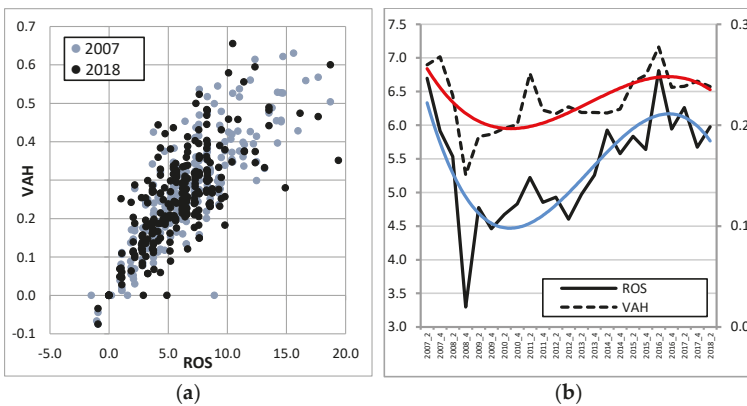

**Figure 5.** Location density (a), for the main part of the set, and trends of changes (b) of VAR determinants in manufacturing enterprises in 2007–2018 (6-month periodisation).

The observed changes over the course of time also include the consistency of direction with regard to ROS–VAH values—an increase in one is accompanied by an increase in the other (Pearson = 0.87). The economic slowdown of 2008–2010 is distinctly shown by particular values, and the next period of deterioration starts in 2016—demonstrated by lower ROS and VAH values.

VAR, from a cause-related perspective, points to a balanced share of ROS and VAH variables (an average of 50% each), and the analysed period is marked by 3 points of changes of contrary trends (increase/decrease, decrease/increase).

The path of the central point of the analysed population forms a trajectory with numerous reversals. However, its regression curve is relatively stabilised (linear  $R^2 = 0.76$ ), and the average conditions of operating effectiveness stand at  $ROS = 5.38\%$ , and  $VAH = 0.22$ .

**Partial conclusions:** (c) There is convergence in the direction of changes in the values of ROS–VAH factors; (d) by causally distributing the VAR component, the share of ROS and VAH factors was equivalent.

4.3. Multifaceted Value Measure (MVM) Determinants

An assessment of MVM changes with regard to ROE–VAR factors in manufacturing enterprises in 2007–2018 leads to several conclusions (Figure 6).

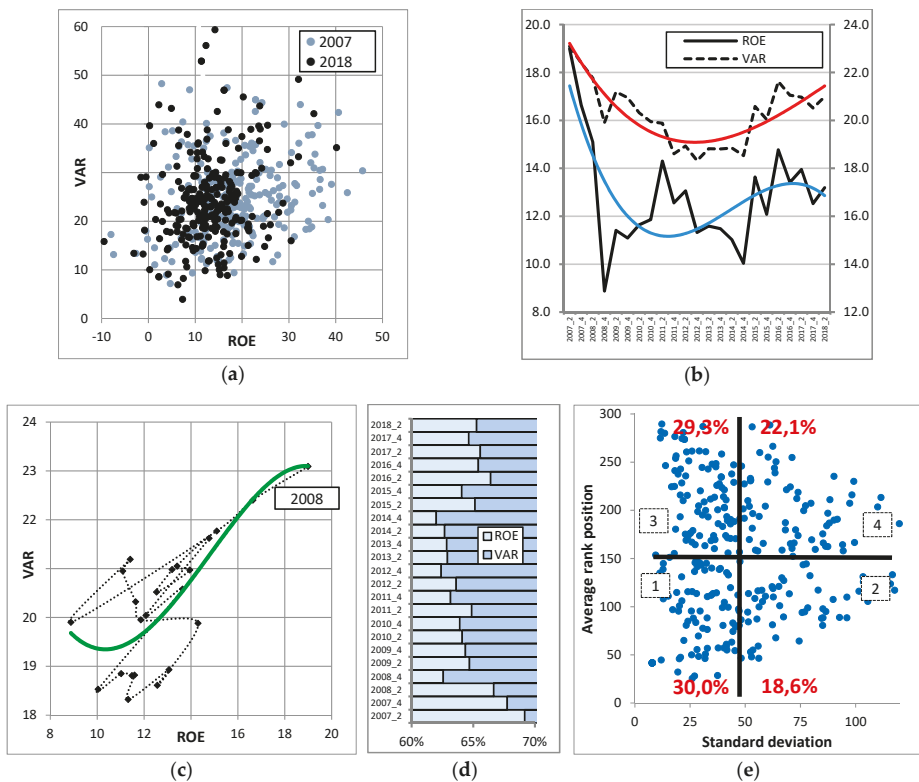

**Figure 6.** Location density (a), the main part of the set; trends of changes (b); path of the central point (c) and share of determinants (d) with regard to MVM; and classification of manufacturing enterprises (e), grouped into PKD classes, according to MVM-related ranking position and its variation in 2007–2018 (6-month periodisation).

An analysis of the movement of objects in the studied period indicates their higher density (+33.3%). It is relatively uniform towards the origin of the coordinate system but closer to the VAR axis. A greater similarity of objects in terms of the measures of internally and externally created value points to stiffer competition in the analysed population of manufacturing enterprises.



The trend of changes in ROE–VAR values is consistent as of 2017—an increase in one is accompanied by an increase in the other (Pearson = 0.73). There are two distinct periods of decreasing ROE values (the second one is weaker, in the initial phase), and one long-lasting period of declining VAR.

The path of the central point is marked by numerous reversals, and its regression curve with a good match of  $R^2 = 0.60$  is described by a 4th-order polynomial. The occurring changes lead to average values of ROE = 12.81%, and VAR = 20.3%.

The set of objects merged into uniform groups according to PKD—the Polish Classification of Activities (microstructures, the protection of individual enterprises data necessary for reasons of statistical confidentiality and law)—can be described by dividing them into uniform subsets (quadrants), distinguished by their ranking position and standard deviation. This procedure points to the majority of PKD classes below the level of average variation (48.0), indicating relative stability. However, such a conclusion is not unambiguous considering a high average value of the standard deviation.

The division of value creation measures into explanatory variables allows the identification of their share in determining the value of MVM (dependent variable). An average share of ROE is 64.5%, with VAR accounting for 35.5%. The 2007–2014 period is marked by a decreasing impact of ROE—10.4%. This share rises in subsequent periods, reaching the level of 94.4% of the initial value at the end of the analysed period (inference related to VAR changes is contrary).

**Key considerations:** (1) The development of manufacturing enterprises, assessed on the basis of value creation, is marked by recurring cycles which are consistent with the factors which affect them; (2) value creation for owners is the main determinant, accompanied by an increased transmission of value to the wider economic system.

#### *4.4. Financial Threat to Going Concern and Bankruptcy*

The measure resulting from estimation—the degree of financial security (FSD)—is the opposition of the concept of the threat to going concern and bankruptcy, which results from its definition as a stimulant for the needs of a multivariate assessment of changes in the enterprise sector, and in the context of inference presented in this paper, for the purpose of the relativisation of value creation assessments. Undoubtedly, the reference point for FSD or financial threat is the category of bankruptcy as a court bankruptcy proceedings and their percentage (percentage of bankruptcy proceedings—PBP).

Bankruptcy proceedings (understood as PBP) intensified and reached their peak values in 2012, especially in the service sector. Trade activities reflected a long-term trend of GDP growth, while production activities were marked by the greatest stability (also in manufacturing enterprises—an average of 105.5% of PBP in production activities). There is a distinct period of economic slowdown (crisis)—the 2009–2010 period, with its peak in 2013 (the second slowdown) (Figure 7a).

The analysis of bankruptcy concentration points to above-average values in services and an increasing trend until 2013, followed by a reverse trend. The production sector records a distinct trend of the decreasing concentration of bankruptcies, while trade activities are marked by a long-term increasing trend (concentration is assessment of court bankruptcy proceedings in a specific group of entities in relation to the total number of group members. Values in excess of 1 indicate above-average concentration of the analysed phenomenon in a given group).

The mutual reference of bankruptcy measures in a legal sense (PBP) and those in an economic sense (FSD) is not possible without defining their actual meaning. It does not imply, however, the absence of correlations between them. FSD and PBP values are similar over longer periods of time (the analysis of the 2007–2018 period). The determined trend functions (polynomial of degree 3) for both curves point to the consistency of their directions. It is also confirmed by the effectiveness of the FSD estimated measure (Figure 7b).

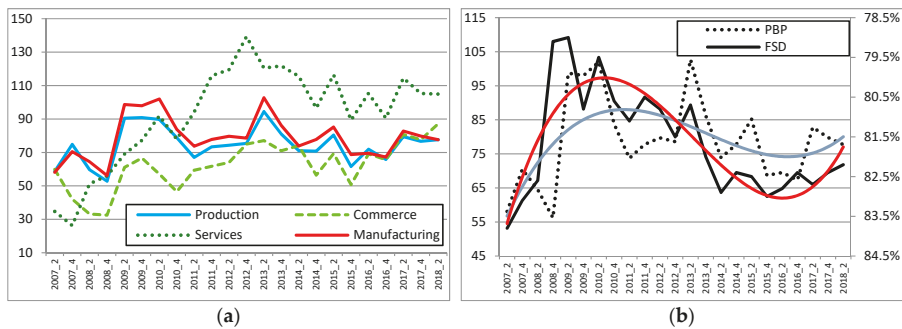

**Figure 7.** The percentage of court bankruptcy proceedings (PBP) by type of activity (a) and the interdependence of FSD and PBP for manufacturing enterprises (b) in 2007–2018 (6-month periodisation). Note: PBP in declining order.

**Partial conclusions:** (e) In the context of bankruptcy, the most stable situation was in manufacturing enterprises; (f) trends in PBP and FSD values are compatible.

#### 4.5. The Degree of Financial Security

With regard to the second key area of the considerations, basic conclusions should be formulated as a result of the analysis of the degree of financial security (FSD) in manufacturing enterprises (Figure 8).

The analysed period is characterised by a considerable and reverse variability of FSD values as well as their standard deviations (SD). The visible impact of economic slowdown after 2008 resulted in lower FSD values, while companies recorded greater changeability, marking the disturbance of relative equilibrium. The situation was reversed after 2010, where the FSD and SD curves intersected—improvements in FSD were accompanied by declining SD values. Another culminating point of FSD values is recorded in the second half of 2015, and as expected, declining FSD values are accompanied by increased SD levels until their curves intersect again (this issue is analysed in subsequent research studies).

The population of objects (enterprises merged into uniform groups according to the PKD classification—microstructure) is divided into subsets (quadrants), marked by their average ranking position and standard deviation (in an FSD-based approach). There is a slight dominance of positions below average variation (53.1%). High average standard deviation values of ranking positions (51.8) point to considerable object relocations, which is confirmed by the above conclusion.

FSD decile distribution shows a considerable improvement in the 9th decile, which results in reducing FSD's average value. Unfortunately, a contrary trend of changes, but weaker in its impact, is recorded for the lowest deciles, and these changes have an adverse effect on improvements in the entire group of manufacturing enterprises.

The identification of explanatory variables in the FSD model shows their share in determining the final value of FSD (dependent variable). The average share of AP (assets productivity) is 16.6%, SF (self-financing)—29.6%, STL (short-term liability)—30.8%, and RoOA (operating return on assets)—23.0%. As compared with the beginning of the analysed period, a greater impact is recorded at the end of the period for AP, SF, and STL (+42.5%, +16.2%, and +12.5%, respectively), and a smaller impact for RoOA (−35.8%). Deviations from average values are lower: +3.0%, +6.4%, −6.5%, and −1.7%, respectively.

**Key considerations:** (3) Changes in financial security occur in recurring cycles, and are contrary to the level of its variation; (4) the distribution of financial security determinants changes, with the lowest impact of asset productivity (capital circulation).

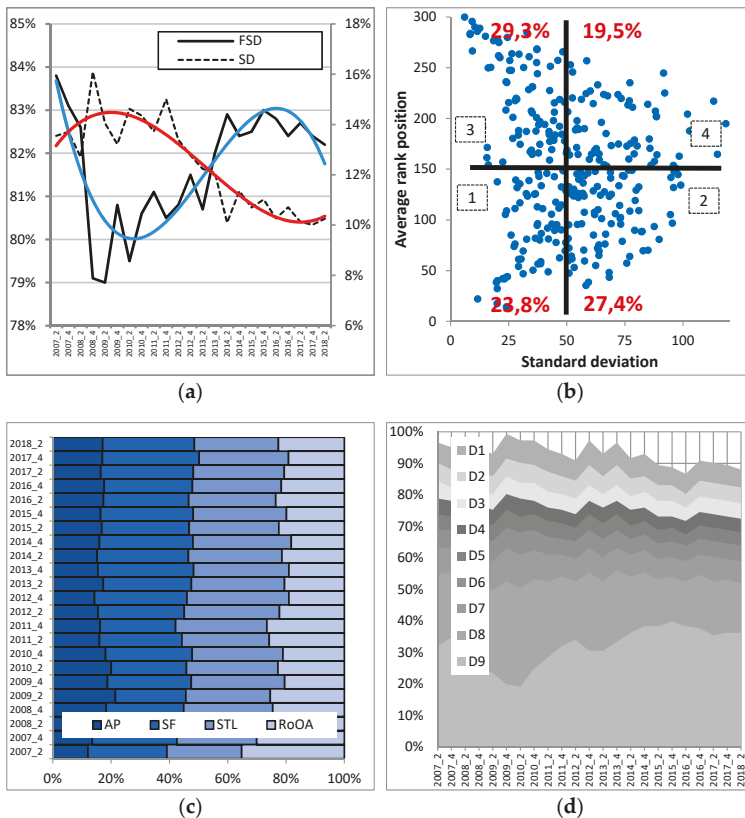

**Figure 8.** Trends of changes (a), classification of manufacturing enterprises (b), grouped into PKD classes, according to FSD-related ranking position and its variation; share of determinants (c); and FSD decile distribution (d) for manufacturing enterprises in 2007–2018 (6-month periodisation).

#### 4.6. Value Creation vs. Financial Security

The main hypothesis of this paper is the existence, in the population of manufacturing enterprises, of direct proportionality between the effects of value creation and ensuring the financial security of going concern. The assessment analysis conducted for 2007–2018 results in several partial findings which lead to the final conclusion confirming this hypothesis (Figure 9).

The analysed population is marked by a higher density of objects (by 30.0%)—it is relatively uniform, and objects become more similar in terms of value creation (MVM) and the level of achieved financial security (FSD). There is a subset of considerable size, characterised by a similar level of MVM and significant differences in FSD (15% of the population of manufacturing enterprises).

The trends of changes of both measures are consistent—an increase in one is accompanied by an increase in the other, and vice versa. Thus, there is a strong, positive and statistically significant correlation between MVM and FSD (Pearson = 0.63,  $p$ -value = 0.001270). There is a distinct period of declining value creation and financial security in 2007–2010, followed by a period of improvement until 2015. In that year, manufacturing enterprises enter another period of lower value creation and deterioration in financial security.

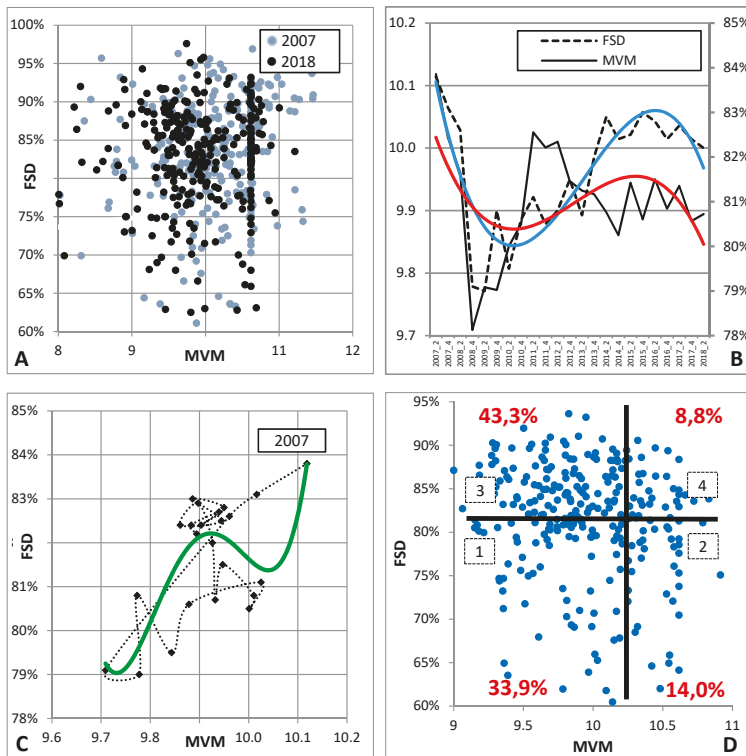

**Figure 9.** Location density (A) for the main part of the set; trends of changes (B); path of the central point (C); and classification of manufacturing enterprises (D), grouped into PKD classes, according to MVM and FSD average values in 2007–2018 (6-month periodisation).

The path of the central point is marked by numerous reversals, its regression curve with a good match ( $R^2 = 0.6$ ) is described by the polynomial of 4th degree, and average values reach the level of  $MVM = 10.3$ , and  $FSD = 81.7\%$ . Regarding these values as criteria for classification (enterprises merged into uniform groups according to PKD classes—microstructure), conditions below average with respect to MVM were characteristic of as many as 77.2% of objects in 2007–2018, and 47.9% of objects in terms of FSD. Only 8.8% of objects meet the above average criteria for both FSD and MVM. Manufacturing enterprises in this group are leaders in terms of value creation as well as in maintaining high levels of financial security.

**Key consideration:** (Hypothesis 0) There is a directly proportional relationship between the effects of the value creation process and the ensuring of financial security in manufacturing enterprises—the confirmation of the principle of sustainable management.

#### 4.7. Structure Profiles in the Context of Value Creation and Financial Security

Multifaceted value measure (MVM) comprises two components—creating value for owners (internal value, ROE) and creating value added as a component of GDP (external value, VAR). The assessment of the population of manufacturing enterprises by PKD classes (microstructure, 306 objects) leads to general conclusions with regard to value creation profiles. An in-depth analysis requires developing an appropriate research methodology, which sets directions for further research and publication of results.

The first conclusion of the initial, generally oriented analysis is a relatively lower variability of objects (PKD classes) in terms of external value creation (standard deviation 9.4, i.e., 39.1% of average value) as compared with internal value (13.1% and 50.1%, respectively). Also, there are differences in the levels of absolute standardised values of both MVM components in particular PKD classes—for example, some of them, when creating internal value, have a relatively small impact on external value creation. Others, in turn, build this value. Also, there are objects which have simultaneously a great or small impact on both external and internal value creation.

The value of taxonomic measure of similarity (TMS) of the analysed microstructure for ROE and VAR variables was 0.710. If  $0.7 < TMS < 0.8$ , the similarity is considered to be low ( $TMS < 0.7$ —no similarity). Therefore, the thesis of low similarity, close to non-existence can be assumed for the analysed microstructure (Figure 10).

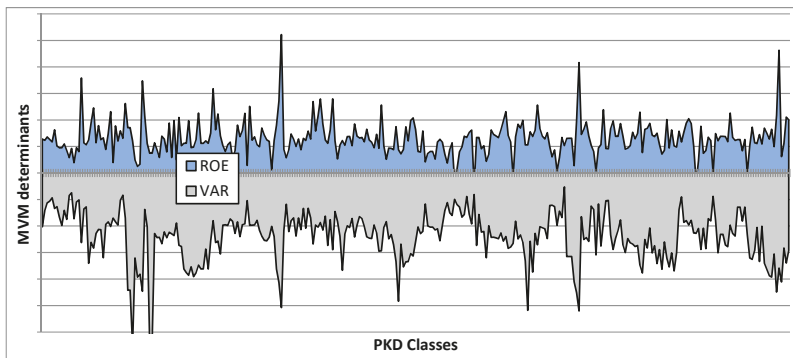
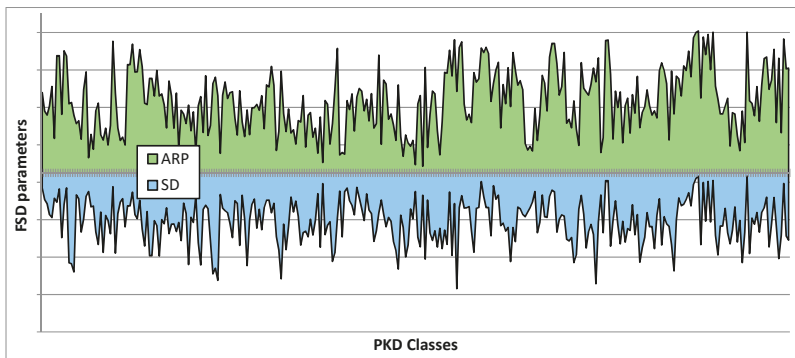

**Figure 10.** Profiles of PKD manufacturing enterprises in terms of internal value creation (ROE) and external value creation (VAR) in 2007–2018.

With regard to the financial security of going concern (FSD), factor analysis for PKD classes, aimed to determine their profiles, can be the subject of further in-depth analyses (5-dimensional), while for the purpose of general assessments we can refer to two features describing financial security in a given PKD class—average ranking position (ARP) in a group, and ranking position variation (SD). Differences on average ranking position in PKD classes are considerable:  $\pm 67.7$  of positions, i.e., 44.0% in relation to an average value in the population. With regard to the SD, its average value is 51.8, and in particular for PKD classes it deviates by  $\pm 24.1$ , i.e., 45.6%.

The value of taxonomic measure of similarity (TMS) of the analysed microstructure for ARP and SD measures (in terms of FSD) was 0.721. Therefore, in this case a thesis of slight similarity of the microstructure can be assumed (Figure 11).

The two abovementioned analytical areas can be combined on the basis of the previously defined normative patterns (in relation to average ranking position and its variation) simultaneously for MVM and FSD measures as an assessment of the consistency of PKD class profiles in manufacturing enterprises. In the analysed population consistency occurs in 31.6% of PKD classes, the lack of consistency in MVM–FSD positive differences occurs in 34.2%, and the same percentage is recorded for negative differences. Consequently, nearly the same number of PKD classes are characterised by the same MVM–FSD pattern as in the case of the dominance of MVM positions over FSD, and vice versa (with regard to normative patterns) (Figure 12).



**Figure 11.** Profiles of PKD manufacturing enterprises in terms of average ranking position (ARP) and its variation (standard deviation, SD) from the perspective of financial security (FSD) in 2007–2018.

**Key consideration:** (5) the compatibility of the profile patterns of manufacturing enterprises’ microstructures in the context of value creation and financial security is not strongly opposed to their considerable diversity.

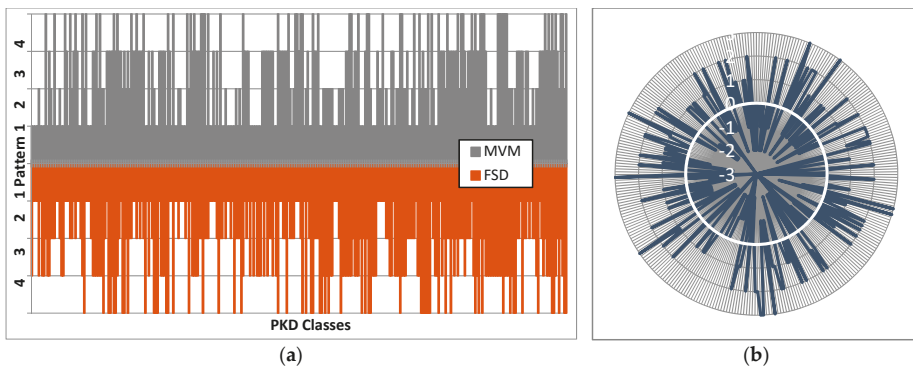

**Figure 12.** Profiles of PKD manufacturing enterprises in terms of the normative patterns of MVM and FSD measures (a), and differences of normative patterns (b) in 2007–2018. Notes: pattern differences  $\langle -3;0 \rangle$  high value assessment, low security assessment,  $\langle 0;3 \rangle$  low value assessment, high security assessment. The white ring—similarity of patterns.

### 5. Conclusions

The microeconomic studies of the populations of enterprises are very rare due to such limiting factors as access, scope and the complexity of data. The results presented in the paper focus on the value creation mechanism related to company owners, and transferred to an economic system. The second area of research concerns the financial security of going concern. The major question and objective of the study is an assessment of bringing balance between value creation and financial security—are there any positive effects of value creation and financial security sustainable management?

The detailed research findings, based on the obtained results and their assessment, allow for formulating the following confirmed main consideration (Hypothesis 0)—there is a directly proportional relationship (strong, positive and statistically significant correlation) between the effects of the value creation process (MVM) and the ensuring of financial security (FSD) in manufacturing enterprises—the confirmation of the principle of sustainable management.

The specific assessments can be given as follows (the points are corresponding to the partial hypotheses 1–5):

1. the development of manufacturing enterprises, assessed on the basis of value creation (MVM), is marked by recurring cycles which are consistent with the factors which affect them (ROE and VAR),
2. the value accruing to the owners (ROE) is the main determinant of value creation, accompanied by an increased transmission of value to an economic system (VAR), *in detail, on the ROE side:*
  - a. changes in ROA and the equity multiplier (EM) move in opposite directions
  - b. the key determinant of ROE is the ROA factor,*in detail, on the VAR side:*
  - c. the directions of changes in the ROS and VAH factors are similar,
  - d. the contribution of ROS and VAH to value added creation (VAR) is equivalent,
3. changes in financial security (FSD) occur in recurring cycles, and are contrary to the level of its variation,
4. the distribution of financial security determinants changes over time, with the lowest impact of asset productivity (capital circulation), *in detail, on the FSD side:*
  - e. the most stable situation in terms of bankruptcy (PBP) is in manufacturing enterprises (in relation to other activities),
  - f. trends in PBP and FSD are compatible,
5. the compatibility of the profile patterns of manufacturing enterprises' microstructures in the context of value creation and financial security is not strongly opposed to their considerable diversity.

In light of the above findings and conclusions presented in the discussion of results, it can be assumed that the formulated hypotheses are positively verified—both the main hypothesis and partial hypotheses. The reliability of the presented evidence results from the fact that the research study covers all manufacturing enterprises (a comprehensive study not based on a statistical sample) in 2007–2018, covered by public statistics, with more than 9 employees. Therefore, the research study can be treated as unique and covering the broadest possible range of objects.

References made in the paper exclusively to a financial approach to assessing the balanced effects of value creation and the financial security of going concern as the result of sustainable management set certain limitations of the research—its scope, specificity, as well as the range of measurements and interpretation of results. These limitations are mainly determined by the adopted epistemological approach—the objective of a company's existence is to achieve financial results. Undoubtedly, such an approach can be regarded as controversial, but it contributes to the universal character of the conducted research—which is its major objective, determining the adoption of the employed methodology.

The concept of research presented in the paper provides a universal tool for assessing the balanced effects of two major corporate management processes—value creation and financial security of going concern. Currently, corporate value is understood from the perspective of outlays and their effects. As a result, this value is associated with a company's ability to increase return on invested capital. Frequently, it leads to a sort of value creation "race"—at any cost, regardless of the possible threats posed by the employment of this strategy. Even if executives' activities do not assume the form of "a race for value", the obvious dilemma is still the choice between intensified corporate value creation and the financial security of going concern. According to classic theories, the use of financial support mechanisms (financial leverage) and the resulting indebtedness may lead to the loss of liquidity and insolvency. Such a threat should be detected by an early warning system, but only by a system

developed within a company. Such a system is founded on threat prediction methods and, currently appreciated for their efficiency, logit models. Such a methodological solution is offered in this paper to company executives. Simultaneously, the paper proposes an effective tool for measuring value creation with a broad understanding of value as internal and external value, which is similar to the idea of value for a company's broadly understood stakeholders: the environment, society and an economic system.

The significant thesis proved in this paper, related to the characteristics of manufacturing enterprises, is the degree of consistency of their profiles with value creation and financial security of going concern. This consistency is recorded for 31.6% of the analysed population, but only 10.4% of entities are marked by "high assessment of value—high assessment of security", which are the features of sustainable management leaders.

Further research will focus on analysing changes in the remaining company core activities (construction, transportation, information and communication, trade, services) and on formulating general conclusions for the entire populations of enterprises (over 50 thousand entities). Moreover, considering suggestions with regard to further analyses, future research will focus on comparisons by company size (small, medium, large), and the characteristics of different business profiles and strategies. Further research will require the acquisition of new analytical data.

**Funding:** Publication financed by funds granted to the Management Faculty of Cracow University of Economics under the scheme for subsidising university research potential.

**Conflicts of Interest:** The author declares no conflict of interest. The funder has no role in the design of the study; in the collection, analyses, or interpretation of data; in the writing of the manuscript, or in the decision to publish the results.

## References

1. Penc-Pietrzak, I. *Analiza Strategiczna w Zarządzaniu Firmą. Koncepcja i Stosowanie (Strategic Analysis in Company Management. Concept and Application)*; C.H. Beck: Warszawa, Poland, 2003; p. 14. (In Polish)
2. Olsen, E. Rethinking Value-Based Management. *Handb. Bus. Strategy* **2003**, *4*, 286–301. [[CrossRef](#)]
3. Cyfert, S.Z. *Kreowanie Wartości przez Organizację w Perspektywie Teorii Firmy (Creation of Value by the Organization from the Perspective of the Company's Theory)*; Akademia Ekonomiczna we Wrocławiu: Wrocław, Poland, 2004; pp. 25–32. (In Polish)
4. Cyert, R.M.; March, J.G. *A Behavioral Theory of the Firm*; Blackwell Publishers: Oxford, UK, 2001; p. 98.
5. Jakubów, L. *Spoleczne Uwarunkowania Rozwoju Przedsiębiorstwa (Social Determinants of the Company's Development)*; Akademia Ekonomiczna we Wrocławiu: Wrocław, Poland, 2000; p. 27. (In Polish)
6. Platonoff, A.L.; Sysko-Romańczuk, S. Dynamiczne modelowanie funkcjonowania przedsiębiorstwa (Dynamic Modelling of the Company's Functioning). *Organ. I Kier.* **2003**, *2*, 19–34. Available online: <http://bazekon.icm.edu.pl/bazekon/element/bwmeta1.element.ekon--element--00000011720> (accessed on 24 January 2019). (In Polish).
7. Gabruszewicz, W. Istota rozwoju przedsiębiorstwa (The Nature of the Company's Development). *Akad. Ekon. W Pozn. Work. Pap.* **1995**, *225*, 35–50. Available online: <http://bazekon.icm.edu.pl/bazekon/element/bwmeta1.element.ekon--element--00000001658> (accessed on 24 January 2019). (In Polish).
8. Chomałowski, S. Dynamika rozwoju a efektywność systemów przemysłowych (Dynamics of Development and Efficiency of Industrial Systems). *Akad. Ekon. W Krakowie Work. Pap.* **1993**, *115*, 1–218. (In Polish)
9. Młynarski, S.; Kaczmarek, J. Asset Productivity and Recovery in the Context of Corporate Restructuring (A Mezo-economic Approach). In *Contemporary Economies in The Face of New Challenges. Economic, Social and Legal Aspects*; Borowiecki, R., Jaki, A., Rojek, T., Eds.; Cracow University of Economics—Foundation of Cracow University of Economics: Cracow, Poland, 2013; pp. 417–431.
10. Osbert-Pociecha, G. Relacja między efektywnością a elastycznością organizacji (The Relationship between Efficiency and Flexibility of the Organisation). *Akad. Ekon. we Wrocławiu Work. Pap.* **2007**, *1183*, 337–349. Available online: <http://bazekon.icm.edu.pl/bazekon/element/bwmeta1.element.ekon--element--000170702153> (accessed on 24 January 2019). (In Polish).



11. Copeland, T.; Koller, T.; Murrin, J. *Valuation—Measuring and Managing the Values of Companies*; John Wiley Sons: New York, NY, USA, 2000; pp. 20–27.
12. Rappaport, A. *Creating Shareholder Value: A Guide for Managers and Investors*; The Free Press: New York, NY, USA, 1998; pp. 60–66.
13. Kaczmarek, J. The concept and Measurement of Creating Excess Value in Listed Companies. *Inz. Ekon. Eng. Econ.* **2018**, *29*, 376–385. [CrossRef]
14. Kaczmarek, J. The Quantification of Effectiveness in the Context of Shareholder Value and its Creation. In *Enterprise in Hardship Economics, Managerial and Juridical Perspectives*; D’Amico, A., Moschella, G., Eds.; ARACNE Editrice: Roma, Italy, 2014; pp. 293–308.
15. Jabłoński, A.; Jabłoński, M. Research on Business Models in their Life Cycle. *Sustainability* **2016**, *8*, 430. [CrossRef]
16. Szczepankowski, P. *Wycena i Zarządzanie Wartością Przedsiębiorstwa (Valuation and Management of Company Value)*; Wydawnictwo Naukowe PWN: Warszawa, Poland, 2007; p. 131. (In Polish)
17. Zarzecki, D. (Ed.) *Metody Wyceny Przedsiębiorstw: Zarys Teorii a Praktyka (Business Valuation Methods: An Overview of Theory and Practice)*; Uniwersytet Szczeciński: Szczecin, Poland, 2000; p. 11. (In Polish)
18. Dudycz, T. *Zarządzanie Wartością Przedsiębiorstwa (Management of Enterprise Value)*; PWE: Warszawa, Poland, 2005; pp. 177–248. (In Polish)
19. Senge, P. *The Fifth Discipline: The Art & Practice of The Learning Organization*; Doubleday, Currency: New York, NY, USA, 2006.
20. Senge, P.; Smith, B.; Kruschwitz, N.; Laur, J.; Schley, S. *The Necessary Revolution: How Individuals and Organizations Are Working Together to Create a Sustainable World*; Broadway Books: New York, NY, USA, 2008.
21. Kidd, C. The evolution of sustainability. *J. Agric. Environ. Ethics* **1992**, *5*, 1–26. [CrossRef]
22. Kreibich, R. *Nachhaltige Entwicklung. Leitbild für die Zukunft von Wirtschaft und Gesellschaft (Sustainable Development. Vision for the Future of Business and Society)*; Beltz Verlag: Weinheim, Germany; Basel, Switzerland, 1996. (In German)
23. Pfohl, H. *Logistiksysteme. Betriebswirtschaftliche Grundlagen (Logistics Systems. Business Fundamentals)*; Springer: Berlin, Germany, 1990; p. 16. (In German)
24. Minda, M.; Gregorczyk, M. Społeczna odpowiedzialność przedsiębiorstw (CSR) jako narzędzie zrównoważonego rozwoju (Corporate Social Responsibility (CSR) as a Tool for Sustainable Development). In *Zarządzanie w Warunkach Zrównoważonego Rozwoju (Governance in a Context of Sustainable Development)*; Żuchowski, J., Ed.; UTH: Radom, Poland, 2014; pp. 102–114. Available online: [https://www.uniwersytetradom.pl/files/get\\_userfile.php?id=6758](https://www.uniwersytetradom.pl/files/get_userfile.php?id=6758) (accessed on 25 March 2019). (In Polish)
25. Lidgreen, A.; Kotler, P.; Vanhamme, J.; Maon, F. *A stakeholder Approach to Corporate Social Responsibility: Pressures, Conflicts, and Reconciliation*; Routledge: London, UK; New York, NY, USA, 2016.
26. Jabłoński, A. Zrównoważony rozwój a zrównoważony biznes w budowie wartości przedsiębiorstw odpowiedzialnych społecznie (A Sustainable Development and Sustainable Business in Kreation of Value the Companies Responsible Socially). *Wyższa Szkoła Humanit. Work. Pap. Zarządzanie* **2010**, *2*, 15–30. Available online: <http://bazekon.icm.edu.pl/bazekon/element/bwmeta1.element.ekon--element--000171357885> (accessed on 25 March 2019). (In Polish).
27. Orsato, R.J. Competitive Environmental Strategies: When does it pay to be green? *Calif. Manag. Rev.* **2006**, *48*, 127–143. [CrossRef]
28. Hart, S.L. Beyond Greening: Strategies for a Sustainable World. *Harv. Bus. Rev.* **1997**, *75*, 66–76. Available online: <https://hbr.org/1997/01/beyond-greening-strategies-for-a-sustainable-world> (accessed on 25 March 2019).
29. Reinhardt, F.L. Bringing the environment down to earth. *Harv. Bus. Rev.* **1999**, *77*, 149–179. Available online: <https://hbr.org/1999/07/bringing-the-environment-down-to-earth> (accessed on 25 March 2019).
30. Placet, M.; Anderson, R.; Fowler, K.M. Strategies for Sustainability. *Res. Technol. Manag.* **2005**, *48*, 32–41. [CrossRef]
31. Cohen, S. *Sustainability Management*; Columbia University Press: New York, NY, USA, 2011.
32. Muller–Christ, G. *Sustainable Management*; Springer: New York, NY, USA, 2011.
33. Svenson, G.; Wood, G.; Callaghan, M. A corporate model of sustainable business practices: An ethical perspective. *J. World Bus.* **2010**, *45*, 336–345. [CrossRef]
34. Alexander, G.; Buchholtz, R. Corporate social responsibility and stock market performance. *Acad. Manag. J.* **1978**, *21*, 479–486. [CrossRef]

35. Porter, M.E.; Kramer, M.R. Creating Shared Value. *Harv. Bus. Rev.* **2011**, *89*, 62–77. Available online: <https://hbr.org/2011/01/the-big-idea-creating-shared-value> (accessed on 25 March 2019).
36. Hill, C.W.; Jones, T.M. Stakeholder-agency theory. *J. Manag. Stud.* **1992**, *29*, 131–154. [CrossRef]
37. Freeman, R.E. Divergent stakeholder theory. *Acad. Manag. Rev.* **1999**, *24*, 233–236. [CrossRef]
38. Donaldson, T.; Preston, L. Stakeholder Theory of the Corporation: Concepts, Evidence and Implications. *Acad. Manag. Rev.* **1995**, *20*, 65–91. [CrossRef]
39. Lenssen, G.G.; Smith, C. (Eds.) *Managing Sustainable Business. An Executive Education Case and Textbook*; Springer: Dordrecht, The Netherlands, 2019; pp. 224–225.
40. Cwynar, A.; Cwynar, W. *Kreowanie Wartości Spółki Poprzez Długoterminowe Decyzje Finansowe (Creation of Company Value Through Long-Term Financial Decisions)*; Polska Akademia Rachunkowości: Warszawa, Rzeszów, Poland, 2007; pp. 13–14. (In Polish)
41. Doś, A. Warunki i strategie kreacji wartości przedsiębiorstwa w oparciu o odpowiedzialność społeczną—ujęcie syntetyczne (Conditions and Strategies of Creating Company Value on the Basis of Corporate Social Responsibility—Synthetic Presentation). *e-Finanse* **2011**, *7*, 29–41. Available online: <https://www.researchgate.net/publication/308115952> (accessed on 25 March 2019).
42. Schepers, D.H.; Sethi, S.P. Do socially responsible funds actually deliver what they promise? Bridging the gap between the promise and performance of socially responsible funds. *Bus. Soc. Rev.* **2003**, *108*, 11–32. [CrossRef]
43. Hahn, T.; Figge, F.; Barkemeyer, R. Sustainable Value creation among companies in the manufacturing sector. *Int. J. Environ. Technol. Manag.* **2007**, *7*, 496–512. [CrossRef]
44. Klassen, R.D.; McLaughlin, C.P. The impact of environmental management on firm performance. *Manag. Sci.* **1996**, *42*, 1199–1214. [CrossRef]
45. Russo, M.V.; Fouts, P.A. A resource-based perspective on corporate environmental performance and profitability. *Acad. Manag. J.* **1997**, *40*, 534–559. [CrossRef]
46. Dangelico, R.; Pujari, D. Mainstreaming Green Product Innovation: Why and How Companies Integrate Environmental Sustainability. *J. Bus. Ethics* **2010**, *95*, 471–486. [CrossRef]
47. Figge, F.; Hahn, T. Sustainable value added. Measuring corporate contributions to sustainability beyond eco-efficiency. *Ecol. Econ.* **2004**, *48*, 173–187. [CrossRef]
48. Lo, S.F.; Sheu, H.J. Is Corporate Sustainability a Value-Increasing Strategy for Business? *Corp. Gov. Int. Rev.* **2007**, *15*, 345–358. [CrossRef]
49. York, J. Pragmatic Sustainability: Translating Environmental Ethics into Competitive Advantage. *J. Bus. Ethics* **2009**, *85*, 97–109. [CrossRef]
50. Hart, S.L.; Milstein, M.B. Creating sustainable value. *Acad. Manag. Exec.* **2003**, *17*, 56–67. [CrossRef]
51. Porter, M.E.; Kramer, M.R. Strategy & Society: The Link Between Competitive Advantage and Corporate Social Responsibility. *Harv. Bus. Rev.* **2006**, *84*, 78–92. Available online: <https://hbr.org/2006/12/strategy-and-society-the-link-between-competitive-advantage-and-corporate-social-responsibility> (accessed on 25 March 2019).
52. Evans, S.; Fernando, L.; Yang, M. Sustainable Value Creation—From Concept Towards Implementation. In *Sustainable Manufacturing. Sustainable Production, Life Cycle Engineering and Management*; Stark, R., Seliger, G., Bonvoisin, J., Eds.; Springer: Cham, Switzerland, 2017; pp. 203–220.
53. Meadows, D.H.; Wright, D. *Thinking in Systems: A Primer*; Earthscan Ltd.: London, UK, 2009.
54. Manzini, E.; Vezzoli, C. A strategic design approach to develop sustainable product service systems: Examples taken from the environmentally friendly innovation Italian prize. *J. Clean. Prod.* **2003**, *11*, 851–857. [CrossRef]
55. Charnley, F.; Lemon, M.; Evans, S. Exploring the process of whole system design. *Des. Stud.* **2011**, *32*, 156–179. [CrossRef]
56. Holmes, S.; Smart, P. Exploring open innovation practice in firm-nonprofit engagements: A corporate social responsibility perspective. *Rd Manag.* **2009**, *39*, 395–409. [CrossRef]
57. Bocken, N.; Short, S.W.; Evans, S. A literature and practice review to develop sustainable business model archetypes. *J. Clean. Prod.* **2014**, *65*, 42–56. [CrossRef]
58. Yang, M.; Evans, S.; Vladimirova, D.; Rana, P. Value uncaptured perspective for sustainable business model innovation. *J. Clean. Prod.* **2016**, *140*, 1794–1804. [CrossRef]
59. Mitroff, I.I.; Pearson, C.M. *Crises Management. A Diagnostic Guide for Improving Your Organization's Crisis-Preparedness*; Jossey-Bass Publishers: San Francisco, CA, USA, 1993.

60. Slatter, S.; Lovett, D. *Corporate Recovery: Managing Companies in Distress*; Beard Books: Frederick, MD, USA, 1999; p. 46.
61. Smart, C.F.; Thompson, W.A.; Vertinsky, I. Diagnosing Corporate Effectiveness and Susceptibility to Crisis. *J. Bus. Adm.* **1978**, *9*, 57–96.
62. Mączyńska, E. Upadłość przedsiębiorstw w kontekście ekonomii kryzysu (Business failure in the context of the economy of the crisis). In *Zarządzanie przedsiębiorstwem w kryzysie (Managing a Company in Crisis)*; Morawska, S., Ed.; SGH: Warszawa, Poland, 2011; pp. 12–34. (In Polish)
63. Zelek, A. Wczesna identyfikacja kryzysu ucieczką od bankructwa (Early Identification of the Crisis with an Escape from Bankruptcy). *Przegląd Organ.* **2002**, *2*, 32–36. Available online: <http://www.przegladoworganizacji.pl/plik/375/po200202pdf> (accessed on 24 January 2019). (In Polish)
64. Kaczmarek, J. Measurement of Creating Corporate Value for Shareholders—Development of Measurements and Improvement of Management Competence and Skills. *Pol. J. Manag. Stud.* **2014**, *9*, 72–83. Available online: <http://oaji.net/articles/2014/1384-1416997716.pdf> (accessed on 24 January 2019).
65. Kaczmarek, T.T. *Ryzyko Kryzysu a Ciągłość Działania (Risk of Crisis and Business Continuity)*; Difin: Warszawa, Poland, 2009. (In Polish)
66. Altman, E.I.; Narayanan, P. An International Survey of Business Failure Classification Models. *Financ. Mark. Inst. Instrum.* **1997**, *6*, 1–57. [CrossRef]
67. Platt, H.D.; Platt, M.B. Predicting Corporate Financial Distress: Reflection on Choice-Based Sample Bias. *J. Econ. Financ.* **2002**, *26*, 184–199. [CrossRef]
68. Pociecha, J. Model logitowy jako narzędzie prognozowania bankructwa—jego zalety i wady (Logit model as a bankruptcy forecasting tool—Its advantages and disadvantages). In *Spotkania z Królową Nauk (Meetings with the Queen of Science)*; Malawski, A., Tatar, J., Eds.; Uniwersytet Ekonomiczny w Krakowie: Kraków, Poland, 2012; pp. 60–74. (In Polish)
69. Kaczmarek, J. A Crisis and a Treat vs. the Financial Security Aspects of Going Concern. *Econ. Horiz.* **2014**, *16*, 191–205. Available online: [http://www.horizonti.ekfak.kg.ac.rs/sites/default/files/Casopis/2014\\_3/EN/Economic\\_Horizons\\_V16\\_N3.pdf](http://www.horizonti.ekfak.kg.ac.rs/sites/default/files/Casopis/2014_3/EN/Economic_Horizons_V16_N3.pdf) (accessed on 24 January 2019).
70. Lam, J. Ten Predictions for Risk Management. *Rma J.* **1985**, *5*, 84–85. Available online: <http://www.jameslam.com/images/PDF/RMA%20May%2003%20Ten%20Predictions%20May%202003.pdf> (accessed on 25 March 2019).
71. Zavgren, C. The Prediction of Corporate Failure: The State of the Art. *J. Account. Lit.* **1983**, *2*, 1–38.
72. Prusak, B. (Ed.) *Ekonomiczne i Prawne Aspekty Upadłości Przedsiębiorstw (Economic and Legal Aspects of Business Failure)*; Difin: Warszawa, Poland, 2007. (In Polish)
73. Cwynar, A.; Cwynar, W. *Zarządzanie Wartością Spółki Kapitałowej. Koncepcje, Systemy, Narzędzia (Management of the Value of a Capital Company. Concepts, Systems, Tools)*; FRRwP: Warszawa, Poland, 2002; pp. 385–411. (In Polish)
74. Rogowski, W. Możliwości wczesnego rozpoznania symptomów zagrożenia zdolności płatniczej przedsiębiorstwa (Possibilities of an Early Detection of Symptoms of Threats to a Company's Paying Capacity). *Bank i Kredyt* **1999**, *6*, 56–72. Available online: [http://bankikredyt.nbp.pl/home.aspx?f=/content/1999/1999\\_06/rogowski\\_pl.html](http://bankikredyt.nbp.pl/home.aspx?f=/content/1999/1999_06/rogowski_pl.html) (accessed on 25 March 2019). (In Polish)
75. Antonowicz, P. *Metody Oceny i Prognoza Kondycji Ekonomiczno-Finansowej Przedsiębiorstw (Methods of Evaluation and Forecast of the Economic and Financial Condition of Enterprises)*; ODiDK: Gdańsk, Poland, 2007; p. 30. (In Polish)
76. Zaleska, M. *Identyfikacja Ryzyka Upadłości Przedsiębiorstwa i Banku. Systemy Wczesnego Ostrzegania (Identification of the Risk of Bankruptcy of the Company and the Bank. Early Warning Systems)*; Difin: Warszawa, Poland, 2002; pp. 27–28. (In Polish)
77. Altman, E.I. *Corporate Financial Distress and Bankruptcy. A Complete Guide to Predicting & Avoiding Distress and Profiting from Bankruptcy*; John Wiley & Sons Press: New York, NY, USA, 1993.
78. Wierczyńska, B. *Kryzys w Przedsiębiorstwie (Crisis in the Company)*; CeDeWu: Warszawa, Poland, 2009; pp. 65–70. (In Polish)
79. Prusak, B. *Nowoczesne Metody Prognozowania Zagrożenia Finansowego Przedsiębiorstw (Modern Methods of Predicting the Financial Risk of Enterprises)*; Difin: Warszawa, Poland, 2005; pp. 105–186. (In Polish)

80. Fijorek, K.; Kaczmarek, J.; Kolegowicz, K.; Krzemiński, P. Ocena zagrożenia przedsiębiorstw upadłością—koncepcja systemowa ISR (Corporate insolvency risk assessment—Systemic concept of the RRI). *Przegląd Organ.* **2015**, *4*, 18–25. Available online: <http://www.przeglądorganizacji.pl/ocena-zagrozenia-przedsiębiorstw-upadloscia-koncepcja-systemowa-isr/numer-42015> (accessed on 24 January 2019). (In Polish).
81. Hosmer, D.W.; Lemeshow, S. *Applied Logistic Regression*; Wiley: New York, NY, USA, 1989; pp. 145–162.
82. Firth, D. Bias reduction of maximum likelihood estimates. *Biometrika* **1993**, *80*, 27–38. [CrossRef]
83. Heinze, G.; Schemper, M. A solution to the problem of separation in logistic regression. *Stat. Med.* **2002**, *21*, 2409–2419. [CrossRef]
84. Kaczmarek, J. Construction Elements of Bankruptcy Prediction Models in Multi-dimensional Early Warning Systems. *Pol. J. Manag. Stud.* **2012**, *5*, 136–149. Available online: <http://oaji.net/articles/2014/1384-1415183942.pdf> (accessed on 24 January 2019).
85. Fijorek, K.; Fijorek, D. Dobór zmiennych objaśniających metodą najlepszego podzbioru do modelu regresji logistycznej Firtha (Selection of Explanatory Variables Using the Best Subset Method for Firth's Logistic Regression Model). *Metod. Inform. Stosow.* **2011**, *2*, 15–24. Available online: <http://www.pan.wi.zut.edu.pl/mispdf/MIS-2011-2.pdf> (accessed on 25 March 2019).
86. Kaczmarek, J. *Mezostuktura Gospodarki Polski w Okresie Transformacji. Uwarunkowania, Procesy, Efektywność (Mesostucture of the Polish Economy in the Period of Transformation. Conditions, Processes, Effectiveness)*; Difin: Warszawa, Poland, 2012; pp. 130–137. (In Polish)
87. Podolec, B. Zarządzanie wydatkami gospodarstw domowych w Polsce—wybrane aspekty analizy statystycznej (Management of household expenditures in Poland—Selected aspects of statistical analysis). *Państwo i Społeczeństwo* **2017**, *2*, 13–34. Available online: [http://cejsh.icm.edu.pl/cejsh/element/bwmeta1.element.desklight-fa862e2a-e9dc-4226-a352-ae1935a43f6/c/pis\\_2017\\_2\\_01\\_Podolec.pdf](http://cejsh.icm.edu.pl/cejsh/element/bwmeta1.element.desklight-fa862e2a-e9dc-4226-a352-ae1935a43f6/c/pis_2017_2_01_Podolec.pdf) (accessed on 24 January 2019). (In Polish).
88. Młynarski, S.; Kaczmarek, J. Effectiveness of Functioning and Mechanisms of Creating Corporate Value in the Sector of Transport of Goods, Warehousing and Transport-Supporting Services. *Res. J. Univ. Gdańsk. Transp. Econ. Logist.* **2017**, *67*, 101–113. Available online: <http://www.znetil.ug.edu.pl/index.php/etil/article/download/88/75/> (accessed on 24 January 2019). [CrossRef]



Article

# Business Model as a Concept of Sustainability in the Banking Sector

Renata Karkowska

Faculty of Management, University of Warsaw, 00-927 Warsaw, Poland; rkarkowska@wz.uw.edu.pl

Received: 31 October 2019; Accepted: 17 December 2019; Published: 22 December 2019

**Abstract:** The paper presents the concept of a sustainable bank by developing a framework based on performance of different business models. Traditional banking and investment activities, such as trading in securities or securitization, may reduce the risk of commercial banks and provide an attractive approach to sustainable finance. Using the method of assessing the performance of a bank, the study appraises the degree of sustainability of the bank from different stakeholders' points of view. The aim of the article is to verify the research question: how does diversification of traditional activities of commercial banks affect their sustainability? The analysis has been extended by the importance of country-specific and macroeconomic factors. The survey was conducted on 368 commercial banks from European countries, using data from the period 1998–2015. The study contributes to the ongoing discussion on the recognized profitability and sustainability nexus as an important part of sustainable finance that may be a powerful solution to financial crises.

**Keywords:** banking; sustainability; banking activities; performance; business model

---

## 1. Introduction

Sustainable development of the company consists in taking care of various internal and external stakeholders [1], and in particular the combined effect on the planet, people, and economies [2]. Hence, the Global Alliance for Banking on Values (GABV) formulates a sustainable bank as providing services and products that satisfy the needs of the economy and people [3]. Financial institutions have lately identified sustainability as a significant part of their projects, manifesting that sustainable banking may be a strong answer to financial slumps. The answer to this challenge in the banking sector may be a change from traditional deposit-taking and lending towards investment based on revenues from fees and commission services such as trading, insurance, and asset management. Such transition is focused on diversification advantages. Quite a number of scholars emphasize the importance of business model and activity diversification for risk reduction and show how asset and income diversification can reduce the insolvency risk of the bank [4–6]. In other cases, research emphasizes divergent views of diversification as increasing instability and abnormal risk-taking behaviors [7–9]. Motivated by the ongoing investment liberalization of financial systems in Europe, I examine whether European banks benefit from diversification of activity by extending their business for managers and shareholders to effectively create a sustainable value of the bank.

The study is stimulated by the fast expansion of the discussion on sustainable banking understood as supplying “good” services and products which are expected to respond to the needs of people and protect the environment while making profit. The scope of such banking is documented by the increase of non-interest income in banking operations. After the global financial crisis, banks' strategies of reducing the traditional model and too high expectations ensuing from universalism can be observed. The first goal of this paper is to understand the current banking business models supporting sustainability backed by different interest and non-interest services. The academic problem of this research is to examine how non-interest activities in commercial banks (i.e., derivatives,

securities-based investment activities, trading) achieve positive effects such as the mentioned risk reduction and efficiency stability. The study estimates the level of diversification of banks' activities at the level of individual banks in 36 selected European countries, dividing the full sample into two groups: (i) 25 developed, and (ii) 11 developing countries. This paper investigates the diversification of activity and focuses on commercial European banks.

The paper contributes to the literature in three main ways. First, I measure the relationship between the bank's business model and its performance sustainability in different European countries, taking into account the level of economic development. Second, my study includes three measures of risk-adjusted performance to estimate how non-interest activities affected bank stability. I therefore employ accounting measures of bank profits such as Return on Assets (ROA), risk-adjusted return as ROA divided by standard deviation of ROA, and finally Z-score showing how falling profits can push a bank into insolvency.

The article consists of five parts: (1) Introduction; (2) Literature Review and Hypotheses; (3) Description of Data and the Research Method; (4) Presentation of Results; and (5) Conclusions.

## 2. A Brief Literature Review and Hypotheses

Considering that banking risk may be a consequence of wrong decisions made by managers about the level of accepted risk and may result from market factors, it seems reasonable to assume that the level of this risk in individual countries is affected by the same categories of factors, yet with different intensity and with a different response of individual banks or the entire banking sector.

This study aims at providing profitability evaluation instruments for a sustainable bank: firstly, for a variety of stakeholders and secondly, for alternative criteria among stakeholders. Finally, by combining all evaluated sides of the different stakeholders, a total rank of satisfaction could be evaluated for each bank. This later appraisal can be used to estimate the sustainability of banks. Figure 1 presents the characteristics of a variety of stakeholders in a hierarchical structure used to assess various aspects of banks' sustainability.

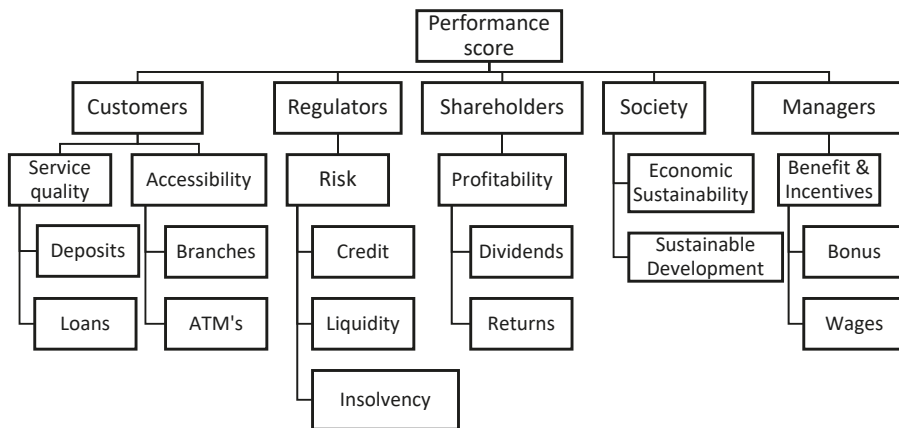

**Figure 1.** Hierarchical framework related to a variety of stakeholders in banks. Source: own study based on [10].

To meet the expectations of all stakeholders is difficult overall. The difficulty mostly lies in the complexity of satisfying contradictory requirements of multiple stakeholders. Borrowers hope for credits at the lowest cost, while this harmfully affects the bank's profit. Depositors look for high interest rates, which results in a strong charge on the bank. The 2007–2008 global financial crisis was an unsustainability crisis where financial institutions did not balance the interests of various stakeholders,

mainly focusing on the management's benefit [11,12]. The crisis provoked a reassessment of sustainable activity in the banking sector [13]. Banks must develop a new view after the crisis. In the literature, traditional banking activities are described as the financing of assets with liabilities and non-traditional activities based on fees and commission services undertaken by the bank [8]. Chronopoulos, Girardone, and Nankervis [14] offer a broad study on the evaluation of efficiency of European banks and indicate that diversification of banking activities positively influences their efficiency. Additionally, similar results were observed in their previous research [11]. Similarly, Peng et al. [15] examined the influence of bancassurance activity in Taiwan in 2004, and emphasized that financial institutions more engaged in similar activities tended to increase performance and gain higher benefits. Their study acknowledges that the use of a bancassurance strategy may affect the bank's efficiency. Similarly, using a sample of American commercial banks in the period of 2001–2011, Filson and Olfati [16] demonstrated that diversification towards insurance and brokerage (according to the Gramm-Leach-Bliley Act of 1999) gives the opportunity to improve banks' values. Williams [17], on the other hand, claims that in the Australian banking sector the diversification of interest income into non-traditional activities did not generate any advantages during the years 2002–2012. Moreover, he points out that non-interest income generating activities are more hazardous than traditional operations. Banks play the role of special agents in the sustainability process. They play an essential role in all forms of trade and industry through the funding and transfer of risk [18,19].

Therefore, this study is aimed at checking whether and to what extent a move towards non-traditional banking may impact the volatility of financial results and stability of banks. This is important for regulators responsible for maintaining the safety and stability of commercial banks, for managers with substantial interests in banks, and for customers from the perspective of the relationship of the bank to the borrower, which may be affected by larger profit volatility.

To estimate the bank's efficiency from managers' standpoint, I suppose that profit and encouragement are appropriate components of the gratification of managers. From the point of view of the clients, banks are most often assessed as suppliers of products and services. Finally, there are rules that protect participants in the financial system and ensure the stability of the whole financial system. To achieve these aims, regulators control risks (default risk, liquidity risk, and credit risk) as the elementary measure of banks' performance. Combining all rated results of the various stakeholders, a universal satisfaction for a bank can be judged as the sustainability of banks. There are not many papers in the literature on the impact of diversification of the bank's activities on its sustainability. Therefore, this paper presents many novel aspects, taking into account the problem that has not been identified so far. The main topic of the work on sustainability in the banking sector is the impact of asset quality on the bank's sustainability. In particular, Cooper, Jackson, and Patterson emphasize that a poor loan portfolio negatively influences the sustainability of banks [20]. On the other hand, there are items that measure the effect of the reversal, namely the importance of the bank's sustainability for its financial performance [21–24].

The main hypothesis of the research is as follows:

**Hypothesis 1 (H1).** *An increase in the diversification of the bank's activities generates an increase in sustainability.*

From the viewpoints of European countries, the ongoing euro area crisis has crucial implications for the European financial groups operating in Central and Eastern European countries. The global financial crisis has affected the countries of Central and Eastern Europe at the time of relatively strong financial integration with highly developed economies. Yet, given different models and development of their financial markets, their vulnerability to external shocks was also different. A sustainable value leads to positive financial results of banks during the financial crisis. As stressed by Stankeviciene and Nikonorova, the number of banks in the European Union that implement a sustainable development strategy is systematically growing to avoid an economic slowdown during the crisis [24]. I do believe

that research aimed at discovering the market mechanisms that cause banking risk will identify new crisis transmission channels and allow for early warning indicators to be developed. I thus expect a significantly stronger relationship between diversification of the bank's activities and its sustainability in developed countries.

**Hypothesis 2 (H2).** *High diversification of the bank's activities leads to higher bank sustainability in developed countries in Europe.*

The last decades have been a period of changes in the financial market, driven by strong competition in the conditions of globalization and deregulation. The deregulation process has reduced the barriers to market access and given the opportunity to establish new, competitive institutions. Banks, losing their privileged position, started to fight for a competitive advantage by developing new, often non-traditional ways of generating revenues. In order to increase their income, banks increased their activity in the off-balance-sheet asset market.

### 3. Data and Methodology

Based on a survey conducted by Mercieca, Schaeck, and Wolf [25], I develop a ratio of diversification of banking activities for each commercial bank to calculate the level of the differentiation between principal operations. The ratio of diversification of banking activities (DIV) for a bank is estimated as follows:

$$DIV = \left( \frac{NONII}{NETINC} \right)^2 + \left( \frac{NII}{NETINC} \right)^2 \quad (1)$$

where net operating income  $NETINC = NII + NONI$ ,  $NII$ —net interest income, and  $NONI$ —non-interest income. Net operating income is the amount of non-interest and interest income. Net non-interest income is the difference between non-interest income and non-interest expenses. The DIV indicator covers diversification of banking operations. With an increase in the DIV ratio, the bank is increasingly concentrated and less diversified.

Based on research undertaken by Demirgüç-Kunt and Huizinga [26] and Laeven and Levine [27], a number of measures of bank instability were adopted as the basis for the bank's sensitivity to changes in non-interest income (generated from non-traditional activities). However, compared to previous surveys, the study introduces a new model based on several explained variables. In particular, the study uses three measures: ROA, risk-adjusted ROA, and Z-score. These ratios use both the bank's profitability and its leverage. The choice of indicator has been confirmed in the literature—in particular, Calmès and Théoret [28] emphasize that banks focusing on non-traditional investment activities are focused on high profitability with equally high leverage risk. The explanatory variables include both financial results for interest and non-interest activities and the bank's exposure to securities and derivatives portfolios, as well as macroeconomic variables.

To verify the hypotheses, the Ordinary Least Squares regression (OLS) model is used as presented in the Equation (2):

$$Y_{n,i,t} = \alpha + \beta_1 SIZE_{n,i,t} + \beta_2 SECUR\_TA_{n,i,t} + \beta_3 DER\_TA_{n,i,t} + \beta_4 LOAN\_TA_{n,i,t} + \beta_5 NONI_{n,i,t} + \beta_6 NII_{n,i,t} + \beta_7 DIV_{n,i,t} + \beta_8 GDP_{i,t} + \beta_9 UNEMP_{i,t} + \beta_{10} TIME\_DUM_t + \beta_{11} COUNTRY\_DUM_i + \varepsilon_{i,t} \quad (2)$$

where  $Y$  is the bank's efficiency measure; I use  $Y = [ROA, ROA\_ADJ, ZSCORE]$  as dependent variables, where ROA is the return-on-assets ratio;  $ROA\_ADJ$  ratio is ROA-adjusted risk estimated as  $\frac{ROA}{\sigma_{ROA}}$ , and a smaller ratio means higher risk weighted profits; ZSCORE is a default ratio estimated as  $\frac{CAR + ROA}{\sigma_{ROA}}$ ; SIZE is the logarithm of the bank's total assets; SECUR\_TA is the securities-to-total assets ratio; DER\_TA is derivatives assets/total assets; LOAN\_TA = loans to total assets; and NONI = non-interest income ratio (non-interest income/operating revenues). Taking into account the problems of collinearity



because of banking control variables, I made a selection of variables and considered only variables whose correlation is the lowest. A similar model was used by Lepetit, Nys, Rous, and Tarazi [29], De Jonghe et al. [30], Stiroh and Rumble [31]; Meslier et al. [32], and Mostak [33]. NII is calculated as the net interest income ratio (interest income/operating revenues); DIV is the ratio of diversification of banking activities estimated according to the formula (Equation (1)); UNEMP = rate of annual unemployment; GDP = growth of gross domestic product; TIME\_DUM and COUNTRY\_DUM are dummy variables for time and country; and COUNTRY\_DUM variable is a country fixed effect. Finally, a random component is  $\epsilon$ . Thus, my coefficients show conditional correlations between the various measures of bank performance and the pursued diversification strategies.

Through a dataset that covers 368 commercial banks from Bankscope database spanning the 1998–2015 period and the methodology of panel regression, the empirical findings document the risk diversification in banking activity. The full range covers banks from 25 developed European countries (Austria, Belgium, Cyprus, Czech Republic, Denmark, Estonia, Finland, France, Germany, Greece, Iceland, Ireland, Italy, Latvia, Luxembourg, Malta, The Netherlands, Norway, Portugal, Slovakia, Slovenia, Spain, Sweden, Switzerland, and the United Kingdom) and 11 developing countries (Albania, Bosnia and Herzegovina, Bulgaria, Croatia, Hungary, Lithuania, Macedonia, Montenegro, Poland, Romania, and Serbia). The indicated division was made on the basis of GDP per capita ratio, according to The World Bank classification. A similar study for 1999–2006 was carried out by Lozano-Vivas and Pasiouras [34].

Tables 1 and 2 (Panel A) indicate that total assets, loans, securities, and derivatives have increased significantly in developed and developing countries. However, in developed countries, this increase was higher. On the other hand, Tables 1 and 2 (Panel B) present descriptive statistics of banks' average indicators. Moreover, in developed countries I find a decrease in ROA, non-interest income to operating income and interest income to operating income, respectively, while in developing countries only the securities-to-total assets ratio decreased.

**Table 1.** Statistics for changes in nominal value of bank's assets/liabilities (Panel A), and summary statistics for ratios of bank's income diversification and macroeconomic characteristics (Panel B) in European developed countries, 1998–2015.

Developed Countries			
Panel A	1998	2015	Change %
Total assets (B EUR)	103.00	164.00	59
Total loans (B EUR)	52.30	120.00	129
Total securities (B EUR)	21.15	79.60	276
Derivatives (B EUR)	3.06	32.28	955
Total equity (B EUR)	3.58	14.82	315
Net interest income (B EUR)	4.03	4.33	7
Total non-interest income (B EUR)	0.96	2.37	147
Panel B	1998	2015	Change %
ROA (%)	0.01	0.01	−10
ROA risk adjusted (%)	0.56	1.28	129
ZSCORE	7.26	18.04	148
Securities to total assets (%)	0.20	0.46	130
Derivatives to total assets (%)	0.02	0.18	8
Loans to total assets (%)	0.50	0.79	58
Non-interest income to operating income (%)	4.54	2.43	−46
Interest income to operating income (%)	19.19	5.62	−71
Diversification index (%)	0.51	0.65	27
Unemployment rate (%)	4.48	10.11	126
GDP growth (%)	3.56	2.77	−22

The index of diversification of banking activities is on average higher in developing countries, and increased from 0.92 in 1998 to 0.93 in 2015 for commercial banks from developing countries and

from 0.51 in 1998 to 0.65 in 2015 for commercial banks from developed countries. As the diversification index rises, the bank becomes more concentrated and less diversified.

**Table 2.** Summary statistics for changes in nominal value of bank's assets/liabilities (Panel A), and summary statistics for ratios of bank's income diversification and macroeconomic characteristics (Panel B) in European developing countries, 1998–2015.

Developing Countries			
Panel A	1998	2015	Change %
Total assets (B EUR)	72.78	90.39	24
Total loans (B EUR)	35.83	61.75	72
Total securities (B EUR)	16.52	41.54	151
Derivatives (B EUR)	2.04	8.44	314
Total equity (B EUR)	2.64	10.55	300
Net interest income (B EUR)	2.98	3.49	17
Total non-interest income (B EUR)	0.68	1.51	123
Panel B	1998	2015	Change %
ROA (%)	0.01	0.01	11
ROA risk adjusted (%)	1.55	2.75	77
ZSCORE	11.39	23.36	105
Securities to total assets (%)	0.33	0.32	−3
Derivatives to total assets (%)	0.01	0.06	500
Loans to total assets (%)	0.41	0.63	54
Non-interest income to operating income (%)	3.37	17.47	418
Interest income to operating income (%)	15.25	15.32	0
Diversification index (%)	0.92	0.93	1
Unemployment rate (%)	5.52	6.62	20
GDP growth (%)	2.49	1.92	−23

Table 3 reports the descriptive statistics for the whole sample of 368 commercial banks from Europe. The average value for the ROA is −0.06%, with the standard deviation 4.27%, and ROA\_ADJ variable is 2.25%, with the standard deviation 4.35%. The mean value of ZSCORE is 17.95 with the standard deviation 24.68%. Average non-interest income ratio is 14.14%, and ranges from −204.41% to 7437.90%. Regarding interest income ratio average value is 15.76%. The median value for diversification index (DIV) is 6.36, with the standard deviation 226.04. It means that diversification of banking activity varied in the full sample of commercial banks.

**Table 3.** Descriptive statistics full sample of commercial banks in European countries, 1998–2015.

	Mean	Sd	Min	Max
ROA (%)	−0.06	4.27	−272.27	0.52
ROA_ADJ (%)	2.25	4.35	−3.87	87.79
ZSCORE	17.95	24.68	−14.05	508.12
SECUR_TA (%)	0.33	0.63	0.00	7.32
DER_TA (%)	0.07	0.33	0.00	4.64
LOAN_TA (%)	0.76	5.38	0.00	340.36
NONII (%)	14.14	209.15	−204.41	7437.90
NII (%)	15.76	203.85	−519.78	9424.84
DIV (%)	6.36	226.04	0.50	13,843.33
UNEMP (%)	7.13	3.61	0.66	27.48
GDP (%)	3.11	3.76	−14.15	34.50
Observations #	1393	1393	1393	1393
Banks #	368	368	368	368

Source: Author's calculations based on Bankscope and World Bank database. DIV—diversification ratio estimated according to Equation (1); RO—return on assets; ROA\_ADJ—risk adjusted profit; ZSCORE—bank's default ratio; SECUR\_TA—securities to total assets ratio; DER\_TA—derivatives assets/total assets; LOAN\_TA—loans to total assets; NONII—non-interest income ratio (non-interest income/operating revenues); NII—net interest income ratio (interest income/operating revenues); UNEMP—rate of annual unemployment; GDP—growth of gross domestic product; #—number of observations and banks respectively.

#### 4. Results and Discussion

The first regression results cover the entire sample of banks, the second one discriminates between the degrees of countries' development, and the third one focuses on public commercial banks. Table 4 presents the average scores for risk-adjusted performance (Model 1 ROA, Model 2 ROA\_ADJ, Model 3 ZSCORE). The first regression results concern the whole sample covering all banks and show that the index of diversification of banking activities has a slight and statistically insignificant influence on the ROA and risk-adjusted ROA ratio (DIV +0.001 vs. −0.019). However, the average ZSCORE ratio decreases in Model 3 when I control for the diversification index (DIV −0.133). As the diversification index rises, the bank becomes more concentrated and less diversified. It means that more traditional activities increase the insolvency risk in commercial banks in Europe. In general, the banking risk decreases when non-interest activity increases (NONI +0.075). It means lower risk-taking by banks. In all cases (Model 1 and 2), the average performance decreases with the inclusion of non-interest income (NONI −0.001 vs. −0.24) but the average insolvency risk measured by ZSCORE decreases (NONI +0.075). In greater detail, the inclusion of derivatives in the ROA and ROA\_ADJ function results in a decrease in the average scores (DER\_TA −0.005 vs. −0.158). However, in Model 3 it influences positively the insolvency risk (DER\_TA +0.2). The bank's performance and risk are strongly sensitive to the size of assets SIZE (Model 1 −0.003, Model 2 −0.395, Model 3 −0.078). The model also estimates the impact of different activities undertaken by banks, including security trading measured by the level of security to total assets in the bank. As for bank performance, the corresponding figures are +0.0001 (Model 1), −0.003 (Model 2), and +0.032 (Model 3). And credit policy is measured by the loans-to-assets ratio. These results suggest that performance and insolvency risk have a positive influence. Among macroeconomic factors, the changes in the annual real GDP growth rate exhibited a positive result, meaning that the GDP growth rate decreases banking stability.

**Table 4.** Risk-adjusted performance and diversification measure in commercial banks in European countries, over the period 1998–2015.

	ROA (Model 1)	ROA_ADJ (Model 2)	ZSCORE (Model 3)
	b/t	b/t	b/t
TA	−0.003 *** (−3.99)	−0.395 *** (−5.73)	−0.078 ** (−2.87)
SECUR_TA	0.001 * (1.85)	−0.003 (−0.07)	0.032 (1.56)
DER_TA	−0.005 *** (−5.40)	−0.158 * (−1.69)	0.200 *** (5.40)
LOAN_TA	0.007 *** (12.95)	0.210 *** (3.66)	0.439 *** (19.26)
NONII	−0.001 ** (−2.26)	−0.240 *** (−4.03)	0.075 *** (3.18)
NII	−0.005 *** (−8.81)	−0.436 *** (−7.64)	−0.110 *** (−4.88)
DIVERS	0.001 (1.48)	−0.019 (−0.20)	−0.133 *** (−3.54)
UNEMPLOY	−0.000 * (−1.79)	−0.016 (−1.46)	0.035 *** (7.81)

Table 4. Cont.

	ROA (Model 1)	ROA_ADJ (Model 2)	ZSCORE (Model 3)
	b/t	b/t	b/t
GDP	0.000 (0.01)	0.047 * (1.84)	−0.011 (−1.03)
CONSTANT	0.065 *** (5.45)	9.697 *** (7.85)	3.163 *** (6.45)
Obs	769	756	756
# banks	148	135	135
R-sqr	0.5	0.4	0.6

DIV—diversification ratio estimated according to Equation (1); ROA—return on assets ratio; ROA\_ADJ; ZSCORE—bank's default ratio; SIZE—logarithm of total assets; SECUR\_TA—securities to total assets ratio; DER\_TA—derivatives assets/total assets; LOAN\_TA—loans to total assets; NONI—non-interest income ratio (non-interest income/operating revenues); NII—net interest income ratio (interest income/operating revenues); UNEMP—rate of annual unemployment; GDP—growth of gross domestic product; #—number of banks. In parentheses t statistics are given. The *p*-value defines significance levels at \*\*\* *p* < 0.01, \*\* *p* < 0.05, \* *p* < 0.1, accordingly.

In summary, the results so far support the importance of non-traditional activities for the bank's sustainability, which is consistent with hypothesis H1.

The second regression model, presented in Table 5, discriminates between the degrees of countries' development. To explore my findings further, I divided the full sample into developed and developing countries groups. Table 5 presents the average performance scores by the country's level of development. The results show that diversification of banking activities disaggregated by the group of countries also influences positively the bank's solvency but decreases income results.

Table 5. Risk-adjusted performance and diversification measure in European developed and developing countries, over the period 1998–2015.

	Model 1A ROA (Developed)	Model 1B ROA (Developing)	Model 2A ROA_ADJ (Developed)	Model 2B ROA_ADJ (Developing)	Model 3A ZSCORE (Developed)	Model 3B ZSCORE (Developing)
	b/t	b/t	b/t	b/t	b/t	b/t
TA	−0.003 *** (−5.31)	−0.003 *** (−3.99)	−0.405 *** (−6.62)	−0.395 *** (−5.73)	−0.058 ** (−2.86)	−0.078 ** (−2.87)
SECUR_TA	0.001 *** (2.59)	0.001 * (1.85)	0.010 (0.18)	−0.003 (−0.07)	0.038 ** (2.18)	0.032 (1.56)
DER_TA	−0.006 *** (−6.55)	−0.005 *** (−5.40)	−0.207 ** (−2.07)	−0.158 * (−1.69)	0.201 *** (6.15)	0.200 *** (5.40)
LOAN_TA	0.007 *** (13.42)	0.007 *** (12.95)	0.191 *** (3.23)	0.210 *** (3.66)	0.434 *** (22.39)	0.439 *** (19.26)
NONII	−0.001 *** (−3.77)	−0.001 ** (−2.26)	−0.202 *** (−4.96)	−0.240 *** (−4.03)	0.033 ** (2.40)	0.075 *** (3.18)
NII	−0.002 *** (−7.61)	−0.005 *** (−8.81)	−0.295 *** (−7.99)	−0.436 *** (−7.64)	−0.055 *** (−4.41)	−0.110 *** (−4.88)
DIVERS	0.000 (0.34)	0.001 (1.48)	−0.135 * (−1.68)	−0.019 (−0.20)	−0.111 *** (−4.17)	−0.133 *** (−3.54)
UNEMPLOY	−0.000 *** (−2.98)	−0.000 * (−1.79)	−0.013 (−1.21)	−0.016 (−1.46)	0.034 *** (9.59)	0.035 *** (7.81)
GDP	0.000 (1.64)	0.000 (0.01)	0.102 *** (3.94)	0.047 * (1.84)	−0.004 (−0.43)	−0.011 (−1.03)
CONSTANT	0.063 *** (6.59)	0.065 *** (5.45)	10.172 *** (9.07)	9.697 *** (7.85)	3.055 *** (8.29)	3.163 *** (6.45)
Obs	1220	769	1207	756	1197	756
# banks	219	148	206	135	206	135
R-sqr	0.4	0.5	0.3	0.4	0.6	0.6

DIV—diversification ratio estimated according to Equation (1); ROA—return on assets ratio; ROA\_ADJ—risk-adjusted ROA; ZSCORE—bank's default ratio; SIZE—logarithm of total assets; SECUR\_TA—securities to total assets ratio; DER\_TA—derivatives assets/total assets; LOAN\_TA—loans to total assets; NONI—non-interest income ratio (non-interest income/operating revenues); NII—net interest income ratio (interest income/operating revenues); UNEMP—rate of annual unemployment; GDP—growth of gross domestic product; #—number of banks. In parentheses t statistics are given. The *p*-value defines significance levels at \*\*\* *p* < 0.01, \*\* *p* < 0.05, \* *p* < 0.1, accordingly.

The comparison of models A and B indicates that the inclusion of non-interest income in the output results in mean performance scores that are positive and statistically significant irrespective of the level of development. However stronger influences could be observed in the case of Central and Eastern Europe than in Western Europe (in Model 2A and Model 2B NONI  $-0.202$  vs.  $-0.24$ ; and in Model 2A and Model 2B NONI  $0.033$  vs.  $0.075$ ). Turning to the estimates of the importance of non-traditional activities for the bank's performance, hypothesis H2 that high bank diversification leads to higher bank performance in developed countries in Europe can be partially rejected as the relationship is positive but stronger in developing countries.

As a robustness check, I narrowed the full sample only to listed commercial banks in Europe and estimated the relationship between non-traditional activities and the bank's performance and sustainability. The selection of listed banks was dictated by their specific obligations to comply with corporate governance principles. The results, displayed in Table 6, show that my main results continue to hold and they are straightforward and relatively robust across the three models.

**Table 6.** Risk-adjusted performance and diversification measure in public commercial banks in European, over the period 1998–2015.

	ROA	ROA_ADJ	ZSCORE
	b/t	b/t	b/t
TA	$-0.004^{***}$ ( $-3.96$ )	$-0.193^{***}$ ( $-4.70$ )	$-0.038^{**}$ ( $-2.33$ )
SECUR_TA	$0.008^{***}$ ( $7.43$ )	$0.156^{***}$ ( $3.05$ )	$0.205^{***}$ ( $10.15$ )
DER_TA	$-0.006^{***}$ ( $-2.63$ )	$-0.143$ ( $-1.41$ )	$0.249^{***}$ ( $6.20$ )
LOAN_TA	$0.004^{***}$ ( $4.38$ )	$0.141^{***}$ ( $3.59$ )	$0.240^{***}$ ( $15.51$ )
NONII	$-0.004^{***}$ ( $-5.35$ )	$-0.145^{***}$ ( $-3.95$ )	$0.049^{***}$ ( $3.32$ )
NII	$-0.007^{***}$ ( $-8.38$ )	$-0.484^{***}$ ( $-13.82$ )	$-0.060^{***}$ ( $-4.34$ )
DIVERS	$-0.001$ ( $-1.15$ )	$-0.053$ ( $-1.35$ )	$-0.026^*$ ( $-1.70$ )
UNEMPLOY	$-0.000^*$ ( $-1.95$ )	$-0.019^*$ ( $-1.78$ )	$0.022^{***}$ ( $5.09$ )
GDP	$-0.002^{***}$ ( $-2.94$ )	$0.047^{**}$ ( $2.02$ )	$-0.023^{**}$ ( $-2.44$ )
CONSTANT	$0.088^{***}$ ( $5.37$ )	$7.084^{***}$ ( $9.60$ )	$2.718^{***}$ ( $9.34$ )
Obs	1848	1835	1832
# banks	331	318	318
R-sqr	0.2	0.3	0.4

DIV—diversification ratio estimated according to Equation (1); ROA—return on assets ratio; ROA\_ADJ—risk adjusted ROA; ZSCORE—bank's insolvency ratio; SIZE—logarithm of total assets; SECUR\_TA—securities to total assets ratio; DER\_TA—derivatives assets/total assets; LOAN\_TA—loans to total assets; NONI—non-interest income ratio (non-interest income/operating revenues); NII—net interest income ratio (interest income/operating revenues); UNEMP—rate of annual unemployment; GDP—growth of gross domestic product; #—number of banks. In parentheses t statistics are given. The  $p$ -value defines significance levels at  $*** p < 0.01$ ,  $** p < 0.05$ ,  $* p < 0.1$ , accordingly.

## 5. Conclusions

This study provides useful insights on the views of risk diversification as the measure of sustainability. Certainty, the estimate utility functions of risk diversification are used to calculate the utility indicator for bank performance. The bank's performance estimate provides a picture of the degree of its sustainability. Vickers' 2011 report [35] highlighted the importance of separating retail operations of systemically important banks and the need to strengthen the capital base, including the strengthening of retail banking requirements. It is worth noting that a separation of retail and investment banks would strengthen their capacity to absorb losses and enhance the risk of insolvency.

This study emphasizes the inclusion of proxies for non-traditional activities as an output in studies of bank performance. A closer investigation shows a positive relationship between risk-adjusted performance and income diversification. In all cases, risk is mainly positively correlated with the share of fee-based activities.

I use a sample of 368 commercial banks from 25 developed and 11 developing European countries spanning the 1998–2015 period and estimate the inclusion of traditional and non-traditional activities on the bank's sustainability across countries.

The study highlights several important issues: a) for commercial bank stakeholders: diversification of commercial bank income through non-traditional activities may have beneficial results for bank stability/performance, but this is volatile income that may trigger an additional risk of default or increased loan costs, particularly for small-sized affiliates in small banks; and b) for supervisors: the widespread bank portfolio diversification makes them more comparable and strengthens the interdependency between market participants, thereby increasing systemic risk. The lack of sustainability, especially in crisis situations, when banks do not deal with the issue of balancing the interests of various stakeholders, with a skewed emphasis on individual benefits for senior management, is not conducive to the stability of the financial sector, and thus people and the economy as a whole [36]. In addition, it can be concluded that the integration of traditional and investment banking activities may decrease the risk of commercial banks. However, researchers are more prudent and point out that while an increase in the versatility of banking operations may potentially reduce risk, the benefits of risk diversification are limited [37].

My findings have two broad implications for research on commercial banks in Europe. First, the diversification process based on different sources of non-interest income has positive effects on bank sustainability. Second, my results point out that non-traditional activities tend to reflect the bank's sustainability a little more strongly in developing countries of Europe. The study provides a basis for continuation towards the verification of the importance of banking services provided for the sustainable development of the economy.

**Funding:** This research received funding from University of Warsaw.

**Conflicts of Interest:** The author declares no conflict of interest.

## References

1. Freeman, R.E. *Strategic Management: A Stakeholder Approach*; Cambridge University Press: Cambridge, UK, 2010.
2. Fisk, P. *People Planet Profit: How to Embrace Sustainability for Innovation and Business Growth*; Kogan Page Publishers: London, UK, 2010.
3. Global Alliance for Banking on Values (GABV) Strong, Straightforward and Sustainable Banking. A Report on Financial Capital and Impact Metrics of Values Based Banking. 2012. Available online: [www.gabv.org/wp-content/uploads/Full-Report-GABV-v9d.pdf](http://www.gabv.org/wp-content/uploads/Full-Report-GABV-v9d.pdf) (accessed on 24 October 2019).
4. Nguyen, M.; Skully, M.; Perera, S. Market power, revenue diversification and bank stability: Evidence from selected South Asian countries. *J. Int. Financ. Mark. Inst. Money* **2012**, *22*, 897–912. [CrossRef]
5. Deng, S.; Elyasiani, E.; Jia, J. Institutional ownership, diversification, and riskiness of bank holding companies. *Financ. Rev.* **2013**, *48*, 385–415. [CrossRef]

6. Amidue, M.; Wolfe, S. Does bank competition and diversification lead to greater stability? Evidence from emerging markets. *Rev. Financ. Dev.* **2013**, *3*, 152–166. [CrossRef]
7. Rogers, K.; Sinkey, J.F., Jr. An analysis of non-traditional activities at U.S. commercial banks. *Rev. Financ. Econ.* **1999**, *8*, 25–39. [CrossRef]
8. Rogers, K.E. Nontraditional activities and the efficiency of US commercial banks. *J. Bank. Financ.* **1998**, *22*, 467–482. [CrossRef]
9. Stiroh, K.J. How did bank holding companies prosper in the 1990s? *J. Bank. Financ.* **2000**, *24*, 1703–1745. [CrossRef]
10. Rebai, S.; Azaiez, M.N.; Saidane, D. Sustainable Performance Evaluation of Banks using a Multi-attribute Utility Model: An Application to French Banks. *Procedia Econ. Financ.* **2012**, *2*, 363–372. [CrossRef]
11. Polonskaya, J.; Babenko, M. *Best Practice Guide on Sustainable Finance: A Practical Toolkit for Russian Financial Sector*; WWF Sustainable Finance Programme Report; World Wide Fund: Moscow, Russia, 2012.
12. Seyfang, G.; Gilbert-Squires, A. Move your money? Sustainability Transitions in Regimes and Practices in the UK Retail Banking Sector. *Ecol. Econ.* **2019**, *156*, 224–235. [CrossRef]
13. Stephens, B.; Caplain, J.; Montes, D.; Siegel, M. Transformation of Banking: Forces, Implications and Actions. Financial Services. 2012. Available online: <https://www.kpmg.com/US/en/IssuesAndInsights/ArticlesPublications/Documents/transformation-of-banking-forces.pdf> (accessed on 28 November 2016).
14. Chronopoulos, D.K.; Girardone, C.; Nankervis, J.C. Are there any cost and profit efficiency gains in financial conglomeration? Evidence from the accession countries. *Eur. J. Financ.* **2011**, *17*, 603–621. [CrossRef]
15. Peng, J.L.; Jeng, V.; Wang, J.L.; Chen, Y.C. The impact of bancassurance on efficiency and profitability of banks: Evidence from the banking industry in Taiwan. *J. Bank. Financ.* **2017**, *80*, 1–13. [CrossRef]
16. Filson, D.; Olfati, S. The impacts of Gramm–Leach–Bliley bank diversification on value and risk. *J. Bank. Financ.* **2013**, *41*, 209–221. [CrossRef]
17. Williams, B. The impact of non-interest income on bank risk in Australia. *J. Bank. Financ.* **2016**, *73*, 16–37. [CrossRef]
18. Jeucken, M. *Sustainable Finance and Banking: The Financial Sector and the Future of the Planet*; Routledge: London, UK, 2010.
19. Jeucken, M.H.; Bouma, J.J. The changing environment of banks. *Greener Manag. Int.* **1999**, *27*, 20–35. [CrossRef]
20. Cooper, M.; Jackson, W.; Patterson, G. Evidence of predictability in the cross-section of bank stock returns. *J. Bank. Financ.* **2003**, *27*, 817–850. [CrossRef]
21. Desai, Y.H.; Rajgopal, S.J.J. Were Information Intermediaries Sensitive to the Financial Statement-Based Leading Indicators of Bank Distress Prior to the Financial Crisis? *Contemp. Account. Res.* **2016**, *33*, 607–615. [CrossRef]
22. Liang, L.W.; Chang, H.Y.; Shao, H.L. Does sustainability make banks more cost efficient? *Glob. Financ. J.* **2018**, *38*, 13–23. [CrossRef]
23. Nizam, E.; Ng, A.; Dewandaru, G.; Nagayev, R.; Nkoba, M.A. The impact of social and environmental sustainability on financial performance: A global analysis of the banking sector. *J. Multinatl. Financ. Manag.* **2019**, *49*, 35–53. [CrossRef]
24. Stankeviciene, J.; Nikonorova, M. Sustainable Value Creation in Commercial Banks During Financial Crisis. *Procedia Soc. Behav. Sci.* **2014**, *110*, 1197–1208. [CrossRef]
25. Mercieca, S.; Schaeck, K.; Wolfe, S. Small European banks: Benefits from diversification? *J. Bank. Financ.* **2007**, *31*, 1975–1998. [CrossRef]
26. Demirgüç-Kunt, A.; Huizinga, H. Bank activity and funding strategies: The impact on risk and returns. *J. Financ. Econ.* **2010**, *98*, 626–650. [CrossRef]
27. Laeven, L.; Levine, R. Is There a Diversification Discount in Financial Conglomerates? NBER Working Paper Series 2007, Working Paper 11499. Available online: <http://www.nber.org/papers/w11499> (accessed on 16 June 2018).
28. Calmès, C.; Théoret, R. The impact of off-balance-sheet activities on banks returns: An application of the ARCH-M to Canadian data. *J. Bank. Financ.* **2010**, *34*, 1719–1728. [CrossRef]
29. Lepetit, L.; Nys, E.; Rous, P.; Tarazi, A. Bank income structure and risk: An empirical analysis of European banks. *J. Bank. Financ.* **2008**, *32*, 1452–1467. [CrossRef]

30. De Jonghe, O.; Diepstraten, M.; Schepens, G. Banks' size, scope and systemic risk: What role for conflicts of interest? *J. Bank. Financ.* **2015**, *61*, S3–S13. [[CrossRef](#)]
31. Stiroh, K.; Rumble, A. The dark side of diversification: The case of US financial holding companies. *J. Bank. Financ.* **2006**, *30*, 2131–2161. [[CrossRef](#)]
32. Meslier, C.; Tacneng, R.; Tarazi, A. Is bank income diversification beneficial? Evidence from an emerging economy. *J. Int. Financ. Mark. Inst. Money* **2014**, *31*, 97–126. [[CrossRef](#)]
33. Mostak, A. Asset quality, non-interest income, and bank profitability: Evidence from Indian banks. *Econ. Model.* **2017**, *63*, 1–14. [[CrossRef](#)]
34. Lozano-Vivas, A.; Pasiouras, F. The impact of non-traditional activities on the estimation of bank efficiency: International evidence. *J. Bank. Financ.* **2010**, *34*, 1436–1449. [[CrossRef](#)]
35. Vickers, J.S. *Independent Commission on Banking Final Report: Recommendations*; The Stationery Office: London, UK, 2011.
36. Yip, A.W.H.; Bocken, N.M.P. Sustainable business model archetypes for the banking industry. *J. Clean. Prod.* **2018**, *174*, 150–169. [[CrossRef](#)]
37. Karkowska, R. Diversification of Banking Activity and Its Importance in Building Financial Stability. In *Global Versus Local Perspectives on Finance and Accounting: 19th Annual Conference on Finance and Accounting (ACFA 2018)*; Procházka, D., Ed.; Springer: Cham, Switzerland, 2018; pp. 79–88. [[CrossRef](#)]



© 2019 by the author. Licensee MDPI, Basel, Switzerland. This article is an open access article distributed under the terms and conditions of the Creative Commons Attribution (CC BY) license (<http://creativecommons.org/licenses/by/4.0/>).



Article

# Testing the Smooth Driving of a Train Using a Neural Network

Emilia Koper \* and Andrzej Kochan \*

Faculty of Transport, Warsaw University of Technology, 00662 Warsaw, Poland

\* Correspondence: emilia.koper@pw.edu.pl (E.K.); andrzej.kochan@pw.edu.pl (A.K.)

Received: 29 January 2020; Accepted: 1 June 2020; Published: 5 June 2020

**Abstract:** This article deals with the extraction of a new original parameter to characterize a railway traffic driving smoothness indicator, and its investigation is based on data obtained from a neural train emulator. This indicator of driving smoothness is an example of the sustainable value of control command and signaling technology. The pro-social and pro-environmental aspects of smooth driving are indicated and the article proposes the introduction of a new indicator for assessing the quality of rail traffic, taking into account traffic on a micro scale—the driving smoothness of a single train (also called driving flow), derived from a parameter identified in the literature—and traffic smoothness (also called traffic flow), describing traffic quality on a macro scale. At the same time, the concept of a neural train emulator is presented, providing input data to determine the value of the proposed indicator for different train models and track systems in order to test the indicator's properties. The concept proposes the structure of an artificial neural network, the technique of obtaining test data sets and the conditions of training the network as well. An emulator based on the neural network enables the simulation of train driving, taking into account its nonlinearity and data acquisition for indicator research.

**Keywords:** driving smoothness; train neural emulator; neural networks

---

## 1. Introduction

Rail traffic is routed traffic, directed on the basis of a previously prepared plan in the form of a timetable and a traffic diagram. The proper functioning of railway traffic, due to its nature, depends on many technical, economic and operational factors.

The need to improve the quality of transport services, resulting from the growing needs of passengers, who are increasingly interested in rail transport services and increasing passenger comfort, is also important. In addition, increasing importance is now being attached to ensuring so-called sustainability. A document encouraging such an approach is, for example, the Public Transport Act [1].

The sustainable development of public transport describes a process of transport evolution that takes into account the social expectations of ensuring the universal availability of public transport services, aimed at promoting different, more environmentally friendly means of transport equipped with modern technical solutions.

Rail traffic should also be operated with the degree of safety required by the users of the rail transport system and should be adapted to social and economic needs. To this end, modern command control and signaling systems are being set up with new expectations, also taking into account the so-called sustainable value. Some examples include the use of ecological solutions, materials, modern vehicles and infrastructure elements, increasing passenger comfort, improving the overall quality of provided services and not interfering with the environment (or interfering to a minimal extent). In turn, sustainable value combines the economic, environmental and social dimensions of sustainable development. Sustainable value integrates the environmental and social dimension into financial

analysis and investment decisions. Sustainable value combines scientific research and applications in the real world [2].

This is also connected with the trend in the development of systems that perform Automatic Train Operation (ATO), which, according to [3], is part of the Automatic Train Control (ATC) system. A key function of the ATO system is to control the train speed in such a way that it minimizes energy consumption and ensures passenger comfort [4].

The analyses conducted so far have focused on the study of the impact of traffic parameters such as line capacity, sequence time, blocking time, capacity use rate, or traffic smoothness in a given area.

The authors of the article propose to introduce a new parameter describing traffic quality—driving smoothness—considering that the quality is treated as a collective property, no-unit value, which is difficult to measure, but quantifiable as the resultant intensity of the most important factors influencing it. The parameter proposed by the authors is the driving smoothness of a rail vehicle, which fits into the idea of a sustainable value. This parameter can be used to analyze the above mentioned energy efficiency and ATO function, but these are not the subject of this article.

The testing of the driving smoothness indicator will be carried out with the use of data sets obtained during train driving simulation, realized under different conditions. Data recording requires, to a great extent, the use of train running simulators, due to the need to record data for very different running scenarios. For the reliability of the tests carried out, it is important to accurately reflect the real dynamic character of the object, which is a train. For this reason, a neural train emulator is used in the tests. The emulator reflects the dynamic and non-linear properties of a real train using an artificial neural network (ann).

Artificial neural networks (ann) are mathematical structures with an established position in the field of artificial intelligence techniques. They can solve different tasks. Depending on the type of task, to solve a problem, a properly structured network and way of learning is selected [5,6]. A train behavior representation task belongs to a class of tasks consisting of the prediction of successive values in a sequence determined by points in time. Such tasks are solved by recursive networks. An interesting proposition are recurrent long short-term memory (LSTM) networks. This type of network or, more precisely, its implementation in a MATLAB environment will be used in the described research.

## **2. State of the Art**

### *2.1. Traffic Smoothness and Driving Smoothness*

The term traffic smoothness, from which the concept of the smoothness of driving originates, is used in railway, road transport [7] and air transport [8,9]. Examples of publications dealing with the issue of railway traffic flow can be found in [10–12].

In [10], the authors state that “a good traffic is a smooth traffic”. “Smooth traffic is the organisation of train movement on a railway line or station in such a way as to mitigate primary and secondary disturbances resulting from the deviation of train driving time from the planned values caused by unforeseen operational events or traffic situations” [10].

The measure of traffic smoothness is the probability that train paths do not need to be adjusted as a result of primary disruption. Smooth traffic is traffic without disturbances, i.e., without a loss of time, resulting from the mutual interaction of individual traffic units. The concept of disturbance is understood as a deviation in the traffic execution from the timetable. Traffic regulation means the removal of traffic collisions or the time losses of a unit caused by the removal of collisions.

Traffic smoothness is not a direct measure of the perception of traffic conditions from the passengers’ point of view (e.g., travel comfort, punctuality, etc.). Nevertheless, secondary disturbances arising in real traffic, such as delays and their consequences, experienced by passengers and resulting from insufficient traffic smoothness affect the perception of rail transport and shape the transport preferences of residents [13]. In this context, the concept of traffic smoothness is of a pro-social nature and influences the positive feelings of rail transport participants.

The concept of traffic smoothness refers to the simultaneous driving of multiple vehicles and is indicated in the article to introduce the concept of driving smoothness. As proposed by the authors, the concept of smooth driving refers to the driving of a single vehicle.

In the analyzed bibliographical sources, the existence of the concept of driving smoothness in relation to rail transport has not been identified. The proposal presented in this article aims to complement the existing parameters with an indicator describing the quality of rail vehicle driving.

Table 1 presents the essential features of transport services, both qualitative and quantitative. The characteristics are classified according to the following criteria: distance-related, time-related, object-related. It is worth noting that, among these characteristics, there are those related to the idea of sustainable value. These include, first of all, passenger comfort—understood as minimizing unnecessary acceleration and braking (strongly related to smoothness of driving)—in a prosocial sense and, at the same time, due to the reduction in the energy consumption in a pro-environmental sense, and pro-environmental aspects such as the minimization of vibrations related to the passage of rolling stock (in a prosocial sense) or noise reduction. It should be kept in mind that, today, the factors influencing passenger satisfaction in public transport are becoming increasingly complex [4].

**Table 1.** Essential features of transport services (own elaboration based on: [13,14]).

Related to Spatial Distance	Related to Time	Related to the Object of Transport
- accessibility to the transport network	- duration of the journey	- mass capacity
- directness	- availability in time	- safety: frequency of accidents
- distance and possible extension of the distance	- reliability	- passenger comfort (comfort): including smooth driving, minimizing vibrations and reducing noise
- capacity	- frequency	- confidence
	- rhythmicity	- service complexity
	- regularity	
	- punctuality	

Table 2 presents a ranking of measures of transport service quality, which translate into passenger satisfaction. Driving smoothness is related to the following quality features: punctuality, comfort, speed and travel time. Moreover, the driving smoothness is also related to such features as capacity and reliability. Furthermore, comfort, speed and travel time are linked to social and environmental policies.

**Table 2.** Importance (ranking) of quality measures (own elaboration based on: [13]).

No.	Feature	Ranking of Quality Measures (%)
1	punctuality	19.37
2	directness	14.37
3	frequency	14.03
4	rhythmicity	13.95
5	low cost	11.82
6	comfort	6.98
7	travel safety	6.81
8	speed and travel time	6.39

Ensuring passenger comfort is directly linked to the quality of service in transport. As indicated in railway standards (e.g., [15]), the comfort of train passengers is influenced by, among other factors, vibrations and vehicle movement style, taking into account, among other factors, the average change in acceleration and deceleration, which can be used to assess the comfort of driving during the train's operation. The above features are in line with the concept of sustainable value.

In modern systems, often emphasizing optimization and pro-environmental aspects, the driving profile is determined and implemented automatically [16–21]. It is worth noting that there are many

studies on the subject of energy consumption optimization, in which it is possible to use the driving smoothness indicator. Examples of publications on this subject include [21,22].

According to [23], “the efficiency of vehicle movement is related to the capacity of the railway line that allows trains to run smoothly, i.e., without unplanned stops or speed restrictions”. The abovementioned aspects (energy consumption optimization, ATO) are reflected in the modeling of smooth driving, but they are not the subject of this article; therefore, in subsequent sections, the authors will not refer to them.

## 2.2. Train Driving Model

Passenger comfort during the journey and thus issues of traffic smoothness are highlighted when speed changes occur. One of the basic operational scenarios implemented by passenger trains is driving between two stopping points, e.g., stations [24]. The algorithm of such a scenario consists of the following steps:

- obtaining a movement authority (setting a route, sending a movement authority);
- starting the run (starting, accelerating);
- monitoring the run (driving at an authorised speed);
- coasting;
- controlling braking conditions (speed reduction and implementation of braking as required);
- end-of-travel stop (targeted braking and precise stop).

Practical examples of driving according to the above algorithm are those specific to suburban and metro traffic, where the distance between stops is small (1–2 km). The model of train movement for a similar scenario has been analyzed in [24–26].

Moving the vehicle between stops according to a fixed timetable (basic ATO functions) is best carried out by the following traffic model, with a steady speed phase. The driving style in this phase is most consistent with the idea of maximizing the value of the driving smoothness indicator. This model shows the optimal train speed profile from an indicator point of view. Its individual stages are well characterized by the traction force ( $\mu_f$ ) and braking force ( $\mu_b$ ) [26]. The stages to be distinguished are:

- start-up–full power (FP), where  $\mu_f = 1$ ,  $\mu_b = 0$ , solid line;
- constant speed–partial power (PP), where  $\mu_f \in [0-1]$ , dotted line;
- coasting (C),  $\mu_f = 0$ ,  $\mu_b = 0$ , dot dashed line;
- full braking (FB),  $\mu_f = 0$ ,  $\mu_b = 1$ , dashed line.

Figure 1 presents the optimal vehicle speed profile.

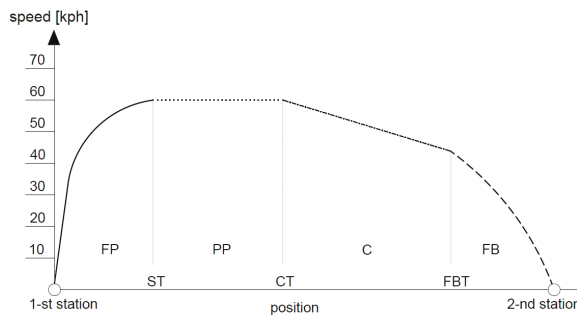

Figure 1. Optimal vehicle speed profile (source: [26]).

Based on the optimal speed profile, the transition points between the individual stages were determined, i.e., Speed Threshold (ST), Cruising Threshold (CT) and Full Brake Threshold (FBT) and we developed an algorithm for these driving stages.

The authors of [24] present on the common graph of speed as a function of distance, curves (driving profile) showing train driving parameters depending on strategy and goals to be achieved, i.e., the minimization of driving time, maximizing passenger comfort, and balanced driving, allowing for the simultaneous minimization of driving time and maximizing passenger comfort. The last of the objectives presented is, of course, a compromise, leading to the minimisation of the two criteria to a sufficiently limited extent. The last approach is in line with the criterion discussed in this article, namely the smooth driving of an individual train and, indirectly, the smooth traffic of trains.

The movement model consists of two or more phases. The occurrence of individual phases is influenced by the length of the section between the stations and the time of travel, which is set in the timetable. There are three possible driving variants (Figure 2):

- start-up–coasting to stop (green);
- start-up–coasting–braking (blue);
- start-up–braking (red).

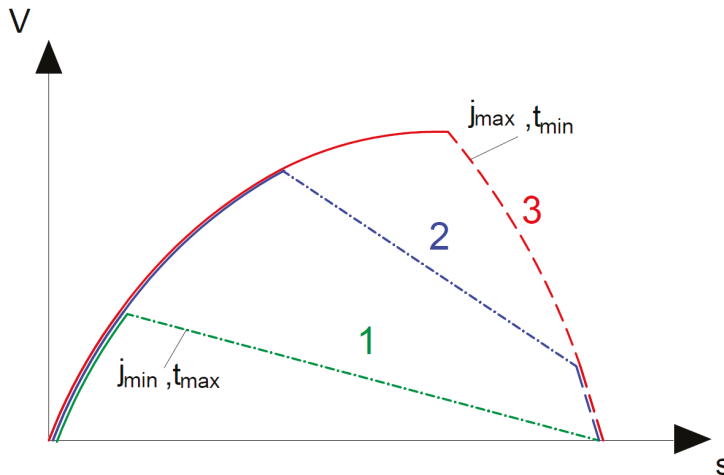

**Figure 2.** Train speed ( $V$ ) as a function of the distance ( $s$ ) for suburban traffic/metro. Stages: 1—start-up–coasting to stop, 2—start-up–coasting–braking, 3—start-up–braking (source: [24]).

In the case of a run consisting of two phases: starting (continuous line) and driving at momentum to stop (dotted line), the energy consumption will be minimal ( $j_{\min}$ ), while passenger comfort will be the highest, but the run time will be the longest ( $t_{\max}$ ). In the case of a forced drive, i.e., driving with a direct transition from start to stop (dashed line), the travel time will be the shortest ( $t_{\min}$ ), but the energy consumption will be maximal ( $j_{\max}$ ), and the passenger comfort will be the lowest. The criterion of smooth driving requires the minimization of significant speed changes.

It shall be possible to simulate the presented train driving strategies in order to test the smooth driving characteristics. Such simulations will be possible by using the train emulator proposed later in the study.

### 2.3. Neural Train Emulator

The testing of the indicator requires data sets describing the dynamic profile of train driving under different conditions, as shaped by [27–29]:

- ATO driving strategy;
- traction characteristics of the locomotive;
- the train's braking performance;
- track infrastructure parameters.

The assessment of the indicator for the different profiles described above will require the actual mapping of the train's behavior over a specific section of the rail network for different driving techniques. In other words, to carry out the tests, it is necessary to acquire the actual driving speed profiles obtained using the train modeling simulator, the value of which are train speed (V), a parameter input value of the traction (drive) adjuster and brake adjuster, and track infrastructure parameters.

In the literature, there are examples of issues that require the accurate mapping of train behavior, where it is considered in a non-linear model [30,31] This is also the assumption made in the work on driving smoothness indicators. A non-linear train model realized as an ann was successfully used by the authors of [31–33]. Based on these examples, the authors of this article propose to simulate train movements using a non-linear predictive control model. Such a network will be referred to as a neural controller.

The use of ann in automation is attractive due to the following features:

- the possibility to approximate any non-linear mapping;
- parallel and distributed processing;
- adaptation;
- learning;
- processing signals from multiple inputs and generating multiple outputs.

Their use in the issues of modeling and the identification of objects (e.g., a train) results primarily from the possibility of approximating any non-linearities [32] and tuning the model on the basis of experimental data or other learning images.

The proposed approach to building a neural emulator is the use of long short-term memory (LSTM) networks. LSTMs are a type of recursive networks, which are suitable for solving sequence to consequence problems, to which the task of the neural emulator belongs. This task is to process the sequence of movement and setpoint values for a train into movement values at successive moments in time. The LSTM-type network was first described by Hochreiter and Schmidhuber [34] in 1997.

This concept, with various modifications, has been used in many successful commercial solutions. For example, in recent years, LSTM has been used as a basic component in new products by the largest technology companies, including Google, Apple and Microsoft [35].

LSTM networks have been made available in various computing environments. One such example is MATLAB. MATLAB software provides a tool called "Deep Learning Toolbox", where one can find many modules to support the creation of ann, which can be used to determine the value of the sequence for series moments in time. Work on such a network can start with a LSTM architecture configured for regression, consisting of four layers:

- input;
- LSTM;
- fully connected;
- regression.

Assuming the available default parameter values, the minimum set of parameters that need to be specified comes down to:

- the number of input parameters ann;
- the number of output parameters ann;
- the number of hidden units in the LSTM layer.

The first two parameters are fully application dependent. For the number of hidden units in the LSTM layer, the value depends on the nature of the value set. Figure 3 shows the structure of the LSTM layer, where  $x_t$  means the input sequence,  $c_t$  the cell state and  $h_t$  the hidden state. The parameters  $c_t$  and  $h_t$  describe the output.

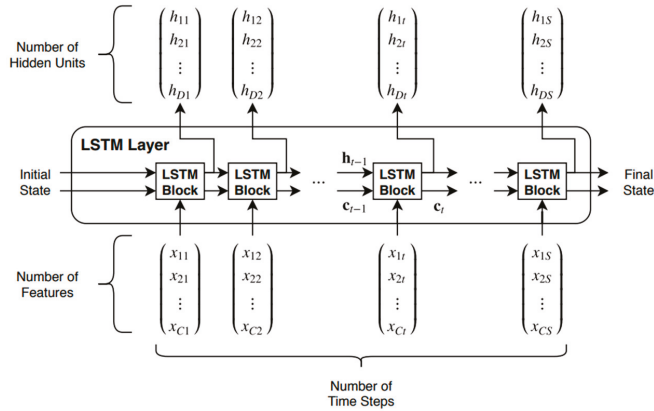

Figure 3. Long short-term memory (LSTM) layer structure of an ANN architecture in MATLAB environment (source: [36]).

The LSTM layer is made up of LSTM blocks, the structure of which is shown in Figure 4, where  $r$  is the reset gate,  $g$  is the gate that adds information to the cell's state, and  $i$  is the gate that controls the updating of the cell's state and  $o$  is the gate that controls the state added to the hidden state.

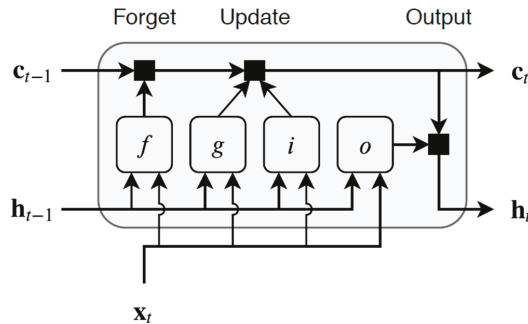

Figure 4. LSTM block structure (source: [36]).

On the configured LSTM architecture, learning is carried out using a series of parameter values, which are the extortion and the desired network responses for particular moments in time. For the described network, the appropriate optimization algorithm is ADAM [37]. The learning algorithm can be configured using parameters such as mini-batch options, validation options, optimization options, sequence options. Learning is performed with a built-in function with the following parameters: sequences, an object representing the configured network and learning parameters. During the learning process, it is possible to follow the progress by observing the graph of the average square error for the network being trained.

Considering that using an LSTM-type network can achieve good results in modeling the dynamic properties of non-linear objects, such a network architecture has been adopted in this study. This network will be referred to as the neural train emulator.

### 3. Research

#### 3.1. Smooth Driving

So far, studies (referred to in Section 3.1) have considered the simultaneous movement of many trains in the area, with movement considered on a macro scale. When using such an approach, traffic smoothness reflecting traffic phenomena on a macro scale is a balanced value. The parameter ignored so far is the “driving smoothness” of a vehicle, relating to the movement (driving) of a single vehicle in an area—on a micro scale.

For the purposes of this article, it is proposed to adopt the following proprietary definition of driving smoothness. Driving smoothness is a measure characterizing the quality of driving of a railway vehicle in a way that eliminates disturbances. Disturbances are understood as the unnecessary braking (energy loss) of a train and the unnecessary acceleration (energy loss) of a train.

By analyzing the definition, it can be seen that the aim of ensuring smooth driving is also to provide energy efficiency, associated with a reduction in unnecessary acceleration and braking, resulting in minimizing the energy consumption and, consequently, reducing the costs resulting from the energy consumption of rail vehicles.

For the purpose of the research on driving smoothness, a driving smoothness indicator has been developed, which is a no-unit value measure of driving quality, describing the variability of the acceleration/deceleration value over a specific distance of road. The mathematical notation corresponds to the measure of the data set diversity used in the statistics. However, the very concept and application of this correlation to determine the smoothness of driving is innovative.

$$k = \frac{\sigma}{|\mu|} \quad (1)$$

where  $k$ —driving smoothness indicator,  $\sigma$ —standard deviation of acceleration,  $\mu$ —average acceleration/deceleration.

$$\sigma = \sqrt{\frac{\sum_{i=1}^n (X_i - \mu)^2}{N}} \quad (2)$$

where  $\sigma$ —standard deviation,  $X_i$ —the value of a random variable in the population,  $\mu$ —arithmetic mean of the population,  $N$ —number of elements in the population.

An ideally smooth driving experience is achieved when the vehicle is in straight-line uniform motion (the acceleration (or deceleration) is zero and change in acceleration (or deceleration) is zero), corresponding to the second phase of driving (described in Section 2.2 of this article), and this case is excluded from consideration. Moreover, at the current stage of the indicator formulation, the authors do not deal with other cases where the average acceleration/deceleration value is zero. The greater the variation in acceleration, the less smooth the driving is (and the lower the value of indicator  $k$ ).

In addition, a higher value of the smooth driving indicator means greater economic and environmental benefits (lower energy consumption, reduced noise emissions, reduced vibrations) and social benefits resulting from increased passenger comfort (less vibro-acoustic impact, better perception of rail transport).

#### 3.2. Model of the Train

The preparation of the neural network structure requires an analysis of the simulation conditions and the preparation of an appropriate train model and its environment. At this stage, the results of the authors’ research dedicated to the analysis of the movement authority model [27] and simulation of braking curves in the ERTMS/ETCS system [28] will be used. In this approach, the train is described by static and dynamic parameters. The static parameters include:



- length;
- mass;
- braking mass;
- traction characteristics;
- braking characteristics;
- maximum design speed of the train;
- delay in service braking;
- emergency braking delay;
- maximum braking distance.

Among the dynamic parameters of the train, the following are distinguished:

- current speed;
- acceleration;
- movement authority;
- dynamic speed profile;
- train driving strategy;
- dynamic driving profile;
- location on the track;
- traction adjuster position;
- brake adjuster position.

### 3.3. Infrastructure Model

The model of the trackside infrastructure on which the train runs well reflects the detailed model of the authorisation to run, as detailed in [27]. Movement authority  $z_j$  is called tuple:

$$z_j = (O, ok, pk, do, pn) \quad (3)$$

where  $z_j$ —movement authority,  $O$ —set of sections of a movement authority without the end section,  $ok$ —end section of movement authority,  $pk$ —end of movement authority,  $do$ —overlap of movement authority,  $pn$ —danger point.

The driving path for a driving permit in the form of a set of sections is described as follows:

$$O = \{o_1, \dots, o_n\} \quad (4)$$

where  $O$ —set of road sections  $z_j$  with exclusion of the end section,  $n$ —number of sections other than the end section,  $n$ —an integer greater than or equal to zero.

The section  $o_i$  is described by the following tuple:

$$o_i = (d, l, v_{max}, tw) \quad (5)$$

where  $o_i$ — $i$ -th section  $z_j$ ,  $d$ —mileage of the beginning of  $o_i$ ,  $l$ —length of  $o_i$ ,  $v_{max}$ —maximum speed on  $o_i$ ,  $tw$ —time-out for  $o_i$ .

### 3.4. Artificial Neural Network of Train Emulator

The dynamics of the train driving process shall be seen as changes in train speed due to changes in the position of the traction and braking adjuster and other factors in the process environment. This relationship is not linear because the speed does not change proportionally with the position of the adjuster. This relationship is influenced by different resistance forces acting on the train and counteracting forces of the traction unit [38]. This phenomenon (the presence of non-linearity) indicates

neural networks as a suitable method for obtaining an accurate representation of the dynamic properties of a train.

Additionally, taking into account the purpose of using the emulator, it was reasonable to choose LSTM architecture as a base for its implementation. The computing environment is that of MATLAB. By using it, the architecture parameterization and learning process of the emulator was carried out. Simulations were also carried out in this environment, as a result of which data were obtained for the purpose of testing the indicator.

The design of the emulator required the following parameters:

- the number of input sequences;
- number of hidden states of the LSTM layer;
- the number of output sequences;
- the time step, which defines the discrete data of ann.

The input parameters of the created network will consist of quantities describing the process state. In a natural way, train driving will be described mainly by speed-related values. On the basis of the previously described models, the minimum set of such values is formed by the following parameters:

- the current actual speed;
- the current permitted speed;
- the current acceleration;
- the position of the traction/braking control;
- the distance of the train to the end of the movement authority.

The above list may be extended with parameters that may affect the acceleration and braking performance. A parameter which varies during driving is the gradient of the track. The values of this parameter are related to specific locations on the track system. In the dynamic model of train driving, they will depend on the current position of the train.

During the learning process, the input parameters will be given for the subsequent  $t_i$  moments. The train's neural emulator, as an output value, will return the train speed value for a given moment  $t_{i+1}$ . On the basis of a trend analysis of the individual parameters, it was assumed that data sequences would consist of samples for moments in time distant from each other by  $\Delta t = 1$  s. As a result of the above considerations, the following parameters were adopted for the emulator:

- number of input sequences—6;
- number of output sequences—1;
- number of hidden states—400.

### 3.5. Learning Process

As mentioned earlier, the learning of the neural emulator was realized in the MATLAB environment. The learning process will take place under supervision (with a teacher). The learning data was derived from ERSA's Traffic Simulator tool. For each version of the emulator, the data was taken from a single train run—from start to stop. For the learning process, rides were duplicated three times by sequential pasting. The resulting set was divided into two parts. The first one constituted 95% of the data and contained the data presented at the input of the network during learning.

The rest of the data (5%) were used as test data and were used to verify the quality of the emulator response. The data from the first part were used to prepare input sequences and response sequences. Input sequences contained samples from 1 to N-1 and sample hint sequences from 2 to N, where N is the sample count in the first part of the data. All sequences were normalized before teaching. The learning time was less than 1 min. After the end of the learning process, the verification was carried out, which was successful.

## 4. Test Results

### 4.1. Simulation of Train Driving Using a Neural Emulator

The simulation of an individual ride was carried out according to the scenario presented in Section 2.2. The train was driving between two stable points, taking into account the actual track system parameters.

The testing of the smoothness driving indicator requires data sets for train driving according to a planned strategy. Therefore, for the purpose of testing, the following strategies were planned:

- make the ride quickly as possible;
- make the ride as economical as possible;
- follow the scheduled sustainable driving time.

In addition, runs were carried out on different track systems, where their diversity was defined by different gradients:

- the profile of descending track;
- the profile of the ascending track;
- a track profile with many hills and descents;
- a horizontal driving profile.

Another factor taken into account was the static speed profile, defining the infrastructure constraints:

- a static profile with one speed limit—maximum line speed;
- a static profile with restrictions on the station areas at the beginning and end of the drive;
- a static profile with restrictions on the route due to infrastructure malfunctions.

Another issue that influenced the number of simulations and the scope of the research was the modeling of different trains. Their diversity was due to the different rolling stock forming the trainsets. A separate version of the emulator was prepared for each infrastructure configuration and train composition.

### 4.2. Driving Smoothness Indicator

Figure 5 shows an example of a train movement diagram illustrating acceleration as a function of the distance, based on simulated data, described in Section 4.1. This data allows for the study of the smooth driving indicator for different driving variants.

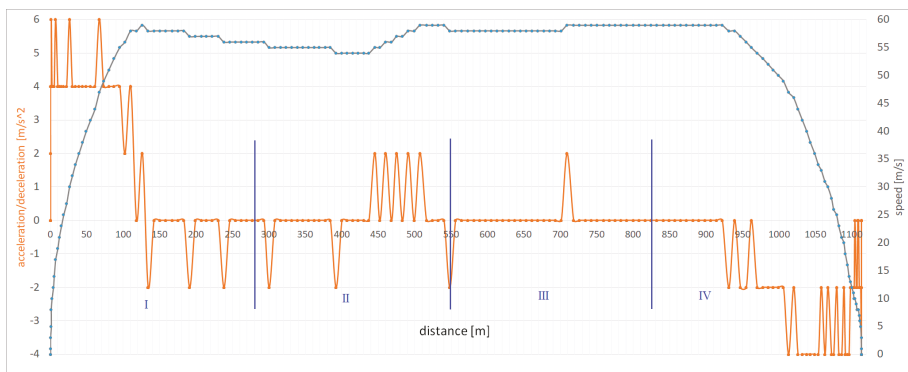

Figure 5. Train movement diagram (source: own elaboration).

For the ride in question, the indicator of driving smoothness was determined for the individual driving stages. For this purpose, the route was divided into four parts (I–IV) and, for each of them, the value of the k indicator was determined.

Table 3 presents the data necessary to determine the driving smoothness indicator for the ride in question—obtained as a result of a simulation with the use of the neural train emulator—the values of the k indicator for individual sections, and the ranking of solutions.

**Table 3.** Driving smoothness indicator k for sections I–IV (source: own elaboration).

Section	I	II	III	IV
standard deviation	2.05	0.79	0.56	1.42
average	2.65	0.39	0.17	2.39
k	0.77	2.03	3.24	0.59
ranking	III	II	I	IV

The highest value for the indicator, determined in accordance with the relation described in Section 3.1, was achieved for part III—corresponding to the uniform ride described in Section 3.2 of the article—and for part II, corresponding to the uniform drive with disturbances. The worst (lowest) ratio values were obtained for parts I and IV, which correspond to starting and braking. The obtained results (trend) are in line with our prediction.

## 5. Conclusions

The article describes a new, original indicator for the assessment of the quality of rail traffic driving smoothness and emphasizes the pro-environmental and pro-social characteristics of rail transport. The parameter discussed in the article is a sustainable value.

An important element of the study of driving smoothness is the preparation of data sets by simulating train driving. The article indicates the possibility of using artificial neural networks to model the non-linear nature of a train. The structure of the neural network in this study, allowing us to model the dynamic properties of a moving train, is presented. For the simulation process, a basic test scenario and different train environment conditions allowed us to prepare the different data sets necessary for a multi-aspect analysis of the studied indicator.

As a result of the simulation, we obtained charts and data illustrating the train's passage. These data, relevant from the point of view of the subject matter of the article, concern speed/acceleration as a function of time or distance, and are the input data for determining the driving smoothness indicator. The article presents, as an example, the way in which the indicator is determined and the obtained values of data from the train's neural emulator.

**Author Contributions:** Writing—original draft E.K., A.K. All authors have read and agreed to the published version of the manuscript.

**Funding:** This research received no external funding.

**Conflicts of Interest:** The authors declare no conflict of interest.

## References

1. *Ustawa z Dnia 16 Grudnia 2010 r. o Publicznym Transporcie Zbiorowym.* (Dz.U 2017 poz. 2136 z Późń. Zmianami); Kancelaria Sejmu: Warsaw, Poland, 2017.
2. Rashid, K.; Safdarnejad, S.; Ellingwood, K.; Powell, K. Techno-economic evaluation of different hybridization schemes for a solar thermal/gas power plant. *Energy* **2019**, *181*, 91–106. [[CrossRef](#)]
3. Imran, T.; Munawir, T.; Abqari, A.; Samah, A. A comparison study on the assessment of ride comfort for LRT passengers. *Mater. Sci. Eng.* **2017**, *226*, 012039.
4. *EN 62290-1:2014 Railway Applications. Urban Guided Transport Management and Command/Control Systems. System Principles and Fundamental Concepts*; BSI: London, UK, 2014.

5. Haykin, S. *Neural Networks a Comprehensive Foundation*; Prentice Hall PTR: Upper Saddle River, NJ, USA, 1999.
6. Korbicz, J.; Obuchowicz, A.; Uciński, D. *Sztuczne Sieci Neuronowe. Podstawy i Zastosowania*; Akademicka Oficyna Wydawnicza PLJ: Warszawa, Poland, 1994.
7. Sobota, A.; Karoń, G. Próba zdefiniowania pojazdu zakłóconego na wybranych odcinkach dróg wielopasowych w aspekcie płynności ruchu. *Zesz. Nauk. Politech. Śląskiej Transp.* **2010**, *66*, 98–106.
8. Dmochowski, P.A.; Mycka, M.; Skorupski, J. Analiza zależności między wielkością a płynnością ruchu w kontekście zarządzania przepływem strumieni ruchu lotniczego. In *Współczesne Problemy Inżynierii Ruchu Lotniczego—Modele*; Jacek, S., Ed.; Oficyna Wydawnicza Politechniki Warszawskiej: Warsaw, Poland, 2014.
9. Dmochowski, P.A.; Mycka, M.; Skorupski, J. Możliwość Implementacji Metody Szacowania Płynności do Operacyjnego Zarządzania Przepływem Ruchu Lotniczego. *Pr. Nauk. Politech. Warsz. Transp.* **2016**, 109–120.
10. Woch, J. *Podstawy Inżynierii Ruchu Kolejowego*; Wydawnictwo Komunikacji i Łączności: Warsaw, Poland, 1983.
11. Andersson, E.V.; Peterson, A.; Krasemann, J.T. Quantifying railway timetable robustness in critical points. *J. Rail Transp. Plan. Manag.* **2013**, *3*, 95–110. [[CrossRef](#)]
12. Cavone, G.; Dotoli, M.; Epicoco, N.; Seatzu, C. A decision making procedure for robust train rescheduling based on mixed integer linear programming and data envelopment analysis. *Appl. Math. Model.* **2017**, *52*, 255–273. [[CrossRef](#)]
13. Kwaśnikowski, J.; Gramza, G. Analiza wybranych zakłóceń w ruchu kolejowym. *Probl. Eksploat.* **2007**, 89–96.
14. Twaróg, J. *Mierniki i Wskaźniki Logistyczne*; Biblioteka Logistyka: Poznań, Poland, 2004.
15. *BS EN 12299:2009 Railway Applications. Ride Comfort for Passengers. Measurement and Evaluation*; BSI: London, UK, 2009.
16. Xu, X.; Yang, L.; Gao, Z.; Long, J. Simulations for train traffic flow on single-track railways with speed limits and slopes. *J. Simul.* **2017**, *11*, 346–356. [[CrossRef](#)]
17. Amrani, A.; Hamida, A.; Liu, T.; Langlois, O. Train speed profiles optimization using a genetic algorithm based on a random-forest model to estimate energy consumption. In Proceedings of the Transport Research Arena (TRA), Vienne, Austria, 16–19 April 2018.
18. Huang, K.; Wu, J.; Yang, X.; Gao, Z.; Liu, F.; Zhu, Y. Discrete train speed profile optimization for urban rail transit: A data-driven model and integrated algorithms based on machine learning. *J. Adv. Transp.* **2019**, *2019*, 7258986. [[CrossRef](#)]
19. De Martinis, V.; Gallo, M. Models and methods to optimise train speed profiles with and without energy recovery systems: A suburban test case. *Procedia-Soc. Behav. Sci.* **2013**, *87*, 222–233. [[CrossRef](#)]
20. Zhao, N.; Roberts, C.; Hillmansen, S.; Western, P.; Chen, L.; Tian, Z.; Xin, T.; Su, S. Train trajectory optimisation of ATO systems for metro lines. In Proceedings of the 17th International IEEE Conference on Intelligent Transportation Systems (ITSC), Qingdao, China, 8–11 October 2014; pp. 1796–1801. [[CrossRef](#)]
21. Jong, J.C.; Chang, S. Algorithms for generating train speed profiles. *J. East. Asia Soc. Transp. Stud.* **2005**, *6*, 356–371.
22. Domínguez, M.; Fernández, A.; Cucala, A.; Blanquer, J. Efficient design of automatic train operation speed profiles with on board energy storage devices. *Wit Trans. Built Environ.* **2010**, *114*, 509–520.
23. Woch, J. *Kształtowanie Płynności Ruchu w Gęstych Sieciach Transportowych*; PAN: Kielce, Poland, 1998.
24. Bergiel, K.; Karbowski, H. *Automatyzacja Prowadzenia Pociągu*; EMI-PRESS: Łódź, Poland, 2005.
25. Tang, H.; Dick, C.; Feng, X. Optimization of train speed profiles for a metro transit system by genetic algorithms. In Proceedings of the 6th International Conference on Railway Operations Modelling and Analysis Planning, Simulation and Optimisation Approaches, Tokyo, Japan, 23–26 March 2015.
26. Morais, V.A.; Rocha, A.A.; Afonso, J.L.; Martins, A.P. Heuristic-based Speed Profile Generation for Multi-Train Simulator. In Proceedings of the International Conference on Intelligent Systems, Funchal-Madeira, Portugal, 25–27 September 2018.
27. Kochan, A.; Koper, E. Mathematical model of the movement authority in the ERTMS/ETCS system. In *ISCT21 2019: Research Methods and Solutions to Current Transport Problems*; Siergiejczyk, M., Krzykowska, K., Eds.; Advances in Intelligent Systems and Computing; Springer: Cham, Switzerland, 2020; Volume 1032.
28. Koper, E.; Kochan, A.; Gruba, Ł. Simulation of the Effect of Selected National Values on the Braking Curves of an ETCS Vehicle. In *Development of Transport by Telematics*; Mikulski, W.J., Mikulski, J., Eds.; Springer: Cham, Switzerland, 2019; pp. 17–31. [[CrossRef](#)]
29. Jia, C.; Xu, H.; Wang, L. Nonlinear hybrid multipoint model of high-speed train with traction/braking dynamic and speed estimation law. *Math. Probl. Eng.* **2019**, *2019*, 1364657. [[CrossRef](#)]

30. Farooqia, H.; Incremona, G.P.; Colaneri, P. Railway collaborative ecodrive via dissension based switching nonlinear model predictive control. *Eur. J. Control* **2019**, *50*, 153–160. [[CrossRef](#)]
31. Shinde, P.; Yadav, S.; Rudrake, S.; Kumbhar, P. Smart Traffic Control System using YOLO. *Int. Res. J. Eng. Technol.* **2019**, *6*.
32. Hagan, M.T.; Demuth, H.B.; Jesús, O.D. An introduction to the use of neural networks in control systems. *Int. J. Robust Nonlinear Control* **2002**, *12*, 959–985. [[CrossRef](#)]
33. Ke, Q.; Zhang, Y. Research on automatic operation control algorithm of high speed train based on artificial neural network. *IOP Conf. Ser. Mater. Sci. Eng.* **2019**, *677*, 042046. [[CrossRef](#)]
34. Hochreiter, S.; Schmidhuber, J. Long short-term memory. *Neural Comput.* **1997**, *9*, 1735–1780. [[CrossRef](#)] [[PubMed](#)]
35. Available online: [https://en.wikipedia.org/wiki/Long\\_short-term\\_memory#History](https://en.wikipedia.org/wiki/Long_short-term_memory#History) (accessed on 15 April 2020).
36. MathWorks, M. *Deep Learning Toolbox*; Technical Documentation. 2019. Available online: <https://www.mathworks.com/help/deeplearning/> (accessed on 1 June 2020).
37. Kingma, D.P.; Ba, J. Adam: A method for stochastic optimization. *arXiv* **2014**, arXiv:1412.6980.
38. Madej, J. *Teoria Ruchu Pojazdów Szynowych*; Oficyna wydawnicza Politechniki Warszawskiej Warszawa: Warsaw, Poland, 2012.



© 2020 by the authors. Licensee MDPI, Basel, Switzerland. This article is an open access article distributed under the terms and conditions of the Creative Commons Attribution (CC BY) license (<http://creativecommons.org/licenses/by/4.0/>).



Article

# Public Policy Timing in a Sustainable Approach to Shaping Public Policy

Dorota Korenik \* and Maria Węgrzyn

Department of Finance, Wrocław University of Economics and Business, Wrocław 53-345, Poland; maria.wegrzyn@ue.wroc.pl

\* Correspondence: dorota.korenik@ue.wroc.pl

Received: 27 January 2020; Accepted: 26 March 2020; Published: 29 March 2020

**Abstract:** This study addresses the problem of optimal public policy timing and the relation to public health policy. Ways of recognizing this problem are presented, as well as the role of public policy timing, which is perceived or can be performed from various economic theories and concepts, mainly: regulation theory; the concept of adaptive public policy; and the theory of policy timing based on the concepts of option value and the transaction costs of the political process. The approach of methodological pluralism adopted by the authors made it possible to reach for various cognitive inspirations borrowed from numerous theoretical approaches, in order to create a comprehensive and coherent theoretical foundation for the purposes of analyzing the role of timing in applied public policies. Next, an attempt was made to define the role of public policy timing in the applied approach, i.e., the case of Polish policy towards the public hospital care sector. The final conclusion is that the role of timing is marginalized in Polish public health policy. The time dimension of its creation was ignored or treated as an exogenous event in relation to the rest of the policy formulation process. There is no political approach that adaptively links the right combination of resources and regulatory activity to timing for specific stages of development or growth in public hospital care.

**Keywords:** timing; public policy; policy making; Polish public health policy

## 1. Introduction

It can be assumed that with good public policy conditions, i.e., sustainable public policy conditions, the achievement of a sustainable net benefit may be enjoyed by society in the form of an optimal and possibly long-term solution to a specific public problem. A relatively permanent solution to a particular public problem can be seen in terms of the sustainable value (net benefits) for society and that the “carrier” is sustainable public policy (e.g., a specific sectoral policy). At the same time, a sustainable public policy is one that is well-designed, effectively implemented, and well-enforced. A key factor for achieving sustainable value as a result of public policy is public policy timing, although this is not the only influencing factor. This term refers to the ability to address matters related to public policy at exactly the right time.

Public policy timing is a recent, completely new, little known, and poorly recognized theoretical idea/concept in public policy shaping. This study presents the issue of public policy timing in the context of the postulation of using a balanced approach in the creation and implementation of public policies.

The first part of the work establishes the role of public policy timing and its significance in various economic theories (such as regulation theory, the concept of adaptive public policy, and the theory of policy timing based on the concepts of option value and transaction costs of the political process). Next, an attempt is made to create a more comprehensive and coherent theoretical basis for the purpose of analyzing the importance of timing in applied public policies. The approach of methodological

pluralism is adopted here, which allows us to reach for various cognitive inspirations that have been borrowed from numerous theoretical approaches. In turn, the second part of this work refers to the selected real sector policy, i.e., the Polish health sector policy. Here, an attempt is made to answer the question of whether the approach to shaping this particular sector policy is in line with the concept of public policy timing, i.e., whether, and if so, to what extent the issue of public timing is taken into account.

The methods used in this work are primarily deductive. A general concept of “public policy timing” is built and used here, although to a limited extent, i.e., taking into account the concept of adaptive public policy to discuss Polish health sector policy. Referring to the results of empirical research only serves as an exemplification and illustration of the deductively derived theoretical concept of “public policy timing”. Contrary to appearances, no inductive method is used in this work, meaning that no generalizations are derived from the information material collected during the empirical research. The only generalization that can be derived concerns the nature of Polish health sector policy, namely whether it is adaptive or not adaptive in the context of the “public timing” factor.

Section 1 presents the state of the theoretical thought on the issue of public policy timing, which constitutes the basis of creating and formulating the concept of public policy based on public timing. This means that within the framework of the concept outlined by the authors (see Section 2), the following points are presented: the point of implementing a policy closely linked with the so-called public policy timing; the results that can be expected from the application of such a policy; and the explanation, using three time perspectives, of why the inclusion of only two instead of three time perspectives in the process of public policy does not give assurance that the public (social) interest will actually be realized and not only the interest of the ruling party/coalition. In line with the assumed concept of public policy, Section 3 features the preparation and description of a way of examining Polish policy regarding public hospitals. The research results are, accordingly, shown in the form of tables in Section 6. The same section also describes the results obtained with the approach practiced by decision-makers in Poland regarding the creation and realization of policies in the public hospital sector. The study here is preceded (in Section 4) by a concise presentation of the systemic context, which allows for better insight into the specificity of the healthcare system in Poland. Section 5 contains the materials and considerations necessary to establish the importance of the time factor in the process of creating and implementing Polish policy regarding public hospitals. Finally, in Section 7, conclusions are formulated concerning the approach practiced by decision-makers in Poland regarding the creation and realization of public policy in healthcare and public hospitals in the context of the role of timing in public policy.

## **2. The State of the Theoretical Thought Regarding “Public Policy Timing”**

The issue of timing in public policy is not shown in the economic theory of regulation or in its positive or normative approaches. This also applies to ongoing discussions in the economic literature on proper regulation. There are two key issues in any regulation. The first is an attempt to substantively justify the reasons for adoption, which relate to the set of public policy objectives or result from the analysis of the implementation of public reforms or market mechanism failures. The second is to indicate which legal and economic tools, principles, and mechanisms offer the greatest chance of achieving regulation efficiency or the optimization of the regulation’s goals. The issue of timing remains in the background and works as a default, which is best seen in the context of proper regulation. Of the numerous definitions of proper regulation, the timing subtext arises fairly clearly from the definition [1], according to which proper regulation is well-designed, effectively implemented, and appropriately enforced, and if the regulation meets these conditions, it provides the greatest net benefit for society. It is not mentioned here, but it seems that proper regulation is of a procedural nature and that all of these conditions, i.e., process phases, take place in time and must be met in proper time for the greatest net benefit to society.



Public policy is closely related to regulation in legal terms and is connected with the ideology of the guaranteeing state. In the legal analysis of the obligations of public authorities, guarantees are understood to be dynamic, taking into account the interests of the beneficiaries of the system that supervise the functioning of the said system. For example, the Constitution of the Republic of Poland imposes an obligation on public authorities to ensure equal and fair access to publicly funded healthcare services. “Ensuring” is understood as a guarantee of equal and fair access to healthcare services financed from public funds, which must include not only the creation of a legal framework for the functioning of the public health system, but also active and dynamic control, as well as supervisory activities [2]. It is obvious that if the control and supervisory activities are to be dynamic, they must not only be appropriate, but also carried out at the right time and in the right way. The assurance by the regulator of an appropriate environment for conducting active control and supervision activities includes identifying and developing legal and economic tools, as well as the principles and mechanisms that provide the greatest chance of obtaining effectiveness and efficiency of control and supervision. It may turn out that for their completion or improvement, it is necessary to observe the real behaviors of regulated entities under the new/modified health system, and to analyze and evaluate the effects of their compliance with the intentions and intended aims of the regulator. Service providers belonging to the same public healthcare subsector, e.g., public hospital care, despite functioning in the same legal environment and period, may exhibit quite different behaviors and may result in significantly different economic, social, and health effects. This also applies to other entities within the system, such as local government units, which, on the one hand, conduct a decentralized health policy and act as a regulator toward the medical entities that they own or co-own, yet, on the other hand, are subject to statutory regulation themselves in order to direct their behavior or achieve the desired change in behavior toward subordinate medical entities. One example is the Polish regulation that increased the financial responsibility of local government units for losses incurred by subordinate medical entities, which is thus expected to lead to a change in the behavior of local government units relative to subordinate (unprofitable) medical entities [3]. This may lead to a further observation that it is necessary to track and coordinate public policy timing with health policy and for specific healthcare subsectors, such as public hospital care. This observation relates to the issue of adaptive public policy.

As part of the theoretical approach to adaptive public policy, an attempt to associate timing with public policy was presented by Koehler [4]. The author posed the following question: Can the development and implementation of public policy be improved by closely tracking and coordinating time with the policy of a regulated sector? Such an association was attempted based on the assumption that the asynchronism between the political process and the regulated sectors or activities may cause unintentional disruptions in the pace of economic change and development, and thus undermine the original intention of the regulatory policy or activities. In addition, such events can lead to unexpected future disruptions. That is why “a policy approach is needed that adaptively ties the right mix of resources and regulatory activity to the timing of particular stages of economic development or growth associated with a particular industry” [4] (p.99). In the issue of adaptive public policy, problems with determining the right time in public policy timing were examined using a new theory based on the concepts of “time-ecology”, “developmental change in time”, and “temporal signature”. The author emphasized that the indicated approach may apply to various organizational issues and may be related to time in various areas of the economy. The full range of space–time network linkages in cluster government and self-government authorities, namely the health service industry, creates an interconnected unique system of ecology among political, economic, and other areas, covering a clear time perspective in which the advantages of resource use and delayed responses of participants to ongoing changes in the industry’s environment are considered. In such a system, there are more or less intense and often complex rhythmic impulses that occur in parallel or in a punctual manner, affecting one another on a number of time scales flowing into the future. Each organized entity in the public healthcare system exists in its own past, present, and future in a unique way, possessing its own “temporal signature” that determines the position of the object in time and which is a detectable

phenomenon. External bonds mutually affect organizations by changing the dynamics of development and growth and the effects achieved by the organization. The whole process, in the context of this study, takes place in the combined adaptive landscapes of public authority or the health services industry.

At this point, it is important to add that the temporal signature of a particular medical entity could be obtained using the benchmarking method for healthcare providers and is expressed in the form of a benchmark, which, by its nature, positions the hospital relative to other hospitals in time and can cover various organizational issues and the effects achieved by the facility. As part of the benchmarking study, it is also possible to use the acquired data and information resources to detect distinguishing features of profitable or unprofitable public hospitals as a unique system in the cluster of public authority vs. public hospital care for the purposes of making adaptive health policy decisions. These are some (proprietary) suggestions for capturing the temporal signature and the unique entity in a given period within the “public authority/public hospital care industry” cluster.

In the economic literature, theoretical thought combining public policy with the timing factor has also been considered by other researchers, but this thought is not yet fully developed. It is reflected well in the work of [5]. Every public authority, whenever making a political decision, must ultimately decide on three separate issues, namely the choice of policy instruments, the setting of the levels of these instruments, and the timing of their implementation. However, in both theoretical and applied policy analysis, the time dimension of policy making is often ignored or simply treated as an exogenous event in relation to the rest of the policy formulation process, i.e., that policy timing is not an integral part of the public policy process.

To be precise, in the economic literature, the issue of public policy timing is highlighted, but mainly in terms of formal deadlines, negotiating (“playing for time”), and timing for communicating. Timing has an impact on formal public policy decision-making processes in specific jurisdictions. However, the right time to communicate with decision-makers about new public health policies (e.g., in the field of hospital care) also depends on other current problems and the likelihood of strong support or opposition to the policy [6]. In turn, the analysis of “playing for time” suggests that negotiations on divergences, and in particular legal regulations, occur not only with time, but also in the case of negotiations for the harmonization of legal orders from different countries (e.g., the European Union (EU) and its member states) and, perhaps above all, concern for the unity of time [7].

Mittenzwei, Bullock, and Salhofer [5] argue that in the literature devoted to the problems of optimal time in politics, it is often thought (e.g., [8]) that a change of policy is irreversible. By its very nature, politics can change, and policy-makers often make use of this fact with the regular introduction, changing, deletion, and reintroduction of policies. Researchers have formulated their own theory, where the central element is that “governments balance the costs of delaying policy reforms against the benefits. Costs are in the form of welfare losses, brought about by delayed adjustment to changes in the economic and political environment and by the costs of the political process that accompany policy changes. Benefits of delaying policy reforms stem from receiving better information by waiting” [5] (p.583). Here, the authors would like to add two observations of their own. First of all, what has not been said by the creators of this theory comes to mind, namely the default assumption that in the process of preparing political reform, every piece of relevant, cognitively valuable, and already existing information is used. Secondly, in light of the combination of this theory with Kohler’s concept, better information can be obtained by detecting the temporal signatures of participants in the public hospital care system, as well as the unique phenomena associated with the system (e.g., the phenomenon of profitable public hospitals under systemic conditions determined for a given time). According to Mittenzwei, Bullock, and Salhofer, the ability to wait before making a decision is very valuable when decisions are made in conditions of uncertainty, and, as time goes on, more and better information appears. The value of waiting for information and the costs of changing policy both shift the balance in the political economic equilibrium and cause sporadic policy changes.

To sum up, in terms of the neoclassical theory of economics, the concept of timing as an important issue has been recognized in the area of the negotiation and communication of new public policy. The

new economic theoretical thought combining public policy with the factor of public policy timing is shaping the theory of policy timing. In general, public policy timing is an integral part of the public policy process and is explained in different ways through the prism of a perspective inherent to the formulation and implementation of the so-called adaptive public policy, or through the prism of the value of the ability to wait for better information before making decisions in conditions of uncertainty. Both approaches seem coherent and logical. In the concept of adaptive public policy, it is crucial to detect the temporal signatures that carry better information and unique phenomena in the system found in a given public healthcare system. This better information, combined with the ability to wait for it, has the benefit of delaying political reform (to avoid frequent policy changes and the irreversible costs of policy change). In addition, due to the recognition of the role of timing in the formulation and implementation of public policy timing, leading to the acquisition of better information, it is possible to formulate more accurate regulation related to this policy, which has the characteristics of good regulation. Moreover, considering the legal approach to the regulations related to public health policy, it should be emphasized that the obligation of public authorities to provide active control and supervision within the public health system is clearly combined with the ability to perform appropriate control and supervisory activities in the best possible way and at exactly the right time.

### **3. The Concept of Public Policy is Closely Linked to Public Policy Timing**

The concept of public policy is closely linked to public policy timing. We wonder whether one can improve—and, if so, how—the development and implementation of sectoral public policy by including time treated as an endogenous event in the process of shaping public policy? The most general sense of seeking an answer to such a question lies in the fact that decision-makers have the opportunity to implement sectoral public policy that is better focused on providing the greatest net benefit to society.

This concept claims that a different perception of time, where time is an endogenous event and not an exogenous event in public policy making, changes thinking about methods for building better informed policy (i.e., evidence-based public policy decision-making). The expected effects of implementing a better informed sectoral policy are positive, i.e., those based on the recognition of reaction time intervals (taking action) in various types of industry participants, the reasons for too late reactions compared to those expected by decision-makers, as well as those contrary to their intentions. The practical use of this knowledge, by developing and implementing a complete set of appropriate measures to prevent or eliminate the occurrence of excessive delays for various participants in the sector, is also important. These are mainly economic and social factors.

Economic effects relate to the rational operation of the system (rationality of resource management), such as:

- Increasing the resilience of the regulated sector to unintended disturbances, leading to unintended disruptions in the pace of economic change (e.g., scale and organization of health services) and economic development (e.g., due to poorer public health), thereby undermining the original intentions of policies or regulatory actions (assuming that the policy is really in the public interest).
- Reducing the risk that such unintended interference will lead to unintended future disturbances in the pace of economic change and development.
- Occasional changes in sectoral public policy, which entail reducing the costs of introducing, changing, deleting, and reintroducing specific sectoral policies, leading to saving costs of the regulated system (e.g., public health system), reduced waste of public funds allocated to the operation of the regulated sector, and more funds remaining in the system to achieve the main objective of the sectoral policy.

Social effects relate to the main objective of sectoral policy, as well as to social rationality, such as:

- Ensuring equal access to goods produced in the sector when financed from public funds, or at least equal opportunities to obtain such access.

- Maintaining or increasing the usability (quality and scope) of goods financed from public funds produced in the sector.

In addition to these effects, a political side effect may occur, i.e., ensuring or strengthening public support for a given public policy.

The concept of public policy is closely linked to “public policy timing” and has three different time perspectives in its field of vision:

- The first perspective concerns the annual cycle of the public budget (formal and administrative deadlines for the planning, preparation, and implementation of budget expenditure).
- The second perspective concerns the cycle of exercising public authority, determined by the time frame of general elections.
- The third perspective concerns the occurrence of time asynchronisms between the course of the public policy process and the course of processes in the regulated sector, as well as between public policy activities and those undertaken by sector participants.

By associating all three time perspectives with one another, a balanced time perspective can be created for the public policy process.

The first and second perspectives create exogenous events for public policy that are not influenced by decision-makers, but instead determine the quality, manner, and duration of the policy. The implementation of expenditure related to policy development and implementation must take place within a rigid bureaucratic framework of the annual budgetary cycle, and, in addition, the term of office of public authority may induce political decision-makers to be guided by more rational political action, achieving rapid, preferably spectacular success, even if it is economically unjustified. The rationality of political action is dominated by the interest of maintaining or gaining political power, which is typically the interest of the dominant ruling party. In the context of rational political action, the time perspective is determined by the calendar of general elections, i.e., the cycle of exercising power by the ruling party. In practice, policy principles, including health policies, are designed in such a way that their use is either short-term or long-term, but the period of validity of government policy is usually limited to the term of the government [9]. The rationality of political action does not have to be closely associated with economic rationality, or be in the public or social interest. Even Shiffman [10], in a study of the phenomenon of setting agendas in health policy, challenged the assumptions that health problems appear in political programs only through rational consideration and the careful consideration of evidence. However, the need to include in the public policy the schedule set resulting from the state budget cycle and the public election cycle should not justify the creation of the poorer quality sectoral policy from the point of view of ensuring public interest and economic rationality. The third time perspective, in which time is an endogenous event in the process of creating and implementing public policy, creates the chance for achieving and implementing better quality policy. It is a time perspective for such a policy that fits into the idea of evidence-based public policy. In this perspective, the tasks in the process of sectoral policy based on public policy timing are as follows:

- Recognizing and explaining the causes of the indicated time asynchronism.
- Determining the economic consequences of the delayed reaction of the entities implementing public policy on the outcome of actions taken by the entities of the regulated sector.
- Determining and developing adequate means of leveling the response when delayed too long (i.e., determining whether economic regulation is sufficient and which of its forms are to be employed, if it is necessary, as well as what legal regulation is needed).

The components that make up public policy timing are the temporal signatures (time structures) of the entities in the system, along with their external linkages, determining the best time to make decisions and act (keiretsu), and the ability to wait for better information.

In the process of public policy timing, better information is generated for the purposes of creating a timetable that takes into account the concepts of keiretsu for introducing changes and undertaking

actions that modify or reform the functioning of the sector and the formal framework of annual financial budgets, as well as, where possible, general elections (it may be in the public interest to move the schedule outside of the electoral cycle). The carriers of such better information are temporal signatures, which are specific to various types of organizational entities of the economic system (e.g., the healthcare system), as well as linkages between the “temporal signatures” of entities occurring on the active side of the policy (conducting public policy activities) and on the passive side (entities of the sector toward which the policy is conducted). Knowledge about these temporal signatures and their external linkages and related phenomena is unique, because it takes into account the systemic, economic, and cultural contexts in a given country. In addition, signatures, linkages, and phenomena may change due to changes in the functioning of the system. Waiting for such information, provided that the public policy information base is focused on its acquisition and processing, is a method for preparing better quality public policy and better implementation without the risk of frequent changes being the result of unforeseen disruptions. The benefits of delaying modifications or thorough reforms when resulting from waiting for better information are greater than the side effects. Amongst the undesirable effects, there are social losses (resulting from prolonged unfavorable states of access and utility provided by the goods sector) and costs of the public policy process accompanying changes in the policy.

This perspective allows one to find better solutions to a key sector policy problem at a given time. In the economic systems of various countries, the key problems are different depending on the state of development of the system, and they are subject to change over time. Hence, the information obtained will always be unique because it will be focused on phenomena that cause the existence of a key problem.

Restrictions on the effective use of the third time perspective are poorly developed information databases for the process of creating and implementing public policy, as well as a possible lack of will of public authorities to pursue evidence-based policies. Additionally, as Sisnowski and Street [11] pointed out, obstacles to creating evidence-based public health policy may be the different characteristics between the two worlds of researchers and policy-makers, including their different timeframes, interests, and priorities.

#### **4. The Method of Examining the Case of Polish Policy Regarding Public Sector Hospitals**

This study examines the approach to shaping and realizing the policy regarding public sector hospitals in Poland in terms of this policy being consistent with the concept of public policy timing. This means deciding whether the approach practiced in Poland involves the issue of public timing, and, if so, to what scope. The approach was evaluated in terms of three components of public policy based on the concept of public policy timing, as follows:

- Temporal signatures (time structures) of providers of hospital services financed from public funds (public hospitals), together with their external linkages.
- The appropriate time (keiretsu) for decision-making.
- The ability of policy-makers to wait for better information.

The research was based on providing and explaining (according to the specific criteria) answers to the questions set in the area of each component. The sets of questions are presented in Table 1.

The fundamental objective of healthcare policy in the area of hospital care based on the principles of universality, equality, and free access for all citizens is highly problematic under the conditions of permanent shortages of public funds in the health sector. Since the 1990s, the key problem has been the high and growing level of financial expenditure in the public hospital sector and the financial ineffectiveness of the great majority of the service providers in this sector. The specificity of the key sector is taken into consideration in the study, as well as the specificity of the functioning of the health service in Poland in the aspect of the provision of hospital care financed from public funds, presented in the next section of this paper.

**Table 1.** Sets of research questions and criteria for answering.

<b>Temporal Signatures of Producers from the Sector and External Linkages of Structures:</b>	
1.	Is the sector system in possession of information that is helpful in defining the temporal signatures of the producers financed from public funds? Answer based on the criterion: "Information to define temporal signatures of producers".
2.	Is the systematically collected information helpful in defining the temporal signatures of the producers financed from public funds? Answer based on the criterion: "Systematic collection of information to define temporal signatures of producers".
3.	Are there defined temporal signatures for the producers financed from public funds? Does this result in a time delay following the introduction of a change/political initiative and the reactions (undertaken actions) of the producers? This knowledge allows for establishing whether the sector reacts/takes action in line with the intentions of policy-makers. Answer based on the criterion: "Temporal signatures of producers".
4.	Is there systematic collection of information about the relationships of the producers and the producing entities (the entities with the functions of ownership and their own supervision)? Answer based on the criterion: "Systematic collection of information about external linkages of temporal signatures of the producers in the area of the relationship between the producers and the producing entities".
5.	Is there an examination of the relationships between the producers and the producing entities, as well as of time changes in the relationship under the influence of the introduced changes/policy actions? These relations and their changes in time are used to describe the external linkages of the temporal signatures of the producers. Answer based on the criterion: "Examining the external linkages of the temporal signatures of the producers in the area of the relationship between the producers and the producing entities".
6.	Does the policy (i.e., the decisions and actions) make use of the knowledge about the relationship and changes in the relationship between the producers and the producing entities? Answer based on the criterion: "Use in public policy of the knowledge about the temporal signatures of the producers and their external linkages in the area of the relationship between the producers and the producing entities".
7.	Is there a systematic collection of information about the relationship between the producing entities and the decision-makers at a central (national) level? Answer based on the criterion: "Systematic collection of information about the external linkages of the temporal signatures of the producers in the area of the producing entities and the decision-makers at a central level".
8.	Are the relationships between the producing entities and the decision-makers examined at the central level, and are the time changes in the relationship under the influence of the introduced changes/political actions considered? Answer based on the criterion: "Examining the external linkages of the temporal signatures of the providers in the area of the producing entities and the decision-makers at a central level".
9.	Does the policy (i.e., the decisions and actions) make use of the knowledge about the relationship and changes in the relationship between the producing entities and the decision-makers at a central level? Answer based on the criterion: "Use in public policies of the knowledge about the temporal signatures of the producers and their external linkages in the area of the relationship between the producers and the decision-makers at a central level".
<b>Time for Making Decisions and Political Action (Is It the Appropriate Time—Keiretsu):</b>	
1.	Prior to the assumption of a policy solution, is the solution subject to public discussion and has it received social acceptance (i.e., it is not contested by important groups in that sector)? Answer based on the criterion: "Discussed and socially accepted policy solution during the time before its introduction".
2.	Before making a decision/implementing action, is there a complete set of means, prepared and analyzed by experts, indispensable to effectively conduct a change (in the sphere of the provision of goods and the supervision of producers)? Answer based on the criterion: "The complete set of political means are analyzed and prepared by experts prior to implementation of the change".

Table 1. Cont.

Ability to Wait for Better Information:	
1.	Are the policy decisions/actions taken in the keiretsu-type time? The clear proof of the existence of the ability to wait for better information is that of the decisions made/actions taken on the basis of better economic information. Answer based on two criteria: "Comprehensiveness of the legal solutions prepared before introducing a decision about policy change" and "comprehensiveness and sufficiency of the prepared set of policy means before its introduction".
2.	Is there political will to wait for better information? The indicators of the existing political will to wait for better information include striving to develop a backup of economic and business information in order to be better informed, avoiding making decisions/policy actions motivated by political rationale (i.e., the wish of a ruling party/coalition to quickly show success resulting from political change, even if devoid of true significance, or the change is downright harmful to the long-term public interest), existing public accountability of political decision-makers, and economic sanctions for introducing solutions (decisions, political actions) harmful to public interest, which encourages the political will to act, above all, in the public interest. Answer based on two criteria: "Developing informational backup for politics" and "domination of political rationale over economic and social rationale in the process of public policy making" (this criterion covers two aspects, namely political solutions based on political rationale and the accountability and economic sanctions regarding political decision-makers).

## 5. Systemic Context for Healthcare Policy in Poland

The assumed directions of state policies impact the formation of the relevant organization and the structure of the system (see Figure 1). Polish regulations that address the functioning of the healthcare system, related to the 1999 reform of that system, are included in the Universal Health Insurance Act. The regulations it contains reflect the accepted fundamental principles of the functioning of the healthcare system, among which the following should be included:

- The principle of social solidarity, which means that all of the insured persons, by paying their contributions, create a specific fund that finances the benefits for those that need them. Granting benefits available in the system depends only on the justified health needs of the insured person, and, at the same time, on being equal for all.
- The principle of self-financing, which means that both the payee and the service providers should finance their activity out of the obtained revenues, is maintaining financial equilibrium. This principle is also reflected in striving to separate the function of the payer for services from the function of the provider of services. Hence, in principle, the payer, namely the National Health Fund (NFZ), cannot run healthcare facilities, and its relationships with the service providers are regulated through contracts and flat rates for the provided health services. The principle of aiming to ensure equal access to services, which corresponds to, among others, assigning the same range of services to all of those entitled to them, and an equal allocation (understood as ensuring the coverage of the costs of the provided medical services) of the entire range of services in every region (voivodeship).
- The principle of economic and deliberate activity.
- The principle of self-governance. This principle was subject to rapid modification in light of the Act introduced in 2003 [12], which resulted in the centralization of the "Kasa Chorych" system and the introduction of a single payer, namely the NFZ.

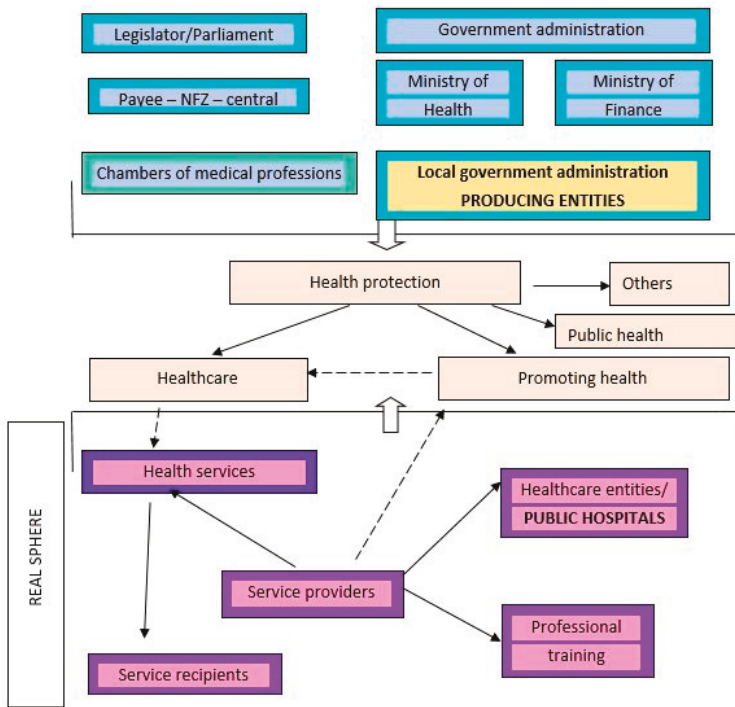

Figure 1. Organization of the healthcare system in Poland.

### 6. Defining the Role of Public Policy Timing in Polish Policy toward the Public Hospital Care Sector

Activities focused on the public hospital care sector fall within the scope of health policy. The role of health policy is to create development directions for the entire healthcare system, including healthcare that is constantly in the forefront of modern times, such that changes in the environment and the system itself do not surprise its unprepared participants. It should also be remembered that the area of interest in health policy is extensive, and a broad perspective should be used, capturing the instrumental role of many sectors of the economy, since it affects many areas that include, among others, family and child protection policy, agricultural and food policy, industrial policy, environmental protection policy, education policy, employment policy and protection of working conditions, and housing policy.

Determining the legal framework and directions of action in health policy is conducted by the legislative authority, government administration, and local government administration. Each of the links, formulating and creating conditions for action, directly influence the shape and organization of the health sector, including public hospital care. The legislative authority sets the legal framework for the functioning of the healthcare system. Exercising this kind of power includes introducing new legal regulations, but also changing the current law. This area includes, among others, decisions on the broadly understood organization of the healthcare system, decisions on the arrangements contained in the Budget Act, decisions on tax rules—in particular, exemptions and deductions, and health expenditures obtained from the collected medical services—as well as arrangements regarding the amount of health insurance premiums (which are part of the tax). The government administration strengthens strategic functions and limits the functions of day-to-day management by conducting central government administration in Poland, including non-integrated administration in the voivodeship and local government administration. The government administration body in the field of healthcare is the Ministry of Health, which, among other rights, has control rights



over other entities operating in the system, but also sets the directions of the country's health policy. One of the most important roles in the healthcare system, however, is played by local government administration performing the functions of the so-called creating (producing) entities. As the special owner of public entities providing medical services, it accepts responsibility for the incorrect activities of its subordinate entities. The most important requirement of local government units, forming bodies of independent public healthcare facilities, is exercising appropriate supervision over them. In the current legal framework, the principles of supervision are regulated in the Act of April 15, 2011 on medical activities [3]. The control and evaluation of a health unit's activity and the work of its manager is carried out, in particular, in areas such as the proper management of property and public funds and financial management, as well as the implementation of tasks specified in the organizational regulations and the statute, in addition to those in the scope of availability and quality of health services provided. What is especially important is the supervision over the financial economy, which is exercised by controlling and assessing its legality, economy, purposefulness, and reliability. On the other hand, supervision over the correctness of property management is carried out through control and assessment, in particular of the use of medical apparatus and equipment, the application for the purchase or acceptance of medical apparatus and equipment, the application for the sale, lease, or rent of fixed assets, or the transfer of such assets to companies or foundations.

This multi-level decision-making has caused the emergence of varied attitudes and behaviors of public hospitals in the activities of hospital medical entities in the face of the changes taking place. An important source of information of the problems undertaken in the framework of health policy is the analysis of activities carried out in connection with the implementation of healthcare system reforms. In Poland, these reforms are usually based on organizational changes in the system, often without touching upon previously diagnosed problems. It is intentionally assumed that new solutions will improve situations (mostly bad economic situations) with which hospitals have had the biggest problems.

An expression of the poor economic situation of public hospitals is the high level of liabilities due to independent public healthcare facilities in subsequent years (2002–2018), shown in Table 2.

**Table 2.** Due obligations of independent public healthcare institutions in the years 2002–2018.

As of:	Independent Public Health Care Facilities Created by Local Government Units and Central Units		Independent Public Health Care Facilities Created by Local Government Units and Central Units	
	Liabilities due		Liabilities due	
	In Thousand PLN	Including Supplies and Services	Dynamics of Changes in % Previous Year—100%	Including Supplies and Services
December 31, 2002	3,248,783	2,084,406		
December 31, 2003	4,732,974	2,480,863	146	119
December 31, 2004	5,684,426	2,839,630	120	114
December 31, 2005	4,875,372	2,310,073	86	81
December 31, 2006	3,603,739	1,912,989	74	83
December 31, 2007	2,627,427	1,664,235	73	87
December 31, 2008	2,379,577	1,510,519	91	91
December 31, 2009	2,340,755	1,579,090	98	105
December 31, 2010	2,258,826	1,657,537	96	105
December 31, 2011	2,281,329	1,844,829	101	111
December 31, 2012	2,360,475	1,961,131	103	106
December 31, 2013	1,930,971	1,657,225	82	85
December 31, 2014	1,807,185	1,603,217	94	97
December 31, 2015	1,758,890	1,564,129	97	98
December 31, 2016	1,739,476	1,555,351	99	99
December 31, 2017	1,407,669	1,273,712	81	82
December 31, 2018	1,622,299	1,547,128	115	121

Source: [13].

The implementation of tasks adopted by the state as part of health policy is related to the amount of financial resources that can be allocated to maintaining or improving the health of society. Not only are their size and structure important, but also their use by individual institutions that provide health services. The consequences of the reforms introduced and the financial effects of these changes are also significant. There have been many significant reforms in Polish healthcare. In 1999, independent public healthcare facilities were introduced in place of the existing healthcare facilities. In 2005, the place of Kasa Chorych funds was taken by the centralized National Health Fund (NFZ), and, in 2011, the system was further organized by introducing the Medical Activities Act. Each of these changes was accompanied by strong pressure of success, regardless of the degree of preparation for the transformation process. Due to the usually very short adjustment period to the new conditions, additional support for the system was organized. As a consequence, the Polish healthcare system has been repeatedly “deleveraged”, which has clearly influenced the attitudes of the managers of public hospitals and their owners, assuming “tacit agreement” in their activities for further deleveraging of entities and uncertainty as to the future of entities. It should be remembered that the processes of debt deleveraging are basically not conditioned by any real economic, organizational, or medical requirements. In view of the above, the Ministry of Health carried out the aforementioned process of deleveraging hospitals several times. The first debt relief took place after the healthcare reform in 1999, which was when the Kasa Chorych funds were created. The reform assumed that the facilities most frequently visited by patients would receive funding. In order to provide equal opportunities, all hospitals were deleveraged. The treasury took on over 7 billion PLN in debt by doing so. However, hospitals started to get into debt again, and the next stage of healthcare reform was to replace the existing health funds with the institution of the National Health Fund in 2004.

Since 2004, the National Health Fund has been dealing with the pricing and contracting of services in hospitals. Despite such a significant change, an increase in the overall debt of hospitals is still being observed. One of the reasons for this is the change in legal regulations affecting the level of expenditure of public hospitals without indicating specific sources of coverage. The so-called 203 Act, adopted in 2000, was a special one, as it forced healthcare facilities to increase their staff salaries by 203 PLN. Total debt increased rapidly during this period. In 2005, the government adopted the Act on state aid and the restructuring of public healthcare institutions. This enabled public hospitals to take loans from the state budget to repay outstanding liabilities. At the same time, the Act allowed hospitals to write off public liabilities after the restructuring process was completed. Since then, the dynamics of the increase in liabilities (see Table 3) have clearly decreased, associated with decision-makers refraining from introducing further unannounced changes. Stable working conditions have, however, caused the settling of public hospitals in economic reality.

The data contained in the table above show the effects of the actions taken by hospitals in individual voivodeships and central units (e.g., the Ministry of National Defense and the Ministry of Interior and Administration). The relative stability of organizational and legal conditions and the relatively long period of stabilization have allowed for the implementation of real remedial measures in hospitals that improve their economic results. An important success is the significant change in the ranking of hospital liabilities of the Dolnośląskie, Lubelskie, and Podkarpackie voivodeships, achieved as a result of numerous, often unpopular, actions. The consolidation of hospitals, changes in business profiles, or the transfer of parts of unprofitable activities to other hospitals has resulted in a clear improvement of their economic situation and better ranking. Among the 18 study participants, the aforementioned voivodeships have significantly improved. Dolnośląskie changed from position 1, the weakest, to position 8; Lubelskie changed from 8 to 3, and Podkarpackie changed from 12 to 6 in the years of 2005 and 2017, respectively. This demonstrates the clear need for stable operating conditions and the need to be well prepared for future tasks, i.e., timing, which is jointly responsible for success in planned projects.

**Table 3.** Total liabilities of public hospitals by voivodships (in million PLN).

Voivodeship	December 31, 2005	December 31, 2017	2017/2005	Ranking 2005	Ranking 2017
Dolnośląskie	1488.7	703.9	47.3%	1	8
Mazowieckie	1217.0	1790.9	147.1%	2	1
Śląskie	993.7	1402.6	141.1%	3	2
Łódzkie	978.8	672.4	68.7%	4	9
Pomorskie	836.7	184.6	22.1%	5	16
Małopolskie	673.3	1007.2	149.6%	6	4
Lubuskie	599.0	62.4	10.4%	7	18
Lubelskie	531.7	1047.1	196.9%	8	3
Kujawsko-Pomorskie	464.0	966.4	208.3%	9	5
Wielkopolskie	376.4	771.6	205.0%	10	7
Świętokrzyskie	374.9	397.4	106.0%	11	11
Podkarpackie	340.7	832.9	244.5%	12	6
Zachodniopomorskie	318.1	412.9	129.8%	13	10
Podlasie	279.5	367.6	131.5%	14	12
Ministry of Interior and Administration	234.5	342.2	146.0%	15	13
Warmińsko-Mazurskie	220.6	237.8	107.8%	16	15
Ministry of National Defence	180.1	271.9	150.9%	17	14
Opolskie	165.8	142.2	85.8%	18	17
TOTAL	9450.0	11,614.1	122.9%		

Source: [13].

Good action means the opportunity to develop and compare the effects of one's actions with the effects of others. Unfortunately, even during a period of exceptionally stable conditions, no systems of universal information on phenomena occurring in the healthcare sector, catalogues of "good practices", or systems of warnings about anticipated difficulties have been introduced in Poland. The market environment has encouraged hospitals to make independent decisions (not enforced by the system), resulting, for example, in the process of ownership transformation. As a result, many hospitals have changed their legal form of business, usually to companies with the majority share of local government units. This form was economically justified, because it gave them the right to conduct activities going beyond the system financed by the payer (NFZ). The year of 2011 brought further turmoil to the economic situation of public hospitals, which was normalized by transferring the obligation to compensate the hospital deficit (net losses) to the forming entities, i.e., local government units. This decision was a surprise not only for hospitals, but also for the local government units (LGUs) themselves [14]. The need for information on the situation of other hospitals and the attitudes of individual LGUs has become extremely important. However, for the purposes of the control and ownership of supervision functions, individual LGUs only have their own information systems or control support tools (or did not have them at all). These systems are not consistent in any way, which absolutely limits their comparative functions. As a result, there has been no available or reliable information collection that would allow rational decisions to be made, either at a given moment or in the future. Only within the framework of scientific research conducted by scientific centers can one find selective or comprehensive studies on this issue. A special place is occupied by unpublished statistical reports based on data covering all voivodeships and data collected as part of an innovative research project carried out in 2011–2015 by the Wrocław University of Economics [15]. These studies have identified the distinguishing features of profitable and unprofitable hospitals. Nevertheless, interest in the results of the study [16] was negligible, on the part of both hospitals and decision-makers. Other interesting research in this area has been conducted only fragmentarily, e.g., in the Łódzkie and Pomorskie voivodeships, which also remains only in the sphere of scientific inquiry.

The need for good information turned out to be necessary at the time of introducing another very important reform—the so-called "hospital network" in 2017 [17]. The hospital network has been

operating since October 1, 2017. The Act introducing this organizational change in the system was prepared in March 2017 and signed on April 2017, and the classification of hospitals into the network was announced on June 27, 2017, without prior information on the planned conditions necessary to be met. Thus, hospital owners did not have enough time to prepare for this change. This means that there was a lack of optimal time projected for hospitals, the so-called timing, with which they could better prepare for entering the network. It is also worth noting that at the time the network was introduced, hospitals were at various stages of economic growth (even if they remained at their profiles, they differed in their efforts to improve their profitability) or were at various stages of economic development (some expanded the range of benefits to ensure better profitability and others changed their legal form). This did not affect the decision to qualify for the network.

Along with the introduction of the hospital network, the method of obtaining funds for hospital operations from the public payer, i.e., from the NFZ, was also changed [18]. The new method of financing benefits was based on a lump sum covering existing contract performance, but without taking into account the previous numerous so-called oversupplies, i.e., necessary medical services provided by hospitals despite the lack of financial coverage in the contract with the NFZ.

In general, hospitals were surprised by the pace of introduction of the “network” solutions and the shape of the reform discriminating against hospitals that were on a development path (i.e., a path not matching the concept of a general hospital or, otherwise, those operating as commercial companies). It should also be emphasized that the intentions of domestic decision-makers regarding the profitability of contract-financed hospitals are not clear, since they had information on the specific properties of profitable and unprofitable hospitals and information from the hospital environment about the potential negative consequences for hospitals and their patients in the context of the rapid entry into forced legal regulations regarding hospital networks.

As a consequence, the quickly implemented changes have not brought the expected effect so far. The introduction of the network, together with the change in the financing method based on the lump sum calculated according to an algorithm, has not changed the decisions taken in hospitals. With the assumption that by limiting the number of service providers (network of hospitals) and transferring funds at a level that takes into account the current overall performance of services (only services settled with the payer), but without additional incentives, a visible improvement in the operation of public hospitals has not been demonstrated. Public hospitals, especially those that are subordinates to district self-government units, are reporting increasing losses and a higher level of liabilities due. The lack of real preparation for action in the new conditions and the lack of real incentives did not lead to the decision to change in the hospitals themselves. Simple services have not transferred from departments to specialist hospital outpatient clinics, although this was the decision-maker’s expectation. No other explicit changes have been made to improve the efficiency of operations, because another mechanism (the obligation of LGUs to cover the hospital deficit) has not inspired them. The lack of comprehensiveness in the last introduced reform, as well as the lack of time for the proper preparation for the planned changes, has not allowed the most anticipated effects of the reform to be obtained, which are, on the one hand, an improvement in the economic situation of public hospitals, yet, on the other, an improvement in access to services for patients, including the shortening of queues.

The need for public policy timing in Polish policy toward the public hospital care sector is therefore very clear. Its apparent lack means that the ability to access better information has not been developed in public hospitals. Changes in political reforms lead to uncertainty and to an increase in financial risk for hospitals and their owners, which does not create a system of universal information on phenomena in the hospital care sector, and which should be a valuable information foundation in the process of formulating and implementing health policy and developing proper regulation. In addition, the lack of homogeneous systems used to perform the functions of ownership control and supervision in local government units causes constant systemic instability and the permanent dissatisfaction of the system’s beneficiaries, i.e., dissatisfaction of both the service providers and the patients.

## 7. Results of the Research on the Role of Public Policy Timing in the Policy Regarding Public Hospitals in Poland

The research results are presented in Table 4.

**Table 4.** Polish policy regarding the public hospitals sector in light of the components of the policy based on public policy timing.

Components of Public Policy	Question Number	Answer	Justification
Temporal Signatures of the Sector Producers and External Linkages of Structures	1	YES, partly	There are defined empirical characteristics which distinguish profitable and non-profitable hospitals but only for the period 2010–2014; there is no systemic way of studying changing characteristic for the former and the latter resulting from introducing changes or the impact of policy; there is ordered and in-depth knowledge on the reactions of hospitals (undertaken actions and their effect) but only for the period 2010–2014; there is a lack of research on the time of reaction to the introduced change and the impact of policy on the part of these hospitals.
	2	YES, partly	Collected information is useful for defining time structures of producers but it is not being processed. Among the bodies gathering data there are the payer, NFZ, and the agency of the Ministry of Health, Centrum Systemów Informacyjnych Ochrony Zdrowia.
	3	NO	Actions taken by producers are often diverse from the expectations of decision-makers and contrary to policy intentions. Example: the lump sum system in hospitals was supposed to impact the change in the method of providing certain services and transferring them from hospital wards (expensive to run) to cheaper, in-hospital ambulatory care—and this did not happen. Only successive corrective initiatives resulted in the changes expected by decision-makers.
	4	NO	No targeted information about producers–producing entities relations is being collected.
	5	NO	Due to the lack of information about the producers–producing entities relations, they are not examined.
	6	NO	Knowledge about temporal signatures of producers and their linkages is not being utilized. Example: without going into the relations and their changes, a legal regulation was introduced imposing the accountability of producing entities for the bad financial condition of hospitals.
	7	NO	No information is being collected about producing entities–decision-makers relations at the central level.
	8	NO	Due to the lack of information about the producing entities–decision-makers relations at the central level, these are not being examined.
	9	NO	Solutions or changes are introduced without the knowledge about these relations.
Time of Making Decisions/ Taking Political Action(Is It Appropriate—Keiretsu)	1	YES, partly	As a rule, new solutions are subject to public consultation, but the lack of approval on the part of important groups in the sector does not always result in rejecting the change. Example: NFZ replacing the Kasa Chorych system.
	2	NO	There is a common shortage of executive acts referring to a significant part of actions, independently of the currently ruling political party/coalition and inadequacy of material, human and financial resources in the scope of the functions of production, as well as supervision and control over producers. Example: the introduced regulation regarding the increase of nursing services for patients in the context of the sharp decline in the general number of nurses.
Ability to Wait for Better Information	1	NO	Frequent loopholes in the prepared legal regulations and their insufficiency result in a lack of ability to wait for better information. Example: detailed changes in the obligatory way of running cost accounting for hospitals appeared much later than the actual legal regulation that introduced them.
	2	YES	Actions targeted at a momentary success, without any relevance for a real permanent solution of the problem. Example: writing off hospitals' debts without deciding about the form of future hospital work and its results; at the same time there are no significant financial sanctions planned for wrong decisions and harmful actions.

The research carried out here includes three components of public policy regarding the sector of public hospitals in Poland, indicating the absence of conducting policies based on the public policy timing. Most of the criteria determined for individual components were not met, or only met in part.

The only absolutely positive answer appeared in the component “ability to wait for better information” in the second criterion, but since that criterion is of a negative nature, this is not, in fact, a positive result.

The approach used by public decision-makers in policy regarding public hospitals has created several effects that do not bring about a positive contribution to the concept of a policy based on public policy timing. The remaining results are described below.

- 1) In the period preceding the reform based on “hospital networks”, there were numerous and inconsistent changes in difficult and hardly predictable reforms. They were chaotic, frequent, and undertaken under the influence of current political issues and pressing financial and infrastructural problems in the health system without a clearly defined vision. At the national level, there was no waiting for “better information”, nor was it essentially sought in a methodical and reproducible manner such that it would allow the detection of unique phenomena in given conditions and time. Additionally, at the regional (local government) and local (district and communal) levels, interest in obtaining better information as part of the function of controlling and supervising subordinate hospitals was different. The ability to wait for better information at the national and lower levels has been shown to not exist. This means that the dimension of the optimal time for creating health policy, including in hospital care, was ignored or treated as an exogenous event in relation to the rest of the policy formulation process.
- 2) As a result, hospitals have been operating in conditions of uncertainty and growing financial risk. This has forced hospitals and their owners to take some specific approaches to solving the general problems of the size, quality, and structure of services versus the hospital’s economic profitability. Over time, hospitals have created their own survival solutions. Scientific research conducted in the environment has led to the detection and transfer of unique information to decision-makers, e.g., the properties of profitable and unprofitable hospitals, which can be treated as better information in the understanding of theories combining timing with public policy. Before the development and implementation of the reform related to the “hospital network”, according to the knowledge of the authors, it was possible to use better information; however, this was omitted in practice.
- 3) The method and scope of the reform of the operation and financing of hospitals included in the so-called public hospital network were contradictory in light of adaptive policy theory, a policy approach that adaptively links the right combination of resources and regulatory activity to timing for specific stages of development or growth in public hospital care.
  - 3a) Public hospitals that were included in the “hospital network” at the time of the introduced reform were at various stages of development in connection with varied adopted directions and ways of adapting them to changes in the operating environment. These hospitals operated in conditions of uncertainty and growing financial risk. For hospitals that were at a low stage of growth or at a higher level but were not sustainable, this concerns financial and production aspects which are significantly unsustainable (i.e., hospitals did not develop the quality of human resources and/or did not develop their activity to improve the quality of services, poorly responded to the intention of the previous legislator regarding economic rationalization of operations, or did not develop the structure of the assortment of services). However, hospitals that fulfilled the specific requirement of being a four-profile hospital (providing health services in four basic medical specialties: internal medicine, general surgery, obstetrics and gynecology, and pediatrics, as well as in the field of anesthesiology and intensive care) were granted more complete access to public funding. Hospitals that entered a higher stage of development (i.e., those who developed a socially desirable offer of services subject to public funding and the ability to provide these services) found themselves in the so-called trap of strategic surprise as the result of a sudden cut of some benefits financed through a public contract. Additionally, public hospitals that, according to the intention of the previous legislative authority, were

transformed into commercial companies with the ownership of local authorities and modernized (with significant investment outlays) were suddenly in a difficult financial situation. The business continuity of these hospitals was threatened by virtually being cut off from financing health services by the NFZ. The omission of the timing factor in the reform related to the “hospital network” led to some hospitals falling into a strategic trap, and this particularly applies to those that previously actively adapted to changes in the environment. This also jeopardizes the effectiveness and efficiency of health policy pursued by local/regional governments, which hospitals falling into a strategic trap are often subject to.

- 3b) The lack of an adaptive political approach is expressed in the failure to make use of the existing unique information (even at the time preceding the communication of the new reform) on the factors and sources of economic viability in connection with the qualitative elements of the operation of public hospitals and their changes over time, and thus information that could allow for the development of better regulation of the “hospital network” (i.e., information that should not be ignored in regard to the importance of the profitability aspect of hospital medical entities for the health system).
- 4) Ignoring or not using the already existing “better information” indicates that the approach of the decision-makers of Polish health policy deviates from what is desirable in the theory of policy timing, i.e., the government balances the costs of delaying political reform with the benefits (resulting from receiving better information by waiting).

The introduced reform carries social and economic losses. The resources of hospitals included in the “public network of hospitals” are not better (i.e., more efficiently and rationally) used, the problem of the financial debt of hospitals is growing (only partly resulting from the increased wage pressure in public hospitals at that time), there is a growing negative pressure in hospitals on treating patients not as customers but as a cost to be minimized, and the management’s motivation to improve the economic viability of hospitals without at the same time having a negative impact on changing the perception of the patient has been weakened. These losses could be avoided or reduced by prudent use of the valuable information already available to decision-makers and by consideration of the issue of the economic viability of healthcare entities.

## 8. Conclusions

The concept of a policy closely linked with public policy timing (described in Section 2) shows that the timetable that de facto considers only formal timing (the first time perspective) and that resulting from the cycle of general elections (the second time perspective), leads to neglecting the possibilities offered by the third time perspective (i.e., preparing a better policy that is based on business information connected with the time factor, if such is deliberately gathered and used, and not resulting in the waste of public funds, etc., as indicated in Section 2). Only a timetable based on combining all three time perspectives will be appropriate, and not one, as is the common case in the Polish approach, that is almost entirely dominated by two perspectives that are typically used alone.

The final conclusion is that the time dimension of Polish public health policy creation has been ignored or treated as an exogenous event in relation to the rest of the policy formulation process. There is no political approach that adaptively links the right combination of resources and regulatory activity to timing for specific stages of development or growth in public hospital care. The result is a continuous lack of a long-term (or even short-term) solution to public health problems in Poland.

**Author Contributions:** D.K.: original draft preparation; conceptualization; investigation and review; validation and editing. M.W.: investigation; formal analysis; validation and editing. All authors have read and agreed to the published version of the manuscript.

**Funding:** The project is financed by the Ministry of Science and Higher Education in Poland under the program “Regional Initiative of Excellence” 2019–2022, project number 015/RID/2018/19 total funding amount 10,721,040.00 PLN.

**Conflicts of Interest:** The authors declare no conflict of interest.

## References

1. Argy, S.; Johnson, M. *Mechanism for Improving Quality of Regulations: Australia in An International Context*; Australian Government Productivity Commission: Canberra City, Australia, 2003.
2. Lach, D.E. *Zasada Równego Dostępu do Świadczeń Opieki Zdrowotnej*; Wolters Kluwer: Warszawa, Poland, 2011; p. 47.
3. Act of Medical Activities. *Journal of Laws* 2011, No. 112, item 654. 15 April 2011; (Ustawa z dnia 15 kwietnia 2011 r. o działalności leczniczej. Dz.U. 2011, nr 112, poz. 654).
4. Koehler, G. Time, complex systems, and public policy: A theoretical foundation for adaptive policy making. *Nonlinear Dyn. Psychol. Life Sci.* **2003**, *7*, 99–114. [[CrossRef](#)] [[PubMed](#)]
5. Mittenzwei, K.; Bullock, D.S.; Salhofer, K. Towards a theory of policy timing. *Aust. J. Agric. Resour. Econ.* **2012**, *56*, 583–596. [[CrossRef](#)]
6. Kwon, H.T.; Nelson, D.E. Communicating Research to help influence Policy and Practice. In *Prevention, Policy, and Public Health*; Moreland-Russell, S., Brownson, R.C., Eds.; Oxford University Press: Oxford, UK, 2016; p. 309.
7. Lindahl, H. Discretion and Public Policy: Timing the Unity and Divergence of Legal Orders. In *The Coherence of EU Law: The Search for Unity in Divergent Concepts*; Prehal, S., Roermund, B., Eds.; Oxford University Press: Oxford, UK, 2008.
8. Pindyck, R.S. Optimal timing problems in environmental economics. *J. Econ. Dyn. Control* **2002**, *26*, 1677–1697. [[CrossRef](#)]
9. Martin, R. Law, and Public Health Policy. In *International Encyclopedia of Public Health*; Qah, S., Ed.; Elsevier: Amsterdam, The Netherlands, 2008.
10. Shiffman, J. Agenda Setting in Public Health Policy. In *International Encyclopedia of Public Health*; Qah, S., Ed.; Elsevier: Amsterdam, The Netherlands, 2017.
11. Sisnowski, J.; Street, J.M. Evidence-Informed Public Health Policy. In *International Encyclopedia of Public Health*; Qah, S., Ed.; Elsevier: Amsterdam, The Netherlands, 2017.
12. The Act of Universal Health Insurance. *Journal of Laws* 2003, No.45, item 391. 23 January 2003; (Ustawa z dnia 23 stycznia 2003 r. O powszechnym ubezpieczeniu w Narodowym Funduszu Zdrowia. Dz. U. 2003, nr 45, poz. 391).
13. Rb-Z reports–Regulation of the Minister of Finance of Reports of Public Finance Sector Entities in the Field of Financial Operations. *Journal of Laws* of 2014, item 1773. 4 March 2010; (Sprawozdania Rb-Z. Rozporządzenie Ministra Finansów z dnia 4 marca 2010 r. w sprawie sprawozdań jednostek sektora finansów publicznych w zakresie operacji finansowych, Dz. U. 2014, poz. 1773).
14. Kosycarz, E. Wpływ kondycji finansowej podmiotów leczniczych na stabilność finansową jednostek samorządu terytorialnego. *Ekon. Probl. Ust.* **2015**, *118*, 197–210. [[CrossRef](#)]
15. Korenik, D.; Węgrzyn, M. *Benchmarking szpitali. Przykład Narzędzia Benchmarkingowego, Portrety Szpitali—Mapy Możliwości Czyli Monitorowanie Jakości Usług Publicznych i Benchmarking z Zakresu Nadzoru nad Funkcjonowaniem Szpitali, dla Których Organem Założycielskim jest Jednostka Samorządu Terytorialnego*; PRYMAT: Wrocław, Poland, 2015.
16. Miszczyńska, K. Ocena Efektywności Funkcjonowania Jednostek Zamkniętej Opieki Zdrowotnej na Przykładzie Wybranych Szpitali w Łodzi. Ph.D. Thesis, Uniwersytet Łódzki, Łódź, Poland, 2017.
17. Act of Amending the Act on Health Care Services Financed from Public funds. *Journal of Laws* 2017, item 844. 23 March 2017; Date of announcement April 26, 2017. (Ustawa z dnia 23 marca 2017 r. o zmianie ustawy o świadczeniach opieki zdrowotnej finansowanych ze środków publicznych. Dz.U. 2017, poz. 844. Published 2017, 26 April).
18. Regulation of the Minister of Health of the Method of Determining the Lump Sum of the Basic Hospital System for Securing Healthcare Services. *Journal of Laws* 2017, item 1783. 22 September 2017; (Rozporządzenie Ministra Zdrowia z dnia 22 września 2017 r. w sprawie sposobu ustalania ryczałtu systemu podstawowego szpitalnego zabezpieczenia świadczeń opieki zdrowotnej, Dz.U 2017, poz. 1783).





Article

# Resource Integration, Reconfiguration, and Sustainable Competitive Advantages: The Differences between Traditional and Emerging Industries

Hongjia Ma <sup>1</sup>, Qing Sun <sup>1</sup>, Yang Gao <sup>2,\*</sup> and Yuan Gao <sup>3,4,\*</sup>

<sup>1</sup> School of Management, Jilin University, Changchun 130022, China; mahongjia@jlu.edu.cn (H.M.); sunqing0709@jlu.edu.cn (Q.S.)

<sup>2</sup> School of Business, Dalian University of Technology, Panjin 124221, China

<sup>3</sup> China Academy of Corporate Governance, Nankai University, Tianjin 300071, China

<sup>4</sup> Business School, Nankai University, Tianjin 300071, China

\* Correspondence: gzm@dlut.edu.cn (Y.G.); loessplateaus@gmail.com (Y.G.)

Received: 25 December 2018; Accepted: 18 January 2019; Published: 21 January 2019

**Abstract:** Emerging industries bear great difference from traditional industries. It is valuable to explore the effectiveness of different resource management methods in the two industries. Based on this, the purposes of this paper are first to define and distinguish two core resource management methods (i.e., resource integration and resource reconfiguration), and second to research the different impact paths of resource integration and resource reconfiguration on the sustainable competitive advantages in different industries. Primarily, in order to achieve these purposes, this paper explores the generation path of resource integration and resource reconfiguration from the perspective of organizational learning; secondly, the empirical analysis method is applied to examine the different influences between resource integration and resource reconfiguration on sustainable competitive advantages. Based on 208 samples in traditional industries and 220 samples in emerging industries, the results show that resource integration and resource reconfiguration are the consequence of organizational learning. In traditional industries, resource integration and resource reconfiguration have a positive impact on sustainable competitive advantages, respectively, resulting in a “concerto effect” on sustainable competitive advantages. While, in emerging industries, though resource integration has a positive impact on sustainable competitive advantages, however, there is an inverted U-shaped relationship between resource reconfiguration and sustainable competitive advantages. In such a situation, the “concerto effect” disappeared. This paper not only reveals the uniqueness of different resource management methods in different industries but also enriches the applications of resource management theories in different situations.

**Keywords:** traditional industries; emerging industries; resource integration; resource reconfiguration; sustainable competitive advantages; concerto effect

---

## 1. Introduction

Industries can be categorized as emerging or traditional. Emerging industries include seven industries, including new generation of information technology, bio-medicine, energy saving and environmental protection, high-end equipment manufacturing, new energy, new materials, and new energy vehicles [1]. Traditional industries mainly refer to those labour-intensive, manufacturing, and processing industries (i.e., textile industry, shoe-making industry, petrochemical industry, paper products industry) [2,3]. Emerging industries are the key to determining a country’s core competency, at the same time, they are also the core fields of national strategy implementation (i.e.,

U.S. industrial Internet, German Industry 4.0, Made in China 2025). Because of the characteristics of short technology upgrading cycle, unclear market structure and uncertain customer demand, enterprises in emerging industries have more challenges in resource input and integration, which is also fundamentally different from traditional industries with relatively stable technology and markets [4]. In addition, enterprises in emerging industries are facing more resource barriers, including the shortage of information resources, knowledge resources, technical resources, and human resources [5]. Therefore, industry turbulence and resource constraints have brought challenges to the traditional classical resource management theory—resource-based view (RBV).

As a classical resource management theory, RBV pays more attention to how to obtain sustainable competitive advantage (SCA) through effective resource management [6] in order to achieve the sustainability in economy, environment, and society [7]. However, due to the differences of external environment, enterprise strategy is dynamic and extroverted, just as the emergence of Porter's industry strategy to cope with dynamic competition [8]. Therefore, enterprises' resource management strategies have also begun to emphasize the importance of integrating resources from external environments [9]. So far, resource integration has become an important concern of RBV theory, and is also regarded as a critical skill for the sustainable development of enterprises.

However, resource integration will lead to the reconfiguration of resource structure which is complex and abstract; little existing research can explain the process and mechanism of reconfiguration clearly. Organizational theory also pays attention to change, and emphasizes shaping new resource structures to gain sustainable competitive advantages (SCAs), such as the transformation of dominant operation processes which lead to new international standards or the cultivation of implicit cultural atmospheres which lead to new behaviors by employees [10]. In the process of organizational change, organizational learning always affects the efficiency of resource integration and the effectiveness of new resource structure [11], so it is crucial to explore the relationship between organizational learning, resource integration, and resource reconfiguration. Therefore, the first purpose of this paper is to reveal the difference between resource integration and resource reconfiguration from the perspective of organizational learning; secondly, because traditional industries and emerging industries have different characteristics, it needs to reveal the differences between resource integration and resource reconfiguration under different industries and explore the "concerto effect" (interaction produces positive effect). Based on this, the second purpose of this paper is to distinguish and explore the different impact paths of resource integration and resource reconfiguration on the SCAs under different industries.

Based on 208 samples in traditional industries and 220 samples in emerging industries, the results show that resource integration and resource reconfiguration are both the consequence of organizational learning. In addition, the research yields that resource integration has a positive effect on SCAs in both emerging and traditional industries. However, though resource reconfiguration has a positive effect on SCAs and also has a "concerto effect" with resource integration on SCAs in traditional industries, there is an inverted U-shaped relationship between resource reconfiguration and SCAs in emerging industries. Thus, the "concerto effect" has disappeared in emerging industries. The theoretical significances of this paper are as follows: Firstly, the paper defines two core resource management methods (resource integration and resource reconfiguration) which have been measured from the perspective of organizational learning. Secondly, this paper compares the different impacts of resource integration and resource reconfiguration on SCAs between traditional industries and emerging industries. Finally, this study validates the "concerto effect" between resource integration and resource reconfiguration. The practical significance of this paper is to guide enterprises to rationally choose different resource management methods in different industries and provide practical guidance and suggestions.

## **2. Literature Review and Hypotheses**

### *2.1. RBV and SCA*

The resource-based view (RBV) originated from strategic management, which was proposed by Wernerfelt [12], and was enriched and perfected by Barney [13]. The RBV reached its peak in 1994, from which time on it has become the most classic and mature theory in the field of resource management. As a theory to explore the source of SCAs, the main feature of RBV is adopting internal resources and resource efficiency to explain the source of competitive advantage. Entirely different from structural analysis [14] and pair-level analysis [15], the perspective of RBV focuses on the inside of enterprises. The introduction of RBV theory also indicates that strategic management theory has a theoretical shift from the outside to the inside. The RBV theory accentuates that the source of competitive advantage is chiefly characterized by four key elements of resources, namely value, rarity, inimitability, and non-substitutability (VRIN). In addition, the RBV theory also provides a unique view on the efficiency of resource utilisation [16]. It emphasises the identification and acquisition of VRIN attributes resources, as well as the allocation and utilisation of resources, which is also the process of resource integration.

Competitive advantages, including short-term competitive advantages and sustainable competitive advantages, usually leads to high profits, but these profits always attract competitors, consequently limiting the duration of competitive advantage. However, if competitors cannot imitate the source of advantage, then the competitive advantage of the company is sustainable [17]. Such SCAs can bring long-term profits and avoid being overtaken by competitors through strategic replication or imitation [18]. As a long-term dynamic process, SCAs originated from the theory of competitive advantage, and is unique to enterprises. The SCA is the advantage, developing in an enterprise against and beyond its competitors continuously [19,20]. Resources are an important driving force for enterprises to gain competitive advantage and performance [21,22], and the process of selecting enterprise resources has an important impact on heterogeneity and SCAs [23]. Enterprises need to establish SCAs and obtain excess profits by effectively integrating resources and developing resources that meet the need for future development.

### *2.2. Organizational Learning, Resource Integration, and Resource Reconfiguration*

#### *2.2.1. Organizational Learning*

Learning can be expressed as changes in beliefs, cognition or behaviour [24]. Organizational learning is a process in which an enterprise acquires new knowledge and insights from the common experience of people in the organization, and has the potential to influence behaviour and improve enterprise capacity [25]. In the development of organizational learning theory, March pioneered the theoretical model of “exploratory learning and exploitative learning”, revealing the internal mechanism and process of organizational learning [26]. Exploratory learning and exploitative learning are the basic learning mechanisms for organizations and other adaptive systems [27]. Exploratory learning refers to the learning of product and process development skills, which are new to the company's current experience [28]. Keys to exploratory learning are search, variability, adventure, experimentation, flexibility, discovery, and innovation [29].

Conversely, exploitative learning refers to learning from knowledge and skills that are familiar with the enterprise's current experience. It emphasises organizational members seeking change and tends to focus on gathering knowledge from stakeholders and cultivating new capabilities to keep the competitive position [30]. Its characteristics are perfection, selection, production, efficiency, selection, implementation, and execution. Based on existing knowledge, absorption and accumulation of new knowledge in a targeted manner are emphasized so as to reorganise the knowledge system and perfect the existing resource structure. Exploratory learning and exploitative learning need to promote each other and cannot be ignored by either side. In addition, from the perspective of the correspondent

relationship between knowledge type and organizational learning, if the knowledge acquired by enterprises is unfamiliar, future, and foreign, that is exploratory learning. Instead, if it is already known, existing, and local knowledge, that is exploitative learning [31].

### 2.2.2. Resource Integration

Resource integration is an important bridge connecting the internal and external enterprise [32]. When resources are discovered and effectively utilised by the enterprise, the value of them will appear [33]. According to RBV, resource integration is the process of effectively identifying, acquiring, and allocating external resources. Enterprises need to keep searching and digging to identify external valuable resources and to gain further competitive advantage. Identifying means companies need to find valuable resources ahead of their competitors; surveillance stresses the need for companies to keep an eye on competitors or market conditions to learn about new industrial trends; learning requires companies to quickly understand and imitate the advanced business methods and models of competitors; and forecasting asks for a longer-term strategic vision. The company equipped with the ability to learn is more likely to perceive events and trends in the market, and the learning organizations are generally more flexible than their competitors [25]. Resource acquisition is the follow-up of resource identification and the process of obtaining resources through various relationship channels and operation methods. It stresses timeliness and the importance of accessing resources quickly and effectively.

Organizational learning is of great significance to access to resources, especially for new enterprises that often lack sufficient resources to underpin their growth [29]. Some enterprises employ various methods in order to get the resources they need. For scarce human resources, the main way is to give high reward and motivation; for some special intellectual property rights, enterprises are more likely to introduce or cooperate through capital purchase, capital transfer, and strategic alliance; certainly, enterprises can absorb and reuse through learning, such as knowledge resources. Due to the heterogeneity of resources and the great differences between different resources, it is necessary to understand the mutual matching of resources through organizational learning to make up for shortcomings, so as to maximise the efficiency of resource utilisation. At the same time, managers can also make full use of scarce resources through organizational learning, and pay attention to the realisation of scarce resources, and maximise the effectiveness of scarce resources. In addition, organizational learning is the process of acquiring new knowledge and capabilities, which strengthens organizational actions. Efficient knowledge sharing and transfer provide organizational members with opportunities of learning and collaboration [34,35].

Accordingly, this paper proposes the following hypothesis:

**Hypothesis 1.** *Organizational learning has a positive effect on resource integration.*

**Hypothesis 1a.** *Exploratory learning has a positive effect on resource integration.*

**Hypothesis 1b.** *Exploitative learning has a positive effect on resource integration.*

### 2.2.3. Resource Reconfiguration

Undertaking resource integration, resource reconfiguration is the process of rebuilding the original resource structure when the enterprise integrates resources. According to RBV, obtaining differentiated resources helps enterprises gain competitive advantage, and ongoing resource reconfiguration can help enterprises overcome their weaknesses and maintain competitive advantage [36,37]. The reconfiguration of the resource structure is also the process of re-updating the inherent rules, which corresponds to the update of organizational routines. Regarding the organizational routines, it can be comprehended at both the behavioural and cognitive levels. On the one hand, routines refer

to a series of behaviour patterns that are repeatedly followed at the behavioural level. On the other hand, routines are the rules of cognition and cognitive model at the cognitive level. Based on this perspective, Feldman and Pentland [38] pointed out that organizational routine is a stable source of organizations to respond to changes in the external environment and divided organizational routine into two aspects: representational interpretation and behavioural expression [38]. Hence, the routine is a combination of the participants' subjective cognitive rules and behavioural implementation rules, which represents the results of organizational learning.

In fact, as a strategy, organizational learning is a new organizational method and procedure that can promote learning and changes [34]. In a dynamic environment, it is particularly crucial for resource management of new enterprises [39]. Efficient organizational learning can ensure enterprises acquire new information and knowledge in understanding and improving the process and mechanism of organizational routines [40]. It supports the creation, configuration, deployment, and update of resource bases within the organization to adapt to environmental changes [41]. The process of organizational learning is built by experience accumulation, knowledge connection and coding, and absorption processes, which can enhance the effectiveness of organizational routines [42,43]. In this process, objective elements such as panels, signs, and slogans from the organization, as the existence of explicit knowledge, play a pivotal role in the formation of the cognitive schema for the organization individual. It can be seen that no matter what kind of learning method an organization takes; it will have a corresponding impact on organizational routines. The logic of resource reconfiguration from the perspective of organizational routines is shown in Figure 1.

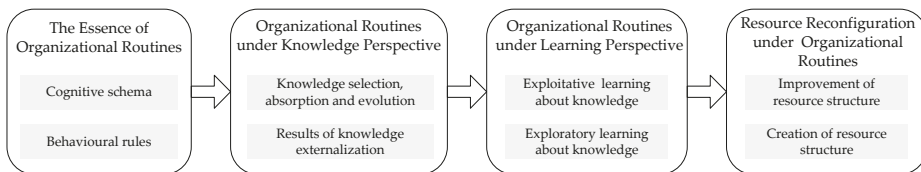

**Figure 1.** The research logic of resource reconfiguration.

Based on this information, this paper proposes the following hypothesis:

**Hypothesis 2.** *Organizational learning has a positive effect on resource reconfiguration.*

**Hypothesis 2a.** *Exploratory learning has a positive effect on resource reconfiguration.*

**Hypothesis 2b.** *Exploitative learning has a positive effect on resource reconfiguration.*

### 2.3. Resource Integration and Reconfiguration under Different Industries

Strategic management theory stresses more on how the enterprise's strategic choice is interdependent with the external environment, and the enterprise needs to make constant changes to cope with the risks of the external environment [44]. Some scholars also classify environmental risks into technical risks and competitive risks, both designated as market risks. Enterprises need to choose strategic implementation plans by overcoming risks at both levels. The technical risk is manifested from the high frequency of technical updates, high technical cost, and uncontrollable benefits. By estimating technological risks, enterprises can choose different resource management methods, either by actively developing or introducing technology. Whereas, the competition risk is presented by the diversification of market competition, unreasonable market competition structure and profit-seeking behaviour of stakeholders. Especially for the immature market, the rules and norms are not perfect so that competitors can influence the interests of the enterprise through plagiarism and malicious competition. The strategic choice in attack or defence, first move or later move will

determine the management mode of enterprise resources, and it is also an important guarantee for the enterprise to resist risks [45].

### 2.3.1. Traditional Industry

Traditional industry is moderate-dynamic, in which situation the market is still changing, but relatively perceptible and predictable [2]. Managers can formulate specific strategic implementation guidelines through insight into the competitive structure of the market; they can also choose the direction of resource allocation by predicting market demand boundaries, consumer spending habits, and future-leading technologies. Based on this, along with the predicted and perceived route, enterprises can identify the competitive structure and boundaries of the market, and explore the key resources and capabilities that affect the market competition. Moreover, they can carry out effective resource integration activities, including mastering key industry technology, grasping mainstream consumer habits and trends, and building strategic alliances with the companies with unique technologies. This kind of resource integration on each node of the supply chain has a positive impact on enterprise operation performance [46,47]. Besides, managers can also carry out activities of resource structural reorganization and renewal orderly, and update through their tacit knowledge and business rules, so as to develop new effective workflow and linear work steps. Especially in the link of structural reform and reorganization, the conclusion of the profound and perfect market analysis is trustworthy for enterprises.

In traditional industries, some information is easily perceived by enterprises due to the huge-scale, long-life and relatively mature technology [3]. For example, in the petrochemical industry which develops slowly, new workflow and steps are the result of continuous data collection, development of alternative solutions, and continuous attempts and improvements [48]. At this time, precisely subdivided, workflow and steps enhance the organization's understanding of the original resource structure and further advance the efficiency of the new resource structure. However, in the dyestuff industry, the development of the industry is still slow, and the strategic decision is long-term and sustainable. The decision-making process is linear, including the type, specification of the dye, transformation and redesign of the dyeing process, and so on. This process can be repeated and overlapped, as well as repeated adjustments made [49]. Therefore, in traditional industries, enterprises can integrate resources by relying on the perception of the market. At this point, the structural resource reconfiguration and the update of routines is a linear process, which can be repeated and adjusted. Overall, resource integration and resource reconfiguration can help enterprises gain SCAs in the market due to the slow development and clear boundaries.

Accordingly, this paper proposes the following hypothesis:

**Hypothesis 3.** *In the traditional industry, resource integration has a positive effect on SCAs.*

**Hypothesis 4.** *In the traditional industry, resource reconfiguration has a positive effect on SCAs.*

**Hypothesis 5.** *In the traditional industry, there is a “concerto effect” between resource integration and resource reconfiguration on SCAs.*

### 2.3.2. Emerging Industry

Emerging industry belonging to the high-velocity industry with vague market structure and boundary faces uncertainty competition [50]. For example, the means of competition has become more complex, the competition standards are not unified, and even the system and laws are one-sided and ineffective. In emerging markets, on account of the emergence of new technologies and the continual death of traditional technologies, the entire industry is facing a subversion and the market is highly risky and uncertain [51]. Consequently, enterprises would find it difficult to identify and predict

critical technologies, and they would also take a risk in innovation. In such a rapidly developing and unpredictable market environment, it is not enough for the enterprises to have specific resources to maintain a competitive advantage [52], and it is necessary to use resource integration to make full use of resources [53]. Enterprises should pay more attention to the integration of tacit resources, and the value of knowledge resources is particularly important. In the integration process of knowledge resources, learning, adapting, absorbing, and sharing will promote enterprises to keep up with industrial development, and also assist enterprises to reserve a deeper resource base to cope with the risk of future industries.

For example, in the field of artificial intelligence, mature technologies and business models are still under exploration. Besides, many bottlenecks have not been tackled, such as relying on massive data, higher artificial intelligence energy consumption, non-generalised training mode, semantic gaps, and reliability, etc. In emerging industries, there is a high risk of uncertainty, and investors and customers adopt a wait-and-see attitude. Besides, laws and regulations are immature, and the industry seems to be dynamic, but there are not many reliable opportunities [54]. Based on this, under the circumstance of fragmented market information and intermittent markets, the conclusions obtained by enterprises through analysis are often discrete, and the successful cases are also low probability events. Enterprises should learn continuously, absorb new knowledge to store knowledge bases and refine special knowledge to meet future challenges. Therefore, resource integration still plays a vital role on the SCAs. Nevertheless, enterprises cannot change the original resource structure easily, because the new resource structure may become ineffective rapidly due to an immature conclusion. It is more sensible to focus on choices rather than making adjustments, and it is easier to succeed by choosing old, simple, and reliable resource structures [55].

Accordingly, this paper proposes the following hypothesis.

**Hypothesis 6.** *In the emerging industry, resource integration has a positive effect on SCAs.*

**Hypothesis 7.** *In the emerging industry, resource reconfiguration has a negative effect on SCAs.*

**Hypothesis 8.** *In the emerging industry, there is no “concerto effect” between resource integration and resource reconfiguration on SCAs.*

Figure 2 presents the overall research framework.

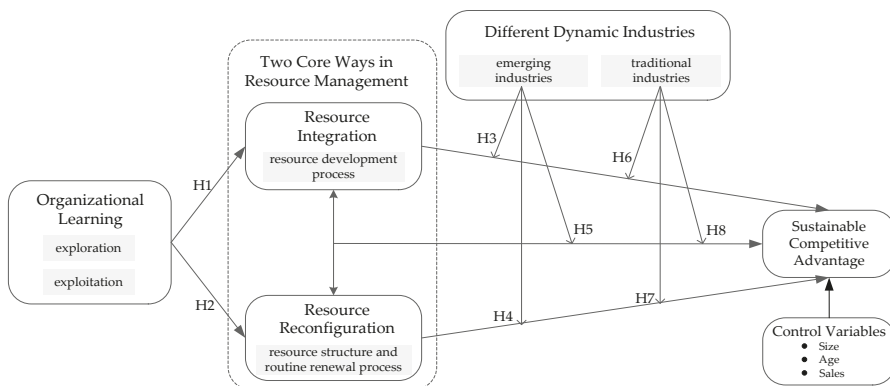

Figure 2. The research model.

### **3. Methodology**

#### *3.1. Selection of Sample*

A structural questionnaire was employed to measure variables and test hypotheses in the model. First, through the database of listed enterprises (Wind and Tai'an, which include enterprise information, financial data and investment consulting data, are the leading economic and financial research databases in China) and industrial enterprises, the basic information on enterprises in emerging industries and traditional industries was gathered. Based on the registration category of the industry, the classification criteria of emerging industries and traditional industries (the existing main business is consistent with the registration category which was determined by the enterprise at the early stage of the life cycle) was determined [56]. The samples of emerging industries were selected from seven strategic emerging industries (see Table 1), and the samples of traditional industries were selected from six specific traditional industries (see Table 1). Each sample has typical industry characteristics while avoiding the selection of enterprises with cross-industry characteristics.

Second, according to the mailing addresses which were drawn from the database, the questionnaires were addressed to the senior managers (i.e., CEOs, general managers, board directors) who are from 600 Chinese firms (300 firms in emerging industries and 300 firms in traditional industries), because they have more information about the firms and play a critical role in organizational resource management [57]. A cover letter was included to explain the purpose of our research in order to provide the managers with a better understanding of the connotation of our questionnaires. The managers were also promised that the detailed information they provided about their companies would remain confidential and that the questionnaire would only be used for scientific research. The cover letter included a network link from which the managers could fill out the questionnaires online.

#### *3.2. Procedure of Analysis*

From October 2016 to February 2018, 16 months were spent collecting the data and 514 completed questionnaires (263 questionnaires in emerging industries and 251 questionnaires in traditional industries) were returned. After checking the questionnaires, some were unqualified due to the missing information and the short filling time less than 5 minutes (43 questionnaires in traditional industries and 43 questionnaires in emerging industries), and thus were eliminated. At last, 428 valid questionnaires were achieved (220 questionnaires in emerging industries and 208 questionnaires in traditional industries). The recovery rate was 73.3% (73.3% in emerging industries and 69.3% in traditional industries). Non-response bias was used to test the differences between early and late responses [58]. Furthermore, a *t*-test was performed and no significant differences between the two subgroups in different industries were detected. Table 1 shows the characteristics of the research samples.



Table 1. Characteristics of the research samples.

	Size (Number of Employee)	Year (Year of Establishment)	Sales (Average Sales per Month, RMB)	Specific Industry (Registered Industrial Category of Firm)
Traditional Industries	1–10 people	1 year or less	1 million or less	Smelting industry
	11–50 people	1–3 years	1–3 million	Textile industry
	51–100 people	3–5 years	3–5 million	Petrochemical industry
	101–300 people	5–8 years	5–10 million	Furniture manufacturing industry
	>300 people	>8 years	>10 million	Paper products industry Shoe-making industry
Emerging Industries	1–10 people	1 year or less	1 million or less	Newgeneration of information technology
	11–50 people	1–3 years	1–3 million	Bio-medicine
	51–100 people	3–5 years	3–5 million	Energy saving and environmental protection
	101–300 people	5–8 years	5–10 million	High-end equipment manufacturing
	>300 people	>8 years	>10 million	New materials
				New energy
				New energy vehicle

### 3.3. Scale Development and Measures

The study used standard statistical methods in the literature to test the reliability and validity of the scale and measure our hypotheses [59]. Each scale of the variables was based on previous scales or definitions from the literature. The selection and estimation of measurement parameters accord with international standards [60] and can fully underpin the empirical results.

According to the Atuahene-Gima and Murray's research [61], six items were used to measure the variable of organizational learning, including three items about exploratory learning: (1) seek market information to address high risk; (2) seek potential market demand to develop new projects; (3) seek access to new areas of product), and three items about exploitative learning: (4) seek information to disentangle current product issues; (5) seek competitor information to improve product strategy; and (6) accumulate the new knowledge. The results of reliability and validity analysis of organizational learning are shown in Table 2.

The measurement of resource integration in academia is based on the scale of Wiklund and Shepherd [62], and includes six items: (1) accumulating unique resources for future use; (2) using new resources to pursue new strategic initiatives; (3) developing new resources for use in new operations; (4) acquiring new resources for future expansion; (5) using existing resources for future expansion; (6) using new resources to create radically new product. The results of reliability and validity analysis of resource integration are shown in Table 3.

The measurement of resource reconfiguration can be based on the research of organizational routines from two aspects: the improvement of resource structure and the creation of resource structure [63,64]. Improvement of resource structure includes three items: (1) adjust organization standard process to get more efficiency; (2) use new knowledge to improve process specification; (3) evaluate the standardization of organizational process regularly. Creation of resource structure includes three items: (4) encourage employee to trial and error; (5) create new process to cope with the external changes; (6) provide new training and guidance for employees. The results of reliability and validity analysis of resource reconfiguration are shown in Table 4.

The independent variable is SCA which is measured by Wu's [53] research with five items: (1) maintain a high market reaction speed for a long time; (2) maintain a high-quality product for a long time; (3) maintain a high production efficiency for a long time; (4) maintain a high innovation frequency for a long time; (5) maintain a high customer satisfaction for a long time. In order to avoid being influenced by external factors on the model, three control variables were chosen (size, age, and sales) [65]. The results of the reliability and validity analysis of SCAs are shown in Table 5.

Table 2. Results of the reliability and validity test of organizational learning.

Variables	Items	Factor Loading Coefficient			Cumulative Variance Explained Rate			Kaiser-Meyer-Olkin KMO			Cronbach's $\alpha$ Coefficient			Deleted Cronbach's $\alpha$ Coefficient			Convergent Validity		
		Traditional Industries	Emerging Industries	Traditional Industries	Traditional Industries	Emerging Industries	Traditional Industries	Emerging Industries	Traditional Industries	Emerging Industries	Traditional Industries	Emerging Industries	Traditional Industries	Emerging Industries	Traditional Industries	Emerging Industries	Traditional Industries	Emerging Industries	
Exploratory Learning	Item (1)	0.803	0.816		67.46%	66.02%		0.694	0.688		0.759	0.743		0.691	0.636		0.861	0.854	
	Item (2)	0.852	0.799					$p = 0.000$	$p = 0.000$					0.654	0.660				
	Item (3)	0.808	0.823											0.686	0.678				
Exploitative Learning	Item (4)	0.843	0.828		72.05%	70.12%		0.710	0.681		0.806	0.787		0.756	0.729		0.885	0.876	
	Item (5)	0.857	0.884					$p = 0.000$	$p = 0.000$					0.707	0.634				
	Item (6)	0.846	0.798											0.741	0.761				

Table 3. Results of the reliability and validity test of resource integration.

Variables	Items	Factor Loading Coefficient			Cumulative Variance Explained Rate			KMO			Cronbach's $\alpha$ Coefficient			Deleted Cronbach's $\alpha$ Coefficient			Composite Reliability		
		Traditional Industries	Emerging Industries	Traditional Industries	Traditional Industries	Emerging Industries	Traditional Industries	Emerging Industries	Traditional Industries	Emerging Industries	Traditional Industries	Emerging Industries	Traditional Industries	Emerging Industries	Traditional Industries	Emerging Industries	Traditional Industries	Emerging Industries	
Resource Integration	Item (1)	0.907	0.665		78.89%	56.89%		0.897	0.836		0.945	0.848		0.931	0.841		0.957	0.887	
	Item (2)	0.903	0.719											0.932	0.827				
	Item (3)	0.904	0.799											0.931	0.812				
	Item (4)	0.884	0.797					$p = 0.000$	$p = 0.000$					0.934	0.819				
	Item (5)	0.867	0.768											0.94	0.819				
	Item (6)	0.863	0.781											0.941	0.816				

Table 4. Results of the reliability and validity test of resource reconfiguration.

Variables	Items	Factor Loading Coefficient			Cumulative Variance Explained Rate			KMO			Cronbach's $\alpha$ Coefficient			Deleted Cronbach's $\alpha$ Coefficient			Composite Reliability		
		Traditional Industries	Emerging Industries	Traditional Industries	Traditional Industries	Emerging Industries	Traditional Industries	Emerging Industries	Traditional Industries	Emerging Industries	Traditional Industries	Emerging Industries	Traditional Industries	Emerging Industries	Traditional Industries	Emerging Industries	Traditional Industries	Emerging Industries	
Improvement of Resource Structure Creation	Item (1)	0.839	0.835		72.50%	66.39%		0.702	0.67		0.823	0.757		0.767	0.666		0.894	0.861	
	Item (2)	0.844	0.845											0.754	0.625				
	Item (3)	0.894	0.78					$p = 0.000$	$p = 0.000$					0.747	0.731				
	Item (4)	0.769	0.829											0.766	0.611				
	Item (5)	0.863	0.797											0.743	0.62				
	Item (6)	0.887	0.797											0.647	0.712				

Table 5. Results of the reliability and validity test of SCAs.

Variables	Items	Factor Loading Coefficient		Cumulative Variance Explained Rate		KMO		Cronbach's $\alpha$ Coefficient		Deleted Cronbach's $\alpha$ Coefficient		Composite Reliability	
		Traditional Industries	Emerging Industries	Traditional Industries	Emerging Industries	Traditional Industries	Emerging Industries	Traditional Industries	Emerging Industries	Traditional Industries	Emerging Industries	Traditional Industries	Emerging Industries
SCA	Item (1)	0.81	0.93							0.874	0.938		
	Item (2)	0.858	0.934							0.86	0.937		
	Item (3)	0.837	0.916	70.27%	84.09%	0.783	0.884	0.893	0.952	0.872	0.941	0.922	0.964
	Item (4)	0.843	0.909			$p = 0.000$	$p = 0.000$			0.871	0.948		
	Item (5)	0.843	0.896							0.874	0.943		

## 4. Finding of the Research

### 4.1. Results of General Descriptive Analysis

Before testing the hypothesis, the bivariate correlations of variables need to be tested. Table 6 presents the results in traditional industries. The correlation coefficient matrix shows the correlation between variables, and the correlation coefficient is less than 0.7 of the critical value.

**Table 6.** Results of descriptive statistics and correlation coefficients in traditional industries.

Variate	1	2	3	4	5	6	7	8
1. Size	1							
2. Year	0.147 *	1						
3. Sales	−0.017	0.097	1					
4. Exploratory Learning	−0.012	−0.025	−0.009	1				
5. Exploitative Learning	0.148 *	−0.07	0.061	0.234 **	1			
6. Resource Integration	0.085	0.211 **	0.012	0.283 **	0.206 **	1		
7. Resource Reconfiguration	0.049	−0.061	−0.054	0.274 **	0.229 **	0.131	1	
8. SCA	0.083	0.028	−0.137 *	0.062	−0.002	0.196 **	0.213 **	1
Mean value	3.060	3.060	3.080	3.788	3.694	3.989	3.583	3.807
Standard deviation	1.394	1.397	1.431	0.908	0.976	0.886	0.626	0.774

Note: \* Correlation is significant at the 0.05 level (two-tailed). \*\* Correlation is significant at the 0.01 level (two-tailed).

Table 7 presents the results in emerging industries. Taking the reliability of empirical research results and the correlation between variables into consideration, mean-centred was used to deal with all variables in order to reduce research errors.

**Table 7.** Results of descriptive statistics and correlation coefficients in emerging industries.

Variate	1	2	3	4	5	6	7	8
1. Size	1							
2. Year	0.034	1						
3. Sales	0.088	0.249 **	1					
4. Exploratory Learning	−0.114	−0.08	−0.018	1				
5. Exploitative Learning	−0.124	−0.104	0.077	0.546 **	1			
6. Resource Integration	0.004	−0.051	0.141 *	0.273 **	0.310 **	1		
7. Resource Reconfiguration	−0.099	−0.115	−0.132	0.291 **	0.283 **	−0.259 **	1	
8. SCA	0.092	0.087	0.172 *	−0.114	−0.138 *	0.341 **	−0.637 **	1
Mean value	2.950	2.980	3.060	3.383	3.794	3.256	3.663	3.262
Standard deviation	1.431	1.462	1.370	0.691	0.888	0.697	0.559	1.222

Note: \* Correlation is significant at the 0.05 level (two-tailed). \*\* Correlation is significant at the 0.01 level (two-tailed).

### 4.2. Results of Multivariate Linear Regression Analysis

To test the hypotheses, a moderated hierarchical regression analysis was conducted [66]. In this process, the interaction or regulation effect requires adjusting variables to avoid multiple co linearity problems. The multiple collinear ties of the variance expansion factor were also tested.

Since the data were divided into two groups, the research first analyzed it in traditional industries. The results are shown in Table 8. The independent variables in model 1 contained only control variables, and the dependent variable was resource integration. Model 2 adds the variables of exploratory learning and exploitative learning. The results of the empirical analysis show that exploratory learning and exploitative learning both had a significant positive correlation with resource integration ( $r = 0.252$ ,

$p < 0.001$ ;  $r = 0.159$ ,  $p < 0.05$ ), indicating that hypothesis 1 is supported in traditional industries. In the same way, the results in model 3 and model 4 shows that exploratory learning and exploitative learning both had a significant positive correlation with resource reconfiguration, indicating that hypothesis 2 is supported in traditional industries. The dependent variable in model 5 is SCA, and resource integration and resource reconfiguration were added in model 6. The results show that resource integration and resource reconfiguration both had a significant positive correlation with SCA ( $r = 0.168$ ,  $p < 0.05$ ;  $r = 0.181$ ,  $p < 0.01$ ), indicating that hypothesis 3 and hypothesis 4 are both supported. Model 7 adds an interaction item of resource integration and resource reconfiguration on the basis of model 6. The results show that there was a significant positive correlation between the interaction and SCA ( $r = 0.216$ ,  $p < 0.01$ ), indicating that hypothesis 5 is supported.

**Table 8.** Results of logistics regression analysis in traditional industries.

	Dependent Variable: SCA						
	Resource Integration		Resource Reconfiguration		SCA		
	Model 1	Model 2	Model 3	Model 4	Model 5	Model 6	Model 7
Constant	−0.490	−0.467	0.074	0.093	0.050	0.105	0.020
Control Variables							
Size	0.055	0.031	0.057	0.031	0.076	0.056	0.057
Year	0.204 **	0.226 **	−0.065	−0.042	0.03	0.008	0.02
Sales	−0.007	−0.016	−0.047	−0.058	−0.138 *	−0.129	−0.102
Main Research Variable							
Exploratory Learning		0.252 ***		0.233 **			
Exploitative Learning		0.159 *		0.171 *			
Resource Integration						0.168 *	0.185 **
Resource Reconfiguration						0.181 **	0.221 **
Resource Integration × Resource Reconfiguration							0.216 **
Adjusted R2	0.034	0.133	−0.005	0.088	0.012	0.072	0.112
△R2	0.048	0.106	0.009	0.101	0.026	0.068	0.044
F change	3.403 *	12.705 ***	0.640	11.439 ***	1.819	7.580 **	10.165 **

Note: \* Correlation is significant at the 0.05 level (two-tailed). \*\* Correlation is significant at the 0.01 level (two-tailed). \*\*\* Correlation is significant at the 0.001 level.

Then, the research tested the hypotheses in the emerging industries. The results are shown in Table 9. In model 9, the results of the empirical analysis show that exploratory learning and exploitative learning both had a significant positive correlation with resource integration ( $r = 0.160$ ,  $p < 0.05$ ;  $r = 0.211$ ,  $p < 0.01$ ), indicating that hypothesis 1 is supported in emerging industries. Combined with the results of traditional industries, hypothesis 1 is supported. In model 11, the results of the empirical analysis show that exploratory learning and exploitative learning both had a significant positive correlation with resource reconfiguration ( $r = 0.179$ ,  $p < 0.05$ ;  $r = 0.185$ ,  $p < 0.05$ ), suggesting that hypothesis 2 is supported in emerging industries. Combined with the results of traditional industries, hypothesis 2 is supported. In model 13, resource integration had a significant positive correlation with SCA ( $r = 0.182$ ,  $p < 0.01$ ), indicating that hypothesis 6 is supported. However, in model 14, the interaction item of resource integration and resource reconfiguration was added, and the research also adds the interaction item of resource reconfiguration and resource reconfiguration. The results show that there was no significant correlation between the interaction item of resource integration and resource reconfiguration and SCA ( $r = 0.07$ ,  $p > 0.05$ ), demonstrating that hypothesis 8 is supported. Other results show that the square of resource reconfiguration and SCA were negatively

correlated ( $r = 0.119, p < 0.05$ ), indicating that hypothesis 7 is not supported completely, and there is an inverted U relation between resource reconfiguration and SCA.

**Table 9.** Results of logistics regression analysis in emerging industries.

	Dependent Variable: SCA						
	Resource Integration		Resource Reconfiguration			SCA	
	Model 8	Model 9	Model 10	Model 11	Model 12	Model 13	Model 14
Constant	−0.115	−0.195	0.327	0.263	−0.727	−0.278	−0.143
Control Variables							
Size	−0.008	0.038	−0.087	−0.043	0.077	0.028	0.027
Year	−0.092	−0.052	−0.086	−0.048	0.046	0.013	−0.003
Sales	0.165 *	0.138 *	−0.103	−0.127	0.153 *	0.064	0.078
Main Research Variable							
Exploratory Learning		0.160 *		0.179 *			
Exploitative Learning		0.211**		0.185 *			
Resource Integration						0.182 **	0.171 **
Resource Reconfiguration						−0.577 ***	0.596 ***
Resource Integration × Resource Reconfiguration							0.070
Resource Reconfiguration × Resource Reconfiguration							−0.119 *
Adjusted R2	0.015	0.111	0.019	0.111	0.024	0.432	0.448
ΔR2	0.028	0.103	0.032	0.099	0.037	0.407	0.021
F change	2.079	12.732 ***	2.385	12.195 ***	2.795 *	78.473 ***	4.261 *

Note: \* Correlation is significant at the 0.05 level (two-tailed). \*\* Correlation is significant at the 0.01 level (two-tailed). \*\*\* Correlation is significant at the 0.001 level.

A summary of the results for all hypotheses is shown in Table 10.

**Table 10.** Summary of the results for all hypotheses.

Hypotheses	Results
Hypothesis 1. Organizational learning has a positive effect on resource integration.	supported
Hypothesis 1a. Exploratory learning has a positive effect on resource integration	supported
Hypothesis 1b. Exploitative learning has a positive effect on resource integration.	supported
Hypothesis 2. Organizational learning has a positive effect on resource reconfiguration.	supported
Hypothesis 2a. Exploratory learning has a positive effect on resource reconfiguration.	supported
Hypothesis 2b. Exploitative learning has a positive effect on resource reconfiguration.	supported
Hypothesis 3. In the traditional industry, resource integration has a positive effect on SCAs.	supported
Hypothesis 4. In the traditional industry, resource reconfiguration has a positive effect on SCAs.	supported
Hypothesis 5. In the traditional industry, there is a “concerto effect” between resource integration and resource reconfiguration on SCAs.	supported
Hypothesis 6. In the emerging industry, resource integration has a positive effect on SCAs.	supported
Hypothesis 7. In the emerging industry, resource reconfiguration has a negative effect on SCAs.	partial supported
Hypothesis 8. In the emerging industry, there is no “concerto effect” between resource integration and resource reconfiguration on SCAs.	supported

## 5. Discussion

Since the literature began to focus on resource management theory, it is critical to explain the complex interaction mechanism between different resource management methods. Based on existing research, this study reveals the differences between resource integration and resource reconfiguration and explores the interaction of them on SCAs under different industries (empirical results are shown in Figure 3). In this context, our study contributes to both theory and practice.

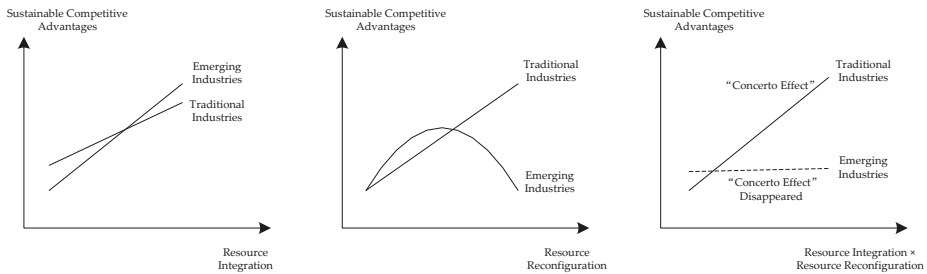

Figure 3. Results of the empirical analysis.

### 5.1. Theoretical Contributions

This study makes three central contributions to the literature. First, we find that resource integration and resource reconfiguration (two core ways in resource management) are both the results of organizational learning. The conclusion emphasizes the process of understanding organizational learning before engaging in resource management activities. As far as resource integration is concerned, exploratory learning can help enterprises timely recognise and obtain the necessary information, technical, and human resources in the market, and provide an effective approach for companies to master the method of utilising new resources, while the company identifies scarce and essential resources with the aid of exploitative learning, thereby looking for and obtaining these resources pertinently. Besides, exploitative learning enables the company to perfect resource allocation and improves resource utilization. As the premise of resource reconfiguration, exploratory learning will be meaningful for organizations only by exploring opportunities or threats. Otherwise changing the original resource structure will impair the overall efficiency. Meanwhile, exploitative learning can help the companies avoid the vulnerability and timeliness of new resource structures by making constant attempts and error feedback to amend and improve innovation and reform.

Second, our research offers a better understanding of the influences of resource integration and resource reconfiguration on SCAs in traditional industries. In traditional industries, the result of organizational learning is assured and convincing. Thus, strategic decision based on organizational learning is the outcome of the high probability decision. Moreover, the organization can not only find the accurate direction on the resource integration, but also get well-directed resource allocation. Therefore, it is essential for an organization to keep continually learning and undergoing purposeful resource integration to obtain enduring competitive advantages. At the same time, due to the high reliability of strategic decision-making, upgrading and recombination can be made in the original resource structure. In such a situation, there is no vulnerability in the new resource structure caused by uncertain risk. Resource reconfiguration can promote enterprise to cultivate more dynamic and adaptive organizational routines. In a word, resource integration and resource reconfiguration can be well coordinated in such conditions.

The third contribution reveals the differences between resource integration and resource reconfiguration in emerging industries. In emerging industries, companies will encounter enormous risk in business investment and operating decisions, and organizational learning is of great significance. Meanwhile, resource integration brings about positive influence on sustainable competitive advantages. Hence, theory fracture of "organizing learning–resource integration–sustainable competitive advantages" can be drawn. However, there is an inverted U-shaped relationship between resource reconfiguration and SCAs, which produced some differences and distinctiveness. Resource reconfiguration is not suitable for long-term implementation in the organization due to the impact and limitation caused by the emerging industries. Appropriate amendment of the resource is acceptable by the organization but over adjustment will bring vulnerability to the new resource structure. Consequently, the negative side of resource structure and organizational routines leads to the invalidation of new resource structures. In emerging industries, if resource integration and resource



reconfiguration are launched at the same time, a positive effect would not be achieved on SCAs, the positive effect of resource integration will be neutralised.

## *5.2. Managerial Contributions*

Combined with the research result, practical meanings are produced as the following.

First of all, through the research on the derivation mechanisms of resource integration and resource reconfiguration, the findings reveal that organising study affects these two elements positively, which is essential for resource management. Managers need to manage resources from both sides, namely exploratory learning and exploitative learning, including exploring and digging precious resources actively and discovering the potential information and trends, especially through the processes of exploring, absorbing, transferring, and utilising knowledge. Furthermore, managers should focus on the evolution of the knowledge during organising, which impacts the formation and results of resource integration and resource reconfiguration directly.

Second, the research unveils the impact of resource integration and resource reconfiguration on SCAs in traditional industries, finding that there is the “concerto effect” between them. This conclusion encourages managers of the enterprises to implement resource integration and resource reconfiguration actively in traditional industries, including recognising and obtaining the resource, allocating and utilising the resource effectively, and attempting to upgrade the resource structure such as incremental upgrading and radical upgrading.

Finally, the result discloses that instead of over resource reconfiguration, resource integration plays a more important basic role in enterprises due to the high dynamics of the market in emerging industries such as artificial intelligence and the internet of things. In such a situation, the relationship between resource reconfiguration and SCAs is a non-linear inverted U-shaped relationship, and the “concerto effect” between resource integration and resource reconfiguration is neutralised. At this time, companies should continue to learn and accumulate new knowledge to form a resource library in case of need. However, the existing resource structure should not be changed rashly in that the upgrade at this time is built on an uncertain analysis. Therefore, wait and see prudently is what a wise man should do.

## **6. Conclusions**

Unlike previous resource management theory that pays more attention to the development of diversified resource management methods and how to improve the efficiency of resource allocation, this study emphasizes that there may be differences and conflicts among different resource management methods, and the interaction effect between different resource management methods is decisively affected by the external environment (such as the industry). Based on the theories of RBV, organizational learning and industry analysis, this paper systematically reveals the derivative sources and essential differences between the two resource management methods (resource integration and resource reconfiguration), and explores the impact of the two resource management methods on SCAs under different industries. The conclusion shows that both resource integration and resource reconfiguration are the results of organizational learning, but the two resource management methods have different impacts on SCAs in different industries. This paper expands the applied boundaries of RBV theory in different industries and provides a new understanding of the combination of organizational learning theory and resource management theory.

Our research has clarified the differences between the two approaches of resource management and provides the conclusion and improvement in applying these two management theories in different situations, but there remains some limitations. First, we selected resource integration and resource reconfiguration as the research variables, though the core position of these two resource management approaches has been acknowledged in existing literature, other management approaches of resource management should be the chief object of study in the future. Second, the data we chose were limited in a narrow range of China and cannot represent all countries in the world, though artificial

intelligence and internet of things have been developed prosperously in China and possesses many typical characteristics. A broader range of data should be collected to ratify the effectiveness of the experiment. At last, SCA is the dependable variable in this study which is a portrait and long-term competitive advantage, but its short-term advantage may also be demonstrated in different resource management approaches. Researching on the impact of different resource management approaches on long-term and short-term advantages can make up for the deficiencies of this study, and it is also an essential direction in the future research.

**Author Contributions:** H.M. and Q.S. proposed the conceptualization of this study and wrote the paper. Y.G. and Y.G. used the methodology and revised the paper.

**Funding:** This research was funded by the China Natural Science Foundation (71672072, 71602016), Science Foundation of Ministry of Education of China (16YJC630025), the China Postdoctoral Science Foundation (2018T110260, 2018T110227), the Liaoning S&T Project (20170520262), and the Liaoning Social Science Planning Fund Project (L17CJL005).

**Conflicts of Interest:** The authors declare no conflict of interest.

## References

1. Prud'homme, D. Dynamics of China's provincial-level specialization in strategic emerging industries. *Res. Policy* **2016**, *45*, 1586–1603. [[CrossRef](#)]
2. Huang, K.C.; Hu, T.S.; Wang, J.Y.; Chen, K.C.; Lo, H.M. From fashion product industries to fashion: Upgrading trends in traditional industry in Taiwan. *Eur. Plan. Stud.* **2016**, *24*, 762–787. [[CrossRef](#)]
3. Abadi, S.; Huda, M.; Hehsan, A.; Mohamad, A.M. Design of online transaction model on traditional industry in order to increase turnover and benefits. *Int. J. Eng. Technol.* **2018**, *7*, 231–237.
4. Forbes, D.P.; Kirsch, D.A. The study of emerging industries: Recognizing and responding to some central problems. *J. Bus. Ventur.* **2011**, *26*, 589–602. [[CrossRef](#)]
5. Guillen, M.F. Business groups in emerging economies: A resource-based view. *Acad. Manag. J.* **2000**, *43*, 362–380.
6. Hart, S.L. A natural-resource-based view of the firm. *Acad. Manag. Rev.* **1995**, *20*, 986–1014. [[CrossRef](#)]
7. Bergman, M.M.; Bergman, Z.; Berger, L. An empirical exploration, typology, and definition of corporate sustainability. *Sustainability* **2017**, *9*, 753. [[CrossRef](#)]
8. Porter, M.E. Industry structure and competitive strategy: Keys to profitability. *Financ. Anal. J.* **1980**, 30–41. [[CrossRef](#)]
9. Reuter, C.; Foerstl, K.A.I.; Hartmann, E.V.I.; Blome, C. Sustainable global supplier management: The role of dynamic capabilities in achieving competitive advantage. *J. Supply Chain Manag.* **2010**, *46*, 45–63. [[CrossRef](#)]
10. Fonseca, L.M. ISO 9001 quality management systems through the lens of organizational culture. *Calitatea* **2015**, *16*, 54–59.
11. Hitt, M.A.; Dacin, M.T.; Levitas, E. Partner selection in emerging and developed market contexts: Resource-based and organizational learning perspectives. *Acad. Manag. J.* **2000**, *43*, 449–467.
12. Wernerfelt, B. A resource-based view of the firm. *Strateg. Manag. J.* **1984**, *5*, 171–180. [[CrossRef](#)]
13. Barney, J. Firm resources and sustained competitive advantage. *J. Manag.* **1991**, *17*, 99–120. [[CrossRef](#)]
14. Dranove, D.; Peteraf, M.; Shanley, M. Do strategic groups exist? An economic framework for analysis. *Strateg. Manag. J.* **1998**, *19*, 1029–1044. [[CrossRef](#)]
15. Grimm, C.M.; Smith, K.G. *Strategy as Action: Industry Rivalry and Coordination*; South-Western College Pub.: Nashville, TN, USA, 1997.
16. Halawi, L.A.; Aronson, J.E.; McCarthy, R.V. Resource-based view of knowledge management for competitive advantage. *Electron. J. Knowl. Manag.* **2005**, *3*, 75.
17. Hesterly, B.; Barney, J. *Strategic Management and Competitive Advantage*; Pearson Prentice Hall: Upper Saddle River, NJ, USA, 2008.
18. Maury, B. Sustainable competitive advantage and profitability persistence: Sources versus outcomes for assessing advantage. *J. Bus. Res.* **2018**, *84*, 100–113. [[CrossRef](#)]
19. Hofer, C.W.; Schendel, D. *Strategy Formulation: Analytical Concepts*; West Publ.: Eagan, MN, USA, 1978.

20. Distanont, A.; Khongmalai, O. The role of innovation in creating a competitive advantage. *Kasetsart J. Soc. Sci.* **2018**, *7*, 9. [[CrossRef](#)]
21. Davcik, N.S.; Sharma, P. Marketing resources, performance, and competitive advantage: A review and future research directions. *J. Bus. Res.* **2016**, *69*, 5547–5552. [[CrossRef](#)]
22. Kozlenkova, I.V.; Samaha, S.A.; Palmatier, R.W. Resource-based theory in marketing. *J. Acad. Market. Sci.* **2014**, *42*, 1–21. [[CrossRef](#)]
23. Oliver, C. Sustainable competitive advantage: Combining institutional and resource-based views. *Strateg. Manag. J.* **1997**, *18*, 697–713. [[CrossRef](#)]
24. Argote, L. Organizational learning research: Past, present and future. *Manag. Learn.* **2011**, *42*, 439–446. [[CrossRef](#)]
25. Jiménez-Jiménez, D.; Sanz-Valle, R. Innovation, organizational learning, and performance. *J. Bus. Res.* **2011**, *64*, 408–417. [[CrossRef](#)]
26. March, J.G. Exploratory and exploitative in organizational learning. *Organ. Sci.* **1991**, *2*, 71–87. [[CrossRef](#)]
27. Yannopoulos, P.; Auh, S.; Menguc, B. Achieving fit between learning and market orientation: Implications for new product performance. *J. Prod. Innov. Manag.* **2012**, *29*, 531–545. [[CrossRef](#)]
28. Yang, J.; Liu, H.; Gao, S.; Li, Y. Technological innovation of firms in China: Past, present, and future. *Asia Pacific. J. Manag.* **2012**, *29*, 819–840.
29. Li, Y.; Chen, H.; Liu, Y.; Peng, M. Managerial ties, organizational learning, and opportunity capture: A social capital perspective. *Asia Pacific. J. Manag.* **2014**, *31*, 271–291. [[CrossRef](#)]
30. Fonseca, L.; Ramos, A.; Rosa, Á.; Braga, A.C.; Sampaio, P. Stakeholder satisfaction and sustainable success. In Proceedings of the International Conference on Business Sustainability, Póvoa de Varzim, Portugal, 22–24 June 2011; pp. 1–4.
31. Niebles, J.C.; Wang, H.; Li, F.-F. Unsupervised learning of human action categories using spatial-temporal words. *Int. J. Comput. Vis.* **2008**, *79*, 299–318. [[CrossRef](#)]
32. Vargo, S.L.; Akaka, M.A. Value cocreation and service systems (re) formation: A service ecosystems view. *Serv. Sci.* **2012**, *4*, 207–217. [[CrossRef](#)]
33. Lusch, R.F.; Vargo, S.L. *Service-Dominant Logic: Premises, Perspectives, Possibilities*; Cambridge University Press: Cambridge, UK, 2014.
34. Hung, R.Y.Y.; Lien, B.Y.H.; Yang, B.; Wu, C.; Kuo, Y. Impact of TQM and organizational learning on innovation performance in the high-tech industry. *Int. Bus. Rev.* **2011**, *20*, 213–225. [[CrossRef](#)]
35. Kim, N.; Atuahene-Gima, K. Using exploratory and exploitative market learning for new product development. *J. Prod. Innov. Manag.* **2010**, *27*, 519–536. [[CrossRef](#)]
36. Capron, L.; Mitchell, W. Selection capability: How capability gaps and internal social frictions affect internal and external strategic renewal. *Organ. Sci.* **2009**, *20*, 294–312. [[CrossRef](#)]
37. Vidal, E.; Mitchell, W. Adding by subtracting: The relationship between performance feedback and resource reconfiguration through divestitures. *Organ. Sci.* **2015**, *26*, 1101–1118. [[CrossRef](#)]
38. Pentland, B.T.; Feldman, M.S. Organizational routines as a unit of analysis. *Industrial and Corporate Change.* **2005**, *14*, 793–815. [[CrossRef](#)]
39. Short, J.C.; Ketchen, D.J., Jr.; Shook, C.L.; Ireland, D. The concept of “opportunity” in entrepreneurship research: Past accomplishments and future challenges. *J. Manag.* **2010**, *36*, 40–65. [[CrossRef](#)]
40. Lichtenthaler, U.; Ernst, H.; Hoegl, M. Not-sold-here: How attitudes influence external knowledge exploitative. *Organ. Sci.* **2010**, *21*, 1054–1071. [[CrossRef](#)]
41. Maes, J.; Sels, L. SMEs’ radical product innovation: The role of internally and externally oriented knowledge capabilities. *J. Small Bus. Manag.* **2014**, *52*, 141–163. [[CrossRef](#)]
42. Zollo, M.; Winter, S.G. Deliberate learning and the evolution of dynamic capabilities. *Organ. Sci.* **2002**, *13*, 339–351. [[CrossRef](#)]
43. Argote, L.; Miron-Spektor, E. Organizational learning: From experience to knowledge. *Organ. Sci.* **2011**, *22*, 1123–1137. [[CrossRef](#)]
44. May, R.C.; Stewart, W.H., Jr.; Sweo, R. Environmental scanning behavior in a transitional economy: Evidence from Russia. *Acad. Manag. J.* **2000**, *43*, 403–427.
45. Czarnitzki, D.; Toole, A.A. Patent protection, market uncertainty, and R&D investment. *Rev. Econ. Stat.* **2011**, *93*, 147–159.

46. Swink, M.; Narasimhan, R.; Wang, C. Managing beyond the factory walls: Effects of four types of strategic integration on manufacturing plant performance. *J. Oper. Manag.* **2007**, *25*, 148–164. [[CrossRef](#)]
47. Flynn, B.B.; Huo, B.; Zhao, X. The impact of supply chain integration on performance: A contingency and configuration approach. *J. Oper. Manag.* **2010**, *28*, 58–71. [[CrossRef](#)]
48. Pisano, G.P. Knowledge, integration, and the locus of learning: An empirical analysis of process development. *Strateg. Manag. J.* **1994**, *15*, 85–100. [[CrossRef](#)]
49. Fredrickson, J.W. The comprehensiveness of strategic decision processes: Extension, observations, future directions. *Acad. Manag. J.* **1984**, *27*, 445–467.
50. Ge, B.S.; Yang, Y.B.; Jiang, D.K.; Gao, Y.; Du, X.M.; Zhou, T.T. An Empirical Study on Green Innovation Strategy and Sustainable Competitive Advantages: Path and Boundary. *Sustainability* **2018**, *10*, 3631. [[CrossRef](#)]
51. Gao, Y.; Ge, B.S.; Lang, X.X.; Xu, X.B. Impacts of proactive orientation and entrepreneurial strategy on entrepreneurial performance: An empirical research. *Technol. Forecast. Soc. Chang.* **2018**, *135*, 178–187. [[CrossRef](#)]
52. Teece, D.J.; Pisano, G.; Shuen, A. Dynamic capabilities and strategic management. *Strateg. Manag. J.* **1997**, *18*, 509–533. [[CrossRef](#)]
53. Wu, L.Y. Applicability of the resource-based and dynamic-capability views under environmental volatility. *J. Bus. Res.* **2010**, *63*, 27–31. [[CrossRef](#)]
54. Wuebker, R.; Hampl, N.; Wuestenhagen, R. The strength of strong ties in an emerging industry: Experimental evidence of the effects of status hierarchies and personal ties in venture capitalist decision making. *Strateg. Entrepreneurship J.* **2015**, *9*, 167–187. [[CrossRef](#)]
55. Eisenhardt, K.M.; Martin, J.A. Dynamic capabilities: What are they? *Strateg. Manag. J.* **2000**, *21*, 1105–1121. [[CrossRef](#)]
56. Jabłoński, A.; Jabłoński, M. Research on business models in their life cycle. *Sustainability* **2016**, *8*, 430. [[CrossRef](#)]
57. Ambrosini, V.; Bowman, C. What are dynamic capabilities and are they useful constructs in strategic management? *Int. J. Manag. Rev.* **2009**, *11*, 29–49. [[CrossRef](#)]
58. Armstrong, J.; Overton, T.S. Estimating nonresponse bias in mail surveys. *J. Market.* **1997**, *14*, 396–402. [[CrossRef](#)]
59. Hair, J.F.; Anderson, R.E.; Tatham, R.L.; Black, W.C. *Multivariate Data Analysis*; Prentice Hall International: Upper Saddle River, NJ, USA, 1999.
60. Ge, B.S.; Jiang, D.K.; Gao, Y.; Tsai, S.B. The influence of legitimacy on a proactive green orientation and green performance: A study based on transitional economy scenarios in china. *Sustainability* **2016**, *8*, 1344. [[CrossRef](#)]
61. Atuahene-Gima, K.; Murray, J.Y. Exploratory and exploitative learning in new product development: A social capital perspective on new technology ventures in China. *J. Int. Market.* **2007**, *15*, 1–29. [[CrossRef](#)]
62. Wiklund, J.; Shepherd, D.A. The effectiveness of alliances and acquisitions: The role of resource combination activities. *Entrepreneurship Theory Pract.* **2009**, *33*, 193–212. [[CrossRef](#)]
63. Feldman, M.S.; Pentland, B.T. Reconceptualizing organizational routines as a source of flexibility and change. *Adm. Sci. Q.* **2003**, *48*, 94–118. [[CrossRef](#)]
64. Miller, K.D.; Pentland, B.T.; Choi, S. Dynamics of performing and remembering organizational routines. *J. Manag. Stud.* **2012**, *49*, 1536–1558. [[CrossRef](#)]
65. Barrales-Molina, V.; Montes, F.J.L.; Gutierrez-Gutierrez, L.J. Dynamic capabilities, human resources and operating routines: A new product development approach. *Ind. Manag. Data Syst.* **2015**, *115*, 1388–1411. [[CrossRef](#)]
66. Cohen, P.; West, S.G.; Aiken, L.S. *Applied Multiple Regression/Correlation Analysis for the Behavioral Sciences*; Psychology Press: New York, USA, 2014.



Article

# Modern Methods of Business Valuation—Case Study and New Concepts

Ireneusz Miciuła <sup>1,\*</sup>, Marta Kadłubek <sup>2</sup> and Paweł Stępień <sup>1</sup>

<sup>1</sup> Faculty of Economics, Finance and Management, Department of Sustainable Finance and Capital Markets, University of Szczecin, 70-453 Szczecin, Poland; pawel.stepien@usz.edu.pl

<sup>2</sup> Faculty of Management, Department of Logistics and International Management, Czestochowa University of Technology, 42-200 Czestochowa, Poland; marta.kadlubek@wz.pcz.pl

\* Correspondence: ireneusz.miciula@usz.edu.pl

Received: 1 February 2020; Accepted: 24 March 2020; Published: 30 March 2020

**Abstract:** In the modern world, the terms enterprise value and valuation are of great importance. Knowledge about how much an enterprise is worth is of fundamental importance for both the owner of that company and investors when negotiating the price of an enterprise at the time of conducting a commercial transaction. The article presents the goals of the company's valuation and characteristic stages of the company's life at which such valuation is necessary. The article classifies the methods of enterprise valuation used today. On this basis, the valuation methodology is presented according to the MDI-R concept (Assets, Income, Intellectual Capital-Market), which in a broad spectrum measures the effectiveness of the company's operations and, in accordance with the current features of good valuation, aims to determine the fair value of the company. The purpose of the article is to demonstrate the need to improve the code of conduct and valuation standards. As part of the implementation of the objective, multi-faceted and complex valuation issues are presented, as well as factors that may distort the determination of fair value. The methodology of the study is based on inferences about the methodology of business valuation, and verification is based on practical examples, by which a hypothesis on the existence of critical elements of valuation is verified that allows the use of broad subjectivity in estimating the value of assets. At the same time, the factors that determine the possibility of the existence of too wide a subjectivity in estimating assets, which is in contradiction with the features of good valuation, are presented. The attempt is made to draw attention to the threats arising from modern business valuation methodologies and their challenges in the future. Additionally, this article offers the authors' proposed hybrid method MDI-R, which draws from existing solutions to improve their functionality and applicability.

**Keywords:** corporate finance; creating value; valuation of the company; management; financial market

## 1. Introduction

The term “enterprise” or “company” can be understood as a separate economic entity, an economic entity producing and selling on its own account goods and services with the goal to maximize profits. Modern enterprise financial management is about maximizing its value. An enterprise is a special form of investment. The owners, by investing in their own capital resources, expect to obtain certain benefits resulting from the multiplication of capital invested in this way, which leads directly to the increase in the value of the enterprise they own. Recognizing at the same time that the economic essence of ownership issues is closely related to issues of utility and the problem of the monetary value of the object of ownership, the issues relating to enterprise value, its specifics, various conditions, as well as methods and training procedures, are invariably important.

Business valuation is a complex process that requires the application of the vast knowledge of many fields of science, and there are many scientific and practical problems associated with this [1].

Despite the fact that a group of specialists has already done much in terms of efforts to standardize the valuation process, there are still many unsolved problems or controversial solutions adopted. Methods of the valuation of enterprises and their organized parts have not been regulated legally as strictly binding [2]. Also, there is no closed and complementary set of rules applicable to this process. The lack of uniform regulations is primarily due to the fact that it is not possible to fully codify a process that may relate to entities with different specificities, legal forms, assets or ownership structures. However, there are standards that allow for its partial structuring. Therefore, in many countries of the world, for many years, there have been standards for business valuation [3]. They relate to the methodology of valuation and the range of expertise that the valuator must have. They were developed by professional organizations that contain specialists in dealing with valuations. Experts are bound by codified procedures and standards of conduct, which guarantee the comparability of valuations and ease of their verification. Such a situation contributes to the security of business transactions.

The need for business valuation results from economic development. Along with the globalization of the economy, which is accompanied by an intense flow of capital to a growing number of countries, valuation becomes necessary to the sale, privatization, mergers and acquisitions or creation of joint ventures and many other processes relating to enterprises [4]. Determination of the final value of the entity is difficult due to the subjectivity of the concept of “value” itself. The problem is also the fact that business valuation is the combination of both theory and practice. It also depends on the capabilities of the business model used by the specific economic entity. It should be remembered, though, that the actual market value of the enterprise is very rarely exclusively determined by the assets taken into account in the balance sheet. The actual valuation is determined by a number of variable factors, such as the economic situation of the country, attractiveness of the market, the company’s development strategy, human resources, the nature and manner of the use of assets owned [5]. Therefore, it can be stated that business valuation is the process of estimation of the price for assets and benefits achieved by the company as a result of their effective management. It is carried out in the moment, since the market is like a living organism and new information affecting the condition and operations of enterprises occurs over and over again.

Therefore, because of the complicated, constantly changing processes of business valuation, it is important to establish certain norms and legal standards. The International Valuation Standards Council developed a document including international norms in this field [6]. It contains the guidelines recommended in the process of assessment of the company’s value, as well as appraisal reports and recommendations concerning their application. Obviously, these rules are not strictly binding, however, they constitute a set of good practices and guidelines specifying certain generally accepted principles, both ethical and methodological. This aims at the elimination of significant disparities in relation to the results of the valuation made, e.g., with respect to the assets of the same type. These rules may be also applicable in the case of court disputes concerning the outcome of the valuation, as well as doubts about the valuation for tax purposes. In the countries where a certain framework and standards for estimating the value of assets have been determined, there is separate certification of experts in the field of valuation.

The objective of the article is to demonstrate the need to improve the code of conduct and valuation standards. Within the framework of the accomplishment of the objective, the multidimensionality as well as the complex issues of valuation are presented along with the factors that could distort the establishment of fair value.

## **2. Methodology**

The research methodology was based on a review of scientific literature and conclusions drawn from business valuation methodology. As part of this methodology a detailed analysis was performed of the subsequent stages of business valuation methods used in business practice. Also in the article practical examples were verified. On their basis, the hypothesis about the existence of key valuation elements was verified, which allows the use of broad subjectivity when estimating the value of

assets. The research methodology used demonstrated the need to improve the code of conduct and valuation standards. Additionally, as part of the critical analysis, factors that may distort the determination of fair value were presented. Therefore, the original concept of MDI-R was presented to improve practical valuation methods. At the same time, the necessity of further development of valuation methods and the search for objective methods of fair value measurement for the conducted business was shown, which require further detailed research based on the analysis of numerical data on practical examples.

### **3. Literature Review**

Business valuation is a set of procedures, analyses and assessments leading to the estimation of the company's value in monetary units for the specific moment [7]. Contemporary realities of the market economy and the globalization process have determined that business valuation is of fundamental importance for economic processes. Contemporary management of corporate finance consists in maximizing its value. Business valuation is the process of estimating the price of assets (fixed and current assets, as well as different intangible assets and characteristics) and benefits achieved due to their effective management [8]. Generally, the objective of business valuation is always to facilitate strategic decision-making in terms of organization, shares or investments. Valuation enables the selection of both ownership and financial options in assets and liabilities. It is actually the opinion of the value prepared by specialized experts, analysts and valuers on the basis of the collected and properly utilized information about the company considered and the environment of its operations [9]. At the same time, it can be acknowledged that the company's value is the market measure of the effectiveness and efficiency of actions taken by the enterprise. Despite such a crucial function performed by business valuation in the economy, its specificity and essence pose many problems. These are related to a variety of conditions and numerous procedures and methods serving business valuation. Another component resulting in problems in the valuation of fair value is the growing importance of intellectual capital. This is due to global technological and organizational transformations, which have led to the knowledge-based economy. Intellectual capital, among others, consists of legal assets, technology and relationships with customers. At the same time, among the issues of intellectual capital, there are many ambiguous and various solutions for both theory and practice. Due to difficulties in the valuation of intangible and legal assets, which primarily determine the contemporary value of enterprises, in particular highly developed ones, in terms of technology, one deals with difficulties in achieving the so-called fair business valuation [10]. The methodology of the valuation of intangible and legal assets is subject to constant changes in search of a universal method. Therefore, at present, in the subject literature, the conclusion is that, in order to make the best possible valuation, it is necessary to value individual components affecting the value of the company with separate methods that best reflect the nature of their value.

The existence of many subjective factors affecting the valuation may lead to abuse, pressure and the desire to influence the experts' decisions, which result in the distortion of fair value. Therefore, in order to streamline business valuation, there is the need to develop a synthetic and universal, yet consistent, methodology for the valuation of basic parameters. This also requires the implementation of appropriate regulations or standards concerning the generally accepted methods of business valuation since, depending on the subjective choice of the method by the appraiser, significant differences in the final valuation may be observed, resulting in low values of the company [11]. Therefore, the objective should be to develop standards that will determine acceptable methods (patterns) for specific industries or cases. All practitioners carrying out business valuations must accept certain fundamental principles. The appropriate model for the estimation of the value of the economic entity should not only inform about the total value but also indicate the structure of the sources of its creation. Therefore, business valuation methods should take into account as many components of the company affecting its value as possible. Nowadays, the valuation process is already moving in this direction, the example of which is a simultaneous use of, most frequently, asset-based, income-based and comparable company methods

to determine the final value of the company. The use of several valuation methods in the course of the applied procedure provides an opportunity to make rational decisions as to the final value of the enterprise [12]. In this paper, the problem areas are analyzed and indicated, which can be useful when building Polish business valuation standards. Undoubtedly, standardization will lead to a reduction in a certain degree of subjectivity, present in valuations. Moreover, valuations made on the basis of the same requirements will become comparable and more easily verifiable in terms of their correctness.

Contemporary realities of the market economy along with the globalization process have caused business valuation to become of fundamental importance for economic processes [13]. Additionally, growing information needs have led to the development of numerous methods of valuation. The enterprise (company) is an economic entity producing and selling goods or services for its own account and at its own risk, an objective of which is to maximize profits. Contemporary management of corporate finance consists in maximizing its value. This is due to the fact that the enterprise, as a separate economic and legal entity, is a particular form of investment. Owners, investing their own capital resources in its economic activities, expect to obtain certain benefits, mainly to multiply the capital invested in this way, which directly leads to an increase in the value of the enterprise they own. At the same time, when recognizing that the economic essence of the issue of ownership is closely linked to the issues of usability and the problem of the monetary value of an object of property, the issue relating to the category of the company's value appears to be invariably important. Business valuation is the process of estimating the price of assets (fixed and current assets, as well as different intangible assets and characteristics) and benefits achieved due to their effective management [14].

The need for business valuation results from economic development. Along with the globalization of the economy, which is accompanied by an intense flow of capital to a growing number of countries, valuation becomes necessary to the sale, privatization, mergers and acquisitions or creation of joint ventures and many other processes relating to enterprises. It is also important for value management of subsidiaries located in the developing countries. Generally, the objective of business valuation is always to facilitate strategic decision-making in terms of organization, shares or investments. Valuation enables the selection of both ownership and financial options in assets and liabilities. It is actually the opinion concerning the value, prepared by specialized experts, analysts and valuers on the basis of the collected and properly utilized information about the company and the environment of its operations [15]. At the same time, it can be acknowledged that the company's value is the market measure of the effectiveness and efficiency of actions taken by the enterprise.

The process that aims to determine the value of the company is valuation. The term "enterprise valuation" means that the subject of the valuation is the economically and legally isolated organizational unit, with specific potential in the form of fixed and current assets, as well as different intangible assets and characteristics. Valuation can be treated as the opinion, judgment, estimation of the preciousness of something. According to Miles, valuation is an opinion concerning the value, usually made in writing and, at the same time, it is the process of estimating the value of the cost of the asset, a group of assets or all the assets belonging to the business or the specific investment [7]. However, despite such a crucial function performed by business valuation in the economy, its specificity and essence pose many problems as measures of effective operations, among others. This is related to a variety of conditions and numerous procedures and methods serving business valuation. At the same time, the reasons for the contemporary crisis of confidence in the methodology of business valuation are presented and the directions of future development are indicated, which is of fundamental importance for the operations and opportunities of the conducted business. The essence of the valuation of the company is to give its value as expressed in the specific monetary units using set prices, rules and analyses.

The research methodology is based on reasoning on the basis of the methodology of asset-based methods of business valuation and the analysis of practical examples in order to verify the hypothesis about the existence of critical components of valuation that enable wide subjectivity in estimating the value of assets.



*The Process of Business Valuation—The Essence and Classification of Methods*

In the contemporary world, the value of the company and its valuation are of crucial importance. The value of the enterprise

- is an invariably important issue of the economic essence of ownership, which is closely linked to issues of usability and the problem of the monetary value of an object of property,
- is the market measure of the effectiveness and efficiency of actions taken by the enterprise.

The process of the valuation of the company, its specificity and essence pose many problems and controversies. This is connected with the essence of monetary valuation, which is a subjective measure. Then, there are various conditions and numerous procedures and methods for business valuation. The knowledge of the company's value is of great importance for making strategic decisions concerning characteristic stages of the company's operation [16]. The essence of the business valuation of the company is to give its value expressed in the specific monetary units using set prices, rules and analyses. Table 1 contains the objectives of business valuation under different conditions, which indicate fundamental importance for the conducted business.

**Table 1.** The objectives of business valuation.

Internal	External	Internal-External
<ul style="list-style-type: none"> <li>- Ability to control the capital invested by the owner to multiply value</li> <li>- Measurement of the value of shares for the purposes of their presentation</li> <li>- Acceptance of new shareholders or exclusion of some of the existing ones</li> <li>- Change in the legal form of the business</li> <li>- Management contracts, remuneration systems based on value creation</li> <li>- Identification of value determinants</li> <li>- Strategic planning</li> <li>- Division of the company</li> </ul>	<ul style="list-style-type: none"> <li>- Dimension of taxes</li> <li>- Determination of the amount of stamp duty, notarial fees, etc.</li> <li>- Determination of the amount of insurance premiums</li> <li>- Public offers</li> <li>- Determination of the amount of compensation arising from insurance</li> </ul>	<ul style="list-style-type: none"> <li>- Purchase or sale of the company</li> <li>- Ownership transformations</li> <li>- Privatization and re-privatization</li> <li>- Transfer of the company under the rent, franchise or lease</li> <li>- Merger of enterprises</li> <li>- Valuation of listed companies for the comparison with the stock market valuation</li> <li>- Sale of newly issued shares</li> <li>- Loan and credit collateral</li> </ul>

Source: Own study based on: [7,17].

Accurate preparation of the business valuation helps in achieving better trading terms since, in the course of negotiations, it allows for relying on facts and not intuition, feelings and emotions [18]. At the same time, it enables avoiding the situation where the owner's idea significantly exceeds the actual value of the company or, on the contrary, where this idea definitely does not estimate the company's value. Therefore, the situation in which the transaction under objective conditions might fail is avoided. There are five functions of valuation resulting from the reasons for carrying it out [19]:

- Advisory (decision-making) function

The essence of the advisory function (also known as decision-making) is to provide the necessary information on the value of the company in relation to the intended execution of certain transactions.

- Argumentative (justifying) function

The implementation of this function consists in the skillful use of information obtained in the course of valuation. This is about the selection of information that will strengthen the bargaining power of the party to the transaction.

- Mediation function

The mediation function, also known as negotiating, refers to situations where the opinions of parties to the transaction as to the value are significantly divergent.

- Security function

Its essence is to provide information on the value of the company for the purposes of protection against the adverse effects of disputes arising in connection with the value.

- Information function

Its essence is to provide information obtained in the process of valuation for the purposes of enterprise management. The recipients of this information are investors, banks, trading partners, customers, financial analysts, authorities at different levels, etc.

After conducting the preliminary analysis of the subject and purpose of the business valuation, it is necessary to choose the method that is the most adequate to the situation of the enterprise and the specificity of its industry. Contemporary realities of the market economy and the globalization process have determined that business valuation is of fundamental importance for economic processes [5]. Additionally, growing information needs have led to the development of numerous methods of valuation. The determinants of the selection of the business valuation method include [20]:

- Valuation objective;
- Who orders (recipient);
- Type of the company due to usability;
- Economic condition of the company and the condition of the environment (economy, industry, region);
- Type, scale and diversity of business;
- Type and number of assets;
- Operation and development prospects of the company;
- Type and quality of information about the company and the market that it is possible to obtain;
- Approaches and types of value in business valuation.

A wide range of practitioners carry out business valuation on a daily basis. Therefore, valuation should be perceived as a practical activity and defined as a way of value (monetary) measurement of the enterprise, i.e., its resources and economic effects of decisions taken.

Fair value is the amount for which an asset can be exchanged if the transaction takes place under market conditions between interested parties who are not related to each other and possess the information that allows for full assessment of the value of the subject of the transaction. At the same time, business valuation is a complex process that is able to illustrate the actual and fair value of the company only if it is carried out in accordance with the so-called characteristics of good (reliable) valuation, which include [21]:

- Compliance of the valuation with the facts;
- Timeliness of data, transparency and relative simplicity;
- Clearly defined purpose of its preparation;
- Being based on the financial data of the company;
- Not being made exclusively on the basis of the value of the company's assets unless it concerns the so-called liquidation method;
- Taking into account income and intangible factors;
- Taking into account the company's development forecasts and risk factors;
- Taking into account all relevant information which affects the valuation and is available in the process of its preparation;
- Being objective and reliable.

On the other hand, the selection of the valuation method itself constitutes the most important part of the process of estimating the actual fair value of the company and must be adjusted to the subject of the valuation. Despite the fact that a wide range of practitioners carry out business valuation on a daily basis, this process still requires improvement. Table 2 presents the methods of business valuation the most frequently applied in practice.

**Table 2.** The classification of business valuation methods.

Business Valuation Methods				
Asset-Based	Income-Based	Mixed	Comparable Company	Unconventional
- Book value method	- Discounted dividend method	- Average cost method	- Multiples method	- Option theory-based methods
- Adjusted net assets method	- Discounted cash flow method	- Swiss method	- Method of comparable transactions	- Time lag methods
- Replacement method	- Discounted future earnings method	- Berlin method		- Others
- Liquidation method		- Excess earnings method		
		- Stuttgart method		
		- UEC <sup>1</sup> method		

<sup>1</sup> The name of the method comes from the commission called by Union Europeene des Experts Comptables Economiques et Financiers. Source: Own study based on: [22].

Another component resulting in problems in the valuation of fair value is the growing importance of intellectual capital. This is due to global technological and organizational transformations that led to the knowledge-based economy [23]. Intellectual capital, among others, consists of legal assets, technology and relationships with customers, etc. At the same time, among the issues of intellectual capital, there are many ambiguous and various solutions for both theory and practice. Figure 1 illustrates the changes in the significance of assets of enterprises for their valuation.

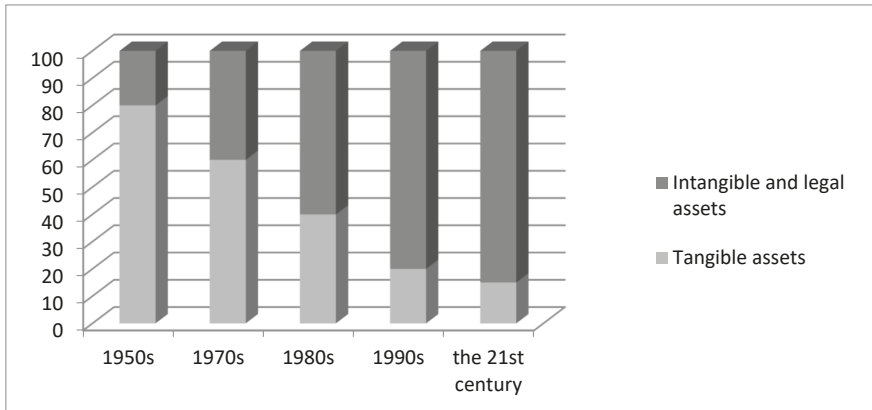

**Figure 1.** The significance of the values of tangible and intangible assets over the years. Source: Own study based on the data: [24].

Therefore, due to difficulties in the valuation of intangible and legal assets, which primarily determine the contemporary value of enterprises, in particular, highly developed ones, in terms of technology, one deals with difficulties in achieving the so-called fair business valuation. The methodology of the valuation of intangible and legal assets is subject to constant changes in search of a universal method. Therefore, along with the aforementioned components, these are the main reasons for the contemporary crisis of confidence in the methodology of business valuation. Therefore, at present, in the subject literature, the conclusion is that in order to make the best possible valuation it is necessary to value individual components affecting the value of the company with separate methods, which best reflect the nature of their value.

**4. Results**

An extremely important factor in the business valuation process is the appropriate selection of methods. This choice is determined not only by the objective of valuation and the situation of the valuated entity but also by the nature of the business and the specificity of areas of its business activity. The economic situation of enterprises, i.e., their market position, status of assets, ability to generate income, are some of the determinants having an impact on the selection of the valuation

method. Additionally, in the course of analyses of information concerning the valuated entity and also within the framework of the application of the same method, one deals with the so-called critical points of valuation, i.e., components subjected to the subjective selection. The proper determination of the financial condition of the company can also be a source of differences, depending on the person carrying out the valuation and availability of information [25]. Additionally, it should be noted that each industry is characterized by a certain specificity, which has a large impact on many components that determine the valuation process. The existence of many subjective factors affecting the valuation may lead to abuse, pressure and the desire to influence the experts' decisions, which results in the distortion of fair value. Therefore, the following should be mentioned as risks and problems to solve in the future:

- Freedom of selection of input data,
- Use of wide subjectivity in the common valuation procedure,
- Subjectivity of selection of valuation methods and internal parameters,
- Lack of coherence in estimation of parameters,
- Lack of legal regulations and standards of valuation.

Therefore, in order to streamline business valuation, there is a need to develop a synthetic and universal yet consistent methodology for the valuation of basic parameters. This also requires the implementation of appropriate regulations or standards concerning the generally accepted methods of business valuation since, depending on the subjective choice of the method by the appraiser, significant differences in the final valuation may be observed with low values of the company [26]. The related works appeared due to the association of a group of specialists and practitioners. One of the tangible results of efforts to eliminate a number of risks is the announced *New Interpretative Note No 5—General Principles of Business Valuation* [27]. Despite a large number of ways of carrying out valuations and with the high quality of analytical work at the valuation, it should be remembered that a business is worth as much as someone is willing to pay for it. On the other hand, good and factual valuation is essential for preparing oneself for substantive discussions with the buyer. Within the framework of this paper, the essence, objectives and functions of business valuation were determined and the overall classification of valuation methods applied in the practice of economic life was made.

#### 4.1. The Examples of Business Valuation Using the Adjusted Net Assets Method—Case Study

##### 4.1.1. The Practice Example No. 1—Valuations Using the Adjusted Net Assets Method

Under ideal conditions, business valuation would consist in estimating the value of each asset individually and then subtracting all liabilities. The net asset value is then received, i.e., the value less liabilities, adjusted for the book value. For example, such a procedure occurs when valuating enterprises under court cases for division of assets or repayment of some of shares, which is illustrated by the example in the table below (Table 3).

**Table 3.** The listing of the values of fixed assets adjusted for the market values in relation to the book values.

No.	The Name of the Fixed Asset	Book Value [PLN]	Market Value on the Valuation Date [PLN]
1.	A fiscal printer—Viking	1.499	800
2.	A printer—Canon 250	0	210
3.	A computer set	3.200	1.200
4.	A car—Toyota Avensis	14.500	9.500
5.	Cell phones—Motorola M3588—2 pieces	1.350	250
6.	A fax machine	0	200
7.	Software—WF-MAG	658.25	658.25
8.	A computer upgrade—HDD 4GB	340	0
9.	A truck—Citroen Berlingo OP15937	15.100	12.000
10.	Etc. till the inclusion of all the assets	...	...

Source: Own study based on the opinion of the court expert on behalf of the District Court of Katowice—Wschód in Katowice.

However, for practical reasons, only the most important balance sheet items are often subjected to adjustment, which are also different depending on the valuation objective. Due to the fact that the starting point of the valuation of the company is its net assets, there are many drawbacks to this method, which, to an extent dependent on the resources designed for valuation (mainly cash and time), are adjusted in the course of the valuation. The largest discrepancies between actual and balance sheet values are mostly caused by referring the balance sheet valuation to historical costs and the difficulty in clear classification of some items as equity or foreign capital (reserves, special funds, accruals). Therefore, in order to obtain the real value of the company, it is necessary to make adjustments to balance sheet items. When making adjustments, one should take into account the valuation objective. Other adjustments will be made when the company is purchased for resale, merger or significant reorganization. Adjustments of individual items are also dependent on the type of the conducted activity. The significance of balance sheet items is also assessed in order to reduce the costs of adjustments of less important items. Valuation should start with the determination if all the items are properly reflected in the balance sheet and if the items included in the balance sheet are not just empty records. Obviously, the balance sheet that is the basis for the valuation should be up to date.

The first item is intangible and legal assets. They are usually valued under the market value; however, when they are unsellable they are valued at zero. However, there are exceptions, e.g., non-transferable software licenses. In the case of business continuation, they will present measurable value. It should be taken into account that most development costs cannot be activated. Therefore, e.g., in research companies, the relevant adjustment may be essential. Another group is tangible fixed assets. If there is a secondary market for tangible fixed assets, the market price should be taken into account, since depreciation write-offs illustrate formal and not actual consumption of these assets. It is also possible to consider the price of a new fixed asset, taking into account a range of adjustments (due to technological underdevelopment, wear, expert opinion, market conditions, liquidity of the secondary market, etc.). It is also important to include, in the valuation, the fact that market prices may significantly vary depending on the stage of the business cycle [28]. The possessed land is usually underestimated, and making its value realistic results in an increased value of the company valued. In the case of the right to perpetual usufruct over land, under the item of tangible fixed assets the difference can be found between the first (higher) and subsequent (lower) charges. This difference will be subjected to depreciation write-offs in accordance with the general rules. Therefore, the possession of the right for perpetual usufruct over land will increase the value of the company valued.

When valuating receivables, despite the existing reserves, lowering adjustments are additionally made, which result from insufficient reserves. It is also necessary to indicate receivables that are not due to specific, already conducted transactions but agreements that cannot be included in the balance sheet on the day of its production [29]. It should be verified if the stocks included in the balance sheet actually exist and if the way of their valuation corresponds to the market value. It is also essential to determine whether the stocks owned by the company are not obsolete, broken or damaged. In the case of receivables, first of all, it should be checked if they are not underestimated and if there are not off-balance sheet obligations and what is the probability of their maturity. Such liabilities will additionally decrease the value of the company valuated. Also, tax liabilities may require adjustments.

While valuating financial assets, the market price of shares and/or stocks should be taken into account. Valuation ought to include the valuation of units in which the specific company has shares/stocks, as long as their value justifies such a way of conduct. When valuating cash, one should pay attention to whether it is cash or whether, under this item, there are also promissory notes and cheques that are associated with risk, which should be considered in appropriate adjustments. Prepayments and accrued income may also require adjustments. Most of all, it is necessary to determine if their allocation over time is correct. In the case of inappropriate estimation, accruals and deferred income may also require adjustments. A typical example would be not taking into account delayed invoices for external services that increase the costs of the specific period. Additionally, when business valuation is made with the intention to merge two entities, there are adjustments to harmonize the accounting approach used in each of the merged enterprises. Also, the need to pay dividends in the future or to recapitalize one of the merging enterprises by the third party will require adjustments increasing or decreasing the entity valuation.

Despite the fact that valuation is carried out on the basis of data resulting from the balance sheet, legal regulations or concluded agreements, this method is also not without a certain dose of subjectivity, since the valuator makes the decision on what adjustments and in relation to what assets they will be applied. Each business valuation should be approached individually, since it may turn out that each item in the balance sheet may require adjustments adapting it to the market value. The adjusted net assets method, due to less complicated assumptions necessary for its conduct and adjustment of prices to current net prices, is the most frequently applied asset-based method when making business valuations.

#### 4.1.2. The Practice Example No. 2

The objective of the valuation in the Example 2 (Table 4) is to inform about the value of equity for the previous owner, who is interested in selling his or her block of shares and is planning to use the valuation as a starting point in negotiations.

Downward adjustments adopted in the valuation related to the following assets:

- Intangible and legal assets—this is an integral part of computer hardware. In this case, the equipment along with the software was included under the item of technical equipment and machinery;
- Means of transport—the market value of the means of transport was lower than their balance sheet value by 11.7%. One of the three vehicles had had an accident; therefore, its value was reduced, which resulted in a lower value of the whole item;
- Fixed assets under construction—these were repair expenditures in the company's main office; the liquidation value of 0 PLN was accepted for the balance sheet after adjustment;
- Long-term receivables—20% was assumed, considering the failure in getting back all the deposits;
- Long-term investments—revaluation of the B2X Ltd. company, in which the Service company has 51% of shares, lowered the value by 24.5% from the balance sheet value;
- Goods and receivables on account of supplies and services—the adjustment indicator of 20% was adopted.

Upward adjustments on the asset side are the following components:

- Real estate (buildings, premises)—revaluation prepared by valutors increased the value by 23.7%, to PLN 5125 thousand and this amount was accepted for the adjusted balance sheet;
- Technical equipment and machinery—were subjected to adjustment on the basis of current market prices and the total value increased;
- Other fixed assets—the appraisal reports produced by valutors indicated a higher value than the balance sheet value.

**Table 4.** The assets of the Service S.A. company prior to and after adjustments.

(PLN Thousand)		Prior to Adjustment	Adjustment %	Adjustment	After Adjustment
<b>A.</b>	<b>Fixed Assets</b>	9453.39			10,303.05
<b>I.</b>	<b>Intangible and Legal Assets</b>	81.54			0
1.	Other intangible and legal assets (software)	81.54		−81.54	0
<b>II.</b>	<b>Tangible Fixed Assets</b>	6550.52			7825.00
1.	Fixed assets	6539.09			7825.00
a)	Buildings, premises and civil engineering facilities	4144.62	23.7%	980.38	5125.00
b)	Technical equipment and machinery	1076.26	23.7%	255.29	1331.54
c)	Means of transport	169.79	−11.7%	−19.79	150.00
d)	Other fixed assets	1148.42	13.2%	151.58	1300.00
2.	Fixed assets under construction	11.43	−100.0%	−11.43	0.00
<b>III.</b>	<b>Long-term Receivables</b>	583.01	−20.0%	−116.60	466.41
<b>IV.</b>	<b>Long-terms Investments</b>	1258.22			950.00
1.	Long-term financial assets	1258.22			950.00
a)	in affiliated entities				
	Shares in B2X Ltd.	1258.22	−24.5%	−308.22	950.00
<b>V.</b>	<b>Long-term Accruals</b>	980.10			980.10
1.	Deferred tax assets	964.47			964.47
2.	Other accruals	15.63			15.63
<b>B.</b>	<b>Current Assets</b>	3939.26			3692.45
<b>I.</b>	<b>Stocks</b>	1234.05			987.24
1.	Goods	1234.05	−20.0%	−246.81	987.24
<b>II.</b>	<b>Short-term Receivables</b>	461.54			390.26
2.	Receivables for the other entities	461.54			390.26
a)	On account of supplies and services, in the repayment period of up to 12 months	356.39	−20.0%	−71.28	285.11
b)	Due to taxes, subsidies, custom duties, social and health insurances and other benefits	79.60			79.60
c)	Others	25.55			25.55
<b>III.</b>	<b>Short-term Investments</b>	2000.00			2000.00
1.	Short-term financial assets	2000.00			2000.00
a)	Cash and other monetary assets	2000.00			2000.00
	- cash in hand and at bank	1000.00			1000.00
	- other cash	900.00			900.00
	- other monetary assets	100.00			100.00
<b>IV.</b>	<b>Short-term Accruals</b>	243.68			243.68
	<b>Total assets</b>	13,392.65			13,924.22

Source: [30].

No adjustments were made to foreign liabilities; therefore, their balance sheet value was assumed in the amount of PLN 7980.28 thousand. The adjusted assets in the amount of PLN 13,924.22 thousand—the adjusted liabilities in the amount of PLN 7980.28 thousand equals the value of PLN 5943.95 thousand. A lot of professionals in the field of business valuation usually end the valuation with the adjusted net assets method at this stage. However, within the framework of the development of the method, it is worth taking into account other components, which may have an impact on the value of the company (value sources), e.g., trademark (brand), know-how, own patents or licenses. In the business practice, the adjusted net assets method usually indicates a lower value of the operating enterprise since it does not include, for example, the value of the company's contacts or knowledge of employees. Therefore, in the process of business valuation, the value determined by the asset-based valuation method was considered as the minimum value for the seller, which constitutes the company's assets.

#### 4.1.3. The Practice Example No. 3

The ABC company, among its assets, has:

- The office building worth (according to the appraisal report of 2009) PLN 3 million,
- The production building worth (according to the appraisal report of 2009) PLN 5 million,
- The assembly line of 2003 worth (in the valuator's opinion) PLN 0.5 million,
- Stocks of materials and products worth PLN 4 million,
- Receivables worth PLN 3 million, PLN 0.5 million of which is uncollectible.

The total value of assets amounts to PLN 15 million (the market value of assets, which may significantly vary from the book value). At the same time, the value of liabilities of the company is two investment loans for a total value of PLN 8 million and liabilities to suppliers worth PLN 3 million. The value of liabilities amounts to a total of PLN 11 million. On the basis of the above, the adjusted net assets value amounts to  $PLN 15 - 11 = 4$  million.

The advantages of the valuation using the adjusted net assets method include:

- Objectivity and ease in carrying out by oneself,
- Access only to basic data,
- Taking into account the condition and usability of assets for operation,
- Possibility to compare with the value determined using other methods,
- Possibility to determine the lower range of values in negotiations.
- On the other hand, the primary disadvantages include:
- Not taking into account important components of the company's value not recorded in the balance sheet, e.g., contracts of the company, knowledge of employees, possessed brands and value of trademarks;
- Possibility to determine only the value of assets in the categories of the so-called material substance, which usually underestimates the value of the operating enterprise.

Undoubtedly, the adjusted net assets method offers the greatest usability in the case of enterprises with a high share of fixed assets in the value of the whole company, i.e., traditional production companies. This is confirmed by the evolutionary history of business valuation methods. At the same time, despite the increasing importance of income-based and comparable company methods, nowadays asset-based methods are still the basis for the estimation of business value.

#### 4.1.4. The Practice Example No. 4

Practical Example number 4 (Table 5) shows the valuation of the enterprise using the income method. This is one of the most popular methods of this type used in practice, namely, Discounted Cash Flows (DCF). For the calculation, the available econometric software used in business valuation practice in the market was applied.



**Table 5.** Example of valuation with the method of income (Discounted Cash Flows).

XYZ S.A.	2017	2018	2019	2020	2021	2022	2023	2024	2025	2026	2026+
<b>Model DCF (Discounted Cash Flows)</b>			Forecast	Forecast	Forecast	Forecast	Forecast	Forecast	Forecast	Forecast	Forecast
1. Operating result (EBIT)	1531	1607	1688.1	1772.5	1861.1	1861	1861	1861	1861	1861	1861
2. Tax rate %	19%	19%	19%	19%	19%	19%	19%	19%	19%	19%	19%
3. Tax on EBIT	290.9	305.5	320.7	336.8	353.6	353.6	353.6	353.6	353.6	353.6	353.6
4. Tax-adjusted operating result (NOPLAT)	1240	1302	1367.4	1435.7	1507.5	1507	1507	1507	1507	1507	1507
5. Depreciation	1317	1445	1597.6	1764.9	1949	2154	2384	2643	2936	3268	3644
6. Investment outlays (CAPEX)	1310	1517	1646.5	1788.6	1945.5	2154	2384	2643	2936	3268	3644
7. Change in working capital	180.0	171.8	180.3	189.4	198.8	0.0	0.0	0.0	0.0	0.0	0.0
<b>8. FCF-free cash flow</b>	<b>1067</b>	<b>1058</b>	<b>1138.1</b>	<b>1222.7</b>	<b>1312.8</b>	<b>1507</b>	<b>1507</b>	<b>1507</b>	<b>1507</b>	<b>1507</b>	<b>1507</b>
9. Risk-free rate%	5%	5%	5%	5%	5%	5%	5%	5%	5%	5%	5%
10. Beta indicator	1.2	1.2	1.2	1.2	1.2	1.2	1.2	1.2	1.2	1.2	1.2
11. Market premium %	2%	2%	2%	2%	2%	2%	2%	2%	2%	2%	2%
12. Cost of equity %	7.4%	7.4%	7.4%	7.4%	7.4%	7.4%	7.4%	7.4%	7.4%	7.4%	7.4%
13. Cost of debt %	8%	8%	8%	8%	8%	8%	8%	8%	8%	8%	8%
14. Tax rate %	19%	19%	19%	19%	19%	19%	19%	19%	19%	19%	19%
15. Cost of debt after tax %	6.5%	6.5%	6.5%	6.5%	6.5%	6.5%	6.5%	6.5%	6.5%	6.5%	6.5%
16. Value of equity (resulting from the valuation)	14092.6	14092.6	14092.6	14092.6	14092.6	14092.6	14092.6	14092.6	14092.6	14092.6	14092.6
17. Value of debt	7075	7075	7075	7075	7075	7075	7075	7075	7075	7075	7075
18. Share of equity	66.6%	66.6%	66.6%	66.6%	66.6%	66.6%	66.6%	66.6%	66.6%	66.6%	66.6%
19. Share of debt	33.4%	33.4%	33.4%	33.4%	33.4%	33.4%	33.4%	33.4%	33.4%	33.4%	33.4%
<b>20. Weighted Cost of Capital (WACC)</b>	<b>7.09%</b>	<b>7.09%</b>	<b>7.09%</b>	<b>7.09%</b>	<b>7.09%</b>	<b>7.09%</b>	<b>7.09%</b>	<b>7.09%</b>	<b>7.09%</b>	<b>7.09%</b>	<b>7.09%</b>
21. Discount indicator	0.933	0.871	0.8142	0.7603	0.709	0.662	0.619	0.578	0.539	0.504	0.504
22. FCF growth rate after 2026		0%	0%	0%	0%	0%	0%	0%	0%	0%	0%
23. Residual value after 2026		-	-	-	-	-	-	-	-	-	21,255
<b>24. Discounted FCF-Free Cash Flow</b>	<b>996.9</b>	<b>923.2</b>	<b>926.6</b>	<b>929.6</b>	<b>932.0</b>	<b>999.3</b>	<b>933.1</b>	<b>871.3</b>	<b>813.6</b>	<b>759.8</b>	<b>10,712</b>
<b>25. Discounted Free Cash Flow Ascending</b>	<b>996.9</b>	<b>1920.1</b>	<b>2846.7</b>	<b>3776.3</b>	<b>4708</b>	<b>5707</b>	<b>6640</b>	<b>7512</b>	<b>8325</b>	<b>9085</b>	<b>19,797</b>
<b>1. Value of the Company from the Valuation</b>	<b>19,797.6</b>										
2. Net debt at the end of 2018	5705.0										
<b>3. Value of Equity from the Valuation</b>	<b>14,092.6</b>										
4. Number of shares in the company	1000										
<b>5. Value of 1 share</b>	<b>14.09</b>										

Source: [31].

The most common methods currently used in valuation practice are the adjusted net asset method and the discounted cash flow method [32]. They form the basis for determining the explanatory variables regarding assets and income options. To combine the advantages of both methods, mixed methods were created that look for optimal structural parameters.

#### 4.2. The Analysis of Methods and the Valuation Process to Establish the Determinants of Value Subjectivity

Asset-based methods are historically the oldest concept of business valuation, adopting assets as the bases for determining the value. Therefore, the value of enterprises, being the effect of this valuation, is known as the asset value. This means that the company is worth as much as its valuated

assets. However, due to the fact that many companies are in debt, one may talk about the gross and net assets value, i.e., the value reduced by the value of debt. In these methods, the market value of the company, understood as the sum of the value of business asset liquidation, is subjected to valuation. The first and simultaneously the simplest valuation of assets is carried out using the net book value method (recordkeeping). The information included in the balance sheet is directly used. The formula for business valuation using the recordkeeping net assets value method:

$$WP = A - P_o = KW,$$

WP—business value (net book value),  
 A—total balance sheet value of assets,  
 P<sub>o</sub>—balance sheet value of foreign liabilities,  
 KW—balance sheet value of equity.

However, the book value of assets and liabilities does not usually equal their market value, which, in the current rapidly changing market conditions—in particular, in the segment of high technologies—may result in significant differences in value, which become unacceptable in order to determine the current fair value. The valuation based on the market value of the possessed assets and liabilities is known as the adjusted net assets method. The formula for business valuation using the adjusted net assets value [33]:

$$WP = AW - POW = KWW$$

AW—total adjusted assets value,  
 POW—value of adjusted foreign liabilities,  
 KWW—value of adjusted equity.

It is the most common method of valuation of business assets applied nowadays.

The objective of the replacement method is to estimate the total financial outlay that would be needed to restore individual assets of the valuated company. This method is often used by entrepreneurs making a decision on whether it is more profitable to buy a company or build it on one's own from the ground up [34]. The formula for business valuation using the replacement method (valuation of infrastructural enterprises—the main asset is infrastructure, e.g., power distribution companies) [8]:

$$W_{ON} = W_{OB} (1 - Z_f)(1 - Z_m),$$

W<sub>ON</sub>—net replacement value (the value of the fixed asset, taking into account its physical and moral wear),  
 W<sub>OB</sub>—gross replacement value (the value of the new fixed asset),  
 Z<sub>f</sub>—physical (technical) wear indicator,  $0 \leq Z_f$ ,  
 Z<sub>m</sub>—moral wear indicator (technological change, aging),  $Z_m \leq 1$ .

A specific case is business valuation using the liquidation method (for the purposes of insolvency proceedings), but then fair value is being dealt with.

Income-based methods consist in estimating the market value of the company understood as the sum of net income obtainable from the company in the future. The general formula of business valuation using the income-based method [10]:

$$WP = \sum_{i=1}^n a_t * D_t,$$

t—year of the analysis,  
 a<sub>t</sub>—discount rate for the year t,

$D_t$ —income in the year  $t$ .

In practice, the most frequently applied method is referring valuation to discounted cash flows. The formula for business valuation using the discounted cash flow method [9]:

$$W_d = \sum a_t * NCF_t + RV,$$

$W_d$ —income value,

$a_t$ —discount rate for the year  $t$ ,

$NCF_t$ —net cash flows for the year  $t$ ,

$RV$ —residual value.

There are many types of valuations using the DCF (Discounted Cash Flow) method, varying both in the level of detail and the structure of cash flows, as well as the determination of the discount rate. According to the DCF method, the value of the company equals the sum of cash flows discounted at an appropriate rate, which, after cumulation and summing, creates the total cash flow at the disposal of the owners [1].

Asset-based methods, as the oldest concept of the valuation of assets, contemporarily also using the practice of comparable company methods, seem to be to the greatest extent objective and compliant with the intention to determine fair value. On the other hand, income-based methods still require improvement in creating good practices and standards, at least in terms of defining discount rates and the number of years accepted for valuation since, among others, these factors allow for the excessive subjectivity of valuation. Comparable company methods consist in estimating the market value, which is established on the basis of the known sale and purchase transactions. The principle of this method is applied when valuating assets, the prices of which are adjusted to market values. However, the method of comparable company valuation is also the method based on market multiples, which is based on the assumption that the financial market provides the best information for business valuation. The selection of multiples and their use is complicated and causes a lot of controversies, particularly in pursuit of fair value. Therefore, the choice of multiples undoubtedly belongs to the subjective determinants of business valuation.

Mixed valuation methods combine the methods of the valuation of assets with income-based methods. This is due to the assumption that the value of the company is affected not only by its assets but also by the ability to generate income. However, these methods may be unreliable, and this is associated with the possibility of overestimation or underestimation in valuation due to different proportions in the value of assets and profitability in the formulas proposed. Table 6 contains examples of valuation for various mixed methods using the example of actual data presented in the court reports in Katowice and Cracow. The examples were selected because of the same assumptions concerning the valuation using the income-based method. The valuers chose the methods in the following order: the Swiss, German and Stuttgart methods.

**Table 6.** The examples of valuation for various mixed methods.

Method	Assets and Income	Stuttgart Formula: $W = M + (5r/1 + 5r)(D - M)$	Anglo-Saxon Formula: $W = M + [1 - 1/(1 + r)^n](D - M)$	German Formula: $W = (M + D)/2$	Swiss Formula: $W = (2D + M)/3$
Valuation (in PLN Thousand)	M = 120 D = 410	216	230	265	313
	M = 98 D = 546	247	268	322	397
	M = 290 D = 110	230	221.5	200	170

Source: Own study based on the valuations by appraisers at the District Court in Katowice and Cracow.

Depending on the subjective choice of the method by the valuator, significant differences in the final valuation may be observed, with low values of the company. Therefore, the objective should be to develop standards that will determine acceptable methods (patterns) for specific industries or cases.

In the above example, it can be seen that the Swiss method prefers (valuates higher) companies that bring higher income with fewer assets, and therefore prefers companies in which assets are less important, e.g., modern IT companies. While the Stuttgart method will price companies higher having a high value of assets with less importance assigned to income possibilities. In this case, it is possible to choose a method that is more favorable to one of the valuation stakeholders of the company. Most often it is a contradictory interest, because one party wants a higher and the other wants a lower valuation. However, as part of the standard and certain norms, objective valuation of the business should be sought: the so-called fair value price. That is why it is so important to define norms and standards even for specific industries. There are also possibilities to create econometric models that, depending on the changing values of determinants, will create a valuation tailored to specific conditions and types of companies. This is an interesting research direction in this field, which requires numerous numerical calculations to develop appropriate patterns. This clearly shows the need for development and the need to come up with new proposals for business valuation methods, which can be seen today.

#### 4.3. The Methodology of Business Valuation According to the MDI-R Concept

The contemporary methodology of business valuation according to the authors' concept takes place in accordance with MDI-R (assets, income, intellectual capital and all these components embedded in the market) [35]. Changes in the economic realities of the world (globalization and rapid technological development) have resulted in alterations in valuation methods according to the change in the significance of the components affecting the company's value. Nowadays, the so-called intangible and legal assets are the most important for the total valuation, which has resulted in the natural development and changes in the concepts of business valuation. Additionally, due to the complexity of issues and the share of all historically known components in the total valuation, undoubtedly, one should look for synthetic and universal calculation models. Mixed methods combine asset-based and income-based calculations. The methodology of MDI-R additionally takes into account comparable company methods, as well as the intangible assets and legal valuation. This results from the assumption that the value of the company is affected not only by its assets, including intangible and legal assets, but also by the ability to generate income and the current market (economic) situation of the environment. The company's assets are valued using the following general formula [36]:

$$M = A - P_o,$$

where:

M—the company's assets,  
A—assets,  
P<sub>o</sub>—foreign liabilities,

where the value of fixed assets can be calculated according to the following formula:

$$W_{st} = W_n(1 - Z_f),$$

where:

W<sub>st</sub>—value of the fixed asset,  
W<sub>n</sub>—value of a new fixed asset,  
Z<sub>f</sub>—wear rate of the fixed physical asset, in the range of  $0 \leq Z_f \leq 1$ ,

or using the market comparable company method, i.e., the current price of the worn fixed asset in the market.

Income is calculated according to the general concept adopted in income-based methods, in particular, using widely known and utilized indicators, for example:

$$D = \frac{NOPAT}{WACC},$$

where:

*NOPAT*—projected annual net operating profit after tax,

*WACC*—discount rate, reflecting weighted average cost of capital of the valuated company.

The DCF method is the most popular income-based method. According to the DCF method, business value equals the sum of discounted cash flows generated by the enterprise, which, after cumulation and summing, create the total cash flow at the disposal of the owners [31].

The MDI-R calculation model takes into account the so-called intangible and legal assets, i.e., human potential, know-how, reputation, the company's market position, etc. These assets are not subjected to the objective valuation since the assets of this type depend on the subjective behavior of market entities, which decide how much they are able to offer for intangible and legal assets. Therefore, these values are considered (valuated) using the comparable company method, consisting in comparisons with transactions of similar companies in the same industry [34]. Depending on the quantity of available transactions, the formula is the following:

$$W_{NiP} = \frac{(W_1 + W_2 + \dots + W_n)}{n},$$

where:

*W<sub>NiP</sub>*—market value of single, specific intangible and legal assets,

*w<sub>1</sub>, w<sub>2</sub>*—known market prices of similar intangible and legal assets,

*n*—number of transactions of the specific value.

The importance of intellectual capital has increased substantially in recent years since business value is less and less dependent on tangible factors. This is caused by global technological, organizational changes, etc., which have led to the knowledge-based economy [35]. Intellectual capital, among others, consists of:

- Specific knowledge, experience, technology,
- Legal assets (brand, know-how, reputation, etc.),
- Relationships with customers and professional skills.

At the same time, the issues associated with intellectual capital are still not well-known and there are many ambiguous and various solutions for both theory and practice in this field [37].

Undoubtedly, due to difficulties in the valuation of the so-called intangible and legal assets, which primarily determine the value of enterprises, in particular highly developed ones, in terms of technology, one deals with difficulties in achieving the so-called fair business valuation. Nowadays, the conclusion is that, in order to make the best possible valuation, it is necessary to valuate individual components affecting the value of the company with separate methods that best reflect the nature of their value. This rule is obeyed by the MDI-R model, which allows the estimation of the total business value, i.e., takes into account all the components affecting business value while assuming that human capital (knowledge, skills) remains unchanged. Business valuation, in accordance with the MDI-R concept, will present the overall image of changes in the company's value, as well as the ones resulting from changes in the business environment. Such valuation will be a good measure of the effectiveness of operations conducted in the enterprise. The characteristics of the MDI-R methodology include:

- Taking into account both tangible and intangible assets (W<sub>NiP</sub>),

- Taking into account the abilities to generate income,
- Taking into account the current situation in the market in which the company operates,
- Taking into account the company's financing method,
- Taking into account future investment needs,
- Universality—variability of the applied methods in the valuation of specific components, taking into account the conditions for the specific industry.

Therefore, it can be concluded that the MDI–R methodology presents the overall image of changes in the value of the company, as well as the ones that result from changes in the business environment and have an impact on its value. The vast amount of frequently contradictory information concerning economic processes is a characteristic feature of the contemporary knowledge-based economy. Therefore, it is very important to include intangible assets in the valuation, which is an extremely complicated challenge.

The econometric model using an equation (system of equations) helps to explain the mechanism of changes occurring in the studied area. It describes the relationships between given economic quantities. This is a formal mathematical record of existing economic regularities.

$$Y_i = \alpha_0 + \alpha_1 X_{i1} + \alpha_2 X_{i2} + \varepsilon_i.$$

A basic example of a linear model is also used in the valuation model, although the actual relationship can be more complicated, which evolves through a number of practical studies. Building an econometric model requires not only good knowledge of economic theory and mathematical and economic knowledge, but also knowledge of economic practice. The econometric model should not only have a cognitive value from the point of view of economic theory, but also a practical value, which means that it can serve as a tool of inference in the future.

In the valuation model, the explained value is the business value. The main explanatory variables are the value of company assets and the value of income brought. The random component contains, among others, all variables omitted or errors in measurements and calculations. This property is closer to real variables, to what is happening in the real world. After all, we can never determine perfectly straightforward functional dependencies. The function of such a component is performed by the comparative method, which is used to calculate the explanatory variables  $M_R$  and  $D_R$ . That is why the comparative method often appears as a peculiar random component in the econometric model regarding the valuation of enterprises. It allows comparison with transactions (of individual components and also of the most similar companies) that have already taken place on the market. Such a synthetic and universal calculation model is a way to eliminate many risks and problems in business valuation that need to be faced in the future.

As part of the available valuations made by appraisers in the District Court in Katowice and Krakow, a linear regression was performed to estimate structural parameters in the valuation model based on the MDI-R methodology. The companies valued belong to the IT industry. The first row in Table 7 contains estimates of structural parameters, the second row contains standard errors of these estimates. The coefficient of determination (determination) informs about how much of the variability (variance) of the variable explained in the sample coincides with the correlations with the variables contained in the model. It is therefore a measure of the extent to which the model matches the sample. The bigger the regression line, the better suited the data. If the value is between 80% and 90%, then the match is considered good, as in the following example.

**Table 7.** Linear regression model in MDI-R methodology for known valuations at the District Court in Katowice and Krakow for the IT industry.

$\alpha_0$	$\alpha_1$	$\alpha_2$
-0.864	0.379	0.621
S ( $\alpha_0$ )	S ( $\alpha_1$ )	S ( $\alpha_2$ )
4.791	0.119	0.252

$$R^2 = 0.8065 = 80.65\%$$

Source: own study.

$$M_R = (W_{NiP} + A) - P_o,$$

$$D_R = \sum_{i=1}^n a_i * NCF_t + RV,$$

$$WP = 0.379 * M_R + 0.621 * D_R - 0.864.$$

Undoubtedly, structural variables require further practical research. For example, the search for more complex relationships than the linear relationship and the values of the structural variables themselves should be assumed. Nowadays, due to the knowledge-based economy (the greater significance of intangible assets and the smaller value of tangible assets), income value is more important in valuation. This allows for practical calculations in the proposed model, as shown in Table 8. However, there are still and will continue to be industries where the high value of material assets will be necessary for business operation. Therefore, estimating structural variables for these differences will require different equations. This will allow a search for the optimal method of business valuation. Currently, it can be concluded that due to differences in industries (resulting from differences in the value of owned assets), a system of equations will most likely be required that will allow tailoring of the selected equation to a particular industry or type of company.

**Table 8.** The examples of valuation for MDI-R methods.

Method	Assets and Income	MDI-R
Valuation (in PLN thousand)	M = 120 D = 410	299
	M = 98 D = 546	375
	M = 290 D = 110	177

Source: own study.

Summing up the business valuation methods, it can be concluded that the appropriate model for the valuation of the economic entity should not only inform about the total value but also indicate the structure of the sources of its creation. Therefore, business valuation methods should take into account as many components as possible of the company affecting its value, which was proposed in the MDI-R concept. Additionally, the proper valuation should be adjusted to the nature of the company and the specific areas of its business activity.

## 5. Discussion and Conclusions

Within the framework of this article, the essence and manner of business valuation using asset-based methods, which constitute the basic and historically first approach to the monetary

business valuation, were determined. Within the framework of the conducted analysis, in terms of the new approach, the reasons for the contemporary crisis of confidence in the business valuation process were presented, including problems and risks occurring in asset-based methods, which, according to the subject literature, are the oldest and most objective foundations for the valuation of a company's assets. While aimed at solving the existing problems and risks, the possibilities of implementing new rules that will restore the quality and confidence in standards for determining the monetary value of a company were determined. Within the framework of determining the direction towards the accomplishment of the objective, which is the most objective valuation of enterprises, the authors' proposals of changes were depicted, which at least related to the need to specify certain valuation methods that can be used in relation to specific industries of the economy and categories of components creating the valuated assets. Nowadays, intangible assets and the ways of their use are more important than the category of so-called material substances, which determine the abilities of the company to multiply the invested capital (including, among others, human potential, brand, know-how, etc.). In the study, through the prism of the analysis and classification of asset-based business valuation methods used in practice, it was shown that the adjusted net assets valuation method is currently the best (objective and the closest to the model fair value) solution, which is confirmed by the fact that it is the basis for all valuations in economic practice. On the other hand, within the framework of the accomplishment of the authors' objective, through the analysis of the literature and practical examples, the need for improvement in the code of conduct and valuation standards was indicated, both in the overall process and within the framework of individual principles applied under asset-based methods, since there is a serious problem in the application of these methods to intangible and legal assets. At the same time, in the study, the factors that can distort the establishment of fair value were presented, while attention was paid to the multidimensionality and complexity of issues of valuation, due to which the pursuit of optimal solutions requires a number of studies of both scientists and practitioners of the discussed subject matter. The research methodology in this study was based on reasoning regarding the methodology of asset-based methods of business valuation and the analysis of practical examples in order to verify the hypothesis of the existence of critical components of valuation, which enable the use of wide subjectivity in estimating the value of assets. The process of valuation of the company, its specificity and essence pose many problems and controversies. This is connected with the essence of monetary valuation, which is a subjective measure. Then, there are various conditions and numerous procedures and methods for business valuation, presented in the study. At the same time, the reasons for the contemporary crisis of confidence in the methodology of business valuation were presented and the directions of future development were indicated, which are of fundamental importance for the operations and opportunities of the conducted business. The study is a part of the discussion concerning the future and development of subsequent solutions aimed at determining, as far as possible, the most objective patterns and standards of business valuation implemented in the practice of economic life.

Summing up, it can be concluded that the appropriate model for the valuation of the economic entity should not only inform about the total value, but also indicate the structure of the sources of its creation. Therefore, business valuation methods should take into account as many components of the company affecting its value as possible. Nowadays, the valuation process is already moving in this direction, the example of which is a simultaneous use of, most frequently, asset-based, income-based and comparable company methods to determine the final value of the company. The use of several methods of valuation in the course of the applied procedure provides an opportunity to make rational decisions as to the final value of the enterprise. Such a tool will lead to the desired harmonization of the methodology for estimation of the basic parameters serving valuation with such a degree of quality, which will provide the recipients of this information with a selection of accurate decision-making options in the future.

In accordance with the literature on the subject, it was found necessary to search for more perfect methods for optimal valuations of fair value for enterprises. An undoubted contribution is the authors'



proposed hybrid method MDI-R, which draws from existing solutions to improve their functionality and applicability. In addition, the article indicates the possible directions of development of valuation methods and the use of existing valuation models to identify companies threatened with bankruptcy. However, in the case of valuation, it is much more complicated and probably should determine the system of equations that will take into account various industries and economic situations.

**Author Contributions:** Conceptualization, M.K and I.M.; methodology, P.S. and I.M.; software, P.S. and I.M.; validation, M.K. and I.M.; formal analysis, M.K. and I.M.; investigation, P.S.; resources, M.K., P.S. and I.M.; data curation, M.K. and I.M.; writing—original draft preparation, M.K. and I.M.; writing—review and editing, P.S.; visualization, P.S. and I.M.; supervision, P.S. and I.M.; project administration, M.K.; funding acquisition, P.S. All authors have read and agreed to the published version of the manuscript.

**Funding:** The project was financed within the framework of the program of the Minister of Science and Higher Education in Poland under the name “Regional Excellence Initiative” in the years 2019–2022, project number 001/RID/2018/19, the amount of financing PLN 10,684,000.00.

**Acknowledgments:** Many thanks to Leon Dorozik for scientific support and Janina Miciuła for life support.

**Conflicts of Interest:** The authors declare no conflict of interest.

## References

1. Mączyńska, E. *Valuation of Companies*; The Association of Accountants in Poland: Warsaw, Poland, 2005.
2. Mohnen, P.; Hall, B.H. Innovation and productivity: An update. *Eurasian Bus. Rev.* **2013**, *3*, 47–65. [\[CrossRef\]](#)
3. Ngo, L.V.; O’cass, A. Innovation and business success: The mediating role of customer participation. *J. Bus. Res.* **2013**, *66*, 1134–1142. [\[CrossRef\]](#)
4. Strykiewicz, T.; Męczyński, M.; Stachowiak, K. Role of creative industries in the post-socialist urban transformation. *Quaest. Geogr.* **2014**, *33*, 19–35. [\[CrossRef\]](#)
5. Van de Schootbrugge, E.; Wong, M.K. Multi-Stage valuation for start-up high tech projects and companies. *J. Account. Financ.* **2013**, *13*, 45–50.
6. Schumpeter, J.A. *Essays: On Entrepreneurs, Innovations, Business Cycles and the Evolution of Capitalism*; Taylor & Francis Group, Routledge: Abingdon, UK, 2017.
7. Miles, R.C. *Basis Business Appraisal*; John Wiley & Sons: New York, NY, USA, 1984; ISBN 978-047188559.
8. Nita, B. *Methods of Measurement and Development of Enterprises*; Polish Economic Publishing House: Warsaw, Poland, 2007; ISBN 978-83-7655-632-8.
9. Cornell, B. *Corporate Valuation*; McGraw – Hill: London, UK, 1993; ISBN – 10: 1556237308.
10. Machala, R. *Financial Management and Business Valuation*; OFICYNA: Warsaw, Poland, 2009.
11. Jaki, A. *Valuation and Development of the Company's Value*; PWN: Cracov, Poland, 2008; ISBN 978-83-7556-463-1.
12. Klingenberg, B.; Timberlake, R.; Geurts, T.G.; Brown, R.J. The relationship of operational innovation and financial performance—A critical perspective. *Int. J. Prod. Econ* **2013**, *142*, 317–323. [\[CrossRef\]](#)
13. Steffens, P.R.; Douglas, E.J. Valuing technology investments: Use real options thinking but forget real options valuation. *Int. J. Technoentrepreneurship* **2007**, *1*, 58–77. [\[CrossRef\]](#)
14. Miciuła, I. Methods of creating innovation indices versus determinants of their values. *Eurasian Econ. Perspect. Eurasian Stud. Bus. Econ.* **2018**, *8*, 357–366. [\[CrossRef\]](#)
15. Capel, C. Mindfulness, indigenous knowledge, indigenous innovations and entrepreneurship. *J. Res. Mark. Entrep.* **2014**, *16*, 63–83. [\[CrossRef\]](#)
16. Galindo, M.A.; Mendez, M.T. Entrepreneurship, economic growth, and innovation: Are feedback effects at work? *J. Bus. Res.* **2014**, *67*, 825–829. [\[CrossRef\]](#)
17. Fernandez, P. *Valuation Methods and Shareholder Value Creation*; Academic Press: San Diego, CA, USA, 2002.
18. Zhao, F. Exploring the synergy between entrepreneurship and innovation. *Int. J. Entrep. Behav. Res.* **2005**, *11*, 25–41. [\[CrossRef\]](#)
19. Miciuła, I. Współczesna metodyka wyceny przedsiębiorstw i jej wyzwania w przyszłości (Contemporary corporate valuation methodology and its challenges in the future). *Acta Univ. Lodz. Folia Oecon.* **2014**, *2*, 183–193.
20. Engel, D.; Keilbach, M. Firm-level implication of early stage venture capital investment: An empirical investigation. *J. Empir. Financ.* **2007**, *14*, 150–167. [\[CrossRef\]](#)

21. Zwolak, J. The effectiveness of innovation projects in Polish industry. *Rev. Innov. Compet. J. Econ. Soc. Res.* **2016**, *2*, 97–110. [CrossRef]
22. Zarzecki, D. *Metody Wyceny Przedsiębiorstw (Business Valuation Methods)*; Fundacja Rozwoju Rachunkowości: Warszawa, Poland, 1999.
23. Kraus, S.; Richter, C.; Brem, A.; Cheng, C.-F.; Chang, M.L. Strategies for reward-based crowdfunding campaigns. *J. Innov. Knowl.* **2016**, *1*, 13–23. [CrossRef]
24. Eurostat. 2019. Available online: <http://europa.eu/statistics/> (accessed on 10 January 2019).
25. Borowiecki, R.; Czaja, J.; Jaki, A. *New Methods for Estimating the Value of Companies*; LIBER: Warsaw, Poland, 2005; ISBN 978-83-7641-552-9.
26. Garcia, S.; Luis, J.; Perez-Ruiz, S. Development of capabilities from the innovation of the perspective of poverty and disability. *J. Innov. Knowl.* **2017**, *2*, 74–86. [CrossRef]
27. Nowa Nota Interpretacyjna Nr 5 – Ogólne Zasady Wyceny Przedsiębiorstw. 2019. Available online: [http://pfarm.pl/NI\\_5.pdf](http://pfarm.pl/NI_5.pdf) (accessed on 10 September 2019).
28. Mitek, A.; Miciuła, I. Determinants of functioning of private enterprises and barriers to their development. *Transylv. Rev.* **2017**, *1*, 123–139.
29. Brzozowska, A.; Kabus, J. Determinants of enterprises' innovativeness in the light of empirical studies—Case studies of Austria and Poland, scientific notebooks of the Silesian University of Technology. *Organ. Manag.* **2018**, *116*, 7–22. [CrossRef]
30. Panfil, M. *Business Valuation in Practice – Methods and eXamples*; MT Business: Wrocław, Poland, 2009.
31. E-BizCom. 2020. Available online: [https://www.e-bizcom.net/program\\_aplikacja\\_wycena\\_spolek/](https://www.e-bizcom.net/program_aplikacja_wycena_spolek/) (accessed on 4 March 2020).
32. Volante. 2020. Available online: <https://volante.pl/wycena-spolek-przedsiębiorstw-firm> (accessed on 2 March 2020).
33. Miciuła, I. Metodyka wyceny wartości przedsiębiorstwa według koncepcji MDR, a kryzys zaufania (The methodology of valuation of the enterprise according to the MDR concept and the crisis of trust). *J. Manag. Financ.* **2012**, *10*, 65–74.
34. Festel, G.; Wuermseher, M.; Cattaneo, G. Valuation of early stage high-tech start-up companies. *Int. J. Bus.* **2013**, *18*, 216–231.
35. Behrouzi, F.; Wong, K.Y. Lean performance evaluation of manufacturing systems: A dynamic and innovative approach. *Procedia Comput. Sci.* **2011**, *3*, 388–395. [CrossRef]
36. Miciuła, I. The universal elements of strategic management of risks in contemporary enterprises. *Przedsiębiorczość Zarz. Entrep. Manag.* **2015**, *16*, 313–323.
37. Morris, S.; Snell, S. Intellectual capital configurations and organizational capability: An empirical examination of human resource subunits in the multinational enterprise. *J. Int. Bus. Stud.* **2011**, *42*, 805–827. [CrossRef]



Article

# Young People Collecting Natural Souvenirs: A Perspective of Sustainability and Marketing

Arnold Pabian \*, Aleksander Pabian and Andrzej Brzeziński

Department of Management, Czestochowa University of Technology, 42-201 Czestochowa, Poland; aleksander.pabian@hotmail.com (A.P.); abf@op.pl (A.B.)

\* Correspondence: arnold.p@wp.pl

Received: 19 December 2019; Accepted: 8 January 2020; Published: 9 January 2020

**Abstract:** Collecting of natural souvenirs causes destruction of the natural environment as well as social and economic problems. The article shows that the next generation will have a tendency to aggravate such problems by collecting natural souvenirs. To discover the preferences of young people related to collecting natural souvenirs, the authors performed a survey in Poland on a sample of 426 persons aged 21–30. The survey has shown that 80.7% of young people participating in tourist trips bring souvenirs to their places of residence. As much as 61.4% collect natural souvenirs. Most people bring shells (53.9%), rocks (22.7%), and sand from seaside beaches (18.0%). Natural souvenirs are important to young Poles. This is confirmed by the following major motivations for collection: natural souvenirs are unique (26.2%), genuine (23.8%), bring back the best memories (22.6%), and cannot be bought in stores (14.5%). Only 9.8% of those surveyed oppose bringing of natural souvenirs, 5.2% deem such practices unlawful, and 11.2% recognize their detrimental effect on local tourist attractions. The article presents demarketing actions, which can largely stem the negative phenomenon of collection of natural souvenirs.

**Keywords:** sustainability; sustainable tourism; natural souvenirs; demarketing

---

## 1. Introduction

Sustainable development cannot keep up with the pace and scale of accumulation of ecological problems. The natural potential of the Earth is quickly running low. The aggravating unsustainability is evidenced by the deteriorating indicators presented in subsequent editions of the Living Planet Report. The global equilibrium between the Earth's ecosystems, which have developed for millions of years, and the human world of production and consumption, becomes disrupted. Not only do these ecosystems provide humans with food, water, and fresh air, but they also create the conditions for relax needed by every tourist.

The concept of sustainability has entered the sector of tourism, initiating the development of sustainable tourism, also known as soft tourism or environmentally sensible tourism. Today, sustainable tourism is regarded as a broadly understood concept of environmentally-friendly tourist development in rural areas and in cities, in small tourist centres, as well as great entertainment and leisure centres. It means respect to cultural, social, and natural values of the area visited by the tourists; protection of natural and cultural resources; respect to the identity, tradition, and lifestyle of local communities, with simultaneous utilization (primarily by the local community, to a smaller extent by external investors) of an economic opportunity provided by tourism for the economic development of the region. Sustainable tourism relies on the model of sustainable development, which was first defined in a declaration of the UN convention (1972), and finally clarified in 1987 by the World Commission on Environment and Development in the report "Our Common Future".

Although the interest in sustainable tourism among both researchers and tourism organizers is on the rise, the same cannot be said about travel agency customers. The behaviours of many tourists

are still contrary to this idea. An example can be taking of natural souvenirs, i.e., various elements of natural environment, fauna, flora, urban, and rural architecture, such as sand, stones, shells, parts of walls, from places of leisure. Tourists from all around the world appropriate different objects during their holidays, including sand, gravel, stones, shells, parts of volcanic rocks, parts of plants, or even small animals. During a single summer season, customs services at the Cagliari airport can confiscate as much as five tons of sand from the tourists. Azulejo tiles disappear from Portugal. In St. Petersburg, in the city centre alone, 12,000 cobblestones vanish from the Palace Square each year. There are willing buyers for pieces of the Berlin Wall as well [1]. Unfortunately, in the age of mass travelling, such practices are contrary to the principles of sustainable development. They exemplify activities from the area of warped tourism, characterized by a destructive effect on all three spheres of the system, i.e., the natural environment, the socio-cultural environment and the economy itself.

Tourists collect natural souvenirs during domestic and foreign trips and then bring them to their places of residence. Such practices result in emergence of research problems regarding the attitude of young people to bringing natural souvenirs and the legality of such practices in their opinion, the consequences for the natural and cultural environment as well as for the society and the economy, the kinds of natural souvenirs brought by young tourists, the tendency by young generation to aggravate or eliminate ecological problems arising from acquisition of natural souvenirs.

In order to explain these problems, the authors of the article performed a questionnaire survey on a representative group of 420 persons aged 21–30, participating in tourist trips. The goal of the article is to present the survey results together with conclusions, as well as to formulate marketing recommendations the implementation of which may largely reduce the damage caused by bringing of natural souvenirs. This will have a favourable effect on the condition of the natural environment, and will protect cultural heritage, including monuments of history, from destruction, largely contributing to sustainable development.

The problem of collecting natural souvenirs is very important and should be investigated in various aspects. Modern tourism is a mass phenomenon. Most tourists bring souvenirs (natural ones as well) from their trips. Therefore, collecting natural souvenirs is becoming a mass phenomenon as well. This means mass depletion and destruction, primarily of the natural environment of which humans are a part. It also causes social and economic problems. In this context, the preferences and behaviors of the young people are important. The young generation takes over responsibility of the Earth and will influence the future of the world.

## **2. Literature Review**

Many scholars have studied the subject matter of tourist souvenirs, identifying them with messengers of meaning and tradable commodities (historical perspectives on souvenirs research, souvenirs as messengers of meaning, souvenirs as tradable commodities and the commodification of souvenirs and handicrafts) [2]. Researchers agree that every souvenir is a thing representing the environment of a destination, affecting a person. In the age of mass consumption, travel souvenirs usually function as a part of supply of the tourist market, comprising products of the souvenir industry or craft with exchange and utility value. The most popular tourist souvenirs are objects specially made for sale, including different utility objects, toys, local and regional products, foods, signs and symbols, presenting the culture of the destination. An important group of souvenirs is comprised by photographs and videos made by tourists themselves. Yet another group includes objects which gain the status of souvenirs by decision of the tourists. This means products which have not been made for tourist purposes but in order to satisfy the needs of local purchasers, e.g., beer coasters [3–5]. From a sociological perspective, it is important to define souvenirs as commodities with specific values, such as Marx's use and exchange value and Baudrillard's sign-value, as well as introducing an additional one, the spiritual-value, as well as functions the tourist expects to obtain by purchasing them [6].

Souvenirs are perceived not only by their utility, but also by their meaningfulness [7]. They fit into the duality of the sphere of cultural meanings, pointed out by C. Geertz. They speak of something,

constitute a model of something, and invoke something at the same time (adapting the reality to themselves), thus constituting the so-called model for themselves. This fact is confirmed by the research of Michael Haldrup who has pointed out the roles they take as material and embodied cohabitants in domestic space, living and communicating with their owners. Therefore, a souvenir is not only a tourist marker or a personal object of memory but it has many faces as a utility item, mediator, fetish, tuner, and artwork [8]. The attitude of people to souvenirs is identical as to things in Löfgren's approach. People do not only look at them but also get addicted to them, use them, wear them, destroy them, repair them, get bored with them, discard them, sometimes to recover them at a later point [9].

A souvenir also expresses the wish to search for authenticity. This is not just about the reality of its appearance but also the authenticity of origin. Noga Collins-Kreiner, Yael Zins [10] point out that souvenirs which have not been purchased at a store or stall remind tourists of their travel. They are objects of idealized reality, substituting for places visited by the tourists during their trip. As research in Laos has shown that authentic souvenirs need to integrate culture and history to represent place identity of the destination, to be handmade, to have a unique, attractive presentation and to require local-specific skills of local artisans [11]. Criteria used by tourists from Midwestern US to define authenticity included craft uniqueness, workmanship, aesthetics and use, cultural and historical integrity, and genuineness; characteristics of the craftperson and the shopping experience also contributed to authenticity [12].

A recent study on souvenirs is a book edited by M. Hitchcock and K. Teague [13]. Authors begin from explanation of the concept of souvenirs and clarification of the essential conceptual framework in this regard. Simultaneously, they define this term in rather general, broad categories: "souvenirs, broadly conceived, are generally thought to be the material counterpart of travels, events, relationships and memories of all kind". Furthermore, they do not focus on physical aspects connected with objects of memory: "do not necessarily focus on material souvenirs in their memorial function as souvenirs". In the next subchapters of the study, they rather utilize case studies as an introduction to discussions of the meaning of souvenirs to those who bring them: "a key focus of many of these chapters, indeed of any discussion of souvenirs, is the question of meaning: what is the meaning of any particular souvenir or collection, and for whom does it bear the meaning?" They recapitulate the results of their discussion with an observation that "for the individual owner, the importance of the souvenir is the memorial link with some occasion, usually an occasion centring on a person or place. The meaning of a souvenir object may be more than just its souvenir function. The owner may value it for some other reason, e.g., home décor, monetary value, or class or status maker". They draw such conclusions based on analysis of experiences connected with acquisition of souvenir objects from destinations as diverse as Santiago de Compostela, the Japanese island of Hokkaido, or Kambot (Papua New Guinea). A completely different approach is represented by D. L. Hume in *Tourism Art and Souvenirs* [14]. Unlike the authors quoted before, D. L. Hume focuses on physical aspects of souvenirs, and specifically, broadly discusses the issues related to their artistic advantages: "this book examines the relationship between art and tourism through the study of the material culture of tourism: tourist art and souvenirs. It thoroughly examines how to categorise the material culture of tourism within the discourses of contemporary art and cultural anthropology, and demonstrates that tourist art is a unique expression of place and genuine artistic style".

The researches also investigated issues with regard to sustainable attitudes of young tourists. Han, Heesup; Kiatkowskin, Kiattipoom; Ryu, Hyungseo Bobby; Jung, Heekyoung; Kim, Wansoo [15] discovered that environmental values, concern, and awareness contribute to the generation of young vacationers' intention to engage in recycling and to conserve water, energy, and local resources at a destination. Heesup Han, Jongsik Yu, Hyeon-Cheol Kim, and Wansoo Kim [16] investigated the associations among social norms (descriptive and injunctive), willingness to sacrifice, and personal norm by developing a theoretical framework for young vacationers' waste reduction and recycling intentions. According to Heesup Han, Wansoo Kim, and Kiattipoom Kiatkawsin [17], greening is one of the most important issues faced by the tourism industry today. Their study developed a

conceptual framework involving biospheric value, environmental concern, environmental awareness, ascribed responsibility, and moral norm in order to better explain young travelers' pro-environmental decision-making process. Bo Meng, Hyungseo Bobby Ryu, Bee-Lia Chua, and Heesup Han [18] write that volunteer tourism (VT) is an emerging tourism paradigm especially for young tourists. Trust, attitude, and subjective norm played important roles in this sphere.

Despite the presence of books on souvenirs as such on the publishing market, there is a lack of studies strictly focused on so-called natural souvenirs. There are no studies dedicated strictly to natural souvenirs, i.e., those not purchased, but comprising a part of the landscape. Some vestigial information, e.g., on shell products as souvenirs, may be found not so much in literature on tourism as in literature connected with issues of ecology and environmental protection, such as the annual report: *Solomon Islands. Ecology, Nature Protection Laws and Regulations Handbook*, International Business Publications, Washington 2011. Therefore, it is necessary to fill the observed research gap. The authors devote the following chapters of the study to this subject matter.

Regardless of whether they are mass-produced commodities, goods manufactured elsewhere or local handicrafts, souvenirs are static objects, unable to intermediate or to generate co-created, active or absorbing experiences wanted by tourists. The development of additive production (3D printing) and open digital production devices create possibilities for customization, creativity, and prosumption, which could alter the consumption of souvenirs [19]. They could also eliminate the phenomenon of acquisition of natural souvenirs regarded as authentic and creative. Similarly, this phenomenon could be eliminated by appropriately supplied souvenir stores that should provide the customers with a unique, broad assortment of souvenirs [20]. In addition to the attributes of the souvenirs and attributes of the store, the kind of souvenirs brought is affected by motivations for travel. Therefore, the goal is to provide a pleasant and profitable sales environment, to the benefit of both the tourist and the economy [21].

### 3. Research Method

In the light of the previous discussion, a research problem emerges concerning whether the young generation of tourists has a tendency for aggravation or for mitigation of ecological, social, and economic problems caused by acquisition of natural souvenirs. From the scientific perspective, it is relevant not just to describe the phenomenon but, above all, to interpret it in the prognostic aspect (indication how the young generation to follow us will affect the state of unsustainability through their practices concerning natural souvenirs) and in the utilitarian aspect, i.e., explanation what benefits to the natural environment, society, and economy will be brought by elimination of this phenomenon.

Before proceeding with the research, the main goal and specific research goals were formulated. The main goal was to identify the existing trends with regard to bringing of natural souvenirs by the young generation of tourists in the aspect of sustainable development and sustainable tourism, and to determine on this basis how such practices may affect sustainable development. The specific goals were formulated as follows:

1. determination of the scale of the phenomenon of bringing of natural souvenirs by young tourists;
2. identification of motivations for bringing of natural souvenirs;
3. determination of what natural souvenirs are most preferably brought by young tourists from their trips;
4. determination of what happens to natural souvenirs after young tourists return to their place of residence;
5. collection of opinions concerning bringing of natural souvenirs, the lawfulness of such practices, and the environmental damage;
6. determination of the kinds of damages to the natural, social, and economic environment, resulting from acquisition of natural souvenirs;
7. determination of manners of elimination of hazards caused by acquisition of natural souvenirs.

Before proceeding with the survey, its project was developed. The first phase of the survey was the method of analysis and criticism of literature, which proved the purposefulness and originality of the examined research problems (bibliographic query, at-desk research). For the purpose of survey, a research tool in the form of a questionnaire was developed, the minimum sample size was determined, and the manner of communication with the respondents was specified. Having conducted the field study, its results were listed and analysed and conclusions were formulated.

Achievement of the determined research goal was possible thanks to a study conducted using a representational method, which had been considered the most proper form of partial research. Random selection of individuals enabled obtaining of a sample as similar as possible to the population. This procedure became a basis for estimation of population property based on sample property.

Four hundred and twenty-six people were subject to the survey process. Such a number of respondents meets the assumptions of a minimum sample size. The minimum sample size was determined in order to draw conclusions about the surveyed population, characterized by specific accuracy and degree of certainty, on the basis of the conducted measurements. When determining the necessary sample size, the following steps were taken:

- estimation accuracy was determined, assuming a specific maximum error of estimate;
- a high confidence level was assumed;
- assumptions concerning the proportion of the surveyed population were made.

Assuming that the success probability order of magnitude  $p$  is unknown, the minimum number of individuals was 385 at the following assumptions: significance level  $\alpha = 0.05$ , maximum error of estimate  $d = 5\%$  ( $u_\alpha = 1.959964$ ).

The survey was conducted among 426 persons. Since the bringing of natural souvenirs is inseparably connected with tourist trips, only those respondents who participate in tourist trips had to be selected from this group. In order to implement this task, the following question was included in the beginning of the questionnaire: *How often do you travel for tourist purposes?* There were answer variants: *several times per year, once per year, once per several years, I do not travel*. The analysis of answers to this question enabled people who do not travel as tourists, so they cannot bring any souvenirs, including natural ones, to be excluded from the further research. Six respondents (3 women and 3 men) turned out not to travel as tourists. Ultimately, the survey covered 420 people, i.e., only those who had participated in tourist trips. They included 291 women and 129 men. The research tool was a survey questionnaire. The survey form consisted of two parts. The first part contained questions aimed at solving the research problem regarding collecting natural souvenirs by young tourists. The questions included in the survey were both closed-response questions and open-response questions. It was important to make sure that the questionnaire met the researchers' expectations in terms of the information needed. Therefore, a questionnaire pretest was made. The second part of the questionnaire explained how old the respondent was and what gender he represented. The survey was anonymous. The respondents were contacted personally.

#### 4. Empirical Results

All participants of the survey had participated in tourist trips. The frequency of tourist trips of the surveyed group was as follows: 48.8% of respondents engage in tourist trips several times per year, 42.8% leave once per year, whereas 8.4% participate in tourist trips once per several years.

The survey has shown that most people (47.6%) engage in both domestic and foreign tourism; 43.1% of respondents focus exclusively on domestic tourism. Foreign tourism alone is preferred by 9.3% of the surveyed.

The further part of the study has explained the attitude of the respondents to bringing of souvenirs from tourist trips. 80.7% of tourists turned out to bring souvenirs from their trips. 19.3% of the surveyed do not do this.

The following three issues addressed in the study concerned the opinion on bringing of natural souvenirs, lawfulness of such practices or harmfulness thereof to local tourist attractions (Table 1). As shown in Table 1, only 9.8% respondents are opposed to bringing of natural souvenirs. Even fewer persons (5.2%) claim such practices are unlawful, whereas 11.2% recognize their harmful effect on local tourist attractions.

**Table 1.** Natural souvenirs in the opinion of young tourists.

Questions and Percentage Structure of Answers	
What is your opinion on bringing of natural souvenirs?	
I support such practices	19.0%
I partially support such practices	48.8%
I do not support such practices	9.8%
I have no opinion	22.4%
Is acquisition of natural souvenirs lawful?	
Certainly yes	10.7%
Depending on the kind of natural souvenir	71.2%
Certainly not	5.2%
I have no opinion	12.9%
Does acquisition of natural souvenirs by tourists cause any damage to local tourist attractions?	
Certainly yes	11.2%
Rather yes	30.0%
Rather not	36.7%
Certainly not	2.4%
I have no opinion	19.7%

Source: Own study.

Subsequently, the study focused on the tourists who bring souvenirs, asking them whether these souvenirs include natural ones, i.e., ones originating from local nature, urban or rural architecture (e.g., shells, stones, parts of buildings, beach sand, volcano rocks, plants, animals, etc.): 61.4% of those surveyed were found to bring natural souvenirs from their trips. On the other hand, 38.6% respondents do not do it.

The following issue concerned the share of natural souvenirs among all souvenirs brought by tourists. For the highest percentage of tourists (77.9%), they constitute a  $\frac{1}{4}$  of all souvenirs. A greater share, amounting to  $\frac{1}{2}$ , was confirmed by 16.3% of the respondents. Few people (2.9%) bring natural souvenirs only. An identical percentage (2.9%) is comprised by tourists whose share natural souvenirs in the total number of souvenirs; it is found to be lower than  $\frac{1}{4}$ .

Moreover, it should have been explained what kind of natural souvenirs were preferred and taken by young tourists. Therefore, they were asked a question: "What kinds of natural souvenirs are you particularly interested in and which ones do you bring the most?" The structure of answers to this question was shown in Figure 1. It demonstrates that most tourists bring shells (53.9%), stones (22.7%), and seaside beach sand (18.0%). Other kinds of natural souvenirs garnered less interest.

The motivation behind bringing natural souvenirs by young tourists are important as well. Figure 2 details the motivations and percentages of respondents who have invoked them. The sequence of major motivations for bringing of natural souvenirs is as follows: they are unique (26.2%); genuine (23.8%); bring back the best memories (22.6%); and cannot be bought at a store (14.5%).



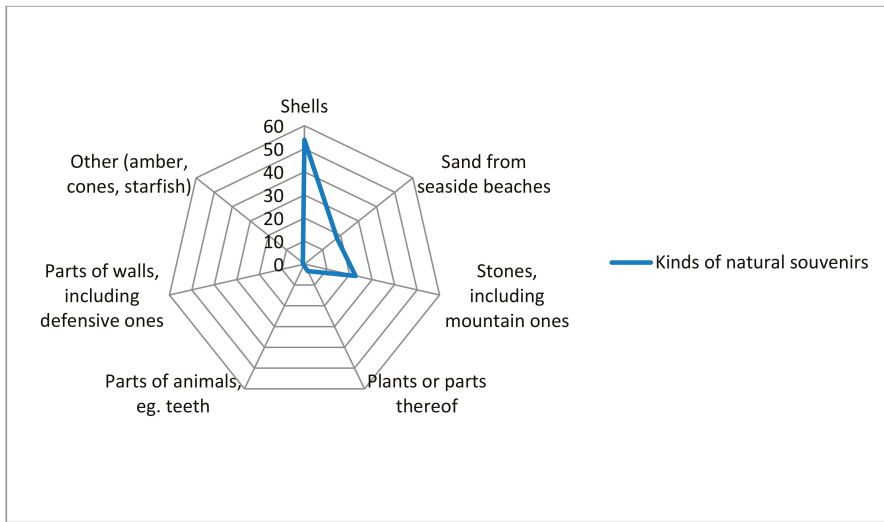

Figure 1. Kinds of natural souvenirs brought by tourists. Source: Own study.

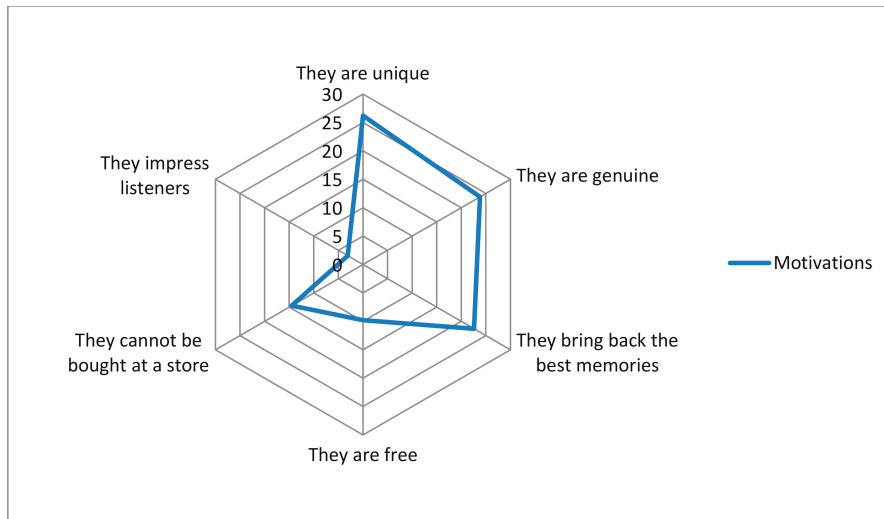

Figure 2. Reasons for bringing natural souvenirs. Source: Own study.

The final issue referred to the duration of storage of natural souvenirs. Most of the people surveyed (76.4%) keep them for very long (never discarding such objects). Some respondents (18.3%) discard natural souvenirs after several years. A small percentage does so after several months (3.4%) or weeks (1.9%).

### 5. Demarketing of Natural Souvenirs

The conducted research has shown that practices of acquisition and bringing of natural souvenirs are highly widespread among young tourists. Not only do they adversely affect the natural environment but they also cause dysfunctions in the social, cultural, and economic sphere. Therefore, curtailing of

acquisition of such souvenirs is very important from the viewpoint of sustainability. Demarketing may play an important role in this process.

Demarketing of natural souvenirs is intended to discourage tourists from purchasing them and from acquiring them directly from the environment in which they find themselves. Natural souvenirs constitute parts of the nature and man-made buildings, but they can also be purchased in different points of sale, located in tourist destinations. Examples include numerous souvenir shops and stalls in the Mediterranean region. A considerable part of their assortment of commodities offered for sale include maritime fauna and flora in the form of shells, starfishes, sponges, seahorses, and many other products.

Demarketing of natural souvenirs should mainly be based on emotional messages inciting the feeling of fear, as well as factual messages. The feeling of fear will be caused by messages indicating the following issues connected with acquisition and bringing of such souvenirs:

- (a) violation of the law and the related penalties;
- (b) hazards to life and health, which may be caused by bacteria, viruses, fungi, and parasites found on natural souvenirs; they cause numerous diseases the symptoms of which manifest themselves either in the tourist's destination country or upon returning home.

Moreover, people need to be discouraged from bringing and collecting natural souvenirs through use of factual messages. They include figures and facts illustrating the deteriorating condition of the natural environment as well as losses in the area of material heritage of mankind. Acquisition of natural souvenirs comprising parts of the fauna or flora means extinction of many animal and plant species, which may, over time, cause disruptions in the functioning of ecosystems and threaten the existence of humans. Misappropriation of even minor parts of historic ruins, walls, or structures deprives them of their historic construction material, thus causing devastation of cultural heritage the originality of which cannot be restored using modern materials.

Messages discouraging tourists from acquisition of natural souvenirs may be disseminated in the following places:

- (a) on websites and at offices of travel agencies;
- (b) in tourist guides and offer catalogues of travel agencies;
- (c) on websites and at offices of companies involved in booking of hotels and sale of tickets for different means of tourist transport, including airline tickets;
- (d) at tourist accommodation sites (hotels, motels, boarding houses, guest houses, hostels, camping sites);
- (e) in means of tourist transport (aeroplanes, coaches, trains);
- (f) at border crossings;
- (g) in media occupied with the subject matter of tourism (tourist magazines, tourist programmes, and channels on the television, radio shows, tourism in the Internet);
- (h) at tourist sightseeing or leisure sites (boards placed at beach entrances, mountain trails, historic structures).

Natural souvenir demarketing messages may take different forms, typical of press, television, radio, and online advertising, as well as outdoor and indoor.

Implementation of demarketing of natural souvenirs is difficult for several reasons. First is the natural character and uniqueness of such goods. Many tourists prefer natural souvenirs over products of questionable aesthetic and quality, mass-produced, made of plastic materials, that dominate the offer of souvenir shops and stalls. Another serious barrier reducing the efficiency of demarketing of natural souvenirs is the fact they can be acquired free of charge, as well as emotional connection with the place of stay.

Utilization of demarketing of natural souvenirs requires creation and dissemination of messages with different content and forms. Such undertakings should be financed from two main sources: from

the state budget as well as by owners of tourist attractions and leisure areas threatened by acquisition of natural souvenirs, since the goals of a state include protection of the natural environment and cultural heritage of the nation. On the other hand, it is in the interest of owners to maintain the value and attractiveness of leisure areas and historic objects managed by them.

## **6. Conclusions**

The goal of this study was to identify the existing tendencies concerning bringing of natural souvenirs by the young generation of tourists in relation to the idea of sustainable development and sustainable tourism, as well as motivation, later utilization, and the state of awareness of the young generation concerning the scope of damage young people cause in the natural, socio-cultural and economic environment through this practice. The study was intended to explain whether the generation to follow has a tendency to aggravate or to mitigate ecological, social, and economic problems caused by acquisition of such souvenirs. An additional goal of the article was to indicate the essence and basic measures in the area of demarketing of natural souvenirs, which may discourage tourists from collecting them to a large extent.

The performed study has demonstrated that the practices concerning acquisition and bringing of natural souvenirs are very widespread among young tourists. Of 80.7% tourists who bring souvenirs from their trips, more than 60% own natural souvenirs. Moreover, 67.8% of tourists support or partially support bringing of such souvenirs, and 39.1% claim that these souvenirs are rather or definitely not harmful to local tourist attractions. It is also worth paying attention to a considerable number of persons with no attitude to such issues as: the opinion on bringing of natural souvenirs (22.4%), the lawfulness of such practices (12.9%), and the damage such souvenirs bring (19.7%). The lack of opinion on these issues results from the unfamiliarity with legal regulations, as well as lack of or insufficient knowledge on the idea of sustainable development.

As the study has shown, the most popular among the brought natural souvenirs are shells (53.9%), followed by stones (22.7%), and sand from seaside beaches (18.0%). This means that the natural environment, rather than historic objects, suffers most due to acquisition of such souvenirs.

Most tourists (76.4%) keep their natural souvenirs for a very long time. However, even after a long time, regardless of their owner and place of storage, souvenirs always end up in landfills, causing other ecological problems.

The conducted research serves as a basis for formulation of final conclusions presented below:

- With regard to the natural environment, acquisition of natural souvenirs leads to depletion or even devastation thereof.
- With regard to the society, bringing of natural souvenirs also causes dysfunctions in the social sphere. Transport of such souvenirs from one end of the world to another also means transport of microorganisms or insects, which can lead to incidence and spread of diseases or, in extreme cases, to epidemics.
- In the cultural aspect, removal of parts of monuments of history, such as the Berlin Wall or azulejo tiles, causes losses in the material heritage of different countries.
- Taking of natural souvenirs also results in losses in the economic sphere of countries. The souvenir, crafts and manufacturing sector suffers losses. A loss is also caused to regions of tourist reception (places of stay of tourists) and tourist emission (places of origin of tourists). For instance, customs services can confiscate several tons of sand from tourists over one summer season. Constant depletion of sand necessitates replenishment, which is connected with financial outlays. On the other hand, costs of removal of natural souvenirs which are discarded and wasted over time are incurred in places of origin of tourists.
- In the ethical aspect, bringing of natural souvenirs constitutes a breach of the binding values, violation of the law, and of moral principles. Persons who bring natural souvenirs set a bad example to other tourists.

To stem such negative trends, it is worth utilizing demarketing, based on emotional and factual messages. They should be disseminated in places with which a tourist comes into contact during preparations for the travel and during the travel itself. They may take diverse forms typical of press, television, radio, and online advertising, as well as outdoor and indoor.

Discouragement of tourists from bringing of natural souvenirs is a very difficult task for governments, tourist organizations, and tourism organizers. As the study has demonstrated, the following motivations prompt tourists to bring such souvenirs: natural souvenirs are unique (26.2%), they are genuine (23.8%), and they bring back the best memories (22.6%). These are strong incentives, confirming the researchers' findings that a souvenir is connected with emotions and expresses the desire of search for authenticity. This is not just about the authenticity of appearance but also the authenticity of origin. Tourist also collect natural souvenirs because they are free. They do not have to be paid for, unlike souvenir products available at shops and stalls. Due to all of the above, many tourists may ignore appeals for abandonment of acquisition of natural souvenirs.

The present article examines the relevant and understudied subject matter of natural souvenirs in the aspects of sustainability, which is worth developing further by conducting research and discussions.

## **7. Discussion**

The subject matter examined in the article prompts discussion concerning various aspects of collection of natural souvenirs and the directions of further research. The first issue is the significance of the problem of collection of natural souvenirs in the aspect of sustainability. At first glance, this problem may seem unimportant, since every tourist usually acquires small amounts of natural souvenirs, so the resulting ecological, socio-cultural, and economic damage is not large. We believe such perception of the problem is wrong. In our opinion, the problem is significant because modern tourism is characterized by mass nature and global scale, so collection of natural souvenirs is becoming a mass phenomenon as well. As shown by the research, more than 60% of tourists are aged 21–30 collect natural souvenirs. If we assume that such souvenirs are brought by a similar percentage of tourists from other age groups, we surely face a mass phenomenon here. A small amount of souvenirs per one tourist, multiplied by millions of people, gives enormous amounts, which results in serious damage. Therefore, it is advisable to conduct research concerning the share of the remaining age groups in bringing of natural souvenirs, as well as quantitative estimation of the scale of this negative phenomenon.

The phenomenon of acquisition of natural souvenirs contributes to devastation of the natural environment, thus bearing the attributes of a pathology in tourism. It also causes damage of social, cultural, and economic nature. Therefore, collection of natural souvenirs hinders sustainable development. Further research should explain in more detail what damage in the social, cultural and economic aspect is caused by collection of natural souvenirs. The authors of the present article claim that bringing of natural souvenirs causes exclusively damage in these aspects. This is the following subject to be discussed.

The problem of elimination of the phenomenon of acquisition and bringing of natural souvenirs requires further detailed research and analysis. The discussion should be focused on such issues as: how to influence tourists to make them renounce bringing of natural souvenirs? Is tightening of the law sufficient for this purpose? If it is, how to enforce legal prohibitions in practice? What other extra-legal means and forms of influence can be applied to discourage people from bringing of natural souvenirs?

An important problem, requiring discussion and further research, is consideration of the phenomenon of collection of natural souvenirs in the aspect of cultural, social, and economic differences between nations. In the opinion of the authors, the behaviour of tourists depends on their origin, i.e., on the cultural, social, and economic conditioning in their country. Further research should explain whether cultural, social, and economic differences impact the quantity and kind of acquired natural souvenirs.

Conducting of discussions and continuation of the research concerning acquisition, collection, and discarding of natural souvenirs will enable better understanding of the phenomena occurring in

this area, including the behaviour of tourists. This will allow creation of increasingly sophisticated solutions for the purpose of limitation and, over time, complete elimination of such practices.

**Author Contributions:** Conceptualization, A.P. (Arnold Pabian); methodology, A.P. (Arnold Pabian); validation, A.P. (Arnold Pabian); formal analysis, A.P. (Arnold Pabian); investigation, A.P. (Aleksander Pabian); resources, A.P. (Arnold Pabian); data curation, A.P. (Aleksander Pabian); writing—original draft preparation, A.P. (Aleksander Pabian); writing—review and editing, A.P. (Aleksander Pabian) and A.B.; visualization, A.B.; supervision, A.P. (Arnold Pabian); project administration, A.B.; funding acquisition, A.P. (Arnold Pabian). All authors have read and agreed to the published version of the manuscript.

**Funding:** This research received no external funding.

**Conflicts of Interest:** The authors declare no conflicts of interest.

## References

1. Rapczyńska, I. Bricks, Teeth and Barbed Wire, or Unusual Holiday Souvenirs. 2016. Available online: <https://turystyka.wp.pl/cegly-zyby-i-drut-kolczasty-czyli-nietypowe-pamiatki-z-wakacji-6044419818861185a?ticaid=117b1d> (accessed on 20 February 2018).
2. Swanson, K.K.; Timothy, D.J. Souvenirs: Icons of Meaning, Commercialization and Commoditization. *Tour. Manag.* **2012**, *33*, 489–499. [[CrossRef](#)]
3. Gordon, B. The Souvenir: Messenger of the Extraordinary. *J. Pop. Cult.* **1986**, *20*, 135–146. [[CrossRef](#)]
4. Brennan, L.; Savage, T. Cultural Consumption and Souvenirs: An ethical framework. *Arts Mark. Int. J.* **2012**, *2*, 144–160. [[CrossRef](#)]
5. Wilkins, H. Souvenirs: What and Why We Buy. *J. Travel Res.* **2010**, *50*, 239–247. [[CrossRef](#)]
6. Paraskevaidis, P.; Andriotis, K. Values of souvenirs as commodities. *Tour. Manag.* **2015**, *48*, 1–10. [[CrossRef](#)]
7. Shtudiner, Z.; Klein, G.; Zwiling, M.; Kantor, J. The value of souvenirs: Endowment effect and religion. *Ann. Tour. Res.* **2019**, *74*, 17–32. [[CrossRef](#)]
8. Haldrup, M. Souvenirs: Magical objects in everyday life. *Emot. Space Soc.* **2017**, *22*, 52–60. [[CrossRef](#)]
9. Löfgren, O. Scenes from a Troubled Marriage: Swedish Ethnology and Material Culture Studies. *J. Mater. Cult.* **1997**, *2*, 95–113. [[CrossRef](#)]
10. Collins-Kreiner, N.; Yael, Z. Tourists and Souvenirs: Changes through Time, Space and Meaning. *J. Herit. Tour.* **2011**, *6*, 17–27. [[CrossRef](#)]
11. Soukhathammavong, B.; Park, E. The authentic souvenir: What does it mean to souvenir suppliers in the heritage destination. *Tour. Manag.* **2019**, *72*, 105–116. [[CrossRef](#)]
12. Littrell, M.A.; Anderson, L.F.; Brown, P.J. What makes a craft souvenir authentic? *Ann. Tour. Res.* **1993**, *20*, 197–215. [[CrossRef](#)]
13. Hitchcock, M.; Teague, K. *Souvenirs: The Material Culture of Tourism*; Routledge: Oxon, UK; New York, NY, USA, 2019.
14. Hume, D.L. *Tourism Art and Souvenirs*; Routledge: New York, NY, USA; London, UK, 2014.
15. Han, H.; Kiatkowskin, K.; Ryu, H.B.; Jung, H.; Kim, W. Determinants of young vacationers' recycling and conservation behavior when traveling. *Soc. Behav. Personal. Int. J.* **2019**, *47*, 1–11. [[CrossRef](#)]
16. Han, H.; Yu, J.; Kim, H.-C.; Kim, W. Impact of social/personal norms and willingness to sacrifice on young vacationers' pro-environmental intentions for waste reduction and recycling. *J. Sustain. Tour.* **2018**, *26*, 2117–2133. [[CrossRef](#)]
17. Han, H.; Kim, W.; Kiatkawsin, K. Emerging youth tourism: Fostering young travelers' conservation intentions. *J. Travel Tour. Mark.* **2017**, *34*, 905–918. [[CrossRef](#)]
18. Bo, M.; Ryu, H.B.; Chua, B.-L.; Han, H. Predictors of intention for continuing volunteer tourism activities among young tourists. *Asia Pac. J. Tour. Res.* **2020**, *25*, 261–273.
19. Anastasiadou, C.; Vetesse, S. From souvenirs to 3D printed souvenirs. Exploring the capabilities of additive manufacturing technologies in (re) framing tourist souvenirs. *Tour. Manag.* **2019**, *71*, 428–442. [[CrossRef](#)]

20. Sthapit, E. The more the merrier: Souvenir shopping, the absence of choice overload and preferred attributes. *Tour. Manag. Perspect.* **2018**, *26*, 126–134. [[CrossRef](#)]
21. Swanson, K.K.; Horridge, P.E. Travel motivations as souvenir purchase indicators. *Tour. Manag.* **2006**, *27*, 671–683. [[CrossRef](#)]



© 2020 by the authors. Licensee MDPI, Basel, Switzerland. This article is an open access article distributed under the terms and conditions of the Creative Commons Attribution (CC BY) license (<http://creativecommons.org/licenses/by/4.0/>).

Article

# Social Expectations and Market Changes in the Context of Developing the Industry 4.0 Concept

Sebastian Saniuk <sup>1,\*</sup>, Sandra Grabowska <sup>2,\*</sup> and Bożena Gajdzik <sup>3</sup>

<sup>1</sup> Department of Engineering Management and Logistics Systems, University of Zielona Góra, 65-417 Zielona Góra, Poland

<sup>2</sup> Department of Production Engineering, Silesian University of Technology, 40-019 Katowice, Poland

<sup>3</sup> Department of Industrial Informatics, Silesian University of Technology, 40-019 Katowice, Poland; bozena.gajdzik@polsl.pl

\* Correspondence: s.saniuk@wez.uz.zgora.pl (S.S.); sandra.grabowska@polsl.pl (S.G.); Tel.: +48-32-6034341 (S.G.)

Received: 14 January 2020; Accepted: 11 February 2020; Published: 13 February 2020

**Abstract:** There are more and more talks in the community of scientists and business practitioners about new challenges for industry in connection with the fourth industrial revolution. Industry 4.0 is the result of the development of cyber-physical generation systems as part of the fourth industrial revolution. Industry 4.0 sets new areas of change in the sphere of production and management but also exerts an impact on various aspects of society's life. It is a transformational challenge for enterprises of the present age. Industry 4.0 is present in economic studies at the macroeconomic level and business at the microeconomic level. Scientists discuss the essence of change, and specialized research centers and consulting companies carry out research on various aspects of this industrial revolution. The article presents the range of expectations and changes in society towards the development of the concept of Industry 4.0. The work was based on a literature study and direct research in the field of social change in the Industry 4.0 era. The aim of the article is to identify social expectations of development changes related to the implementation of the Industry 4.0 concept. The article devotes a lot of attention to customization because it is one of the keys of Industry 4.0, leading to a change of the paradigm from mass production to personalized production. This simple change will affect customers, producers, and employees. Based on the synthesis of literature and secondary research, authors identify opportunities and threats to the broadly understood society functioning in the Industry 4.0 environment. Social conditions were analyzed from the point of view of the consumer, producer, and employee. In the cited direct studies, the basic area of analysis was product personalization and pre-recognition of the opinions of potential consumers about customization in Industry 4.0. The limitation of the research area to the consumer segment resulted from the importance of product personalization in Industry 4.0 and its impact on producer behavior and effects for employees.

**Keywords:** Industry 4.0; customization; smart factory; expectations of modern consumers; customer and producer challenges

---

## 1. Introduction

Along with economic and social changes resulting from technical progress, new levels of civilization develop. If the extent of the change is radical, then there is talk of a revolution. In the case of industrial development, four industrial revolutions were recorded. The latter, the Fourth Industrial Revolution, results in a strong connection between two worlds: Real (physical) and virtual (IT) in Cyber Physical Systems (CPS). The new industry concept, referred to as Industry 4.0, means the integration of IT devices and solutions in production processes that are designed to increase production efficiency and increase production flexibility [1–4].

The concept of Industry 4.0 was initiated in Germany in 2011. Its essence lies in the combination of a real and virtual work organization system as well as networking and integration of people with digitally controlled intelligent machines that make extensive use of the Internet and information technology. Production is characterized by automation, computerization, and robotization. All devices in the technological line communicate with each other, creating an intelligent production system [5–8]. The production technique implemented using computers and microelectronics was already implemented in the second half of the 20th century, but Industry 4.0 is about increasing the share of industrial robots and manipulators in the manufacture of products using the Internet to control devices in integrated processes inside and outside the enterprise within the supply chain. This creates new opportunities for the development of the economy and modern society [9,10].

A paradigm Industry 4.0 will be a step forward towards more sustainable industrial value creation. In the current literature, this step is mainly characterized as a contribution to the environmental dimension of sustainability. The allocation of resources, i.e., products, materials, energy, and water, can be realized in a more efficient way on the basis of intelligent cross-linked value creation modules. Besides these environmental contributions, Industry 4.0 holds a great opportunity for realizing sustainable industrial value creation on all three sustainability dimensions: Economic, social, and environmental [11].

There are more and more economic initiatives related to Industry 4.0. The popularization of Industry 4.0 results in changes in many areas of society and economy. The scope of changes is very wide and it is impossible to list them all and even fully identify them. In light of the changes taking place, the question arises: What are the social expectations of the Fourth Industrial Revolution? Selected expectations from the perspectives of: customers and consumers of products, producers and employees in relation to the environment of Industry 4.0 constitute the content of this publication [12–16]. The article is of a review nature and undertakes considerations in the scope of characterization and assessment of the approach, which is flexible production focused on customization, as well as indicating directions of evaluation of expectations of producers, employees, and consumers. To this end, the literature on the subject was analyzed, and case studies, as well as the results of surveys carried out, were used.

## **2. Review of the Subject Literature**

### *2.1. Industry 4.0 Pillars Set*

Industry 4.0 means the integration of intelligent machines and systems and the introduction of changes in production processes aimed at increasing production efficiency and introducing the possibility of flexible changes in the range. Industry 4.0 is not only about technology, but also about new ways of working and the role of people in Industry [17–19].

Industry 4.0 is another technological leap, using the potential of connected machines and devices via the Internet [20–23]. Industry 4.0 is the subset of the fourth industrial revolution that concerns the industry. The term “Industry 4.0”, shortened to I4.0 or simply I4, originated in 2011 from a project in the high-tech strategy of the German government, which promotes the computerization of manufacturing [24–27]. The project of changes created in Germany was aimed at preparing the German industry for smart production. The changes are characterized by strong individualization of products in the conditions of very flexible production [28–31]. Customers and business partners are directly involved in business processes and value creation. Production is combined with high quality services. In the future, thanks to intelligent monitoring and decision making processes, companies and entire networks should be able to control and optimize their operations almost in real time [32–34].

In essence, Industry 4.0 is the trend towards automation and data exchange in manufacturing technologies and processes, which include Cyber Physical Systems (CPS), the Internet of Things (IoT), Industrial Internet of Things (IIOT), Cloud Computing, Cognitive Computing, and Artificial Intelligence Recommendations for implementing the strategic initiative Industry 4.0: Final report of



the Industry 4.0. Also known as SMART manufacturing or Manufacturing 4.0, Industry 4.0 is marked by a shift toward a physical-to-digital-to-physical connection [35–39].

There are several basic pillars of Industry 4.0. Individual authors of scientific publications, consultants, advisors, employees of scientific institutes, and consulting companies specify various systems of features describing Industry 4.0 [40–43]. In order to avoid duplication of information already contained in many available publications, the basic pillars of Industry 4.0 have been compiled and presented in Table 1. The compilation was based on searching for information using a web browser (Google) with the password: “Pillars of Industry 4.0”. Also used was a list of keywords for Industry 4.0 prepared by the Hermann team, which at the beginning of 2015 analyzed 51 publications [44]. The results from this study were IoT, smart factory, IoS, smart product, M2M, Big Data, and Cloud Computing. The basic pillars of Industry 4.0 were Smart Solutions, Smart Innovations, Smart Supply Chain, and Smart Factory. Smart Solutions is constituted of Smart Products and Smart Services [45]. A further search of databases resulted in the repeatability of nine pillars of Industry 4.0 proposed by Boston CG (selected scientific publications are listed in Table 1). The basic pillars according to BCG include [46]:

1. Big Data and Big Data Analytics,
2. Augmented Reality,
3. Printing 3D,
4. Cloud Computing,
5. Cyber Security,
6. Autonomous Robots,
7. Simulation,
8. Horizontal/Vertical Software Integration,
9. IoT.

**Table 1.** Pillars of Industry 4.0.

Source	Pillars of I 4.0	Accessed
Pillars identified in scientific works		
G. Erboz	<ul style="list-style-type: none"> <li>• Cyber-Physical Systems</li> <li>• IoT</li> <li>• Cloud Computing</li> <li>• Cognitive Computing</li> </ul>	<a href="https://www.researchgate.net/publication/326557388_How_To_Define_Industry_40_Main_Pillars_Of_Industry_40">https://www.researchgate.net/publication/326557388_How_To_Define_Industry_40_Main_Pillars_Of_Industry_40</a>
D. Burrell	<ul style="list-style-type: none"> <li>• IoT</li> <li>• Big Data</li> <li>• Cloud Computing</li> <li>• Advanced Simulation</li> <li>• Autonomous Systems</li> <li>• Universal Integration</li> <li>• Augmented Reality</li> <li>• Additive Manufacture</li> <li>• Cyber Security</li> </ul>	<a href="https://www.plextek.com/insights/insights-insights/industry-4-0-and-the-9-pillars/">https://www.plextek.com/insights/insights-insights/industry-4-0-and-the-9-pillars/</a>
C. Senn	<ul style="list-style-type: none"> <li>• IoT</li> <li>• Augmented Reality (Safety Training by using AR, Streamlined Logistics, Maintenance by using AR)</li> <li>• Simulation</li> <li>• Additive Manufacture (Design 3D, Prototyping: 3D, Low-Volume Production)</li> <li>• System Integration</li> <li>• Cloud Computing</li> <li>• Autonomous System</li> <li>• Cyber Security</li> <li>• Big Data Analytics</li> </ul>	<a href="https://www.idashboards.com/blog/2019/07/31/the-pillars-of-industry-4-0/">https://www.idashboards.com/blog/2019/07/31/the-pillars-of-industry-4-0/</a>

Table 1. Cont.

H. Fatorachian and H. Kazemi	<ul style="list-style-type: none"> <li>• Industrial Internet</li> <li>• IoT</li> <li>• CPSs</li> <li>• Information Network</li> <li>• Software Systems</li> <li>• Cloud Computing and Big Data Analytics</li> </ul>	Online: Taylor and Francis (11 January 2019)
V. Pilloni	<ul style="list-style-type: none"> <li>• Internet and new industrial technology</li> <li>• Machine-to-Machine Communication</li> <li>• Big Data and Advanced Analytics</li> </ul>	<a href="http://www.mdpi.com/journal/futureinternet">www.mdpi.com/journal/futureinternet</a>
K. Santos et al.	<ul style="list-style-type: none"> <li>• Smart Solutions,</li> <li>• Smart Innovations,</li> <li>• Smart Supply Chain</li> <li>• Smart Factory</li> <li>• Smart Products</li> <li>• Smart Services</li> </ul>	Procedia Manufacturing 11 (2017) 1358–1365
<b>Pillars identified in industrial reports</b>		
BCG	<ul style="list-style-type: none"> <li>• Big data and Big Data Analytics</li> <li>• Augmented reality</li> <li>• Printing 3D</li> <li>• Cloud computing,</li> <li>• Cyber Security</li> <li>• autonomous robots</li> <li>• Simulation</li> <li>• horizontal/vertical software integration</li> <li>• IoT</li> </ul>	<a href="https://napedzamyprzyszosc.pl/files/Zeszyt_10_PL.PDF">https://napedzamyprzyszosc.pl/files/Zeszyt_10_PL.PDF</a>
Booth Welsh	<ul style="list-style-type: none"> <li>• IoT</li> <li>• Systems Integration</li> <li>• Simulation</li> <li>• Augmented Reality</li> <li>• Big Data</li> <li>• Additive Manufacture</li> <li>• Autonomous System</li> <li>• Cloud computing</li> <li>• Cyber Security</li> </ul>	<a href="https://boothwelsh.co.uk/defining-pillars-industry-4-0/">https://boothwelsh.co.uk/defining-pillars-industry-4-0/</a>
Deloitte	<ul style="list-style-type: none"> <li>• Industrial Internet</li> <li>• Connected Enterprise</li> <li>• Smart Manufacturing</li> <li>• Smart Factory</li> <li>• Manufacturing 4.0</li> <li>• Internet of Everything</li> <li>• Internet of Things for Manufacturing</li> </ul>	<a href="https://www2.deloitte.com/content/dam/insights/us/articles/manufacturing-ecosystems-exploring-world-connected-enterprises/DUP_2898_Industry4.0ManufacturingEcosystems.pdf">https://www2.deloitte.com/content/dam/insights/us/articles/manufacturing-ecosystems-exploring-world-connected-enterprises/DUP_2898_Industry4.0ManufacturingEcosystems.pdf</a>

The pillars of Industry 4.0 listed in Table 1 interpenetrate each other and enter into logical interactions that will be controlled by artificial intelligence in the long run. The common denominator of the above solutions is “digital”, which is the foundation for the development of Industry 4.0. The Internet itself has acquired two meanings. In a narrow sense, it is about the Internet with social networks and applications on mobile devices. In a broad sense, it is about the role of the Internet in creating new opportunities for producers, employees, and customers [47–51]. There are customers, producers, competitors, and suppliers in the network, and their cooperation creates a global space of possibilities. The changes are all-encompassing across various areas of cooperation and are unlimited in time and space [52–55].

## 2.2. Industry 4.0 from the Perspective of: Customer, Producer and Employee

The Fourth Industrial Revolution refers to the production and demand; that is, of how customers and consumers enjoy the products and how they are involved in their creation. The development of Industry 4.0 technology opens new opportunities for customers who overcome time and space constraints, which may result in a decrease in internal demand in consumption and an increase in external demand. In individual product markets, technological changes take place at different rates and depend on the product life cycle. In sectors such as energy and metallurgy, where the life cycle of devices counts in decades, changes are slower than in the sector of everyday goods and services (clothing, shoes, cars, household appliances, electronics) [56–60].

Companies that are becoming digital (Boeing, General Electric, Adidas) are growing dynamically, deepening the distance of efficiency and earnings between them and companies still existing in the “analogous reality”. In turn, the companies that offered innovative solutions become benchmarks for other companies. Examples include:

- Uber-drivers providing passenger transport services do not belong to the traditional group of taxi drivers,
- Adidas-Salomon with intelligent footwear that has a built-in computer and is created for an individual customer,
- H&M network, based on information collected in the cloud about the tastes and behavior of its customers, designing entire collections for specific customer,
- BMW Individual Manufactory offering its customers a car configuration up to the third power, without any restrictions. The BMW Individual Manufactory is a factory enabling its customers to realize their own car fantasies.

The aspirations and aspirations of enterprises in shaping the field of their market activity in the environment of Industry 4.0 are manifested in the creation of highly personalized products. The results achieved in this field are to be determined by the customer’s involvement at the product manufacturing stage (the shapes and dimensions of typical product components are modified and changed to meet the specific needs of a specific customer), as well as through standardized customization, where the customer is involved at the product distribution or assembly stage [61–65]. This enhances the scope of changes in the functioning of product manufacturers, manifesting itself, among others, in the forms of design, ordering, communication, sale of products, and the way they are delivered. In the era of Industry 4.0, mass customization of products and services is to become more beneficial than mass production. The changes introduced in the production processes are to enable the implementation of activities in the design and manufacture of the product initiated by the customer [48,61–68].

However, the new reality raises many questions of strategic importance for customers, producers, and employees. To respond to new challenges, a bibliometric analysis of publications included in the Web of Science, Google Scholar, and other publicly available sources was performed. The obtained publications were selected by searching their content in terms of customization, social responsibility, sustainable development, problems or concerns of consumers, producers, and employees in view of changes in the perspective of developing the concept of industry 4.0. Industrial reports (consulting companies) PWC [15], ASTOR [69], Deloitte [70], and McKinsey [39] dominate in this category. Creating a list of opportunities and threats, scientific publications were also used: Fatorachian H., Kazemi H. [71]; Kagermann H., et al. [72]; Helo P., Hao Y. [73]; Öberg C., Graham G. [74]; Hu B., Kostamis D. [75]; Chen Y. J., Deng M. [76]; Lang M., et al. [77]; Shamsuzzoha A., et al. [78]; Bechtold, J., et al. [79]; Li F., et al. [80]; Brecher C., et al. [81]; Zhong R. Y., et al. [82]; Brettel M., et al. [36]; Brousell D. R., et al. [83]; Schmidt R., et al. [84]. Based on reports and publications, the authors created their own list of key questions about Industry 4.0 from the perspective of the customer/consumer, producer, and employees (Table 2). On the other hand, Table 3, on the basis of reports and publications of other authors, lists the opportunities and threats in relation to the examined segments. The three-segment system is our own study.

An example list of questions was developed by the authors of this publication and summarized in Table 2.

**Table 2.** The list of question about Industry 4.0.

<b>Customer</b>	
How to do	How to directly communicate, trade, exchange goods and services without system, communication, logistics or language barriers on a large scale in Industry 4.0?
About cooperation	Do you want to resign from owning the resources only for personal use for paid sharing? What resources are available for personal use only to be used for paid sharing (car, room in the apartment, capital or time)? Do I have the appropriate competences and skills to share resources in accordance with the principles of sharing economy?
About model of life	What mobile devices should equip your work and life environment? How do you balance life and high technology? Will big data and artificial intelligence analytics that examine our consumption, communication, nutrition or health behaviors and habits, and guess our needs, suggest the right solutions for us? How to buy and use products to be responsible towards the world/planet?
About cyber security	How to be secure online without restrictions? Will autonomous devices, e.g., cars, take us safely to where we want to, or will they guarantee us safety and fulfillment of goals/tasks?
<b>Producer</b>	
About customer and demand	What are the new (personalized) customer expectations? What needs of an increasingly demanding customer will develop in the future? How to identify them, how to satisfy them? How will production on demand change consumer behavior? How to reach the customer when he needs it? To what extent will consumer preferences affect the demand for manufactured products? Will automated factories using artificial intelligence anticipate customers' needs well? Which elements of the offer should be personalized and which in the same offer should be customized? To what extent should the company implement personalization and should it be played at individual, segment level or between them?
About flexibility business	Does business, by offering new solutions, provide consumers with the opportunity to personalize products and services? Is the leading party in production the consumer and his behavior discovered through Big Data and data analytics? How does business tolerate digitization? By reducing production line control, will manufacturers provide what customers need at the right time? How to build an effective production system enabling cooperation of millions of consumers creating products and services in the model of direct consumer-to-consumer interaction?
About business model	How should a company from country A "digital company" cooperate with company country B "analogue company"? How do new business models - based on digital platforms and integrating with real business - affect competition?
About market and regulations	How to regulate markets so as not to interrupt development? How to accelerate the transformation of business models? What challenges does digitization pose to regulators in terms of safety and consumer protection against the unfair competition? How ethical is it to use information about you and track your online activity? How to ensure safe and socially beneficial long-term development during a period of radical changes? How to design dynamic pre-emptive regulations that allow you to scale new business models?
<b>Employee</b>	
About employment reduction	Will Industry 4.0 change the employment structure/will low-skilled employees be needed?
About new jobs	Will artificial intelligence completely eliminate a person from the workplace?
About education	What technical competencies are required in cooperation with the new technology?
About work place	Does the existing education system in your country allow you to acquire new qualifications required in Industry 4.0?

Like any change, changes in the pursuit of societies and economies up to level 4.0 favor the emergence of opportunities and threats. Based on the publications: Fatorachian H., Kazemi H [71]; Helo P., Hao Y. [73]; Wamba S. F., et al. [7] and other the industrial reports: BCG [46], PWC [85], ASTOR [69], Deloitte [70], McKinsey [49].

The opportunities and threats were compared in a three-segment system: customer-producer-employee and presented in Table 3.

Tables 2 and 3 summarize the many opportunities, threats, questions, and concerns that are the voice of business representatives and customers. Emerging opportunities, however, are to lead to the creation of modern factories (Smart Factory), in which it is possible to flexibly produce increasingly shorter product series, implemented under a specific personalized customer order in a one-piece-flow arrangement [86–89]; where customers get broad access to the Internet of Things (IoT) and activities related to information processing and creating a virtual version of the product ordered at his request. The recipient of the product can view and check it in the virtual world before making the final purchase, avoiding (or minimizing the risk) the same purchase of the unnecessary product, which becomes a dangerous waste for the environment [90–93].

**Table 3.** Opportunities and threats for customer/consumer–producer–employee in Industry 4.0.

	Opportunities	Threats
<b>Customer</b>	<ul style="list-style-type: none"> <li>- Personalized satisfaction of consumption needs individualization manufacturing processes (generation of high-quality and highly customized products),</li> <li>- Including individual customer-specific criteria in the process of production,</li> <li>- Rapid transferring of customer requirements into production processes,</li> <li>- Individual, customer-specific criteria will be included in the design, configuration, ordering, planning, manufacturing and operation phases, also incorporating last-minute changes, indeed enabling mass customization to be implemented,</li> <li>- A sense of uniqueness from the process of purchasing a co-designed product,</li> <li>- Enabling high level of flexibility,</li> <li>- Higher usability of personalized products (best-suited product) Enabling last-minute changes into the production process,</li> <li>- Enabling last-minute changes into the production process,</li> <li>- The possibility of additional earnings by renting free resources, e.g., cars, designer clothing,</li> <li>- Being a socially responsible consumer.</li> </ul>	<ul style="list-style-type: none"> <li>- Increase in external demand by increasing the competitive advantage of foreign solution providers I 4.0,</li> <li>- Uncontrolled disclosure of preferences by the customer may threaten his anonymity,</li> <li>- Crossing the border between sales persuasion and surveillance,</li> <li>- Customization may make it difficult for the customer to make a purchase decision (because companies compete with each other in the scope of the offer, hence the selection of a specific product may be difficult),</li> <li>- The customer may not see his needs, which will not generate demand,</li> <li>- The need to overcome hardware and language barriers in new communication systems and ordering products,</li> <li>- The customer may feel cornered by receiving continuous information about products as part of marketing one to one.</li> </ul>

Table 3. Cont.

	Opportunities	Threats
<b>Producer</b>	<ul style="list-style-type: none"> <li>- Creating new products with high added value,</li> <li>- Dynamic and flexible configuration of various elements of business processes,</li> <li>- Accurate responding to the needs of consumers due to product design for individual orders and shortening of production series,</li> <li>- Creation of agile engineering and manufacturing processes,</li> <li>- On time verification of design decisions and quick incorporation of decisions into engineering and production processes,</li> <li>- Easy access to real-time information and effective cooperation between different machinery and manufacturing systems</li> <li>- Monitoring operations in real time and improved information sharing and collaboration,</li> <li>- Increase in productivity by shortening the production time of products, a decrease in equipment failure rate, limitation of product storage, etc. (improved resource productivity—the lowest amount of resources will be used to produce the highest volume of products, while minimizing emissions),</li> <li>- Continuous optimization of manufacturing processes and production systems, creating cost effective measurement systems and performance management tools, automation of environmental control tools,</li> <li>- Improved responsiveness and decision-making (enabling proactive approach towards problem solving), improved performance and production quality, improved product development,</li> <li>- Improved integration and collaboration,</li> <li>- A decrease in labor costs with a significant reduction in employment.</li> </ul>	<ul style="list-style-type: none"> <li>- High costs of new investments and an increase in production costs (at Adidas costs increased by up to 30% compared to standard production),</li> <li>- Loss of existing outlets (companies do not gain by adaptation of mass customization because it reduces product differentiation in a competitive context),</li> <li>- Loss of control over autonomous factories and loss of control over business information in Cyber Space,</li> <li>- The need to identify products, e.g., in block chain,</li> <li>- The need to search for new cooperation opportunities in cyber networks—entering into new strategic alliances, agreements, and other forms of cooperation,</li> <li>- The increased level of integration and data exchange will lead to an increase in the complexity of business processes,</li> <li>- Difficulties in maintaining a balance between business and life, between high technology and life,</li> <li>- Customer expectations are constantly rising (the customer’s own designed product model may not be implemented due to the high level of unreality of its features in relation to the possibilities of producers),</li> <li>- The need to reduce employs along with full automation and robotization of production lines (additional social costs may appear on companies dismissing employees),</li> <li>- A significant increase in remuneration for employees with unique competencies.</li> <li>- A large gap in knowledge of sustainable development models in Industry 4.0.</li> </ul>

Table 3. Cont.

	Opportunities	Threats
Employee	<ul style="list-style-type: none"> <li>- Possibility to improve work and life balance through remote work,</li> <li>- The new flexibility will enable more flexible work organization models, which will gradually meet the growing need of employees to strike a better balance between their work and private lives,</li> <li>- New opportunities to train and acquire new skills and new knowledge,</li> <li>- New jobs with high added value focused around automation, IT and human-machine interfaces,</li> <li>- Improvement of work safety (resignation from work in conditions harmful to employees' health, dangerous work will be done by devices/machines/robots),</li> <li>- Overcoming barriers to the physical accessibility of an employee simultaneously in many places through the possibility of providing work at a distance (virtual work).</li> </ul>	<ul style="list-style-type: none"> <li>- Risk of losing a job (especially in the case of performing physical work or not requiring many operations—simple operation of devices),</li> <li>- Risk of inadequate adjustment of employees' qualifications to new jobs due to lack of access to new forms and directions of education,</li> <li>- Temporary employment forms for the duration of projects, intensification of employment in the systems: virtual work, teleworking, etc. Which, in turn, can lead to loosening of the bonds in the employer-employee system,</li> <li>- strong polarization of workplaces, manifesting itself in an almost complete elimination of positions requiring a medium level of competence (machine operators, maintenance).</li> </ul>

Some threats, such as consumer safety in cyberspace, are still under investigation [94]. The progress of computer technology and the development of the Internet, as well as the vitalization of life, are conducive to the emergence of many threats related to data loss and privacy. Industry 4.0 is characterized by the ease of obtaining information. Each consumer wants to receive information quickly but also does not want all information about him to be publicly available (without his informed consent) [95]. In the new cyber reality created, technological and spatial barriers in circulation, processing, documenting (archiving) and access to information have been broken. IoT and IoS with a blockchain system is not only access to information, but it is also more than just entering information into everyday life for 24 h [96]. In relation to the market, wide access to information gives customers the opportunity to quickly choose a product, and even participate in its creation (customization); on the other, it creates new opportunities to manipulate the expectations of the customer and other market participants [97].

Industry 4.0 with flexible production systems is expected to change the operating conditions of societies that are better at dealing with cyber technology and are very aware of their needs and expectations. Implemented cyber technological solutions (remote robots) for production change the employment structure [98,99]. Low-skilled occupations disappear on the labor market, and new ones with special skills of cooperation with robots appear, e.g., robot coacher. In the coming years (2–3 years), the group of candidates for whom there is demand mainly includes people with experience in implementing and/or managing systems based on Industry 4.0 pillars [14,24,47,61,85].

### 3. Research Methods

The main goal of the research was to identify opportunities and threats to the wider society in the Industry 4.0—with particular emphasis on customization, which initiates many changes in the functioning of the market (including changes for producers and employees). The three-segment system adopted in the literature part was limited to the consumer segment in the study. To achieve this goal, the literature synthesis and survey methods 'Industry 4.0—perception and expectations' were used. Selected research results carried out by the authors in 2019 are presented.



The study was conducted using the CAWI method (standardized computer-based internet interview). The research tool was a questionnaire consisting of 25 questions (closed, complex, filtering, conditional, and tabular). The survey questionnaire consisted of 3 parts and specifications. The first part contained questions in the field of customization, the second part regarded concerns about the implementation of the concept of Industry 4.0 in Poland, while the third part—the benefits of Industry 4.0. The questionnaire was validated, and a pilot study was conducted among 15 experts with knowledge of Industry 4.0. The questionnaire was corrected for their comments. The respondents were potential customers representing the Silesian, Lower Silesia, Greater Poland, and Lubuskie voivodships, so it can be assumed that it was an infinite population.

Assuming a confidence level of 0.99 and an error of 10%, it was determined that the minimum size of the general population should be 166 customers. Therefore, the information contained in the surveys received can be treated as representative—504 opinions were obtained.

Most customers came from large and medium-sized cities (59%). It is worth noting that the majority of respondents assessed their financial situation as good (64.1%) and sufficient (23.24%). About 13.9% of respondents declared a very good financial (material) situation. Only 1.8% of respondents declared poor financial situation. Selected results of the selection of customer are presented in Table 4.

**Table 4.** Gender, age, place of residence, and subjective assessment of the material situation of the customer.

Age	Sex		Place of Residence				Material Situation			
	W	M	Village	Small Town	Medium City	Big City	Very Good	Good	Not Bad	Bad
below 18	16	34	3	3	26	18	13	26	10	1
19–25	122	118	56	50	66	68	23	164	49	4
26–35	30	34	10	11	22	21	10	37	14	3
36–45	34	30	14	15	21	14	12	43	9	0
46–55	19	28	11	9	14	13	4	33	9	1
56–67	15	16	12	5	5	9	6	18	7	0
over 67	4	4	4	2	1	1	2	2	4	0
/sum	240	264	110	95	155	144	70	323	102	9

The main objective of the survey was to determine the actual needs of customers associated with the products offered on the market, as well as the assessment of the level required by the customer customization. The study looked for answers to the following questions:

1. What are the expectations and preferences of consumers in the area of personalized production in the context of the development of the Industry 4.0 concept?
2. How do they perceive their commitment to the process of creating personalized products?
3. What threats and benefits respondents identify in the perspective of implementing the concept of Industry 4.0?

The following hypothesis was adopted in the research—customization is a key element in changing the mass production paradigm to individual production, as a result of which there are changes in the relations between consumer-producer-employee.

#### 4. Results of Direct Research

Surveys on a selected group of potential consumers showed expectations of modern customers. Over half of the respondents from the total number of respondents declared interest in personalized products. The largest group of respondents was interested in personalizing clothes and footwear (62.5% of respondents), electronic devices in (39.5%), ordering personalized dishes in restaurants (37.2%), personalized various types of accessories (31.2% of respondents), jewellery (24.9%), and home and

garden equipment including furniture (23.7% of respondents). Detailed data of customer's preferences are presented in Figure 1.

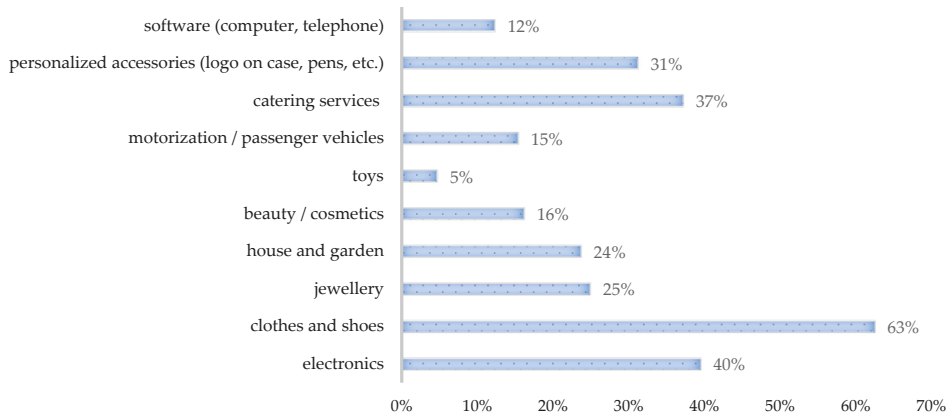

Figure 1. Consumer preferences regarding the type of personalized products.

Only 21% of respondents were willing to pay more for personalized products, while 47% of respondents made decisions dependent on the level of price difference between the standard and personalized product and the type of product (Figure 2).



Figure 2. Acceptance of a high price level for personalized products.

Studies show a great interest in personalized products created in various customization strategies. Respondents most often indicated the uniqueness of the product as a reason for purchasing personalized products, and emphasized the impact on its final shape/appearance, greater satisfaction, and comfort of use. As many as 55.5% of respondents believed that personalized products are unique (Figure 3).

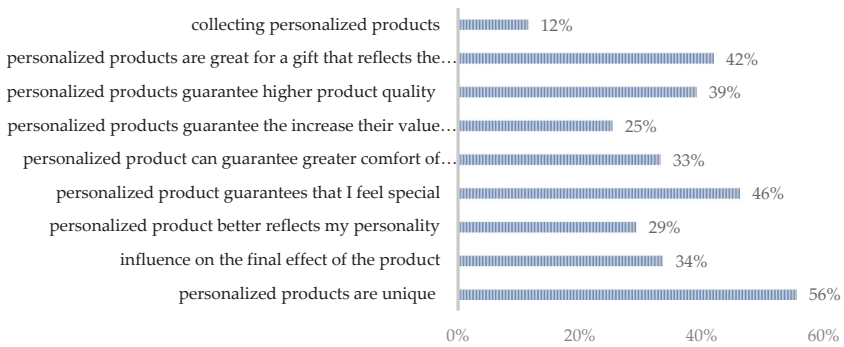

Figure 3. Reasons to buy personalized products.

Direct contact with the manufacturer’s representative (81.8% of respondents) was most often indicated as the preferred channel of contact with the producer, the use of e-commerce channels (89.15% of respondents), and more than 79% of respondents expected specialized design programs for personalized integrated products with the manufacturer’s system. The less preferred channels were questionnaire, telephone, or live broadcast, and various types of messengers (Figure 4).

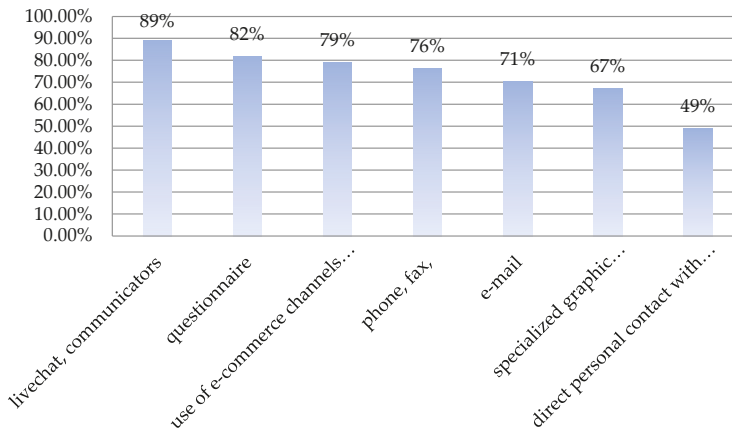
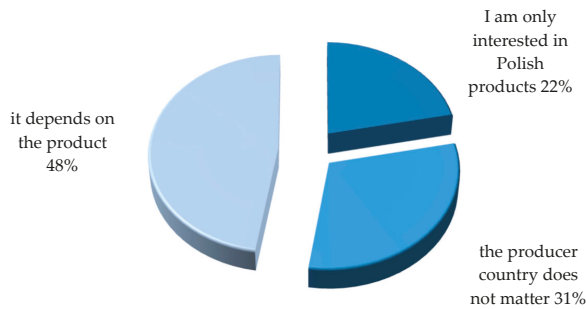

Figure 4. Preferred communication channels producer/seller-customer/consumer.

It is worth noting that as much as 21.8% of people always pay attention to the country in which the product was made, and 47.5% depended on the type of product (Figure 5). These results positively testify to the modern consumer, his social responsibility, and the expectations of social responsibility towards the producer (as an employer, user of natural resources, an entity having an influence on the market, competition, socio-economic environment).



**Figure 5.** Answers to the question: Does it matter to you whether the personalized product will be made in Poland?

As shown in the study, the Fourth Industrial Revolution was also of great concern (Figure 6). Respondents could choose from a list of five answers that they believed best described their subjective concerns. The most frequently indicated (53.3%) risk was related to a decrease in competitiveness, especially of small and medium-sized production enterprises, which could not afford investment in new technologies and fear of changing the employment structure, including higher requirements (required qualifications) in relation to employees employed in industry (59.3%). The risk of technological unemployment emerging was also strongly emphasized, resulting in a decline in consumer demand (48.1%); the possibility of a change in the social structure, especially due to the exclusion of people with low professional qualifications (42.5%); as well as increased interest in foreign products manufactured by companies that will quickly implement the Industry 4.0 concept and offer highly personalized products (42.3%). However, addition to the purchase of personalized products was perceived as a threat only by 19.8% of respondents.

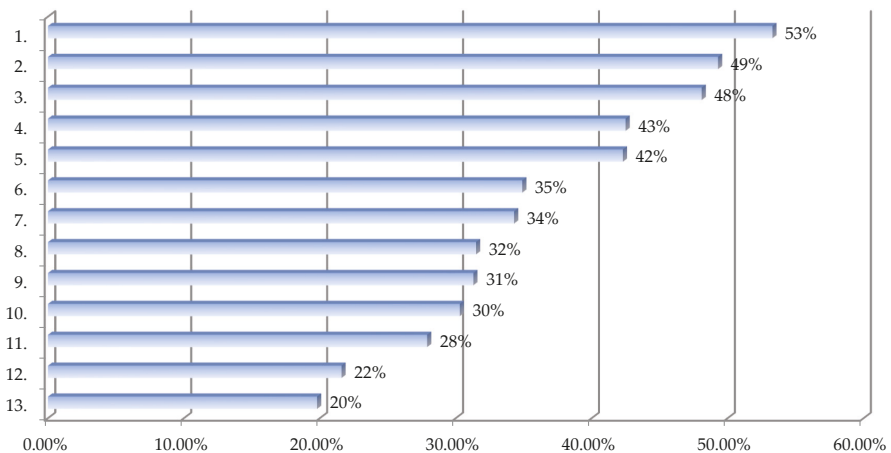

**Figure 6.** Threats related to the implementation of the Industry 4.0 concept.

Legend (Figure 6):

1. The decline in the competitiveness, especially small and medium-sized manufacturing enterprises, which cannot afford to invest in new technologies;
2. Change in the employment structure including higher requirements (required qualifications) in relation to employees employed in industry;

3. Technological unemployment, which will affect the decline in consumer demand;
4. Changes in the social structure, especially due to the exclusion of people with low professional qualifications;
5. Interest in foreign products produced by companies that will implement the Industry 4.0 concept faster and will offer highly personalized products;
6. Problems with returning personalized products to the point of sale (return logistics);
7. Excessive increase in the level of consumption for personalized products and thus the risk of increased demand for energy and environmental pollution;
8. Ecological problems, e.g., the need to withdraw products from the market more often;
9. The decrease in the number of stationary sales points and an increase in electronic sales (e-commerce);
10. Difficulties with the service of personalized products (e.g., lack of availability of spare parts);
11. An increase in the level of stress caused by the desire to have new, personalized products;
12. The danger of theft of “intellectual capital” in the case of own designs of personalized products;
13. Addiction to the purchase of personalized products.

The study also attempted to identify the benefits of Industry 4.0 (Figure 7). The respondents could choose five answers. According to the respondents, the greatest benefit was the increase in the level of adaptation of the product offer to the current needs of the customer (66.6%); reducing the number of intermediaries in the supply chain (55%); increasing the availability of a wide range of products (53.8%); production of highly personalized products at a low purchase price (53.6%); and the possibility of active participation in the design of new products (46.4%).

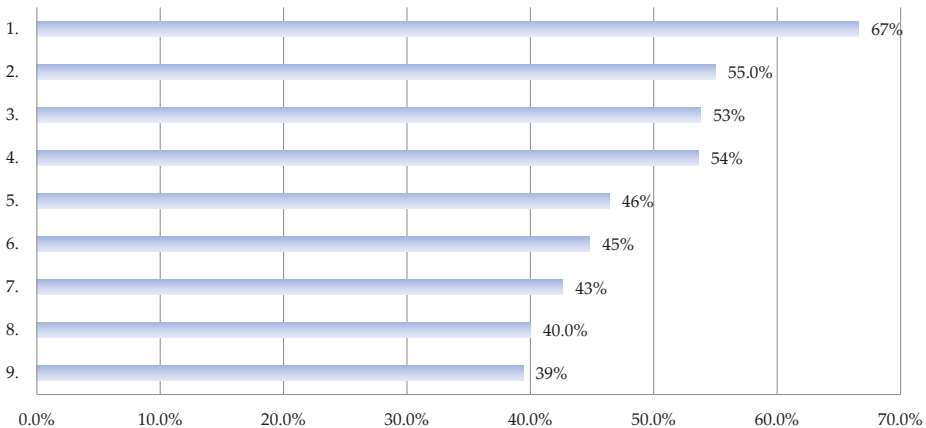

Figure 7. Benefits of implementing the Industry 4.0 concept.

Legend (Figure 7):

1. A higher level of adjustment of the product offer to the current client's needs;
2. Reducing the number of elements of the supply chain;
3. Increasing the availability of a wide range of products;
4. Production of highly personalized products at a low purchase price;
5. The possibility of active involvement in the design of new products;
6. A higher level of on-time delivery of orders (products);
7. Industry 4.0 can solve the problem of the lack of employees with basic qualifications;
8. Increase in the quality of life through the opportunity to purchase personalized products;

9. The possibility of developing new business models based on the products of own design produced by enterprises of Industry 4.0.

## **5. Discussion and Conclusions**

Industry 4.0 is a change in the production paradigm from mass production to personalized production—it is a key element of Industry 4.0, which is why so much attention was paid to customization in research. On the other hand, the pillars of Industry 4.0 described in the literature are fundamentals enabling substantive transformation of the production system. The research focused on the consumer, because it generates demand for personalized products, and as a consequence, the manufacturer introduces a number of changes to ensure the gift. Changing the way of working, technology implemented innovative production impact on employees.

The research confirmed the importance of customization for the modern consumer, thus confirming the correctness of the hypothesis. Modern consumers are interested in personalizing products, expecting much more than just the best-quality product at the lowest price. Consumers expect the possibility of personalizing products, and this phenomenon is already clearly visible in many industries, especially in the clothing and footwear, consumer electronics, and automotive industries. Consumers increasingly expect products that will reflect their tastes, needs, adapt to their lifestyle, will be unique, and at the price of a mass-produced product. The supply of personalized products can guarantee benefits for both parties to the consumer–producer transaction. Active customer participation in the design and production of products reduces the risk of producing unsuccessful products and contributes to improving the adaptation of the market offer to the current needs of consumers. A higher level of satisfaction with purchased, personalized products can contribute to an increase in the quality of life, which is emphasized by respondents in their responses. Increased satisfaction with having unique products may directly reduce the overall consumption, which will have a positive impact on sustainable development (e.g., zero waste). Nowadays, excessive consumption can be observed for products that are purchased only because of the desire to have a new model or only to a small extent improving the functionality of the product used so far—which results in problems related to, for example, an excess of generated waste by consumers. The possibility of active customer involvement in product design (full customization) eliminates the problem of the need for frequent product changes and thus reduces excessive consumption, waste of resources, or the need to dispose of discontinued standard products. In addition, the satisfied customer will be more loyal, which in turn can translate into the stability of the manufacturer’s revenues.

Manufacturers should recognize that customers are increasingly assessing them in many ways, noting whether they are a socially responsible company.

Based on the research and literature studies, it can be determined that a modern consumer wants to buy personalized products. This results in threats to companies. Many entrepreneurs will not be able to afford investments in new technologies that are able to cope with the automatized production remaining at the price level of mass production. There will also be threats related to technological unemployment and a change in the employment structure and required qualifications, because manufacturing companies most often employ people with basic qualifications. This raises concerns about changes in the social structure caused by the exclusion of people with low qualifications when the concept of Industry 4.0 is introduced. This means the emergence of a series of problems of a social and economic nature resulting from technological unemployment.

Also noteworthy is the danger of consumers becoming addicted to personalized production, which is manifested in an increase in stress levels caused by the desire to have unique products (especially observed among young people).

Summing up the social expectations and market changes in the era of Industry 4.0, it should be noted that it is difficult to predict now how the concept of Industry 4.0 will evolve and the industrial revolution that is under way. With the development of Industry 4.0, new opportunities and threats to enterprises appear, as well as social opportunities and threats. Building a new industry is not easy

because it requires building new resources of enterprises. Formulating and adapting to changes is a long-term activity that requires a lot of material and financial expenses. This increases the need for future research into the problems of developing new business models, especially focused on network forms of cooperation between customer-oriented enterprises operating in the era of the Industry 4.0 concept.

**Author Contributions:** Conceptualization, S.S. and S.G.; methodology, S.S. and S.G.; software, S.S.; validation, S.S., S.G. and B.G.; formal analysis, S.S. and S.G.; investigation, S.S. and S.G.; resources, S.S. and S.G.; data curation, S.S. and S.G.; writing—original draft preparation, S.S., S.G. and B.G.; writing—review and editing, S.S., S.G. and B.G.; visualization, S.S. and S.G.; supervision, S.S.; project administration, S.G.; funding acquisition, S.S. All authors have read and agree to the published version of the manuscript.

**Funding:** This research received no external funding.

**Conflicts of Interest:** The authors declare no conflict of interest.

## References

1. Bauernhansl, T. Die Vierte Industrielle Revolution—Der Weg in ein wertschaffendes Produktionsparadigma. In *Industrie 4.0 in Produktion, Automatisierung und Logistik—Anwendung, Technologien, Migration*; Bauernhansl, T., ten Hompel, M., VogelHeuser, B., Eds.; Springer: Wiesbaden, Germany, 2015; pp. 5–35.
2. Chandler, D. Strategic Corporate Social Responsibility. In *Sustainable Value Creation*; Sage: London, UK, 2016.
3. Clarke, T.; Clegg, S. Management paradigm for the new millennium. *Int. J. Manag. Rev.* **2000**, *2*, 45–64. [[CrossRef](#)]
4. Kiel, D.; Arnold, C.; Collisi, M.; Voigt, K.I. The Impact of the Industrial Internet of Things on Established Business Models. In Proceedings of the 25th International Association for Management of Technology (IAMOT) Conference, Orlando, FL, USA, 15–19 May 2015.
5. Gajdzik, B.; Grzybowska, K. Example models of building trust in supply chains of metalurgical enterprises. *Metalurgija* **2012**, *51*, 563–566.
6. Pilloni, V. How Data Will Transform Industrial Processes: Crowdsensing, Crowdsourcing and Big Data as Pillars of Industry 4.0. *Future Internet* **2018**, *10*, 24. [[CrossRef](#)]
7. Wamba, S.F.; Gunasekaran, A.; Akter, S.; Ren, S.J.F.; Dubey, R.; Childe, S.J. Big Data Analytics and Firm Performance: Effects of Dynamic Capabilities. *J. Bus. Res.* **2017**, *70*, 356–365. [[CrossRef](#)]
8. Szczanowicz, J.; Saniuk, S. Implementation of CSR concept in manufacturing companies. *Management* **2014**, *1*, 71–82. [[CrossRef](#)]
9. Domingo Galindo, L. *The Challenges of Logistics 4.0 for the Supply Chain Management and the Information Technology*; Norwegian University of Science and Technology: Trondheim, Norway, 2016.
10. Mortazavi, H.; Pirmouradi, N.; Nejad, S.A. Corporate Social Responsibility. *J. Behav. Sci. Asia* **2013**, *4*, 63–77.
11. Stock, T.; Seliger, G. Opportunities of Sustainable Manufacturing in Industry 4.0. *Procedia Cirp* **2016**, *40*, 536–541. [[CrossRef](#)]
12. Industry 4.0. Available online: <https://www.bmbf.de/de/zukunftspjekt-industrie-4-0-848.html> (accessed on 10 January 2020).
13. Koen, P.A.; Bertels, H.M.; Elsum, I.R. The three faces of business model innovation: Challenges for established firms. *Res. Technol. Manag.* **2011**, *54*, 52–59. [[CrossRef](#)]
14. Mrugalska, B.; Wyrwicka, M.K. Towards lean production in industry 4.0. *Procedia Eng.* **2017**, *182*, 466–473. [[CrossRef](#)]
15. PwC—Industry 4.0. Available online: <https://www.pwc.pl/pl/pdf/przemysl-4-0-raport.pdf> (accessed on 10 January 2020).
16. Wolniak, R. The level of maturity of quality management systems in Poland—results of empirical research. *Sustainability* **2019**, *11*, 4239. [[CrossRef](#)]
17. Nanterme, P.; Daugherty, P. *Technology for People: The Era of the Intelligent Enterprise*; Accenture: Dublin, Ireland, 2017.
18. Stanimir, A. *Analysis of Correspondence as a Tool for Studying Economic Phenomena (Translated from Polish)*; Wydawnictwo AE we Wrocławiu: Wrocław, Poland, 2005.

19. Zhou, K.; Liu, T.; Zhou, L. Industry4.0: Towards future industrial opportunities and challenges. In Proceedings of the IEEE 2015 12th International Conference on Fuzzy Systems and Knowledge Discovery (FSKD), Zhangjiajie, China, 15–17 August 2015; pp. 2147–2152.
20. Czakon, W. Istota relacji sieciowych przedsiębiorstwa. *Przegląd Organ.* **2005**, *9*, 10–13.
21. Czakon, W. Sieci w zarządzaniu strategicznym. Oficyna a Wolters Kluwer business. *Warszawa* **2012**, *1*, 264.
22. Jamali, D.R.; El Dirani, A.M.; Harwood, I.A. Exploring Human Resource Management Roles in Corporate Social Responsibility: The CSR-HRM Co-creation Model. *Bus. Ethics A Eur. Rev.* **2015**, *24*. [CrossRef]
23. Kliment, M.; Trebuña, P.; Straka, M. Tecnomatix Plant Simulation, Its Features and Its Integration into Business Processes in Logistics Systems. *Am. J. Mech. Eng.* **2014**, 286–289. [CrossRef]
24. Baden-Filler, C.; Haefliger, S. Business Models and Technological Innovation. *Long Range Plan* **2017**, *46*, 419–426.
25. Eisenegger, M. Trust and Reputation in the Age of Globalization. In *Reputation Capital. Building and Maintaining Trust in the 21st Century*; Kiewers, J., Wreschniok, R., Eds.; Springer: Berlin/Heidelberg, Germany, 2009; p. 65.
26. Lee, J.; Kao, H.-A.; Yang, S. Service innovation and smart analytics for industry 4.0 and big data environment. *Procedia Cirp* **2014**, *16*, 3–8.
27. Prahalad, C.K.; Krishnan, M.S. *The New Age of Innovation*; McGraw-Hill: New York, NY, USA, 2010; p. 15.
28. Kagermann, H.; Wahlster, W.; Helbig, J. *Final Report of the Industrie 4.0 Working Group*; Acatech-National Academy of Science and Engineering: München, Germany, 2013; Available online: [http://forschungsunion.de/pdf/industrie\\_4\\_0\\_final\\_report.pdf](http://forschungsunion.de/pdf/industrie_4_0_final_report.pdf) (accessed on 10 January 2020).
29. Korena, Y.; Shpitalnib, M.; Guc, P.; Hu, S.J. Product design for mass-individualization. *Procedia Cirp* **2015**, *36*, 64–71. [CrossRef]
30. Longo, F.; Nicoletti, L.; Padovano, A. Smart operators in industry 4.0: A human-centered approach to enhance operators' capabilities and competencies within the new smart factory context. *Comput. Ind. Eng.* **2017**, *113*, 144–159. [CrossRef]
31. Zott, C.; Amit, R. The business model: A theoretically anchored robust construct for strategic analysis. *Strat. Organ.* **2013**, *11*, 403–411. [CrossRef]
32. Malina, A. Research on structural similarities between Poland and EU countries in terms of employment structure. *Argum. Oeconomica Crac.* **2005**, *4*, 57–70.
33. Schwab, K. *The Fourth Industrial Revolution*, *World Economic Forum*; Deloitte: New York, NY, USA, 2016.
34. Szymańska, O.; Adamczak, M.; Cyplik, P. Logistics 4.0—a new paradigm or set of known solutions? *Res. Logist. Prod.* **2017**, *7*, 299–310.
35. Azmi, A.N.; Kamin, Y.; Noordin, M.K.; Nasir, A.N.M. Towards industrial revolution 4.0: Employers' expectations on fresh engineering graduates. *Int. J. Eng. Tech.* **2018**, *7*, 267–272.
36. Brettel, M.; Friederichsen, N.; Keller, M.; Rosenberg, M. How Virtualization, Decentralization and Network Building Change the Manufacturing Landscape: An Industry 4.0 Perspective. *Int. J. Mech. Aerosp. Ind. Mechatron. Eng.* **2014**, *8*, 37–44.
37. Grabowska, S.; Gajdzik, B.; Saniuk, S. The Role and Impact of Industry 4.0 on Business Models. In *Sustainable Logistics and Production in Industry 4.0. EcoProduction (Environmental Issues in Logistics and Manufacturing)*; Grzybowska, K., Awasthi, A., Sawhney, R., Eds.; Springer: Cham, Germany, 2020. [CrossRef]
38. Lasi, H.; Fettke, P.; Kemper, H.-G.; Feld, T.; Hoffmann, M. Industry 4.0. *Bus. Inf. Syst. Eng.* **2014**, *6*, 239–242. [CrossRef]
39. McKinsey—Industry 4.0: How to Navigate Digitization of the Manufacturing Sector. Available online: <https://www.mckinsey.com/business-functions/operations/our-insights/industry-four-point-o-how-to-navigate-the-digitization-of-the-manufacturing-sector> (accessed on 8 January 2020).
40. Franke, U. The concept of virtual web organizations and its implications on changing market conditions. *Electr. J. Organ. Virtualness* **2001**, *3*, 120–139. Available online: [www.virtual-organization.net](http://www.virtual-organization.net) (accessed on 21 November 2019).
41. Kaliczyńska, M.; Dąbek, P. Value of the Internet of Things for the industry—an overview. In *Mechatronics: Ideas for Industrial Applications*; Springer: Berlin/Heidelberg, Germany, 2015; pp. 51–63.
42. Perechuda, K. *Zarządzanie Przedsiębiorstwem Przyszłości. Koncepcje, Modele, Metody*; Agencja Wydawnicza Placet: Warszawa, Poland, 2002; pp. 53–54.



43. Saniuk, S.; Saniuk, A. Decision support system for rapid production order planning in production network. In *Advances in Intelligent Systems and Computing*; Springer International Publishing: Berlin/Heidelberg, Germany, 2018; Volume 637, pp. 217–226.
44. Hermann, M.; Prentek, T.; Otto, B. Design Principles for Industrie 4.0 Scenarios: A Literature Review. Available online: [http://www.iim.mb.tu-dortmund.de/cms/de/forschung/Arbeitsberichte/Design-Principles-for-Industrie-4\\_0-Scenarios.pdf](http://www.iim.mb.tu-dortmund.de/cms/de/forschung/Arbeitsberichte/Design-Principles-for-Industrie-4_0-Scenarios.pdf) (accessed on 10 January 2020).
45. Santos, K.; Loures, E.; Piechnicki, F.; Canciglieri, O. Opportunities Assessment of Product Development Process in Industry 4.0. *Procedia Manuf.* **2017**, *11*, 1358–1365. [[CrossRef](#)]
46. Rübmann, M.; Lorenz, M.; Gerbert, P.; Waldner, M.; Justus, J.; Engel, P.; Harnisch, M. Industry 4.0: The Future of Productivity and Growth in Manufacturing Industries. Available online: [www.inovasyon.org/pdf/bcg\\_perspectives\\_Industry.4.0\\_2015.pdf](http://www.inovasyon.org/pdf/bcg_perspectives_Industry.4.0_2015.pdf) (accessed on 6 January 2020).
47. Berger, R. *The Industrie 4.0 Transition Quantified. How the Fourth Industrial Revolution is Reshuffling the Economic, Social and Industrial Model*; Roland Berger: Monachium, Germany, 2016.
48. Drath, R.; Horch, A. *Industrie 4.0: Hit or hype?* [Industry forum]. *IEEE Ind. Electron. Mag.* **2015**, *8*, 56–58. [[CrossRef](#)]
49. Chui, M.; Löffler, M.; Roberts, R. The Internet of Things. *McKinsey* **2010**, *2*, 1–9.
50. Motyl, B.; Baronio, G.; Uberti, S.; Speranza, D.; Filippi, S. How will change the future engineers' skills in the industry 4.0 framework? A questionnaire survey. *Procedia Manuf.* **2019**, *11*, 1501–1509. Available online: <https://doi.org/10.1016/j.promfg.2017.07.282> (accessed on 28 November 2019).
51. Teece, D.J. Business models, business strategy and innovation. *Long Range Plan* **2010**, *43*, 172–194. [[CrossRef](#)]
52. Lopez Research. Building Smarter Manufacturing with the Internet of Things (IoT). Part 2 of 'The IoT Series'. Lopez Research, White Paper. Available online: [http://cdn.iotwf.com/resources/6/iot\\_in\\_manufacturing\\_january.pdf](http://cdn.iotwf.com/resources/6/iot_in_manufacturing_january.pdf) (accessed on 3 February 2020).
53. Porter, M.E.; Heppelmann, J.E. How Smart Connected Products Are Transforming Competition. *Harv. Bus. Rev.* **2014**, *92*, 64–88.
54. Schneider, S.; Spieth, P. Business model innovation: Towards an integrated future research agenda. *Int. J. Innov. Manag.* **2013**, *17*, 1–34. [[CrossRef](#)]
55. Wirtz, B.W.; Pistoia, A.; Ullrich, S.; Gottel, V. Business model innovation: Development, concept and future research directions. *Long Range Plan* **2016**, *19*. [[CrossRef](#)]
56. Arnold, C.; Kiel, D.; Voigt, K.I. How Industry 4.0 changes business models in different manufacturing industries. In Proceedings of the XXVII ISPIM Innovation Conference—Blending Tomorrow's Innovation Vintage, At Porto, Portugal, 19–22 June 2016; p. 1.
57. Ashton, K. That 'Internet of Things' Thing. Available online: <https://www.rfidjournal.com/articles/view?4986> (accessed on 9 December 2019).
58. Burmeister, C.; Luettgens, D.; Piller, F.T. Business Model Innovation for Industrie 4.0: Why the Industrial Internet Mandates a New Perspective on Innovation. In *Working Paper*; RWTH-TIM: Aachen, Germany, 2015.
59. Fogliatto, F.S.; da Silveira, G.J.C.; Borensteine, D. The mass customization decade: An updated review of the literature. *Int. J. Prod. Econ.* **2012**, *138*, 14–25. [[CrossRef](#)]
60. Hąbek, P. CSR Reporting Practices in Visegrad Group Countries and the Quality of Disclosure. *Sustainability* **2017**, *9*, 2322. [[CrossRef](#)]
61. Bakkari, M.; Khatory, A. Industry 4.0: Strategy for More Sustainable Industrial Development in SMEs. Available online: <http://ieomsociety.org/ieom2017/papers/414.pdf> (accessed on 23 August 2019).
62. Casson, M. *Global Research Strategy and International Competitiveness*; Basil Blackwell: Oxford, UK, 1991; p. 513.
63. Ćwik, N. Wspólna odpowiedzialność. Rola dostaw i zakupów: Forum Odpowiedzialnego Biznesu. Available online: [www.odpowiedzialnybiznes.pl](http://www.odpowiedzialnybiznes.pl) (accessed on 30 November 2019).
64. Grzybowska, K.; Łupicka, A. Key competencies for industry 4.0. *Econ. Manag. Innov.* **2017**, *1*, 250–253.
65. Klassen, R.D.; Vereecke, A. Social issues in supply chain: Capabilities link responsibility, risk (opportunity) and performance. *Int. J. Prod. Econ.* **2012**, *140*, 103–115. [[CrossRef](#)]
66. Ahi, P.; Searcy, C. A Comparative Literature Analysis of Definitions for Green and Sustainable Supply Chain Management. *J. Clean. Prod.* **2013**, *52*, 329–341. [[CrossRef](#)]
67. Bauernhansl, T.; Hompel, M.; Vogel-Henser, B. *Industrie 4.0 in Produkten. Automatisierung und Logistik*; Springer: Wiesbaden, Germany; Fachmedie: Stefa, Switzerland, 2014.

68. Grzybowska, K.; Gajdzik, B. Seci model and facilitation in change management in metallurgical enterprise. *Metalurgija* **2016**, *52*, 275–278.
69. ASTOR—Industry 4.0 Whitpaper. Available online: [www.astor.com.pl/industry4](http://www.astor.com.pl/industry4) (accessed on 10 January 2020).
70. Deloitte—How leaders are navigating the Fourth Industrial Revolution. Available online: <https://www2.deloitte.com/us/en/insights/deloitte-review/issue-22/industry-4-0-technology-manufacturing-revolution.html> (accessed on 10 January 2020).
71. Fatorachian, H.; Kazemi, H. A critical investigation of Industry 4.0 in manufacturing: Theoretical operationalisation framework. *J. Prod. Plan. Control Manag. Oper.* **2018**, *29*, 633–644. [[CrossRef](#)]
72. Kagermann, H.; Helbig, J.; Hellinger, A.; Wahlster, W. Recommendations for Implementing the Strategic Initiative Industry 4.0: Securing the Future of German Manufacturing Industry. Final Report of the Industry 4.0 Working Group Forschungsunion. 2013. Available online: [http://www.acatech.de/fileadmin/user\\_upload/Baumstruktur\\_nach\\_Website/Acatech/root/de/Material\\_fuer\\_Sonderseiten/Industrie\\_4.0/Final\\_report\\_\\_Industrie\\_4.0\\_accessible.pdf](http://www.acatech.de/fileadmin/user_upload/Baumstruktur_nach_Website/Acatech/root/de/Material_fuer_Sonderseiten/Industrie_4.0/Final_report__Industrie_4.0_accessible.pdf) (accessed on 2 February 2020).
73. Helo, P.; Hao, Y. Cloud Manufacturing System for Sheet Metal Processing. *Prod. Plan. Control* **2017**, *28*, 524–537. [[CrossRef](#)]
74. Öberg, C.; Graham, G. How Smart Cities Will Change Supply Chain Management: A Technical Viewpoint. *Prod. Plan. Control* **2017**, *27*, 529–538. [[CrossRef](#)]
75. Hu, B.; Kostamis, D. Managing Supply Disruptions when Sourcing from Reliable and Unreliable Suppliers. *Prod. Oper. Manag.* **2015**, *24*, 808–820. [[CrossRef](#)]
76. Chen, Y.J.; Deng, M. Information Sharing in a Manufacturer-supplier Relationship: Suppliers' Incentive and Production Efficiency. *Prod. Oper. Manag.* **2015**, *24*, 619–633. [[CrossRef](#)]
77. Lang, M.; Deflorin, P.; Dietl, H.; Lucas, E. The Impact of Complexity on Knowledge Transfer in Manufacturing Networks. *Prod. Oper. Manag.* **2014**, *23*, 1886–1898. [[CrossRef](#)]
78. Shamsuzzoha, A.; Toscano, C.; Carneiro, L.M.; Kumar, V.; Helo, P. ICT-based Solution Approach for Collaborative Delivery of Customised Products. *Prod. Plan. Control* **2016**, *27*, 280–298. [[CrossRef](#)]
79. Bechtold, J.; Kern, A.; Lauenstein, C.; Bernhofer, L. Industry 4.0 - The Capgemini Consulting View. 2014. Available online: [https://www.de.capgemini-consulting.com/resource-file-access/resource/pdf/capgemini-consulting-Industry-4.0\\_0.pdf](https://www.de.capgemini-consulting.com/resource-file-access/resource/pdf/capgemini-consulting-Industry-4.0_0.pdf) (accessed on 2 February 2020).
80. Li, F.; Nucciarelli, A.; Roden, S.; Graham, G. How Smart Cities Transform Operations Models: A New Research Agenda for Operations Management in the Digital Economy. *Prod. Plan. Control* **2016**, *27*, 514–528. [[CrossRef](#)]
81. Brecher, C.; Kozielski, S.; Schapp, L. *Integrative Production Technology for High-wage Countries*; Springer: Heidelberg, Germany, 2011.
82. Zhong, R.Y.; Xu, C.; Chen, C.; Huang, G.Q. Big Data Analytics for Physical Internet-based Intelligent Manufacturing Shop Floors. *Int. J. Prod. Res.* **2015**, 1–12. [[CrossRef](#)]
83. Brousell, D.R.; Moad, J.R.; Tate, P. The Next Industrial Revolution: How the Internet of Things and Embedded, Connected, Intelligent Devices will Transform Manufacturing. In *A Manufacturing Leadership White Paper*; Frost & Sullivan: San Antonio, TX, USA, 2014; Available online: [https://www.allegient.com/wp-content/uploads/FS\\_industrial\\_revolution.pdf](https://www.allegient.com/wp-content/uploads/FS_industrial_revolution.pdf) (accessed on 2 February 2020).
84. Schmidt, R.; Möhring, M.; Härting, R.C.; Reichstein, C.; Neumaier, P.; Jozinovic, P. Industry 4.0-potentials for creating smart products: Empirical research results. In Proceedings of the International Conference on Business Information Systems, Poznań, Poland, 24–26 June 2015; Springer: Cham, Switzerland, 2015; pp. 16–27.
85. PWC Industry 4.0: Building the Digital Enterprise Metals Key Findings. Global Industry 4.0 Survey. 2016. Available online: <https://www.pwc.com/gx/en/metals/pdf/industry-4-0-metals-key-findings.pdf> (accessed on 5 January 2020).
86. Bijańska, J.; Wodarski, K.; Wójcik, J. Preparing the Production of a New Product in Small and Medium—Sized Enterprise by Using the Method of Projects Management. *Manag. Syst. Prod. Eng.* **2016**, *22*, 128–134. [[CrossRef](#)]
87. Chesbrough, H. Business Model Innovation: It's Not About Technology Anymore. *Strategy Lead.* **2007**, *35*, 12–17. [[CrossRef](#)]
88. Jabłoński, M. *Strategic Value Management: A Dynamic Perspective*; Nova Science Publishers: New York, NY, USA, 2019.

89. Olszewski, M. Mechatronizacja produktu I produkcji - przemysł 4.0. *Pomiary Autom. Robot.* **2016**, 13–28. [CrossRef]
90. Casadesus-Masanell, R.; Ricart, J.E. Competitiveness: Business Model Reconfiguration for Innovation and Internationalization. *Manag. Res. J. Iberoam. Acad. Manag.* **2010**, 35, 123–149. [CrossRef]
91. Erboz, G. How to Define Industry 4.0: The Main Pillars of Industry 4.0. 2017. Available online: [https://www.researchgate.net/publication/326557388\\_How\\_To\\_Define\\_Industry\\_40\\_Main\\_Pillars\\_Of\\_Industry\\_40](https://www.researchgate.net/publication/326557388_How_To_Define_Industry_40_Main_Pillars_Of_Industry_40) (accessed on 5 February 2020).
92. Mushanyuri, B.E. The impact of corporate responsibility on sustainable supply chains: A review of literature. *Eur. J. Bus. Soc. Sci.* **2013**, 1, 52–60.
93. Saniuk, S.; Saniuk, A.; Cagaňová, D. Cyber Industry Networks as an environment of the Industry 4.0 implementation. *Wirel. Netw.* **2019**, 1–7. [CrossRef]
94. Unold, J. *Zarządzanie Informacją w Cyberprzestrzeni*; Wydawnictwo Naukowe PWN: Warszawa, Poland, 2015.
95. Szczepankiewicz, E.I. Model zarządzania bezpieczeństwem informacji korporacyjnych w przedsiębiorstwie. *Przedsiębiorczość I Zarządzanie* **2018**, 2, 191–209.
96. Stevens, T. Global Cybersecurity: New Directions in Theory and Methods (PDF). *Politics Gov.* **2016**, 6, 1–4. [CrossRef]
97. Lin Tom, C.W. The New Market Manipulation. *Emory Law J.* **2017**, 66, 1253.
98. Cavalcante, S.; Kesting, P.; Ulhøi, J. Business model dynamics and innovation: (Re)Establishing the missing linkages. *Manag. Decis.* **2011**, 49, 1327–1342. [CrossRef]
99. Gajdzik, B.; Grabowska, S.; Wyciślik, A. Explanatory preview of directions of changes in development of industry 4.0. *Pol. Tech. Rev.* **2019**, 1, 5–9. [CrossRef]



© 2020 by the authors. Licensee MDPI, Basel, Switzerland. This article is an open access article distributed under the terms and conditions of the Creative Commons Attribution (CC BY) license (<http://creativecommons.org/licenses/by/4.0/>).



Article

# Identifying the Financial Risk Factors of Excessive Indebtedness of Rural Communes in Poland

Aldona Standar <sup>1</sup> and Agnieszka Kozera <sup>2,\*</sup>

<sup>1</sup> Department of Economics and Economic Policy in Agribusiness, Faculty of Economics and Social Sciences, University of Life Sciences, Wojska Polskiego 28, 60-637 Poznan, Poland; standar@up.poznan.pl

<sup>2</sup> Department of Finance and Accounting, Faculty of Economics and Social Sciences, University of Life Sciences, Wojska Polskiego 28, 60-637 Poznan, Poland

\* Correspondence: agnieszka.kozera@up.poznan.pl

Received: 9 December 2019; Accepted: 18 January 2020; Published: 21 January 2020

**Abstract:** The purpose of this paper is to identify the financial risk factors of excessive indebtedness of Polish rural communes. The objective of this research task is to verify the following research hypothesis: the main determinant of the risk of excessive indebtedness is the rural communes' own income potential. To meet the objective of this research, an empirical study was carried out in three steps. The first step of the research procedure was the analysis of the operation of Polish rural communes in the context of financial management. In the second step was the analysis of indebtedness of rural communes compared to other types of Polish administrative units in 2007–2017. The evolution of the level and share of total debt in total incomes of entities studied was analyzed, and the share of overindebted rural communes was identified. In the third step, a discriminatory analysis was performed to build a model able to forecast the financial risk factors of excessive indebtedness for Polish rural communes. The problem of increasing indebtedness can be observed in a growing number of communes and on an increasing scale in Poland. The discriminant analysis showed that the share of the operating surplus and own income in total income, as well as the amount of the EU funds per capita (in zlotys), are particularly significant. The study reveals that the smaller the share of the operating surplus in total income is as well as the greater the share of own income in total income and the amount of the EU funds in zlotys per capita are, the lower the value of the estimated discriminatory function is and the higher the risk of excessive indebtedness of a rural commune is.

**Keywords:** communes; excessive indebtedness; financial risk; Poland; discriminant analysis

## 1. Introduction

Along the lines of what is in place in other European countries, Polish government entities handle only a part of local and regional tasks. In accordance with the principle of subsidiarity, the essential part of tasks having no relevance from the countrywide perspective is performed by local government units, namely, local authorities which are subordinate to, and represent the interests of, a local or regional community. Since 1999, a three-level local government model has been in place in Poland, comprising communes, districts, and voivodeships. As basic local government units (LGUs), the communes carry out tasks of importance in the local context while the districts represent an intermediate level in charge of supra-communal tasks. In turn, voivodeships, the largest entities in the country's territorial division, carry out regional tasks.

To perform their tasks and functions, Polish local government entities access defined sources of incomes, i.e., own incomes (including fiscal and non-fiscal income and property income) and transferred incomes (targeted grants and state budget subsidies). The sources and structure of LGU incomes are highly important for the implementation of their financial management tasks and policies. LGUs with certain own incomes from precisely defined sources are more autonomous and

better positioned to perform their tasks and functions, especially including expensive infrastructural investments. Conversely, a considerable share of transferred incomes (grants, subsidies), largely based on a discretionary allocation of funds by central authorities, restricts the LGUs' financial autonomy. To perform their own tasks, and, in particular, to implement infrastructure investments, local government entities may access repayable sources of finance (including credit and loans).

When considering the basic entities of the Polish local government sector, attention should be paid to rural communes, which represent the largest population of communes (1548 as at 1 November 2018, i.e., over 60% of all communes). In 2018, over 15 million people lived in rural areas in Poland. Rural communes were inhabited by nearly 11 million people, i.e., as much as 30% of the total population [1]. The increase in the total number of people inhabiting these areas results from the phenomenon of suburbanisation, which has been observed in recent years. In view of this fact, local communities have growing needs, especially for technical and social infrastructure. According to research carried out by many scientists, including Kozera and Głowicka-Wołoszyn [2], the functional type of many rural communes is transforming from the one characterised by the traditional agricultural function to the type with residential and service-providing functions. At the local level, it is communes that are chiefly burdened with the financial costs of inhabitants' growing needs. In order to implement different projects, rural communes often need to rely on EU funds as their own income is limited. In Poland, the communes' own income potential strictly depends on the functional type they represent. Even though the own income potential of Polish rural communes becomes increasingly higher, it still is the composite result of the demographic potential, local entrepreneurship, and local economic conditions, especially the location rent. As regards many rural communes, low levels of own income potential may be a barrier to socioeconomic development. This is because insufficient incomes make it more difficult to access external funds, whether repayable or non-repayable (including from the EU), which are determinant for the scope of communal investments and local development [3]. As a result, they use repayable sources of financing. By using these funds, rural communes can function under conditions where their income does not correspond to the costs of tasks implemented. Simultaneously, they can maintain high standards of these tasks [4]. The difficult financial situation of local governments has a negative influence on all citizens [5] and economic development in general [6–8]. Excessive indebtedness of local government units, especially the rural communes whose financial independence is below the average level in other administrative types of communes, may lead to the loss of financial liquidity or, in extreme cases, it may even result in falling into a debt spiral [9]. Although according to Polish law, this situation does not result in the bankruptcy of a local government unit, the state takes responsibility for local finance. In view of this fact, it is necessary to apply different measures to prevent the occurrence of this situation. For example, it is necessary to manage the debt adequately and identify the financial risk factors of excessive indebtedness of local government units. Although these actions are not enforced by law, they are the most important aspects of financial management [10]. In international literature, different approaches to debt management procedures are presented, which would be worth looking into. Special attention is paid to the need for a long-term approach to debt management [11–13].

However, a budget deficit cannot be regarded as a purely negative development. Its scale (usually, the relative figures calculated in relation to budget incomes) and, first of all, its reasons must be considered when assessing it [14]. Debt incurred by local government units to finance ongoing expenditure should definitively be judged negatively and is a prohibited practice in certain countries [15]. In accordance with the golden rule for a balanced budget, local government should not undertake liabilities to finance their current tasks.

The risk of indebtedness is affected by factors related with administration, government, law, the economic base of local government units, their general financial situation as well as the amount and character of debt [16]. Kosak-Wojnar and Surówka [17] indicate that the activity of local government units is characterised by the occurrence of different risks, including financial ones, which are related with the methods of financing of the tasks implemented. One of them is the risk of excessive debt. According to Filipiak [18], at present, it is caused not only by the fact that local government units implement an increasingly broad spectrum of tasks but also by the consequences of the economic

and financial crisis, the decreasing amount of own income. According to Standar [19], the risk is also caused by the implementation of numerous projects co-financed from EU funds.

It should be noted that in the literature worldwide, especially in America, financial risks are understood as economic distress [20], sometimes as fiscal health [21] and fiscal or financial stress [22]. A solution to this problem is greatly influenced by [23,24]. First, the problem is that local authorities show little interest in this process. According to Kolha et al. [23], of the 50 states covered by their study, only 15 rely on indicators to monitor the local financial conditions. Many of them use indicators that fail to identify local problems before they become important. The above is related to the next major issue involved in this research topic: the selection of indicators. During her research in 264 municipalities of the Chicago metropolitan area, Handrick [25] found that the analysis of fiscal health is a complex concept whose dimensions, though interlinked, affect each other in an indirect or non-linear manner. This means they must be measured separately rather than being combined into a comprehensive indicator of fiscal standing. Another view is presented by Wang et al. [26] who defined four dimensions of financial condition: dimensions in cash, budget, long-run and service-level solvencies, and 11 financial condition indicators. In turn, Jones and Walker [24] proved the existence of a relationship between incomes and population, on one side, and the emergence of fiscal hazards, on the other. In the relevant literature, the third important aspect is tackled by Rivenbark and Roenigk [27]. They noted the importance of the decision to analyze, interpret, and present the financial condition to selected officials and to see what management practices help in the analysis of financial conditions. The recent interest in the issue of the financial risk of communes has increased, as evidenced by recent research in all the world, e.g., in China—[28], in Hungary—[29], in Spain—[30], in Poland—[31].

The purpose of this paper is to identify the financial risk factors of excessive indebtedness of Polish rural communes. The objective of this research task is to verify the following research hypothesis: the main determinant of the risk of excessive indebtedness is the rural communes' own income potential. To meet the objective of this research, the empirical study was carried out in three steps. The first step of the research procedure was the analysis of the operation of Polish rural communes in the context of financial management. In the second step was the analysis of indebtedness of rural communes compared to other types of Polish administrative units in 2007–2017. The evolution of the level and share of total debt in total incomes of entities studied was analysed, and the share of overindebted rural communes was identified. In the third step, a discriminatory analysis was performed to build a model able to forecast the financial risk factors of excessive indebtedness for Polish rural communes.

This paper addresses the issues of public debt, which, in the theoretical sense, are a part of general economic and public finance theories. Generally, there are two conflicting doctrines regarding debt. According to the orthodox doctrine, debt is the consequence of defective financial management. In turn, the interventionist doctrine claims that debt should be viewed as a positive development which stimulates economic growth and makes investments financially feasible [16].

## **2. Materials and Methods**

The empirical research was based on the database published by the Ministry of Finance [32] and the Central Statistical Office of Poland [1]. The results are presented in Polish currency (the key data was converted to euro as per the weighted average exchange rate of the National Bank of Poland, which was from 3.52 EUR/PLN to 4.36 EUR/PLN [33]). In the first part of the research, basic methods of descriptive statistics were used to process the empirical data collected from the database so as to analyse the indebtedness of rural communes in Poland. The results were shown in boxplots. Tukey [34] introduced the boxplot to exploratory data analysis. In the third part of the research, discriminant analysis was used to build a model enabling prediction of excessive indebtedness of rural communes and identification of chief financial factors causing the risk of excessive indebtedness of these entities. This method was selected following a literature study and an attempt to build other models, e.g., a logit model, which, however, failed to deliver satisfactory results for the discriminant analysis.

Discriminant analysis is a classification method that is categorised as both a method of multidimensional statistical analysis and as a taxonomic method [35]. It is used for ordering and classification of economic and financial phenomena according to many explanatory variables at the same time [36–38]. Several assumptions needed to be verified in order to use this analysis. While the variables should follow a normal distribution, the discriminatory analysis is tolerant to a moderate violation of this assumption in the case of large samples. The model was built using Statistica software which checks the tolerance value [39,40]. Should that principle be violated, a wrong matrix message will be displayed, making it impossible to continue the analysis. The next assumption is about the sample size. In this case, the number of variables is adequate for the number of cases [40]. Because the discriminatory analysis is highly sensitive to outliers, the variables were scanned for outlying observations, which were subsequently removed.

There are different methods for undertaking discriminant analysis. The most common linear function was used to estimate the form of the discriminant model [41]:

$$Z_{ij} = \beta_0 + \beta_1 X_1 + \dots + \beta_k X_k \quad (1)$$

where:

$Z_{ij}$ —dependent variable for  $j$ -th item ( $j = 1, 2, \dots, n$ ) in  $l$ -th class (excessive debt—yes/no);

$\beta_0$ —discriminant function constant;

$\beta_1, \dots, \beta_k$ —discriminant function coefficients ( $i = 1, 2, \dots, k$ );

$X_1, \dots, X_k$ —explanatory variables ( $i = 1, 2, \dots, k$ ).

The objects under study are classified according to the estimated function value, which is usually a combination of several financial indicators (cf. [40,42,43], which clearly differentiate (discriminate) the collection of items. In order to allocate an item under study to a particular group, the discriminant function value of the total value of products of variables and function parameters (i.e., the indicators' weights) is compared with the limit value [44,45].

The discriminant function is a basic tool used in discriminant analysis. When adequate explanatory variables are selected, the function can be used to allocate an item (e.g., a commune) to a particular group of items [44,46]. As far as the prediction of financial factors causing the risk excessive indebtedness of local government units is concerned, discriminant analysis can be used to divide the rural communes under study into two separate classes: 0 and 1, referring to the communes unthreatened or threatened by the risk of excessive debt (dependent variable). The main period covered by the discriminatory model is 2012 to 2014. It was selected purposely because a large number of rural communes experienced debt problems at that time. This situation was preceded by the public finance crisis, which had reduced their incomes while intensifying pressure on the communes to make investments co-financed with available EU funds. Two subsequent discriminative models for the periods 2007–2009 and 2015–2017 were developed in order to carry out a comparative analysis of the main financial factors behind excessive indebtedness of Polish rural communes.

In our research, the rural communes, during the three years, where the average share of the total debt in the total income was greater than 50%, were classified as the communes with excessive debt. The authors of this paper defined the excessive indebtedness threshold as a situation where the ratio of total liabilities to total income is 50%. Until the end of 2013, the total liabilities/total income ratio was the official indebtedness indicator, and could not exceed 60% [47]. The authors set a more restrictive level because even a ratio of 50% meant financial problems for local government units. First of all, communes with such a high ratio of debt to total income had a poor credit rating, restricting their ability to access repayable instruments (loans). Secondly, local government authorities with a lower financial rating often relied on shadow-banking loans whose high interest rates posed a considerable risk of sending them into a debt spiral in the next years. What also needs to be emphasized is that even at the same level of debt (numerator), the ratio can vary in function of fluctuations in total income (denominator), which could drive a further several percentage point increase in the ratio, resulting in the commune going beyond the defined threshold.

A set of 18 financial indicators was used as explanatory variables showing the financial situation and functioning of the local government units under study. They served as predictors of the risk



of excessive indebtedness of local government units. The indicators recommended by the Ministry of Finance and by experts in local finance [48] were selected (later in this paper, you may find the characteristics of indicators taken into consideration when building the discriminatory model). The selection was also based on an overview of the literature and previous studies concerning the forecasting of the financial threat of local government units (cf. [43]). The variables were calculated as average values (medians) for three-year periods and they characterised the financial condition of local government units, especially referring to the financial independence and attractiveness of these entities. The time frames of this study were selected purposely because, as mentioned earlier, the communes considered reported the highest levels of debt at that time, translating into a risk of excessive indebtedness. Having made the substantive selection of discriminant variables, they were statistically verified. As a result of conducted statistical verification, due to a high correlation with the other variables, eight variables were eliminated from further analysis. In consequence, the model was based on the following ten variables (financial indicators) characterised by high discriminatory power:

- share of own incomes in total incomes (%),  $OI/TI$ ) which reflects the financial independence from the state budget and financial autonomy (the higher the ratio, the greater the local government's financial autonomy);
- the share of property (investment) expenditures in total incomes (%),  $PE/TI$ ) showing the scale of investments in relation to the entity's income potential (the higher the ratio, the greater the focus on development);
- share of remunerations and related expenditure in current expenditure (%),  $R/CE$ ), a ratio which shows the proportion between personnel costs and in-kind expenses, and therefore tells whether the incomes are distributed properly;
- the level of property (investment) expenditure per capita in PLN ( $PE/M$ ) showing the LGU's investment potential per inhabitant;
- fiscal wealth indicator per capita (in zlotys,  $FWI$ )—the indicator shows the commune's income potential, which is decisive to the economic power of local government units (The expenditure capacity is determined especially by the amount of income from local taxes received by the commune (agricultural tax, forest tax, property tax, vehicle tax, tax on civil law transactions, tax from the tax card income, income from the exploitation fee), which indicates the scale of an entity's fiscal wealth [49]);
- the level of income from income taxes which are state budget incomes in PLN per capita ( $IT/M$ ), reflecting the residential and economic attractiveness of the LGU (the higher the ratio, the greater the financial autonomy of the local government);
- the amount of EU funds accessed in PLN per capita ( $EU/M$ ), showing the activity and effectiveness of local authorities in accessing additional investment funds;
- the operating surplus in PLN per capita ( $OS/M$ ), reflecting the financial standing of the commune: its capacity to invest and incur debt;
- the share of operating surplus in total incomes (%),  $OS/TI$ ), showing the part of the total income potential accounted for by investment funds obtained primarily in the form of investment grants and savings from the current part of the budget;
- self-financing ratio ( $SFR$ )—the ratio refers to the share of operating surplus and property income in property expenditures. It indicates the extent to which a local government unit finances investments with its own funds, i.e., the financing capacity. The higher the ratio is, the lesser is the risk of losing financial liquidity due to excessive debt service costs. However, on the other hand, if the ratio is high, it may also indicate a low implementation of investments in relation to the potential of a particular local government unit.

Afterwards, the selected explanatory variables were standardized. Outliers (extreme values) were eliminated from the data set, as they could considerably affect the results of research. As a consequence, upon removal of outliers, 140 rural communes were found to be overindebted in 2012–2014. Thus, the main

discriminant model was based on 280 rural communes split into two equal groups. Group 1 consisted of 140 communes with a ratio of total debt to total incomes beyond 50%; Group 2 was composed of 140 randomly selected communes which did not exhibit overindebtedness in the study period.

### 3. Results and Discussion

#### 3.1. Functioning of Polish Rural Communes

Ever since Poland joined the European structures, much attention has been paid to rural development [49–51], also in the context of assessing the financial condition of rural areas, including excessive indebtedness [52–55]. Research carried out under the *Socioeconomic Development of Rural Areas in Poland* project by the Institute of Rural and Agriculture Development [56] and by the Foundation for the Development of Polish Agriculture [57] is of particular importance in this regard. The role of rural areas in the national economy is reflected by their area and population (as they make up over 90% of the national territory and are home to over 30% of the total population) [1].

Three administrative types of Polish basic local government units can be identified: urban communes (whose borders coincide with the limits of the commune capital city), rural communes (which do not include any cities) and urban-rural communes (which include both cities within their administrative boundaries and territories located beyond city limits). In 2017, there were 2478 communes, of which rural units (over 60% of the total number) and urban units (barely 13%) formed the largest and the smallest group, respectively [1]. The basic functions of rural communes continue to be related to agriculture. However, the ongoing processes and developments, including the increasing demographic and economic potential of rural areas (especially those located near big cities, i.e., metropolitan areas), contribute to changing the nature of functions fulfilled by rural areas. Indeed, many of them shift from a typical agricultural function towards a residential and service functional type [2]. At the same time, the needs of the local community keep growing, including in the area of technical and social infrastructure; and it is largely the responsibility of local government units to implement the relevant investments.

In Poland, the operational framework for financial management of local government units is provided in several documents, including the Constitution of the Republic of Poland [58], the Public Finance Act [59] and the Act on Incomes of Local Government Units [60]. In turn, the scope of municipal government activities is set forth in the Municipal Government Act [61] and the European Charter of Local Self-Government [62]. The foundation for municipal operations is the capacity to generate income and the ability and possibility to obtain revenue in an amount necessary to finance the needs of the local community. The European Charter of Local Self-Government (Article 9) [62] grants the right to sufficient own financial resources and the freedom to allocate them. Also, it specifies that the financial resources of local communities should be proportional to their competence, i.e., to the extent of tasks carried out by the local government. What matters from the perspective of communes is the guarantee that any changes in their tasks and competencies shall be accompanied by corresponding changes in the delivery and redistribution of dedicated funds [63].

Own income potential of municipal government units (which includes most sources of own incomes) is one of the drivers of stable local development. Own incomes of entities active in the local government sector are incomes that involve fiscal sovereignty and ownership of specific sources of income or the authority to introduce and develop specific incomes. In turn, as provided for in the Constitution of the Republic of Poland, own incomes of LGUs are incomes other than general subsidies and targeted grants from the state budget. In this sense, own incomes of LGUs also include incomes derived from their share in collected income taxes (personal income and corporate income taxes) which are state budgetary income. This is the very category of income which puts the LGUs in a position to make changes, including improving the development level of the socioeconomic infrastructure, enhancing innovativeness, and providing the local community with better conditions and standards of living. Own incomes of Polish communes mainly include local taxes and fees (e.g., property tax, agricultural tax, forestry tax), income taxes and funds derived from the sale and lease of property. At

the same time, the amount of own incomes per capita and their share in total incomes are among the main indicators of these units' financial autonomy [63–67].

In Poland, urban communes have by far the highest level of own incomes, which amounted to PLN 96.4 billion (EUR 22.6 billion) in 2017, i.e., PLN 320 million per commune (EUR 75.2 million). Because of their high demographic and economic potential, urban communes, especially big cities (metropolises), accumulate a large part of the total own incomes of communes. In absolute terms, rural communes have a distinctively small own income potential. In 2017, their total own income totaled barely PLN 18 billion (EUR 4.2 billion), which is only PLN 12 million per commune (EUR 2.8 million). Between 2007 and 2017, an enhancement was observed in the own income potential of basic Polish LGUs. The greatest increase in own incomes (by more than 95%) was found in rural communes; this could have been caused by the benefits they derive from suburbanization. Indeed, this process drives an increase in the demographic and economic potential of rural communes. As a consequence, many of them shift to another functional type which, in turn, translates into much greater tax revenues (Table 1).

**Table 1.** Selected indicators of financial management in Polish communes in 2007–2017.

Specification	2007	2008	2009	2010	2011	2012	2013	2014	2015	2016	2017
Level of own income in million PLN											
total	57,337.3	65,063.2	63,284.0	66,548.2	70,441.7	73,930.5	78,604.8	84,604.7	88,347.0	91,003.8	96,388.9
urban	39,188.2	43,932.8	42,461.0	43,988.7	46,112.3	47,945.2	50,868.8	54,535.7	56,702.7	58,383.3	61,543.6
urban-rural	9019.1	10,514.6	10,348.0	11,130.6	11,982.2	12,717.5	13,468.9	14,534.9	15,192.1	15,835.1	16,965.6
rural	9130.0	10,615.9	10,475.0	11,428.9	12,347.2	13,267.9	14,267.1	15,534.1	16,452.2	16,785.5	17,879.7
Level of own income level in PLN per capita											
total	1504.3	1707.0	1658.7	1727.8	1828.4	1918.6	2041.6	2198.4	2297.4	2368.3	2508.7
urban	2074.7	2332.8	2258.1	2333.1	2450.4	2552.8	2716.5	2920.5	3043.4	3142.8	3317.6
urban-rural	1063.2	1234.1	1205.7	1271.0	1361.7	1444.3	1530.1	1643.7	1713.7	1779.5	1898.0
rural	849.7	986.3	972.9	1048.1	1131.9	1212.1	1300.1	1416.3	1501.4	1532.7	1635.4
Share of own income in total income (%)											
total	55.2	58.2	54.9	52.7	53.1	52.9	54.5	55.4	55.8	51.6	50.8
urban	64.8	68.5	65.1	62.5	62.2	60.8	62.0	62.5	62.9	60.1	59.7
urban-rural	48.1	51.0	48.0	46.5	47.4	48.3	50.1	51.1	51.3	45.7	44.6
rural	37.1	39.3	36.8	35.9	37.1	38.5	40.3	41.9	42.7	37.8	36.8
Level of investment expenditure in PLN per capita											
total	530.7	621.2	729.9	840.6	785.9	673.7	631.6	747.7	687.4	477.8	662.8
urban	654.0	754.2	839.1	893.3	856.0	800.5	743.9	888.9	806.3	536.8	685.0
urban-rural	388.8	480.0	597.8	718.1	666.0	528.0	476.8	559.3	528.1	400.4	598.4
rural	426.7	500.8	644.8	848.0	761.9	573.9	564.9	659.6	614.4	440.7	677.8
Financial result in million PLN (surplus / budget deficit)											
total	1925.3	-2303.4	-1,0994.1	-1,2498.7	-8506.9	-2567.7	-135.1	-1922.8	2458.8	6098.4	-769.7
urban	1366.9	-1915.1	-7484.0	-6544.8	-5372.8	-2701.5	-567.6	-1349.5	1014.8	3266.5	-179.8
urban-rural	207.8	-323.9	-1791.0	-2517.6	-1399.1	-122.6	93.6	-189.7	511.6	1198.2	-298.7
rural	350.6	-64.4	-1719.0	-3436.3	-1735.0	256.4	338.9	-383.5	932.3	1633.7	-291.2
Relation of budget deficit to realised investment expenditure (%)											
total	×	9.7	39.5	38.6	28.1	9.9	0.6	6.7	×	×	3.0
urban	×	13.5	47.5	38.9	33.4	18.0	4.1	8.1	×	×	1.4
urban-rural	×	7.9	34.9	40.0	23.9	2.6	×	3.8	×	×	5.6
rural	×	1.2	24.7	37.1	20.8	×	×	5.3	×	×	3.9

×—In the years concerned, the types of communes covered by the analysis did not report a budget deficit (had a budget surplus instead). Hence, it is impossible to calculate the ratio between budget deficit and investment expenditure. Source: own study based on data from the Central Statistical Office of Poland [1].

Polish rural communes are characterized by the smallest own income potential per capita. They are mostly agricultural in nature, which results in low levels of income derived from property tax, personal income tax and corporate income tax; note that these are the main sources of own incomes for urban units. In 2017, own incomes collected by rural communes averaged at PLN 1635 per capita (284 EURO), i.e., over 60% less than in urban communes. In addition to having the smallest own income potential per capita, rural communes also prove to be the most heterogeneous in this regard (Table 1).

Note also that rural communes report the smallest financial autonomy, quantified with the share of own incomes in total incomes. In 2017, in rural communes, the share of own incomes in total incomes was barely 37%, compared to over 50% for an average municipality. Irrespective of the administrative type of territorial units covered by this study, a smaller share of own incomes in their total incomes

may be observed in 2009–2010 and in 2016–2017. In the first period, the reduced share of own incomes in total incomes (which means a decline in the levels of financial autonomy) resulted from smaller amounts of taxes being levied to finance the municipal budgets; but in 2016–2017, the tax receipts were growing. Therefore, the reduction in the contribution of own incomes to total incomes of the LGUs under consideration was the consequence of larger budgetary incomes drawn from non-fiscal sources. Indeed, transfer incomes from the state budget (mainly including targeted grants allocated to delegated tasks) have grown considerably since 2016. This is because the benefits under the Rodzina 500+ program (put in place in Poland in 2016 to support large families) are disbursed through the municipal budget. The extent of this support measure is so large that it prevents the proper interpretation of the indicator discussed. Therefore, when analyzing the decreasing level of own incomes in total incomes, it must be benchmarked against the increasing level of own incomes per capita. The above means that the financial autonomy of basic Polish LGUs does not decline [67].

LGUs must invest in order to ensure economic development within their territories. In Poland, local government units make up a considerable part of economic processes. As part of their own tasks, they take investment measures to improve the conditions and standards of living for the population through development processes and improvements to technical and social infrastructure. Measures are also taken to attract capital, which stimulates the creation of new jobs. In relative terms, the biggest investment expenditure is incurred by urban communes, especially in urban districts and in the largest ones (metropolises). In 2017, investment expenditure incurred by urban communes was PLN 685 per capita (EUR 180.9), compared to PLN 678 per capita (EUR 159.2) in rural communes. According to Dolewka [68] and a number of other researchers, practice demonstrated that big cities allocate greater financial resources to infrastructural development; this results from a different scale of needs which are primarily caused by the number of residents. Although rural communes have a smaller investment potential than other municipality types, they recorded the highest growth in investments over the study period. However, the increase in investment expenditure resulted in a greater budget deficit; that trend prevailed in municipal government units practically throughout the period covered by this study (Table 1).

Undoubtedly, the global economic crisis which occurred during the study period had an adverse effect on the budgetary performance of Polish communes. Indeed, the local finance crisis resulted in decreasing the level of own income potential of all local government units. A study by Kozera [69] suggests that over 60% of rural communes experienced a clear reduction in own incomes between 2008 and 2009. The decline in own incomes of rural communes was especially due to income streams, which depend on the economic situation, primarily including incomes derived from the share in personal and corporate income taxes. It perpetuated the fiscal imbalance manifested through growing budget deficits and the deteriorating operational performance (reduction in the operating surplus or increase in operational deficit). The rapid decline in financial performance in both rural and other types of communes was observed in 2009–2011. At that time, their total budget deficit reached the peak level. Rural communes recorded the highest budget deficit (a total of PLN 3436.3 million—EUR 860.2) in 2010. In 2009–2011, a budget deficit was reported by 70% of all rural communes [30]. However, the way the funds derived from the deficit are spent sometimes fails to comply with that rule. When analyzing the ratio between the budget deficit and investment expenditure of Polish communes, it can be noticed that peak levels were recorded in 2009–2011. The average budget deficit/investment expenditure ratio was nearly 25% in 2009 and went up to over 37% in 2010 (Table 1).

### 3.2. The Indebtedness in Poland between 2007 and 2017

Today, public debt is a problem faced by most market economy countries. That economic category is commonly defined as total financial liabilities of public authorities caused by the excess of expenditure over income. Recently, the world has experienced a sharp increase in public debt levels. In the 1990s, public debt was also recorded in economies in transition, including Poland. This was the consequence of public finance disruptions that accompanied the economic transformation. In recent years the financial and economic crisis resulted in serious challenges being posed to many European governments [70].

In the study period (2007–2017), the average level of public debt expressed as a percentage of GDP went up from 61.7% to 82.1% in European Union countries. When comparing the 2007 and 2017 figures, note that only three countries (Malta, Denmark and Bulgaria) recorded a decline in debt levels. It was the opposite in other countries, especially in Greece, Portugal and Spain which are among the most indebted economies. In Poland, the debt/GDP ratio in 2007 and 2017 was 45% and 50.6%, respectively. This is a safe level because, in accordance with national and Union legislation, the state-level public debt ratio cannot exceed 60% [71].

When comparing the levels of state-level public debt in Poland between 2017 and 2007, note that it grew by over 82%, from PLN 527.4 billion to PLN 961.9 billion (from EUR 139.4 billion to EUR 225.9 billion). Of the three sectors that generate state-level public debt, the government sector had the greatest contribution; in the study period, it varied in the range of 94.8% (2007) to 92.8% (2017) of total state debt. Its decreasing importance in the debt structure results from the fact that local government debt grows at a faster rate. In 2007, that sector accounted for PLN 24.5 billion (EUR 6.5 billion) of debt (4.9% of state-level public debt) and reached as much as PLN 69.5 billion (EUR 16.3 billion) (7.8% of state-level public debt) in 2017. When comparing the growth rates between the sectors considered, it can be noticed that local government debt grew quickest (and nearly doubled) whereas government debt grew by a half and social insurance debt decreased by 96% as a result of open pension funds being transferred to the Social Insurance Institution. It needs to be emphasized that local government debt reached the highest level (PLN 60–70 billion—EUR 14.5–16.7 billion) in 2011–2015, contributing 8–9% to state-level public debt (Table 2).

**Table 2.** Level and structure of state-level public debt in Poland by sectors in 2007–2017.

Sector	2007	2008	2009	2010	2011	2012	2013	2014	2015	2016	2017
The level of public debt (in billion PLN)											
Government	500.2	566.9	623.6	692.4	748.8	770.8	813.5	755.0	805.1	895.6	892.3
Local government	24.5	28.1	39.3	53.5	64.3	67.4	68.4	71.7	72.1	69.6	69.5
of which communes	10.0	10.8	14.6	21.9	26.0	26.2	25.8	26.4	25.4	23.9	24.9
Social security	2.7	2.8	7.0	2.0	2.3	2.3	0.4	0.1	0.1	0.1	0.1
Total	527.4	597.8	669.9	747.9	815.4	840.5	882.3	826.8	877.3	965.3	961.9
The structure of public debt (%)											
Government	94.8	94.8	93.1	92.6	91.8	91.7	92.2	91.3	91.8	92.8	92.8
Local government	4.9	5.0	6.3	7.7	8.6	8.7	8.4	9.5	9.0	7.8	7.8
of which communes											
as % local government	40.8	38.4	37.2	40.9	40.4	38.9	37.7	36.8	35.2	34.3	35.8
as % total	1.9	1.8	2.2	2.9	3.2	3.1	2.9	3.2	2.9	2.5	2.6
Social security	0.5	0.5	1.0	0.3	0.3	0.3	0.0	0.0	0.0	0.0	0.0

Source: The authors' compilation based on [72–74].

The level and growth of local government debt were heavily impacted by debt generated by communes, Polish basic LGUs. From 2007 to 2017, municipal debt grew by PLN 14.9 billion (EUR 3.5 billion), i.e., one-and-a-half times. Considering the individual components of local government debts, municipal debt had the largest share, varying in the range of 40.8% in 2007 to 35.8% in 2017. Although it moved down in the structure of local government debt (the indebtedness of other LGUs grew at a faster rate), its share in the structure of total debt increased (Table 2).

### 3.3. The Indebtedness of Rural Communes in Poland between 2007 and 2017

Polish law imposes restrictions on debt levels. They result not only from decisions made by national authorities but also from international agreements (Poland signed the fiscal compact in 2013) and membership in integration groupings (Poland joined the European Union in 2004). Pursuant to a provision of Chapter X of the Constitution of the Republic of Poland, it is prohibited to raise loans or to provide guarantees as a consequence of which the government debt would exceed 3/5 (60%) of GDP (Article 216, Para. 5 [58]). The debt ratios are also regulated under the Public Finance Act. It primarily imposes some restrictions on the way the LGUs may enter into commitments, and provides for prudence and recovery procedures applicable to entities of the public finance sector if the ratio of government debt to GDP (and the ratio to GDP of the amount resulting from the conversion of

government debt to the Polish currency based on the arithmetic mean of average currency exchange rates published by the National Bank of Poland within a budget year, in the case of debt expressed in foreign currencies), less spare funds of the Ministry of Finance, exceeds 55% [75]. Until the end of 2013, the indebtedness of communes was limited by the ratio of total debt to total incomes (Article 170 [46]). From 1 January 2014, the debt incurred within a year cannot exceed the average operating surplus from the last three years (Article 243 [59]). The new debt indicator is an individual restriction for local government units. It is particularly beneficial to local governments with a large income potential that translates into a strong collateral for loans. In turn, the indicator previously used as a debt limit (ratio of total liabilities to total income) offers a very important advantage: it allows us to compare the figures between different local government units, and therefore the Ministry of Finance continues to present it as one of key yardsticks of financial condition of LGUs. As a consequence, the total liabilities/total income ratio is the one used in this paper as an indicator of indebtedness.

Communes are basic local government units. They implement the largest number of public tasks assigned to the entities of the local government sector in Poland. We can distinguish between three administrative types of communes: urban, rural and urban-rural communes. Rural communes are the largest group because they make more than 60% of the total number of communes in Poland and they are the most diversified group of commune governments among all administrative types. These communes are characterised not only by their fundamental agricultural function but also, especially in recent years, they have been losing this function in favour of the service-providing and residential functions, which are characteristic of other administrative types. Due to the progressing suburbanisation processes, they are the most convenient places to live and run a business. Thus, they are becoming a residential, production and logistic base. On the other hand, communes with natural values are often transformed into specialised centres of tourism and recreation. In communes with natural resources, the development of other than the industrial function usually does not make sense. The industry often becomes the main source of income for the local community. The change in the significance and role of rural communes results in a larger number of investments adjusted to the needs of new inhabitants, investors and tourists. The implementation of these tasks requires considerable funds. On the one hand, the authorities of communes feel the competitive pressure of other local governments. On the other hand, they feel that they have a unique opportunity to use the EU funds and make numerous capital-intensive investments with a minimal amount of their own funds. In order to create local development and increase the attractiveness of rural areas for residential and business investments, the authorities of communes use all possible financial sources. They increasingly tend to use repayable sources.

Rural communes increasingly use repayable funds to implement investments. This fact is proven by the change in the average amount of total liabilities per capita (Table 3). From one year to another, the average value (median) of this indicator has been increasing in the local governments under study. It rose from 268 zlotys (EUR 71) in 2007 to 898 zlotys (EUR 218) per capita in 2011 (i.e., by 227%). Then it slightly decreased to 751.9 zlotys (EUR 205) per capita in 2017 (i.e., by 4%). It is necessary to note that during the entire period under study, in rural communes, the median of the total debt per capita in zlotys was lower than in urban-rural communes or in urban ones. It is noteworthy that there was not only an increase in the total debt of rural governments but also we could observe increasing differences between entities in the amount of their debt due to the growing number of communes with excessive amounts of debt. In 2011, when this indicator reached the greatest value, there were 239 communes where the debt per capita exceeded 1500 zlotys (EUR 264). In the commune of Rewal, the indicator amounted to 6400 zlotys (EUR 1553) per capita. In 2017, 235 communes exceeded the limit of 1500 zlotys. In the commune of Ostrowiec, the debt per capita exceeded 18,000 zlotys (EUR 3106), whereas in the commune of Rewal, it exceeded 14,000 zlotys (EUR 8841) [32].

Table 3. The level of total liabilities of communes classified according to the administrative type in Poland between 2007 and 2017 (%).

Specification	Debt per Capita (in Zlotys)										
	2007	2008	2009	2010	2011	2012	2013	2014	2015	2016	2017
	Median										
total	312.5	311.6	448.7	799.2	948.9	939.1	921.4	929.7	764.5	706.5	734.7
urban	426.9	439.3	622.9	859.9	983.3	997.3	1012.0	1021.6	935.0	855.5	870.0
urban-rural	392.9	400.6	559.9	900.9	1060.5	1049.7	1038.2	1064.7	994.5	922.5	963.0
rural	267.7	267.7	368.6	739.5	897.8	873.5	846.2	859.1	774.2	706.0	751.9
	Range										
total	2570.3	4264.9	7161.9	6408.5	6414.3	7951.8	35,603.7	37,434.5	36,962.0	30,241.1	20,038.6
urban	2570.3	1815.4	2269.3	3090.9	4066.4	4610.3	4422.6	5576.3	3767.9	2720.2	3972.8
urban-rural	2415.4	2566.5	3052.5	3110.8	3998.5	3428.1	4220.5	4688.0	5544.5	5321.0	12,130.5
rural	2136.2	4264.9	7161.9	6408.5	6414.3	7951.8	35,603.7	37,434.5	36,220.0	30,172.5	18,676.2
	Coefficient of variation * (%)										
total	61.4	69.4	61.7	42.3	39.6	40.8	40.7	41.6	55.9	57.2	58.1
urban	46.2	45.8	38.8	31.1	32.4	33.7	28.3	25.0	30.3	34.7	38.1
urban-rural	45.9	57.1	47.9	33.1	30.9	32.6	32.9	35.5	40.2	43.9	41.8
rural	65.8	75.9	74.0	48.9	43.7	45.9	46.6	47.0	52.3	56.3	55.5
	Number of communes with debt per capita exceeding 1500 zlotys										
Total	15	19	53	218	379	408	353	433	382	334	404
urban	2	3	6	24	33	36	27	39	35	32	36
urban-rural	4	5	19	60	107	124	108	131	131	115	133
rural	9	11	28	134	239	248	218	263	216	187	235

\* : positional measure. Source: the authors' compilation based on data published by the Ministry of Finance [32].

The overall increase in the amount of communes' debt resulted in an increase in the average share of total liabilities in total income. Until the end of 2013, 60% was the maximum limit allowed by law [32,46]. Until 2011, the median of this indicator was increasing in local government units (Table 3, Figure 1). Also the range between the maximum and minimum value of the share of total liabilities in the total income of communes was increasing systematically. In 2007, the maximum amount of debt exceeded the statutory limit only by 5%, but in 2017, it exceeded the limit by over seven times. It shows that there is a growing number of communes facing the problem of increasing indebtedness.

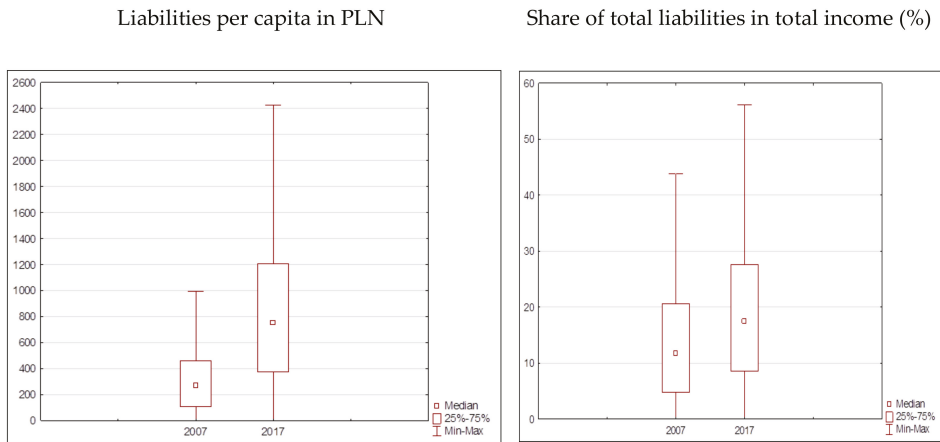

**Figure 1.** A box-plot for total liabilities per capita (in zlotys) and the share of total liabilities in total income (%) in rural communes in Poland between 2007 and 2017. Source: the authors' compilation based on data published by the Ministry of Finance [32].

The comparison of individual groups of administrative units shows that rural communes were the least indebted group during the whole period under study. The median of the share of total liabilities in the total income of rural communes was 2–4 p.p. smaller than the median for the other administrative types. However, it is necessary to note the fact that this group of local government units was characterised by the greatest increase in the total debt. Simultaneously, this group was characterised by the greatest coefficient of variation and range in all the communes; it was equal to the maximum value of the debt indicators. It shows that this group of local government units was the most diversified in its indebtedness. During the whole period under study, there was high diversification, reaching the highest level between 2007 and 2009, i.e., nearly 70%. Later it dropped to about 40%. The increase in the median of the indicator under analysis and the increase in the coefficient of variation show that the group of rural communes facing the problem of growing indebtedness is becoming larger. It is noteworthy that regardless of the administrative type, in each group there were entities which exceeded the limit of the maximum share of the total debt in total income. However, among rural communes there were local governments with the biggest problems (Table 4).

There was a significant number of communes where the share of liabilities in the total income exceeded the limit of 50%, which was assumed in this study. In 2017, nearly 5% of rural communes exceeded this limit. It is noteworthy that it was the largest group among the administrative types under analysis. It is necessary to note that the number of communes which exceeded the limit of 50% for the indicator in question was the largest in 2011, when the total debt reached the highest level. It may have been caused by the fact that at the time many expensive investments were being financed with a share of EU funds. In 2007, there were only 20 communes in this group. In 2011, there were 252, whereas in 2017, there were 91 (Table 4).



**Table 4.** The share of total liabilities in the total income of communes classified according to the administrative type in Poland between 2007 and 2017 (%).

Specification	Share of Debt in Total Income (%)										
	2007	2008	2009	2010	2011	2012	2013	2014	2015	2016	2017
	Median										
total	14.3	13.3	18.0	28.6	32.7	31.6	29.7	29.4	25.6	20.3	19.3
urban	18.9	17.5	26.6	32.5	35.4	35.8	33.9	31.7	29.2	22.7	21.4
urban-rural	17.9	16.8	22.4	33.4	37.2	35.0	34.1	33.1	30.3	24.0	23.3
rural	11.7	10.9	14.2	25.8	29.8	28.0	26.7	26.3	23.0	18.1	17.4
	Range										
total	64.7	88.8	83.6	106.0	129.7	146.0	259.0	304.2	405.7	360.8	437.3
urban	54.4	52.4	61.1	86.1	95.3	94.9	80.1	78.6	74.1	66.8	69.5
urban-rural	64.0	62.1	78.5	83.1	129.7	99.6	106.4	93.9	129.2	89.1	275.9
rural	64.7	88.8	83.6	106.0	110.7	146.0	259.0	304.2	405.7	360.8	437.3
	Coefficient of variation * (%)										
total	57.6	64.6	60.6	42.2	38.0	39.8	38.6	39.2	43.8	48.8	49.0
urban	41.5	48.3	38.1	33.4	30.0	30.3	27.4	26.1	25.0	30.3	33.5
urban-rural	45.2	53.5	48.2	34.1	28.4	32.0	32.1	33.5	35.5	39.9	41.8
rural	66.5	74.6	72.7	47.5	41.8	44.6	44.0	43.7	48.1	53.9	54.7
	Number of communes with share of liabilities in total income exceeding 50%										
total	34	27	82	258	439	339	292	268	215	98	91
urban	2	2	13	30	45	39	27	19	16	4	7
urban-rural	12	9	31	79	142	122	111	102	82	36	31
rural	20	16	38	149	252	178	154	147	117	58	53

\* : positional measure. Source: the authors' compilation based on data published by the Ministry of Finance [32].

There were similar statistics for the debt of urban and urban-rural communes. The debt indicator increased from 17–18% in 2007 to 35–37% in 2011, and then it dropped to 21–23% in 2017. In 2017, the most indebted urban communes were Świeradów-Zdrój (69.5%), whereas the most indebted urban-rural communes were Byczyna (275.9%), Lubsko (84.8%) and Myślenice (77.4%). In comparison with 2007, in 2017, the average debt of urban communes increased by 103.8%, whereas the average debt of urban-rural communes increased by 145.1%. It is necessary to add that the group of urban communes was more homogenous in terms of the indicator value, whereas urban-rural communes were more diversified. This fact is proved not only by the high coefficient of variation but also by high maximum values, which also indicate the range (Tables 3 and 4).

### *3.4. Identifying the Financial Risk Factors of Excessive Indebtedness of Rural Communes by Means of Discriminant Analysis*

The first step in identifying the financial factors behind excessive indebtedness of rural communes based on the discriminative analysis was to pick the units at excessive debt levels, defined as those with a liabilities/total income ratio above 50%. That group was by far the largest in 2012–2014, with 140 units (i.e., nearly 9% of all rural communes in Poland). Research suggests that excessive debt levels are found in rural communes of different functional types. However, typical units affected by excessive indebtedness are agricultural communes with a tourist function (nearly 17% of all communes of that type recorded excessive debt levels) and communes with residential and service functions (over 15% of all communes of that type). Conversely, agricultural communes were less frequently affected by excessive indebtedness (only 6% of them; the calculations are based on author's research presented in [2]). The key investment target for the authorities of tourist communes (located mainly in northern and southern Poland) was the enhancement of tourist and similar infrastructure. In turn, communes with residential and service functions (located in main metropolitan centers, in the immediate vicinity of big cities) mainly invested in the technical and social infrastructure. This was driven, on the one hand, by the needs of tourists, new residents or entrepreneurs and, on the other, by the capacity to meet these needs by accessing EU financing instruments. The purpose of investments implemented by communes (financed or co-financed with repayable funds) is to make the region more attractive (e.g., in terms of tourism or residential aspects). As a consequence, local government units derive more revenue from various types of local taxes (e.g., property tax, personal income tax) and local fees (e.g., visitors taxes, resort taxes). Usually, financial problems affecting these local government units resulted from the implementation of large-scale investments, sending them into a debt spiral. This is because the banks denied credit to them whereas shadow banks were eager to grant loans at an interest rate three times that charged by the banks [76].

Table 5 presents a selection of socioeconomic characteristics of rural communes at excessive debt levels and those with a debt maintained within one-half of their budgets. Heavily indebted communes demonstrate more favorable socioeconomic indicators than those which do not report excessive debt. Rural communes at high debt levels witnessed a higher positive net migration rate and a higher share of councilors with a higher level of education. Also, heavily indebted communes reported rapid growth of entrepreneurship as the number of operators entered to the REGON register per 10,000 population was much higher than in other rural communes. At the same time, residents of excessively indebted communes were more socially active as they establish foundations, associations and social organizations (Table 5).

**Table 5.** Socioeconomic characteristics of excessively indebted Polish rural communes in 2012–2014 (average (median) values).

Specification	Rural Communes in Which the Share of Total Liabilities in Total Revenues		<i>t</i>	<i>p</i>
	Was Less than 50%	Was Higher than 50%		
Share of arable land in total area (%)	66.92	58.92	5.06	0.00
Population at non-working age per 100 persons at working age	59.96	58.99	2.20	0.03
Migration balance per 1000 people	0.09	1.76	−3.62	0.00
Percentage of councilors with a high level of education (%)	28.08	31.66	−2.75	0.01
Percentage of population using the sewage system (%)	37.03	42.73	−2.49	0.01
Percentage of population using the gas network (%)	15.56	20.95	−2.41	0.02
Average floor area of the flat per person	28.26	29.21	−2.30	0.02
Entities entered in the REGON register per 10,000 population	687.76	800.16	−4.93	0.00
Newly registered units in the REGON register per 10,000 population	64.26	75.55	−4.69	0.00
Foundations, associations and social organizations per 10,000 population	32.38	34.76	−2.38	0.02

Source: the authors' calculations based on data published by the Central Statistical Office [1].

The discriminant model of the risk of excessive indebtedness of rural communes was built in four stages. At the first stage, the aim of the study and classification criteria were defined, and a group of local government units was selected for analysis. The aim of the study was to build a discriminant model enabling prediction of the danger of excessive indebtedness of rural communes and identification of the financial factors of excessive indebtedness of these entities. The model includes ten financial indicators selected based on substantive and statistical criteria (Step 2).

The first step of the research method consisted of entering the share of the operating surplus in total income ( $OS/TI$ ) as a variable. It was characterised by the greatest discriminatory power due to the greatest  $F$  statistic value (Table 6). Further steps involved entering the share of own income in total income ( $OI/TI$ ) and the amount of the EU funds in zlotys per capita ( $EU/M$ ) as variables. The third step was the final one, because the other variables did not have sufficient discriminatory power due to the low  $F$  statistic value. Table 7 shows the data characterising the variables in the model. The critical significance level  $p$  shows that the variables significantly contributed to distinguishing between rural communes threatened or unthreatened by excessive indebtedness. The value of partial Wilks' lambda indicates that the  $OS/TI$  variable had the greatest discriminatory contribution.

**Table 6.** The results of an analysis of the discriminant function (stepwise progressive method).

Step	Number of Variables	Last Variable Entered	Wilks' Lambda	$F$
Step 1	1	$OS/TI$	0.9742	13.87
Step 2	2	$OI/TI$	0.9118	3.51
Step 3 (final step)	3	$EU/M$	0.9028	2.01

Source: the authors' calculations based on data published by the Ministry of Finance [32] and Central Statistical Office [1].

**Table 7.** A summary of analysis of the discriminant function.

Variable	Partial Wilks' Lambda	Toleration	<i>p</i>
<i>OS/TI</i>	0.9143	0.9515	0.0003
<i>OI/TI</i>	0.9769	0.9157	0.2310
<i>EU/M</i>	0.9866	0.9451	0.0358

Source: as in Table 2.

Canonical analysis was conducted in order to obtain the discriminant function coefficients. It resulted in raw and standardised coefficients. Raw coefficients are better suited for classification. The estimated discriminant function with raw coefficients had the following form:

$$Z = 0.6524 + 5.5928 OS/TI - 0.5843 OI/TI - 0.6187 EU/M \quad (2)$$

In an interpretation of the parameter values in the estimated model, we can say that the smaller the share of the operating surplus in total income is as well as the greater the share of own income in total income and the amount of the EU funds in zlotys per capita are, the lower the discriminatory value of the function and the higher the risk of excessive indebtedness of a local government unit. The study revealed that the risk of excessive indebtedness is most likely to occur in the rural communes that are more financially independent and those that make intensive investments in socioeconomic development by acquiring EU funds for this purpose.

According to the rule of co-financing, the EU funds are supposed to supplement local government entities' own funds, but they should not replace them. It is required that the commune should make its own contribution. Additionally, it is necessary to stress the fact that the funds received from the EU for a project must be repaid. This solution may also influence the commune's financial liquidity [77]. Due to the fact that local government entities' own income is limited, especially in rural communes, it is increasingly often replaced by repayable instruments received by a local government unit. It is necessary to remember that although it is possible to finance investments with repayable funds, the resulting excessive indebtedness causes future instability of public finance. Local authorities should assess the efficiency of investment expenditure because large amounts of liabilities to be paid by future generations may inhibit the socioeconomic development of these entities not only on a local but also national scale. Note that the procedure for calculating the debt ratio of local government entities had changed in recent years. The debt related to the implementation of EU projects is not taken into account when calculating the debt ratio [32]. The objective of this amendment was to help the communes finance their own contribution with debt instruments. Therefore, it drove interest in, and expanded the use of, repayable instruments.

The share of the operating surplus in total income proved to be an important financial risk factor of excessive indebtedness of rural communes. The lower the ratio is, the higher the risk of excessive indebtedness of a particular commune. An operating surplus indicates investment capacity, and it is the source from which a local government unit can pay its liabilities. Since 2014, it has been the parameter determining the indebtedness threshold according to the algorithm [46]. According to Dylewski [78], relatively low capacity to generate an operating surplus may be a financial risk factor causing excessive indebtedness not only in rural communes but also in other entities of the local government sector. It may also be a barrier blocking the possibility to finance, pre-finance or participate in financing new investments in the financial perspective of 2014 to 2020. Since 2014, there have been new legal regulations concerning the maximum debt of local government units. Individual creditworthiness is determined for each local government unit. It is an individual debt indicator calculated from the mean operating surplus in the last or three or seven years (the changes take effect gradually).

Having determined the discriminant function, the fourth stage consisted of specifying the limit according to which a particular local government unit could be classified into the group of rural communes threatened by the risk of excessive debt or into the group of unthreatened communes. The limit value

between the groups is 0 because the discriminant function is estimated by means of a sample with the same number of communes in both groups (cf. [79]). The population of rural communes is classified according to the values of the discriminant function ( $Z$ ). Table 8 shows the results of the classification of the communes under study, where  $Z_{limit} = 0$ . According to Wisniewski, [43] stresses the fact that the accuracy of classification is the most measurable empirical evaluation of the quality of the estimation model. The classification matrix shows that the overall accuracy of classification was relatively high and amounted to more than 60%. In investigations of the risk of bankruptcy of different entities, the so-called grey zone is also determined. It is an interval of values with both positive and negative results (cf. [37]).

**Table 8.** The accuracy of classification of rural communes in Poland according to the estimated discriminant function ( $Z_{limit} = 0$ ).

Actual Grouping of Communes	Classification Correctness (%)	Communes Classified According to Model	
		Class 1	Class 2
Class 1—communes threatened by excessive indebtedness	62.1	87	53
Class 2—communes unthreatened by excessive indebtedness	62.1	53	87
Total	62.1	140	140

Source: as in Table 2.

Rural communes were categorised into one of three groups, according to the following limits: I ( $Z < -0.5$ )—rural communes with high risk of excessive indebtedness, II ( $-0.5 \leq Z \leq 0.5$ )—grey zone (rural communes requiring in-depth analysis), III ( $Z > 0.5$ )—rural communes unthreatened by excessive indebtedness (Table 9). The discriminant model based on these limits had a high prognostic accuracy of near 70.0%. The rural communes with the grey zone value of function  $Z$  cannot be allocated either to the group of local government entities threatened by excessive indebtedness or the group of unthreatened entities. Their financial situation needs to be given in-depth analysis.

**Table 9.** The accuracy of classification of rural communes in Poland according to the estimated discriminant function (class 1:  $Z < 0.5$ , class 2:  $Z > 0.5$ , grey zone:  $-0.5 \leq Z \leq 0.5$ ).

Actual Grouping of Communes	Classification Correctness (%)	Communes Classified According to Model		
		Class 1	Class 2	Grey Zone
Class 1—communes threatened by excessive indebtedness	69.7	53	23	64
Class 2—communes unthreatened by excessive indebtedness	69.0	27	60	53
Total	69.3	80	83	117

Source: as in Table 2.

The discriminative model of excessive indebtedness of rural communes in 2012–2014 was compared to models built based on 2007–2008 and 2015–2017 data (Table 10). The analysis of discriminative models developed in this study suggests that the main factors of risk of excessive indebtedness facing rural communes in 2007–2009 were the self-financing capacity, own potential income, and access to European Union funds. The analysis of signs of the model's parameters shows that the higher the self-financing indicator, and the lower the share of own income in total income, and the lower the share of own incomes in total incomes, and the lower the share of EU funds accessed per capita, the smaller are the values of function  $Z$  and, thus, the greater is the risk of excessive indebtedness facing the communes. Therefore, in 2007–2009 (i.e., at the beginning of the financial perspective of 2007 to 2013), debt was mainly incurred by communes at lower levels of own income potential which until that time did not access EU funds. However, the model needs to be interpreted with caution because of the

poor representativeness of the sample (as only 15 rural communes experienced excessive indebtedness in the study period). In turn, in 2015–2017, the financial factors of risk of excessive debt facing the rural communes were similar to those identified in 2012–2014, a period where excessive indebtedness of communes became most widespread. The analysis of the signs of the model's parameters shows that the higher the own income potential (the higher the share of own incomes in total incomes), and the lower the share of the operating surplus in total incomes, the higher are the values of function  $Z$  and, thus, the greater is the risk of excessive indebtedness facing the communes. Hence, in recent years, excessive indebtedness was a risk faced mainly by communes at higher levels of own income potential, mostly including those, which in addition to their agricultural function, also had residential, service and tourist functions. In order to improve their competitive edge over other communes, they willingly invested in local development by accessing repayable sources of financing.

**Table 10.** Estimated discriminatory functions of risk of excessive indebtedness of Polish rural communes.

Specification	Years		
	2007–2009	2012–2014	2015–2017
Form of estimated discriminant function ( $Z$ )	$Z = -0.8463 \text{ SFR} + 0.5753 \text{ OI/TI} + 0.5177 \text{ EU/M}$	$Z = 0.6524 + 5.5928 \text{ OS/TI} - 0.5843 \text{ OI/TI} - 0.6187 \text{ EU/M}$	$Z = -1.3031 \text{ OI/TI} + 1.2272 \text{ OS/TI}$
Correctness of classification (%)	80.0%	61.8%	68.8%
Size of sample of excessively indebted communes	15	140	61

Source: as in Table 2.

### 3.5. Discussion

As shown by the analysis of excessive indebtedness or, generally, of the fiscal health of public entities, there are multiple assessment methods and groups of indicators used in measuring these developments. This results in considerable disagreements [26,80,81]. In the US alone, several states have developed their own systems for measuring the fiscal condition of their local governments [82]. An indicator-based analysis is among the proposed measurement methods [83]. Note however that the selection of indicators is problematic. For instance, Finkler, Smith, Calabrese and Purtell [84] recommend 19 different indicators while others rely on 29 indicators [85]. One of the most widely used measurement systems is Brown's 10-point test [86]. The test consists of 14 indicators, many of which were also used in the assessment procedure in this paper (with respect to expenditure and income, including tax income). According to Maher and Nollenberger [80], they are relatively simple to use. In turn, Wang, Dennis and Tu [26] relied on the solvency test with 11 indicators relating to cash, budget, long-run, and service. Note that they consider the calculation of surpluses/deficits, which were also used in this paper.

It needs to be emphasized that the discriminatory analysis can be used in forecasting a disadvantageous financial situation. Rarely used with respect to public entities, it mostly serves to forecast business failures. In Poland, E. Mączyńska [45] was the first one to develop a linear model of a discriminatory function of the risk of business failure. Research was also carried out by D. Hadasik, A. Hołda, M. Hamrol and many other scientists [87,88].

Considering the variables of the discriminatory model, the studies corroborate the findings by other authors. Some researchers, including Filipiak [89], believe the insufficient amount of non-repayable financing and the restricted financial autonomy of communes to be among the reasons behind local government debt. As noted by Dafflon and Beer-Toth [90], debt is one of the natural ways to fulfill a unit's tasks. It provides an alternative way of financing, especially if the LGU does not have enough own funds, and evidences its efficiency in using all available sources of financing. The importance of financial autonomy for the risk of excessive indebtedness is also indicated in research by Kata [91]. He

believes that a dangerous situation occurs if municipal finance is threatened by several risks, e.g., high indebtedness accompanied by low levels of financial autonomy. Standar and Kozera [52] used such a discriminatory model in examining one of the Polish regions. Their findings were very much the same. The regional model covered four variables and the share of investment expenditure per capita. This formed a basis for drawing conclusions on whether that method is useful in this kind of studies.

### *3.6. Political Implications*

Both the European Union and national legislation imposes restrictions on public debt, including in the public finance sector. When it comes to European Union law, the Treaty on the Functioning of the European Union [92] stipulates that the stock of government debt, in addition to deficit restrictions, is the criterion used by the Commission to examine compliance with budgetary discipline in member states (Article 126), and defines what is referred to as the Excessive Deficit Procedure (EDP). The Protocol on the Excessive Deficit Procedure [93], as enclosed to the Treaty on European Union and the Treaty on the Functioning of the European Union [92], defines debt and sets the baseline for the public debt/GDP ratio at 60%. Council Regulation (EC) No. 479/2009 of 25 May 2009 [94] specifies the titles of public debt. In turn, Regulation (EU) No. 549/2013 [95] of the European Parliament and of the Council of 21 May 2013 on the European system of national and regional accounts in the European Union (ESA 2010) defines the categories of financial liabilities and the general government sector. In the Polish legislation, the following legal acts are of key importance in that respect: Constitution of the Republic of Poland, and Public Finance Act [96].

The growing debt of the Polish public sector, including at the commune level, resulted in amendments to legal regulations. First of all, a new solution was introduced for calculating the debt limits. The objective was to customize the safe debt indicator and make it dependent upon financial standing (the previous algorithm failed to do so). Also, some other issues were regulated, including the implementation of resolution measures for local government units at risk of jeopardizing their public tasks. Steps taken in such circumstances include restricting new investments so as not to generate more debt and restricting the expenditure on compensation of the management and councilors. At the same time, with a more stringent debt limit, in order to increase the local government units' capacity to absorb European Union funds, the restrictions provided for in the Public Finance Act were eased. The debt ceiling does not apply to some items any longer, including interest on debt incurred to implement projects co-financed by the European Union, and the debt incurred to co-finance the expenses under an EU program, project or task which is more than 60% subsidized by the EU [75]. Also, since 2011, local governments have been required to establish multiannual financial forecasts. This is how the scope of published forecasts of debt levels and servicing costs was extended. It is an important aspect of local budget planning. The significance of changes in that respect is reflected by the fact that in recent years, commune offices have established separate organizational units to deal with debt issues. According to many experts in this field, e.g., Halaburda [97], these changes consist of handing the responsibility for the growing public debt over to local government units. These solutions give rise to doubts, especially in a situation where the government focuses its policy on extending the scope of LGUs' tasks without enhancing their income base.

Currently, the objective of Polish regulations is to rationalise the local government's ability to incur debt, make their financial management more flexible and strengthen the legal mechanisms designed to improve financial security. The key draft amendments are to enable restructuring the debt of LGUs through the repayment of existing debt with new debt at lower servicing costs, or through early repayment if own funds are available. The above also strengthens the legal mechanisms designed to improve the financial security of LGUs, for instance, by calculating the individual debt repayment indicator so as to take account of liabilities whose economic effects are similar to those of a loan or credit agreement (including customised financial instruments); this will allow elimination of the circumvention of the debt indicator and, thus, will improve financial security at LGU level (2019–2022 Debt Management Strategy for the Public Finance Sector, 2018) [96].

#### 4. Conclusions

Repayable financing allows local government units to function when their income does not correspond to the costs of tasks implemented. It also enables these entities to maintain high investment expenditures when their investment potential is low. However, it is necessary to face the problem of safe indebtedness of local government units and to manage the debt appropriately. Excessive indebtedness of entities in the local government sector causes dangers. During an economic downturn, the financial condition is worse and it is a specific barometer indicating local development perspectives. Excessive indebtedness of local government units is a danger not only to their stability and to local development, but also to the entire public finance sector.

The problem of increasing indebtedness can be observed in a growing number of communes and on an increasing scale in Poland. Between 2007 and 2017, rural communes were the least indebted group. However, the greatest increase in the total amount of debt was observed in this group. Apart from that, due to the diversified functions of rural communes, this group was characterised by the greatest diversification both in the amount of debt and the share of total debt in the communes' budgets. Apart from that, in this group, there were entities facing the biggest problems caused by excessive indebtedness. However, typical units affected by excessive indebtedness are agricultural communes with a tourist function and communes with residential and service functions. In turn, agricultural communes are affected less frequently. The key investment target for the authorities of tourist communes (located mainly in northern and southern Poland) was the enhancement of tourist and similar infrastructure. In turn, communes with residential and service functions (located in main metropolitan centers, in the immediate vicinity of big cities) mainly invested in technical and social infrastructure.

There is a large number of factors of the total debt of communes and the debt of rural communes in Poland. Financial factors are one of the causes of indebtedness. The discriminant analysis showed that in 2012–2014, the share of the operating surplus and own income in total income as well as the amount of EU funds per capita in zlotys) were particularly significant. The study revealed that the smaller the share of the operating surplus in total income is as well as the greater the share of own income in total income and the amount of the EU funds in zlotys per capita are, the lower the value of the estimated discriminatory function and the higher the risk of excessive indebtedness of a rural commune. Thus, we can conclude that the risk of excessive indebtedness is most likely to occur in the rural communes that are more financially independent (characterised by a higher level of own income potential) and in those that make intensive investments in socioeconomic development by acquiring the EU funds for this purpose. The discriminative model of excessive indebtedness of rural communes in 2012–2014 was compared to models built based on 2007–2008 and 2015–2017 data. In 2007–2009 (i.e., at the beginning of the financial perspective of 2007–2013), debt was mainly incurred by communes at lower levels of own income potential which until that time did not access EU funds. In turn, in 2015–2017, the financial factors of risk of excessive indebtedness facing the rural communes were similar to those identified in 2012–2014.

This study allowed us to confirm the research hypothesis that the main determinant of the risk of excessive indebtedness is the rural communes' own income potential. Considerable indebtedness of many rural communes in Poland, low investment capacity and relatively low operating surplus generated by these entities of the local government sector may become barriers blocking their local development. In the current financial perspective, the human factor in the entities of the local government sector seems to be a particularly important element conditioning appropriate debt management and local development of rural communes. In view of the fact that rural communes' own funds are limited and these entities have poor capacity to incur new liabilities due to the low operating surplus generated, in the financial perspective of 2014–2020, it will be particularly important to consider all investment plans carefully in terms of the costs borne and potential long-term benefits.

**Author Contributions:** Conceptualization, A.S., A.K.; data curation, A.S., A.K.; formal analysis, A.K.; methodology, A.K., A.S.; project administration, A.S.; resources, A.K., A.S.; software, A.K., A.S.; visualization, A.K., A.S.; writing—original draft preparation, A.S., A.K.; writing—review and editing, A.K., A.S.; funding acquisition,



A.S., A.K.; investigation, A.K., A.S.; supervision, A.S.; validation, A.K. All authors have read and agreed to the published version of the manuscript.

**Funding:** The research was co-financed from resources of the National Center for Science, allocated pursuant to decision DEC-2013/11/D/HS4/03884 and the Faculty of Economics and Social Sciences Poznań University of Life Sciences.

**Conflicts of Interest:** The authors declare no conflict of interest.

## References

1. Central Statistical Office. Local Data Bank Database. Available online: <http://www.stat.gov.pl/bdl> (accessed on 16 January 2019). (In Polish)
2. Kozera, A.; Glowicka-Wołoszyn, R. Identification of functional types of rural communes in Poland. In Proceedings of the 2018 International Scientific Conference Economic Sciences for Agribusiness and Rural Economy, Economic Sciences for Agribusiness and Rural Economy, Warsaw, Poland, 7–8 June 2018; Volume 1, pp. 109–115.
3. Kozera, A. Własny potencjał dochodowy gmin wiejskich w Polsce (Own income potential of rural communes in Poland). *Polityki Eur. Finans. I Mark.* **2018**, *19*, 95–106. (In Polish)
4. Kata, R. Ryzyko finansowe w kontekście zadłużenia jednostek samorządu terytorialnego w Polsce (Financial risk in the context of indebtedness of local government units in Poland). *Optim. Studia Ekon.* **2015**, *4*, 54–71. Available online: [http://sj.wne.sggw.pl/pdf/EIOGZ\\_2012\\_n96\\_s129.pdf](http://sj.wne.sggw.pl/pdf/EIOGZ_2012_n96_s129.pdf) (accessed on 16 January 2019). (In Polish). [CrossRef]
5. Carmeli, A. The Effect of Fiscal Conditions of Local Government Authorities on Their Economic Development. *Econ. Dev. Q.* **2007**, *21*, 91–98. [CrossRef]
6. Watson, D.J.; Handley, D.M.; Hassett, W.L. Financial distress and municipal bankruptcy: The case of Prichard, Alabama. *J. Public Budg. Account. Financ. Manag.* **2005**, *17*, 129–150. [CrossRef]
7. Carmeli, A. The fiscal distress of local government in Israel. *Adm. Soc.* **2008**, *39*, 984–1007. [CrossRef]
8. Pagano, M.; Moore, R.J.T. *Cities and Fiscal Choices: A New Model of Urban Public Investment*; Duke University Press: Durham, NC, USA, 1985.
9. Rabiczko, A.; Puszek, K. Czy polskim jednostkom samorządu terytorialnego grozi widmo spirali zadłużenia? (Is the specter of a spiral of debt threatening Polish local self-government units?). In *Finanse samorządu Terytorialnego W Niestabilnym Otoczeniu (Local Government Finances in an Unstable Environment)*; Poniatowicz, M., Ed.; Wydawnictwo Uniwersytetu w Białymstoku: Białystok, Poland, 2013; pp. 77–84.
10. Brzozowska, K.; Gorzalczyńska-Koczkodaj, M.; Kogut-Jaworska, M.; Ziolo, M. *Gospodarka Finansowa W Jednostkach Samorządu Terytorialnego (Financial Economy in Local Government Units)*; CeCeWu: Warszawa, Poland, 2013. (In Polish)
11. Fisher, R.C. *State and Local Public Finance*; Foresman and Company: Glenview, IL, USA, 1987.
12. Alesina, A.; de Broeck, M.; Prati, A.; Tabellini, G. Default Risk on Government Debt in OECD Countries in: Economic Policy. *Eur. Forum* **1992**, *7*, 428–463.
13. Gianakis, G.A.; McCue, C.P. *Local Government Budgeting*; Praeger: Westport, CT, USA, 1999.
14. Dafflon, B. *Local Debt: From Budget Responsibility to Fiscal Discipline*; Université de Fribourg: Fribourg, France, 2010.
15. Burret, H.T.; Feld, L.P. A note on budget rules and fiscal federalism. *CESifo DICE Rep.* **2014**, *12*, 3–11.
16. Poniatowicz, M. *Dług Publiczny W Systemie Finansowym Jednostek Samorządu Terytorialnego (Public Debt in the Financial System of Local Government Units on the Example of Cities with Poviatt Rights)*; Wydawnictwo Uniwersytetu w Białymstoku: Białystok, Poland, 2005.
17. Kosak-Wojnar, M.; Surówka, K. *Podstawy Finansów Samorządu Terytorialnego (Basics of Local Government Finances)*; Wydawnictwo PWN: Warszawa, Poland, 2007. (In Polish)
18. Filipiak, B. Przesłanki dokonania oceny samorządowego długu publicznego na tle podejścia badawczego (Estimating the level of indebtedness of local government units in conditions of an increased risk of losing financial liquidity). In *Szacowanie Poziomu Zadłużenia Jednostek Samorządu Terytorialnego W Warunkach Zwiększonego Ryzyka Utraty Płynności Finansowej (The Rationale for Assessing Local Government Debt Against the Background of the Research Approach)*; Denek, E., Dylewski, M., Eds.; Difin: Warszawa, Poland, 2013; pp. 169–208. (In Polish)

19. Standar, A. The problem of indebtedness of Polish communes. *Hradec Econ. Days* **2017**, *7*, 821–828.
20. Wood, L.E. Trends in National and Regional Economic Distress: 1960–2000, Prepared for the Appalachian Regional Commission. Available online: [https://www.arc.gov/research/researchreportdetails.asp?REPORT\\_ID=28](https://www.arc.gov/research/researchreportdetails.asp?REPORT_ID=28) (accessed on 20 May 2019).
21. Honadle, B.W.; Costa, J.M.; Cigler, B.A. *Fiscal Health for Local Governments*; Elsevier: London, UK, 2003.
22. Trussel, J.M.; Patrick, P.A. The Symptoms and Consequences of Fiscal Distress in Municipalities: An Investigation of Reductions in Public Services. *Account. Public Interest* **2013**, *13*, 151–171. [[CrossRef](#)]
23. Kloha, P.; Weissert, C.; Kleine, R. Someone to Watch Over Me: State Monitoring of Local Fiscal Conditions. *Am. Rev. Public Adm.* **2005**, *35*, 236–255. [[CrossRef](#)]
24. Jones, S.; Walker, R. Explanators of Local Government Distress. *Abacus* **2007**, *63*, 396–418. [[CrossRef](#)]
25. Hendrick, R. Assessing and Measuring the Fiscal Health of Local Government: Focus on Chicago Suburban Municipalities. *Urban Aff. Rev.* **2004**, *40*, 78–114. [[CrossRef](#)]
26. Wang, X.; Dennis, L.; Tu, Y.S.J. Measuring financial condition: A study of US states. *Public Budg. Financ.* **2007**, *27*, 1–21. [[CrossRef](#)]
27. Rivenbark, W.C.; Roenigk, D.J. Implementation of Financial Condition Analysis in Local Government. *Public Adm. Q.* **2011**, *35*, 241–267. [[CrossRef](#)]
28. Ambrose, B.W.; Deng, Y.; Wu, J. Understanding the Risk of China’s Local Government Debts and its Linkage with Property Markets. Presented at the International Symposium on Housing and Financial Stability in China, Shenzhen, China, 18–19 December 2015; pp. 1–43. [[CrossRef](#)]
29. Aczél, Á.; Homolya, D. Risks of the indebtedness of the Hungarian local government sector from a financial stability point of view. In *Crisis Aftermath: Economic Policy Changes in the EU and Its Member States Conference Proceedings*; Munich Personal RePEc Archive Paper 40345; University Library of Munich: Munich, Germany, 2012; pp. 157–169. Available online: <http://mpra.ub.uni-muenchen.de/40345> (accessed on 19 September 2019).
30. Bolívar, M.P.R.; Galera, A.N.; Muñoz, L.A.; Subirés, M.D.L. Risk Factors and Drivers of Financial Sustainability in Local Government, An Empirical Study. *Local Gov. Study* **2016**, *42*, 29–51. [[CrossRef](#)]
31. Standar, A. Zagrożenia w gospodarce finansowej samorządów gminnych a wyrównywanie poziomu rozwoju lokalnego (Threats in the financial economy of gmina local governments and equalization of the level of local development). *Nierówności Społeczne Wzrost Gospod.* **2017**, *49*, 359–371. (In Polish) [[CrossRef](#)]
32. *Wskaźniki do Oceny Sytuacji Finansowej Jednostki Samorządu Terytorialnego (Indicators for Assessment of the Financial Situation of Local Government Units)*; Ministry of Finance: Warsaw, Poland, 2016. Available online: <http://www.finanse.mf.gov.pl/budzet-panstwa/finanse-samorzadow/opracowania> (accessed on 16 January 2019). (In Polish)
33. *Archiwalne Średnie Kursy (Archive of Medium Courses)*; Narodowy Bank Polski: Warsaw, Poland, 2018.
34. Tukey, J.W. *Exploratory Data Analysis*; Addison-Wesley: Boston, MA, USA, 1977.
35. Wysocki, F. *Metody Taksonomiczne W Rozpoznawaniu Typów Ekonomicznych Rolnictwa I Obszarów Wiejskich (Taxonomic Methods in Recognizing Economic Types of Agriculture and Rural Areas)*; Wydawnictwo Uniwersytetu Przyrodniczego w Poznaniu: Poznań, Poland, 2010.
36. Reimann, C.; Filzmoser, P.; Garrett, R.; Dutter, R. *Statistical Data Analysis Explained—Applied Environmental Statistics with R*; John Wiley & Sons Ltd.: Chichester, West Sussex, UK, 2008.
37. Wysocki, F.; Kozera, A. Wykorzystanie analizy dyskryminacyjnej w ocenie ryzyka upadłości przedsiębiorstw przemysłu mięsnego (The use of discriminant analysis in assessing the risk of bankruptcy of food industry enterprises). *J. Agribus. Rural. Dev.* **2012**, *4*, 167–182. (In Polish)
38. Zielińska-Chmielewska, A. Use of chosen discrimination models in the assessment of bankruptcy risk in meat processing enterprises. *J. Agribus. Rural. Dev.* **2015**, *36*, 363–370. [[CrossRef](#)]
39. Tabachnick, B.G.; Fidell, L. *Using Multivariate Statistics*, 3rd ed.; Happer&Row: New York, NY, USA, 1996.
40. Stanisz, A. Przystępny kurs statystyki z zastosowaniem STATISTICA PL na przykładach z medycyny. In *Tom 3. (An Affordable Statistic Course Using STATISTICA PL on Examples of Medicine. Volume 3)*; Statsoft: Kraków, Poland, 2007.
41. Johnson, R.A.; Wichern, D.W. *Applied Multivariate Statistical Analysis*, 5th ed.; Prentice Hall: Upper Saddle River, NJ, USA, 2002.
42. Altman, E.I. Financial ratios, discriminant analysis and the prediction of corporate bankruptcy. *J. Financ.* **1968**, *23*, 589–609. [[CrossRef](#)]

43. Wiśniewski, M. *Ocena Zdolności Kredytowej Gminy (Credit Rating of a Commune)*; Difin: Warszawa, Poland, 2011.
44. Huberty, C.J. *Applied Discriminant Analysis*; John Wiley Sons Inc.: New York, NY, USA, 1994.
45. Mączyńska, E.; Zawadzki, M. Dyskryminacyjne modele predykcji bankructwa przedsiębiorstw (Discriminating bankruptcy prediction models for enterprises). *Ekonomista* **2006**, *2*, 1–24.
46. Afifi, A.; May, S.; Clark, V.A. *Practical Multivariate Analysis*; CRC Press/Taylor: Florida, FL, USA, 2012.
47. Public Finance Act of June 30, 2005. Journal of Laws of 2005, No. 249, Item 2104. Available online: <http://prawo.sejm.gov.pl/isap.nsf/download.xsp/WDU20052492104/U/D20052104Lj.pdf> (accessed on 18 April 2019).
48. Dylewski, M. Analiza pionowa i pozioma sprawozdań jednostki samorządu terytorialnego (Vertical and horizontal analysis of the reports of local government units). In *Metody Analityczne W Działalności Jednostek Podsektora Samorządowego (Analytical Methods in the Activity of Local Government Units)*; Dylewski, M., Filipiak, B., Gorzałczyńska-Koczkodaj, M., Eds.; Difin: Warszawa, Poland, 2010; pp. 76–91. (In Polish)
49. Bański, J. Perspektywy rozwoju polskiej wsi—wybrane zagadnienia (Prospects for the development of the rural areas of Poland—Selected issues). *Wiś I Rol.* **2014**, *4*, 13–25. Available online: <http://kwartalnik.irwirpan.waw.pl/archive?year=2014> (accessed on 18 April 2019). (In Polish).
50. Hadyński, J. *Regionalna Konkurencyjność Obszarów Wiejskich (Regional Competitiveness of Rural Areas)*; Wydawnictwo Uniwersytetu Przyrodniczego w Poznaniu: Poznań, Poland, 2015. (In Polish)
51. Heffner, K.; Klemens, B. *Obszary Wiejskie: Wiejska Przestrzeń I Ludność, Aktywność Społeczna I Przedsiębiorczość (Rural Areas: Rural Space and Population, Social Activity and Entrepreneurship)*. Polska Akademia Nauk; Heffner, K., Klemens, B., Eds.; Komitet Przestrzennego Zagospodarowania Kraju: Warszawa, Poland, 2016.
52. Standar, A.; Kozera, A. Wykorzystanie analizy dyskryminacyjnej w ocenie ryzyka nadmiernego zadłużenia jednostek samorządu terytorialnego na przykładzie gmin województwa wielkopolskiego (The use of discriminant analysis in the evaluation of risk of excessive debt of local government units for example communes of Wielkopolska province). *Finans. Rynk. Finans. Ubezpieczenia* **2016**, *4*, 805–818. (In Polish) [[CrossRef](#)]
53. Kozera, A. Problem zadłużenia gmin wiejskich na przykładzie województwa wielkopolskiego (The problem of indebtedness in rural gminas based on the example of Wielkopolskie province). *Wiś I Rol.* **2017**, *1*, 75–97. (In Polish) [[CrossRef](#)]
54. Kozera, A. Rosnące zadłużenie jednostek samorządu terytorialnego jako zagrożenie dla rozwoju lokalnego (The growing debt of local government units as a threat to local development). *Nierówności Społeczne Wzrost Gospod.* **2017**, *49*, 203–204. (In Polish) [[CrossRef](#)]
55. Standar, A. Identyfikacja poziomu ryzyka w zakresie nadmiernego zadłużenia się gmin i jego finansowych determinant (Identification of the level of risk in terms of municipal excessive indebtedness and its financial determinants). *Nierówności Społeczne Wzrost Gospod.* **2018**, *56*, 121–132. (In Polish) [[CrossRef](#)]
56. Rosner, A.; Stanny, M. *Socio-Economic Development of Rural Areas in Poland, The European Fund for the Development of Polish Villages Foundation, Institute of Rural and Agricultural Development*; Polish Academy of Sciences: Warsaw, Poland, 2017.
57. Wilkin, J.; Nurzyńska, I. (Eds.) *Rural Poland 2018—The Report on the State of Rural Areas*; Scholar Publishing House: Warszawa, Poland, 2018.
58. Constitution of the Republic of Poland of 2 April 1997. Journal of Laws of 1997, No. 78, Item 483. Available online: <http://prawo.sejm.gov.pl/isap.nsf/download.xsp/WDU19970780483/U/D19970483Lj.pdf> (accessed on 16 January 2019). (In Polish)
59. Public Finance Act of August 27, 2009, Journal of Laws of 2009, No. 157, Item 1240. Available online: <http://prawo.sejm.gov.pl/isap.nsf/download.xsp/WDU20091571240/U/D20091240Lj.pdf> (accessed on 18 April 2019).
60. Act on Local Government Revenues, Article 3, Journal of Laws of 2003, No. 203, item 1966 (Ustawa O Dochodach Jednostek Samorządu Terytorialnego). Available online: <http://prawo.sejm.gov.pl/isap.nsf/download.xsp/WDU20032031966/U/D20031966Lj.pdf> (accessed on 18 November 2019). (In Polish)
61. Act of 8 March 1990 on communal self-government, Journal of Laws of 1990, No. 16, item 95 (Ustawa O Samorządzie Gminnym). Available online: <http://prawo.sejm.gov.pl/isap.nsf/download.xsp/WDU19900160095/U/D19900095Lj.pdf> (accessed on 18 November 2019). (In Polish)
62. *European Charter of Local Self-Government*; European Treaty Series No. 122; Council of Europe: Strasbourg, France, 1985.

63. Jastrzębska, M. *Finanse Jednostek Samorządu Terytorialnego (Finances of Local Government Units)*; LEX a Wolters Kluwer Business: Warszawa, Poland, 2012. (In Polish)
64. Šević, Z. *Fiscal Decentralisation and Grant Transfers in Transition Countries: A Critical Perspective*; Šević, Z., Ed.; The Network of Institutes and Schools of Public Administration in Central and Eastern Europe: Bratislava, Slovakia, 2005.
65. Rusu, E. Comparative analysis of local financial autonomy in the European Union countries. *Ann. Ștefan Cel Mare Univ. Suceava* **2008**, *8*, 224–230.
66. Surówka, K. *Samodzielność Finansowa Samorządu Terytorialnego W Polsce (Financial Independence of Local Government in Poland)*; Polskie Wydawnictwo Ekonomiczne: Warszawa, Poland, 2013. (In Polish)
67. Satola, Ł.; Standar, A.; Kozera, A. Financial autonomy of local government units: Evidence from Polish rural municipalities. *Lex Localis J. Local Self Gov.* **2019**, *17*, 321–342. (In Polish) [[CrossRef](#)]
68. Dolewka, Z. Bezpieczeństwo finansowe miast wojewódzkich (Financial security provincial cities). *Nierówności Społeczne Wzrost Gospod.* **2014**, *40*, 31–41. Available online: <http://yadda.icm.edu.pl/yadda/element/bwmeta1.element.ekon-element-000171315171> (accessed on 18 November 2019). (In Polish).
69. Kozera, A. Stabilność finansowa gmin wiejskich w Polsce (Financial stability of rural communes in Poland). *Studia I Mater. Wydziału Zarządzania Univ. Warsz.* **2017**, *2*, 80–96. (In Polish) [[CrossRef](#)]
70. Coccia, M. National Debts and Government Deficits within European Monetary Union: Statistical Evidence of Economic Issues, National Research Council of Italy and Arizona State University, CocciaLab Working Paper 2018—No. 34/bis. Available online: <https://arxiv.org/ftp/arxiv/papers/1806/1806.07830.pdf> (accessed on 16 January 2019).
71. Eurostat Database. Available online: <https://ec.europa.eu/eurostat> (accessed on 26 November 2019).
72. *Zadłużenie Sektora Finansów Publicznych W 1 Kwartale 2016 (The Indebtedness of the Public Finance Sector in the First Quarter of 2016)*; Ministry of Finance: Warsaw, Poland, 2015. Available online: [https://www.cirf.gov.pl/documents/766655/5853197/zsfp\\_2016\\_03.pdf](https://www.cirf.gov.pl/documents/766655/5853197/zsfp_2016_03.pdf) (accessed on 16 January 2019). (In Polish)
73. *Gospodarka Finansowa Jednostek Samorządu Terytorialnego 2014 (Financial Economy of the Local Government Unit)*; Central Statistical Office: Warsaw, Poland, 2015. Available online: <https://stat.gov.pl/obszary-tematyczne/rachunki-narodowe/statystyka-sektora-instytucji-rzadowych-i-samorzadowych/gospodarka-finansowa-jednostek-samorzadu-terytorialnego-2018,5,15.html>(in archives). (accessed on 26 November 2019). (In Polish)
74. *Gospodarka Finansowa Jednostek Samorządu Terytorialnego 2018 (Financial Economy of the Local Government Unit)*; Central Statistical Office: Warsaw, Poland, 2019. Available online: <https://stat.gov.pl/obszary-tematyczne/rachunki-narodowe/statystyka-sektora-instytucji-rzadowych-i-samorzadowych/gospodarka-finansowa-jednostek-samorzadu-terytorialnego-2018,5,15.html> (accessed on 26 November 2019). (In Polish)
75. *Strategia Zarządzania Długiem Sektora Finansów Publicznych 2015–2018 (Debt Management Strategy for the Public Finance Sector in 2015–2018)*; Ministry of Finance: Warsaw, Poland, 2014. Available online: <http://www.finanse.mf.gov.pl> (accessed on 18 April 2019).
76. Bereźnicki, J. 2017 Najbardziej Zadłużone Gminy. Ostrowice Zbankrutowały, Jak Jest W Innych Samorządach? (Most Indebted Municipalities. Ostrowice Went Bankrupt, How is It in Other Local Governments?). Available online: <http://www.money.pl> (accessed on 26 November 2019). (In Polish).
77. Standar, A. Access to EU funds vs. financial risks faced by rural municipalities of the Wielkopolskie Voivodeship. In Proceedings of the 19th International Scientific Conference, Economic Science for Rural Development 2018, Jelgava, Latvia, 9–11 May 2018; Volume 49, pp. 169–177.
78. Dylewski, M. Zadłużenie JST—Problemy nowej perspektywy finansowej UE (Local governments’ debt-problems of the new EU financial perspective). *Zesz. Nauk. Univ. Ekon. W Katowicach Studia Ekon.* **2014**, *198*, 125–134. (In Polish)
79. Panek, T. *Statystyczne Metody Wielowymiarowej Analizy Porównawczej (Statistical Methods of Multivariate Comparative Analysis)*; Szkoła Główna Handlowa: Warszawa, Poland, 2009. (In Polish)
80. Maher, C.S.; Nollenberger, K. Revisiting Kenneth Brown’s ‘10-point test’. *Gov. Financ. Rev.* **2009**, *25*, 61–66.
81. McDonald, B.D. Does the charter form improve the fiscal health of counties? *Public Adm. Rev.* **2015**, *75*, 609–618. [[CrossRef](#)]

82. Pew Charitable Trusts. *State Strategies to Detect Local Fiscal Distress*; Pew Charitable Trusts: Washington, DC, USA, 2016; Available online: [http://www.pewtrusts.org/~\(\)/media/assets/2016/09/detecting\\_local\\_distress\\_report.pdf](http://www.pewtrusts.org/~()/media/assets/2016/09/detecting_local_distress_report.pdf) (accessed on 27 November 2019).
83. Kieso, D.E.; Weygandt, J.J.; Warfield, T.D. *Intermediate Accounting*; John Wiley and Sons: New York, NY, USA, 2011; Volume 1.
84. Finkler, S.A.; Smith, D.L.; Calabrese, T.D.; Purtell, R.M. *Financial Management for Public, Health, and Not-for-Profit Organizations*, 5th ed.; CQ Press: Washington, DC, USA, 2017; Available online: [https://www.academia.edu/38899262/FINANCIAL\\_MANAGEMENT\\_FOR\\_PUBLIC\\_HEALTH\\_AND\\_NOT-FOR-PROFIT\\_ORGANIZATIONS\\_Fifth\\_Edition](https://www.academia.edu/38899262/FINANCIAL_MANAGEMENT_FOR_PUBLIC_HEALTH_AND_NOT-FOR-PROFIT_ORGANIZATIONS_Fifth_Edition) (accessed on 27 November 2019).
85. Groves, S.M.; Godsey, W.M.; Shulman, M.A. Financial indicators for local governments. *Public Budg. Financ.* **1981**, *1*, 5–19. [CrossRef]
86. Honadle, B.W.; Costa, J.M.; Cigler, B.A. *Fiscal Health for Local Governments: An Introduction to Concepts, Practical Analysis, and Strategies*; Elsevier: London, UK, 2004.
87. Holda, A.; Pocięcha, J. *Probabilistyczne Metody Badania Sprawozdań Finansowych (Probabilistic Methods of Auditing Financial Statements)*; Wydawnictwo Uniwersytetu Ekonomicznego w Krakowie: Kraków, Poland, 2009. (In Polish)
88. Kitowski, J. *Metody Dyskryminacyjne Jako Instrument Oceny Zagrożenia Upadłości Przedsiębiorstwa (Discriminatory Methods As an Instrument for Assessing the Threat of Company Bankruptcy)*; Wydawnictwo Uniwersytetu Rzeszowskiego: Rzeszów, Poland, 2015. (In Polish)
89. Filipiak, B. *Finanse samorządowe. Nowe Wyzwania Bieżące i Perspektywiczne*; Difin: Warszawa, Poland, 2011. (In Polish)
90. Dafflon, B.; Beer-Toth, K. Managing local public debt in transition countries: An issue of self-control. In Proceedings of the 14 th Annual Conference of the Network of Institutions and Schools of Public Administration in Central and Eastern Europe (NISPAcee), Ljubljana, Slovenia, 11–13 May 2006. [CrossRef]
91. Kata, R. Ryzyko finansowe w działalności jednostek samorządu terytorialnego-metody oceny, *Zeszyty Naukowe SGGW w Warszawie. Ekon. I Organ. Gospod. Żywnościowej* **2011**, *97*, 129–141. (In Polish)
92. Consolidated Version of the Treaty on the Functioning of the European Union, Official Journal of the European Union 26.10.2012. Available online: <https://eur-lex.europa.eu/legal-content/PL/TXT/PDF/?uri=CELEX:12012E/TXT&from=EN> (accessed on 26 November 2019).
93. Consolidated Version of the Treaty on European Union, Official Journal of the European Union 29.7.1992. Available online: <https://eur-lex.europa.eu/legal-content/PL/TXT/?uri=celex%3A11992M%2FTXT> (accessed on 26 November 2019).
94. Council Regulation (EC) No 479/2009 25.05.2009. Available online: <https://eur-lex.europa.eu/LexUriServ/LexUriServ.do?uri=OJ:L:2009:145:0001:0009:PL:PDF> (accessed on 26 November 2019).
95. Regulation (EU) No 549/2013 Of The European Parliament and of The Council 21.05. Available online: <https://eur-lex.europa.eu/legal-content/EN/TXT/PDF/?uri=CELEX:32013R0549&from=pl> (accessed on 26 November 2019).
96. *Strategia Zarządzania Długiem Sektora Finansów Publicznych 2019–2022 (Debt Management Strategy for the Public Finance Sector in 2019–2022)*; Ministry of Finance: Warsaw, Poland, 2018. Available online: <https://www.gov.pl/web/finanse/strategie-zarzadzania-dlugiem> (accessed on 18 April 2019).
97. Hałaburda, D.A. Zadłużenie jednostek samorządu terytorialnego w świetle nowych regulacji prawnych (Indebtedness of local governments units in the light of new law regulation). *Zeszyty Naukowe SGGW w Warszawie. Ekon. I Organ. Gospod. Żywnościowej* **2011**, *91*, 153–164. (In Polish)





Article

# The Role of Local Finance in Overcoming Socioeconomic Inequalities in Polish Rural Areas

Aldona Standar <sup>1,\*</sup> and Agnieszka Kozera <sup>2</sup>

<sup>1</sup> Department of Economics and Economic Policy in Agribusiness, Faculty of Economics and Social Sciences, University of Life Sciences, Wojska Polskiego 28, 60-637 Poznan, Poland

<sup>2</sup> Department of Finance and Accounting, Faculty of Economics and Social Sciences, University of Life Sciences, Wojska Polskiego 28, 60-637 Poznan, Poland; agnieszka.kozera@up.poznan.pl

\* Correspondence: standar@up.poznan.pl; Tel.: +48-61-846-63-76

Received: 31 August 2019; Accepted: 17 October 2019; Published: 21 October 2019

**Abstract:** Poland is affected not only by a persistent regional differentiation but also by an internal polarization of regional development levels, particularly in rural areas. Local government authorities, especially municipalities, play an important role in bridging inequalities in socioeconomic rural development. This is because the investment capacity depends on the efficiency and effectiveness of local public finance. Note that the fight against inequalities is related to the issues of sustainable development. Therefore, the main purpose of this paper is to assess the changes in the level of socioeconomic inequalities between rural municipalities and the importance of local public finance in bridging these inequalities, as illustrated by the example of Poland. The objective formulated above emanates from the research hypothesis advanced by the authors which assumes that a strong relationship exists between one's own income and investment potential, on one side, and the socioeconomic development level of Polish rural municipalities, on the other. In the first stage of research, the levels of socioeconomic development of the municipalities surveyed were assessed with a synthetic indicator estimated using the TOPSIS method (Technique for Order Preference by Similarity to an Ideal Solution). The indicator served as a basis for building the typological classes of socioeconomic development at the municipal level. Following this, selected descriptive statistics methods were used to describe the typological classes of socioeconomic development. The second stage of research consisted of assessing the quantitative relationships between the development level and the financial situation of entities surveyed. This was done using the Pearson linear correlation coefficient and the pseudo-test of differences of means. As demonstrated in the analyses, Polish rural municipalities witnessed an improvement in their socioeconomic development level and a simultaneous reduction in development disparities. Also identified were the relationships between local public finance and development levels of rural municipalities. The empirical study also allowed us to confirm the research hypothesis formulated in this paper.

**Keywords:** socioeconomic inequalities; convergence; local finance; public sector; rural development; sustainable development

---

## 1. Introduction

Development means positive quantitative and qualitative changes which consist of leveraging available regional resources to improve the region's welfare and support the aims of equality [1]. To make this happen, the responsible entity must incur investment expenditure. In Poland, that entity is the local government, primarily including the municipalities (as the basic authorities in that sector) Since 1991, a three-level local government model has been in place in Poland. In addition to basic units (municipalities), it includes districts and voivodeships. Municipalities are charged with the broadest scope of tasks. The municipal government has a legal personality, owns assets and has the capacity to

collect incomes allocated to ongoing activities and investments [2,3]. Polish municipalities fulfill tasks related to (without limitation) technical and social infrastructure, environmental protection and land use management [3].

Public investments, including local government investments, are usually infrastructural expenditures with a long lifecycle. These can also be considered capital expenditure used to finance hard (physical) infrastructure projects and soft infrastructure projects (related to creating and developing human capital, innovations and R & D) [4,5]. Investment expenditure at the local government unit (LGU) level not only results in improving the standards and conditions of living for the local community but also drives local development. Indeed, municipal investments have a remarkably broad extent of positive effects of importance on both the local community and the entire local economy (including entrepreneurs based in the municipality). These effects include the demand effect which emerges when the infrastructure is created, and the supply effect which is manifested in the long term and is equated with benefits provided by the strengthened competitiveness of LGUs [6,7]. As noted by several authors, including P. McCann [8], local development policies are usually driven by supply and are focused on improving the conditions for investments by enhancing the infrastructure. Local government activities should therefore promote future socioeconomic development of local government communities.

In recent years, Poland has experienced major transformation processes due to the implementation of multiple investments, including those co-financed by the European Union (for a broader description, see A. Standar 2018 [9], A. Standar 2018 [10]). However, the development level of all Polish regions continues to be below the European Community average. The highest level of development was recorded in the Mazowieckie voivodeship where per capita GDP stood at 65% of the Union average in 2017. Conversely, the lowest level was found in eastern Poland voivodeships (Lubelskie, Podkarpackie, Podlaskie) with a per capita GDP not in excess of 30% of the Union average [11]. What also needs to be emphasized is that Poland demonstrates considerable intra-regional disparities, especially at the lowest (municipal) administrative level (NUTS 5). As noted by M. Stanny et al. [12], Poland is affected not only by a persistent regional differentiation but also by an internal polarization of regional development levels. Extremely large inequalities continue to be observed in the levels of socioeconomic development of rural municipalities (cf. [13]) which make up more than 60% of the total number of basic units of the Polish local government sector. As shown in a number of studies, including those by A. Kozera and R. Głowicka-Wołoszyn [14] and A. Rosner and M. Stanny [13], their primary functions continue to be related to agriculture. However, as the socioeconomic development progresses, and as the migration and suburbanization processes emerge, many rural municipalities shift from a purely agricultural function to residential and service functions [12,15]. Differences between local government units are a natural and obvious phenomenon; the problem is the scale and the convergent or divergent trends of differences rather than the differences themselves.

Note that the fight against inequalities is related to the issues of sustainable development. In accordance with the lines of rural development [16], rural areas should become an attractive place for working, living, relaxing and carrying out an agricultural or non-agricultural business; at the same time, their unique natural, landscape and cultural values should be preserved for future generations. Therefore, based on the sustainable development concept, the farming process should take the needs of future generations into account. Instead of being focused on profit maximization, businesses should also consider their impacts on the environment which, if degraded, can significantly affect the economy [17]. In economic terms, the sustainable development concept means meeting one's objectives while taking account of the costs of one's decisions. Sustainable development also means economic growth that promotes greater cohesion (including reducing social fragmentation, ensuring equal opportunities, and fighting against marginalization and discrimination).

Local government authorities (in Poland: municipalities, as mentioned earlier) play an important role in bridging inequalities in socioeconomic rural development. Inequalities are defined as being the opposite of equality, and involve social, economic, political and other issues. This can be interpreted as a situation where the largest possible number of municipalities find themselves in a good socioeconomic



standing. In this paper, socioeconomic development was assumed to be a multifaceted aspect, and was therefore quantified using a synthetic indicator in which the differences between the levels correspond to the extent of socioeconomic inequalities. The efficiency and effectiveness of local public finance are conditions for changes in infrastructural facilities available in rural areas which, in turn, are largely decisive for the lines of rural development. Hence, from a cognitive and applicative perspective, it is important to explore the relationships between local government finance and socioeconomic development level of rural areas.

The main purpose of this paper is to assess the changes in the level of socioeconomic inequalities between rural municipalities and the importance of local public finance in bridging these inequalities, as illustrated by the example of Poland. The objective formulated above emanates from the research hypothesis advanced by the authors which assumes that a strong relationship exists between one's own income and investment potential, on one side, and the socioeconomic development level of Polish rural municipalities, on the other.

The role of local finance in fighting socioeconomic inequalities across rural areas, as illustrated by the example of Poland, is an extremely important topic because of its cognitive and utilitarian aspects. Poland is among the largest beneficiaries of the EU cohesion policy. Since joining the European Community in 2004, Poland has accessed huge amounts of money in support of narrowing the socioeconomic gaps, especially in rural areas which make up over 90% of the national territory. A large part of these funds is allocated to local government units, including rural municipalities which account for 60% of all basic Polish LGUs. Also, Poland implements its national policy for regional development. In turn, the assumption behind the Polish system of local government financing is to support poorer units, including rural municipalities. Incomes of rural municipalities are equalized with the use of subsidies (the compensating and the balancing part); the system for implementing EU projects gives preference to units at lower development levels. Hence, it is reasonable to assess the changes in the level of socioeconomic disparities between the smallest territorial units, i.e., municipalities (especially including rural municipalities), and the role of local finance in fighting inequalities in development levels in a context of assessing the system for the allocation of Union and national public funds.

## 2. Materials and Methods

Two-stage empirical research was necessary to verify the research hypothesis and to meet the defined objective. The first step consisted of assessing the levels of socioeconomic development of the rural municipalities surveyed in 2005–2007 and 2015–2017. Because of the multidimensionality of the process considered, the socioeconomic development of municipalities was assessed using a synthetic indicator estimated based on TOPSIS (*Technique for Order Preference by Similarity to an Ideal Solution*) [18]. Three-year median values (calculated for 2005–2007 and 2015–2017) of one-year indicators (simple characteristics) were used to eliminate fluctuations. Typological classes of socioeconomic development at the municipal level were built based on the estimated value of the synthetic indicator. Descriptive statistics methods were also used later in this study; the resulting differences in synthetic indicator values were presented in a box plot.

The second stage of research consisted of assessing the financial situation of Polish rural municipalities in typological classes of socioeconomic development levels, as identified earlier. Also, an assessment was conducted on quantitative relationships between the development level and the financial situation of these municipalities. The above relationships were explored using the Pearson linear correlation coefficient. In turn, the pseudo-test of difference of means was used to assess the importance of particular indicators of the financial situation in typological classes of socioeconomic development levels of rural municipalities.

Rural municipalities located in one of the Poland's largest regions, the Wielkopolskie voivodeship, were selected for the case study (N = 113). The Wielkopolskie voivodeship demonstrates relatively large disparities between rural municipalities with different typological functions (agricultural, residential, industrial or tourist), as corroborated in research by numerous authors, including A.

Kozera and R. Głowicka-Wołoszyn [14] and A. Rosner and M. Stanny [13]. The empirical study was based on data retrieved from the Local Data Bank (Polish Central Statistical Office) [19], the *Województwo wielkopolskie—podregiony, powiaty, gminy* (Wielkopolskie voivodeship: sub-regions, districts, municipalities) yearbook (Poznań Statistical Office) [20] and *Wskaźniki do oceny sytuacji finansowej jednostek samorządu terytorialnego* (Indexes for the assessment of local government units' financial standing) (Polish Ministry of Finance) [21].

The first step of the research was an assessment of socioeconomic development levels of Polish rural municipalities in the Wielkopolskie voivodeship, based on synthetic indicators for 2005–2007 and 2015–2017. The socioeconomic development level can be regarded as a complex multi-criterion hierarchical structure. It includes the primary criterion (socioeconomic development level) and secondary criteria extending over different aspects of development (e.g., social conditions, infrastructural development level, economic development level). Particular criteria are based on simple characteristics of the objects concerned (Table 1).

**Table 1.** Simple characteristics used for the construction of the synthetic indicator of socioeconomic development of municipalities.

Item	Designation	Secondary Criterion	Name of the Characteristic
1	$x_1$	Demographic situation	Population density (per km <sup>2</sup> )
2	$x_2$		Population growth rate per 1000 population
3	$x_3$		Net migration rate per 1000 population
4	$x_4$	Social situation	Percentage of unemployed people in the total working-age population (%)
5	$x_5$		Share of councilors at tertiary education levels (%)
6	$x_6$		Number of foundations, associations and social organizations per 1000 population
7	$x_7$		People employed in the industrial, construction and service sectors per 100 working-age population
8	$x_8$		Share of social assistance beneficiaries in the total population (%)
9	$x_9$	Local economy	Number of operators entered into the REGON register per 10,000 population
10	$x_{10}$		Number of natural persons engaged in a business per 1000 population
11	$x_{11}$		Number of operators with 50 or more employees per 10,000 working-age population
12	$x_{12}$		Number of beds in accommodation facilities per 1000 population
13	$x_{13}$	Agriculture	Share of farms with an area of 15 ha or more in the total number of farms (%)
14	$x_{14}$	Housing conditions	Average usable floor area per person (m <sup>2</sup> )
15	$x_{15}$		Share of apartments equipped with central heating (%)
16	$x_{16}$	Infrastructure	Share of population served by a sewerage network (%)
17	$x_{17}$		Share of population served by a gas network (%)

Source: Own study.

Six steps can be identified in the process of building a synthetic characteristic. The first step, based on substantive and statistical criteria, includes selecting simple characteristics of the objects (municipalities), and determining the way they affect the general criterion considered (i.e., socioeconomic development level). Based on substantive grounds, 17 simple characteristics were selected (Table 1) to reflect the

demographic and social situation, local economy, infrastructure, agriculture and housing conditions in rural municipalities covered by this study. Based on statistical grounds, 10 simple characteristics ( $x_2, x_3, x_4, x_5, x_7, x_8, x_9, x_{11}, x_{16}$  and  $x_{17}$ ) were selected to be used for the construction of the synthetic indicator of socioeconomic development of rural municipalities in the Wielkopolskie voivodeship (Table 1).

Characteristics considered to have an inhibitory effect were converted into opposite characteristics with the use of a negative coefficient transformation [22]:

$$x_{ik} = a - b \cdot x_{ik}^D \quad (1)$$

where:

- $x_{ik}^D$  Value of characteristic  $k$  with an inhibitory effect ( $k \in I_D$ ) for object (municipality)  $I$  ( $i = 1, \dots, N$ ),
- $x_{ik}$  Value of characteristic  $k$  ( $k = 1, \dots, K$ ) converted into a variable with a stimulating effect for object (municipality)  $i$ ,
- $a, b$ : constants set arbitrarily, usually  $a = 0$  and  $b = 1$ .

In the next (2nd) step, which was the normalization of simple characteristics, the classic standardization method was used:

$$z_{ik} = \frac{x_{ik} - \bar{x}_k}{s_k} \quad (2)$$

where:

- $x_{ik}$  Value of characteristic  $k$  in object  $i$ ,
- $\bar{x}_k, s_k$  Arithmetic mean and standard deviation, respectively, for characteristic  $k$ .

The normalization of simple characteristics was performed for the aggregate of average figures from 2005–2007 and 2015–2017 (referred to as object-years) in order to ensure comparability of results in the periods considered and to reveal the development trend followed by the complex process under consideration.

The coordinates of ideal objects are determined in the next (3rd) stage. Usually, they are defined as the positive ideal solution [22]:

$$A^+ = \left( \max_i(z_{i1}), \max_i(z_{i2}), \dots, \max_i(z_{iK}) \right) = (z_1^+, z_2^+, \dots, z_K^+) \quad (3)$$

and the negative ideal solution:

$$A^- = \left( \min_i(z_{i1}), \min_i(z_{i2}), \dots, \min_i(z_{iK}) \right) = (z_1^-, z_2^-, \dots, z_K^-) \quad (4)$$

However, real-world datasets may include unusual values (outliers or extreme characteristics) resulting from the specifics of the phenomenon under consideration. This is the issue encountered when assessing the socioeconomic development level of Polish rural municipalities. These observations may have a significant impact on the results of the analysis (e.g., a typological classification), which is why they require special attention. In such cases, according to empirical research by F. Wysocki and his team [23–26], if an assumption is made that the maximum and minimum values of the characteristics in reference methods for linear ordering (e.g., TOPSIS) are module objects, it results in most objects being excessively distant from the ideal values of simple characteristics. For instance, if the distribution of simple characteristics has a strong right-side asymmetry, most objects will be located far away from the positive ideal solution and very close to the negative ideal solution (in TOPSIS). As a consequence, the values of the synthetic indicator will be low and concentrated in the bottom part of its range ( $<0; 1>$ ). In turn, the reduced range of the synthetic indicator may entail problems with identifying the development levels of the phenomenon considered. In reference methods for linear ordering, ideal solutions are set separately for each characteristic. Therefore, the method for the identification of outliers proposed in this paper relies on a single-dimensional approach: the quartile criterion – used to

draw *box plots* introduced by J. W. Tukey [26] (cf. [24]). The values of a single characteristic are found to be outliers if located outside the following interval [27,28]:

$$[Q_{1k} - 1.5 \cdot IQR_k, Q_{3k} + 1.5 \cdot IQR_k], \quad (5)$$

where:

$Q_{1k}, Q_{3k}$  First and third quartile, respectively, of values of characteristic  $k$ ,

$IQR_k$  Quartile deviation for values of characteristic  $k$ .

Based on the quartile criterion (6), the coordinate of the ideal positive solution ( $A_k^+$ ) for characteristic  $k$  (having a stimulating effect) is defined as [24]:

$$A_k^+ = \begin{cases} \max_{i=1, \dots, N} (z_{ik}), & \text{if } z_{ik} \in [Q_{1k} - 1.5 \cdot IQR_k, Q_{3k} + 1.5 \cdot IQR_k] \text{ for } i \in [1, \dots, N], \\ Q_{3k} + 1.5 \cdot IQR_k, & \text{if } \max_{i=1, \dots, N} (z_{ik}) > Q_{3k} + 1.5 \cdot IQR_k, \end{cases} \quad (6)$$

and the negative ideal solution  $A_k^-$  is defined as:

$$A_k^- = \begin{cases} \min_{i=1, \dots, N} (z_{ik}), & \text{if } z_{ik} \in [Q_{1k} - 1.5 \cdot IQR_k, Q_{3k} + 1.5 \cdot IQR_k] \text{ for } i \in [1, \dots, N], \\ Q_{1k} - 1.5 \cdot IQR_k, & \text{if } \min_{i=1, \dots, N} (z_{ik}) < Q_{1k} - 1.5 \cdot IQR_k. \end{cases} \quad (7)$$

Hence, the coordinate of the positive ideal solution  $A_k^+ = Q_{3k} + 1.5 \cdot IQR_k$ , and the coordinate of the negative ideal solution  $A_k^- = Q_{1k} - 1.5 \cdot IQR_k$  are assigned to all outliers of characteristic  $k$  found in intervals  $[Q_{3k} + 1.5 \cdot IQR_k, \max_{i=1, \dots, N} (z_{ik})]$  and  $[\min_{i=1, \dots, N} (z_{ik}), Q_{1k} - 1.5 \cdot IQR_k]$ , respectively [24].

The coordinates of reference objects provide a basis for calculating the distance of each object (municipality) under consideration from the positive ideal solution ( $A^+$ ) and the negative ideal solution ( $A^-$ ) using the Euclidean formula. If the value of characteristic  $k$  (having a stimulating effect) of object  $i$  was found to be an outlier, the distance of that object from the positive or negative ideal solution is 0 (step 4) [22]:

$$d_i^+ = \sqrt{\sum_{k=1}^K (z_{ik} - z_k^+)^2}, \quad d_i^- = \sqrt{\sum_{k=1}^K (z_{ik} - z_k^-)^2}, \quad (8)$$

The TOPSIS method [18] was used to create the synthetic indicator (step 5).

$$S_i = \frac{d_i^-}{d_i^- + d_i^+}, \quad (i = 1, \dots, N), \quad (9)$$

with  $0 \leq S_i \leq 1$ .

Values of the synthetic indicator calculated above provide a basis for linear ordering of rural municipalities in a non-ascending sequence. In step 6, this was the basis for identifying the typological classes of socioeconomic development level of Polish rural municipalities in the Wielkopolskie voivodeship. The quartile approach (dividing the population into four classes) was chosen arbitrarily. At the same time, the typological classes of rural development levels were also identified based on substantive grounds.

The second stage of research consisted of assessing the quantitative relationships between the socioeconomic development level and the financial situation of rural municipalities in the Wielkopolskie voivodeship. Therefore, the Pearson linear correlation coefficients were estimated between the values of the synthetic indicator of socioeconomic development levels and the values of indicators used to assess the financial condition in the entire group of rural municipalities and in the identified typological classes. The pseudo-test of difference of means was used to identify specific indicators of the financial

situation in typological classes of socioeconomic development levels of rural municipalities. It is calculated as follows [22,29,30]:

$$t_{ck(d)} = \frac{\bar{x}_{ck} - \bar{x}_k}{s_{ck}}. \quad (10)$$

The test value measures the distance between the class mean ( $\bar{x}_{ck}$ ) and the general mean ( $\bar{x}_k$ ) of characteristic  $k$ ; the distance unit is the standard error of the class mean;

$s_{ck}^2 = \frac{N-N_c}{N-1} \cdot \frac{s_k^2}{N_c}$  is the variance of means in the case of sampling of  $N_c$  objects of class  $c$  ( $c = 1, \dots, C$ ) without replacement;

$s_k^2$  is the empirical variance of characteristic  $k$  in the population,

$\frac{N-N_c}{N-1}$  is the finite population  $N$  correction factor.

The distribution of class means is approximated with the normal distribution (at a 0.95 confidence level). Therefore, the mean value of a specific characteristic in the class is assumed not to differ from the general mean within the limits of the standard error of the mean ranging from  $-1.96$  to  $+1.96$ . Such a characteristic is not considered to be specific. The greater is the absolute value of the test for a characteristic, the more specific it is. The values of the pseudo-test of differences of means were the basis for identifying the specific characteristics in typological classes with the use of the following scale [22]:

1.  $t_{ck(d)} \in (-\infty; -3 > v < 3; +\infty)$  very high intensity of characteristic  $k$  in class  $c$ ; the characteristic is highly specific (in positive or negative terms);
2.  $t_{ck(d)} \in (-3; -2 > v < 2; 3)$  high intensity of characteristic  $k$  in class  $c$ ; the characteristic is moderately specific (in positive or negative terms);
3.  $t_{ck(d)} \in (-2; 2)$  average intensity of characteristic  $k$  in class  $c$ ; the characteristic does not stand out and is not specific.

### 3. Role of Local Government in Promoting Development and Fighting Against Socioeconomic Inequalities: A Theoretical Background

Regional development extends over a broad spectrum of economic policy issues related to the need to use appropriate resources which may either contribute to or constrain regional wealth (in absolute or relative terms). As a consequence, regional development is related to two priorities: the optimum use of rare inputs; and social, economic and territorial coherence [1]. Generally, regional development includes all changes at regional level, especially as regards three components: regional economic potential and competitive edge and the standards and quality of living for the population [31,32]. Note that regional and local developments are equally important processes, the terms being used with respect to larger territorial units (e.g., regions) and smaller ones (e.g., municipalities), respectively [33]. In the context of a structural socioeconomic shift towards a worldwide/global economy, the interest in regional problems provides an essential counterbalance [34,35]. According to A. Spellerberg et al. [36], it is important to strengthen the endogenous potential in order for the regions to remain well-positioned in the national and international environment because effective regions are believed to fuel economic development.

For a long time now, sustainable regional development has encouraged the researchers to measure the disparities between regions, identify the reasons for such disparities and assess the impact of political measures taken to address the undesired inequalities. Table 2 presents a review of key theories on this matter, grouped by the level at which momentum for development is generated. According to top-down development theories, regional development should be driven by strong state intervention measures. Additionally, these theories can be divided into classical approaches and polarization theories. Conversely, in accordance with the bottom-up concept, development should be driven by autonomous territorial government authorities based on endogenous factors.

The grounds for an economic analysis of the theory of regional growth were laid by classical economists, such as Smith and Marshall. The basics of the modern theory of economic growth can be found in work by R. Solow [36,37], who proved that in the world of neoclassical economics, the regional

growth rate (measured as income per capita) is inversely proportional to the initial income per capita. That thesis is an optimistic outlook for poor regions [1].

In turn, Schumpeter and Tinbergen are believed to be the pioneers of the *convergence concept* (see [38–42]) which builds on Ricardo's comparative costs theory. The assumption behind Ricardo's concept is that less developed countries may derive benefits from trade based on differences in labor efficiency and cost. Note, however, that benefits arising from trade require that production be exports-oriented rather than intended for internal purposes. As noted by Tinbergen, while trade actually does equalize incomes between both countries (the rich and the poor one), this is a conditional process. First of all, the poor country must participate in the global market economy. Secondly, it should own physical capital to create enough jobs to accelerate production growth. The second condition is what makes the convergence concept stand apart from the theory of comparative costs. Generally, the essential recommendation of the convergence theory for underdeveloped countries is to import capital; this is because capital value is low in countries at lower development levels, and additional capital resources can bring greater effects than in a developed country. In early 1990s, several scientists, including Barro and Sala-Martin, carried out research on income convergence in Europe. This was a reply to the dilemmas emerging in the European Union: do the incomes follow a convergence or a divergence process? The researchers believe that income convergence at regional level is not common [40,42].

An appropriate allocation of funds (grants, subsidies) by national or European Union authorities is the instrument designed to narrow the gap between regions. Aid may be allocated evenly or preferentially (to support less developed/poor municipalities or more effective/rich ones); the selection of the allocation criterion has long been subject to discussion [43–45]. As noted by Spellerberg et al. (2007) [36], there was broad consensus in Germany that their government should provide support for disadvantaged regions. Currently, there is a doctrinal shift based on the conviction that support should rather be focused on strong regions that are expected to provide momentum for weaker towns through development diffusion processes. Note, however, that due to limited amounts of public funds, there is a considerable risk that support for weaker regions would be strongly reduced.

According to G. Henckel [46], regional differences have since long been noticed by the European Union. The Committee of the Regions and the European Regional Development Fund were established to provide support for regions. The fight against inequalities is also mentioned in the Maastricht Treaty which sets it as the main priority for the European Union. Moreover, the largest portion of funds disbursed under the regional policy is allocated to support for convergence processes. The issue of converge and its reasons have long been of particular interest for scientists around the world, including R. Capello and P. Nijkamp [1], R.J. Barro and X. Sala-i-Martin [47] and K. Dervish [48]. Complex convergence/divergence processes were examined at a global level (e.g., A.J. Korotayev et al. [49]) or in the context of selected continents or areas (e.g., [50–52]). As regards developed countries, note that some authors examined the various aspects of convergence processes in OECD members (e.g., [53,54]), including at a regional (below-national) level, especially in Europe. Researchers who explored that context include J.P. Elhorst [55], C.M. Aumayr [56], E. Marelli and M. Signorelli [57], Y. Le Pen [58], M. Bartkowska and A. Riedl [59]. Today, political decision-makers and economists are also interested in growth and convergence processes to find out whether poor countries/regions are capable of catching up with rich ones. Many modern-day experts believe that advanced economies will continue to dominate, which means convergence processes will fail [39]. As noted by D. Quah [39], the global economy entered a new era of convergence around 1990 when average incomes per capita in emerging and developing markets (considered jointly) started to rise much faster than in developed economies. The classification into rich and poor countries, which has been an inherent part of reality since the industrial revolution in early 1800s, now becomes blurred. The key question is whether the new convergence will continue progressing.

According to G. Nell and M. Signorelli [60], one of the major reasons for disproportions is the lack of infrastructure and of the network effect. For instance, areas without telecommunications

coverage cannot access new technologies. As a consequence, the dependent communication and information technologies (e.g., Internet) are also unavailable. Development disparities are also driven by an inadequate (e.g., corrupt) institutional environment, demographic and social aspects and, finally, financial performance (see [61]). As noted by G. Henckel [46], peripheral areas are affected not only by economic weaknesses but also by deteriorated social determinants.

**Table 2.** Main types and authors of development theories.

Main Types of Development Theories	Groups of Development Theories	Development Theories	Selected Authors
Top-down development (1) Classical approach	Neoclassical economics	Basic neoclassical model	Smith A. (1776)
		Theory of comparative advantage Heckscher–Ohlin theory of factor proportions	Ricardo D. (1817) Heckscher E. (1919); Ohlin B. (1930)
	Keynesian model	Basic Keynesian model	Keynes J. M. (1936)
		Theory of economic base	North D. C. (1955); Rittenbruch K. (1968)
Stage models	Rostow’s stages of growth Kondratiev waves Product lifecycle theories	Rostow W. W. (1960)	
		Kondratiev N. D. (1926) Vernon R. (1966)	
Sustainable and unsustainable development theories	Sustainable development Unsustainable development	Nurkse R. (1953); Rosenstein-Rodan P.N. (1961)	
		Hirschman A.O. (1958); Streeten P. (1964)	
Top-down development (2) Polarization theories	Growth poles	Sectoral polarization	Schumpeter J. A. (1964); Peroux F. (1964)
		Regional polarization	Myrdal G. (1957)
		Sectoral and regional polarization	Hirschman A. O. (1958); Kaldor N. (1970) Peroux F. (1964); Paelinck J. (1965); Boudeville J. R. (1956); Pottier P. (1963)
	Growth poles concept		
Growth poles and hierarchical diffusion	Theory of innovation and of innovation process phases Theory of sectoral and regional growth poles	Schumpeter J. A. (1964)	
		Lausen J. M. (1969)	
Core-periphery theory	Core-periphery theory (Prebisch) Core-periphery theory (Friedmann)	Prebisch R. (1959)	
		Friedmann J. (1973)	

Table 2. Cont.

Main Types of Development Theories	Groups of Development Theories	Development Theories	Selected Authors
Bottom-up development	Historical perspective of development processes	Theory of long-term alternation between development phases	Walter P. P. (1980); Stohr W. B. (1981)
	Theory of basic needs	Redistribution and growth strategy	Chenery H. H. S. (1974); ILO/MOP (1979); Tinbergen J. (1976) Report from Cocoyoc (1974); Hammarskjöld Foundation (1975); Roman Club Report (1975); Stohr W. B. (1974)
		Strategy of alternative development	
	Self-centered development theory and selective separation	Theory of dependency	Frank A. G. (1978)
		Theory of self-centered development and selective separation	Senghaas D. (1977)
	Theory of independent regional development	Regional policy concept	Stohr W. B. (1981); Uahane (1985); Maier G. (1987)
Concept of independent regional development Concept of regional development through activation of sub-sectoral potential		Scheer G. (1981); Glatz H. (1981) Hahne U. (1992)	
Theory of use of endogenous potential	Regional self-fulfillment concept of intraregional flows of an innovative regional environment	Maier G. (1987)	

Source: [62].

Note that rural transformation results in the emergence of a problem which is how to delimit urban areas from urbanized areas. In Poland, the scope of mobility and suburbanization processes becomes increasingly broader. These trends resulted in the urbanization of the rural lifestyle and in the emergence of “intermediate cities” [63]. As a consequence, the lines between poor rural areas and rich cities become increasingly blurred. In Poland, rural communities located in the area of impact of big cities of regional importance are often wealthier than many urban local government units. The group of polarization theories indicates the importance of location as a determinant of development and shows how the peripheral environment can derive growth momentum from its backbone.

In turn, bottom-up development theories indicate the important role of endogenous factors, including the strength of impact of local government authorities. Local government activities are supposed to include an effective management of public finance and use of local resources. Local government authorities can stimulate the economy through budgetary instruments, including earmarked investment expenses [64]. Sustainable Agriculture and Rural Development (SARD) is an important concept from the perspective of rural development. It emerged due to the need for an increase in agricultural production; the heterogeneous environmental impacts of agriculture; and the importance of rural areas for ecosystems and quality of living [65]. These authors [65] believe that the sustainable rural development shall govern all rural activities. Polish rural areas are strongly heterogeneous in economic and social terms. In particular, a tremendous gap can clearly be seen between development levels of the technical infrastructure; appropriate water supply and discharge of waste water can be regarded as the most urgent problems affecting rural areas [16]. The absence of the relevant infrastructure can result in the marginalization of the entire region because of the feedback loop between the infrastructure level and general development level. On the one hand,



the infrastructure development level is a component of the general development level. On the other hand, poorly developed municipalities are unlikely to attract investors, tourists and residents; this translates into their financial condition (e.g., small revenue from the share in PIT and CIT) which, in turn, is the condition for enhancements. Therefore, there is need for supporting the development of infrastructure, especially in poorer rural and urban-rural financially disadvantaged municipalities that are unable to bear such large amounts of investment expenditure [66].

Although addressed in a number of studies, sustainable development continues to attract much interest. Its definition, main components and their importance are debated between the researchers. While the concept of sustainable agriculture is broadly discussed and needs to be further explored, less scientific efforts are dedicated to sustainable rural development which therefore requires even more attention [17].

In summary, this paper is consistent with the theories of regional development, primarily including the theory of use of endogenous potential and the polarization theories. From the perspective of local government processes, the theories of use of endogenous potential are of particular importance. According to most of these concepts, regions should be self-reliant and need to leverage their own internal potential. In the context of the financial condition of Polish municipalities, the above means that the government supports the municipalities with the general subsidy and targeted grants. While this support is obviously desirable, it is usually spent on ongoing operators. The income potential grows (and, as a consequence, so does the investment potential) when the unit uses its own inputs, such as own and organizational capital (including employee experience, adequate skills, activity of local authorities). In turn, polarization theories are of great importance for the understanding of today's regional disparities. These concepts help understand why, although funds have been allocated to regions at lower levels of socioeconomic development for many years, they continue to lag behind and the disproportions remain enormous.

## 4. Results and discussion

### 4.1. Results of Empirical Research, Part 1—Assessing the Socioeconomic Development Level of Polish Rural Municipalities Located in the Wielkopolskie Voivodeship

In recent years, especially after Poland's accession to the European Union, rural areas have attracted increased interest. Much attention is paid to their problems and outlooks and to threats they face in their development process. On the one hand, this resulted in an accelerated infrastructural transformation of many Polish municipalities [67]. On the other hand, the reason why rural areas attract interest is that according to the methodology for the delimitation of rural areas used by the Central Statistical Office, they make up over 90% of the national territory and are home to nearly 40% of the total population [19]. In the Wielkopolskie voivodeship, rural areas represent over two thirds of the territory, with more than half of basic local government units being rural municipalities. The region is strongly heterogeneous in terms of functions fulfilled by rural areas [14]. This translated into large differences in socioeconomic development levels between the LGUs.

The socioeconomic development level of rural municipalities in the Wielkopolskie voivodeship in the context of the European integration was assessed based on the values of the synthetic indicator developed using the TOPSIS methods. The results of empirical research are presented in Figure 1, in Tables 3 and 4 and in Map 1. The finding from empirical research is that the general level of socioeconomic development of rural municipalities in the region covered by this study was higher in 2015–2017 than in 2005–2007 (Figure 1). In 2005–2007, the synthetic indicator of socioeconomic development level varied in the range of 0.172 (municipality of Olszówka) to 0.909 (municipality of Suchy Las). In 2015–2017, it varied in the range of 0.221 (municipality of Wierzbinek) to 1.000 (municipality of Komorniki). This means an increase in the range of the synthetic indicator (from 0.736 in 2005–2007 to 0.779 in 2015–2017) and in the median of the indicator which provides a picture of the development level of an average rural municipality in the Wielkopolskie voivodeship (from 0.433 in 2005–2007 to 0.567 in 2015–2017). Hence, the empirical research revealed not only an increase in the

general development level of rural municipalities surveyed (as reflected by the increase in the average level of the synthetic indicator) but also a reduction in the socioeconomic development gap between them. This is evidenced by the declining value of the coefficient of variation for the synthetic indicator which was 33% in 2005–2007 and went down to 25% in 2015–2017. However, rural municipalities of the Wielkopolskie voivodeship continue to be relatively strongly heterogeneous in terms of the socioeconomic development level.

The quartile approach (based on the values of the synthetic indicator) was used to identify four classes of rural municipalities at different levels of socioeconomic development (*high*, *medium-high*, *medium-low* and *low*). As shown by empirical research, the proportion of rural municipalities at *high* and *medium-high* levels of socioeconomic development was higher in 2015–2017 than in 2005–2007 (by 8.8 and 33.6 percentage points, respectively). Also, between these periods, there was a considerable decline in the share of rural municipalities at a *medium-low* level of socioeconomic development (by as much as 38.1 percentage points). In 2005–2007, most rural municipalities (nearly 64%) in the region surveyed were at a *medium-low* level, with only every twentieth being at a *high* development level. In turn, in 2015–2017 nearly 60% and over 14% of rural municipalities in the Wielkopolskie voivodeship were at *medium-high* and *high* levels of socioeconomic development, respectively (Table 3, Figure 2). Hence, this study found that Polish rural areas experienced a positive change in their development levels. Most importantly, note that in addition to improvements in the general level of socioeconomic development, there was an accelerated progress in narrowing the gap between underdeveloped and best developed municipalities.

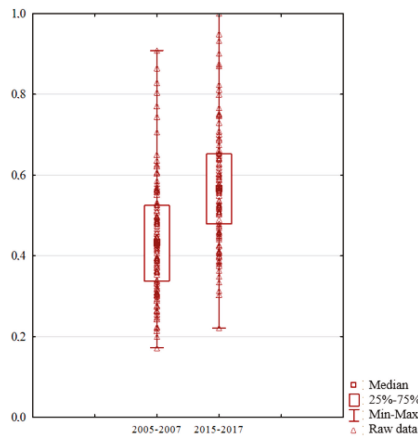

**Figure 1.** Box-plot of the synthetic indicator of the socioeconomic development level of Polish rural municipalities located in the Wielkopolskie voivodeship. Source: Own calculations based on [19].

**Table 3.** Classification of Polish rural municipalities located in the Wielkopolskie voivodeship by socioeconomic development level.

Typological Class	Development Level	Thresholds for the Synthetic Indicator	Number of Municipalities		Percentage of Municipalities (%)		Change (Percentage Points)
I	high	<0.75, 1.00	6	16	5.3	14.2	8.8
II	medium-high	<0.5, 0.75	29	67	25.7	59.3	33.6
III	medium-low	<0.25, 0.5	72	29	63.7	25.7	−38.1
IV	low	<0.0, 0.25	6	1	5.3	0.9	−4.4

Source: own calculations based on [19].

**Table 4.** Identification of typological classes of socioeconomic development level of Polish rural municipalities located in the Wielkopolskie voivodeship (a selection of simple characteristics).

Specification	Typological Class/Socioeconomic Development Level					Total
	I High	II Medium-High	III Medium-Low	IV Low		
Distance from the region's central city of Poznań (km)	2005–2007	76.4	112.0	137.0		91.3
	2015–2017	42.2	85.4	137.0	125.0	91.0
Population density (per km <sup>2</sup> )	2005–2007	160.1	56.7	52.6	49.0	56.9
	2015–2017	91.6	56.4	53.5	50.5	59.7
Net migration rate per 1000 population	2005–2007	42.3	2.3	−1.0	−2.3	0.1
	2015–2017	4.3	−0.4	−1.0	−4.8	−0.4
Share of unemployed people in the total working-age population	2005–2007	3.2	6.2	10.4	12.8	8.9
	2015–2017	1.8	3.7	4.9	8.4	3.3
Share of councilors at tertiary education levels in the total number of councilors (%)	2005–2007	48.9	23.3	17.8	6.7	20.0
	2015–2017	46.7	26.7	13.3	0.0	4.7
People employed in the industrial, construction and service sectors per 100 working-age population	2005–2007	41.4	17.6	11.3	8.3	13.8
	2015–2017	35.7	14.3	8.2	12.5	14.0
Share of social assistance beneficiaries in the total population (%)	2005–2007	4.4	8.8	12.0	11.4	10.7
	2015–2017	4.7	6.0	8.7	12.2	6.4
Operators entered to the REGON register per 10,000 population	2005–2007	1212.3	723.4	578.4	469.6	626.1
	2015–2017	1203.7	811.2	645.7	434.4	784.2
Operators with 50 or more employees per 10,000 working-age population	2005–2007	19.9	13.2	3.9	0.0	5.3
	2015–2017	14.9	6.50	2.36	6.4	6.4
Share of people served by a sewerage network in the total population (%)	2005–2007	45.6	34.4	25.4	13.0	27.3
	2015–2017	70.4	52.2	27.1	3.5	49.4
Share of people served by a gas network in the total population (%)	2005–2007	61.4	6.4	0.0	0.0	0.0
	2015–2017	60.3	2.3	0.03	0.1	1.5

Source: own calculations based on [19,20].

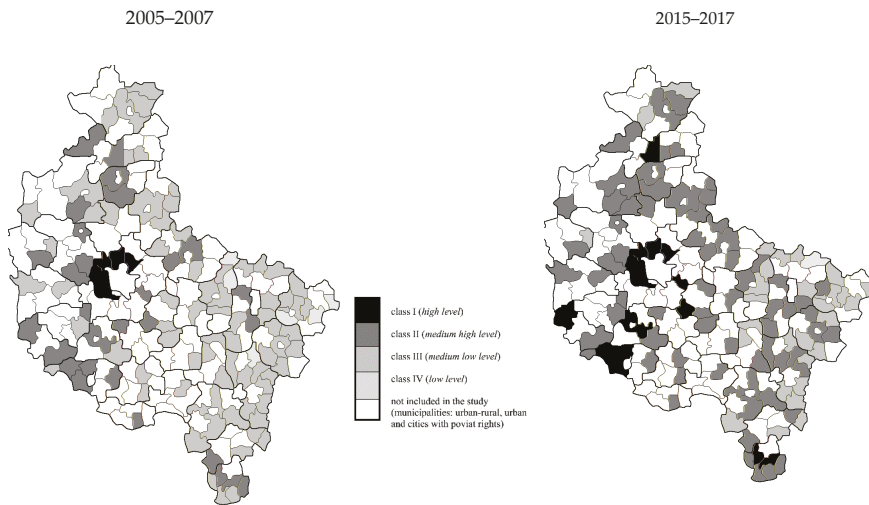

**Figure 2.** Territorial delimitation of socioeconomic development levels of Polish rural municipalities in the Wielkopolskie voivodeship in 2005–2007 (left) and 2015–2017 (right). Source: Own study.

Undoubtedly, since the beginning of the economic transformation, rural areas have undergone a process of socioeconomic change which gained particular momentum after Poland's accession to the European Union. The above is consistent with research findings presented in the *Rural Poland* report [68]. As the socioeconomic development progresses, many rural municipalities shift from a purely agricultural function to residential and service functions. This is especially true for those favorably situated vis-à-vis big cities or busy roads. In the Wielkopolskie voivodeship, rapid rural development is particularly noticeable in municipalities surrounding the region's capital city of Poznań. The functional shift and the increase in the level of socioeconomic development of many rural municipalities surrounding big cities are largely driven by suburbanization which means people moving from urban to suburban areas. As a consequence, suburban areas witness a rapid growth of population and business development. In 2015–2017, as much as 14.2% of all rural municipalities in the Wielkopolskie voivodeship were at a *high* level of socioeconomic development, most of them located in the Poznań Metropolitan Area. The Poznań Agglomeration, i.e., the Poznań Metropolitan Area, is the term most commonly used to refer (based on various criteria) to the strongly urbanized region in the central part of Greater Poland. It is one of the main elements of today's settlement system, not only nationally but also in Europe. It is considered to be one of the key European settlement systems according to both ESPON (European Spatial Planning Observation Network) and to METREX (The Network of Metropolitan Regions and Areas) [69]. An important factor of impact on the functioning of local government units is the institutional rent, defined as the benefits from the proximity of regional authorities (especially voivodeship-level authorities) with strong competences or a large financial capacity. This is an important exogenous factor of development for local government units [70]. Compared to other rural municipalities, rural municipalities at a *high* level of socioeconomic development are distinctively characterized by a high demographic potential (high population density and positive net migration rate), a high economic potential (large number of economic operators per 10,000 population, large number of people employed in the industrial, construction and service sectors per 100 working-age population) and a high share of total population served by sewerage and gas supply networks. In this context, note that in rural municipalities at a *high* development level, nearly half of councilors had a tertiary education (Table 4).

In 2015–2017 compared to 2005–2007, there was a considerable reduction (by as much as 38 percentage points) in the number of rural municipalities at a *medium-low* level of socioeconomic

development. As a consequence, in 2015–2017, 25.7% and barely 1.0% of the total number of rural municipalities were at a *medium-low* and *low* level, respectively (Table 3). Compared to other units, these municipalities demonstrate several distinctive characteristics, including a population density and economic activity level below the average for rural municipalities, a negative net migration rate and a high unemployment rate. Their low level of socioeconomic development is reflected by the fact that approximately each tenth resident is a beneficiary of social aid schemes (Table 4). Municipalities at *medium-low* and *low* levels of development are located mainly in the eastern part of the voivodeship, relatively far away from the region's central city of Poznań (Figure 2).

One of the major findings of this research is the confirmation of differences in socioeconomic development levels and in functions between rural municipalities located in the eastern and western part of the Wielkopolskie voivodeship. *High* and *medium-high* levels dominate in rural municipalities located in the eastern part of the region. Many rural municipalities, especially those located around the city of Poznań (regional center) are no longer rural in nature; now, they fulfill residential and service functions. Conversely, rural municipalities located in the eastern part of the region are generally at *medium-low* and *low* levels of socioeconomic development, and their local economies fulfill only one function (agriculture) (Table 4).

#### 4.2. Results of Empirical Research, Part 2—Assessing the Quantitative Relationships Between the Socioeconomic Development Level and Financial Situation of Polish Rural Municipalities Located in the Wielkopolskie Voivodeship

Interest in local finance is driven by the role played by basic local government units in Poland (municipalities) in creating local socioeconomic development. Therefore, the second stage of research was focused on assessing the quantitative relationships between the financial situation and socioeconomic development of Polish rural municipalities, as illustrated by the example of the Wielkopolskie voivodeship. Empirical research found that a relationship exists between the general development level and financial performance of rural municipalities surveyed. The highest positive correlation was observed between the socioeconomic development level and the share of own incomes in total municipal incomes and between the development level and the amount of municipal incomes derived from income taxes (which are state revenue) per capita. In view of the above, it may be concluded that the higher the rating of the municipalities' income situation, the higher the level of socioeconomic development. What matters from the perspective of the ability to freely create local development is the LGUs' own income potential. This is because own income collected by local government units is usually the main source of financing for their own tasks, assigned as provided for in international and national regulations, primarily including the *European Charter of Local Self-Government* (which lays down the framework characteristics of LGU financing) [71] and the *Constitution of the Republic of Poland* [2]. Therefore, the municipalities' own income potential is the condition for durable local development, and vice versa. As provided for in the Constitution [2], own incomes of municipalities include any and all incomes of local government units except for general subsidies and targeted grants. The Act on Incomes of Local Government Units [72] provides a list of all components thereof, including incomes from: local taxes and fees (e.g., property tax, agricultural tax), property (sale, lease) and shares in central-level PIT and CIT. The latter category is the second major factor of municipal development. Note that while the impact of own incomes declined between the two points in time covered by this study, the importance of incomes from PIT and CIT increased. This situation was the consequence of changes in functions fulfilled by rural municipalities. Due to suburbanization, many of them shift from agricultural functions (which are typical of rural areas) towards developing residential or industrial functions [14]. As a *hinterland for cities*, rural units become attractive places to live and run a business in. This is a determinant for the level and structure of incomes they derive from PIT and CIT. As a result of these transformations, rural areas lose their nature and collect less money from agricultural tax (of primary importance to them) while earning more from central-level taxes, especially PIT.

When analyzing the findings presented in Table 5, note the high negative correlation between incomes from general subsidies (except for the educational part) and the level of socioeconomic development of rural municipalities. This should be considered obvious, having in mind that other parts of the subsidy (compensatory and educational) are an instrument intended to balance the budgets and support poorer units. The principles for establishing and the principles and procedure for granting different parts of the general subsidy are detailed in the Act on Incomes of Local Government Units of 13 November 2003 [72].

In turn, a moderate correlation was found between the indicators of the municipalities' general financial condition (related to the operating surplus) and property investment expenditure, on one side, and the socioeconomic development level of rural municipalities surveyed, on the other. The operating surplus (difference between current incomes and current expenditure) indicates the investment potential and the ability to meet liabilities, i.e., the general financial condition. Therefore, as a logical conclusion, local government units cannot develop without these funds. In turn, the relationship between the development level and investment expenditure is fully justified: it is hard to expect development processes without investment expenditure. In Poland, local government units make up a considerable part of economic processes. As part of their own tasks, they take investment measures to improve the conditions and standards of living for the population through development processes and improvements to technical and social infrastructure. Indeed, investments made by local government units have a remarkably broad extent of positive effects which are of importance not only to the local community but also to the entire local economy (including entrepreneurs based in the municipality). Usually, two categories of investment effects can be identified: the demand effect which emerges when the infrastructure is created, and the supply effect which is manifested in the long term and can be equated with benefits provided by the strengthened competitiveness of the LGU concerned [6].

The relatively weak correlation between the development level and the indebtedness of rural municipalities can also be regarded as an interesting finding (Table 5). Because of the extensive scope of tasks performed by LGUs, funds derived from budgetary incomes are often not enough to cover all expenses planned in the budget. Therefore, to meet social expectations to the fullest possible extent and maintain a high level of investment expenditure, LGUs rely on refundable financing. This allows them to operate in a situation where incomes do not match the costs of tasks they fulfill. Also, this is a way to maintain a high level of investment expenditure for LGUs with a low investment potential (especially including rural municipalities that are purely agricultural in nature). Over the study period, many rural municipalities undertook to implement a series of investment projects (especially infrastructural projects) co-financed by the Union. Refundable financing was used for that purpose [40]. Note that the investments currently carried out by rural municipalities can create conditions for their future development. This is because local development is a long-term process of economic transformation. The absence of a relationship between indebtedness and development level of rural municipalities can also result from the implementation of unsuccessful investments financed with refundable funds. When planning investments, local authorities should take account not only of direct implementation costs but also of future operating expenses. Hence, it is important to analyze the "costs" and "benefits" of investments planned because if unsuccessful, they often cause financial problems to the LGU concerned. The benefits from having an increasingly sophisticated infrastructure should exceed the related costs. As noted by B. Dafflon and K. Beer-Toth [73], debt is one of the natural ways to fulfill a unit's tasks. It provides an alternative way of financing, especially if the LGU cannot deliver its own funds, and evidences its efficiency in using all available sources of financing.

**Table 5.** Linear correlation coefficients between the indicator of socioeconomic development and sub-indicators of the financial situation of rural municipalities located in the Wielkopolskie voivodeship in 2005–2007 and 2015–2017.

Specification	Typological Classes/Socioeconomic Development Level							Total
	I High		II Medium-High		III Medium-Low		IV Low	
Own incomes per capita (PLN)	2005–2007	0.61	0.33 *	0.07	0.47	0.35 **		
	2015–2017	0.62 **	0.09	0.01	×	0.51 **		
Share of own incomes in total incomes (%)	2005–2007	0.72 *	0.01	0.35 **	0.64	0.73 **		
	2015–2017	0.80 **	0.26 **	0.00	×	0.66 **		
Per capita income derived from income taxes which are state budget revenue (PLN)	2005–2007	0.32	0.22	0.28 **	0.37	0.69 **		
	2015–2017	0.80 **	0.30 **	0.13	×	0.69 **		
Per capita income derived from local taxes (PLN)	2005–2007	0.66	−0.28	0.14	0.20	0.46 **		
	2015–2017	0.52 **	0.07	−0.05	×	0.41 **		
Operating surplus per capita (PLN)	2005–2007	0.57	−0.03	0.07	−0.59	0.49 **		
	2015–2017	0.64 **	−0.07	−0.17	×	0.42 **		
Investment expenditure per capita (PLN)	2005–2007	0.62	0.17	0.12 **	−0.83	0.54 **		
	2015–2017	0.72 **	0.05	−0.44 **	×	0.45 **		
Total liabilities per capita (PLN)	2005–2007	0.44	−0.23	−0.07	−0.10	0.25 **		
	2015–2017	0.48 *	0.22 *	−0.13	×	0.36 **		

\*\* \* mean statistically significant correlation coefficients at  $\alpha = 0.05$  and  $\alpha = 0.1$ , respectively; × means the correlation coefficient between the characteristics considered cannot be calculated in a single-element class. Source: own calculations based on [19,21].

The empirical research analyzed more than just the quantitative relationships between the socioeconomic development level and the financial situation indicators for all rural municipalities of the voivodeship considered. A more in-depth analysis was carried out to explore the quantitative relationships in four groups of municipalities defined by levels of socioeconomic development. Empirical research found that the group of municipalities at a *high* level of development (class 1) exhibited the greatest number of statistically significant relationships between development levels and financial situation indicators (except for only one indicator covered by this study) (Table 5). Only one significant correlation was discovered in municipalities at a *medium-high* level of development (class 2). In turn, no correlation was found to exist between development levels and financial situation indicators in municipalities at a *medium-low* level of development. Finally, in the group of least developed rural municipalities (class 4), quantitative relationships were found between their development levels and two indicators of financial situation (Table 5).

High development levels of rural municipalities are determined by a high level of own incomes; revenue derived from income taxes which are state revenue; operating surplus; property investment expenditure; and indebtedness. This means that municipalities can become *drivers of development* provided that they have a considerable potential of own incomes derived from their own activities; take measures to encourage the inflow of new residents and enterprises; and are able to use diversified financing channels for their investments, including repayable funds. In turn, the group of rural municipalities at a *low* development level (class 4) witnessed negative correlation with the operating surplus indicator and with the investment expenditure indicator. This reflects their poor general condition which has a direct adverse effect on their investment capacity and, thus, on development processes.

Rural municipalities grouped in class 1 (at a *high* level of development) generally demonstrate the most advantageous and highly specific financial performance (Table 5). First of all, that group of local government units enjoys the highest level of financial autonomy (i.e., independence from the state budget and broad discretionary powers) measured with own income indicators. Financial autonomy is driven by the largest transfers of funds derived both from local taxes and fees and from the share in central-level PIT and CIT. Their investment capacity and ability to meet liabilities are at the highest level, as evidenced by the operating surplus indicators. As a consequence, these local governments report the largest average amounts of investments per capita. Because of the scale of their investment projects, local authorities use debt instruments to the relatively largest extent (if converted into per capita figures); in the 2015–2017 period alone, this resulted in a large portion of incomes being diverted to debt servicing. Note that the amounts of debt were so important that the debt servicing ratio went beyond the acceptable threshold of 15%. Pursuant to Article 169 of the Public Finance Act of 2005 [73], that limit was applicable until the end of 2013. However, the Ministry of Finance continues to calculate it in order to compare the financial situation of Polish local government units.

Rural municipalities grouped in class 2 (at a *medium-high* level of development) have an average level of financial autonomy. As another particularity, they allocated a large part of expenditure to investments in 2005–2007. However, it was only half of the amounts invested by local government units grouped in class 1. In that period, these municipalities relied on repayable instruments, as evidenced by large amounts of debt per capita and the highest share of debt in total incomes (Table 5).

Rural municipalities grouped in class 3 (at a *medium-low* level of development) were also characterized by the largest amounts of funds derived from state budget. This is related to a low contribution of own incomes to total municipal income and to its components (Table 5). As also confirmed by operating surplus indicators, they have a limited investment potential which translates into low investment expenditure. Moreover, the relatively low operating surplus (which is decisive for their capacity to incur debt) resulted in a reduced use of alternative sources of finance for investments, such as repayable instruments.

Similar disadvantageous figures are characteristic of group 4 which demonstrates a *low* level of development. Limited own income potential and high indebtedness are of particular importance in



this class. Hence, this group of rural municipalities is exposed to the strongest business risk in the entire region under consideration [74]. Under these circumstances, it is difficult to allocate considerable amounts of funds to investments, although these are the very municipalities who should invest much more than other ones in order to accelerate changes brought by development. Therefore, it may be very difficult, if not impossible, to overcome the underdevelopment of these local governments.

The analysis reveals some changes between the 2015–2017 and 2005–2007 sub-periods in average values of financial situation indicators in the defined classes of municipalities at different levels of socioeconomic development (Table 6). Considering that Poland enjoyed a favorable economic situation over the study period, an improvement in per capita figures should be expected. This results not only from an advantageous internal situation but also from considerable amounts of funds transferred by the European Union which were used to implement many investment projects. In view of the above, the decline in the rural municipalities' own income potential should be considered an important finding. While the difference was ca. 17% for municipalities at a *high* level of development (class 1), those at a *medium-low* level saw their own income potential decrease by nearly a half. That group had very little financial autonomy in 2015–2017, considering that as much as 70% of their incomes were derived from the state budget. What should also be noted is that municipalities at a *medium-low* level of development (class 3) allocated more funds to investments in 2015–2017. However, compared to the most developed LGUs, this was still not enough (even though class 1 local governments reduced their investment expenditure). It needs to be emphasized that all local government groups considered increased their indebtedness and the related debt servicing costs which went beyond the safe limit of 15% in representatives of class 3 [75]. This is a very worrying phenomenon because in the long run, it can result in a reduction of investment expenditure as the authorities will look for additional funds to repay the debt. As a consequence, this will hamper their already slow development processes.

#### 4.3. Discussion and Political Implications

Development levels vary considerably across European Union countries. For many years, it has been a topic of interest to both researchers (as mentioned by R. Capello and P. Nijkamp [1]) and political decision-makers who have developed a framework for regional policy development since the 1950s [76]. With the Lisbon Treaty entering into force in 2009, economic and social cohesion was supplemented with territorial cohesion. This is documented in Article 3 of the Treaty: The Union shall promote economic, social and territorial cohesion and solidarity among Member States [77]. Cohesion is a high-profile issue to the EU, as reflected by subsequent reports on economic, social and territorial cohesion. The last three were delivered in 2010, 2014 and 2017 [78–80]. The analyses of the European Commission prove that disproportions exist both between and within countries. Although regional disproportions in Poland are large, a similar situation exists in other countries. However, the development of all Polish regions is below the European Union average [80,81]. The empirical research also demonstrated that regional disparities in the level of socioeconomic development have reduced once again and follow a convergence trend. Also, Poland is among the countries who report the greatest improvements in that respect. Researchers who explored the topic of regional disparities and convergence processes include J.P. Elhorst [55], C.M. Aumayr [57], E. Marelli and M. Signorelli [57], Le Pen [58], M. Bartkowska and A. Riedl [59].

**Table 6.** Financial situation of Polish rural municipalities at different levels of socioeconomic development located in the Wielkopolskie voivodeship in 2005–2007 and 2015–2017.

Specification	Typological Class/Socioeconomic Development Level					Total
	I High	II Medium-High	III Medium-Low	IV Low		
Own incomes per capita (PLN)	2005–2007	2107.0	2091.3	2033.6	2140.9	
	2015–2017	2508.7 **	1550.1	1194.3 *	1745.1	
Share of own incomes in total incomes (%)	2005–2007	41.9 **	30.6 *	25.3 *	35.5	
	2015–2017	53.9 **	37.8	29.5 *	37.9	
Per capita income derived from income taxes which are state budget revenue (PLN)	2005–2007	725.2 **	291.5 **	178.8 *	235.0	
	2015–2017	1069.8 **	539.3 *	405.8 *	577.8	
Per capita income derived from local taxes and fees (PLN)	2005–2007	1066.1 **	394.8	310.8 *	368.9	
	2015–2017	997.4 **	600.5	463.2 *	622.5	
Share of operating surplus in total incomes (%)	2005–2007	30.5 **	12.0	9.9 *	11.6	
	2015–2017	17.1 **	10.9 *	9.9 *	11.5	
Operating surplus per capita (PLN)	2005–2007	961.2 **	247.2	208.5 *	258.4	
	2015–2017	766.4 **	443.0 *	399.2 *	476.9	
Property investment expenditure per capita (PLN)	2005–2007	1239.9 **	406.2	276.6 *	361.8	
	2015–2017	790.9 **	443.8 *	387.1 *	478.7	
Share of property investment expenditure in total expenditure (%)	2005–2007	37.4 **	19.0 **	13.0 *	16.0	
	2015–2017	18.3 **	11.7 *	10.9 *	12.4	
Per capita income derived from the general subsidy (without the educational part) (PLN)	2005–2007	4.3	159.9 *	292.9 **	246.9	
	2015–2017	91.3 *	366.0	564.6 **	377.5	
Total liabilities per capita (PLN)	2005–2007	505.1	409.4 **	283.6 *	327.0	
	2015–2017	1028.7 **	681.2	514.8 *	691.0	
Share of total liabilities in total incomes (%)	2005–2007	18.3	19.6 **	13.6 *	15.4	
	2015–2017	22.7	17.4	13.1 *	17.1	
Share of capital and interest repayments in total incomes (%)	2005–2007	6.0	6.6	5.3	5.6	
	2015–2017	22.0 **	14.8	12.7 *	15.3	

\*\* \*, designate highly specific characteristics in typological classes (identified based on the pseudo-test of differences of means); \*\* designates a high intensity of characteristic *k* in class *c*; \* designates a low intensity of characteristic *k* in class *c*. Source: own calculations based on [19,20].

In Poland, there is increased interest in local disparities in socioeconomic development levels [12,13,82–84]. Inequality issues are mentioned in the key legal acts that govern the Polish regional policy, i.e., the 2007–2015 National Development Strategy [85] and the 2007–2013 National Strategic Reference Framework [86]. The policy implemented by regional public authorities is consistent with the Development Strategy for the Wielkopolskie Voivodeship by 2020 (issued in 2005) [87] and the 2010–2020 National Strategy for Regional Development: Regions, Cities, Rural Areas (issued in 2010) [87]. Both documents place emphasis on the existence and extent of internal disparities in the Wielkopolskie voivodeship. Authors who analyzed the disparities in development levels, incomes and economic situation within the Wielkopolskie voivodeship include M.W. Gaczek [88], P. Motek [89] as well as M. Dolata and T. Czyż [90]. At the lowest (municipality, NUTS 5) level, including in rural municipalities, these disproportions were examined and confirmed to exist by A. Rosner and M. Stanny [13], M. Stanny and her team [12] and A. Kozera and R. Głowicka-Wołoszyn [14]. Moreover, in her research [12,13], Stanny proved the existence of a positive correlation between the development level of territorial units and financial aspects. Also, empirical research by Satola and his team [91] suggests that a relationship exists between the level of own income potential, on one side, and the development level and functional type of Polish rural municipalities. Therefore, in order to enhance their financial autonomy, the authorities of these municipalities must take measures to attract new residents or stimulate entrepreneurship. In turn, to do so, they must invest (mainly including their own funds). Thus, the dependence between development and own revenues is obviously a closed-loop relationship. Note that a low own potential also reduces access to external funds, whether repayable (such as debt instruments) or non-repayable (e.g., EU subsidies). As can be seen, the inability to additionally tap into these sources restricts the development; this is how a vicious circle is triggered which can only be stopped by an effective policy implemented at the local government level.

The literature hardly provides any clues as to the impact of local finance on socioeconomic instability. Instead, the analyses focus on assessing the determinants of the financial situation of local government units [92]. Research by E. Wibbels and J. Rodden [93] and H. Wolman [94] also suggests that a relationship exists between own incomes and GDP per capita (which is considered to be the basic indicator of development levels). In turn, research by H. Blochliger and her team [95] suggest that the municipality's expenditure policy is related to its development level.

## 5. Conclusions

An increase in the level of socioeconomic development of rural municipalities was observed in Poland in the context of European integration (see Stanny [12]), as confirmed by empirical research carried out in the Wielkopolskie voivodeship. The research found that in addition to an increase in the average level of socioeconomic development (measured with the synthetic indicator), rural municipalities also became more homogeneous in this respect. This suggests that positive convergence processes took place. This is evidenced by the fact that the coefficient of variation for the synthetic measure of socioeconomic development level decreased over the study period in the municipalities surveyed, and by some municipalities moving from lower development classes to higher ones. The proportion of rural municipalities at high and medium-high levels of socioeconomic development was higher in 2015–2017 than in 2005–2007 (by 8.8 and 33.6 percentage points, respectively). Also, between these periods, there was a decline in the share of units at a medium-low level of socioeconomic development (by as much as 38.1 percentage points). Most importantly, note that in addition to improvements in the general level of socioeconomic development of Polish rural areas, there was an accelerated progress in narrowing the gap between underdeveloped and best developed municipalities.

The highest levels of development are characteristic of rural municipalities located in the immediate vicinity of the region's central city of Poznań. The study period witnessed the emergence of new clusters of rural municipalities at *high* and *medium-high* levels of development, mostly located in the western part of the voivodeship, especially in the vicinity of Leszno, Kościan, Kępno, Wolsztyn and

Piła. When comparing these research findings with the conclusions made by other Polish (e.g., [70,96]) and international [97,98] researchers, it can be noted that a relationship existed between the location and the general financial condition of municipalities. It is a great advantage for rural municipalities to be located close to a city (especially to a regional center) because it enables the development of non-agricultural functions. Such municipalities become urban dormitories or production and logistics centers. On the one hand, the inflow of new residents and entrepreneurs drives revenue from local taxes and fees which are determinant for the income potential and the (extremely important) investment capacity. On the other hand, such units report greater demand for investments, and the construction of the required infrastructure is a capital-intensive project. Therefore, these municipalities have the greatest financial autonomy and the largest investment capacity; as a consequence, they implement the biggest investments.

In turn, municipalities at a *low* level of development are located in peripheral regions. They have a low level of own incomes while facing high levels of indebtedness, resulting in a high business risk, as indicated by many authors, including R. Kata [74]. Under these circumstances, it is difficult to allocate considerable amounts of funds to investments, and it may be very tough, if not impossible, to overcome the underdevelopment of these local governments.

The increase in the level of socioeconomic development of rural municipalities is the combined result of many factors. Local development is also strongly impacted by local government finance. Indeed, empirical research found that a relatively strong correlation exists between the financial situation of the total group of rural municipalities and their development level in the region considered (Wielkopolskie voivodeship). The development level is particularly strongly correlated with the rural municipalities' own income potential and with their investment potential. In view of the above, it may be concluded that the higher the rating of the municipalities' income situation, the higher the level of socioeconomic development. What matters from the perspective of the ability to freely create local development is the LGUs' own income potential. In this context, it is particularly important for the municipalities to have their own income potential in order to be able to freely drive local development. This is because for the municipalities, own income is usually the main source of financing for their own tasks. In turn, a moderate correlation was found between the indicators of the municipalities' general financial condition (related to the operating surplus) and property investment expenditure, on one side, and the socioeconomic development level of rural municipalities surveyed, on the other. The operating surplus (difference between current incomes and current expenditure) indicates the investment potential and the ability to meet liabilities, i.e., the general financial condition. Therefore, as a logical conclusion, local government units cannot develop without these funds. In turn, the relationship between the development level and investment expenditure is fully justified: it is hard to expect development processes without investment expenditure. Hence, the empirical study allowed us to confirm the research hypothesis advanced by the authors which assumes that a strong relationship exists between the level of own income and investment potential and the socioeconomic development level of Polish rural municipalities.

We need to note the high negative correlation between incomes from general subsidies (except for the educational part) and the level of socioeconomic development of rural municipalities. This should be considered obvious, having in mind that other parts of the subsidy (compensatory and educational) are an instrument intended to balance the budgets and support poorer units.

In the future, if the strong relationship between the financial situation and development level of rural municipalities persists, it may bring growing divergence processes and may result in discontinuing the implementation of the sustainable development concept. Today, the Polish law provides support for weaker units (including through subsidies, soft loans and pre-financing for EU grants). The European Union, too, has for many years, allocated the largest amounts of funds to meet the convergence objective as part of its policy for reducing regional disparities [76]. Polish beneficiaries, including municipalities, have accessed a considerable part of these funds. As a consequence, certain natural differences in true income potential between the municipalities become blurred. However, the question

arises about what will happen after a restriction or discontinuation of these preferential measures. In such a situation, own funds earned by the municipalities will become the basis for investments. Therefore, measures taken to enhance their own income potential should be regarded as the key challenge faced by Polish rural municipalities. With greater own incomes, local government authorities will enjoy more discretionary powers and greater financial autonomy when implementing investments to reduce disparities in the levels of socioeconomic and promote sustainable development. The empirical research and analyses conducted by the authors do not fully exhaust the issue of the role of local finance in fighting socioeconomic inequalities in rural municipalities. However, they provide a basis for further analyses of the extent and conditions of this phenomenon.

**Author Contributions:** Conceptualization, A.S., A.K.; data curation, A.S. A.K.; formal analysis, A.K.; methodology, A.K., A.S.; project administration, A.S.; resources, A.K., A.S.; software, A.K., A.S.; visualization, A.K., A.S.; writing—original draft preparation, A.S., A.K.; writing—review and editing, A.K., A.S.; funding acquisition, A.S., A.K.; investigation, A.K., A.S.; supervision, A.S.; validation, A.K.

**Funding:** The research was co-financed from resources of the National Center for Science, allocated pursuant to decision DEC-2013/11/D/HS4/03884 and the Faculty of Economics and Social Sciences Poznań University of Life Sciences.

**Conflicts of Interest:** The authors declare no conflict of interest.

## References

1. Capello, R.; Nijkamp, P. Regional growth and development revisited. In *Endogenous Regional Development, Perspectives, Measurement and Empirical Investigation*; Stimson, R., Stough, R., Nijkamp, P., Eds.; Edward Elgar Publishing: Cheltenham, UK, 2011; pp. 301–324.
2. Constitution of the Republic of Poland of 2 April 1997, Journal of Laws of 1997, No. 78, Item 483. Available online: <http://prawo.sejm.gov.pl/isap.nsf/download.xsp/WDU19970780483/U/D19970483Lj.pdf> (accessed on 16 January 2019). (In Polish)
3. Municipal Government Act of 8 March 1990, Journal of Laws of 1990, No. 16, Item 95. Available online: <http://prawo.sejm.gov.pl/isap.nsf/download.xsp/WDU19900160095/U/D19900095Lj.pdf> (accessed on 16 January 2019). (In Polish)
4. Hulbert, C.; Vammalle, C. *Sub-National Perspective on Financing Investment for Growth I—Measuring Fiscal Space for Public Investment: Influences, Evolution and Perspectives, No. 2*; OECD Regional Development Working Papers: Paris, France, 2014.
5. Allain-Dupre, D.; Hulbert, C.; Vammalle, C. *Public Investment at Central and Sub-National Levels: An Adjustment Variable for OECD Countries in the Present Context of Austerity?* OECD Workshop on Effective Public Investment and Sub-National Level in Times of Fiscal Constraints: Meeting in Coordination and Capacity Challenges; OECD: Paris, France, 2012.
6. Gren, J. Reaching the Peripherical Regional Growth Centres; Centre-periphery convergence through the structural funds' transport infrastructure actions and the evolution of the centre-periphery paradigm. *Eur. J. Spat. Dev.* **2003**, *3*, 1–20.
7. Wyszowska, D. *Samodzielność Finansowa Jako Determinanta Potencjału Inwestycyjnego Jednostek Samorządu Terytorialnego—Studium Empiryczne Gmin w Polsce (Financial Autonomy as a Determinant of Investment Potential of Local Government Units: An Empirical Study into Polish Municipalities)*; House of the Białystok University: Białystok, Poland, 2018. (In Polish)
8. McCann, P. *Urban and Regional Economics*; Oxford University Press: New York, NY, USA, 2001; pp. 258–259.
9. Standar, A. Differences in accessing Rural Development Programme (RDP) factors on the support level. The example of municipalities in the Wielkopolska region. In *Innovation and Cooperation in Smart, Sustainable and Inclusive Rural Regions*; Egartner, S., Niedermayr, J., Wagner, K., Eds.; Institute of Agriculture and Food Economics—National Research Institute: Warsaw, Poland; Vienna, Austria, 2018; Volume 15, pp. 93–105.
10. Standar, A. Access to EU funds vs. financial risks faced by rural municipalities of the Wielkopolskie Voivodeship. In *Proceedings of the 19th International Scientific Conference, Economic Science for Rural Development 2018*, Jelgava, Latvia, 9–11 May 2018; Volume 49, pp. 169–177.
11. Eurostat. Database. Available online: <https://ec.europa.eu/eurostat/data/database> (accessed on 16 July 2019).

12. Stanny, M.; Rosner, A.; Komorowski, Ł. *Monitoring Rozwoju Obszarów Wiejskich. Etap III Struktury Społeczno-Gospodarcze, Ich Przestrzenne Zróżnicowanie I Dynamika (Wersja Pełna) (Monitoring of Rural Development. Stage 3. Meaning of, Territorial Disparities and Changes in Socioeconomic Structures (Full Version))*; The European Fund for the Development of Polish Villages Foundation (EFRWP), Institute of Rural and Agricultural Development, Polish Academy of Sciences (IRWIR PAN): Warsaw, Poland, 2018; p. 220.
13. Rosner, A.; Stanny, M. *Socio-Economic Development of Rural Areas in Poland*; The European Fund for the Development of Polish Villages Foundation (EFRWP), Institute of Rural and Agricultural Development, Polish Academy of Sciences (IRWIR PAN): Warsaw, Poland, 2017.
14. Kozera, A.; Głowicka-Wołoszyn, R. Identification of functional types of rural communes in Poland. In Proceedings of the 2018 International Scientific Conference Economic Sciences for Agribusiness and Rural Economy, Economic Sciences for Agribusiness and Rural Economy, Warsaw, Poland, 7–8 June 2018; Volume 1, pp. 109–115.
15. Standar, A. Realizacja przedsięwzięć inwestycyjnych przez gminy—skala, zróżnicowanie i perspektywa (Investment project implementation by communes—scale, diversity and future possibilities). *Probl. Zarządzania* **2017**, *2*, 161–172. [CrossRef]
16. *Kierunki Rozwoju Obszarów Wiejskich. Założenia do Strategii Zrównoważonego Rozwoju wsi i Rolnictwa (Lines of Rural Development. Assumptions for the Strategy of Sustainable Development of Agriculture and Rural Areas)*; Ministry of Agriculture and Rural Development: Warsaw, Poland, 2010; Volume 50, p. 16. Available online: [http://ksow.pl/fileadmin/user\\_upload/ksow.pl/pliki/rozne\\_agenda\\_itp\\_/2010.03-KROWaxc.pdf](http://ksow.pl/fileadmin/user_upload/ksow.pl/pliki/rozne_agenda_itp_/2010.03-KROWaxc.pdf) (accessed on 16 January 2019). (In Polish)
17. Standar, A.; Bartkowiak-Bakun, N. *Ocena Oddziaływania Wybranych Działań PROW 2007–2013 na Zrównoważony Rozwój Obszarów Wiejskich Polski (Analiza Regionalna)*; (Assessing the impact of selected measures under the 2007–2013 RDP on sustainable rural development in Poland (a regional analysis)); Publishing House of the Poznań University of Life Sciences: Poznań, Poland, 2015. (In Polish)
18. Hwang, C.L.; Yoon, K. *Multiple Attribute Decision-Making: Methods and Applications*; Springer: Berlin, Germany, 1981.
19. Central Statistical Office. Local Data Bank. 2019; Database. Available online: <http://www.stat.gov.pl/bdl> (accessed on 16 January 2019). (In Polish)
20. Rocznik Województwo Wielkopolskie—Podregiony, Powiaty, Gminy (Yearbook of the Wielkopolskie Voivodeship: Sub-Regions, Districts, Municipalities). Poznań Statistical Office: Poznań, Poland, 2018. Available online: <https://poznan.stat.gov.pl/publikacje-i-foldery/roczniki-statystyczne/wojewodztwo-wielkopolskie-2018-podregiony-powiaty-gminy,1,15.html> (accessed on 16 January 2019). (In Polish)
21. Wskaźniki do Oceny Sytuacji Finansowej Jednostki Samorządu Terytorialnego (Indicators for Assessment of the Financial Situation of Local Government Units). Ministry of Finance: Warsaw, Poland, 2016. Available online: <http://www.finanse.mf.gov.pl/budzet-panstwa/finanse-samorzadow/opracowania> (accessed on 16 January 2019). (In Polish)
22. Wysocki, F. *Metody Taksonomiczne w Rozpoznawaniu Typów Ekonomicznych Rolnictwa i Obszarów Wiejskich (Taxonomic Methods in the Identification of Economic Types of Agriculture and Rural Areas)*; Publishing House of the Poznań University of Life Sciences: Poznań, Poland, 2010. (In Polish)
23. Łuczak, A.; Wysocki, F. Zastosowanie mediany przestrzennej Webera i metody TOPSIS w ujęciu pozycyjnym do konstrukcji syntetycznego miernika poziomu życia (The application of spatial median of Weber and the method TOPSIS in positional formulation for the construction of synthetic measure of standard of living). *Pr. Nauk. Univ. Ekon. Wrocławiu* **2013**, *278*, 63–73. (In Polish)
24. Kozera, A.; Wysocki, F. Problem Ustalania Współrzędnych Obiektów Modelowych W Metodach Porządkowania Liniowego Obiektów (The Problem of Determining the Coordinates of Model Objects in Object Linear Ordering Methods). *Research Papers of Wrocław University of Economics Taksonomia* **27**. 2016, Volume 427, pp. 131–142. Available online: [http://www.dbc.wroc.pl/dlibra/docmetadata?id=33159&from=&dirids=1&ver\\_id=&lp=1&QI](http://www.dbc.wroc.pl/dlibra/docmetadata?id=33159&from=&dirids=1&ver_id=&lp=1&QI) (accessed on 16 January 2019). (In Polish). [CrossRef]
25. Kozera, A.; Łuczak, A.; Wysocki, F. The application of classical and positional TOPSIS methods to assessment financial self-sufficiency levels in local government units. In *Data Science: Innovative Developments in Data Analysis and Clustering*; Studies in Classification, Data Analysis and Knowledge Organization; Palumbo, F., Montanari, A., Vichi, M., Eds.; Cham Springer: Berlin, Germany, 2017; pp. 273–284.

26. Głowicka-Wołoszyn, R.; Wysocki, F. Problem Identyfikacji Poziomów Rozwoju w Zagadnieniu Konstrukcji Cechy Syntetycznej (The Problem of Identifying Development Levels in Constructing Synthetic Characteristics). *Research Papers of Wrocław University of Economics, Taksonomia* 31. 2018, Volume 508, pp. 56–65. Available online: <http://www.dbc.wroc.pl/dlibra/publication?id=64913&tab=3> (accessed on 16 January 2019). (In Polish). [[CrossRef](#)]
27. Tukey, J.W. *Exploratory Data Analysis*; Addison-Wesley: Boston, MA, USA, 1977.
28. Oliveira, E.C.; Faro, A.O.; Anderson, L.F. Comparison of Different Approaches for Detection and Treatment of Outliers in Meter Proving Factors Determination. *Flow Meas. Instrum.* **2016**, *48*, 29–35. [[CrossRef](#)]
29. Lebart, L.; Morineau, A.; Piron, M. *Statistique Exploratoire Multidimensionnelle*; Donod: Paris, France, 1995.
30. Lebart, L.; Salem, A.; Berry, L. *Exploring Textual Data*; Kluwer Academic Publishers: Dordrecht, The Netherlands, 1998.
31. Potoczek, A. *Polityka Regionalna i Gospodarka Przestrzenna (Regional Policy and Land Use Management)*; Publishing House of the Toruń University: Toruń, Poland, 2003. (In Polish)
32. Toczyński, W.; Mikołajczyk, A. *Polityka Regionalna (Regional Policy)*; College of Humanities: Gdańsk, Poland, 2001. (In Polish)
33. Kosiedowski, W. Wprowadzenie do teorii i praktyki rozwoju regionalnego i lokalnego (An introduction to the theory and practice of regional local development). In *Samorząd Terytorialny w Procesie Rozwoju Regionalnego i Lokalnego (Local Authorities in the Regional and Local Development Process)*; Kosiedowski, W., Ed.; Dom Organizatora: Toruń, Poland, 2005; pp. 11–58. (In Polish)
34. Mau, S. Soziale Ungleichheit in der Europäischen Union (Social Inequality in the European Union). In *Aus Politik und Zeitgeschichte (Notes on Politics and Contemporary History)*; 2004; Volume 38, pp. 38–46. Available online: <http://www.bpb.de/apuz/28113/soziale-ungleichheit-in-der-europaeischen-union> (accessed on 16 January 2019). (In German)
35. Stiens, G. Region und Regionalismus (Regions and Regionalism). In *Handwörterbuch zur Gesellschaft Deutschlands (Concise Dictionary of German Sociology)*; Schäfers, B., Zapf, W., Eds.; Bundeszentrale für politische Bildung: Bonn, Germany, 2001; pp. 538–550.
36. Spellerberg, A.; Huschka, D.; Habich, R. Quality of life in rural area. Process of divergence and convergence. *Soc. Indic. Res.* **2007**, *83*, 283–307. [[CrossRef](#)]
37. Solow, R.M. A Contribution to the Theory of Economic Growth. *Q. J. Econ.* **1956**, *70*, 65–94. [[CrossRef](#)]
38. Afonasova, M. The Concept of Convergent Development of Rural Areas of the Russian Federation. *Eur. Res. Stud. J.* **2017**, *20*, 14–38.
39. Quah, D. Convergence Determines Governance—Within and Without, Growth, Convergence and Income Distribution: The Road from the Brisbane G-20. Available online: <http://www.dannyquah.com/Quilled/Output/2014.11-Danny.Quah-Convergence-DeterminesGovernance-tt20-UK-Convergence-Governance-Quah.pdf> (accessed on 16 January 2019).
40. Standar, A.; Puślecki, Z.W. *Ocena Zastosowania Środków Polityki Regionalnej Unii Europejskiej Przez Samorządy Gminne Województwa Wielkopolskiego (Assessing the Use of Funds under the European Union Regional Policy by Municipal Government Units in the Wielkopolskie Voivodeship)*; Publishing House of the Poznań University of Life Sciences: Poznań, Poland, 2011. (In Polish)
41. Adamowicz, M. Dyfuzja innowacji jako czynnik rozwoju regionów peryferyjnych (Diffusion of innovations as a development factor for peripheral regions). In *Zarządzanie Wiedzą w Agrobiznesie w Warunkach Polskiego Członkostwa w Unii Europejskiej (Agribusiness Knowledge Management in Poland as a Member of the European Union)*; Adamowicz, M., Ed.; Publishing House of the Warsaw University of Life Sciences: Warsaw, Poland, 2005; pp. 581–592. (In Polish)
42. Churski, P. Czynniki rozwoju regionalnego w świetle koncepcji teoretycznych (Regional development factors in the light of theoretical concepts). *Sci. J. Humanit. Econ. Coll. Włocławek* **2005**, *19*, 3. (In Polish)
43. Fuest, C.; Huber, B. Can regional policy in a federation improve economic efficiency? *J. Public Econ.* **2005**, *90*, 499–511. [[CrossRef](#)]
44. Woś, B. *Rozwój Regionów i Polityka Regionalna w Unii Europejskiej Oraz w Polsce (Regional Development and Regional Policy in the European Union and Poland)*; Publishing House of the Wrocław University of Technology: Wrocław, Poland, 2005. (In Polish)
45. Heller, J. Dochody budżetowe samorządów gmin wiejskich w ujęciu regionalnym (Budgetary income of rural municipal government units). *Rocz. Stowarzyszenia Ekon. Rol. Agrobiz.* **2008**, *10*, 74–79. (In Polish)

46. Henckel, G. Dorf und Gemeinde (Village and Community). In *Handwörterbuch zur Ländlichen Gesellschaft in Deutschland (Concise Dictionary of Social Conditions in Rural Germany)*; Beetz, S., Brauer, K., Neu, C., Eds.; Springer: Wiesbaden, Germany, 2005; pp. 41–54.
47. Barro, R.J.; Sala-i-Martin, X. *Economic Growth*, 2nd ed.; The MIT Press: Cambridge, MA, USA, 2004.
48. Dervish, K. Convergence, interdependence and divergences. *Financ. Dev.* **2012**, *9*, 11–14.
49. Korotayev, A.; Zinkina, J.; Bogevolnov, J.; Malkov, A. Global unconditional convergence among larger economies after 1998. *J. Glob. Stud.* **2011**, *2*, 25–62.
50. Dobson, S.; Ramlogan, C. Economic growth and convergence in Latin America. *J. Dev. Stud.* **2002**, *38*, 83–104. [[CrossRef](#)]
51. Herrerias, M.J.; Ordóñez, J. New evidence on the role of regional clusters and convergence in China (1952–2008). *China Econ. Rev.* **2012**, *23*, 1120–1133. [[CrossRef](#)]
52. Ghosh, M.; Ghoshray, A.; Malki, I. Regional divergence and club convergence in India. *Econ. Model.* **2013**, *30*, 733–742. [[CrossRef](#)]
53. Andrés, J.; Doménech, R.; Molinas, C. Macroeconomic performance and convergence in OECD countries. *Eur. Econ. Rev.* **1996**, *40*, 1683–1704. [[CrossRef](#)]
54. Arnold, J.; Bassanini, A.; Scarpetta, S. Solow or Lucas? Testing speed of convergence on a panel of OECD countries. *Res. Econ.* **2010**, *65*, 110–123. [[CrossRef](#)]
55. Elhorst, J.P. The mystery of regional unemployment differentials: Theoretical and empirical explanations. *J. Econ. Surv.* **2003**, *17*, 709–748. [[CrossRef](#)]
56. Aumayr, C.M. European region types in EU-25. *Eur. J. Comp. Econ.* **2007**, *4*, 109–147.
57. Marelli, E.; Signorelli, M. Transition, regional features, growth and labour market dynamics. In *The Labour Market Impact of the EU Enlargement*; Caroleo, F.E., Pastore, F., Eds.; Springer Physica-Verlag: Berlin/Heidelberg, Germany, 2010; pp. 99–147.
58. Le Pen, Y. A pair-wise approach to output convergence between European regions. *Econ. Model.* **2011**, *28*, 955–964. [[CrossRef](#)]
59. Bartkowska, M.; Riedl, A. Regional convergence clubs in Europe: Identification and conditioning factors. *Econ. Model.* **2012**, *29*, 22–31. [[CrossRef](#)]
60. Nell, G.; Signorelli, M. *Convergence and divergence. Palgrave Dictionary of Emerging Markets and Transition Economics*; Hölscher, J., Tomann, H., Eds.; Macmillan Palgrave: London, UK, 2015; pp. 437–457.
61. Grafton, R.Q.; Knowles, S.; Owen, P.D. *Social Divergence and Economic Performance*; Department of economics Working Paper 0103E, University of Ottawa: Ottawa, ON, Canada, 2002.
62. Gałazka, A. Teoretyczne podstawy rozwoju regionalnego—wybrane teorie, czynniki i bariery rozwoju regionalnego. *Studia BAS* **2017**, *1*, 9–61.
63. Sieverts, T. *Zwischen Ort und Welt, Raum und Zeit, Stadt und Land (Intermediate City. Between Location and the World, Place and Time, Town and Country)*; Birkhäuser: Braunschweig, Germany; Wiesbaden, Germany, 1998. (In German)
64. Sobczyk, A. Instrumenty rozwoju lokalnego (Local development instruments). In *Polityka Regionalna i Lokalna w Aspekcie Wejścia Polski do Unii Europejskiej (Regional and Local Policy in the Context of Poland's Accession to the European Union)*; Fic, M., Ed.; Sulechów Vocational College: Sulechów, Poland, 2004; p. 39. (In Polish)
65. Woś, A.; Zegar, J.S. *Rolnictwo Społecznie Zrównoważone (A Socially Sustainable Agriculture)*; Institute of Agricultural and Food Economics: Warsaw, Poland, 2002; p. 51. (In Polish)
66. Standar, A.; Bartkowiak-Bakun, N. Zmiany poziomu rozwoju gminnej infrastruktury technicznej w województwie wielkopolskim (Changes in the level of development of technical infrastructure in communes of the Wielkopolska voivodeship). *J. Agribus. Rural Dev.* **2014**, *4*, 147–157.
67. Bański, J. *Przemiany Polskiej wsi (Transformation of Polish Rural Areas)*; Institute of Geography and Spatial Organization of the Polish Academy of Sciences: Warsaw, Poland, 2010.
68. Foundation for Development of Polish Agriculture. *Rural Poland 2016. The Report on the State of Rural Areas*; Scholar Publishing House: Warsaw, Poland, 2016.
69. Kaczmarek, T. Obszar metropolitalny jako przedmiot badania i narzędzie działania (Metropolitan area as a subject matter of studies and an actionable tool). In *Delimitacja Poznańskiego Obszaru Metropolitalnego (Delimitation of the Poznań Metropolitan Area)*; Kaczmarek, T., Kaczmarek, U., Mikuła, Ł., Bul, R., Walaszek, M., Eds.; Metropolitan Research Center of the Adam Mickiewicz University, Library of the Poznań Agglomeration: Poznań, Poland, 2014.



70. Kopczevska, K. *Rola Sektora Publicznego w Przestrzennym Rozwoju Państwa (Role of the Public Sector in the Territorial Development of a Country)*; CeDeWu.pl: Warsaw, Poland, 2011. (In Polish)
71. European Charter of Local Self-Government Signed 15 October 1985, Strasbourg, France, ETS No.122. Available online: <https://www.coe.int/en/web/conventions/full-list/-/conventions/treaty/122> (accessed on 18 April 2019).
72. Act on Incomes of Local Government Units of November 13, 2003, Journal of Laws of 2010, No. 80, Item 526. Available online: <http://prawo.sejm.gov.pl/isap.nsf/download.xsp/WDU20032031966/U/D20031966Lj.pdf> (accessed on 18 April 2019).
73. Dafflon, B.; Beer-Toth, K. Managing Local Public Debt in Transition Countries: An Issue of Self-Control. Paper Prepared at the 14th Annual Conference of the Network of Institutions and Schools of Public Administration in Central and Eastern Europe (NISPAcee). Available online: [https://www.researchgate.net/publication/227821199\\_Managing\\_local\\_public\\_debt\\_in\\_transition\\_countries\\_an\\_issue\\_of\\_self-control](https://www.researchgate.net/publication/227821199_Managing_local_public_debt_in_transition_countries_an_issue_of_self-control) (accessed on 18 April 2019).
74. Kata, R. Ryzyko finansowe w działalności jednostek samorządu terytorialnego–metody oceny (Financial risk in the activities of local government units—the method of assessment). *Zesz. Nauk. Sggw Eiogż* **2012**, *97*, 129–141.
75. Public Finance Act of June 30, 2005, Journal of Laws of 2005, No. 249, Item 2104. Available online: <http://prawo.sejm.gov.pl/isap.nsf/download.xsp/WDU20052492104/U/D20052104Lj.pdf> (accessed on 18 April 2019).
76. European Commission, History of the Policy. Available online: [https://ec.europa.eu/regional\\_policy/en/policy/what/history/](https://ec.europa.eu/regional_policy/en/policy/what/history/) (accessed on 1 October 2019).
77. Barcz, J. *Przewodnik po Traktacie z Lizbony. Traktaty Stanowiące Unię Europejską. Stan Obecny Oraz Teksty Skonsolidowane w Brzmieniu Traktatu z Lizbony (Guide to the Treaty of Lisbon. Treaties Constituting the European Union. Current Status and Consolidated Texts as Amended by the Treaty of Lisbon)*; Wyd. Prawnicze LexisNexis: Warszawa, Poland, 2008. (In Polish)
78. European Commission. *Investing in Europe's Future. Fifth Report on Economic, Social and Territorial Cohesion*; Publications Office of the European Union: Luxembourg, 2010.
79. European Commission. *Investment for Jobs and Growth. Promoting Development and Good Governance in EU Regions and Cities*; Sixth Report on Economic, Social and Territorial Cohesion; Publications Office of the European Union: Luxembourg, 2014.
80. European Commission. *My Region, My Europe, Our Future. Seventh Report on Economic, Social and Territorial Cohesion*; Publications Office of the European Union: Luxembourg, 2017.
81. Rodriguez-Pose, A.; Fratesi, U. Between development and social politics: The impact of European structural funds in Objective 1 regions. *Reg. Stud.* **2004**, *38*, 97–113. [[CrossRef](#)]
82. Gorzelak, G. Polska polityka regionalna wobec zróżnicowań polskiej przestrzeni (Polish regional policy towards the diversity of Polish space). *Studia Reg. Lokalne* **2004**, *4*, 37–72. (In Polish)
83. Filipiak, B.; Kogut, M.; Szewczuk, A.; Ziolo, M. *Rozwój Lokalny i Regionalny. Uwarunkowania, Finanse, Procedury (Local and Regional Development. Conditions, Finance, Procedures)*; Fundacja na rzecz Uniwersytetu Szczecińskiego: Szczecin, Poland, 2005. (In Polish)
84. Strategia Rozwoju Kraju na Lata 2007–2015 (National Development Strategy for 2007–2015). Ministry of Regional Development. Available online: [http://pkpplewiatan.pl/upload/File/plik/Strategia\\_Rozwoju\\_Kraju.pdf](http://pkpplewiatan.pl/upload/File/plik/Strategia_Rozwoju_Kraju.pdf) (accessed on 1 October 2019). (In Polish).
85. Narodowe Strategiczne Ramy Odniesienia 2007–2013 (National Strategic Reference Framework 2007–2013). Ministry of Regional Development. Available online: [https://www.funduszeuropejskie.2007-2013.gov.pl/WstepDoFunduszyEuropejskich/Documents/NSRO\\_maj2007.pdf](https://www.funduszeuropejskie.2007-2013.gov.pl/WstepDoFunduszyEuropejskich/Documents/NSRO_maj2007.pdf) (accessed on 1 October 2019). (In Polish)
86. Strategia Rozwoju Województwa Wielkopolskiego do 2020 (Development Strategy of Wielkopolska Province until 2020). Wielkopolska Voivodship Regional Assembly. Available online: [http://www.wrot.umww.pl/wp-content/uploads/2014/07/Strategia-rozwoju-wojew%C3%B3dztwa-wielkopolskiego-do-2020-r\\_2005.pdf](http://www.wrot.umww.pl/wp-content/uploads/2014/07/Strategia-rozwoju-wojew%C3%B3dztwa-wielkopolskiego-do-2020-r_2005.pdf) (accessed on 1 October 2019). (In Polish).
87. Krajowa Strategia Rozwoju Regionalnego 2010–2020–Regiony, Miasta, Obszary Wiejskie (National Strategy for Regional Development 2010–2020–Regions, Cities, Rural Areas). Ministry of Regional Development. Available online: <http://prawo.sejm.gov.pl/isap.nsf/download.xsp/WMP20110360423/O/M20110423.pdf> (accessed on 1 October 2019). (In Polish)

88. Gaczek, M.W. Zróżnicowanie wewnętrzne województwa wielkopolskiego (Internal diversity of the Wielkopolskie voivodship). *Biul. KPZK PAN* **2001**, *197*, 37–58. (In Polish)
89. Motek, P. *Gospodarka Finansowa Samorządu Terytorialnego w Województwie Wielkopolskim (Financial Economy of Local Government in the Wielkopolska Voivodeship)*; Bogucki Wydawnictwo Naukowe: Poznań, Poland, 2006. (In Polish)
90. Dolata, M. Wewnętrzne zróżnicowanie poziomu rozwoju gospodarczego województwa wielkopolskiego (Internal differentiation of the level of economic development of Wielkopolska voivodeship). In *Charakter Regionalny Województwa Wielkopolskiego (Regional Character of the Wielkopolska Voivodeship)*; Czyż, T., Ed.; Biuletyn Instytutu Geografii Społeczno-Ekonomicznej i Gospodarki Przestrzennej UAM: Poznań, Poland, 2009; Volume 9, pp. 63–76. (In Polish)
91. Satoła, Ł.; Standar, A.; Kozera, A. Financial autonomy of local government units: Evidence from Polish rural municipalities. *Lex Localis—J. Local Self-Gov.* **2019**, *17*, 321–342.
92. Gardini, S.; Grossi, G. What is known and what should be known about factors affecting financial sustainability in the public sector, A literature review. In *Financial Sustainability and Intergenerational Equity in Local Governments*; Rodriguez Bolivar, M.P., Lopez Subires, M.D., Eds.; IGI Global: Hershey, PA, USA, 2018; pp. 179–205. [[CrossRef](#)]
93. Wibbels, E.; Rodden, J. Business Cycles and Political Economy of Decentralized Finance: Lessons for Fiscal Federalism in the EU. In *Fiscal Policy Surveillance in Europe*; Wierst, P., Ed.; Macmillan: London, UK, 2006; pp. 1–43.
94. Wolman, H. *National Fiscal Policy and Local Government During the Economic Crisis Urban Policy Paper Series*; The German Marshall Fund of the United States: Washington, DC, USA, 2014.
95. Blochliker, H.; Charbit, C.; Pinero Campos, J.M.; Vammalle, C. *Sub-Central Governments and Economic Crisis: Impact and Policy Responses*; Economics Department Working Papers 752; OECD: Paris, France, 2010.
96. Smutek, J. Change of municipal finances due to suburbanization as a development challenge on the example of Poland. *Bull. Geogr. Soc.-Econ. Ser.* **2017**, *37*, 139–149. [[CrossRef](#)]
97. Hendrick, R. *Managing the Fiscal Metropolis: The Financial Policies; Practices, and Health of Suburban Municipalities*; Georgetown University Press: Washington, DC, USA, 2011.
98. Wixforth, J. *Kommunal Finanzen in Suburbia. Das Beispiel der Regionen (Municipal Finances in Suburbia. The Example of the Regions)*; VS Verlag für Sozialwissenschaften: Wiesbaden, Germany; Berlin/Heidelberg, Germany, 2009. (In German)



Article

# Search for Measure of the Value of Baltic Sustainability Development: A Meta-Review

Piotr Staszkiwicz

Collegium of Business Administration, SGH Warsaw School of Economics, al. Niepodległości 162, 02-554 Warsaw, Poland; piotr.staszkiwicz@mail.com

Received: 20 October 2019; Accepted: 22 November 2019; Published: 24 November 2019

**Abstract:** The purpose of the study is to identify a sustainability development measure. The United Nations announced 17 development objectives in Agenda 2030. This research attempts to identify a measurement which captures all of the UN objectives. It uses the Baltic Sea Region as a natural laboratory for the sustainability discussion. This paper provides an analysis of a sample from the population of 159 research papers, published between 1990 and 2019. With the application of citation count regression, the population of papers is reduced to a sample of the heterogenic papers. These papers were then analysed for the existence of an integrated sustainability development measurement. The results indicate that there is no available applied or theoretical model for an integrated measurement of sustainable development across all of the United Nation's goals. The study provides the framework for a further matrix in reference to gross domestic product. The results are robust in terms of different sample specifications. The identified research gap has a policy implication. There is a need to develop a universal and comprehensive sustainable value measure to support policymakers and their public choices.

**Keywords:** sustainability management; creating value; synthesis; review; regression of citation count; 2030 agenda; 17 objectives; Baltic Sea Region; individual transaction sustainability value; ODS ONU; negative externalities; indicators sustainability

---

## 1. Introduction

This study asks whether a common measurement of all the United Nation's sustainable goals exists.

The purpose of the study is to identify a sustainability development measure which captures the widest range of the United Nation's goals. The specific objective is to identify the basic results of diversity studies. The study is important for policymakers since without a common measurement, we are unable to compare the values created in different sustainable areas.

In order to achieve both objectives, different research approaches have been used; in the case of the basic objective, research populations have been identified based on a sociometric database. A purpose-driven sample of various studies was identified, with the application of citation count regression. The worldwide sustainable literature is vast, thus the geographic scope was narrowed to the Baltic Sea Region (BSR), as it is a natural laboratory for research on sustainable development.

This paper contributes to the literature in two areas, namely on sustainable development and synthesis, and on meta-analysis of scientific research. In the area of research on sustainable development, the results indicate tendencies towards an atomic rather than a holistic perception of problems and processes in the area of the BSR. In the area of meta-analysis and research synthesis, the results confirm the effectiveness of using citation count regression not only for population reduction in the area of auditing studies [1] but also in the area of sustainable development.

The remainder of the paper is organised as follows: section two discusses the literature and develops the testing hypothesis, section three outlines the methodological approach, section four is devoted to the data sets, section five discusses the findings, and the last section concludes the paper.

## 2. Literature Review

Sustainable development has attracted attention in numerous fields, e.g. risk management [2], resource management [3], economic development [4], and corporate responsibilities [5] to name a few.

The 2030 Agenda for Sustainable Development presented by the United Nations included 17 development objectives [6–9]. The United Nation's proposals do not include measures that would imply the level of achievement of the objectives [10]. Hence, different approaches have emerged in the literature concerning potential measures of sustainable development (e.g., reference [11]) and the need to integrate measurements [12]. The core discussion focus on the integration of the various aspects of economic, social, and environmental indications into a composite index [13,14]. The integration is applied at different levels of the potential cross section of the UN goal, for example, in city management [15,16], farming [17], waste management [18], and harbour traffic impacts on air quality [15]. The proposals apply different approaches, including correlation analysis and a transaction driven approach.

There is a lack of measures like the gross national product that aggregates results for all 17 objectives and offers policymakers an easy tool for allocating resources. A measure that integrates the 17 objectives would be extremely helpful in developing and implementing sustainable development policies. In this study, a synthesis of the literature on the BSR was used to search for such a measure. The synthesis allows for capturing research trends and directions of potential development, while the BSR is a natural laboratory concentrating on global problems. Therefore, the following working hypothesis has been formulated.

**Hypothesis 1.** *In the area of research on the BSR, a measure integrating all 17 objectives of Agenda 2030 was applied.*

While performing an initial review of the literature on sustainable development in the area of the BSR, synthetic works aimed at integrating research from various areas have not been identified. Although a literature review in reference [19] was used, no studies aimed at indicating a unified way of measuring sustainable development were identified. This research, however, tends to present a wider approach and draw the landscape of the entire spectrum of sustainable issues potential measurement. The existence of the uniform matrix is probably the key milestone for sustainable value management. Therefore, this study fills this gap and determines areas for further research.

## 3. Outline of the Test Method

The global discussion on the sustainability development is vast and comprehensive, thus this study's scope focused on studies relating to the Baltic region.

The BSR is a natural laboratory for research and sustainable development (see Figure 1). In addition to the countries with direct access to the Baltic Sea, the BSR also includes Norway, the Czech Republic, Slovakia, Belarus, and Ukraine. This is an area affected by two groups of countries: the first group is the European Community and Norway, and the second group is Russia, Belarus, and Ukraine. This is where the interests of individual municipalities, countries, international communities, and various social and economic systems clash. In view of the above, addressing transnational problems relating to sustainable development requires local, national, transnational, and intergovernmental consensus. Hence, the solutions developed in the area of the BSR may be generalised to global issues.



Figure 1. Baltic region countries.

The aggregation of the research results can be done with the application of various methods. The most common is a narrative discussion of selected papers. The narrative discussion is subject to the author selection bias. The alternative approach is a meta-analysis, which allows the verification of the hypothesis by calculating the overall effect of all studies in a given literature. The meta-analysis however requires a common hypothesis. The citation count regression avoids both methodological limitations. The citation count regression identifies a select number of important papers for a narrative literature review. It is not affected by researcher bias and does not require a common hypothesis among the literature in discussion. Since the synthesis method used was developed at the beginning of 2019, the papers that were published were not identified and would use the method of regression of the number of citations to reduce the population dimension. Hence, the presented study fills a research gap both in terms of the subject matter of the study and in terms of the research method. Next, the idea of using the regression of citation numbers as a supplement to meta-analysis and synthesis of literature will be presented.

The method allows the reduction of a large group of articles to a smaller sample. The selection of the sample is not of a random nature, and selected articles should be characterised by a large substantive diversity. It applies the properties of linear regression and the number of citation count regression. It applies to the group of articles metadata, for example, the year of publication, an affiliation of the authors, etc. In the model, the number of citations is a dependent variable. The idea of selection is to choose such articles as leverage observations.

The analysis of a fit regression model utilised the fact that one observation (atypical) can significantly change the model parameter estimation. Figure 2 presents three situations: a lack of atypical observation (panel A), and two specific cases. Atypical observations can be leverage observations (panel B) or outliers (panel C). A combination of an outlier and the leverage can affect the accuracy of the model. Hence, during modelling, influential observations are not identified based on Diffits tests, Cook distances, or other measure.

Panel A

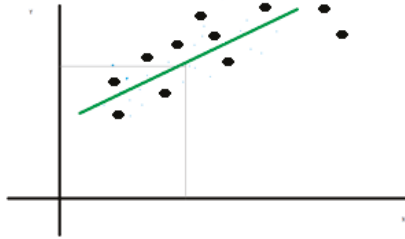

Panel B

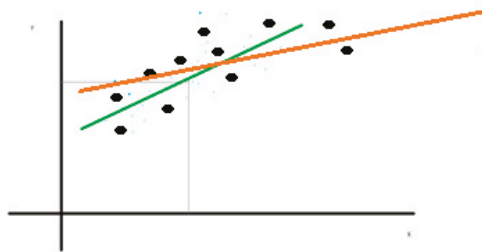

Panel C

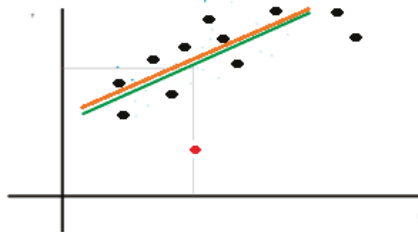

**Figure 2.** Panel A – The regression line for a uniform set of observations. Panel B - The regression line for leverage observations. Panel C - The regression line for outlier observations.

In the discussed method, the scenario indicated in Figure 1 Panel B is used to reduce the group of articles for narrative description, such observations (articles) are selected from the regression of the number of citations, which have the character of leverage rather than influential citations. The choice is less dependent on the model's matching.

This study applies the following design: firstly, the population of the literature is defined with application of the key words research. Secondly, the entire population is coded with the citation count regression variables. Thirdly, the high leverage observation (the paper) estimated with the citation count regression constitutes the narrative sample. Finally, the sample is analysed against the null hypothesis. Based on the narrative review, the hypothesis is either rejected or accepted.

#### 4. Dataset

Based on the Web of Science Clarivate Analytics sociometric database, research populations were identified. The database was searched according to the keyword "Baltic" and then "sustainability" covered the period from 1990 to 2019. Population identification was carried out in June 2019. The identified population of 159 scientific articles met the selection criteria. A list of articles making up the general population is available electronically (see Appendix A). Based on the analysis of article abstracts, metadata in the form of detailed variables were extracted. The list of variables and their definitions are presented in Table 1.

**Table 1.** Variables names and definitions.

Variable	Definition
TC/Year	The number of citations divided by the number of years (in the denominator the year of publication - one value)
Publication_Year	2019 + 1 minus year of publication natural number
Method	Binary variable value 1 for the survey when regression methods are used, 0 in other cases
Time_Span	The time range in the years of the sample
Sample	Size of the test sample in units of measurement
Agriculture	Binary variable value 1 for the agricultural survey, 0 in other cases
Transport	Binary variable value 1 for the transport survey, 0 in other cases
Fishing	Binary variable value 1 for the fishing survey, 0 in other cases
Energy	Binary variable value 1 for the energy survey, 0 in other cases
Pollution_Control	Binary variable value 1 for pollution damages, 0 in other cases
Business_Finance_Mgt	Binary variable value 1 for the finance business or economy survey, 0 in other cases

In contrast to the original study presenting the methodology used [1], the AngloSaxon variables (identifying whether the authors of the study have roots in the English-speaking culture) BigSample (identifying studies with more than 1000 observations in the sample) were not used, as well as the type of financing due to the fact that these variables had low discriminatory power and introduced approximate collinearity of the model. Extensions of meta-variables related to research fields were introduced due to the heterogeneity, contrary to the original proposal, of the subject of the study. A time-weighted number of citations was used as a dependent variable. The variables: Agriculture, Transport, Fishing, Energy, Pollution\_Control, Business\_Finance\_Mgt define fields of research.

The following regression equation was applied:

$$TC\_Year = \beta_0 + \beta_1 Publication\_Year + \beta_2 Method + \beta_3 TimeSpan + \beta_4 Sample + \beta_5 Agriculture + \beta_6 Transport + \beta_7 Fishing + \beta_8 Energy + \beta_9 Pollution\_Control + \beta_{10} Business\_Finance\_Mgt + \varepsilon \quad (1)$$

where

$\beta_i$  is the coefficient of the variable  $i$  and  $\varepsilon$  is the error term.

Estimations were carried out using the classical method of the smallest squares (OLS) with the correction of heteroskedasticity.

#### 5. Results

Table 2. presents the distribution of the population by the research area.

**Table 2.** Number of papers by areas.

Area	Number of Papers
Agriculture	7
Transport	6
Fishing	28
Energy	12
Pollution_Control	16
Business_Finance_Mgt	16
Unallocated	74
Sum	159

Of the total population there are only three articles that comprise more than one field, namely works V. Bobinaite [20] - energy and management, A. Sundkvist, A.M. Jansson, P. Larsson [21] - energy and pollution, and finally M. Hammer, A. Jansson, B.O. Jansson [22] - Governance and Fisheries. An important part of the population is the items that cannot be clearly attributed to the area. Descriptive statistics of the population are presented in Table 3.

**Table 3.** Descriptive statistics.

Variable	Mean	Med.	Min.	Max.	Std. Dev.	Skew.	Kurt.	5% Perc.	95% Perc.
TC_Year	1.8	0.6	0.0	19.2	3.2	3.1	10.2	0.0	11.0
Publication_Year	9.1	7.0	1.0	27.0	5.9	0.9	0.1	1.0	23.0
Method	0.1	0.0	0.0	1.0	0.3	3.2	8.3	0.0	1.0
Time_Span	8.0	0.0	0.0	1000.0	79.4	12.4	152.1	0.0	14.0
Sample	113.5	0.0	0.0	18,000.0	1427.5	12.5	154.0	0.0	0.0
Agriculture	0.0	0.0	0.0	1.0	0.2	4.4	17.8	0.0	0.0
Transport	0.0	0.0	0.0	1.0	0.2	4.9	21.5	0.0	0.0
Fishing	0.2	0.0	0.0	1.0	0.4	1.7	0.9	0.0	1.0
Energy	0.1	0.0	0.0	1.0	0.3	3.2	8.3	0.0	1.0
Pollution_Control	0.1	0.0	0.0	1.0	0.3	2.7	5.0	0.0	1.0
Business_Finance_Mgt	0.1	0.0	0.0	1.0	0.3	2.7	5.0	0.0	1.0

The population is characterised by relatively high variability within the sample size range. Table 4 presents the estimated model of citation regression count together with model diagnostics.

**Table 4.** Model estimation results.

	Coefficient	Std. Error	t-ratio	p-Value
Const.	1.65278	0.548219	3.0148	0.0030 ***
Publication_Year	0.0240776	0.0463692	0.5193	0.6044
Method	-0.49815	0.481207	-1.0352	0.3023
Time_Span	-0.00156831	0.000483838	-3.2414	0.0015 ***
Sample	-0.00011668	$3.92137 \times 10^{-5}$	-2.8477	0.0050 ***
Agriculture	-0.869443	0.719052	-1.2092	0.2285
Transport	0.236317	1.2931	0.1828	0.8552
Fishing	0.828027	0.790064	1.0481	0.2963
Energy	-0.984779	0.469697	-2.0966	0.0377 **
Pollution_Control	0.181339	1.0242	0.1771	0.8597
Business_Finance_Mgt	-1.07773	0.452412	-2.3822	0.0185 **
Model diagnostics				
Mean dependent var	1.760225	S.D. dependent var.	3.205253	
Sum squared resid.	1553.164	S.E. of regression	3.239499	
R-squared	0.043168	Adjusted R-squared	-0.021483	
F(10, 148)	5.052342	P-value(F)	$2.56 \times 10^{-6}$	
Log-likelihood	-406.8033	Akaike criterion	835.6065	
Schwarz criterion	869.3645	Hannan-Quinn	849.3153	

\*\*\*  $p < 0.01$ , \*\*  $p < 0.05$ , \*  $p < 0.1$ . Model: OLS, using observations 1–159. Dependent variable: TC\_Year. Heteroskedasticity-robust standard errors, variant HC1.



The model fit rates are low but this is not an obstacle to sample identification because the method is robust and depends primarily on the difference in the directional coefficients of the original model and the reduced model. Table 5 shows the leverage points (papers) for which the value of the test statistic exceeded the reference level, while Table 6 shows distribution by areas.

Table 5. Leverage papers.

No	First author	error u	leverage $0 < h \leq 1$	Year	Ref.
1	Svanback, A	-0.79016	0.161 *	2019	[23]
2	Yatskiv, I	-1.9613	0.167 *	2017	[24]
3	Reidla, K	-0.85557	0.154 *	2017	[25]
4	Schroder, M	-1.2354	0.167 *	2016	[26]
5	Boonstra, WJ	3.3704	0.151 *	2016	[27]
6	Beifert, A	-0.62965	0.151 *	2016	[28]
7	Brankovic, N	-1.9854	0.167 *	2016	[29]
8	Proskurina, S	1.3984	0.167 *	2015	[30]
9	Streimikiene, D	-0.09024	0.161 *	2007	[31]
10	Urboniene, R	-1.2375	0.157 *	2015	[32]
11	Bobinaite, V	2.2094	0.189 *	2015	[20]
12	Lotz, C	-2.0095	0.167 *	2015	[33]
13	Dekker, W	0.001682	1.000 *	2013	[34]
14	Lindholm, M	5.7933	0.169 *	2012	[35]
15	Taagepera, R	0.14328	0.995 *	2011	[36]
16	Deutsch, L	-0.21117	0.147 *	2005	[37]
17	Sundkvist, A	-0.25419	0.170 *	2001	[21]
18	Valpasvuo-Jaatinen, P	0.45333	0.174 *	1997	[38]
19	Libert, B	-1.3371	0.174 *	1997	[39]
20	Hammer, M	-0.53465	0.148 *	1993	[22]

\* Leverage observation.

Table 6. Distribution of the leverage papers by areas.

First author	Agriculture	Transport	Fishing	Energy	Pollution	Business finance
Svanback, A	1	0	0	0	0	0
Yatskiv, I	0	1	0	0	0	0
Reidla, K	1	0	0	0	0	0
Schroder, M	0	1	0	0	0	0
Boonstra, WJ	1	0	0	0	0	0
Beifert, A	0	1	0	0	0	0
Brankovic, N	0	1	0	0	0	0
Proskurina, S	0	1	0	0	0	0
Urboniene, R	0	0	0	0	1	0
Bobinaite, V	0	0	0	1	0	1
Lotz, C	0	1	0	0	0	0
Dekker, W	0	0	1	0	0	0
Lindholm, M	0	1	0	0	0	0
Taagepera, R	0	0	0	0	0	0
Streimikiene, D	0	0	0	0	0	0
Deutsch, L	1	0	0	0	0	0
Sundkvist, A	0	0	0	1	1	0
Valpasvuo-Jaatinen, P	1	0	0	0	0	0
Libert, B	1	0	0	0	0	0
Hammer, M	0	0	1	0	0	1

The selected sample includes all the articles in multiple domains and all the control variables are represented, including articles not assigned to domains.

## 6. Discussion

Descriptive statistics show a low degree of article differentiation between domains. Indeed, only three articles focused on more than one domain, namely V. Bobinaite [20], A. Sundkvist, A. Jansson and P. Larsson, [21], and M. Hammer et al. [22]. The result indicates tendencies for detailed analyses and silage of research within one or two fields. At the same time, a high percentage of articles not assigned to any of the fields suggests a strong development of the subject and scope of research. By far the most widely represented articles in the population are ones that are not assigned to a specific field, followed by articles on fishing, economics and management, environmental protection (pollution) and energy, agriculture, and transport.

The selected target sample does not reflect the population structure, because the broadest represented domain is transport (seven articles); followed by agriculture (six articles); other (i.e., fisheries, energy, and environmental protection (pollution), economics, and management); and not allocated (two articles each). While the thematic structure is not reproduced, the time range of the sample extends from 1993 to 2019 and almost coincides with the general population period, i.e., 1990–2019.

### *Agriculture*

Reidla and Nurmet [25] analysed dairy farms and studied economic and social conditions of production, concluding that in comparison to other regions, dairy farms in the BSR do not differ significantly from other regions. Svanbäck et al. [23] addressed the links between animal production and the number of nutrients flowing into the Baltic Sea. They pointed to the relation between the concentration of animal production in the case of nitrogen and phosphate fertilisers applied in areas with a high concentration of animal production. The authors stated that the application of the EU common agricultural policy resulted in a decrease in the inflow of nutrients to the Baltic Sea in the period from 2000 to 2010. Boonstra et al. [27] conceptualised additional social-ecological traps beyond lack of adaptative capacity. They constructed a typology of human responses. Deutsch and Folke [37] noticed that the ecosystem areas appropriated (ArEAs) for agricultural production in Sweden have decreased from 1962 to 1994. The authors attributed the results to the fact that production in Sweden is supplied by ecosystems of other nations. Valpasvuo-Jaatinen et al. [38] called, in 1997, for a common standardised system for assessing the present and future sustainability of agriculture for the BSR, while Libert [39] showed the paths for agricultural transition towards sustainability in the western countries of the Baltic region. All of the mentioned papers in agriculture were dedicated to a specific issue, while Valpasvuo-Jaatinen et al. [38] tend to present the common standards, but limited to agriculture, thus in the agriculture subsample, the common universal value measurement for sustainable development was not identified.

### *Transport*

Yatskiv and Budilovich [24] based on the study case of planning decisions for the passenger network in Riga City, showed the need for multi-modal passenger transportation sustainable development. Schroder and Prause analysed the economic, ecological, and social risks appearing in the context of handling and transportation of dangerous goods in a Green Transport Corridor, while Beifert [28] showed the different limitations of air-cargo transport for the local Baltic Sea airports. Brankovic, Salketic, and Ferizovic [29] described how Baltic-Adriatic transport flows could be affected by a single railway line. Proskurina et al. [30] identified an inherent limitation within the Russian pellet business, which faces constraints due to an oligopolistic market structure, inadequate infrastructure, and a lack of foreign investments. Lotz [33] showed the spatial interconnection between the railway network and accessible forest resources, and its trade-off for the forest sustainable management. Lindholm and Behrends [35] pointed out the lack of a methodology for analysing freight transport on the urban areas. The papers within the transport area touched on a number of different aspects of transportation. owever

similarly to for agriculture, there were no instances noted that proposed and unified measurement methods to determine a sustainability value.

*Fishing, Energy, Pollution, Business, and others*

Dekker and Sjöberg [29] examined the factors affecting stocks of European eel and concluded that the fishing impact on the eel population was less than 10%. Hammer et al. [22] claimed to conserve biodiversity in the fishing industry we need the resource-management systems, placing themselves at the edge of both the fishing and business areas. A similar linkage between business and energy can be observed in Bobinaite's research [20]. With the application of the Altman-like insolvency prediction model [40,41], Bobinaite identified the bankruptcy risk among the electricity producers in the BSR. This leads to the concern of energy security and need for cross-country cooperation. Sundkvist et al. [21] identified a problem on the intersection between energy and pollution. They contrast the local small-scale and centralised large-scale bread production. In doing so, they identified contradictory forces. Due to inefficient technology production, the local bakeries require more total energy input per kilogram of bread than an industrial bakery. Concurrently, the emissions of CO<sub>2</sub>, SO<sub>2</sub>, and NO<sub>x</sub> are smaller from the local bakeries than from big bakeries. This is because the transportation routes are shorter in local bakeries and the oil is more frequently used for heating the ovens in large bakeries. Urboniene et al. [32] discussed the projection coverage of vegetation and morphometric parameters of the beach. The unallocated papers to the specific area represent Taagepera [36] and Streimikiene [31]. Taagepera shows the historical precondition for the national sustainable development, while Streimikiene points out the knowledge spill over in terms of energy cooperation across Baltic States. All of the studies mentioned above do not offer an integrated measurement of sustainable development across all of the United Nation's goals.

The findings of this study lead to the rejection of the initial hypothesis that in the area of research on the BSR, a measure integrating all 17 objectives of Agenda 2030 was applied. Consequently, it shows the discrepancy between the goals and the way we measure them. There is no one integrated sustainability goal value, thus policymakers must cope with the different aspects of sustainable development. Suppose there was one integrated measurement, meaning at the applied research and policy level, we would be able to compare different policy actions and their results. As per an analogy to gross domestic product, the desired measurement would integrate different levels of sustainability activity (goals) into one measurable indicator. We might expect that to provide such a measurement, we need to record all of the sustainable transactions (human interactions with the global environment) and assign to them a common measurement, then aggregate them to the country, region, or continent values. Let us call this desired measurement the Gross Sustainable Impact (GSI). Possession of such an aggregated and general indicator would support the policymakers and society with their decision. The GSI constitutes a precondition for general value measurement. In particular it might be subject to a reliability issue, (e.g., in sustainable reporting studies, Waniak-Michalak et al. [5] showed that entities may treat sustainability reports as a tool for legitimising their actions) which indicates a space for influence. A search for the concrete concept of the GSI and its practical application might be a goal for further studies.

*Robustness of Results and Limitations*

The above-stated results are conditioned on the sample selection methods and its stability as well as being subject to the metadata selected for regression analysis. Thus, a selection might be subject both to the sampling bias and the model variables selection bias. The original procedure [1] was proven to be stable, however, it was tested on other types of papers. Therefore, to test the stability of the results, an additional 11 papers were randomly sampled from the general population. The random sample consists of the following papers: Holma et al. [42], Siksnylyte et al. [43], Oleinikova et al. [44], Holmgren et al. [45], Jokikokko and Huhmarniemi [46], Zhang [47], Larsson and Granstedt [48], Orru and Orru [49], Hallemaa et al. [50], Heikinheimo et al. [51], and Raukas and Tavast [52]. Within

the random sample, there was no identified paper which applies or proposes the method to integrate all the United Nations goals. Thus, the primary results tend to be stable.

It is important to add a disclaimer here. As this article is written based on the Baltic region, it is not fully legitimate to claim that there is a lack of GSI measurements within all sustainable research areas globally. Nevertheless, if we accept the unique characteristic of the BSR as being representative of global issues, then the entire analysis of this research area becomes more plausible, however is not fully convincing.

## 7. Conclusions

The study focused on the search of the studies which would apply a common measurement to all of the United Nations sustainability goals. It failed to present such a measurement in respect of the BSR, which is likely to hold true in terms of the global discussion. Without a common measurement method, we are unable to compare the values created across the different sustainable areas, thus the steering of the global human activities is subject to decision biases.

This study provides robust evidence on the sustainable development discussion on the BSR, which might be a starting point for discussion on the practical application of an index driven measurement.

This study proposes to develop an aggregated measurement based on the individual transaction sustainability value. The aggregation of the value of each transaction would inherit some characteristics of the gross domestic product concept and support policymakers with their social choices. The concept of the Gross Sustainable Impact and its practical application could be developed with further studies.

**Funding:** This project was financially supported by SGH project number KNOP/S19/10/19 headed by A. Fierla.

**Acknowledgments:** The paper benefits from the insight discussion with participants of the Baltic University Program, Student and Teacher SAIL 2019. A special thanks go to Lars Osterlund, Sinikka Suomalainen, Wojciech Janicki, Xi-Lillian Pang, Mats Bergman, Sofia Nakonechna, Andrey Nikishin, Yash Chawla, Emma Johansson. This project benefits from the unique experience co-organised by Dominika Stygar at Students SAILS 2019.

**Conflicts of Interest:** The author declare no conflict of interest.

## Appendix A

The papers included in the analysed population: DOI:10.17632/gvysfjrfp5.1

## References

1. Staszkiwicz, P. The application of citation count regression to identify important papers in the literature on non-audit fees. *Manag. Audit. J.* **2019**, *34*, 96–115. [[CrossRef](#)]
2. Kaczmarek, J. The Mechanisms of Creating Value vs. Financial Security of Going Concern—Sustainable Management. *Sustainability* **2019**, *11*, 2278. [[CrossRef](#)]
3. Ma, H.; Sun, Q.; Gao, Y.; Gao, Y. Resource Integration, Reconfiguration, and Sustainable Competitive Advantages: The Differences between Traditional and Emerging Industries. *Sustainability* **2019**, *11*, 551. [[CrossRef](#)]
4. Gorynia, M.; Nowak, J.; Trapeczyński, P.; Wolniak, R. Friend or Foe? On the role of institutional reforms in the investment development path of Central and East European economies. *Int. Bus. Rev.* **2019**, *28*, 575–587. [[CrossRef](#)]
5. Waniak-Michalak, H.; Sapkauskienė, A.; Leitonienė, S. Do companies manipulate CSR information to retain legitimacy? *Eng. Econ.* **2018**, *29*. [[CrossRef](#)]
6. Sustainable, T.; Goals, D. *The Sustainable Development Goals Report 2016*; Afghanistan Centre at Kabul University: Kabul, Afghanistan, 2016.
7. Griggs, D.; Stafford-Smith, M.; Gaffney, O.; Rockström, J.; Öhman, M.C.; Shyamsundar, P.; Steffen, W.; Glaser, G.; Kanie, N.; Noble, I. Sustainable development goals for people and planet. *Nature* **2013**, *495*, 305–307. [[CrossRef](#)] [[PubMed](#)]
8. Costanza, R.; Daly, L.; Fioramonti, L.; Giovannini, E.; Kubiszewski, I.; Mortensen, L.F. The UN Sustainable Development Goals and the Dynamics of Well-being. *Front. Ecol. Environ.* **2016**, *14*, 59. [[CrossRef](#)]

9. Gaffney, O. Quiet green revolution starts to make some noise. *Nature* **2014**, *505*, 587. [[CrossRef](#)] [[PubMed](#)]
10. Bebbington, J.; Unerman, J. Achieving the United Nations Sustainable Development Goals. *Account. Audit. Account. J.* **2018**, *31*, 2–24. [[CrossRef](#)]
11. Fuso Nerini, F.; Tomei, J.; To, L.S.; Bisaga, I.; Parikh, P.; Black, M.; Borrión, A.; Spataru, C.; Castán Broto, V.; Anandarajah, G.; et al. Mapping synergies and trade-offs between energy and the Sustainable Development Goals. *Nat. Energy* **2018**, *3*, 10–15. [[CrossRef](#)]
12. Leal Filho, W.; Azeiteiro, U.; Alves, F.; Pace, P.; Mifsud, M.; Brandli, L.; Caeiro, S.S.; Disterheft, A. Reinvigorating the sustainable development research agenda: The role of the sustainable development goals (SDG). *Int. J. Sustain. Dev. World Ecol.* **2018**, *25*, 131–142. [[CrossRef](#)]
13. Kondyli, J. Measurement and evaluation of sustainable development. *Environ. Impact Assess. Rev.* **2010**, *30*, 347–356. [[CrossRef](#)]
14. Mori, K.; Christodoulou, A. Review of sustainability indices and indicators: Towards a new City Sustainability Index (CSI). *Environ. Impact Assess. Rev.* **2012**, *32*, 94–106. [[CrossRef](#)]
15. Ruiz-Guerra, I.; Molina-Moreno, V.; Cortés-García, F.J.; Núñez-Cacho, P. Prediction of the impact on air quality of the cities receiving cruise tourism: The case of the Port of Barcelona. *Heliyon* **2019**, *5*, e01280. [[CrossRef](#)]
16. Alfaro-Navarro, J.L.; López-Ruiz, V.R.; Peña, D.N. A New Sustainability City Index Based on Intellectual Capital Approach. *Sustainability* **2017**, *9*, 860. [[CrossRef](#)]
17. Zorn, A.; Esteves, M.; Baur, I.; Lips, M. Financial Ratios as Indicators of Economic Sustainability: A Quantitative Analysis for Swiss Dairy Farms. *Sustainability* **2018**, *10*, 2942. [[CrossRef](#)]
18. Molina-Sánchez, E.; Leyva-Díaz, J.; Cortés-García, F.; Molina-Moreno, V. Proposal of Sustainability Indicators for the Waste Management from the Paper Industry within the Circular Economy Model. *Water* **2018**, *10*, 1014. [[CrossRef](#)]
19. Martínez-Molina, A.; Tort-Ausina, I.; Cho, S.; Vivancos, J.L. Energy efficiency and thermal comfort in historic buildings: A review. *Renew. Sustain. Energy Rev.* **2016**, *61*, 70–85. [[CrossRef](#)]
20. Bobinaite, V. Financial sustainability of wind electricity sectors in the Baltic States. *Renew. Sustain. Energy Rev.* **2015**, *47*, 794–815. [[CrossRef](#)]
21. Sundkvist, A.; Jansson, A.; Larsson, P. Strengths and limitations of localizing food production as a sustainability-building strategy—An analysis of bread production on the island of Gotland, Sweden. *Ecol. Econ.* **2001**, *37*, 217–227. [[CrossRef](#)]
22. Hammer, M.; Jansson, A.; Jansson, B.O. Diversity change and sustainability: Implications for fisheries. *Ambio* **1993**, *22*, 97–105.
23. Svanbäck, A.; McCrackin, M.L.; Swaney, D.P.; Linefur, H.; Gustafsson, B.G.; Howarth, R.W.; Humborg, C. Reducing agricultural nutrient surpluses in a large catchment—Links to livestock density. *Sci. Total Environ.* **2019**, *648*, 1549–1559. [[CrossRef](#)] [[PubMed](#)]
24. Yatskiv, I.; Budilovich, E. A comprehensive analysis of the planned multimodal public transportation HUB. In *Transportation Research Procedia*; Elsevier: Amsterdam, The Netherlands, 2017; Volume 24.
25. Reidla, K.; Nurmet, M. Sustainability performance indicators in dairy farms of Baltic States. In *STRATEGIES FOR THE AGRI-FOOD SECTOR AND RURAL AREAS—DILEMMAS OF DEVELOPMENT*; Wigier, M., Kowalski, A., Eds.; INSTITUTE OF AGRICULTURAL AND FOOD ECONOMICS NATIONAL RESEARCH INSTITUTE: Warsaw, Poland, 2017; pp. 145–155.
26. Schröder, M.; Prause, G. Transportation of Dangerous Goods in Green Transport Corridors—Conclusions from Baltic Sea Region. *Transp. Telecommun.* **2016**, *17*, 322–334. [[CrossRef](#)]
27. Boonstra, W.J.; Björkvik, E.; Haider, L.J.; Masterson, V. Human responses to social-ecological traps. *Sustain. Sci.* **2016**, *11*, 877–889. [[CrossRef](#)]
28. Beifert, A. Role of Air Cargo and Road Feeder Services for Regional Airports—Case Studies from the Baltic Sea Region. *Transp. Telecommun.* **2016**, *17*, 87–99. [[CrossRef](#)]
29. Brankovic, N.; Salketic, S.; Ferizovic, A. Analysis of the possibilities of the construction of a railway line VARES-BANOVIĆI. In Proceedings of the Third International Conference on Traffic and Transport Engineering (ICTTE), Belgrade, Serbia, 24–25 November 2016; pp. 467–475.
30. Proskurina, S.; Heinimö, J.; Mikkilä, M.; Vakkilainen, E. The wood pellet business in Russia with the role of North-West Russian regions: Present trends and future challenges. *Renew. Sustain. Energy Rev.* **2015**, *51*, 730–740. [[CrossRef](#)]

31. Streimikiene, D. Monitoring of energy supply sustainability in the Baltic Sea region. *Energy Policy* **2007**, *35*, 1658–1674. [[CrossRef](#)]
32. Urboniėne, R.; Kelpšaitė, L.; Borisenko, I. Vegetation impact on the dune stability and formation on the Lithuanian coast of the Baltic sea. *J. Environ. Eng. Landsc. Manag.* **2015**, *23*, 230–239. [[CrossRef](#)]
33. Lotz, C. Expanding the space for future resource management: Explorations of the timber frontier in northern Europe and the rescaling of sustainability during the nineteenth century. *Environ. Hist.* **2015**, *21*, 257–279. [[CrossRef](#)]
34. Dekker, W.; Sjöberg, N.B. Assessment of the fishing impact on the silver eel stock in the Baltic using survival analysis. *Can. J. Fish. Aquat. Sci.* **2013**, *70*, 1673–1684. [[CrossRef](#)]
35. Lindholm, M.; Behrends, S. Challenges in urban freight transport planning—A review in the Baltic Sea Region. *J. Transp. Geogr.* **2012**, *22*, 129–136. [[CrossRef](#)]
36. Taagepera, R. Albert, Martin, and Peter too: Their roles in creating the Estonian and Latvian nations. *J. Balt. Stud.* **2011**, *42*, 125–141. [[CrossRef](#)]
37. Deutsch, L.; Folke, C. Ecosystem Subsidies to Swedish Food Consumption from 1962 to 1994. *Ecosystems* **2005**, *8*, 512–528. [[CrossRef](#)]
38. Valpasvuo-Jaatinen, P.; Rekolainen, S.; Latostenmaa, H. Finnish agriculture and its sustainability: Environmental impacts. *Ambio* **1997**, *26*, 448–455.
39. Libert, B. The transition of Baltic agriculture. *Ambio* **1997**, *26*, 473–475.
40. Altman, E.I. The success of business failure prediction models. *J. Bank. Financ.* **1984**, *8*, 171–198. [[CrossRef](#)]
41. Altman, E.I.; Iwanicz-Drozdowska, M.; Laitinen, E.K.; Suvas, A. Financial Distress Prediction in an International Context: A Review and Empirical Analysis of Altman's Z- Score Model. *J. Int. Financ. Manag. Account.* **2017**, *28*, 131–171. [[CrossRef](#)]
42. Holma, M.; Lindroos, M.; Romakkaniemi, A.; Oinonen, S. Comparing economic and biological management objectives in the commercial Baltic salmon fisheries. *Mar. Policy* **2019**, *100*, 207–214. [[CrossRef](#)]
43. Siksnelyte, I.; Zavadskas, E.K.; Bausys, R.; Streimikiene, D. Implementation of EU energy policy priorities in the Baltic Sea Region countries: Sustainability assessment based on neutrosophic MULTIMOORA method. *Energy Policy* **2019**, 90–102. [[CrossRef](#)]
44. Oleinikova, I.; Mutule, A.; Obushevs, A. Baltic transmission expansion planning considering wholesale electricity market. In Proceedings of the International Conference on the European Energy Market, Lisbon, Portugal, 19–22 May 2015. [[CrossRef](#)]
45. Holmgren, J.; Nikopoulou, Z.; Ramstedt, L.; Woxenius, J. Modelling modal choice effects of regulation on low-sulphur marine fuels in Northern Europe. *Transp. Res. Part D Transp. Environ.* **2014**, *28*, 62–73. [[CrossRef](#)]
46. Jokikokko, E.; Huhmarniemi, A. The large-scale stocking of young anadromous whitefish (*Coregonus lavaretus*) and corresponding catches of returning spawners in the River Tornionjoki, northern Baltic Sea. *Fish. Manag. Ecol.* **2014**, *21*, 250–258. [[CrossRef](#)]
47. Zhang, J.; Gilbert, D.; Gooday, A.J.; Levin, L.; Naqvi, S.W.A.; Middelburg, J.J.; Scranton, M.; Ekau, W.; Peña, A.; Dewitte, B.; et al. Natural and human-induced hypoxia and consequences for coastal areas: Synthesis and future development. *Biogeosciences* **2010**, *7*, 1443–1467. [[CrossRef](#)]
48. Larsson, M.; Granstedt, A. Sustainable governance of the agriculture and the Baltic Sea—Agricultural reforms, food production and curbed eutrophication. *Ecol. Econ.* **2010**, *69*, 1943–1951. [[CrossRef](#)]
49. Orru, M.; Orru, H. Sustainable use of Estonian peat reserves and environmental challenges. *Est. J. Earth Sci.* **2008**, *57*, 87–93. [[CrossRef](#)]
50. Hallemaa, H.; Vitsur, H.; Oja, T.; Mander, Ü. Sustainability of energy use in Estonian settlements and regions. *WIT Trans. Ecol. Environ.* **2006**, *93*, 509–519. [[CrossRef](#)]
51. Heikinheimo, O.; Setälä, J.; Saarni, K.; Raitaniemi, J. Impacts of mesh-size regulation of gillnets on the pikeperch fisheries in the Archipelago Sea, Finland. *Fish. Res.* **2006**, *77*, 192–199. [[CrossRef](#)]
52. Raukas, A.; Tavast, E. Sustainable management of mineral resources, soil cover and geosites in Estonia. *Pol. Geol. Inst. Spec. Pap.* **2004**, *13*, 191–197.



Article

# Influence of Interlocking Directorates on Integration after the Acquisition of Warsaw Stock Exchange—Listed Companies

Anna Stankiewicz-Mróz

Department of Management Systems and Innovation, Lodz University of Technology, Piotrkowska 266, 90-924 Łódź, Poland; anna.stankiewicz-mroz@p.lodz.pl

Received: 19 November 2019; Accepted: 3 December 2019; Published: 6 December 2019

**Abstract:** Acquisition processes are aimed at achieving value based on synergistic effects. One of the most important obstacles in achieving value is the manner of conducting post-transaction integration—a risk area often ignored. This study assumes that a factor that may be important for the course of integration after the acquisition of enterprises may be the fact of personal connections through interlocking directorates between transaction partners of acquisitions. The research was carried out in two stages. The first was to identify the scope of connections by interlocking between WSE-listed companies participating in acquisition transactions. This stage was implemented using the social network analysis method (SNA) and covered 188 companies. In the second stage, research was conducted using semi-structured interview techniques with the CEOs of the acquiring companies. The aim of the study was to identify the relationship between personal relations and the course of post-transaction integration. The analysis focused primarily on two factors: the dynamics of integration activities and their centralization. The research covered 38 companies that were included in the sample in the first stage of the research (including 19 personally related companies and, for comparison, in 19 unrelated companies). Studies have shown that the fact of connecting through interlocking affects the post-transaction integration model in the analyzed group. The dynamically centralized model dominates in enterprises related by particular persons. Many integration activities are carried out in the first 100 days. The factor affecting the implemented integration model is the durability of connections between participants before and after the transaction is conducted and the position in the network of connections determined by such sociometric measures as the centrality of proximity and own vector. Enterprises connected with long-term relationships usually demonstrate high dynamics of integration activities, which are conducted by joint teams whose group employees represent each of the merging enterprises. In addition, the CEOs surveyed from this group of companies declare having an integration plan with different levels of detail in each case.

**Keywords:** company acquisitions in Poland; personal relations; model of post-transaction integration

---

## 1. Introduction

The goal of the acquisition processes of enterprises is to achieve value thanks to synergy effects as its source. In economics, the concept of synergy appears in connection with the improvement of work and production processes [1] and it is assumed to be a consequence of combining resources. The need to search for synergistic effects implies recommendations for shaping the acquisition process in such a manner so that it entails increasing the value of the company. The analyses performed so far regarding the impact of mergers on the value of enterprises and that have participated in transactions indicate that the shareholders of target companies always benefit from acquisitions, while the profit of the shareholders of the acquiring companies is small or such companies even incur losses due to the aforementioned transactions [2,3]. The researchers, who, among other authors,

noticed the loss of value of the acquiring companies in the several years after the transaction were Mitchell and Stafford [4], Rosen [5], Czerwonka [6]. As a result of the acquisition, the acquiring enterprise obtains two value chains—its own and the one of the acquired company. Therefore, there is a need to decide on their modification or integration. Effective post-transaction integration is the most ignored risk area and, at the same time, one of the most important obstacles to the full value of the transaction. The most common causes of failure include a slow pace of integration [7], no integration plans or other integration problems [8]. Decisions regarding the course of integration activities are usually taken in the post-transaction stage. It is particularly important to determine which processes are the source of value and to what extent and dynamics they should be integrated. In this study, it is assumed that a factor that may be relevant to the acquisition process is possibly the fact of personal relationships through interlocking directorate between the companies involved in transactions. Continuous interaction and long-term relationships between management boards which require a strategic and tactical-operational approach contribute to achieving better financial and non-financial results for the company and affect their long-term value. This approach fits perfectly in the sustainable business model [9]. The concept of networking between enterprises through interlocking directorates is of interest to many modern researchers. It is an indicator of the functioning of enterprises in a network of social relations that enable related organizations to implement a certain shared strategic idea which increases their overall effectiveness. Networking mechanisms are explained as part of transaction cost theory [10] and also within resource theory [11] agency theory [12], stakeholder theory [13], network theory [14], as well as game theory [15]. This problem is also analyzed as part of embeddedness theory [16], in which it is emphasized that the behavior of economic entities always occurs in a specific social context. Quick access to relevant information on the strategy of other enterprises, planned investments or data illustrating the real economic situation is of particular value for companies who base their strategy on exogenous development implemented through acquisitions of other companies. The problem of connections through interlocking and its impact on the course of integration is rarely addressed both from the theoretical and cognitive viewpoint as well as from the empirical side or the field of its implications. In the studies of the problem of acquisition of enterprises, the emphasis is placed primarily on strategic or financial issues. There are no analyses of the relationships between enterprises participating in acquisitions at the time of concluding the transaction and the course of the post-transnational integration process. A failure to recognize the issue of the impact of personal relationships between the management boards of merging enterprises on the implemented post-transaction model of integration thus constitutes a visible research gap and has become the motivation for addressing this matter. This article attempts to fill this gap and its purpose is to present the results of the analysis of the relationship between the linking of enterprises participating in acquisitions through interlocking directorates and the post-transaction integration model. These studies are of an exploratory nature and concern companies operating in Poland, which is an additionally new research context. The vast majority of previous work on interlocking directorates in acquisition processes concerns companies operating in developed western markets. For the purpose of this study, a two-stage methodology was adopted. The first involved identifying relationships between enterprises listed on the Warsaw Stock Exchange (WSE). The study covered 188 listed companies that participated in acquisitions between 2012 and 2014 implemented on the Polish capital market. The research applied the social network analysis (SNA) method. In the second stage, the research was carried out using the semi-structured interviews with Polish CEOs from acquiring companies—the purpose of which was to identify the model of post-transaction integration which was used in both related and unrelated enterprises. The integration model was developed as a result of a desk-research type of examination. The model focuses on two selected parameters significant from the point of view of the integration process in the context of achieving the assumed transaction objectives i.e., the dynamics and centralization of integration activities. In the studies on the subject, these parameters are indicated as key success factors in acquisition transactions [17–19]. The research system designed in such a way is the first empirical and cognitive analysis of the acquisition processes



which take place between companies listed on the Polish capital market. In order to determine the course of post-transaction integration, an original model—used in the conducted empirical studies—was built. At the stage of research conceptualization, attention was also paid to determinants that may affect the implemented model. In the examined group of 188 listed companies, a transaction took place between enterprises connected through interlocking directorate (which accounts for 17%) in the case of 32 acquisitions. In the group of personally related enterprises, it was possible to conduct research in the second stage in 19 enterprises that participated in the acquisition transaction between the years 2012 and 2014. To compare the relationship between the connection and the integration process, a study was also conducted on a group of 19 companies included in the sample of WSE-listed companies participating in transactions not related through interlocking directorates. A time perspective of three years was adopted from the date of the acquisition transaction for the assessment of integration activities, hence the second stage of the study was conducted between 2015 and 2017. The research was carried out to find answers to the following questions: What is the scope of interlocking directorates in WSE-listed companies participating in acquisitions? How does the relationship through interlocking directorates between transaction partners affect the implemented model of post-acquisition integration? How does the stability of the relationship through interlocking directorates affect the implemented model of post-transaction integration? How does interlocking directorates affect the assessment of a completed transaction?

This article contributes to the literature on strategic management from a relational perspective by identifying the correlation between the personal relationships of management board members of companies involved in takeover transactions and the implemented post-transaction integration model. The course of post-transaction integration is a key factor in achieving synergy and creating value. It extends the current state of knowledge by describing the importance of interlocking in the processes of acquisition of enterprises. However, the scope of reasoning is limited due to the small research sample.

## **2. Literature Review**

### *2.1. Interlocking Directorates in Acquisition Processes*

Interlocking directorates is a situation where the same person or a group of persons appearing on the board of one company sits on the board of directors or the supervisory board of another company [20]. In recent years, interlocking directorates has become a widespread phenomenon across the world. Research shows that around 72.13% of companies listed on the Shanghai Stock Exchange and the Shenzhen Stock Exchange have at least one joint member of the board of directors [21]. In Poland, the scope of interconnection through interlocking is definitely smaller. Research conducted by Zdziarski [22] among companies listed on the Warsaw Stock Exchange showed that 42% of the surveyed population do not have a single relationship established by any member of their management board or supervisory board. One of the basic functions of interlocking is to reduce uncertainty and mitigate the risk of business activities thanks to accessing information by connecting with the boards of other companies [23,24]. Serving on the supervisory board or management board of another company is treated as a way of dealing with uncertainty in the environment [25], as an element of risk mitigation providing access to the relevant strategic information [26] but also facilitating obtaining the necessary funds [27]. Studies show that the relations with the management board affect the financial arrangements between the parties in the acquisition processes [28,29].

The subject of analysis under this article is inter-organizational interlocking, which primarily allows access and an exchange of information enabling each party to formulate and effectively apply an appropriate competition strategy [30]. Corporate social relationships (i.e., the relations of management board members presented by related managements) influence business decision making and the value of the company, including decisions on acquisitions. Interlocking directorates in acquisition processes is treated primarily as a risk-mitigating factor. This approach is in line with the views

developed within the theory of resource dependence, which assumes that management boards and supervisory boards control the external environment and perform a kind of scanning of the strategy of other companies by persons serving on the management boards or supervisory boards of other companies [31]. Cukurova [32] conducted a study among American listed companies and found that, compared to other companies, companies linked through interlocking with the acquiring company demonstrate a higher probability of being acquired. The study of the impact of the relational network on the acquisition decisions made was the subject of Wu's analysis [33], which proves the hypothesis that relation-based connections create communication channels and, as a consequence, enable the acquisition of a company on more favorable terms. Other studies show that they allow hostile takeovers to be made [34]. The companies that were located in the center of the inter-organizational network more often acted as the acquiring company [35]. Cai and Sevilir [16] note that purchasers operating in a network of connections incur significantly lower costs associated with investment consulting. In addition, they stated that relations with management play an important positive role in creating value for mergers and acquisitions.

## *2.2. Determinants of Post-Transaction Integration*

Schnlau and Singh [36] draw attention to the relationship between personal connections between transaction partners and the course and dynamics of the post-transaction integration process. The post-merger integration is a process that develops after closing a transaction to reconfigure merging companies by reimplementing, adding, or disposing of resources, product lines, or entire companies to achieve the expected benefits of merging [37]. Integration is one of the most risky and expensive stages of the entire acquisition transaction. Its course is a critical factor in the success of post-acquisition processes [38]. A common mistake at the stage of making a decision about entering into a transaction is valuing the acquired resources without taking into account the real costs of their integration. Pablo [39] asserts that integration is associated with the introduction of changes in all areas of functional activity, organizational structures, as well as systems and cultures of merging organizations in order to facilitate their consolidation into one functioning entity. It is a "continuous, interactive process in which people with the two merging organizations are learning to work together and cooperate in the transfer of strategic capabilities" [40]. It is assumed that the success of integration is determined by two key factors: the time in the field of speed of action to obtain benefits and the added value resulting from the acquisition and prudence that underlies taking rational, planned actions implemented without undue haste also taking into account the interests of the transaction partner [17]. For the purposes of this study, it was assumed—based on the research of Cording, Christman, King [18]—that the integration pace is defined as the time from closing the transaction to the completion of the integration process. The issues of integration dynamics have been the subject of studies of, among others, Chase [41]; Schlaepfer et al. [42]; Bauer, Degischer, and Matzler [43]. However, the research conducted so far has not brought a clear position on the optimal pace of integration. Angwin [44]; Homburg and Bucorius [45]; Cording, Christman, and King [18] point out that the impact of high dynamics of integration on the success of the transaction is positive. Bijlsm-Frankema [8] and Olie [46] studies demonstrated the negative influence and studies by Bauer and Matzler [47] indicate that this parameter has no significant impact. The optimal pace of integration depends on the similarity of internal and external conditions in which the companies participating in the transactions operate. If companies were characterized by a significant level of similarity in the area of such internal factors (e.g., management style, strategic orientation, performance) but the similarity of external connections was low (e.g., sales markets and serviced customers), then the high pace had a positive impact on the success of integration. If the similarity in the area of internal factors was low, then the high pace of integration had negative effects [48]. The pace should be primarily determined by the nature of the transaction. If the essence of the discussed process is the transfer of material resources, then quick action is beneficial. If the transfer is to be carried out at the level of people's know-how, then it is slow integration that gives time for learning. The acquiring company's experience in conducting acquisition processes, the good or bad condition of the acquired

company, as well as the financial and human resources at the disposal of the transaction partners are also important. A significant factor influencing the course of integration is the level of centralization of the discussed process. The key task from the point of view of effective integration is the appointment of an integration manager for a limited period of time. Typically, such a manager sets up a team that should consist of representatives of both combined units and has project management experience [49] in the field of acquisition and operational skills. In a situation where such employees cannot be found in the organization, it should be decided to employ external specialists. The establishment of one joint integration team results in the centralization of the integration process. The integration team should not be too large as it hinders, among others, effective work during meetings and slows down the decision-making process. On the other hand, however, its composition should be constant. Team members should have knowledge regarding the motives of the transaction and their relationship with the company’s strategy, key success factors and potential threats, their place in the team, and importance in the process of achieving goals, the role of other team members and possible bonuses for completed tasks [48]. In the present study, many factors that may have an impact on the course of post-acquisition integration have highlighted two parameters that constitute the author’s model: i.e., the dynamics of integration activities and their level of centralization. Taking into account the fact that the dynamics of operations can be high, moderate, or low and the level of centralization may be high or low, six different models can be distinguished. They are presented in Figure 1.

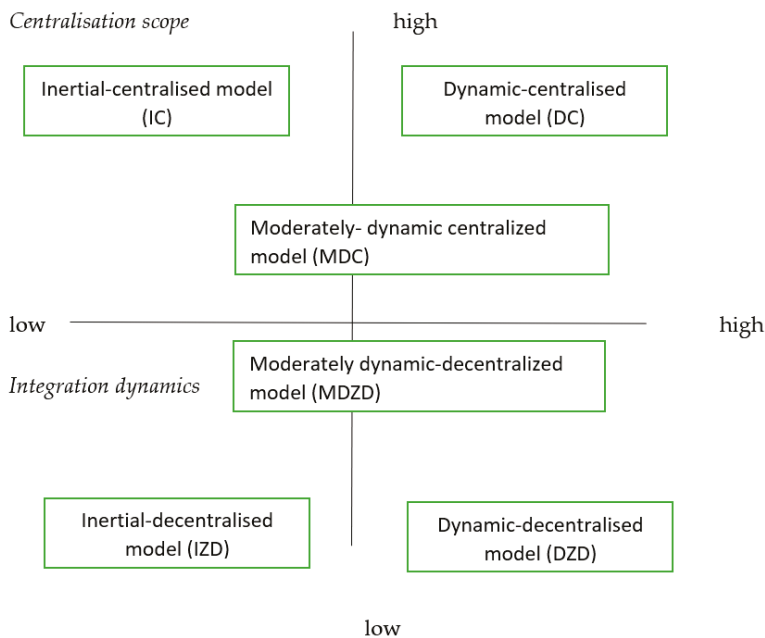

Figure 1. Post-trade integration models verified in the surveyed enterprises.

The inertial-centralized (IC) model assumes the conduct of integration activities stretched in the long term. After three years of functioning in the post-merger structure, the scope of integration is small. For the purpose of conducting slow integration activities, a common team consisting of employees joining the organization is established. In the inertial-decentralized (IZD) model, integration activities are implemented with low dynamics in each of the merged enterprises separately. At the other extreme are dynamic models. These assume a high scope of integration activities, which had already been introduced in the first 100 days and subsequently throughout the year. These activities

can be described in the form of a centralized dynamic model (DC) which describes the high pace of integration activities implemented by one joint team grouping representatives of each of the transaction partners or a decentralized one (DZD) which assumes great freedom for integration activities conducted separately within each of the entities of the acquisition. The dynamics of integration activities can also be moderate but are conducted by the integration team (DDC model) or separately in each of the enterprises participating in the transaction (MDZD model). In models assuming moderate dynamics of activities, integration activities are usually spread over a period of three years.

### 3. Methodology

#### 3.1. Sample

In the first stage, the subject of examination was the relationship through director interlocking between companies listed on the stock exchange that took part in the acquisitions carried out between 2012 and 2014. The research was conducted using the Euromoney Institutional Investor Company (EMIS) DealWatch database, out of which transactions that meet the adopted criteria were selected. Data on members of management boards and supervisory boards was obtained from the INOFERITI database. The research was conducted using the method of SNA (social network analysis) and covered 188 companies. The examined group included 43 companies participating in the acquisition transaction in 2012, 84 companies that participated in acquisitions in 2013, and 61 companies in 2014. Enterprises surveyed in the first stage were contacted during the second stage—implemented three years after the transaction was carried out—based on the adopted methodology adopted. It was assumed that such a time perspective is necessary to evaluate the integration process. The research was, therefore, retrospective. The discussed stage of the study was conducted between 2015 and 2017. It was assumed that in the study group all enterprises associated personally through interlocking and, for comparison in the same number, unrelated enterprises will be included. The difficulties that arose during the implementation of the second stage research meant that the final analysis of stock exchange transactions made for the purposes of this study concerns 38 acquisitions. In this group, half (i.e., 19 companies) were related through interlocking directorates. Initially, it was assumed that the research would be treated as a whole and would cover all companies analyzed in the first stage of the research. However, as attempts to contact potential respondents were usually unsuccessful, it was decided to verify this assumption. Ultimately, the selection for the sample was purposeful, taking into account the criterion of availability of respondents. The research was carried out using a semi-structured interview technique. The adopted methodology, therefore, assumed triangulation of methods (the multiple, heterogeneous approach including the SNA quantitative method as well as the qualitative method). The characteristics of the surveyed enterprises are presented in Table 1.

**Table 1.** Characteristics of enterprises of participants of the acquisition transaction examined in the second stage.

Characteristics of the Examined Transaction	Enterprises Related through Interlocking (N = 19)	Unrelated Enterprises (N = 19)
Company ownership form:		
• national private enterprise	10	12
• international company	2	-
• state-owned company	7	7
Total	19	19
Organizational form:		
• single-site company	3	6
• multi-site company	7	9
• capital group	9	4

Table 1. Cont.

Characteristics of the Examined Transaction	Enterprises Related through Interlocking (N = 19)	Unrelated Enterprises (N = 19)
Total	19	19
Employment volume before acquisition:		
• 50–249 employees	8	9
• 250–500 employees	9	8
• over 500 employees	2	2
Total	19	19
Business profile:		
Industrial processing	17	17
Construction industry	2	2
Total	19	19

According to the Polish Classification of Activities (PKD), the surveyed enterprises belonged to two branches: industrial manufacturing (35) and construction (4). All transactions analyzed were industry-related and were an example of horizontal concentration.

To identify the organizational model of post-acquisition integration, semi-structured interviews with the CEOs of the acquiring companies were carried out (presidents, vice presidents, general directors, managing directors). The job profile of the respondents is presented in Table 2.

Table 2. Job profile of respondents.

Job Categories	Number of Respondents	
	Related Enterprises	Unrelated Enterprises
President/Vice-President of the Board	3	2
Managing Director	10	9
General Director—CEO	6	8
Total	19	19

The surveyed group of respondents representing personally related enterprises included two presidents and one vice president of the management board, ten managing directors and six general directors. The sample of unrelated enterprises examined included one president and one vice president of the management board, nine managing directors, and eight general directors.

### 3.2. Method of Research

The process of researching acquisitions was complex and prolonged. It was conducted in two stages using the triangulation of research methods. In the first stage of the research, the method applied was SNA (Social Network Analysis). SNA is a set of research methods belonging to the category of quantitative methods, which—in a uniform and comprehensive manner—deals with many issues of varying degrees of complexity in the network [49]. SNA is distinguished from conventional social research tools by the fact that the focus of this method is the so-called relational data, not attributes [50]. This tool allows both internal and external inter-organizational relationships to be analyzed, including capital connections or personal connections of enterprises through interlocking directorate. The method also allows knowledge that facilitates the identification of organizations that create the greatest value to be obtained as well as comparing the potential of this type of relationships between major competitors [51]. As a result, an easier task is to identify companies—potential acquisition targets and partners to form business associations. SNA allows inter-organizational relationships as well as personal relationships between companies that are created to be measured, for example by managerial interlocking, i.e., sitting on the management boards or supervisory boards of other companies. Research on the impact of the relational network on the acquisition decisions made was the

subject of Yang's analysis [32]. Studies show that relational connections create a communication channel and, as a consequence, enable a company to be taken over on more favorable terms or enable hostile takeovers [35]. Knowledge brought about by the use of SNA also brings the answer to the question, 'at which level of the organizational structure should post-transactional integration be conducted?', and allows the types of networks that are the easiest to undergo the integration process to be determined. It also allows key people for work coordination and the flow of information and knowledge as well as the opportunity to properly use their potential when merging organizations after the transaction to be identified. This is important, among others, from the point of view of identifying people who could be entrusted with the role of integration manager. As a result of the SNA study, it is possible to identify relationships that increase work efficiency—the activation of which may support both the transition process and permanently increase the company's resources after the merger. The second stage of the study was carried out based on the qualitative method. The second stage of the research was carried out based on the qualitative method using semi-structured interviews. The implementation of this stage was preceded by the assumption that a specific time perspective is necessary for the assessment of the integration process. As a result of the literature research, it was concluded that the optimal time horizon was 36 months after the transaction was closed. Although quantitative analyses predominate among methods of testing acquisition processes in various areas, there is a clearly outlined group of supporters of qualitative analyses among researchers. Miles and Huberman [52] ought to be mentioned here as an example of researchers who suggested that, in the case of examination of acquisitions, there is a need for deep understanding and contextualization; therefore, qualitative research methods are optimal. A similar position is represented by Larson and Lubatkin [53], who stress that qualitative research is especially dedicated to testing acquisitions and integration due to the need for detailed descriptions of sensitive contextual data. In the second stage of the study, a semi-structured interview technique was applied, which was conducted with managerial staff from the CEO level. This form of interview makes it possible to understand the complex combination of the factors that accompany integration processes and to capture their multidimensionality. The analyzed post-trade integration processes are approached in retrospective categories which are primarily based on the questions of "how" and "why" [54]. The choice of such a research technique resulted from the exploratory character of the examination—the subject of which is a problem that has not been clearly defined so far. The advantage of semi-structured interviews is the possibility of using open-ended questions to obtain more information and a deeper 'insight' into the problem. Providing respondents with the possibility of free answers allows the views of respondents to be identified without forcing them into the researcher's train of thought. The disadvantage of semi-structured interviews is primarily the subjectivity of respondents in the perception of the described phenomenon [54]. This technique provided information on the course of post-transactional integration, its scope, dynamics, and the level of centralization of activities. The collection of this information was based on open-ended questions. The interview also included closed questions, presented in the form of a five-point Likert scale. This concerned the personal assessment, by the staff of the CEO of acquiring companies, of the effectiveness of integration activities and the importance of selected factors affecting the course of integration such as the integration plan, dynamics of activities and the level of centralization for achieving the original goals determined by the acquisition transaction. Collecting the opinions of staff from the CEO level is one way to evaluate the effectiveness of acquisitions in merger and acquisition processes [19]. Interviews were conducted in the offices of companies and were preceded by a letter of invitation to the study. Additionally, contact by phone was made to determine the details of the meeting. Due to the very low interest from potential respondents, personal contacts were also used to reach respondents. The choice of a semi-structured interview as a research technique was conditioned by the advantage of this form of interview, i.e., the ability to deepen one's knowledge about the issue studied. It gives the researcher quite a lot of freedom in distributing accents during the interview. The respondents had a deep knowledge of the subject of the study. Interviews were conducted with 38 top-level managers. In this group, 22 people represented enterprises with Polish private capital,

14 respondents the State Treasury Company. Only two CEOs represented international corporations. Given that the research sample was small, the key issue remains the number of interviews enabling knowledge saturation and meeting the requirement of methodological rigor. The source literature on the subject lacks clarity regarding the number of interviews that must be carried out to meet these requirements. Some authors indicate 15 respondents [54], while others mention the number of 12 interviews with a homogeneous group in order to achieve knowledge saturation [55]. It should be emphasized that the examination of processes that are carried out in the post-transaction phase is complicated in the field of methodology. It is difficult to separate actions and their effects, being only the effect of post-transaction integration, and to separate them from actions resulting from other conditions. Acquisition processes are extremely complex and multi-layered and are, therefore, accompanied by methodological dilemmas.

#### **4. Methods of Data Analysis**

Quantitative and qualitative research was used to meet the assumed goal. Quantitative research based on SNA allowed the scope of connections through interlocking directorates, relationship durability and network position—determined by such sociometric measures as a measure of closeness centrality and a measure of eigenvector centrality—to be determined. The first measure indicates the position of the node in the network and indicates the possibility of information inflow transmitted on short paths, which is important from the point of view of information transfer time. The second of the analyzed sociometric measures determines the ability to transmit information by connecting to nodes with a large number of relationships. In business networks, an enterprise with a high intrinsic value of eigenvector has relationships with nodes (other entities) that perform an important function in the network (e.g., have key resources, are a source of innovation, or have a large market share). The analyzed measures in each case account to values in the range  $<0-1>$ . In the case of the measure of centrality of closeness of relations, values close to zero mean a low position of the closeness of the node in the network. The value '1' means that a given node is in the closest distance from all nodes in the network. In the first stage, the respondents were looking for answers to:

- Research Question 1: What is the scope of interlocking directorates in the acquisition processes of companies listed on the stock exchange? In the second stage of the study, the model of own authorship was built, dedicated to identifying the process of post-transaction integration in the time perspective of three years after the acquisition was conducted.

The following further research questions were the focus of this stage of the study:

- Research Question 2: How does the relationship through interlocking directorates between transaction partners affect the implemented model of post-acquisition integration?
- Research Question 3: How does the stability of the relationship through interlocking directorates affect the implemented model of post-transaction integration?
- Research Question 4: How does interlocking directorates affect the assessment of a completed transaction?

#### **5. Analysis of the Approach to Post-Transaction Integration and Its Determinants**

##### *5.1. Scope of Relationships through Interlocking Directorates*

In the audited period from 2012–2014, 188 acquisitions of companies listed on the Warsaw Stock Exchange took place. In this group, 37 enterprises were related through interlocking directorates. The level of cross-linking was 19.7%. The essential sociometric measures subjected to analysis were closeness centrality of relations and eigenvector centrality. The measure of closeness centrality of relations reached an average value of 0.42 (the minimum value was 0.02 while the maximum value was 0.66). This means a moderate position of the node's closeness in the network. A detailed analysis of the

paths between pairs of enterprises in the network demonstrated a moderate level of centrality, which may mean access to information sent by other nodes in the network to a moderate extent. The second of the measures analyzed also achieved a low average value of 0.36 (minimum value 0.08, maximum 0.54), which indicates a moderate level of connections between the surveyed enterprises with companies holding central positions in the network. This situation can potentially result in moderate access to information resources on the network. They are presented in Table 3.

**Table 3.** Selected sociometric measures describing the network of relationships between companies participating in acquisitions on the WSE in 2012–2014.

Selected Sociometric Measures Describing the Network	Average Value	Minimum	Maximum
Closeness centrality	0.42	0.02	0.66
Eigenvector centrality	0.36	0.08	0.54

Source: own research.

In a group of 19 companies connected through interlocking directorates, the second stage of the survey was carried out (and, for the purpose of comparison, also in 19 unrelated companies). In the research, it was important to identify the areas in which integration activities were carried out. Studies have shown that after 36 months from the date of the transaction, full integration usually only took place in the so-called ‘hard’ areas such as IT systems, budgeting, marketing, and sales. Integration was less common in the introduction of new products. In 12 cases, it was noted that before the formal conclusion of the transaction in the company being acquired, adjustment activities were carried out. This allowed significant acceleration of the integration after acquisitions in the area of budgeting and IT systems. They are presented in Figure 2.

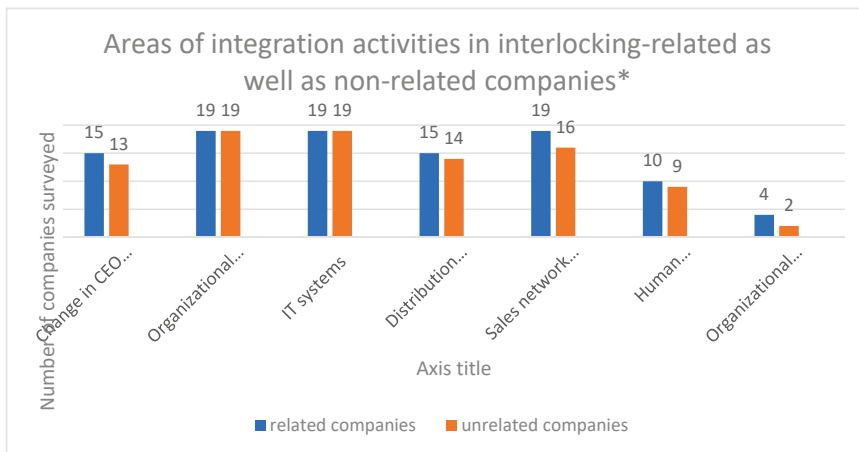

**Figure 2.** Areas subjected to post-acquisition integration in related and unrelated companies. They are presented in Figure 2. \* = the results do not add up because the respondents had the opportunity to indicate several variants of the answer.

Conducting an overall assessment of the scope of integration after three years of functioning in the structure—after mergers—in companies related through interlocking directorates. In 10 cases, it was described as high, in 6 as moderate, and in 3 transactions indicated as low. In the case of unrelated enterprises, in the CEO’s assessment, a high scope was indicated in seven cases, moderate in eight, while a low scope of integration activities was indicated in four cases. Detailed lists of the assessment of the scope of integration activities in individual areas are presented in the Table 4.



**Table 4.** Declared scope of integration in selected functional areas three years after the acquisition in enterprises in interlocking related and unrelated enterprises.

The Area in Which Integration Activities Were Carried Out	Declared Scope of Integration					
	Related Enterprises (N = 19)			Unrelated enterprises (N = 19)		
	Low	Moderate	High	Low	Moderate	High
Marketing and sales	-	7	12	-	8	11
IT systems	-	-	19	-	-	19
Accounting procedures	-	1	18	-	1	18
Suppliers and distribution channels	6	5	8	5	6	8
Human resources management	4	10	5	10	6	3
Brands	3	8	8	3	10	6
Technologies	6	5	8	6	7	6
Organisational culture	12	5	2	17	2	-

Studies have shown that the highest scope of integration occurred in the case of IT systems and accounting procedures. They are intended to secure core operations. In the 28 transactions analyzed, they were carried out within the first 100 days after the merger. A very important area—from the point of view of integration priorities—in almost every transaction examined is marketing and sales. This is justified by the respondents' assumed integration motives. In acquisition transactions, it is important to conduct changes in this area at an early stage of the integration project to reduce the period of uncertainty for both external and internal clients. However, it should be emphasized that the sales area contains elements that may be beyond the purchaser's control. This may include issues such as customer loyalty, market dynamics, and competitive responses [56]. It is important to analyze integration priorities in the area of marketing and sales in connection with the motives of an acquisition transaction. In 12 cases, the acquisition caused a problem of partial or total overlap of the product portfolio of the acquiring and acquired company. As a result, in each case a marketing plan, which assumed the integration of the portfolio of transaction partners' offers, was prepared. In seven cases, the prepared marketing strategy assumed the creation of a completely new portfolio of offers. This was in line with the transaction motive, i.e., expansion into new markets and reaching a new group of customers. The integration in the area of marketing and sales in many companies results in the necessity of adopting a multi-brand strategy and enforces competence in managing the portfolio of offers of combined organizations. In 14 cases, no changes were planned to the product on offer. It should be emphasized that the decision on the brand strategy after the acquisition is conditioned by the company adopting the market strategy. When a market gap is identified and it is possible to fill it in, a new brand is often created together. However, in the case of developed markets, for a new company created after the merger, the existing brands that have their established position are usually left. The strategy of integrating the portfolio of offers after the merger should be prepared in the pre-transaction phase—especially if the acquiring company assumes expansion into new markets and reaching a new group of customers. In the analyzed transactions, full integration of brands took place in 14 cases (in 8 interlock-related and 6 unrelated companies). Integration in this area was associated with such transaction motives as the increase in goodwill after the merger (nine indications including five in related companies and three in unrelated companies), increasing the entry barrier (eight indications including four in related companies and four in unrelated companies) or increasing market share (10 responses, 6 in related companies and 4 in unrelated companies). The largest differences in integration between related and unrelated companies concerned 'soft' areas such as organizational culture and human resources management. In each case, in the study conducted among the CEOs it was emphasized that cultural integration is a very complex problem—an emotional one which raises the question of whether it should actually be conducted. G. Schweiger and J. Walsh [57] note that from the point of view of acquisition efficiency, the decisive problem describing integration issues in the cultural area is not how diverse the cultures of the merged enterprises are, but whether maintaining these differences in the long run will prove beneficial. The problem of cultural integration is particularly

complex, among others, due to the fact that there may be several subcultures within one enterprise. This way of thinking about the multilevel of organizational subcultures is also found in the sociological concept of Cuche [58]. In the research on acquisitions in the area of cultural considerations, the paradigm based on the traditional approach assuming the 'uniformity' and 'monolithism' of corporate culture dominates, apart from the fact that organizations may consist of fragmented cultures [59]. In the cultural aspect, it is assumed that "the greater the cultural discrepancy between the organizations involved, the worse the performance of the terms of the contract" [60]. Meanwhile, in the literature on the subject, there is no clarity regarding the impact of cultural differences between transaction partners on acquisition efficiency. Whilst Datta [61], Chatterjee et al. [62], and Weber and Camerer [63] build the conclusion that this influence is negative, Krishnan et al. [64] demonstrated a positive relationship between the differences and the financial result of the acquisition. In the absence of a clear conclusion, it seems that the issue of 'depth of integration' must be treated with extreme caution. At this point one should stop at the methodology of conducting research on the relationship between the depth of integration in the cultural dimension and the effectiveness of this process. Usually, the subject of analyses is the inter-cultural differences between management teams. This shows the difficulties in capturing cultural differences in the acquisition processes. In this regard, Teerikangas and Vera [65] pose the question: "In the final analysis, the question arises - whether the research really touched upon the essence of organizational culture; what are the researchers actually measuring? How is organizational culture conceptualized: as differences in the management team's culture?" Riad [66] criticizes existing research on culture in takeover processes and emphasizes the need to force what he describes as a "binary opposition" between the coherence of culture on the one hand and the pluralism of cultures on the other. Riad warns against tradition in the literature on acquisitions to categorize cultures into certain types or to focus on 'differences' between cultures. He asks whether cultures and their potential differences cannot simply be taken into account as such in times of mergers and acquisitions as they are in multicultural societies.

### *5.2. The Model of Post-Transaction Integration and Its Determinants*

Identifying the dynamics of integration was a key issue from the point of view of the research goal. In the literature on the subject, there is no unequivocal view on the most favorable dynamics of the integration process. It is usually emphasized that pace is important from the point of view of behavioral psychology because rapid integration reduces uncertainty among employees. Quick integration also allows the initial enthusiasm associated with mergers to be used, which is usually short-lived. The high dynamics of integration is also important for the marketing and sales area because it helps reduce customer uncertainty. The advantage of slow integration is, above all, minimizing conflicts between partners and building trust between transaction partners. Low integration dynamics also allow potential disruptions in the processes carried out with each of the transaction partners to be limited. An overall assessment of the dynamics of integration indicated in 13 cases that it was high and in 13 cases that it was moderately dynamic. In 12 transactions, the integration dynamics after acquisition was assessed as low. Studies have shown that dynamics is conditioned by the fact of personal connections between transaction partners. In the case of enterprises related through interlocking directorates, in 9 cases out of 19, respondents declared high dynamics of integration activities (in the group of unrelated enterprises high integration dynamics was declared in four cases). The second parameter describing the research model was the centralization of integration activities. They are presented in Figure 3.

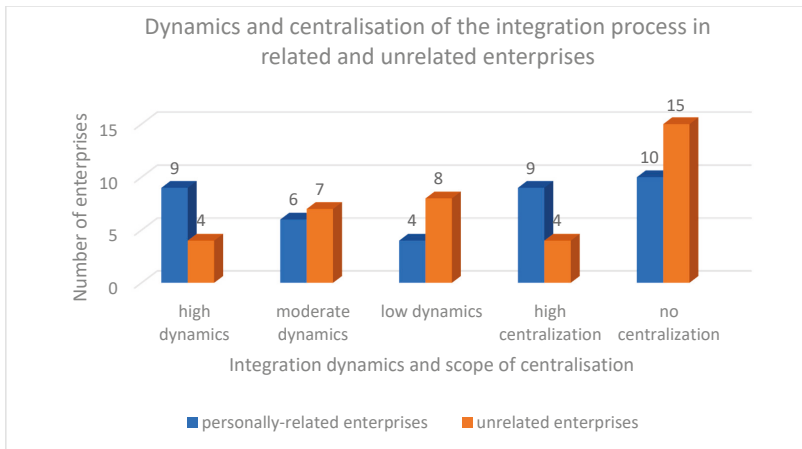

**Figure 3.** Dynamics and scope of centralization of the post-acquisition integration process in enterprises related through interlocking directorates and in unrelated enterprises.

Analysis of the two parameters constituting the adopted working model of post-transaction integration, i.e., the dynamics and centralization of integration activities showed that the surveyed companies carried out integration activities in line with the following models:

- Dynamic-centralized (DC) is the dominant model in persons linked by direct interlocking (nine cases analyzed). In unrelated enterprises, the model stated occurred in four cases.
- Moderately dynamic-decentralized (MDDZ) occurred in six examined interlocking-related companies and seven unrelated companies.
- Inertial-decentralized (IDZ) describes integration activities implemented in four companies related through interlocking and in eight unrelated companies.

Research has shown that the dominant model of post-transaction integration in related enterprises is the dynamic-centralized (DC) model. It occurred in nine transactions. For comparison, the discussed model occurred in the case of four transactions in the surveyed unrelated enterprises. Integration activities were entrusted to an operational team, grouping representatives of each of the combined organizations. The study additionally showed that in 13 transactions out of 38 respondents, integration activities were decentralized and were carried out separately.

The research pointed to several factors that may affect the implemented integration model. They are presented in the Figure 4.

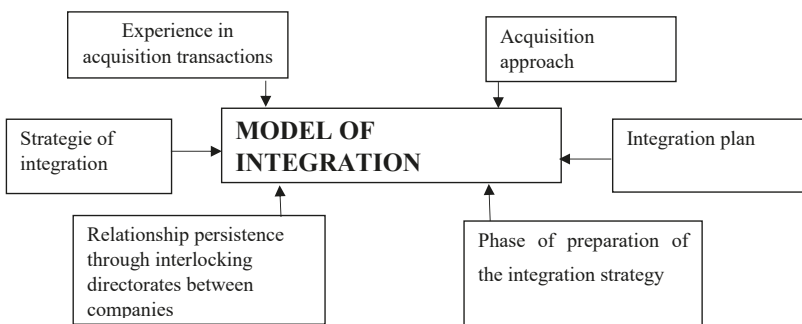

**Figure 4.** Determinants of the post-transaction integration model included in the study.

An important factor, from the point of view of the course of integration, is the stability of the relationship between transaction participants. Stahl, Kremershof and Larsson [67] note that inter-organizational relationships between partners build trust before concluding transactions and this element is treated as a critical success factor in post-acquisition integration processes. The analysis shows how long before and after the transaction the relationship between companies takes place through interlocking directorates. For the purposes of these studies, it was assumed that the short-term relationship lasts less than one year. Relationships over one year are long-term relationships. To determine the length of the relationship, both the duration of the relationship before and after the transaction was analyzed in the case of the tested connections, the average length of the relationship was 496 days. They are presented in Figure 5.

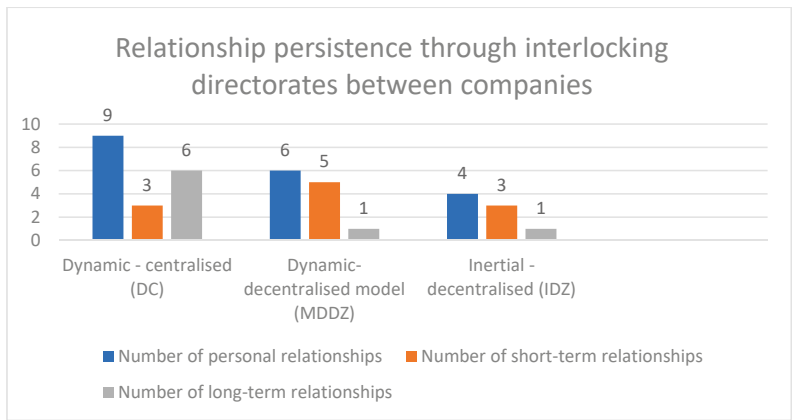

**Figure 5.** Relationship persistence through interlocking directorates between companies, acquisition partners and the implemented model of post-transaction integration.

The research demonstrated that enterprises connected with long-term relationships usually demonstrate high dynamics of integration activities which are conducted by teams grouping employees representing each of the merging enterprises. In addition, the CEOs surveyed from this group of companies declare having an integration plan with different levels of detail in each case. An important parameter analyzed was also the period of occurrence of relationships. The study sought the answer to the question: how long before the conclusion of the acquisition transaction and after its completion did personal connections occur through interlocking directorates? In the analyzed transactions, if the durability of connections after the merger was low, then the decentralization of the integration process took place more often. They are presented in Figure 6.

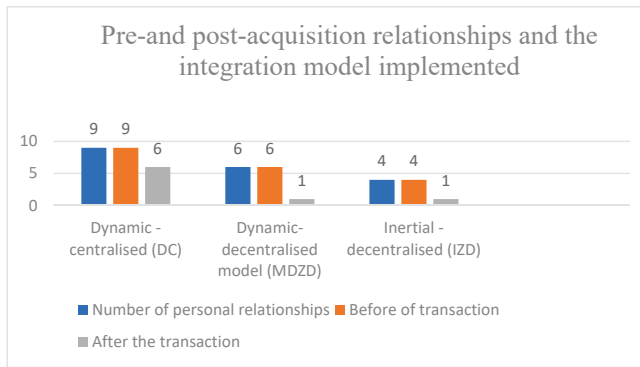

Figure 6. Pre-and post-acquisition relationships and the integration model implemented.

From the point of view of the efficiency of the post-acquisition stage, previous experience in conducting acquisition transactions may be relevant. Despite a significant number of studies on this subject, there is no clear evidence of a link between experience in acquisition and achievement of effects [68]. Studies have shown that this is an insignificant factor [69] with a negative impact [70] or a positive impact [71]. In the presented research, the experience in the area of acquisitions was declared in the case of 15 companies whose representatives emphasized that the acquisitions were part of the adopted and implemented development strategy of the enterprise. At the same time, 18 CEO respondents declared personal experience in acquisition transactions. Each of the respondents who declared previous experience in takeover processes emphasized that this is a factor that translates positively into the efficiency of the post-transaction integration process and the effectiveness of the takeover process. The summary of declared enterprise experience and the level of centralization and dynamics of integration activities are presented in Table 5.

Table 5. Experience in acquisitions and implemented integration model in personally related and unrelated enterprises.

Experience in Acquisition Transactions	Model of Post-Transaction Integration		
	Personally Related Enterprises		
	DC (N = 9)	MDDZ (N = 6)	IDZ (N = 4)
Yes (N = 11)	7	3	1
No (N = 8)	2	3	3
Enterprises not related personally			
	DC (N = 4)	MDDZ (N = 7)	IDZ (N = 8)
Yes (N = 4)	2	1	1
No (N = 15)	2	6	7

The marginalization of post-transaction integration issues is visible at the stage of preparing the plan on the basis of which integration will be carried out. In the examined group, the integration plan was prepared in one-third of transactions. Typically, the plan was prepared after the transaction (10 cases) and was characterized by a high level of generality (7 cases). The preparation of a detailed plan was declared in only one case and in four cases a detailed plan was prepared for selected functional areas that were directly related to the motives of conducting a takeover transaction. The identified trend is very worrying. It seems that integration planning already at the stage of due diligence is associated with a reduction in business risk that accompanies these transactions. The relationship between the integration process and having a plan is presented in Table 6.

**Table 6.** The integration plan and its characteristics and the model of post-transaction integration.

Integration Plan and Its Characteristics	Integration Model in Related Enterprises			Integration Model in Unrelated Enterprises		
	DC [9]	MDDZ [6]	IDZ [4]	DC [4]	MDDZ [7]	IDZ [8]
Possession of an integration plan (N = 12)	5	1	-	4	2	-
Prepared before transaction (N = 2)	2	-	-	-	-	-
Prepared after transaction (N = 10)	3	1	-	4	2	-
No integration plan (N = 26)	4	5	4	-	5	8
Plan characteristics						
General plan (N = 7)	2	1	-	2	1	-
Detailed plan (N = 1)	1	-	-	-	-	-
Plan only for selected functional areas (N = 4)	2	-	-	2	1	-

Studies have shown that having an integration plan translates into higher dynamics and centralization of integration activities. The relationship between the implemented integration model and the circumstances in which the transaction was concluded remains interesting. The question was asked whether the acquisition was a tool for implementing the company's development strategy or for seizing the opportunity. In 26 cases, it was declared that the transaction was included in the strategy. In five cases, that the opportunity was used, while in seven it was confirmed that the acquisition was included in the company's growth strategy but the opportunity was taken and carried out at the right time. The relationship between the integration model used in related and unrelated companies and the circumstances of the transaction are presented in Table 7.

**Table 7.** Model of post-transaction integration and circumstances of concluding acquisition transactions.

Implemented Integration Model	Circumstances of Concluding the Acquisition Transaction					
	Related Enterprises (N = 19)			Unrelated Enterprises (N = 19)		
	Strategy	Opportunity	Included in Strategy but Using the Opportunity	Strategy	Opportunity	Included in Strategy but Using the Opportunity
DC (N = 13)	6	-	3	3	-	1
MDDZ (N = 13)	6	-	1	6	-	-
IDZ (N = 12)	2	4	2	3	1	-
Total	14	4	6	12	1	1

Including the acquisition into the company's development strategy translates into the dynamics of the discussed process in the case of the examined transactions. In the static model, acquisition was often the result of using an emerging opportunity or included in the strategy, but using the opportunity. An opportunity-based approach that results in high-level dynamics on the level of due diligence and in the transaction phase raises the risk of a lack of preparation of internal processes that justifies, to some extent, the low dynamics of integration activities. Another element analyzed was the relationship between the fact of having an integration strategy and the moment when it was created and the implemented integration model. The obtained results are presented in Table 8.

Possession of an integration strategy in the form of a document was declared in eight surveyed enterprises. They contained sub-strategies for selected functional areas in which the potential to achieve synergies was recognized. In 18 cases, attention was drawn to the fact that the strategy was functioning but was not prepared in the form of a document. It was emphasized that during the three years analyzed since the transaction, the integration strategy was subject to many modifications. For the remaining 12 transactions, no integration strategy was prepared and if there was a need for integration activities, they were implemented on an ongoing basis. In the case of implementing integration based on the DC model (dynamic-centralized), the strategy—in the form of a framework document—was prepared during the pre-transactional stage.

**Table 8.** Integration model applied and the phase of preparation of the integration strategy.

Possession of an Integration Strategy	Implemented Post-Transaction Integration Model		
	DC (N = 13)	UDZD (N = 13)	Iزد (N = 12)
Yes, in the form of a document (N = 8)	3	4	1
Yes, but not in the form of a document (18)	10	4	4
No (N = 12)	-	5	7
The stage of the acquisition process at which the integration strategy was created			
Pre-transaction phase (N = 1)	1	-	-
Transaction phase (N = 0)	-	-	-
Post-transaction phase (N = 25)	12	8	5

The last area subjected to analysis was the assessment of the effectiveness of the integration process and giving importance to individual elements describing its course by respondents. As observed by Zollo and Meier [72], about 14% of all articles devoted to the effectiveness of mergers and acquisitions were based on the subjective assessment of the managerial staff. There is also literature confirming the positive correlation of research results based on interviews with research results based on objective market and accounting data [73]. The use of CEO staff's opinions for the purposes of assessing effectiveness is justified by the problem of obtaining objective, reliable, and current measures of selected aspects of the acquisition processes [19]. During the interview, participants were asked to assess the significance of selected elements describing the process of post-transaction integration, which in the literature are treated as key success factors. The assessment concerned parameters such as integration dynamics, its scope, level of centralization, integration plan, and the experience of companies in conducting transactions. The questions also concerned assessing the importance of interlocking for post-transaction integration. An overall assessment of satisfaction with the completed post-transaction integration model was attempted to be identified by asking the question, 'how do you assess the level of achievement of the goals set for the analyzed transaction in a perspective of three years from the date of the transaction?'. For 12 evaluated transactions, it was declared that the goals were achieved, in 19 transactions not all of the assumed goals were achieved but the most important goals were achieved. In seven cases, no answer was given. It can therefore be assumed that in 12 transactions the assumed goals were achieved and this translated into a high level of satisfaction with the acquisition transactions. The level of satisfaction with the acquisition transaction carried out in personally related and unrelated companies is presented in Table 9.

**Table 9.** Declared level of satisfaction with the implemented model of post-transaction integration in enterprises related through interlocking directorates and in unrelated enterprises.

Implemented Post-Transaction Integration Model	Level of Satisfaction with the Transaction					
	Enterprises Related through Interlocking			Unrelated Enterprises		
	High	Moderate	Undetermined	High	Moderate	Undetermined
Dynamic-centralized model (N = 13)	4	3	2	1	3	-
Moderately dynamic decentralized model (N = 13)	2	3	1	2	4	1
Inertial-decentralized model (N = 12)	1	1	2	3	4	1
Total	7	7	5	5	12	2

A higher level of satisfaction with the achieved transaction goals was observed in personally related companies (seven responses). In unrelated companies, the level of satisfaction was usually defined as moderate. This concept hinted at a partial implementation of the assumed acquisition goals. The parameter that was important for assessing the satisfaction of the transaction was the position in the network of connections determined by the indicator of closeness centrality and the eigenvector. Seven companies that declared a high level of achievement of the objectives achieved an average closeness centrality indicator of 0.6 (with the average for the related companies surveyed 0.42). Also, the

eigenvector index reached an average higher than the average for the whole group of related companies, which was 0.58 (the average for the group was 0.36). This may mean better access to information in this group of companies than for the other surveyed companies related through interlocking. The research assumed that several factors influence the course of post-transaction integration, which in the literature are indicated as key success factors in the acquisition processes. The surveyed CEOs were asked to assess the significance of several selected factors such as experience in acquisition processes, having an integration plan, dynamics of integration activities and their centralization, their approach to acquisition in terms of strategy or market opportunity. The obtained results are presented in Table 10.

**Table 10.** Assessment of the importance of selected elements in the process of post-transaction integration in personally related and unrelated enterprises.

Criterion for Assessing the Post-Acquisition Integration Process	Evaluation of the Importance of the Criterion	
	Personally Related Enterprises	Unrelated Enterprises
Experience in acquisition transactions	High	Moderate
Acquisition approach (strategy/market opportunity)	High	Moderate
Transaction motivation	High	High
Dynamics of integration activities	High	Moderate
Possession of an integration plan	High	Moderate
Form of integration (centralized/decentralized)	High	High

When assessing these factors, none of the CEOs surveyed indicated their low importance. The difference in the perception of significance in related and unrelated companies concerned such factors as the significance of experience in conducting acquisitions which, in unrelated companies, was defined as moderate. A similar assessment in this group of enterprises also concerned the importance of the dynamics of integration activities, having an integration plan or the approach to acquisition in terms of an instrument for implementing the growth strategy or taking advantage of the market opportunity.

## 6. Conclusions

In this article, attempts were made to determine—based on empirical data—the impact of personal connections between the management boards of companies involved in the acquisition and the post-transaction integration model, based on which the process of merging organizations was carried out in the listed companies under examination. All of the analyzed transactions were carried out on the Polish capital market, were industry acquisitions and constituted an example of horizontal concentration. The conducted research, the results of which have been presented as part of this study, has shown that the scope of personal relationships between companies and acquisition transaction partners is low. In the analyzed companies, the relationship through interlocking directorates translates into a higher integration dynamics, a higher level of centralization of activities and a higher declared satisfaction with the acquisition. An important factor for the process of post-transaction integration is the durability of relationships between transaction partners and the position held in the network of connections. If relationships are long-term, it is important for faster integration of business processes. Also, higher than the average value for the examined group of companies were measures of closeness centrality and eigenvector. These can mean better access to information, translate into higher dynamics and centralization of integration activities in personally related companies. As a result of the conducted research, it is possible to formulate recommendations of directing enterprises towards the exploitation of personal relations between management boards for those companies which have based their strategic development on mergers and acquisitions. Since interlocking connections have an impact on the higher dynamics of integration activities, personal connections would be primarily recommended for those enterprises which the pace business process integration is important, from the point of view of rapid achievement of the assumed integration goals. It is important that these relationships are



long-term (in the presented studies, the average length of relationship was 496 days). The requirement of a long-term relationship, fulfilled long before the transaction is concluded, builds trust; and this element is treated as a critical success factor in post-acquisition integration processes. It seems that it would be worthwhile to continue researching this issue in the future. It would be interesting to identify trends in interlocking directorates in acquisition processes in Poland in the long term. It would also be worth expanding the scope of research using the adopted methodology to other countries in Central and Eastern Europe. Undoubtedly, an interesting direction of further research would be financial analyses which show the relationship between interlocking and the implemented post-transaction integration model and the impact on the financial effect of acquisition transactions. An undoubted limitation for the research conducted was the incompleteness of the Euromoney Institutional Investor Company (EMIS) database, based on which the analyses were conducted. The dedicated database of all operations that took place between the years 2012 and 2014 on the Warsaw Stock Exchange and New Connect, although treated as the most comprehensive source of information on acquisitions carried out on capital markets, contained many data gaps that hindered the analysis. Restrictions also appeared during the stage of collecting opinions in studies using semi-structured interviews. Difficulties in reaching respondents resulted in the need to launch informal channels to reach them. Unfortunately, achieving representativeness in the analyzed studies turned out to be impossible.

**Funding:** This research received no external funding.

**Conflicts of Interest:** The author declare no conflict of interest.

## References

1. Pool, R. Training for Results: Innovative Synergy between Learning and Business Performance. *Ind. Commer. Train.* **2011**, *43*, 31–37. [\[CrossRef\]](#)
2. Pun, K.F. A Conceptual Synergy Model of Strategy Formulation for Manufacturing. *Int. J. Oper. Prod. Manag.* **2004**, *24*, 912–918.
3. Anand, M.; Singh, J. Impact of Merger Announcements on Shareholders' Wealth: Evidence from Indian Private Sector Banks. *Vikalpa* **2008**, *33*, 35–54. [\[CrossRef\]](#)
4. Mitchell, M.L.; Stafford, E. Managerial Decisions and Long-Term Stock Price Performance. *J. Bus.* **2000**, *52*, 1765–1790. [\[CrossRef\]](#)
5. Rosen, R.J. Merger Momentum and Investor Sentiment the Stock Market Reaction to Merger Announcements. *J. Bus.* **2006**, *79*, 987–1017. [\[CrossRef\]](#)
6. Czerwonka, L. Długookresowy wpływ połączeń przedsiębiorstw na wartość spółek przejmujących. *Rynek Kapitałowy* **2010**, *10*, 35–36.
7. Rappaport, A. *Creating Shareholder Value: A Guide for Managers and Investors*; The Free Press: Richmond, VA, USA, 1998.
8. Bijlsma-Frankema, K. On managing cultural integration and cultural change processes in mergers and acquisitions. *J. Eur. Ind. Train.* **2001**, *25*, 192–207. [\[CrossRef\]](#)
9. Svenson, G.; Wood, G.; Callaghan, M. A corporate model of sustainable business practices: An ethical perspective. *J. World Bus.* **2010**, *45*, 338. [\[CrossRef\]](#)
10. Miozzo, M.; Walsh, V. *International Competitiveness and Technological Change*; Oxford University Press: Oxford, UK, 2006.
11. Hatch, M.J. *Teoria Organizacji*; Wydawnictwo Naukowe PWN: Warszawa, Poland, 2001.
12. Jensen, M.C. Agency Costs of Free Cash Flow, Corporate Finance and Takeovers. *Am. Econ. Rev.* **1986**, *76*, 323–329.
13. Harrison, J.S.; Bosse, D.A.; Phillips, R.A. Managing for stakeholders, stakeholder utility functions, and competitive advantage. *Strateg. Manag. J.* **2010**, *31*, 58–74. [\[CrossRef\]](#)
14. Myerson, R.B. *Game Theory. Analysis of Conflict*; Harvard University Press: Cambridge, MA, USA, 1997.
15. Granovetter, M. Economic Action and Social Structure: The Problem of Embeddedness. *Am. J. Sociol.* **1985**, *91*, 481–510. [\[CrossRef\]](#)
16. Cai, Y.; Sevilir, M. Board connections and M&A transactions. *J. Financ. Econ.* **2012**, *103*, 327–349. [\[CrossRef\]](#)

17. Chwistecka-Dudek, H. *Dywersyfikacja. Strategia Rozwoju Przedsiębiorstwa*; Wyższa Szkoła Biznesu w Dąbrowie Górniczej: Dąbrowa Górnicza, Poland, 2009.
18. Cording, M.; Christman, P.; King, D.R. Reducing Causal Ambiguity in Acquisition integration: Intermediate Goals as Mediators of Integration Decision and Acquisition Performance. *Acad. Manag. J.* **2008**, *51*, 744–767. [[CrossRef](#)]
19. Schoenberg, R. Measuring the Performance of Corporate Acquisitions: An Empirical Comparison of Alternative Metrics. *Br. J. Manag.* **2006**, *17*, 361–370. [[CrossRef](#)]
20. Mizruchi, M. What Do Interlocks Do? An Analysis, Critique and Assessment of Research on Interlocking Directorates. *Annu. Rev. Sociol.* **1996**, *22*, 271–298. [[CrossRef](#)]
21. Zhang, Q. A Comparative Study of the Effect of Interlocking Directorates on Merger Target Selection under Different Merger and Acquisition Modes. *Am. J. Ind. Bus. Manag.* **2016**. [[CrossRef](#)]
22. Zdziarski, M. Elita wewnętrznego kręgu i centralne firmy. Wyniki badań relacji przez rady nadzorcze w polskich spółkach giełdowych. *Organizacja i Kierowanie* **2012**, *1*, 23–39.
23. Perez-Calero, L.; Barossa, C. It is useful to consider the interlocks according to the type of board member (executive or non-executive) who possesses them? Their effect on firm performance. *Rev. Eur. Dir. Econ. Empres.* **2015**, *24*, 130–137.
24. Simoni, M.; Caiazza, R. Interlocking directorates' effects on economic system's competitiveness. *Bus. Strategy Ser.* **2013**, *14*, 30–35. [[CrossRef](#)]
25. Bodner, J. Post-merger integration. *J. Organ. Des.* **2018**, *7*, 1–20. [[CrossRef](#)]
26. Chuluun, T.; Prevost, A.; Puthenpurackal, J. Board Ties and the Cost of Corporate Debt. *Financ. Manag.* **2014**, *43*. [[CrossRef](#)]
27. Zona, F.; Gomez-Mejia, L.; Withers, M. Board Interlocks and Firm Performance. *J. Manag.* **2018**, *44*, 589–618. [[CrossRef](#)]
28. Engelberg, J.; Gao, P.; Parsons, C.A. Friends with money. *J. Financ. Econ.* **2012**, *103*, 169–188. [[CrossRef](#)]
29. Palmer, D. Broken Ties: Interlocking Directorates and Intercorporate Coordination. *Adm. Sci. Q.* **1983**, *28*, 40–55. [[CrossRef](#)]
30. Yang, Y.; Lütge, C.; Yang, H. Organizational culture affecting post-merger integration. *Rev. Int. Bus. Strategy* **2019**, *29*, 139–154. [[CrossRef](#)]
31. Yang, H.; Lin, Z.; Peng, M. Behind Acquisitions of Alliance Partners: Exploratory Learning and Network Embeddedness. *Acad. Manag. J.* **2011**, *54*, 1069–1080. [[CrossRef](#)]
32. Cukurova, S. Interlocking Directors and Target Selection in Mergers and Acquisitions. Available online: [www.igier.unibocconi.it/files/Cukurova.pdf](http://www.igier.unibocconi.it/files/Cukurova.pdf) (accessed on 24 September 2019).
33. Wu, Q. Information Conduit or Agency Cost: Top Management and Director Interlock between Acquirers and Targets. *SSRN Electron. J.* **2017**. [[CrossRef](#)]
34. Cremers, K.J.; Nair, V.B.; Kose, J. Takeovers and the Cross-section of Returns. *Rev. Financ. Stud.* **2005**, *22*, 1409–1445. [[CrossRef](#)]
35. Sleptov, A.; Anand, J.; Vasudeva, G. Relational configurations with information intermediaries: The effect of firm-investment bank ties on expected acquisition performance. *Strateg. Manag. J.* **2013**, *34*, 957–977. [[CrossRef](#)]
36. Schonlau, R.; Singh, P. Board Networks and Merger Performance, 2009, 4–14. Available online: <https://ssrn.com/abstract=1322223> (accessed on 20 September 2019).
37. Habeck, M.H.; Kroger, F.; Trum, M.R. *After the Mergers: Seven Rules for Successful Post-Merger Integration*; Prentice Hall: New York, NY, USA; Financial Times: London, UK, 2000.
38. Gomes, E.; Angwin, D.; Weber, Y.; Tarba, S. Critical Success Factors through the Mergers and Acquisitions Process: Revealing Pre- and Post-M&A Connections for Improved Performance. *Thunderbird Int. Bus. Rev.* **2013**, *55*. [[CrossRef](#)]
39. Pablo, A. Determinants of Acquisitions Level: A Decision making Perspective. *Acad. Manag. J.* **1994**, *4*, 803–836.
40. Haspeslagh, P.C.; Jemison, D. *Managing Acquisitions: Creating Value through Corporate Renewal*; The Free Press: New York, NY, USA, 1991; p. 106.
41. Chase, B. National city's latest mergers put premium on fast execution. *Am. Bank.* **1998**, *3–4*, 163.
42. Schlaepfer, R.; di Paola, S.; Kupiers, R.; Brauchli-Rohrer, B.; Marti, A.; Brun, P.; Baldinger, G. How can leadership make a difference—An integration survey. *PWC* **2008**, *143*, 1–16.

43. Bauer, F.; Degischer, D.; Matzler, K. Is Speed of Integration in M&A Learnable? The Moderating Role of Organizational Learning on the Path of Speed of Integration on Performance. Zadar, Croatia, 2013. Available online: <http://www.toknowpress.net/ISBN/978-961-6914-02-4/papers/ML13-299.pdf> (accessed on 24 September 2019).
44. Angwin, D. Speed in M&A integration: The first 100 days. *Eur. Manag. J.* **2004**, *22*, 418–430.
45. Homburg, C.; Bucerius, M. Is speed of integration really a success factor of mergers and acquisitions? An analysis of the role of internal and external relatedness. *Strateg. Manag. J.* **2006**, *27*, 347–367. [CrossRef]
46. Olie, R. Shades of culture and institutions in international mergers. *Organ. Stud.* **1994**, *15*, 381–405. [CrossRef]
47. Bauer, F.; Matzler, K. Antecedents of M&A success: The role of strategic complementarity, cultural fit, and degree and speed of integration. *Strateg. Manag. J.* **2013**. [CrossRef]
48. Silverman, D. *Prowadzenie Badań Jakościowych*; Wydawnictwo Naukowe PWN: Warszawa, Poland, 2019.
49. Kawa, A. *Orientacja Sיעiowa Przedsiębiorstw Branży Usług Logistycznych*; Wydawnictwo Uniwersytetu Ekonomicznego w Poznaniu: Poznań, Poland, 2017.
50. Scott, J. *Social Network Analysis. A Handbook*; SAGE Publications: London, UK, 2000.
51. Stankiewicz-Mróz, A. Analiza sieci społecznych jako narzędzie optymalizacji przebiegu integracji po przejęciach przedsiębiorstw. *Zesz. Nauk. Politech. Łódzkiej* **2016**, *1209*, 107–121.
52. Miles, M.B.; Huberman, A.M. *Qualitative Data Analysis. An Expanded Sourcebook*; Sage: Beverly Hills, CA, USA, 1994.
53. Larsson, R.; Lubatkin, M. Achieving acculturation in mergers and acquisitions: An international case survey. *Hum. Relat.* **2001**, *54*, 1573–1607. [CrossRef]
54. Bertaux, D. From the Life-history Approach to the Transformation of Sociological Practice. In *Biography and Society: The Life History Approaches in the Social Sciences*; Bertaux, D., Ed.; Sage Publications: Beverly Hills, CA, USA, 1981; pp. 29–45.
55. Guest, G.; Bunce, A.; Johnson, L. How many interviews are enough? An experiment with data saturation and variability. *Field Methods* **2006**, *18*, 59–82. [CrossRef]
56. Risks of the Modern Merger and Acquisition Market. Report from the Crowe Horwath and FERF 2017 Survey. Available online: <https://www.tgc.eu/media/publikacje/Mergers&Acquisitions.pdf> (accessed on 24 September 2019).
57. Schweiger, D.M.; Walsh, J.P. Mergers and Acquisitions: An Interdisciplinary View. In *Research in Personnel and Human Resources Management*; Shaw, B.B., Beck, J.E., Eds.; JAI Press: Greenwich, CT, USA, 1990; Volume 8, pp. 41–107.
58. Cuhe, D. La Notion de Culture dans les Sciences Sociales. *Découverte Rev. Française Sociol. Année* **2001**, *41*, 170–172.
59. Vaara, E. Cultural Differences and Post-Merger Problems: Misconceptions and Cognitive Simplifications. *Organisasjonsstudier* **1999**, *1–2*, 59–88.
60. Teerikangas, S.; Very, P. The Culture-Performance Relationship in M&A: From Yes/No to How. *Br. J. Manag.* **2006**, *17*, 31–48.
61. Datta, D.K. Organizational Fit and Acquisition Performance: Effects of Post-Acquisition Integration. *Strateg. Manag. J.* **1991**, *12*, 281–297. [CrossRef]
62. Chatterjee, S.; Lubatkin, M.H.; Schweiger, D.M.; Weber, Y. Cultural Differences and Shareholder Value in Related Mergers: Linking Equity and Human Capital. *Strateg. Manag. J.* **1992**, *13*, 319–334. [CrossRef]
63. Weber, R.A.; Camerer, C.F. Cultural Conflict and Merger Failure: An Experimental Approach. *Manag. Sci.* **2003**, *49*, 400–415. [CrossRef]
64. Krishnan, H.A.; Miller, A.; Judge, W.Q. Diversification and Top Management Team Complementarity: Is Performance Improved by Merging Similar or Dissimilar Teams? *Strateg. Manag. J.* **1997**, *18*, 361–374. [CrossRef]
65. Faulkner, D.; Teerikangas, S.; Joseph, R. (Eds.) Culture in M&A—A critical synthesis and steps forward. In *Handbook of Mergers and Acquisitions*; Oxford University Press: Oxford, UK, 2012.
66. Riad, S. Of Mergers and Cultures: “What Happened to Shared Values and Joint Assumptions?”. *J. Organ. Chang. Manag.* **2007**, *20*, 26–43. [CrossRef]
67. Stahl, G.; Kremershof, J.; Larsson, R. *Trust Dynamics in Mergers and Acquisitions. A Case Survey*; Human Resources Management; INSEAD: Fontainebleau, France, 2011; Volume 50, pp. 575–603.

68. Barkema, H.G.; Schijven, M. A How do firms learn to make acquisitions? A review of past research and an agenda for the future. *J. Manag.* **2008**, *34*, 594–634. [[CrossRef](#)]
69. Barkema, H.G.; Bell, J.H.; Pennings, J.M. Foreign entry, cultural barriers, and learning. *Strateg. Manag. J.* **1996**, *12*, 151–166. [[CrossRef](#)]
70. Ellis, K.M.; Reus, T.H.; Lamont, B.T.; Ranft, A.L. Transfer effects in large acquisitions: How size-specific experience matters. *Acad. Manag. J.* **2011**, *54*, 1261–1276. [[CrossRef](#)]
71. Reus, T.H.; Lamont, B.T.; Ellis, K.M. A darker side of knowledge transfer following international acquisitions. *Strateg. Manag. J.* **2016**, *37*, 932–944. [[CrossRef](#)]
72. Zollo, M.; Meier, D. What is M&A performance? *Acad. Manag. Perspect.* **2008**, *22*, 55–77.
73. Dess, G.; Robinson, R.B. Measuring Organizational Performance in the Absence of Objective Measures: The Case of the Privately-held Firm and Conglomerate Business Unit. *Strateg. Manag. J.* **1984**, *5*, 265–273. [[CrossRef](#)]



© 2019 by the author. Licensee MDPI, Basel, Switzerland. This article is an open access article distributed under the terms and conditions of the Creative Commons Attribution (CC BY) license (<http://creativecommons.org/licenses/by/4.0/>).

Review

# Research Profiling for Responsible and Sustainable Innovations

Agata Sudolska <sup>1,\*</sup>, Andrzej Lis <sup>2</sup> and Monika Chodorek <sup>3</sup>

<sup>1</sup> Department of Enterprise Management, Faculty of Economic Sciences and Management, Nicolaus Copernicus University, Gagarina 13a, 87-100 Torun, Poland

<sup>2</sup> Department of Business Excellence, Faculty of Economic Sciences and Management, Nicolaus Copernicus University, Gagarina 13a, 87-100 Torun, Poland; andrzejlis@econ.umk.pl

<sup>3</sup> WSB University in Torun, Institute of Management, Młodziejowa 31a, 87-100 Torun, Poland; monika.chodorek@wsb.torun.pl

\* Correspondence: aga@econ.umk.pl; Tel.: +48-56-6114890

Received: 27 October 2019; Accepted: 18 November 2019; Published: 20 November 2019

**Abstract:** The issues of responsible and sustainable innovations have been attracting the growing attention of the ranks of scholars in recent years. However, this amassing productivity in the field has not been mapped and profiled thoroughly, yet. Therefore, the aim of the paper is to map the research output related to the concepts of responsible and sustainable innovations with the method of research profiling. The analysis consists of three components: general research profiling, subject area profiling and topic profiling conducted with the use of Scopus database. The research process is directed at answering three research questions: (1) who are the main contributors within the scholarly community? why? so what? (2) how is the research output distributed among subject areas? why? so what? (3) what are the central topics and issues discussed within the research field? why? so what? First of all, key contributing countries, research institutions, journals, and authors are identified in order to characterize the scholarly community working in the field. Secondly, research output is profiled through the prism of respective subject areas. This type of profiling aims at discovering varieties among key journals, authors and core references distributed across various subject areas. Thirdly, topic analysis is conducted in order to point out most crucial aspects studied in the body of literature in the field. The research sample consists of 1083 publications indexed in Scopus database, including the phrases ‘responsible innovation’ or ‘sustainable innovation’ within their titles, keywords, and abstracts (topic search). The findings from the general research profiling confirm the growing interest of academia in exploring and investigating the issues of responsible and sustainable innovations. The leading contributors in the field are scholars and research institutions from the Netherlands, the United Kingdom, and the United States. Dutch universities and research centers occupy three top three positions in regard to the number of publications. Among them, Delft University of Technology is the unquestionable leader. *Journal of Cleaner Production* and *Journal of Responsible Innovation* are found to be the most prolific and highly recognized source titles in the field. Subject area profiling shows a relatively high level of interrelatedness among the four leading subject areas i.e., Business, Management and Accounting, Engineering, Social Sciences, and Environmental Science in regard to authors, source titles and core references. Topic profiling indicates two leading thematic streams in the research field focused on the features and core aspects of responsible and sustainable innovations, and the relationships of the concept with people (human, humans), research, ethics, and technology. Discussion of research findings is focused around comparing and contrasting three overlapping concepts (i.e., responsible research and innovation, responsible innovation, and sustainable innovation), providing the critical assessment of the reasons for the scholarly research to have developed along with certain patterns and identifying unexplored aspects or possible future avenues of research.

**Keywords:** responsible innovation; sustainable innovation; bibliometrics; research profiling

---

## 1. Introduction

The discussion on the responsibility of business for the impact on society as well as the environment has matured over the last few decades, resulting in comprehensive literature across several fields of study [1–7]. Among others, the issue of business responsibility involves the problems of broadly understood innovations. Recently, in the above-said literature stream, responsible innovation has emerged as a new approach that expands on previously proposed concepts related to business responsibility by drawing on technology assessment, ethics in science and technology studies, and ethical, legal, as well as social aspects at the start of innovation process [8–13]. The main idea of the concept is to democratize innovation as well as realize deliberative forms of governance through stakeholder and public engagement [14–16]. Although generally innovation is perceived as inherently good, there is always a probability that it may have some unforeseen consequences. Today, there is a considerable agreement among researchers on the fact that even the most promising innovation can fail due to ethical and societal concerns that result from the innovation but were not properly taken into account [14,17,18]. Also, the way people think today about responsibility, from the perspective of innovations, is changing by reflecting the modern context in which innovations occur [15,19,20]. In consequence, nowadays, the scope of responsibility in regard to innovations goes beyond legal requirements and business standards and encompasses the expectations of stakeholders and values related to the society and the natural environment required at the markets, where innovations are planned to be implemented. In such a context, the literature introduces the ideas of responsible and sustainable innovations [9,15,21].

The importance of responsible and sustainable innovations refers to the fact that these ideas are considered as up-to-date holistic and multidisciplinary concepts highlighting the problem of dynamic capability used to develop a long-term firm sustainable advantage. Focus on responsible and sustainable innovations forces companies to learn new approaches and let go of old ones around the search for innovation [15,21]. It entails governing through early ‘upstream’ interventions rather than ‘downstream’ monitoring and ‘correction’ of interventions ex-post. The discussion on responsible and sustainable innovations is momentous as frequently one can observe significant time lags between the development of innovations, understanding of their wider impacts as well as subsequent governance. Therefore, nowadays there is an urgent need for more anticipatory and adaptive approaches that help to understand the ways in which new technologies and social practices enable societies to become more sustainable and that help unleash a new era of economic development [15].

The issues of responsible and sustainable innovations have been attracting the growing attention of the ranks of scholars in recent years. However, this growing research output in the field has not been mapped and profiled thoroughly, yet. The search in Scopus and Web of Science databases, conducted on 27 May 2018, shows no records for the conjunction of phrases ‘responsible innovation’ OR ‘sustainable innovation’ AND ‘research profiling’ in titles, keywords and abstracts of indexed publications. Such an observation reveals the gap in the research field. It allows to state that the assessment of the research productivity in a quantitative and systematic way is not found in the literature. Thus, there is a need for a research profiling analysis that studies ‘responsible innovation’ as well as ‘sustainable innovation’ from a global perspective. Filling the identified research gap is a motivation for undertaking the research. Traditional literature surveys, regardless of whether they are of simple narrative or even systematic character, are flawed with incompleteness resulting from the limited number of publications included for qualitative analysis. Employing the method of research profiling gives the opportunity to conduct the quantitative analysis of a wide body of literature in order to identify research trends and patterns. Combining this quantitative approach with the qualitative systematic review used to support discussion and interpretation of collected data ensures the triangulation of research methodology and

increases quality assurance of the study. As mentioned above, so far there has not been such a research profiling study in the field. Therefore, using this particular bibliometric method to map the research field is something that makes this study exceptional and differentiates it from other surveys in the field. It contributes to the novelty of the study and its potential to become an important publication in light of all other existing and recent reviews in the field.

Taking into account the identified gap in the body of knowledge and the aforementioned motivations, the aim of the paper is to map the research output related to the concepts of responsible and sustainable innovations. The research process is focused on the following research questions: (1) who are the main contributors (countries, affiliated institutions, source titles, authors) within the scholarly community? why? so what? (2) how is the research output distributed among subject areas? why? so what? (3) what are the central topics and issues discussed within the research field? why? so what?

## **2. Method and Structure of Study**

The method of research profiling is applied to achieve the aforementioned aim and provide answers to research questions. Research profiling is categorized among the methods of bibliometric descriptive studies aimed at exploring the features of the body of knowledge in the given research field [22] (pp. 150–151). The research profiling method shows a high potential to augment traditional literature reviews by exploring a wide range of literature in order to identify patterns and research trends [23] (pp. 351–353). Therefore, research profiling may be considered as an effective tool used to map the research field.

The work by Martinez et al. [24] was used as a benchmark to design the research process and structure the paper. Moreover, some other publications applying research profiling methodology provided inspirations and guidelines [25–27]. The structure of the paper follows the pattern of the research profiling methodology and consists of three components i.e., general research profiling, subject area profiling, and topic profiling. First of all, key contributing countries, research institutions, journals, and authors are identified in order to characterize the scholarly community working in the field. Secondly, research output is profiled through the prism of respective subject areas. This type of profiling aims at discovering varieties among key journals, authors and core references distributed across various subject areas. Thirdly, topic analysis is conducted in order to point out the most crucial aspects studied in the body of literature in the field. Results presentation and analysis is concluded with the discussion section aimed at interpreting the findings in the context of the existing literature in the field. The method of a systematic literature review is used to support discussion and interpretation of the findings.

## **3. Research Sample**

Within the field of study, the variety of concepts combining the ideas of innovations and corporate social responsibility may be observed. For instance, Lis and Sudolska [28] identify twelve of such concepts including: responsible innovations (RI), responsible research and innovations (RRI), socially responsible innovations (SRI), social innovation (SocI), sustainable innovations (SI), environment innovations (EI), eco-innovations (EcoI), green innovations (GI), inclusive innovations (II), frugal innovations (FI), grassroots innovation (GRI), and workplace innovations (WI). The aforementioned concepts vary in scope, some of them refer in general to the ideas of responsibility or sustainability, the others focus on particular aspects such as the environment, society or employees. Some of these concepts are stand-alone, while others overlap. Being aware of complexity and multidimensionality of the concepts in the research field, we decided to focus the mapping process on responsible innovations and sustainable innovations, which both are comprehensive categories, their definitions are close to each other and their scopes encompass other concepts mentioned above. It should be made explicit that such a solution has both advantages and limitations. On the one hand,

it increases the consistency of the research sample, while on the other hand reduces the number of items included in the sample.

The process of research sampling was conducted with the use of the Scopus database. As of 27 May 2018, the pair of phrases ‘responsible innovation’ OR ‘sustainable innovation’ was searched within titles, keywords, and abstracts of publications indexed in Scopus. In total, 1083 records were retrieved, which were used for research profiling. The majority of the research sample is made up of articles (593, 54.76%), conference papers (199, 18.37%), and book chapters (104, 9.60%). All the categories of publications included in the sample are listed in Table 1.

**Table 1.** The structure of the research sample by document type.

Document Type	N	%
Article	593	54.76
Conference paper	199	18.37
Book chapter	104	9.60
Review	66	6.09
Editorial	31	2.86
Article in press	25	2.31
Book	24	2.22
Conference review	11	1.02
Note	11	1.02
Short survey	11	1.02
Letter	5	0.46
Erratum	3	0.28

Source: Own study based on data retrieved from the Scopus database (accessed 27 May 2018).

The value of the h-index for the research profiling sample is 44. Identification of the most prominent works within the field was used as the foundation for building up the corpus of publications used for systematic literature review supporting discussion and interpretation of the research profiling findings. Then, using abstract analysis, the papers most relevant to the topic and aim of the study were chosen. The advantage of such an approach is to ensure that all the relevant and, simultaneously, the most influential (i.e., those receiving the highest number of citations) publications in the field are included. Nevertheless, this procedure of sampling has some weaknesses as well. For instance, there is a risk of neglecting some key and important papers published recently which so far have not been cited so much (which is quite likely) or papers not including searched keywords (‘responsible innovation’ or ‘sustainable innovation’) in their titles, keywords, and abstracts (less likely). Moreover, the Scopus database is biased towards English language publications, which results in the underrepresentation of literature in other languages in the sample. Therefore, using the method of snowball sampling, the body of publications was supplemented with some other works not listed among core references in the research profiling sample.

#### 4. General Publication Profiling

##### 4.1. Number of Publications and Received Citations

The earliest publication included in the research sample is dated as of 1978. Nevertheless, the main bulk of research output is very recent. The most dynamic growth of researchers’ interest in the field has been observed since 2013. The publications making up the research sample have received in total 10,789 citations. Similarly to the number of publications, a significant increase in the number of received citations has been noted in very recent years. Yearly distribution of publications within the sample and citations they received are illustrated in Figure 1.



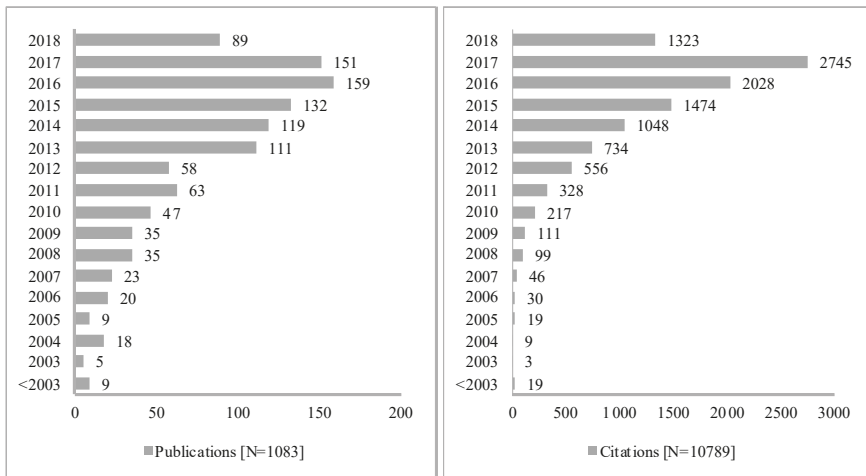

**Figure 1.** Scientific productivity of research on responsible and sustainable innovations. Source: Own study based on data retrieved from Scopus database (accessed 27 May 2018).

The changes in the scientific productivity (the number of publications) from 2003 to 2017 are best represented with the 2 degree polynomial function ( $y = 0.7404x^2 - 2964.9x + 3E+06, R^2 = 0.9647$ ) or the exponential function ( $y = 5E-198e^{0.2279x}, R^2 = 0.9308$ ). Similarly, the line of trend for the number of citations received by the publications included in the sample shows characteristics typical of the exponential function ( $y = 0e^{0.4609x}, R^2 = 0.9781$ ) or the 2 degree polynomial function ( $y = 23.342x^2 - 93670x + 9E+07, R^2 = 0.9758$ ). The analysis of research productivity in the field manifested in the number of publications and the number of citations received by these works shows the growing interest of the academia in issues related to responsible and sustainable innovation. Prior to 2003, only single publications are noticed. Then, there is observed a period of slowly growing attention (2003–2012). Recently (2013–2018), the acceleration of the rising trend is reported.

#### 4.2. Country Profiling

The research sample includes 84 items of undefined country/territory. The remaining publications are distributed among 55 countries representing all the continents. Table 2 shows the geographical distribution of research in the area of responsible and sustainable innovations.

**Table 2.** Geographical distribution of research on responsible and sustainable innovations.

No.	Region	Publications			Citations			h
		N	% [1083 = 100%]	% [1430 = 100%]	N	% [10,789 = 100%]	% [15,558 = 100%]	
1	Europe	714	65.93	49.93	9063	84.00	58.25	41
2	North America	232	21.42	16.22	2314	21.45	14.87	22
3	Asia	173	15.97	12.10	1086	10.07	6.98	17
4	South America	96	8.86	6.71	1432	13.27	9.20	15
5	Australia and Oceania	79	7.29	5.52	746	6.91	4.79	14
6	Africa	52	4.80	3.64	592	5.49	3.81	12
7	Undefined territory	84	7.76	5.87	325	3.01	2.09	6
	Total	1430	132.04	100.0	15,558	144.2	100.0	

Source: Own study based on data retrieved from the Scopus database (accessed 27 May 2018).

The leading position of European countries is noticeable in the published papers regarding responsible and sustainable innovation. They account for contributing to over 65% of all articles in the

research sample (nearly 50% if contributions counted separately for each country), and their citation rate falls at 84% (respectively 58%). North America is in the second position and Asia in the third one. A significant difference between Europe and other continents in the number of published articles and received citations should be noticed.

Country profiling can be a reflection of the activity and the academic level in the analyzed field. Table 3 shows the most productive countries in research on responsible and sustainable innovations.

**Table 3.** Topmost productive countries/territories in research on responsible and sustainable innovations.

No.	Country/Territory	Publications		Citations		
		N	%	N	%	h
1.	Netherlands	219	20.22	3770	34.94	27
2.	United Kingdom	173	15.97	3823	35.43	29
3.	United States	168	15.51	1729	16.03	20
4.	Germany	75	6.93	1632	15.13	14
5.	Italy	59	5.45	323	2.99	11
6.	France	54	4.99	306	2.84	10
7.	China	51	4.71	176	1.63	7
8.	Brazil	47	4.34	883	8.18	10
9–10.	Denmark	39	3.60	508	4.71	11
9–10.	Spain	39	3.60	525	4.87	10

Source: Own study based on data retrieved from the Scopus database (accessed 27 May 2018).

Top 10 most productive countries contribute with 85.32% of all research output in the field. The group of the most productive countries is made up of representatives of European, North American, South American, and Asian nations. The regions highly concentrated on the research in the field in Europe are the Netherlands and the United Kingdom (together 392 articles). What is also of paramount importance, the research affiliated at institutions in these two countries shows high quality, which is manifested in a high number of received citations and the value of h-index. Other European countries ranked among the top 10, i.e., Germany, Italy, France, Denmark, and Spain, contributed in total with 266 articles. The group of the most productive countries is complemented by the representatives of North America (the United States, N = 168 articles, rank 3), Asia (China, N = 51, rank 7), and South America (Brazil, N = 47, rank 8). The key contributors from other continents are Australia (N = 31, rank 13) and South Africa (N = 11, rank 22). Summing up, in regard to quantity of the research output, the leaders in the field are the Netherlands, the United Kingdom, and the United States. Taking into account the quality of the research, Germany should be added to the aforementioned countries.

#### 4.3. Institution Profiling

As regards affiliated institutions, there are identified 17 universities that contributed with 10 or more papers. Top 10 most productive universities provided 228 publications (268 if calculated separately), which received 4941 citations. The h-index for the top 10 institutions is 41. They are listed in Table 4.

The most productive institutions in the field come mainly from Europe (seven of them from the Netherlands, two from the United Kingdom) and only one from the United States. The leader is the Delft University of Technology (67 articles). The second position is occupied by Wageningen University and Research Center (36 articles) and the third position by Utrecht University (26 articles). As regards the number of received citations, manifesting the quality of research work, the leaders are two universities from the United Kingdom, i.e., the University of Sussex and the University of Exeter. Among the most productive institutions, there are no representatives of other nations found to be leaders in research on responsible and sustainable innovations such as Germany, Italy, France, China, Brazil, Denmark, or Spain.

**Table 4.** Topmost productive institutions in research on responsible and sustainable innovations.

No.	Institution	Country	Publications		Citations		
			N	%	N	%	h
1.	Delft University of Technology	Netherlands	67	6.19	718	6.65	13
2.	Wageningen University and Research Center	Netherlands	36	3.32	242	2.24	8
3.	Utrecht University	Netherlands	26	2.40	497	4.61	11
4.	Arizona State University	United States	25	2.31	421	3.90	8
5.	University of Twente	Netherlands	23	2.12	356	3.30	8
6.	Eindhoven University of Technology	Netherlands	21	1.94	751	6.96	9
7–8.	University of Sussex	United Kingdom	18	1.66	1094	10.14	10
7–8.	University of Exeter	United Kingdom	18	1.66	951	8.81	11
9–10.	Vrije University Amsterdam	Netherlands	17	1.57	272	2.52	5
9–10.	Maastricht University	Netherlands	17	1.57	213	1.97	6

Source: Own study based on data retrieved from the Scopus database (accessed 27 May 2018).

#### 4.4. Journal Profiling

Within the sample, there are 10 source titles that issued to 10 or more publications. The threshold of 5 and more publications is achieved by 28 source titles. Table 5 shows the topmost productive journals in responsible and sustainable innovations area.

**Table 5.** Top most productive source titles in research on responsible and sustainable innovations.

No.	Journal	Publications		Citations		
		N	%	N	%	h
1.	Journal of Cleaner Production	64	5.91	1143	10.59	15
2.	Journal of Responsible Innovation	59	5.45	410	3.80	11
3.	Sustainability Switzerland	17	1.57	63	0.58	4
4.	Science and Engineering Ethics	15	1.39	156	1.45	7
5–7.	International Journal of Innovation and Sustainable Development	14	1.29	55	0.51	4
5–7.	Responsible Innovation 2: Concepts, Approaches and Applications	14	1.29	111	1.03	5
5–7.	Responsible Innovation: Managing the Responsible Emergence of Science and Innovation in Society	14	1.29	463	4.29	12

Source: Own study based on data retrieved from the Scopus database (accessed 27 May 2018).

The most prolific and highly recognized source title in the field is the *Journal of Cleaner Production*, which published 64 articles receiving in total 1143 citations. The second place is occupied by the *Journal of Responsible Innovation* (59 articles cited 410 times). Other source titles differ significantly from the two leading ones in terms of the number of publications. It is worth noting that *Responsible Innovation: Managing the Responsible Emergence of Science and Innovation in Society* published only 14 articles, however, the number of their citations is the second in the series (cited 463 times). Noteworthy are also *Science and Engineering Ethics* (15 articles) cited 156 times and *Responsible Innovation 2: Concepts, Approaches and Applications* (14 articles) cited 111 times.

#### 4.5. Authors Profiling

Only three authors contributed with more than 10 papers on responsible and sustainable innovations, while 25 researchers produced five publications or more. Topmost productive authors are listed in Table 6.

**Table 6.** Topmost productive authors in research on responsible and sustainable innovations.

No.	Author	Institution	Country	Publications		Citations		
				N	%	N	%	h
1.	Blok V.	Wageningen University and Research Center	Netherlands	15	1.39	164	1.52	7
2–3.	Fisher E.	Arizona State University	United States	14	1.29	277	2.57	7
2–3.	Owen R.	University of Bristol	United Kingdom	14	1.29	993	9.20	10
4–5.	Macnaghten P.	Wageningen University and Research Center	Netherlands	9	0.83	771	7.15	6
4–5.	Özdemir V.	Mary Ann Liebert, Inc.OMICS: A Journal of Integrative Biology	United States	9	0.83	73	0.68	6
6–8.	Guston D.H.	Arizona State University	United States	8	0.74	152	1.41	5
6–8.	Smith A.	University of Sussex	United Kingdom	8	0.74	742	6.88	7
6–8.	Swierstra T.	Maastricht University	Netherlands	8	0.74	51	0.47	4
9–11.	Flipse S.M.	Delft University of Technology	Netherlands	7	0.65	43	0.40	4
9–11.	Quist J.	Delft University of Technology	Netherlands	7	0.65	230	2.13	4
9–11.	Stilgoe J.	University College London	United Kingdom	7	0.65	776	7.19	6

Source: Own study based on data retrieved from the Scopus database (accessed 27 May 2018).

In terms of the number of published articles, the most prolific author is V. Blok from Wageningen University and Research Center (15 articles), then E. Fisher from Arizona State University (14 articles) and R. Owen from the University of Bristol (14 articles). All of the aforesaid authors in their works discuss the framework for the responsible innovation concept. In his papers, V. Blok is mainly focused on providing the framework for responsible research and innovation, with particular stress on the challenges, insights, and perspectives of this concept. Among his scientific interests one can find the issues related to socio-ethical factors of innovations and their impact on society as well as the environment. R. Fisher from Arizona State University studies policy of science and technology, including the multi-level governance of new emerging technologies. In line with other leading researchers of responsible innovations, in his papers Fisher provides a conceptual understanding of changing relationships between science and society. He focuses on public policy demands for and practitioner responses to interdisciplinary collaborations between science and the humanities in order to enhance societal responsiveness. Also, R. Owen concentrates on the concept of responsible innovations. He highlights the necessity to include ethics issues into the governance of innovations and new technologies, as well as the need to engage society while managing innovation processes to enhance the ability of innovators to take responsibility for the future of this society. R. Owen is the most cited author (993 times). The second in terms of the citations number is J. Stilgoe from University College London, who published seven articles, cited 776 times. Co-working with R. Owen and P. Macnaghten, J. Stilgoe also explains the idea and complexity of the responsible research and innovation concept. P. Macnaghten from Wageningen University and Research Center, who is the next in order with the number of published articles (9), cited 771 times, deals with the issues related to the governance of science and technology and societal engagement. Noteworthy is also A. Smith from the University of Sussex, who published eight articles, cited 742 times. In his papers, Smith, similar to other most productive authors identified in Table 6, considers the politics and governance of innovation for sustainability. His research is of interdisciplinary character and draws upon theories and methodologies from sociology, political science, innovation studies, and science and technology studies. In Smith's scientific considerations one can find a particular field of interest regarding grassroots innovation for sustainability. The researcher seeks to understand the processes by which groups in civil society create and support innovations that seek to transform dominant social, economic and technological systems.

The most productive institution in the field i.e., the Delft University of Technology is represented by S. M. Flipse (cited 43 times) and J. Quist (cited 230 times), who published seven papers per person. Flipse's works focus mainly on interaction design for responsible innovation management. In his papers, Flipse stresses that four dimensions of responsible innovations (anticipation, reflection,

deliberation, and responsiveness) require communication and collaboration of several market players. He concentrates on exploring how scientists and engineers can collaborate with other actors, in a functional way, thereby also functionally shaping responsible innovation practices. Also, J. Quist discusses the sustainable innovation concept. His works refer to the issues of business models for sustainable innovation, stakeholder inclusion and providing a methodological framework as well as participatory tools for this issue.

Having identified the key contributors among nations, institutions, source titles and authors, subject area profiling is the next step to map the research field. Its aim is to discover and portray the diversity and the multidimensionality of studies related to the issues of responsible and sustainable innovations.

## 5. Subject Area Profiling

The research output related to responsible and sustainable innovations is distributed over 26 subject areas. The highest number of publications is indexed in such areas as: Business, Management and Accounting (491), Engineering (279), Social Sciences (270), Environmental Science (206), Energy (144), Decision Sciences (137), Computer Science (129), Economics, Econometrics and Finance (108). All remaining areas include: Arts and Humanities (84), Medicine (75), Biochemistry, Genetics and Molecular Biology (46), Agricultural and Biological Sciences (38), Chemistry (38), Materials Science (36), Psychology (26), Chemical Engineering (23), Nursing (21), Earth and Planetary Sciences (14), Physics and Astronomy (14), Pharmacology, Toxicology and Pharmaceutics (10), Immunology and Microbiology (6), Multidisciplinary (6), Neuroscience (3), Veterinary (2), Health Professions (1). In order to thoroughly explore diversity and multidimensionality of research related to the issues of responsible and sustainable innovations research output in leading areas will be studied through the lens of key journals and authors, and core references. These leading areas under the study include Business, Management and Accounting, Engineering, Social Sciences, and Environmental Science.

### 5.1. Journal—Subject Area Profiling

Identifying top source titles in each of the leading subject areas is the first step of the subject area profiling. In Table 7, we present the topmost productive journals distributed by a subject area.

**Table 7.** Topmost productive journals by subject area.

Subject Area	Journals
Business, Management and Accounting (491)	Journal of Cleaner Production (63) Journal of Responsible Innovation (59) Science and Engineering Ethics (15) International Journal of Innovation and Sustainable Development (14) Responsible Innovation 2: Concepts, Approaches and Applications (14)
Engineering (279)	Journal of Cleaner Production (63) Responsible Innovation 1: Innovative Solutions for Global Issues (9) International Journal of Sustainable Engineering (7) ASEE Annual Conference and Exposition Proceedings (5) IEEE International Engineering Management Conference (5)
Social Sciences (270)	Sustainability Switzerland (17) Science and Engineering Ethics (15) Responsible Innovation 2: Concepts, Approaches and Applications (14) Business Strategy and the Environment (11)
Environmental Science (206)	Journal of Cleaner Production (63) Sustainability Switzerland (17) Business Strategy and the Environment (11) Energy Policy (8)

Source: Own study based on data retrieved from the Scopus database (accessed 27 May 2018).

*Journal of Cleaner Production* is the most universal and top-ranked journal in terms of the number of publications in the following three areas: Business, Management and Accounting, Engineering, and Environmental Science. *Journal of Responsible Innovation* is the second leading source title as regards the number of publications. All the publications (59) included in this journal relate to the subject area of Business, Management and Accounting only. Two other source titles, i.e., *Science and Engineering Ethics* and *Responsible Innovation 2: Concepts, Approaches and Applications*, bridge the areas of Business, Management and Accounting, and Social Sciences. Social Sciences and Environmental Science have two journals linking these two areas, i.e., *Sustainability Switzerland* (3rd position in the ranking of topmost productive titles) and *Business Strategy and the Environment*. All other source titles are specific to relevant areas. Engineering is found to be less interrelated with other subject areas.

### 5.2. Journal—Subject Area Profiling

Table 8 shows the most prolific authors identified in each of the leading subject areas in the field.

**Table 8.** Topmost productive authors by subject area.

Subject Area	Authors
Business, Management and Accounting (491)	Blok V. (12), Fisher E. (9), Owen R. (6), Swierstra T. (6), Flipse S.M. (5), Guston D.H. (5), Huisingh D. (5), Macnaghten P. (5), Quist J. (5)
Engineering (279)	Huisingh D. (5), Quist J. (5), Lockton D. (4), Silvester S. (4), Som C. (4)
Social Sciences (270)	Blok V. (5), Fisher E. (5), Flipse S.M. (5)
Environmental Science (206)	Blok V. (6), Huisingh D. (5), Quist J. (5)

Source: Own study based on data retrieved from the Scopus database (accessed 27 May 2018).

In each of these areas, one can come across top-ranked authors conducting research on responsible and sustainable innovations. Many of the most prolific authors categorized in the area of Business, Management, and Accounting are found to contribute to other subject areas, too. V. Blok is the most prolific author in three areas, i.e., Business, Management and Accounting, Social Sciences, and Environmental Science. Other authors sharing their research between Business, Management and Accounting, and Social Sciences are E. Fisher and S.M. Flipse. The works by D. Huising and J. Quist bridge the area of Business, Management and Accounting with Engineering and Environmental Science. Summing up, a relatively high level of homogeneity is observed as regards the distribution of top authors through leading subject areas in research on responsible and sustainable innovations.

### 5.3. Core References—Subject Area Profiling

Core references analysis regards those works that have received the highest number of citations. Such references in relation to identified subject areas have been presented in Table 9. As shown in Table 9, we have distinguished four subject areas: Business, Management, and Accounting (BusMan&Acc), Engineering (Eng), Social Sciences (SocSci), and Environmental Science (EnvSci).

The analysis of core references related to the identified subject areas allows to state that the work of Boons and Lüdeke-Freund [2] is shared among three areas: Business, Management and Accounting, Engineering, Social Sciences, and Environmental Science. In their paper, Boons and Lüdeke-Freund [2] consider how the issues of business models and sustainable innovations interrelate. They explore these links by proposing a set of normative requirements for a business model to contribute to market sustainable innovations as well as pointing out some barriers in marketing sustainable innovations. We assume that due to the fact that the authors take into account technological, organizational, and also social innovations, their paper is often cited in the three above mentioned subject areas. The conducted analysis of core references studied by subject areas shows that there are five works shared by two areas. The most cited of such papers is the work of Smith et al. [30]. It is shared by the areas of Business, Management and Accounting, and Engineering. Smith et al. [30] provide a review paper regarding a multi-level perspective on socio-technical transitions within innovation studies. On the

other hand, the paper by Johnson et al. [31] is often cited both in the literature of Business, Management, and Accounting as well as Social Sciences. This results from the fact that in their work Johnson et al. [31] propose a planning model for sustaining innovations within an organization, community, and the state level. Thus, they highly focus on the social aspects of their research.

**Table 9.** Core references by a subject area.

Article	Citations	Subject Areas			
		BusMan&Acc	Eng	SocSci	EnvSci
Schot and Geels [29]	465	X			
Smith et al. [30]	452	X	X		
Stilgoe et al. [14]	325	X			
Boons and Lüdeke-Freund [2]	310	X	X		X
Johnson et al. [31]	202	X		X	
Stirling [32]	300		X		
Boons et al. [33]	179		X		X
Nil and Kemp [34]	176		X		
Owen et al. [35]	254			X	X
Bos-Brouwers [36]	164			X	X
Larson [37]	123			X	
Ozaki [38]	117			X	
Ozaki and Sevastyanova [39]	149				X

Source: Own study based on data retrieved from the Scopus database (accessed 27 May 2018).

Moreover, as identified and shown in Table 9, Engineering and Environmental Science share the work of Boons et al. [33], who study the idea and nature of sustainable innovation and offer a conceptual framework for searching the link between sustainable business models, innovation, and competitiveness. In their paper, the authors provide an overview of innovation definitions and categories with a focus on ecological sustainability. Thus, it is not surprising that the paper is often cited in the field of Engineering and Environmental Science. The authors highlight also that the attributes of sustainable innovations are systemness and radicalness. Taking this perspective, Engineering seems to be the area interested in such an approach.

Finally, we have found two papers that are shared by Social Sciences and Environmental Science. There are works by Owen et al. [35] and Bos-Brouwers [36]. Owen et al. [35] provide a brief historical overview of the responsible (research and) innovation concept and concentrate on its four dimensions. Particularly, they stress the inclusive participation of different actors that allows in embedding research and innovation goals and potential impacts into societal and environmental values. They strongly focus on the fact that innovations should be generated for society and with society. On the other hand, Bos-Brouwers paper [36], also shared by Social Sciences and Environmental Science, points out that sustainable innovations result in positive social and environmental impacts. Presenting the research outcomes from a sample of small and medium enterprises, he argues that many sustainable innovations are directed into improvements of technological processes in the field of eco-efficiency, as well as to lower the cost of production. Thus, one can find here both environmental and social aspects of innovations.

Among the most often cited papers that belong only to one subject area, a paper of Stilgoe et al. [14] is worth noticing (325 citations). This work is assigned to the Business, Management and Accounting subject area. The authors of the paper develop a framework for the responsible (research and) innovation concept, highlighting the unpredictability of innovations that are inherently linked into its collective nature. The authors stress the complexity of the responsible (research and) innovation concept by explaining its dimensions in detail and indicating the techniques and approaches to make them alive. They also stress that the conception of responsibility should be built on the understanding that science and technology are socially as well as politically constituted.

The procedure of research profiling is completed with topic profiling aimed at searching for predominant themes in the field by analyzing keywords from the perspective of authors, journals, subject areas, and core references.

## 6. Topic Profiling

### 6.1. General Topic Profiling and Author—Topic Profiling

Topic profiling is based on the keywords used by the authors in their papers and informs about the most important research patterns and points of view of the authors. Table 10 shows the main keywords used by authors.

First and foremost, the most popular keywords collected in Table 10 relate directly to the issues associated with responsible and sustainable innovations. The leading keywords here are: ‘innovation’, ‘sustainable development’, ‘sustainable innovation’, ‘sustainability’, and ‘responsible innovation’. Other keywords show the relationships between responsible and sustainable innovations with people (human, humans), research, ethics, and technology. Some interesting tendencies may be also observed while studying the research interests of leading authors. For instance, Owen [15,40] focuses his research on the issues related to innovations, responsible innovations, and research. Piccinno et al. [41] deal with sustainable development and sustainable innovations and Flipse et al. [42] are oriented to human and technological dimensions.

**Table 10.** Top 10 most often cited keywords.

Keywords	Authors
Innovation (281)	Owen R. (4), Smith A. (4), Edgeman R. (3), Eskilden J. (3), Kern F. (3), Raven F. (3), Riel A. (3), Verhees B. (3), Wiek A. (3), Xiang G. (3)
Sustainable development (231)	Hischier R. (4), Huisingh D. (4), Piccinno F. (4), Seeger S. (4), Smith A. (4), Som C. (4)
Sustainable innovation (158)	Som C. (5), Hischier R. (4), Piccinno F. (4), Quist J. (4), Seeger S. (4),
Sustainability (143)	Foley R.W. (4), Bossink B.A.G. (3), Edgeman R. (3), Eskilden J. (3), Huisingh D. (3), Wiek A. (3)
Responsible innovation (129)	Blok V. (6), Owen R. (5), Fisher E. (5), Macnaghten P. (5), Flipse S.M. (4), Foley R.W. (4), Stilgoe J. (4), Wiek A. (4), Özdemir V. (4)
Human (73)	Özdemir V. (4), Osseweijer P. (5), Dove E.S. (4), Flipse S.M. (4), Llerena A. (4), Shrivastava S. (4), Warnich L. (4)
Humans (52)	Osseweijer P. (4), Bredenoord A.L. (3), Flipse S.M. (3), van der Sanden M.C.A. (3), Özdemir V. (3)
Research (40)	Owen R. (3), Macnaghten P. (2), Stilgoe J. (2)
Ethics (39)	Bredenoord A.L. (3), Flipse S.M. (3), Osseweijer P. (3), van der Sanden M.C.A. (3)
Technology (39)	Flipse S.M. (2), Kirna A.H. (2), Osseweijer P. (2), van Berkel R. (2), van der Sanden M.C.A. (3)

Source: Own study based on data retrieved from Scopus database (accessed 27 May 2018).

### 6.2. Source Title—Topic Profiling

The topmost prolific source titles are focused on some particular topics. Table 11 shows the most often cited keywords by source title.

The papers published by the *Journal of Cleaner Production* are mainly focused on sustainable development, sustainable innovations, and innovations. Other topics studied in the journal are related to life-cycle and its assessment, product design and production engineering, and environmental impact. However, sustainability is a general ‘umbrella’ for all these topics. The leading topics in the *Journal of Responsible Innovation* are responsible innovation, responsible research, and general responsibility.



More specific topics are focused on technology assessment, synthetic biology, governance, and public engagement. Both the aforementioned source titles combine the issues of technology in specific sectors with the ideas of responsibility and sustainability. Other journals contributing to the field with a smaller number of papers show similar tendencies. The most often studied topics in *Sustainability Switzerland* are innovation, sustainability, sustainable innovation, responsible research and innovation, and corporate social responsibility. In *Science and Engineering Ethics*, ethics is the leading keyword that is linked with responsible innovation, social innovation, ethics research and human (humans). *International Journal of Innovation and Sustainable Development* studies are focused on sustainable innovations, eco-innovations, environmental innovations, open innovations, and sustainable development. *Responsible Innovation 2: Concepts, Approaches and Applications* are centered on responsible innovation and responsibility. Additional research areas are connected with justice, stakeholders, and engagement. Finally, *Responsible Innovation: Managing the Responsible Emergence of Science and Innovation in Society* is focused mostly on responsible innovation. In general, it can be observed that the source titles under the study are centered on very similar research areas.

**Table 11.** Topmost often cited keywords by a source title.

Journal/ Source Title	Keywords
Journal of Cleaner Production (64)	sustainable development (46), sustainable innovation (28), innovation (11), life-cycle (10), life cycle assessment (10), sustainability (10), societies and institutions (9), product design (8), environment impact (7), production engineering (7), sustainable business (7)
Journal of Responsible Innovation (59)	responsible innovation (28), technology assessment (10), synthetic biology (5), governance (4), innovation (4), responsibility (4), responsible research and innovation (4), public engagement (3), sustainability (3)
Sustainability Switzerland (17)	innovation (15), sustainability (9), sustainable innovation (6), corporate social responsibility (5), responsible research and innovation (5), sustainable development (4), entrepreneur (3), organizational framework (3), RRI (3), responsible innovation (3)
Science and Engineering Ethics (15)	ethics (11), responsible innovation (10), human (9), humans (9), science (7), social responsibility (6), technology (6) ethics research (5), research ethics (5), social behavior (5)
International Journal of Innovation and Sustainable Development (14)	sustainable innovation (7), innovation (4), eco-innovation (2), environmental innovation (2), open innovation (2) social systems theory (2), sustainable development (2)
Responsible Innovation 2: Concepts, Approaches and Applications (14)	responsible innovation (6), justice (2), responsibility (2), stakeholder engagement (2)
Responsible Innovation: Managing the Responsible Emergence of Science and Innovation in Society (14)	responsible innovation (7)

Source: Own study based on data retrieved from the Scopus database (accessed 27 May 2018).

### 6.3. Subject Area—Topic Profiling

Table 12 presents the most often cited keywords that have been used in the analyzed literature categorized by a subject area.

Generally, all the subject areas share their interest in such themes as innovation, sustainable development, sustainable innovation, responsible innovation, and sustainability. However, the analysis of data collected in Table 12 shows some aspects of research typical of relevant subject areas. For Business, Management and Accounting it is about technology, societies and institutions, planning and managing in the industrial context. Engineering is also oriented to product design, life cycle management,

competition, and environmental impact. Social Sciences balance the focus on humanistic and technological aspects. Life cycle management, climate changes, and environmental impact are the issues characteristic of the research categorized within the subject area of Environmental Science.

**Table 12.** Topmost often cited keywords by a subject area.

Subject Area	Keywords
Business, Management and Accounting (491)	innovation (125), sustainable development (114), sustainable innovation (87), responsible innovation (74), sustainability (64), technology (21), competition (20), societies and institutions (18), industry (16), industrial management (15), planning (15), research (15)
Engineering (279)	sustainable development (119), innovation (73), sustainable innovation (65), sustainability (27), product design (25), societies and institutions (22), life cycle (18), competition (17), design (15), environmental impact (15)
Social Sciences (270)	innovation (90), sustainability (60), sustainable development (47), responsible innovation (44), sustainable innovation (34), ethics (21), human (15), humans (15), responsible research and innovation (13), technology (11)
Environmental Science (206)	sustainable development (84), innovation (78), sustainability (58), sustainable innovation (52), environmental impact (14), life cycle assessment (14), life cycle (13), Europe (13), societies and institutions (11), climate change (10), decision making (10), responsible innovation (10)

Source: Own study based on data retrieved from the Scopus database (accessed 27 May 2018).

#### 6.4. Core References—Topic Profiling

As already said, core references analysis regards those works that have received the highest number of citations. Such references in relation to identified topics are presented in Table 9. As shown in Table 13, we identified five such topics: innovation, sustainable development, sustainable innovation, sustainability, and responsible innovation.

**Table 13.** Top 5 most often cited core references by topic.

Keywords	Core References
Innovation (281)	Schot and Geels [29], Stilgoe et al. [14], Owen et al. [35], Johnson et al. [31], Boons et al. [33]
Sustainable development (231)	Smith et al. [30], Boons and Lüdeke-Freund [2], Boons et al. [33], Nill and Kemp [34], Bos-Brouwers [36]
Sustainable innovation (158)	Smith et al. [30], Boons and Lüdeke-Freund [2], Boons et al. [33], Ozaki [38], Leach et al. [43]
Sustainability (143)	Schot and Geels [29], Johnson et al. [31], Bos-Brouwers [36], Larson [37], Hellström [44]
Responsible innovation (129)	Stilgoe et al. [14], Owen et al. [15], Guston [45], Owen and Goldberg [40], Hellström [46]

Source: Own study based on data retrieved from the Scopus database (accessed 27 May 2018).

The findings presented in Table 13 prove that several particular topics share some works. The papers shared by the three topics are done by Boons et al. [33] and Bos-Brouwers [36]. Also, there are several papers shared by two topics. These are Schot and Geels [29], Stilgoe et al. [14], and Johnson et al. [31]. The other core references identified in Table 13 have been assigned just to one topic.

Thus, in regard to the issue of innovation, already described works of Stilgoe et al. [14] as well as Owen et al. [35] provide the framework for the responsible (research and) innovation concept,

pointing out the contemporary context in which innovations occur nowadays. Also mentioned before Boons et al. [33] present the idea of sustainable innovation linking it with the issue of a business model. Moreover, Johnson et al. [31], recalled before, discuss the definition of sustainability as well as present a prevention-focused sustainability-planning model for sustaining innovations highlighting key factors regarding sustainable innovations and the problems of dealing with them. As said before, the authors discuss these issues in relation to the organization, community and state level. On the other hand, Schot and Geels [29] suggest that sustainable innovations might be facilitated by creating technological niches. Thus, they follow the problem of strategic niche management, presenting how concepts and ideas have evolved over time.

Among the most often cited papers addressing the topic of sustainable innovation, Smith et al. [30] contribute by introducing a framework of multi-level perspective on sustainability transitions related to innovations, particularly stressing further research areas. Boons et al. [33] explain the idea and the nature of sustainable innovations. Furthermore, Boons and Lüdeke-Freund [2] contribute to the field by confronting the topic of sustainable innovation with the business model perspective. In their paper, the aforesaid authors provide a review of the literature on the interrelations between business models and sustainable innovations. Among the papers concentrating on sustainable innovation, there are some authors highlighting the issues of the environment as well as other global challenges of the 21st century. Thus, the problems of Sustainable Development Goals related to climate change, resource depletion, food production problems and poverty alleviation, aging societies, etc., are the topics of the paper by Leach et al. [43]. They argue that accomplishing these goals requires a new approach to innovations that involves different actors and processes within an inclusive, multi-scale innovation policy. Ozaki [38] deals with environmental innovations, focusing mostly on green electricity. She analyses the problem from consumers' point of view by posing a question concerning factors motivating consumers to adopt and pay for sustainable innovations.

Among the most often cited core references identified in relation to the topic of sustainable development, again Smith et al. [30], Boons et al. [33], as well as Boons and Lüdeke-Freund [2], have been found. Additionally, Bos-Brouwers [36] who was already mentioned before, explores the possibility of generating innovation oriented towards sustainable development. An interesting problem is discussed by Nill and Kemp [34] who explore the evolutionary approaches for sustainable innovation policies. They propose a framework integrating the strategic niche management approach, transition management approach and time strategies approach to contribute to sustainable development, particularly focusing on their strengths and specific problems.

Among the publications regarding the topic of sustainability, the most often cited again are the papers of Schot and Geels [29], Johnson et al. [31], Bos-Brouwers [36]. In addition, Larson [37] presents an interesting example of environmental and sustainability considerations integration into business strategy. Hellström [44] in his work studies environmentally sustainable innovation from the perspective of innovation theories in order to establish successful ways forward.

As far as the topic of responsible innovation is concerned, the most often cited works belong to already mentioned Stilgoe et al. [14] and Owen et al. [15]. Considering the issues of responsible innovation, some authors point out the problem of anticipatory governance necessary to promote the emergence of responsible innovations. These aspects are highlighted by Owen and Goldberg [40] who focus on the necessity of anticipating and understanding the wide potential impacts and associated with new products and technologies. The aforementioned authors stress the need for continuous reflectivity and anticipation to support the decisions shaping the trajectory of innovation in time. Also Guston [45] discusses the issue of anticipatory governance based on reflection of scientists, policymakers and other public players who share responsibility within the innovation process. In a similar vein, Hellström [46] raises the problem of the risk associated with systemic innovation. He explores how new complex technological systems generate risk or negative synergies on several levels of society.

## 7. Discussion

### 7.1. *Overlapping Concepts*

The analysis of literature on responsible innovation proves that there are different approaches to explain and define it. Several authors describe this new concept as Responsible Research and Innovation, responsible innovation, or sustainable innovation. We start our study by following von Schomberg [47] who provides the commonly used definition of Responsible Research and Innovation (RRI). According to aforesaid author, RRI is “a transparent, interactive process by which societal actors and innovators become mutually responsive to each other with a view to the (ethical) acceptability, sustainability and societal desirability of the innovation process and its marketable products (in order to allow embedding of scientific and technological advances in our society)” [47] (p. 9). Responsible Research and Innovation has been also defined in the European Union documents which say that RRI is “an on-going process of aligning research and innovation to the values, needs and expectations of society” [48] (p. 1).

In line with the abovementioned, a central point of the RRI idea is that it embeds responsibility at very early stages of research and innovation by emphasizing research integrity, several institutional environments, and dynamics with a strong bearing on the societal impact of business [49,50]. The concept points out that research and innovation can be responsible in many ways: environmentally, ethically, as well as socially or politically. Thus, it highlights the necessity of collaboration of various market players responsible for research and innovation, such as research founders, policymakers, business entities, etc., to promote a transition to mutual responsibility [51]. Dove and Özdemir [52] highlight that the RRI concept is multidimensional and complex, and thus it needs including natural sciences, social sciences, and humanities as well as political forces that influence the structure of knowledge-based innovations into collaboration. Moreover, the RRI approach emphasizes the cooperation of different groups of stakeholders in order to come up with sustainable solutions focused on ethical acceptability, sustainability and societal desirability of the innovation process and its marketable outcomes that influence society [9,15,53]. Summing up, RRI focuses on incorporating responsibility into the DNA of contemporary companies and requires that the products or outcomes of innovation meet deeply held moral values [54,55].

Following von Schomberg’s explanation of RRI, Owen, Stilgoe, and Macnaghten, provide their definition of the term ‘responsible innovation’. They highlight that responsible innovation refers to taking care of the future through collective stewardship of science and innovation in the present [15]. On the other hand, Noorman, Swierstra, and Zandbergen emphasize that responsible innovation is a normative conception of technology development, which hopes to improve upon prevailing practices [56]. While considering the analyzed concept, several authors highlight that stakeholder engagement is the key characteristic of responsible innovation [56–61]. Stakeholders together with the members of the public are involved upstream in the innovation process and encouraged to deliberate on the features and uncertainties related to the innovation [14,18]. Stakeholder and public members’ inclusion are perceived as a strategy to become mutually responsive to each other and anticipate research and innovation results in the context of serious social and environmental challenges (climate change, resource depletion, poverty alleviation, aging societies, etc.) for which they share responsibility [57]. This collective responsibility enables to control and direct innovation into ethically acceptable, societally desirable, and sustainable direction [9,56]. Blok and Lemmens [58] stress that, in the concept of responsible innovation, responsibility is perceived as the extension to ‘regular innovation’ pointing out stakeholder involvement particularly regarding ethical and societal aspects of innovation. They highlight that due to this extension, the innovation process is better enabled to balance economic, socio-cultural as well as environmental interests.

Burget, Bardone, and Pedaste [62], who analyzed the matter of responsible innovation based on the review of 235 RRI-related articles, notice that policymakers and scientists define and conceptualize responsible innovation in different ways. Having reviewed several conceptual approaches, the aforesaid

authors propose the following definition: “Responsible innovation is essentially an attempt to govern research and innovation in order to include all the stakeholders and the public in the early stages of research and development. The inclusion of different actors and the public is, in turn, meant to increase the possibilities to anticipate and discern how research and innovation can or may benefit society as well as prevent any negative consequences from happening” [62] (p. 15).

In the relevant literature, the idea of responsible innovation is explained also in terms of four dimensions, pointing out that to innovate responsibly requires to be anticipatory, reflective, inclusively deliberate, and responsive [14,63]. In this context, responsible innovations, considered as an outcome of smart planning and actions, are based on motivations related to the company’s influence on the workplace, society and the environment. Anticipation means describing and analyzing the intended but also potentially unintended impacts related to economic, social or environmental aspects that may arise in future related to the innovation that is to be developed [14]. This requires that innovators understand the dynamics shaping innovation [62]. Thus, anticipation refers to asking questions: ‘What if ...?’ and ‘What else might it do?’. This refers to another responsible innovations’ dimension that is reflectivity. Being reflective requires analyzing motivations and potential impacts of innovations, taking into account both what is known but also what is uncertain and unknown. It also refers to being aware of the limits of knowledge and the fact that one’s reality might not be universally held [14,64]. Inclusion and deliberation are focused in all works on responsible innovation, as they are related to other dimensions [62]. Inclusion and deliberation refer to upstream engagement of stakeholders and public members in the discussions aimed at analyzing social, political, environmental, as well as ethical implications that the development of the innovation could bring [14,65]. The fourth dimension of responsible innovation is responsiveness. It is about having the capacity to change the shape of innovation or its direction responding to values of stakeholders and the wider public [18]. Here, it seems necessary to say that care and responsiveness are two dimensions of prospective responsibility [20,66–69]. They allow market players to reflect on the purposes and outcomes of science and innovation. Responsiveness is a key dimension allowing several options to be kept open [32,70]. The company’s responsiveness means being adaptive, responding to the views and perspectives of the public and stakeholders. In other words, it refers to being deliberative. This means that responsible innovations are the outcome of continuous dialogue with various groups of stakeholders which shows the features of the organizational learning process-oriented to dynamic adjustment to changing needs.

An extensive literature review on responsible and sustainable innovation allows to state that sustainable innovation overlaps conceptually with responsible innovation [71,72]. Sustainable innovations, like responsible innovations, are intended to respond to contemporary societal and environmental challenges. Furthermore, Lubberink et al. as well as Adams et al. highlight that both responsible and sustainable innovations are focused on sustainability as a desirable outcome of innovation [71,72]. Adams et al. also state that sustainable innovations require the collaboration of a complex network of stakeholders. This enables engagement in dialogue necessary to acquire the knowledge needed to generate responsive solutions [71]. Moreover, both responsible and sustainable innovations take into account economic, environmental as well as social dimension while considering innovation outcomes [18].

An interesting point of view is presented by Dyck and Silvestre who distinguish between ‘sustainable innovation 1.0’ and ‘sustainable innovation 2.0’. According to aforesaid authors, the term ‘sustainable innovation 1.0’ refers to innovations that are aimed at both reducing an organization’s negative socioecological externalities and enhancing their financial interests. On the contrary, as ‘sustainable innovation 2.0’ they describe innovations that are driven by the social and ecological returns they will generate. In other words, Dyck and Silvestre highlight that the ultimate goal of ‘sustainable innovation 2.0’ is to improve overall social and ecological well-being. This type of innovation enables organizations to enhance positive socio-ecological externalities while remaining financially viable but not needing to maximize financial returns [73].

Taking the corresponding perspective in analyzing the idea of sustainable innovation, Boons, Montalvo, Quist, and Wagner propose a general explanation stating that sustainable innovation is an innovation that improves sustainability performance in terms of ecological, economic, and social criteria. They propose a definition of sustainable innovation saying it is “a process where sustainability considerations (environmental, social, and financial) are integrated into company systems from idea generation through research and development (R&D) to commercialization. This applies to products, services, and technologies, as well as to new business and organizational models” [33] (p. 4). Taking such a point of view, sustainable innovation will have different meanings and characteristics in different contexts. Additionally, the aforementioned researchers argue that due to the fact that responsible innovations go beyond regular product and process innovations and are future-oriented, they are characterized by systemness and radicalness.

In the similar vein, Bos-Brouwers, and Calik and Bardudeen claim that as ‘sustainable’ one may call an innovation in which the improvement of products, services, technological or organizational processes commercialized or internally implemented, not only brings in an improved economic performance but also enhances environmental and social performance. Thus, both in the short and long term, sustainable innovations have the capacity to generate positive social and environmental impacts [36,74,75]. In addition, Tello and Yoon particularly emphasize the care of resource deployment, pointing out that sustainable innovation can be defined as new products, processes, services, and technologies which contribute to the development and well-being of human needs and institutions by respecting the worlds’ natural resources and regenerative capacity [76].

An interesting approach is proposed by Hargadon [21]. According to him, sustainable innovation means two things. First, following the definition of Bruntland Commission, he argues that the term refers to generating, developing and launching new products and processes which “meet the needs of the present without compromising the ability of future generations to meet their own needs” [77]. In other words, the term ‘sustainable innovation’ refers to the new products and processes that consume fewer environmental resources, foster people’s health as well as are affordable for both consumers and producers. Secondly, the aforesaid author claims that sustainable innovation also means building an organization that is capable of sustaining the pace of innovation over several years (ten or more). He proposes his second explanation with the comment that a single innovation will neither support a company nor drive fundamental change within the industry [21]. In other words, the implementation of sustainable innovations expresses the care of enterprises for the future manifested in making business decisions based on anticipation and reflection made today.

However, while considering the matter of sustainable innovation, Zeng et al. stress that it is difficult to achieve within a single organization [78]. The aforementioned authors highlight the necessity of creating sustainable innovation ecosystems formed by continuous interactions among organizations, policies, society and the environment. In their considerations, they refer to the open innovation concept [79,80], pointing out that nowadays most industries adopt an open approach to innovating [78]. This enables identifying future customer needs, as well as scanning for disruptions through foresight networks [78,81].

Finally, some authors indicate sustainable innovations as a concept consisting of several approaches to sustainability-related (sustainability-oriented) innovations, like green innovations, eco-innovations, environmental innovations, grass-root innovations, socially-responsible innovations, etc. [28,71,82–87]. In the literature the term environmental innovation (short: eco-innovation) is defined very broadly and regards all measures of relevant actors (firms, politicians, unions, associations, churches, private households) that develop new ideas, behavior, products, and processes, apply or introduce them and that contribute to a reduction of environmental burdens or to ecologically specified sustainability targets [82,88]. On the other hand, the term ‘grassroots innovations’ is used to describe networks of activists and organizations generating novel bottom-up solutions for sustainable development. These are the solutions that respond to the local situation and the interests and values of the communities involved. A highlighted by Seyfang and Smith [83], in contrast to mainstream

business greening, grassroots initiatives operate in civil society arenas and involve committed activists experimenting with social innovations as well as using greener technologies. Social innovations (socially-responsible innovations) seem to be the most multi-dimensional category of abovesaid. It is characterized by several approaches in the literature. Despite different approaches, the common point in defining this category refers to the fact that social (socially-responsible) innovations play a significant role in meeting social needs and solve several social problems both in organizations and society [89–92].

## 7.2. Research Patterns

Having discussed central ideas of the overlapping concepts of responsible research and innovations, responsible innovations or sustainable innovations, the next step is to provide the critical assessment of the reasons for the scholarly research to have developed along with certain patterns. In regard to research patterns in the field, our particular interest is focused on: (1) the dominant position in the field occupied by the Netherlands, Dutch universities and researchers, (2) the leading position of *Journal of Cleaner Production* and *Journal of Responsible Innovation* among most productive source titles in the field, (3) multidimensionality of research perspectives in the field.

The dominant position in the field occupied by the Netherlands, Dutch universities and researchers imposes the question why is it so? Of course, there are several reasons for such a situation. However, the first reason for focusing on innovations (also responsible innovations) both in research and practice seems to be the fact that the Netherlands is a country with low land and flat geography, known as the safest delta in the world, with 26% of the country area and almost half of its population are located below the sea level. Moreover, despite its size, it is one of the most densely populated nations in the world. All circumstances that make the Netherlands a low-lying, flood-prone country caused the necessity for the Dutch government as well as the citizens to be innovative in protecting the land against flooding and to secure freshwater supplies [93].

Secondly, as pointed out by Hofstede [94], the Netherlands is a Feminine society which means that the dominant values in society are caring for others and quality of life. In Feminine countries, it is important to keep the life/work balance and to make sure that all are included. Conflicts are resolved by compromise and negotiation and the Dutch are known for their long discussions until consensus has been reached [95]. Moreover, tough life conditions related to the country situated below the sea level forced people to work together in order to reclaim the land from the sea. In turn, nowadays the Netherlands is relatively unique in practicing a strong consensus-driven approach to decision making. As far as the field of responsible innovation is concerned, it has to be highlighted that in the Netherlands, there is a long tradition of negotiations: between public organizations, enterprises, trade unions, consumer pressure groups as well as NGOs [96]. Additionally, the Netherlands has an egalitarian society which results in thinking that everyone is equal and should be treated accordingly [97]. This virtue directly refers to the issue of stakeholders' engagement while anticipating innovations' impact on the society or environment. It also enables firms and citizens to better understand the main idea of responsible innovation concept.

Another explanation for the dominant position of Dutch researchers and universities in the field of responsible innovation regards the configuration of the Dutch research eco-system. A strong Dutch science base, world-class companies combined with government support policies result in an ecosystem with strong linkages between innovation partners. Dutch research eco-system fosters the development of innovations (and focuses on responsible innovations) as it involves different entities such as universities and research institutes, government policymakers, companies, civil society organizations, and financial institutions. The main cornerstones of Dutch innovation research ecosystem are: interconnections and networking between participants, sharing and creating of knowledge and technology, providing diversity in financial sources for partners in innovation, and boosting the business climate [98]. Thanks to having such a peculiar configuration of the innovation eco-system, Dutch enterprises are among the world's leading innovators with strong technological capabilities and performance [99]. The Netherlands' innovative top sectors are among the world's best. The country's top

nine sectors include: horticulture and propagation materials, agri-food, water, life sciences and health, chemicals, high tech, energy, logistics, and creative industries [100]. All the abovementioned sectors are closely related to the concept of responsible innovations that focuses on providing new products and processes that generate profits and at the same time are socially and environmentally accepted.

Another reason for the dominant position in the field occupied by the Netherlands, Dutch universities and researchers, refers to the fact that the country has very strong universities as reflected in the number and quality of scientific publications. Most Dutch universities do very well in international rankings [99]. Thus, Dutch researches follow the new concepts and fields of knowledge developing in the world. The research on responsible innovation issues is so developed in the Netherlands also due to some special governmental funding for research in this area. The field of responsible innovation is of particular interest to The Netherlands Organization for Scientific Research, falling under the responsibility of the Ministry of Education, Culture and Science. The organization implements funding instruments for several fields, among them for responsible innovation domain. The Netherlands Organization for Scientific Research frequently opens new registration rounds for the research in the field of responsible innovation. In addition, the organization has a platform for responsible innovation to provide information, inspiration, and contacts for researchers, companies, government bodies, and societal organizations. The platform focuses on providing researchers with outcomes and experiences from the research programs, that already have been financed. In turn, all participants interested in exploring the field are able to get knowledge about responsible innovations in various areas including life sciences and healthcare, energy transition, agriculture, and food. Additionally, the platform provides guidelines and tools for companies, government bodies, and other stakeholders to implement insights from projects in responsible innovation processes, models for the design process of innovations, and new business models [101].

The leading position of the *Journal of Cleaner Production* and *Journal of Responsible Innovation* among the most productive source titles in the field is the next pattern to be noticed while discussing the development of research on the concepts of responsible and sustainable innovations. What are the reasons for such achievements? In our opinion, the attention should be given to three following aspects: high quality and very good matching of the scopes of these source titles with the issues of responsible and sustainable innovations, openness for research perspectives from various subject areas, and networking with leading research institutions in the field.

The *Journal of Cleaner Production* is focused on the concept of cleaner production which “aims at preventing the production of waste while increasing efficiencies in the uses of energy, water, resources, and human capital” [102]. The scope of the *Journal of Cleaner Production* encompasses such aspects as sustainability, sustainable development, products, services or consumption which can be considered as the outputs of responsible innovation processes. The high quality of the journal is confirmed by the value of its impact factor (5.561) in the Journal Citation Report (JCR) 2017 by Clarivate Analytics and the Scimago Journal Rank (SJR) indicator as of 2017 (1.467). Since 2006, it has been listed in the first quartile (Q1) of source titles in all four subject areas categories where indexed i.e.: Environmental Science, Engineering (Industrial and Manufacturing Engineering), Energy (Renewable Energy, Sustainability and the Environment), Business, Management and Accounting (Strategy and Management). Therefore, it seems to be obvious that the *Journal of Cleaner Production* belongs to priority choices of scholars searching for a quality source title to submit their papers. This strong position in various subject areas in the field is confirmed by our study of subject area/journal profiling (cf. Table 7).

Responsible innovation is per se the center of gravity for the *Journal of Responsible Innovation*, which is manifested in its source title. What is important the *Journal of Responsible Innovation* invites the studies applying various research perspectives and representing diverse subject areas. The scope of accepted papers ranges from humanities and legal studies through social sciences to science and engineering [103]. In consequence, direct reference to the issue of responsible innovation in conjunction with its multidimensionality predestine the journal to become one of the leading platforms for disseminating research findings in the field. However, what is interesting, in spite of the declared



scope encompassing a wide range of subject areas, the scientific output published in the *Journal of Responsible Innovation* is mainly categorized within the Business, Management and Accounting subject area. The journal is not found among the most influential source titles of other leading subject areas in the field i.e., Engineering, Social Sciences or Environmental Science (cf. Table 7). The network of relations with key actors in the field is another aspect that may be considered among the strengths of the journal and explaining its competitive position. The *Journal of Responsible Innovation* is well-linked with leading research centers in the field. As officially announced on its website, the journal is supported by four following institutions: Arizona State University, the University of Exeter, Maastricht University, and Karlsruhe Institute of Technology (JRI, nd). Three of them are found to be among the most productive organizations in research on responsible and sustainable innovations (cf. Table 4).

Multidimensionality of research perspectives in the field is another feature of scientific production related to responsible and sustainable innovations. As found, the research output is distributed over 26 subject areas ranging from science through social sciences to humanities. The highest number of publications is indexed in such areas as Business, Management and Accounting, Engineering, Social Sciences, Environmental Science, Energy, Decision Sciences, Computer Science, Economics, Econometrics and Finance. Therefore, the question arises: why is the research output in the field distributed among so many subject areas? The concepts of responsible and sustainable innovations respond to up-to-date problems faced by governments, businesses, non-governmental organizations, and individuals. Due to their multidimensionality, the ideas of responsible innovations match to research questions considered as central in many subject areas. Generally, as pointed out in Section 6.3, all the leading subject areas in the field share their interest in such themes as innovation, sustainable development, sustainable innovation, responsible innovation, and sustainability. However, some specificity and particular interests of researchers cultivating in various subject areas may be noticed. For instance, in the areas Business, Management and Accounting it is about technology, societies and institutions, planning and managing in the industrial context. Engineering is also oriented to product design, life cycle management, competition, and environmental impact. Social Sciences balance the focus on humanistic and technological aspects. Life cycle management, climate changes, and environmental impact are the issues characteristic of the research categorized within the subject area of Environmental Science. Due to its inclusiveness, the research field encompasses the research conducted from the perspective of technology (e.g., in subject areas of Engineering and Computer Science), the environment (studies related to Environmental Science and Energy), humans and society (Social Sciences) or economy and business (subject areas related to Economics, Econometrics and Finance as well as Business, Management and Accounting). What are the consequences of this multidimensionality for conducting research?—which is the next issue to be discussed. Firstly, crossing the boundaries between subject areas is observed. In consequence, numerous publications are indexed as referring to more than one subject area. For instance, Business, Management and Accounting shares its research output with 16 other subject areas, including in particular: Engineering (119 publications), Decision Sciences (111), Social Sciences (94), Environmental Science (91), Economics, Econometrics and Finance (83), and Energy (82). Similar tendencies are noticed while analyzing other leading subject areas. Due to strong interrelatedness with other subject areas and a high number of publications, Business, Management and Accounting studies seem to have the potential to play an integrating role in the field. Secondly, diversity of research perspectives due to the extended multidimensionality may result in combining research methodologies typical of related subject areas leading to search for synergy in eclectic research approaches. Nevertheless, so far it is challenging to provide strong evidence to support such an observation, which requires further exploration.

### 7.3. New Research Avenues

Analyzing and discussing existing research patterns in the field is very important to fully understand the situation, its antecedents, and circumstances. However, to make the step forward and

contribute to the development of the field, the identification of unexplored aspects or possible future avenues of research from the perspective of policy, practice, and theory are needed.

While indicating new directions for further research, first of all, it is necessary to point out that responsible research and innovation concept is highly predestinated for cross-disciplinary research and thinking beyond established boundaries. The problem of creating responsible innovations is very complex so it requires complex research-based dialogue between scholars from different disciplines to engage with management research. However, to produce positive outcomes, responsible innovations are to be embedded in the business context. Therefore, one of the new directions for further research in the field is searching for the business context of responsible innovations. The current discussion on responsible innovations is not capturing enough attention from the business community [104]. The concept of responsible innovations has been implemented mainly in the context of publicly funded research with little effort to adapt and operationalize it for the business context [12,104]. Further research requires to focus on drivers of responsible innovation and measures of the outcomes resulting from implementing the responsible innovation concept. In regard to responsible innovation drivers, it is interesting to investigate what are these drivers and under what conditions they will facilitate responsible innovation best. Also the issue regarding the way of measuring responsible innovation in business is of great importance. Van de Poel et al. highlight that the concept of Responsible Research and Innovation needs to be translated into business-relevant key performance indicators [49]. The authors provide methodological steps for developing such key performance indicators. However, the avenue for further research is searching for measuring the returns of responsible research and innovation in the business context. There is still a lack of the works providing such measures as well as the research-based on larger-scale quantitative empirical testing. Search for fact-based evidence in the business context seems to be of high significance for enhancing the managerial practice in firms. In our opinion quantitative research is essential for further development of the concept and its implementation in companies. Also, the commercial dynamics related to responsible innovations are poorly developed in the literature of the field [104]. Thus, this seems to be an interesting path for researchers to follow in the future.

Another issue regarding further research refers to the industry sector and local specific factors regarding implementing the concept of responsible research and innovation in the business context. Sector-specific differences so far have not been taken into account in the research on responsible innovation and in turn some sectors are underrepresented. The sectors most often mentioned in the works on responsible innovation are nanotechnology and ICT [12]. However, singular policy and technological solutions which appear optimal from the global perspective rarely prove viable or desirable in all industries and localities. The differences in sector specificity or different cultural and ecological settings require varied approaches [43]. The insights from other industries and sectors will contribute to developing a better conceptualization of responsible innovation and to distinguishing sector-specific characteristics of its application [12]. Furthermore, such variables as governance structure, company size, organizational culture, leadership or team dynamics require particular attention while conducting research on implementing the responsible innovation concept in the business context. Investigating how abovementioned aspects contribute to responsible innovation will add some new valued for theory of management, the practice of firms as well as policies.

Alternating avenue for further research regarding responsible research and innovation refers to the networked nature of the concept in the business context with a particular focus on value chain issues. Nowadays, there is a considerable agreement among researchers that most firms innovate in networks, cooperating with their supply chain partners. While taking such a perspective, further research should focus on responsibility of individual companies in creating responsible innovations. In our opinion, further research going beyond the implementation of responsible innovation just in individual companies would highly enrich the understanding of complexity and interrelations of firms within their value chains while focusing on responsibility in innovation contexts. This will be a contribution to the development of the theory of management.

Also, the role of business in defining as well as enforcing governance mechanisms, that facilitate responsible innovation, with particular attention on the access and involvement of business in political processes seems to be an interesting direction for further research contributing in terms of policy and practice.

The next avenue for further research in the field refers to the distribution of both commercial and socio-economic benefits of responsible innovation. As there are conflicting interests between several actors related to the innovation process, it seems important to ask the question: who gains and who loses from particular policies and innovations? The significant issues here are the following: what sort of development and responsibility is being pursued, for whom and how what this implies, how such choices are made in relation to what values in a particular social and political context? Thus, monitoring the policy and the process of responsible innovation creation requires keeping the issues of benefits distribution at the center. The research focused on such aspects is of high significance for both policy and practice.

Also, examining the relationship between disruptive and emerging technologies (e.g., robotics, artificial intelligence, synthetic biology, etc.) and society seems to be a promising avenue for further research. An interesting question here regards the challenges for a society that are emerging from the development of new areas of science. While following this research path it seems important to concentrate on the ways of accounting for and managing the risks posed by emerging technologies and building trust towards emerging technologies in the community. Furthermore, while considering the macro-level, it seems interesting to investigate the implications of recent societal developments, such as emerging nationalism or fundamentalism, for responsible innovation. The research could try to provide the answers to the question: how and why can these developments foster or hinder responsible innovation? Abovesaid areas of research also could contribute in terms of theory and policy.

Taking the consumer perspective on responsible innovation also seems to be an interesting direction for further research. The inhibitors to the responsible innovation concept adoption in the industry, such as strong differences among multiple stakeholders, incentives for not sharing information with competitors, limited human abilities to predict all innovation consequences [58], cause responsible innovation to be a costly process. From the firms' perspective, it can be justified only if responsible innovation creates valued attributes that consumers are willing to pay for [105]. Thus, it seems necessary to conduct research aimed at recognizing demands from citizens for responsible innovation. In our opinion, for responsible innovation in order to be financially feasible, further research is required to understand how credence attributes can be marketed to consumers' chains that increase returns to producers and processors.

## 8. Conclusions

Analysis of research productivity and the number of citations received by publications included in the sample confirm the growing interest of the academia in research on responsible and sustainable innovations. Making an attempt to map the key players in the research field, contributions made by nations, research institutions, journals, and authors have been studied. The representatives of European, North American, South American and Asian nations are found among the most productive countries. In regards to quantity of the research output, the leaders in the field are the Netherlands, the United Kingdom, and the United States. Taking into account quality of the research, Germany should be added to the aforementioned countries. The ranking of the top 10 most productive research institutions in the field is dominated by the Netherlands. Dutch universities and research centers occupy the top three positions in regard to the number of publications. The Delft University of Technology is the unquestionable leader. However, the highest number of citations is received by two British institutions i.e., the University of Sussex and the University of Exeter. The most prolific and highly recognized source title in the field is the *Journal of Cleaner Production*, which published 64 articles, receiving a total of 1143 citations.

The most prolific authors in the field are V. Blok from Wageningen University and Research Center (Netherlands), E. Fisher from Arizona State University (United States) and R. Owen from the University of Bristol (United Kingdom). When it comes to the number of received citations, the leaders are R. Owen, J. Stilgoe from University College London (United Kingdom), P. Macnaghten from Wageningen University and Research Center (Netherlands), and A. Smith from the University of Sussex (United Kingdom).

Subject area profiling has aimed at exploring diversity and the multidimensionality of research related to the issues of responsible and sustainable innovations. The study has been focused on key journals and authors, and core references representing the four following leading subject areas in the field: Business, Management and Accounting, Engineering, Social Sciences, and Environmental Science. The *Journal of Cleaner Production* is recognized to be the most universal and top-ranked journal in terms of the number of publications in the following three areas: Business, Management and Accounting, Engineering, and Environmental Science. Moreover, there are titles shared by Business, Management and Accounting, and Social Sciences (i.e., *Science and Engineering Ethics* and *Responsible Innovation 2: Concepts, Approaches and Applications*) as well as Social Sciences and Environmental Science (*Sustainability Switzerland, Business Strategy and the Environment*). In regard to source titles, Engineering is found to be less interrelated with other subject areas. A relatively high level of homogeneity is observed as regards the distribution of the top authors through leading subject areas in research on responsible and sustainable innovations. V. Blok is recognized to be the most prolific author in three areas, i.e., Business, Management and Accounting, Social Sciences, and Environmental Science. Similarly, the profiling for core references shows a lot of links between the subject areas in the field. Analyzing the top five core references in each of the leading areas, we identified one paper [2] shared among three areas and five other works shared by at least two subject areas. Summing up, subject area profiling shows a relatively high level of interrelatedness among the four leading areas under the study i.e., Business, Management and Accounting, Engineering, Social Sciences, and Environmental Science in regard to authors, source titles and core references.

Finally, the topic profiling has been completed with the aim of searching for predominant themes in the field by analyzing keywords from the perspective of authors, journals, subject areas, and core references. Analyzing the most often cited keywords two interesting thematic streams may be observed in the field. First of all, the leading keywords such as: 'innovation', 'sustainable development', 'sustainable innovation', 'sustainability' and 'responsible innovation' concentrate the attention on the core aspects of responsible and sustainable innovations. Secondly, the keywords indicate the relationships of the concept with people (human, humans), research, ethics, and technology. Topic-subject areas profiling shows that generally all the subject areas share their interest in such themes as innovation, sustainable development, sustainable innovation, responsible innovation, and sustainability. However, some aspects of research typical of relevant subject areas may be found e.g., product design and life cycle management in Engineering, humanistic and technological issues in Social Sciences, or life cycle management and environmental impact in the case of Environmental Science. Finally, we have analyzed the core references related to the following leading topics: innovation, sustainable development, sustainable innovation, sustainability, and responsible innovation. The analysis indicates that several particular topics share some works. For instance, the publications by Boons et al. [33] and Bos-Brouwers [36] are shared by three topics, while Schot and Geels [29], Stilgoe et al. [14], and Johnson et al. [31] contribute with their research to two of leading themes. Similarly to the study of the research field from the perspective of subject areas, topic profiling indicates links and bridges between topics analyzed through the prism of authors, source titles, subject areas, and core references.

Discussing the findings of research profiling, overlapping approaches in the literature on responsible innovation are worth noticing. Several authors describe this new concept as responsible research and innovation, responsible innovation, or sustainable innovation. Moreover, some other concepts combining the ideas of innovations and corporate social responsibility and focusing

on particular aspects may be observed, e.g., environmental innovations, grassroots innovations, and social innovations.

In regard to research patterns in the field, the discussion has been focused on the reasons for scholarly research to have developed along certain lines. Making an attempt to explain the dominant position in the field occupied by the Netherlands, Dutch universities and researchers, geographical and cultural aspects are to be mentioned first. Being a flood-prone country caused the necessity for the Dutch government as well as citizens to be innovative in protecting the land against flooding and to secure freshwater supplies. Moreover, the Netherlands is a Feminine society which means that the dominant values in society are caring for others and quality of life. Next, it should be noticed that the Dutch research eco-system fosters the development of innovations (and focus on responsible innovations) as it involves different entities such as: universities and research institutes, government policymakers, companies, civil society organizations, and financial institutions. What is also of paramount importance is the fact that the country has very strong universities as reflected in the number and quality of scientific publications. Considering the leading position of the *Journal of Cleaner Production* and *Journal of Responsible Innovation* among the most productive source titles in the field, we assume it has been achieved due to: high quality and very good matching of the scopes of these source titles with the issues of responsible and sustainable innovations, openness for research perspectives from various subject areas, and networking with leading research institutions in the field. Multidimensionality of perspectives is a high feature of research in the field. The concepts of responsible and sustainable innovations respond to up-to-date problems faced by governments, businesses, non-governmental organizations, and individuals. Due to their multidimensionality, the ideas of responsible innovations match to research questions considered as central in many subject areas.

Finally, the discussion has concentrated attention on the identification of unexplored aspects or possible future avenues of research. Among them, the three following lines are worth noticing: (1) searching for the business context of responsible innovations, (2) exploring networked nature of the concept in the business context with particular focus on value chain issues, and (3) examining the relationship between disruptive and emerging technologies (e.g. robotics, artificial intelligence, synthetic biology etc.) and society.

The study makes a contribution to the body of knowledge on responsible and sustainable innovations through mapping the research field, discussing existing research patterns and their antecedents, and identifying new research avenues. Firstly, the paper identifies key contributors (nations, research institutions, journals, and authors) providing the answer to the question about the constituents of the research community [23]. Secondly, the paper explores the interdisciplinarity of research in the field analyzing outputs in leading subject areas i.e., Business, Management and Accounting, Engineering, Social Sciences, and Environmental Science. Thirdly, it contributes to topic profiling, analyzing most often cited keywords, in order to explore thematic boundaries of the field. Both, the second and third parts of the study make an attempt to identify the most central research issues in the field [23].

The paper is of theoretical character, so it contributes mainly to the development of the body of knowledge in management sciences. Nevertheless, some implications it has for business practice are worth considering, too. As observed by Lis [106], bibliometric studies aimed at mapping research fields in management sciences may be useful for managers in four ways. Firstly, the identification of leading research institutions and the most prolific and highly recognized authors enable the companies interested in cooperation with academia to find out the relevant partners. Secondly, recognition of the most productive source titles (journals) and core references receiving the attention of the research community provides an indication for managers searching for valuable sources of information and knowledge. Thirdly, discovery of leading and emerging study topics may focus the attention of business practitioners on key and 'hot' issues, they should deal with. Fourthly, highlighting some research topics discussed in literature may catalyze identification of real-life managerial problems and submitting them as proposals for further studies. In regard to the issue of responsible and sustainable innovation

explored in our paper, two other aspects should be highlighted. The paper discusses an interesting case of the Dutch research ecosystem, finding it among the reasons standing behind the strong position of the Netherlands in the research field focused on responsible innovations. Development of this ecosystem, combining the efforts of universities and research institutes, government policymakers, companies, civil society organizations, and financial institutions, could be considered as a good practice recommended for implementation in other areas in order to strengthen cooperation between academia and its business environment. Finally, the paper reveals the industries which have been relatively well studied in regard to developing and implementing responsible innovations as well as those which still require more investigation embedded in their particular contexts.

Concluding, the limitations of the study and recommendations for further research should be discussed. Firstly, limitations related to some level of subjectivity associated with the research profiling methodology need to be pointed out. Therefore in the future, it is suggested to supplement the mapping of the research field with other bibliometric methods and techniques. Secondly, there are limitations caused by the research sampling process. Scopus is considered to be one of the largest and most prestigious bibliometric databases. However, it covers only a part of the research output. What is more, Scopus is very much biased to publications in English, while neglecting those issued in other languages, which results in a natural gap while sampling for the bibliometric study. In consequence, replication of the study with the use of other bibliometric databases is worth considering. Thirdly, bibliometric studies, as literature quantitative studies, provide a general, but not a very thorough, analysis of the situation in the research field. That is why they should be supplemented with qualitative literature surveys. Finally, due to the very dynamic development of the research field, we find a static, one-time analysis to be insufficient. Therefore, the replication of the study in the future is recommended to observe changing trends and shifts in the research field over time.

**Author Contributions:** A.L. initiated the project and conceptualized the paper, designed methodology as well as retrieved and prepared data for analysis. All the authors (A.L., A.S. and M.C.) were responsible for data analysis. A.S. and A.L. contributed to introduction, discussion, and conclusion sections as well as editing the manuscript.

**Funding:** This research received no external funding.

**Acknowledgments:** The paper was supported with statutory research funding of the Faculty of Economic Sciences and Management, Nicolaus Copernicus University in Torun, Poland and WSB University in Torun, Poland.

**Conflicts of Interest:** The authors declare no conflict of interest.

## References

1. Bouglet, J.; Joffre, O.; Simon, E. How to reconcile business with sustainable development: An innovation approach. *Soc. Bus. Rev.* **2012**, *50*, 307–336. [[CrossRef](#)]
2. Boons, F.; Lüdeke-Freund, F. Business models for sustainable innovation: State-of-the-art and steps towards a research agenda. *J. Clean. Prod.* **2013**, *45*, 9–19. [[CrossRef](#)]
3. Starik, M.; Kanashiro, P. Toward a theory of sustainability management. *Organ. Environ.* **2013**, *26*, 7–30. [[CrossRef](#)]
4. Montiel, I.; Delgado-Ceballos, J. Defining and measuring corporate sustainability. *Organ. Environ.* **2014**, *27*, 113–139. [[CrossRef](#)]
5. Carroll, A.B. Corporate social responsibility. *Organ. Dyn.* **2015**, *44*, 87–96. [[CrossRef](#)]
6. Kolk, A. The social responsibility of international business: From ethics and the environment to CSR and sustainable development. *J. World Bus.* **2016**, *51*, 23–34. [[CrossRef](#)]
7. Barnett, M.L. The business case for corporate social responsibility: A critique and an indirect path forward. *Bus. Soc.* **2019**, *58*, 167–190. [[CrossRef](#)]
8. Grunwald, A. Responsible innovation: Bringing together technology assessment, applied ethics and STS research. *Enterp. Work Innov. Stud.* **2011**, *7*, 9–13.
9. von Schomberg, R. Prospects for technology assessment in a framework of responsible research and innovation. In *Technikfolgen Abschätzen Lehren*; Dusseldorp, M., Beecroft, R., Eds.; VS Verlag für Socialwissenschaften: Wiesbaden, Germany, 2012; pp. 39–61.

10. Rip, A. The past and future of RRI. *Life Sci. Soc. Policy* **2014**, *10*, 1–15. [[CrossRef](#)]
11. Zwart, H.; Landeweerd, L.; van Rooij, A. Adapt or perish? Assessing the recent shift in the European research funding arena from 'ELSA' to 'RRI'. *Life Sci. Soc. Policy* **2014**, *10*, 1–19. [[CrossRef](#)]
12. Blok, V.; Martinuzzi, A.; Brem, A.; Stahl, B.; Schonherr, N. Responsible research and innovation in industry—Challenges, insights and perspectives. *Sustainability* **2018**, *10*, 702. [[CrossRef](#)]
13. Griffy-Brown, C.; Earp, B.D.; Rosas, O. Technology and the good society. *Technol. Soc.* **2018**, *52*, 1–78. [[CrossRef](#)]
14. Stilgoe, J.; Owen, R.; Macnaghten, P. Developing a framework for responsible innovation. *Res. Policy* **2013**, *42*, 1568–1580. [[CrossRef](#)]
15. Owen, R.; Stilgoe, J.; Macnaghten, P.; Gorman, M.; Fisher, E.; Guston, D. A framework for responsible innovation. In *Responsible Innovation. Managing the Responsible Emergence of Science and Innovation in Society*; Owen, R., Bessant, J., Heintz, M., Eds.; Wiley: London, UK, 2013; pp. 27–50.
16. Macnaghten, P.; Owen, R.; Stilgoe, J.; Wynne, B.; Azevedo, A.; de Campos, A.; Chilvers, J.; Dagnino, R.; di Giulio, G.; Frow, E. Responsible innovation across borders: Tensions, paradoxes and possibilities. *J. Respir. Innov.* **2014**, *1*, 191–199. [[CrossRef](#)]
17. Ribeiro, B.E.; Smith, R.D.J.; Millar, K.A. A mobilising concept? Unpacking academic representations of responsible research and innovation. *Sci. Eng. Ethics* **2016**, *23*, 81–103. [[CrossRef](#)] [[PubMed](#)]
18. Lubberink, R.; Blok, V.; van Ophem, J.; Omta, O. Lessons from responsible innovations in the business context: A systematic literature review of responsible, social and sustainable innovation practices. *Sustainability* **2017**, *9*, 721. [[CrossRef](#)]
19. Groves, C. Future ethics: Risk, care and non-reciprocal responsibility. *J. Glob. Ethics* **2009**, *5*, 17–31. [[CrossRef](#)]
20. Adam, B.; Groves, C. Futures tended: Care and future-oriented responsibility. *Bull. Sci. Technol. Soc.* **2011**, *31*, 17–27. [[CrossRef](#)]
21. Hargadon, A. *Sustainable Innovation: Build Your Company's Capacity to Change the World*; Stanford University Press: Stanford, CA, USA, 2015.
22. Osareh, F. Bibliometrics, citation analysis and co-citation analysis: A review of literature I. *Libri* **1996**, *46*, 149–158. [[CrossRef](#)]
23. Porter, A.L.; Kongthong, A.; Lu, J.C. Research profiling: Improving the literature review. *Scientometrics* **2002**, *53*, 351–370. [[CrossRef](#)]
24. Martinez, H.; Jaime, A.; Camacho, J. Relative absorptive capacity: A research profiling. *Scientometrics* **2012**, *92*, 657–674. [[CrossRef](#)]
25. Choi, D.G.; Lee, H.; Sung, T. Research profiling for 'standardization and innovation'. *Scientometrics* **2011**, *88*, 259–278. [[CrossRef](#)]
26. Lis, A. General research profiling for the concept of a 'learning organization'. In *Business and Non-profit Organizations Facing Increased Competition and Growing Customers' Demands*; Nalepka, A., Ujwary-Gil, A., Eds.; Wyższa Szkoła Biznesu—National Louis University: Nowy Sącz, Poland, 2017; pp. 75–92.
27. Lis, A.; Czerniachowicz, B.; Wieczorek-Szymańska, A. Leadership and corporate social responsibility: Research topic profiling. In *Business and Non-profit Organizations Facing Increased Competition and Growing Customers' Demands*; Nalepka, A., Ujwary-Gil, A., Eds.; Wyższa Szkoła Biznesu—National Louis University: Nowy Sącz, Poland, 2017; pp. 59–74.
28. Lis, A.; Sudolska, A. W poszukiwaniu typologii innowacji społecznie odpowiedzialnych: Mapowanie pola badawczego. *Stud. I Prace Wyzd. Nauk Ekon. I Zarz. Univ. Szczec.* **2018**, *52*, 115–126. [[CrossRef](#)]
29. Schot, J.; Geels, F.W. Strategic niche management and sustainable innovation journey: Theory, findings, research agenda, and policy. *Technol. Anal. Strateg. Manag.* **2008**, *20*, 537–554. [[CrossRef](#)]
30. Smith, A.; Voß, J.P.; Grin, J. Innovation studies and sustainability transitions: The allure of the multi-level perspective and its challenges. *Res. Policy* **2010**, *39*, 435–448. [[CrossRef](#)]
31. Johnson, K.; Hays, C.; Center, H.; Daley, C. Building capacity and sustainable prevention innovations: A sustainability planning model. *Eval. Program Plan.* **2004**, *27*, 135–149. [[CrossRef](#)]
32. Stirling, A. A general framework for analysing diversity in science, technology and society. *J. R. Soc. Interface* **2007**, *4*, 707–719. [[CrossRef](#)]
33. Boons, F.; Montalvo, C.; Quist, J.; Wagner, M. Sustainable innovation, business models and economic performance: An overview. *J. Clean. Prod.* **2013**, *45*, 1–8. [[CrossRef](#)]

34. Nill, J.; Kemp, R. Evolutionary approaches for sustainable innovation policies: From niche to paradigm? *Res. Policy* **2009**, *38*, 668–680. [CrossRef]
35. Owen, R.; Macnaghten, P.; Stilgoe, J. Responsible research and innovation: From science in society to science for society, with society. *Sci. Publ. Policy* **2012**, *39*, 751–760. [CrossRef]
36. Bos-Brouwers, H.E.J. Corporate sustainability and innovation in SMEs: Evidence of themes and activities in practice. *Bus. Strategy Environ.* **2010**, *19*, 417–435. [CrossRef]
37. Larson, A.L. Sustainable innovation through an entrepreneurship lens. *Bus. Strategy Environ.* **2000**, *9*, 304–317. [CrossRef]
38. Ozaki, R. Adopting sustainable innovation: What makes consumers sign up to green electricity? *Bus. Strategy Environ.* **2011**, *20*, 1–17. [CrossRef]
39. Ozaki, R.; Sevastyanova, K. Going hybrid: An analysis of consumer purchase motivations. *Energy Policy* **2011**, *39*, 2217–2227. [CrossRef]
40. Owen, R.; Goldberg, N. Responsible innovation: A pilot study with the U.K. Engineering and Physical Sciences Research Council. *Risk Anal.* **2010**, *30*, 1699–1707. [CrossRef]
41. Piccinno, F.; Hischier, R.; Seeger, S.; Som, C. From laboratory to industrial scale: A scale-up framework for chemical processes in life cycle assessment studies. *J. Clean. Prod.* **2016**, *125*, 1085–1097. [CrossRef]
42. Flipse, S.M.; de Winde, J.H.; Özdemir, P.; van der Sanden, M.C.A. The wicked problem of Socially Responsible Innovation. *EMBO Rep.* **2014**, *15*, 464. [CrossRef]
43. Leach, M.; Rockström, J.; Raskin, P.; Scoones, I.; Stirling, A.C.; Smith, A.; Thompson, J.; Millstone, E.; Ely, A.; Arond, E.; et al. Transforming innovation for sustainability. *Ecol. Soc.* **2012**, *17*. [CrossRef]
44. Hellström, T. Dimensions of environmentally sustainable innovation: The structure of eco-innovation concepts. *Sustain. Dev.* **2007**, *15*, 148–159. [CrossRef]
45. Guston, D.H. Understanding ‘anticipatory governance’. *Soc. Stud. Sci.* **2014**, *44*, 218–242. [CrossRef]
46. Hellström, T. Systemic innovation and risk: Technology assessment and the challenge of responsible innovation. *Technol. Soc.* **2003**, *25*, 369–384. [CrossRef]
47. von Schomberg, R. Introduction: Towards responsible and innovation in the information and communication technologies and security technologies field. In *Towards Responsible Research and Innovation in the Information and Communication Technologies and Security Technologies Field*; von Schomberg, R., Ed.; Publications Office of the European Union: Luxembourg, 2011; pp. 7–15.
48. European Union. *Rome Declaration on Responsible Research and Innovation in Europe*; European Union: Brussels, Belgium, 2014. Available online: [https://ec.europa.eu/research/swafs/pdf/rome\\_declaration\\_RRI\\_final\\_21\\_November.pdf](https://ec.europa.eu/research/swafs/pdf/rome_declaration_RRI_final_21_November.pdf) (accessed on 1 August 2018).
49. van de Poel, I.; Asveld, L.; Flipse, S.; Klaassen, P.; Scholten, V.; Yaghmaei, E. Company strategies for responsible research and innovation (RRI): A conceptual model. *Sustainability* **2017**, *9*, 2045. [CrossRef]
50. Blok, V.; Scholten, V.; Lon, T.B. Responsible innovation in industry and the importance of customer orientation: Introduction to the special issue. *Int. Food Agribus. Manag. Rev.* **2018**, *21*, 455–462. [CrossRef]
51. Foxon, T.; Pearson, P. Overcoming barriers to innovation and diffusion of cleaner technologies: Some features of a sustainable innovation policy regime. *J. Clean. Prod.* **2008**, *16*, S148–S161. [CrossRef]
52. Dove, E.S.; Özdemir, V. The epiknowledge of socially responsible innovation. *EMBO Rep.* **2014**, *15*, 462–463. [CrossRef]
53. Stahl, B.; Obach, M.; Yaghmaei, E.; Ikonen, V.; Chatfield, K.; Brem, A. The responsible research and innovation (RRI) maturity model: Linking theory and practice. *Sustainability* **2017**, *9*, 1036. [CrossRef]
54. Viesser, W. *The Age of Responsibility: CSR 2.0*; Wiley: New York, NY, USA, 2011.
55. Van den Hoven, J. Value sensitive design and responsible innovation. In *Responsible Innovation. Managing the Responsible Emergence of Science and Innovation in Society*; Owen, R., Bessant, J., Heintz, M., Eds.; Wiley: London, UK, 2013; pp. 75–84.
56. Noorman, M.; Swierstra, T.; Zandbergen, D. Questioning the normative core of RI: The challenges posed to stakeholder engagement in a corporate setting. In *Responsible Innovation 3: A European Agenda?* Asveld, L., van Dam-Mieras, R., Swierstra, T., Lavrijssen, S., Linse, K., van den Hoven, J., Eds.; Springer International Publishing: Cham, Germany, 2017; pp. 231–249.
57. von Schomberg, R. A vision of responsible research and innovation. In *Responsible Innovation. Managing the Responsible Emergence of Science and Innovation in Society*; Owen, R., Bessant, J., Heintz, M., Eds.; Wiley: London, UK, 2013; pp. 51–74.



58. Blok, V.; Lemmens, P. The emerging concept of responsible innovation: Three reasons why it is questionable and calls for a radical transformation of the concept of innovation. In *Responsible Innovation 2: Concepts, Approaches and Applications*; Koops, B.J., Oosterlaken, I., van den Hoven, J., Romijn, H.A., Swierstra, T.E., Eds.; Springer: Dordrecht, The Netherlands, 2015; pp. 19–35.
59. Koops, B.J. The concepts, approaches, and applications of responsible innovation: An introduction. In *Responsible Innovation 2: Concepts, Approaches and Applications*; Koops, B.J., Oosterlaken, I., van den Hoven, J., Romijn, H.A., Swierstra, T.E., Eds.; Springer: Dordrecht, The Netherlands, 2015; pp. 1–15.
60. Maier, M.A.; Brem, A.; Kauke, M. Exploring the boundaries of corporate social responsibility and innovation: A conceptual framework of socio-political stakeholders and their integration into the innovation process. *Int. J. Innov. Sustain. Dev.* **2016**, *10*, 312–337. [[CrossRef](#)]
61. Vollero, A.; Palazzo, M.; Siano, A.; Elving, W.J.L. Avoiding the greenwashing trap: Between CSR communication and stakeholder engagement. *Int. J. Innov. Sustain. Dev.* **2016**, *10*, 120–140. [[CrossRef](#)]
62. Burget, M.; Bardone, E.; Pedaste, M. Definitions and conceptual dimensions of responsible research and innovation: A literature review. *Sci. Eng. Ethics* **2016**, *23*, 1–19. [[CrossRef](#)]
63. Swierstra, T. Economic, technological, and socio-epistemological drivers behind RRI. In *Responsible Innovation 3: A European Agenda?* Asveld, L., van Dam-Mieras, R., Swierstra, T., Lavrijssen, S., Linse, K., van den Hoven, J., Eds.; Springer International Publishing: Cham, Germany, 2017; pp. 9–20.
64. Lee, R.G.; Petts, J. Adaptive governance for responsible innovation. In *Responsible Innovation. Managing the Responsible Emergence of Science and Innovation in Society*; Owen, R., Bessant, J., Heintz, M., Eds.; Wiley: London, UK, 2013; pp. 143–164.
65. Wickson, F.; Carew, A.L. Quality criteria and indicators for responsible research and innovation: Learning from transdisciplinarity. *J. Responsible Innov.* **2014**, *1*, 254–273. [[CrossRef](#)]
66. Richardson, H.S. Institutionally divided moral responsibility. In *Responsibility*; Miller, E.F., Paul, J., Eds.; Cambridge University Press: Cambridge, UK, 1999; pp. 218–249.
67. Pellizzoni, L. Responsibility and environmental governance. *Environ. Politics* **2004**, *13*, 541–565. [[CrossRef](#)]
68. Groves, C. Technological futures and non-reciprocal responsibility. *Int. J. Humanit.* **2006**, *4*, 57–61. [[CrossRef](#)]
69. Grinbaum, A.; Groves, C. What is ‘responsible’ about responsible innovation? Understanding the ethical issues. In *Responsible Innovation. Managing the Responsible Emergence of Science and Innovation in Society*; Owen, R., Bessant, J., Heintz, M., Eds.; Wiley: London, UK, 2013; pp. 119–142.
70. Stirling, A. “Opening up” and “closing down”: Power, participation, and pluralism in the social appraisal of technology. *Sci. Technol. Hum. Values* **2007**, *33*, 262–294. [[CrossRef](#)]
71. Adams, R.; Jeanrenaud, S.; Bessant, J.; Denyer, D.; Overy, P. Sustainability-oriented innovation: A systematic review. *Int. J. Manag. Rev.* **2015**, *18*, 180–205. [[CrossRef](#)]
72. Lubberink, R.; Blok, V.; van Ophem, J.; Omta, O. A framework for responsible innovation in the business context: Lessons from responsible-, social- and sustainable innovation. In *Responsible Innovation 3: A European Agenda?* Asveld, L., van Dam-Mieras, R., Swierstra, T., Lavrijssen, S., Linse, K., van den Hoven, J., Eds.; Springer International Publishing: Cham, Germany, 2017; pp. 181–207.
73. Dyck, B.; Silvestre, B.S. Enhancing socio-ecological value creation through sustainable innovation 2.0: Moving away from maximizing financial value capture. *J. Clean. Prod.* **2018**, *171*, 1593–1604. [[CrossRef](#)]
74. Horbach, J. *Indicator Systems for Sustainable Innovation, Sustainability and Innovation*; Physica-Verlag Heidelberg: Heidelberg, Germany, 2005.
75. Calik, E.; Bardudeen, F. A measurement scale to evaluate sustainable innovation performance in manufacturing organizations. 13th Global Conference on Sustainable Manufacturing—Decoupling Growth from Resource Use. *Procedia CIRP* **2016**, *40*, 449–454. [[CrossRef](#)]
76. Tello, S.F.; Yoon, E. Examining drivers of sustainable innovation. *Int. J. Bus. Strateg.* **2008**, *8*, 164–169.
77. Great Britain and World Commission on Environment and Development. *Our Common Future: A Perspective by the United Kingdom on the Report of the World Commission on Environment and Development*; Department of the Environment: London, UK, 1988.
78. Zeng, D.; Hu, J.; Ouyang, T. Managing innovation paradox in the sustainable innovation ecosystem: A case study of ambidextrous capability in a focal firm. *Sustainability* **2017**, *9*, 2091. [[CrossRef](#)]
79. Chesbrough, H. *Open Business Models: How to Thrive in the New Innovation Landscape*; Harvard Business School Press: Boston, MA, USA, 2006.

80. Chesbrough, H. Open innovation: A new paradigm for understanding industrial innovation. In *Open Innovation. Researching a New Paradigm*; Chesbrough, H., Vanhaverbeke, W., West, J., Eds.; Oxford University Press: Oxford, UK, 2008; pp. 1–12.
81. Calof, J.; Meissner, D.; Razheva, A. Overcoming open innovation challenges: A contribution from foresight and foresight networks. *Technol. Anal. Strateg. Manag.* **2018**, *30*, 718–733. [CrossRef]
82. Rennings, K. Redefining innovation—Eco-innovation research and the contribution from ecological economics. *Ecol. Econ.* **2000**, *32*, 319–332. [CrossRef]
83. Seyfang, G.; Smith, A. Grassroots innovations for sustainable development: Towards a new research and policy agenda. *Environ. Politics* **2007**, *16*, 584–603. [CrossRef]
84. Schiederig, T.; Tietze, F.; Herstatt, C. Green innovation in technology and innovation management—An exploratory literature review. *R D Manag.* **2012**, *42*, 180–192. [CrossRef]
85. Flipse, S.M.; Van Der Sanden, M.C.A.; Radstake, M.; De Winde, J.H.; Osseweijer, P. The DNA of socially responsible innovation: Social and natural scientists need to establish mutual understanding and a common language to efficiently work together. *EMBO Rep.* **2014**, *15*, 134–137. [CrossRef] [PubMed]
86. Franceschini, S.; Faria, L.G.D.; Jurowetzi, R. Unveiling scientific communities about sustainability and innovation: A bibliometric journey around sustainable terms. *J. Clean. Prod.* **2016**, *127*, 72–83. [CrossRef]
87. Loya, M.I.M.; Rawani, A.M. Adoption factors for green brick innovation: An empirical study of consumers in India. *Int. J. Innov. Sustain. Dev.* **2017**, *11*, 23–36. [CrossRef]
88. Klemmer, P.; Lehr, U.; Lobbe, K. *Environmental Innovation: Volume 3 of Publications from a Joint Project on Innovation Impacts of Environmental Policy Instruments; Synthesis Report of a Project Commissioned by the German Ministry of Research and Technology (BMBF); Analytica-Verlag: Berlin, Germany, 1999.*
89. OECD. LEED Forum on Social Innovations. 2000. Available online: <http://www.oecd.org/cfe/leed/Forum-Social-Innovations.htm> (accessed on 15 July 2018).
90. Heisala, R. Social innovations: Structural and power perspectives. In *Social Innovations, Institutional Change and Economic Performance*; Hamalainen, T.J., Heiskala, R., Eds.; Edward Elgar: Cheltenham, UK, 2007; pp. 52–79.
91. Mulgan, G. *Social Silicon Valleys: A Manifesto for Social Innovations*; The Young Foundation: London, UK, 2007.
92. Harris, M.; Albury, D. *The Innovation Imperative*; NESTA: London, UK, 2009.
93. Hisham, S. A Country Built by Innovation: The Netherlands. Geospatial World. Available online: <https://www.geospatialworld.net/article/a-country-built-by-innovation-the-netherlands/> (accessed on 6 September 2018).
94. Hofstede, G. *Culture's Consequences: Comparing Values, Behaviors, Institutions, and Organizations Across Nations*; Sage: Thousand Oaks, CA, USA, 2001.
95. Hofstede Insights. Available online: <https://www.hofstede-insights.com/country/the-netherlands/> (accessed on 3 September 2018).
96. Best Practices in The Netherlands. Available online: <https://thegreentake.wordpress.com/tag/the-netherlands> (accessed on 5 September 2018).
97. Hampden-Turner, C.; Trompenaars, A. *The Seven Cultures of Capitalism: Value Systems for Creating Wealth in Britain, the United States, Germany, France, Japan, Sweden and The Netherlands*; Doubleday Business: New York, NY, USA, 1995.
98. Building an Ecosystem to Foster Innovation. Available online: <https://tno.nl/en/about-tno/news/2017/5/building-on-ecosystem-to-foster-innovation/> (accessed on 30 July 2018).
99. OECD Reviews on Innovation Policy: The Netherlands. Overall Assessment and Recommendations. Available online: [www.oecd.org/sti/innovation/reviews](http://www.oecd.org/sti/innovation/reviews) (accessed on 5 September 2018).
100. Encouraging Innovation. Available online: [www.government.nl/topics/enterprise-and-innovation/encouraging-innovation](http://www.government.nl/topics/enterprise-and-innovation/encouraging-innovation) (accessed on 3 September 2018).
101. The Dutch Research Council (NWO). Available online: <https://www.nwo.nl/en> (accessed on 1 September 2018).
102. JCLP (nd). Journal of Cleaner Production. Available online: <https://www.journals.elsevier.com/journal-of-cleaner-production/> (accessed on 20 June 2018).
103. JRI (nd). Journal of Responsible Innovation: Aims and Scope. Available online: <https://www.tandfonline.com/action/journalInformation?show=aimsScope&journalCode=tjri20> (accessed on 20 June 2018).

104. Silva, H.P.; Lehoux, P.; Miller, F.A.; Denis, J.L. Introducing responsible innovation in health: A policy-oriented framework. *Health Res. Policy Syst.* **2018**, *16*. [[CrossRef](#)]
105. Dalziel, P.; Saunders, C.; Tait, P.; Saunders, J.; Miller, S.; Guenther, M.; Rutherford, P.; Driver, T. Rewarding responsible innovation when consumers are distant from producers: Evidence from New Zealand. *Int. Food Agribus. Manag. Rev.* **2018**, *21*, 487–504. [[CrossRef](#)]
106. Lis, A. Managing organization development: Identifying research patterns and mapping the research field. In *Contemporary Challenges in Cooperation and Competition in the Age of Industry 4.0*; Zakrzewska-Bielawska, A., Staniec, I., Eds.; Springer: Cham, Switzerland, 2020; pp. 375–396.



© 2019 by the authors. Licensee MDPI, Basel, Switzerland. This article is an open access article distributed under the terms and conditions of the Creative Commons Attribution (CC BY) license (<http://creativecommons.org/licenses/by/4.0/>).



Article

# Method for Selecting the Safety Integrity Level for the Control-Command and Signaling Functions

Dariusz Szmel, Wiesław Zabłocki, Przemysław Ilczuk and Andrzej Kochan \*

Department of Traffic Control and Infrastructure, Faculty of Transport, Warsaw University of Technology, 00001 Warsaw, Poland; dariusz.szmel@gmail.com (D.S.); zab@wt.pw.edu.pl (W.Z.); pil@wt.pw.edu.pl (P.I.)

\* Correspondence: ako@wt.pw.edu.pl; Tel.: +48-664-127-441

Received: 29 October 2019; Accepted: 4 December 2019; Published: 10 December 2019

**Abstract:** The purpose of the article is to present selected method of risk assessment of railway control and signaling systems, including current normative and legal bases, such as directives and regulations that regulate the interoperability and safety of the railway system. Selected methods used at the initial stage of creating safety requirements and referring to the initial definition of the system defined at a high level of abstraction are considered. Issues of holistic approach and residual risk management are also discussed. Risk models are presented as well as individual steps of risk analysis, evaluation, and assessment, including hazard identification, impact analysis, and selection of the risk acceptance principle. Selected model based on hazard and operability studies (HAZOP) and an adapted risk graph was applied to the real signalling equipment. The key aspect undertaken in the article is the proposal to set quantitative safety objectives based on the safety integrity level/tolerable hazard rate (SIL/THR) indicator, as an important parameter in further analysis of the system, especially in computer applications. The result of study showed that application of proposed combination HAZOP and adapted risk graph method are efficient and suitable for a railway signalling application. The results and conclusion are presented in Chapters 4 and 6 of the article.

**Keywords:** risk analysis; risk assessment; THR; railway; transport management; traffic safety

## 1. Introduction

The most vulnerable part of any system, including railway signalling systems, is human. Not only humans who use technical equipment, but people who design and manufacture equipment. Railway signalling systems become more and more complicated and complex. The overarching aim at the designing stage is to automatize work in order to eliminate human errors in the signalling process [1–4]. Therefore, technical problems are a significant problem of safety and risk analysis. The main problem now is to apply reasonable and practicable method to perform risk assessment in order to identify the safety requirements that shall be considered during the signalling system development. It is desired that the method is no time and resources consuming in the dynamic world with so many changes occurring so fast. The purpose of the article is to present selected method of risk assessment of railway control and signaling systems, including current normative and legal bases, such as directives and regulations that regulate the interoperability and safety of the railway system. These problems differ because the devices and systems vary significantly. Engineers solve these problems mainly at the stage of designing. They are legally and morally responsible for the safety of future users of designed devices. The engineers design and supervise production processes of these devices to maintain the safety level required by law [5]. It is especially difficult to specify the expected safety level, which is linked to the social risk acceptance level. In order to specify the safety level, we use the term risk, which is inextricably linked with the randomness of phenomena and events in the world [6,7]. Risk assessment is a key part of the safety management strategy [8]. In the article, the authors focus on the initial stage

of the risk assessment: from defining the system to specifying safety requirements. The goal of the article was to present the hazard and operability studies (HAZOP) and adapted risk graph method to perform initial risk assessment process and determine safety integrity level/tolerable hazard rate (SIL/THR) requirement and as well to meet the requirements of railway regulation especially regulation 402/2013 [9–11]. The SIL and THR in the context of this article is applied interchangeably. The reason for that is because the used method is qualitative. Authors are aware that the two parameters represent different requirements, however in authors opinions, it has impact and meaning at further steps of safety analysis of a given system [12]. The authors propose the combination of HAZOP and adapted risk graph as practical and comprehensive method to determine the safety targets for the system. There are many other qualitative and quantitative methods available. However, the goal of the method selection was to use well proven, but adapted methods, easy to apply at this level of the system analysis, and easy to understand by railway authorities and/or decision makers. The notations and abbreviations can be found in Appendix A, Table A2.

This publication is part of the research constituting statutory activity and as part of other research programs.

## **2. Literature Review**

Risk assessment of the railway system has been specified in the Implementing Regulation of the European Commission (EU) No 402/2013 of 30 April, 2013 on the common safety method for risk evaluation and assessment and repealing Regulation (EC) No 352/2009 [9]. If a risk assessment is required by the relevant technical specification for interoperability (TSI) then the TSI shall, where necessary, specify which parts of this Regulation apply and, in the case of a railway signalling system, the Commission Regulation (EU) 2016/919 of 27 May, 2016 on the technical specification for interoperability relating to the ‘control-command and signalling’ subsystems of the rail system in the European Union says that CENELEC standards shall apply [10,11]. Currently the SIL investigation methods in railway signalling is not clearly defined. Most of the standards propose several methods to perform the analysis without pointing out the one that is the most suitable [10]. The idea of applying SIL concept is based on the standard PN-EN 61508-1 [12], where also several methods are proposed for the generic E/E/PE systems including risk graph. Most of the scientific papers related to SIL determination is outside of the railway signalling domain [13,14].

The HAZOP method has its deficiencies [15–17], however it is commonly used in railway system for identification of hazards and when carefully applied still provide very good value for the risk assessment process. In paper [18] authors discuss the new HAZOP method is to be applied for the Train Control System in the railway environment with modified parameters. The approach in this article was to use selected guide words to specific functions of the system. It is the typical use of the HAZOP system with application to signalling domain. The risk graph method is not often used in main line signalling systems and more often you can see the risk matrices applied [19], however the risk graph method provides very good values as a qualitative method that does not require huge effort and provides higher levels of details to consider during the decision making [20,21].

In the new version of the PN-EN 50126 standard [10] and in the regulation [9], the description of risk assessment is similar and differs mainly in terms of details at the stage of implementation. In the standard [10], a simplified model has been presented, showing safety activities. It has been named Hourglass model and it separates the risk analysis process, which is a part of the risk assessment at the stage of the concept of the system, from hazards analysis, which is a part of the hazards control at the stage of system implementation. The Hourglass model is well illustrated in the standard PN-EN 50126 [10].

In considerations and analyses regarding safe systems, the concept of a risk model is used because a real risk is not known and cannot be specified. Therefore, the risk analysis must be preceded by a risk model that takes into account, in turn, the human being, real risk, description of the risk (concept mapping), risk model, and risk analysis [11,22,23].

The risk model adopted in Commission Implementing Regulation (2013) [9] shows relations between the causes, hazards, and accidents and their consequences. It is especially assumed that: a single cause can lead to a few hazards, a hazard can consequently lead to a number of accidents of different types, depending on the context of the operation process and environmental parameters. Therefore, such an accident can have various consequences. An exemplary risk model has been shown at Figure 1. It specifies how a hazard at the level of a considered subsystem or system, as a result of operational or technical factors, can be moved to the railway system level, and can lead to an accident, taking into account trigger events and availability of external barriers. The risk graph was applied to consider the below risk model and include evaluation of causes, external barriers, and consequences.

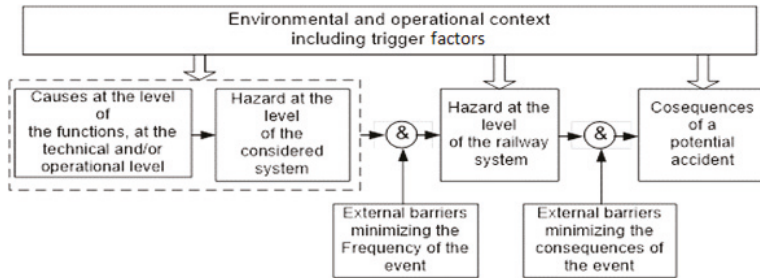

Figure 1. Example of a risk model (source: own work on the basis of [10]).

One of the key and difficult stages of a risk analysis is hazards identification. It is a continuous stage, which should be conducted on a regular basis, during the whole lifecycle of the system. Here, a hazards identification process at the initial stage of system development is described. Firstly, parts of the system are selected, where an unwanted event can take place. Causes and consequences of these events are specified. This task encompasses many methods which support hazard identification. FMECA [24] and HAZOP are the most widespread, described in detail by standards [17,25]. It is also recommended to determine principles and criteria of hazards identification beforehand. The risk model needs to be supplemented by information about consequences of a potential accident. For this purpose, induction and deduction methods are applied, or combination thereof, among others the ones described above and such methods as ETA and FTA [26], described in detail by standards [27,28]. The above activities provide information which is essential in order to classify hazards and estimate risk. In order to evaluate risk, it is necessary to specify risk acceptance criteria. Each analysis starts with a qualitative approach, followed by a quantitative one. However, it is not always possible to estimate risk mathematically. In [9,10], three risk acceptance criteria have been adopted: codes of practice, a comparison with a reference system, and an explicit risk estimation. Such an approach provides for an overview of the whole system, not just the part that can be assessed quantitatively. Proposals regarding the estimation of an explicit risk have been presented in Chapters 3 and 4 of the publication. By using the code of practice or by comparing with a reference system, hazards can be controlled. The code of practice can include principles which are recognized and applied in the railway environment (e.g., standard [5], registers of railway plans). New principles can be applied, but they need to meet the requirements indicated in [9] and be justified. A comparison with a reference system consists of applying safety measures already checked in the system with safety acceptance and is operated. When it comes to residual risk, the process management of the established Safety Related Application Conditions (SRAC) is very important [10].

### 3. Materials and Methods

Risk assessment means the overall, multi-stage process comprising: system definition, hazards identification, risk estimation, and risk evaluation. Risk assessment is linked to the management of hazards through a hazard record. The system definition should, among others, specify the objective

of the system, its functions and elements, as well as boundary, interfaces and environment. After hazards identification, risk acceptance is specified, using the following risk acceptance principles: the application of codes of practice, a comparison with similar systems and an explicit risk estimation [9]. At the stage of risk estimation, it needs to be shown that the risk acceptance principle has been applied accordingly. Application of these risk acceptance principles will make it possible to identify possible safety measures which will make the risk of the assessed system acceptable. Out of the identified safety measures, measures which serve the purpose of risk control will be selected, which will become safety requirements that the system needs to meet [4]. The whole process should be documented in the hazards record, which means the document in which identified hazards, their related measures, their origin, and the reference to the organization which has to manage them are recorded and referenced.

In order to apply risk estimation as the principle of risk acceptance, it is necessary to specify an acceptable risk level. Estimating an explicit risk is possible through specifying the frequency of hazard occurrence and its seriousness. The frequency and seriousness can be specified qualitatively or quantitatively (e.g., by matrix methods or ratio methods). For the purposes of technical systems, taking into account the frequency and seriousness, a safety objective will be set in the form of THR. It determines SIL. This chapter describes the risk graph method as the method chosen for further consideration.

The risk graph method, in accordance with the recommendations of the standard IEC 61508 [12], as well as of the standard PN-EN 50126 [4], makes it possible to estimate risk and determine the required safety integrity level targets or THR, using the following risk elements

$$SIL = f(S; E; A; O) \tag{1}$$

The parameters of the equations definition:

- S—potential consequences of the event
- E—exposure (time/frequency of exposure to the event)
- A—possibility to avoid or limit damages
- O—probability of the occurrence of the event

The relationship between the elements of the method and the passage through the subsequent assessment steps is shown in Figure 2.

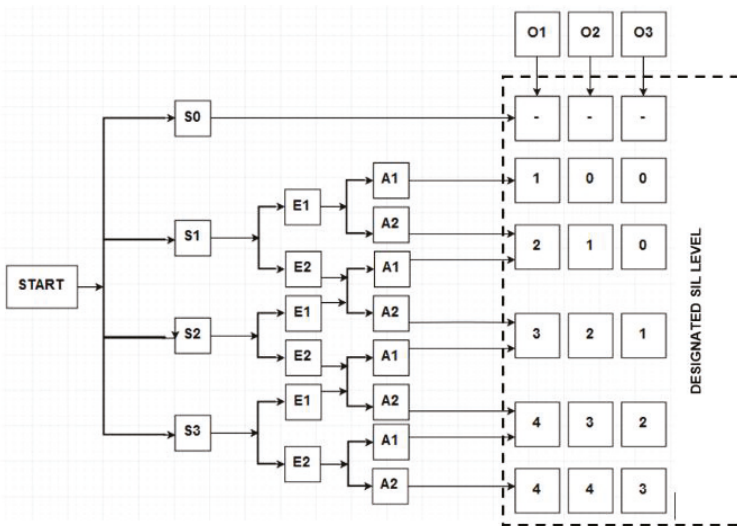

Figure 2. Risk graph (source: own work on the basis of [19]).



The method is relatively easy to use and takes into account in explicit way more parameters than risk matrices methods when specifying the risk level. However, it needs to be adjusted for the right application.

Other data should be determined using hazards identification methods (such as HAZOP) and consequences analysis (e.g., ETA). The determined hazard rate constitutes tolerable hazard rate (THR) for a given system. The adaptation of the method was presented in Section 4 as it is the part of the HAZOP method and no new approach has been identified.

For each factor, criteria based on quantitative and qualitative values have been adopted. For the purpose of the analysis it was necessary to adapt the initial parameters/criteria of the graph. They have been defined in the following way:

**START**

Set up of initial conditions for the analysis

1. There is a procedure of bidirectional communication between the train dispatcher and the level crossing attendant (currently in an analogue mode, telephone communication)
2. There is no dependence between track/station side devices and communication devices between the train dispatcher and the attendant
3. SWI system cannot be worse than the existing communication system.

A risk analysis executed with a risk graph method has been used for the SWI communication system between the train dispatcher and the level crossing attendant. The system shall support bi-directional communication based on telegrams and confirmation of messages. The initial conditions are related with applied system and are referenced for the further steps in the analysis. The authors decided to establish the initial conditions as reference base for the criteria analysis. The conditions and graduation have been analyzed at workshop together with railway experts. At the workshop, people responsible for safety, engineering, maintenance, and operation were invited. At the meeting the method was explained. The goal of the meeting was to analyze the propose definition of parameters based on the brainstorming. The parameters have been as well verified by the railway infrastructure manager.

**S—potential consequences of the event**

S0—event not affecting safety

S1—event affecting safety (no fatalities)

S2—event with a serious consequence (one fatality)

S3—event with catastrophic consequences (more than one fatality)

The potential consequences of the event have been developed in a way to meet the regulation applied in Poland [5] and represent the 4-step order of magnitude increasing from S0 to S3.

**E—exposure (time/frequency of exposure to the event)**

E1—possible exposure to the event

E2—frequent exposure to the event

Exposure to the event was selected base on two possible options. In the authors opinion, these two options actually define if the function is in demand mode or in continuous mode. This was the assumption made for further analysis.

**A—possibility to avoid or limit damages**

For technical reasons (the system equipped with existing technical safety measures), human reasons (skills, awareness, knowledge, psychophysical predispositions), and organizational reasons.

A1—possible avoidance or significant limitation of damages

A2—is not possible

These two parameters have been designed to draw attention for analysts to external barriers minimizing the frequency or the consequences of the event. This category considers the external barriers from the risk model are presented in Figure 1 above. It is important to notice that at the bottom of the graph there is no difference in resulting SIL ( $SIL = 4$ ) when selecting A1 or A2. Authors assumed here that the goal of the analysis was aimed at determining the SIL level for the electronic system. Any other additional external measures have to be analyzed together with the railway infrastructure manager and were not considered in the analysis. This assumption is further discussed in Chapter 5.

#### O—probability of the occurrence of the event

The history of accidents for the same or similar systems.

O1—the event can happen often (more often than once every 10 years;  $1 \times 10^{-5}$ )

O2—the event can happen sometimes during the lifecycle of the system

O3—the event can happen rarely (more rarely than once every 20 years;  $5 \times 10^{-6}$ ).

Probability of the occurrence of the event is established based on the history data. As mentioned at the start of the analysis, one of the assumption is that the new system cannot be worse than the one used before. The three-step approach and the ranges were selected in workshop with railway experts. The main issue with selecting the parameter is to established the contribution level of the system under consideration to the event scenario. The authors see the possibility to further research in this area.

On the basis of these data, a risk analysis report has been prepared. Results for an exemplary function have been presented in Chapter 4.

The method has been used in order to calculate the required value of THR/SIL parameters for specific system functions and in order to verify the parameter SIL4 imposed by the railway infrastructure manager for the whole SWI system. The SWI system is the system to be used by the train dispatcher and the level crossing operator to support the communication between them. The manually operated level crossing is used in the area where there is huge road and railway traffic. At the moment, in Poland, there are 2415 such operating level crossings (category A), which is 18.9% of all level crossings in Poland [29,30]. The Figure 3 represents the share of the level crossing categories in Poland [30].

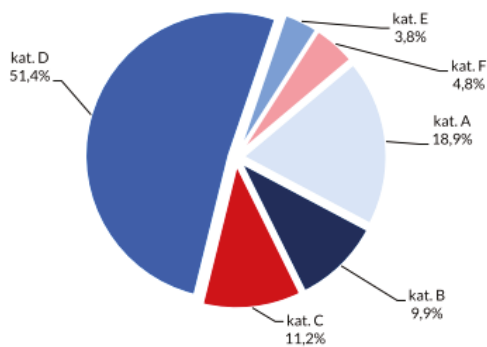

Figure 3. The share of the level crossing categories in Poland.

Legend for the Figure 3:

Kat. A—means level crossing category A—Manually operated level crossing (by signalman or gatekeeper)

Kat. B—means level crossing category B—Automatic level crossing equipped with road signals and barriers

Kat. C—means level crossing category C—Automatic level crossing equipped with road signals only

Kat. D—means level crossing category D—Level crossing not equipped with any LX system

Kat. E—means level crossing category E—Level crossing for pedestrians equipped with systems like for cat. A or B

Kat. F—means level crossing category F—Private level crossings equipped like for cat. A or B.

From 2013 to 2018 there was, in average, 12.5 accidents per year [30], which shows clearly the need to improve the level crossing operation. The SWI system shall improve that at the level of the communication. The system in principle shall support bi-directional communication based on telegrams and confirmation of messages and shall be primary mean to communicate between two operators and the current analogue phone communication will serve as a fallback system.

The SWI system has several components i.e., SWI-BD—database is a recording system, and a place for his administration and configuration files, SWI-IF—transferring data interface with external systems, SWI-PI—human machine interface system unit, responsible for exchanging telegrams between signaller and gatekeeper and SWI-SZ—approach detection unit notifying of the gatekeeper of incoming railway vehicle to level crossing (optional) [31]. The general decomposition of the system is presented in Figure 4.

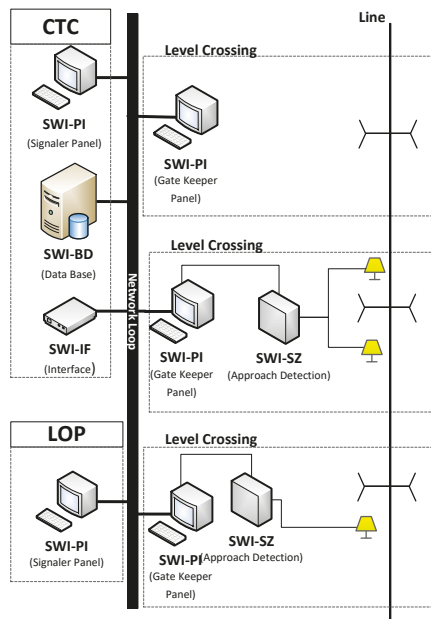

Figure 4. SWI system decomposition [28].

#### 4. Results

At the first stage of the analysis, railway instruction regulating requirements for SWI has been analyzed, and a functional analysis has been done in order to identify the necessary functions that will be performed by the system. The application of the system for railway line no. 7 Warsaw–Lublin at level crossings category A was taken into consideration. As a result of the latter, system functions have been determined, for which an identification number has been assigned and a preliminary information flow has been specified as required in order to perform the function. Below you can find the example of several functions and its decomposition to information flow. In total, there was 52 functions and they were further broke down to 81 information. The Table 1 presents the examples of the SWI system functions.

**Table 1.** Examples of the SWI system functions.

No.	Functions	No. of Inf.	Information
F1	<b>Informing the level crossing attendant that the train has been sent on track</b>	Inf_1	Sending the message about the train sent on track
		Inf_10	Sending the confirmation of the receipt of the message about the train sent on track
		Inf_12	Confirmation of the closed level crossing for the train
		Inf_23	Confirmation of the train having passed
F2	<b>Revocation of the train departure from the station</b>	Inf_2	Revocation of the message about the train departure from the station
		Inf_11	Confirmation of the revocation message
F6	<b>Suspension of shunting movement over the level crossing</b>	Inf_04	Sending the message about the shunting suspension
		Inf_15	Confirmation of the message about the shunting suspension

On the basis of the determined functions, system requirements have been developed and in total there were 81 system requirements. All of the system requirements have been analyzed with application of HAZOP method, with use of the key words:

- “Loss of function”,
- “Excess of function”,
- “Inverse of intended function”,
- “Function done too early”,
- “Function done too late” and
- “Other than intended function”.

The HAZOP method is commonly used in the railway signalling domain and enables the identification of critical elements in the system functionality. The Table 2 presents the extract from HAZOP analysis.

**Table 2.** Extract from HAZOP analysis.

No.	Part of the System	ID_SRS	Function	Sub-Function	Guide Word	Effect	Hazard
1	SWI-PI	SRS_001	F1 Informing the level crossing attendant that the train has been sent on track	Inf_1 Sending the message about the train sent on track	Loss of function	In emergency no possibility to inform users	Several possibilities
2					Excess of function	Lack of influence	No fully operated panel
3					Inverse of intended function	Lack of influence	-
4					Function done too early	Lack of influence	-
5					Function done too late	Loss of function	Wrong operation of panel can lead to event at level crossing
6					Other than intended function	Loss of function	Wrong operation of panel can lead to event at level crossing

Table 2. Cont.

No.	Part of the System	ID_SRS	Function	Sub-Function	Guide Word	Effect	Hazard		
7		SRS-011	F2 - Revocation of the train departure from the station	Revocation of the message about the train departure from the station	Loss of function	Unnecessary closing of the barriers	Level crossing closed.		
8	Excess of function				Unnecessary opening of the barriers when train left	Hazard: the train with higher than 20km/h at level crossing			
9	Inverse of intended function				See above	See above			
10	Function done too early				No influence	-			
11	Function done too late				Unnecessary closing of the barriers	Level crossing closed.			
12	Other than intended function				No influence	-			
13	Loss of function				Unnecessary closing of the level crossing	-			
14	SRS-020				F6 - Suspension of shunting movement over the level crossing	Sending the message about the shunting suspension	Excess of function	Possible shunting movement over the level crossing	Train movement with speed higher than 20 km/h over the level crossing which is not closed
15							Inverse of intended function	Unnecessary closing of the level crossing	-
16							Function done too early	No influence	-
17							Function done too late	Unnecessary closing of the level crossing	-
18		Other than intended function	No influence	-					
19		SRS-021	Confirmation of the message about the shunting suspension	Loss of function			No influence	-	
20				Excess of function			Possible unnecessary speed limitation	-	
21				Inverse of intended function			No influence	-	
22	Function done too early			No influence	-				
23	Function done too late			No influence	-				
24	Other than intended function			No influence	-				

As a result of the HAZOP analysis, consequences of incorrect execution of a given function have been determined and generic hazards have been assigned, which had been identified earlier, as a result of a preliminary hazards analysis. The PHA was actually to derive the generic hazards in form of the preliminary hazard lists. It was done based on the brainstorm meeting and analysis of Hazards Log of the railway infrastructure. The HAZOP was to detail the hazards related with the identified high level functions.

The next step of the analysis was the application of the risk graph. The risk graph method was introduced in Chapter 2 and an example for mentioned functions is graphically shown in Figure 5.

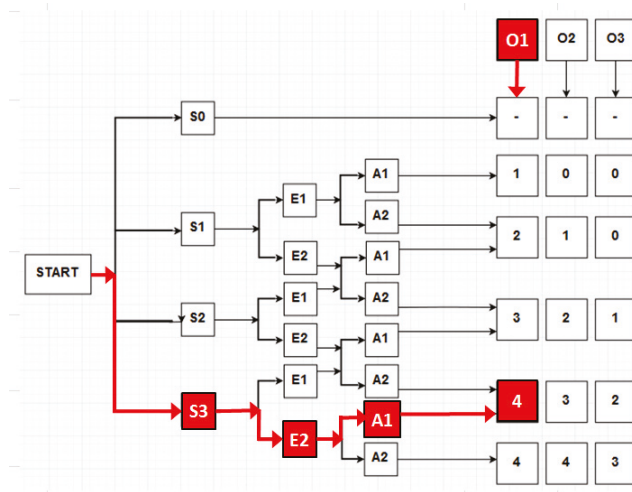

Figure 5. The example of the analysis with risk graph for a given function.

The Table 3 presents exemplary result of the risk analysis for several functions.

Table 3. Exemplary result of the risk analysis for several functions.

ID_SRS	SRS_001
Function	Informing the level crossing attendant that the train has been sent on track
S – potential consequences of the event	In the worst case, if the function breaks down, it is not possible to inform other users about the situation
S level	S3
E – exposure	Traffic control procedures entail that the function is performed often
E level	E2
A – possibility to avoid or limit damages	If the SWI communication module failed/broke down, users are obliged to use the level crossing communication (in accordance with Par. 8 p. 4 of the instruction Ie-113 [2])
A Level	A1
O – probability of the occurrence of the event	By analyzing annual PKBWK reports [12], frequency of the occurrence of dangerous situations has been determined, a railway vehicle running into a road vehicle at level crossings cat. A accounts for 8 times/7 years, i.e., around once every year
Level O	O1
Designated SIL	4 (on the basis of the table from the standard [5] THR has been determined at the level of 10E-09 ≥ THR ≥ 10E-08
ID_SRS	SRS-011
Function	F2 - Revocation of the train departure from the station
S – potential consequences of the event	The worst case is the train approaching the level crossing and operator do not close the barriers due to miscommunication
S level	S3
E – exposure	Rare exposure, because the revocation is not regular procedure
E level	E1
A – possibility to avoid or limit damages	There is no possibility to avoid
A Level	A2
O – probability of the occurrence of the event	By analyzing annual PKBWK reports [12], frequency of the occurrence of dangerous situations has been determined, a railway vehicle running into a road vehicle at level crossings cat. A accounts for 8 times/7 years, i.e., around once every year
Level O	O1

Table 3. Cont.

ID_SRS	SRS_001
Designated SIL	4 (on the basis of the table from the standard [5] THR has been determined at the level of $10E-09 \geq THR \geq 10E-08$ )
ID_SRS	SRS-020
Function	Sending the message about the shunting suspension
S – potential consequences of the event	Train movement with speed higher than 20 km/h over the level crossing which is not closed
S level	S1
E – exposure	Rare
E level	E1
A – possibility to avoid or limit damages	It is not possible to avoid the situation when train is already shunting in the area of the level crossing
A Level	A1
O – probability of the occurrence of the event	By analyzing annual PKBWK reports [12], frequency of the occurrence of dangerous situations has been determined, a railway vehicle running into a road vehicle at level crossings cat. A accounts for 8 times/7 years, i.e., around once every year
Level O	O1
Designated SIL	2
ID_SRS	SRS-021
Function	Confirmation of the message about the shunting suspension
S – potential consequences of the event	Possible unnecessary speed limitation
S level	S0
E – exposure	-
E level	Not applicable
A – possibility to avoid or limit damages	-
A Level	Not applicable
O – probability of the occurrence of the event	-
Level O	Not applicable
Designated SIL	No SIL assigned.

The result of the analysis has provided very good screening of the requirements. The full scope of the analysis was done in 6 sessions with relatively small team. At the workshop the people responsible for safety, engineering, maintenance, and operation were invited. There was in total five people participated with two people experienced in risk assessment (five years' experience) and three people experienced in signalling (from five to eight years). The results have been verified by the safety authority and further by the railway authority at separate meeting. The necessary effort was easy to consider in the project activities including clarification with the user. For the total of 81 functions, 23 were identified as S3 level, so the worst case scenario, no S2 level parameter have been identified, and 4 S1 level were identified. Other functions were estimated at S0 so no further steps in the analysis were necessary. In total, there were 16 SIL3/4 functions identified, but the most important point was the possibility to justify 65 functions at lower safety level i.e., SIL0,1,2, or non SIL.

## 5. Discussion

The results of the analysis for all performed system functions meet the expectation of the Railway Authority. The interesting fact related with adaptation of risk graph shows that with the highest severity (S3) there was only 65% of functions with the highest safety requirements (SIL4). The remaining 35% of cases, after careful analysis, show that two functions have high exposure and only due to the low value of parameters A and O, it was possible to limit the achieved requirement.

The results of the analysis have been presented to the railway infrastructure manager and the next step was to jointly review it. The standard method used by railway infrastructure manager is based on FMEA and RPN analysis. The method is regulated by the Technical and Operational Risk Analysis procedure [32]. Therefore, the authors contrasted their own approach to the methods used so far. As a result of this activity, the value of the parameter "O" has been reduced in some situations, given the fact that the SWI system can only partly contribute to accidents at level crossings, consisting in a railway vehicle running into a road vehicle. It further reduced the achieved SIL [13]. Additionally,

in reference to the initial stage of the analysis, where a set of technical devices performing specific functions was not clearly defined and was treated like a “black box”, the following principle has been adopted: “Worst possible scenario”, “Reasonable estimates”, “Reasonable worst case”. Nevertheless it was not further considered in the article and this approach can be further investigated. Taking into account the principle introduced in [33], which stipulates that the risk related to technical systems, with a plausible likelihood of catastrophic consequences as a direct result of a breakdown, does not need to be further reduced if the frequency of such breakdowns equals or is lower than 10<sup>−9</sup> per hour of the system’s working time. On the basis of the above mentioned activities, the required SIL and THR have been assigned to every function of the system, instead of, like it was the case in earlier analyses made by the infrastructure manager, to the system as a whole.

## 6. Conclusions

The article presents a general description of the risk assessment process and the consequences of setting safety requirements. Especially, explicit risk estimation methods were presented, based on the methods used to meet the safety targets in binding standards and norms dedicated for railway signalling systems. Next, an example has been presented of a risk assessment made with an adapted risk graph for one of the systems used in railway signalling. The system has been chosen because of its relatively short period of operation and taking into account the new requirements of the infrastructure manager. In this light, making a risk assessment was a difficult task. Using the risk graph made it possible to effectively set safety objectives and was warmly received by the infrastructure manager. The results of the study showed that good practice is to consider more parameters in the analysis than only probability and severity. Moreover the semi-qualitative approach was beneficial as well in the deeper analysis and making a better decision as it was possible to investigate better in the review of the analysis results and justification. The really interesting conclusion here is that the analysis initially limit the original requirements of the user, which were done in the more traditional way i.e., based on the experience. The method, with the proposal of adapted parameters of risk graph can be used for classifying safety requirements in this area of railway signalling project. The complexity of the solutions provided in railway environment is getting bigger and bigger and there is strong movement to adopt newest technology in the operation, which of course results in higher risk [34–36], that is why more simple methods are needed to follow this trend in the railways.

**Author Contributions:** Conceptualization, W.Z. and D.S.; methodology, A.K. and P.I.; validation, W.Z. and A.K.; formal analysis, P.I.; investigation, D.S.; resources, A.K. and D.S.; data curation, D.S.; writing—original draft preparation, D.S.; writing—review and editing, P.I.; visualization, D.S. and P.I.; supervision, W.Z.; project administration, D.S. and P.I.; funding acquisition, A.K.

**Funding:** This research receives no funding.

**Acknowledgments:** Special thanks to Wiesław Zabłocki who passed away this year in June. He was a great man, great scientist, and expert in the signalling automation field. He always gave huge support for colleagues, workers, students, and the whole transport community. The authors would like to also thank Cezary Czarkowski who lead the analysis and has big contributions in the analysis principles and its application in Thales company.

**Conflicts of Interest:** The authors declare no conflict of interest.



## Appendix A

## Notations and abbreviations

Table A1. Notations.

Notation	Explanation
SIL	Safety integrity level targets
S	Potential consequences of the event
E	Exposure (time/frequency of exposure to the event)
A	Possibility to avoid or limit damages
O	Probability of the occurrence of the event
P	the frequency of the occurrence of the event, resulting from the hazard. Letter "P" adopts a total value between 1 and 10;
W	probability of the detection of the hazard when the risk control measures applied so far are used. Letter "W" adopts a total value between 1 and 10;
S	the numbers specifying the value of the consequences of the event, and if during the period subject to the assessment more than one event occurs, the average value for the consequences resulting from the hazard. Letter "S" adopts a total value between 1 and 10;

Table A2. Abbreviations.

Abbreviations	Explanation
FMEA	Failure Mode and Effect Analysis
FMECA	Failure mode, effects and criticality analysis
HAZOP	Hazard and Operability study
ETA	Event tree analysis
FTA	Fault Tree Analysis
THR	Tolerable Hazard Rate
SIL	Safety Integrity Level
SWI	Polish language: System Wymiany Informacji (Bi-directional communication system)
RPN	Risk Priority Number
PKBWK	Polish language: Panstwowa Komisja Badan Wypadkow Kolejowych (Polish Committee for Railway Accidents Investigation)
CENELEC	European Committee for Electro technical Standardization
PHA	Preliminary Hazard Analysis
SRS	System Requirements Specification
SRAC	Safety Related Application Condition
PN-EN	Polish Norms – European Norms

## References

1. Szopa, T. *Niezawodność i Bezpieczeństwo (Eng. Reliability and Safety)*; Warsaw Technical Universtiy: Warsaw, Poland, 2009.
2. Aven, T. *Misconception of Risk*; University of Stavanger: Stavanger, Norway; John Wiley & Sons Ltd.: Hoboken, NJ, USA, 2010.
3. Andrzej, L. *Current and New Signalling Systems*; TTS 2-3/2012; Research Institute: Radom, Poland, March 2012; pp. 28–35.
4. Nancy, G. Leveson, Safeware. In *System Safety and Computers*; University of Washington, Addison Wesley: Boston, MA, USA, 1995.
5. PKP PLK S.A. (Infrastructure Manager), Ie-113. *Requirements for the Information Exchange System between Traffic Posts Employees Participating in the Service of the Railway-Road Crossing and the Employee in Charge of the Railway-Road Crossing*; PKP PLK S.A.: Warsaw, Poland, 2015.
6. Aven, T. On how to define, understand and describe risk. University of Stavanger, Norway. *Reliab. Eng. Syst. Saf.* **2010**, *95*, 623–631. [[CrossRef](#)]
7. Aven, T. The risk concept—Historical and recent development trends. University of Stavanger, Norway. *Reliab. Eng. Syst. Saf.* **2012**, *99*, 33–44. [[CrossRef](#)]

8. Elise, G.C.; Kift, R.L. Keeping track of railway safety and the mechanisms of risk. *Saf. Sci.* **2018**, *110*, 195–205.
9. Commission Implementing Regulation of the European Commission No 402/2013 of 30 April 2013 on the Common Safety Method for Risk Evaluation and Assessment and Repealing Regulation (EC) No 352/2009. Available online: <https://eur-lex.europa.eu/LexUriServ/LexUriServ.do?uri=OJ:L:2013:121:0008:0025:EN:PDF> (accessed on 16 October 2019).
10. *Standard PN-EN 50126:2018 Railway Applications—Specification of Reliability, Accessibility, Maintainability and Safety*; CEN-CENELEC Management Center: Brussels, Belgium, 2018.
11. *Standard PN-EN 50129:2007 Railway Applications—Communication, Data Processing and Traffic Control Systems—Electronic Systems of Traffic Control Related to Safety*; CEN-CENELEC Management Center: Brussels, Belgium, 2007.
12. *Standard PN-EN 61508-1:2010 Functional Safety of Electrical/Electrical/Programmable Electronic Systems Related to Safety—Part 1: General Requirements*; CEN-CENELEC Management Center: Brussels, Belgium, 2010.
13. Fuchs, P.; Zajíček, J. Safety Integrity Level (SIL) versus full quantitative risk value. *Maint. Reliab.* **2013**, *15*, 99–105.
14. Gulland, W.G. *Methods of Determining Safety Integrity Level (SIL) requirements—Pros and Cons, Practical Elements of Safety*; Springer: London, UK, 2004; pp. 105–122.
15. Redmill, F.; Chudleigh, M.; Catmur, J. *System Safety: HAZOP and Software HAZOP*; John Wiley & Sons: Chichester, UK, 1999.
16. Ericson, C.A., II. *Hazard Analysis Techniques for System Safety*; John Wiley & Sons: Hoboken, NJ, USA, 2005.
17. *Standard PN-EN 61882:2016-07 Studies of hazards and operability (HAZOP studies)*. In *Application Guide*; CEN-CENELEC Management Center: Brussels, Belgium, 2016.
18. Hwang, J.; Jo, H. Hazard Identification of Railway Signalling System Using PHA and HAZOP Methods. *Int. J. Autom. Power Eng.* **2013**, *2*, 32–39.
19. Baybutt, P. Calibration of risk matrices for process safety, Primatch Inc., Columbus, OH, USA. *J. Loss Prev. Process Ind.* **2015**, *38*, 163–168. [[CrossRef](#)]
20. Baybutt, P. An improved risk graph approach for determination of safety integrity levels (SILs). *Process Saf. Prog.* **2006**, *26*, 66–76. [[CrossRef](#)]
21. Zhang, W.; Lan, N.; Li, X. Estimation Technology of Safety Integrity Level of Safety-Related Systems in High Speed Train, School of Reliability and System Engineering, Beihang University. *IERI Procedia* **2012**, *1*, 172–177.
22. Berrado, A.; El-Koursi, E.; Cherkaoui, A.; Khaddour, M. A Framework for Risk Management in Railway Sector: Application to Road-Rail Level Crossings. *Open Transp. J.* **2011**, *5*, 34–44. [[CrossRef](#)]
23. Restel, F.; Wolniewicz, L. Tramway Reliability and Safety Influencing Factors. *Procedia Eng.* **2017**, *187*, 477–482. [[CrossRef](#)]
24. Szmel, D.; Wawrzyniak, D. Application of FMEA Method in Railway Signalling projects. *J. KONBiN* **2017**, *42*, 93–110. [[CrossRef](#)]
25. *Standard PN-EN 60812:2009 System Fault Analysis Techniques Fault Modes and Effects Analysis (FMEA)*; CEN-CENELEC Management Center: Brussels, Belgium, 2009.
26. Baybutt, P. On the completeness of scenario identification in process hazard analysis (PHA), Primatch Inc., Columbus, OH, USA. *J. Loss Prev. Process Ind.* **2018**, *55*, 492–499. [[CrossRef](#)]
27. *Standard PN-EN 61025:2007 Fault Tree Analysis (FTA)*. 2007. Available online: [https://infostore.saiglobal.com/en-us/Standards/PN-EN-61025-2007-949989\\_SAIG\\_PKN\\_PKN\\_2232975/](https://infostore.saiglobal.com/en-us/Standards/PN-EN-61025-2007-949989_SAIG_PKN_PKN_2232975/) (accessed on 16 October 2019).
28. *Standard PN-EN 62502:2011 Reliability Analysis Techniques Events Tree Analysis (ETA)*. 2011. Available online: <https://shop.bsigroup.com/ProductDetail?pid=00000000030169893> (accessed on 16 October 2019).
29. *The State Committee for Railway Accidents, Ministry of Infrastructure and Construction, Annual Reports for 2011–2017 on the Activities of the State Committee for Railway Accidents*; National Safety Authority: Warsaw, Poland, 2018.
30. *National Safety Authority Safety Report for Year 2018*; Railway Transport Authority: Warsaw, Poland, 2019; ISBN 978-83-65709-35-6.
31. Materials of Thales company (agreed to be presented in the paper as they are official documents)
32. PKP PLK, S.A. *SMS/MMS-PR-02 Technical and Operational Risk Assessment*; PKP PLK S.A Procedure: Warsaw, Poland, 2014.

33. Sobral, J.; Soares, C.G. Assessment of the adequacy of safety barriers to hazards. *Saf. Sci.* **2019**, *114*, 40–48. [[CrossRef](#)]
34. Aven, T.; Kristensen, V. How the distinction between general knowledge and specific knowledge can improve the foundation and practice of risk assessment and risk-informed decision-making. *Reliab. Eng. Syst. Saf.* **2019**, *119*, 106553. [[CrossRef](#)]
35. Le Coze, J.C. Safety as Strategy: Mistakes, failures and fiascos in high-risk systems. *Saf. Sci.* **2019**, *116*, 259–274. [[CrossRef](#)]
36. Jensen, A.; Aven, T. A new definition of complexity in risk analysis setting. *Reliab. Eng. Syst. Saf.* **2018**, *117*, 169–173. [[CrossRef](#)]



© 2019 by the authors. Licensee MDPI, Basel, Switzerland. This article is an open access article distributed under the terms and conditions of the Creative Commons Attribution (CC BY) license (<http://creativecommons.org/licenses/by/4.0/>).



MDPI  
St. Alban-Anlage 66  
4052 Basel  
Switzerland  
Tel. +41 61 683 77 34  
Fax +41 61 302 89 18  
[www.mdpi.com](http://www.mdpi.com)

*Sustainability* Editorial Office  
E-mail: [sustainability@mdpi.com](mailto:sustainability@mdpi.com)  
[www.mdpi.com/journal/sustainability](http://www.mdpi.com/journal/sustainability)





MDPI  
St. Alban-Anlage 66  
4052 Basel  
Switzerland

Tel: +41 61 683 77 34  
Fax: +41 61 302 89 18

[www.mdpi.com](http://www.mdpi.com)



ISBN 978-3-03936-554-8