

Chopra, Felix; Eisenhauer, Philipp; Falk, Armin; Graeber, Thomas W

Working Paper

Intertemporal Altruism

IZA Discussion Papers, No. 14059

Provided in Cooperation with:

IZA – Institute of Labor Economics

Suggested Citation: Chopra, Felix; Eisenhauer, Philipp; Falk, Armin; Graeber, Thomas W (2021) : Intertemporal Altruism, IZA Discussion Papers, No. 14059, Institute of Labor Economics (IZA), Bonn

This Version is available at:

<https://hdl.handle.net/10419/232811>

Standard-Nutzungsbedingungen:

Die Dokumente auf EconStor dürfen zu eigenen wissenschaftlichen Zwecken und zum Privatgebrauch gespeichert und kopiert werden.

Sie dürfen die Dokumente nicht für öffentliche oder kommerzielle Zwecke vervielfältigen, öffentlich ausstellen, öffentlich zugänglich machen, vertreiben oder anderweitig nutzen.

Sofern die Verfasser die Dokumente unter Open-Content-Lizenzen (insbesondere CC-Lizenzen) zur Verfügung gestellt haben sollten, gelten abweichend von diesen Nutzungsbedingungen die in der dort genannten Lizenz gewährten Nutzungsrechte.

Terms of use:

Documents in EconStor may be saved and copied for your personal and scholarly purposes.

You are not to copy documents for public or commercial purposes, to exhibit the documents publicly, to make them publicly available on the internet, or to distribute or otherwise use the documents in public.

If the documents have been made available under an Open Content Licence (especially Creative Commons Licences), you may exercise further usage rights as specified in the indicated licence.

DISCUSSION PAPER SERIES

IZA DP No. 14059

Intertemporal Altruism

Felix Chopra
Philipp Eisenhauer
Armin Falk
Thomas Graeber

JANUARY 2021

DISCUSSION PAPER SERIES

IZA DP No. 14059

Intertemporal Altruism

Felix Chopra

University of Bonn

Philipp Eisenhauer

University of Bonn

Armin Falk

brq Institute on Behavior and Inequality, University of Bonn and IZA

Thomas Graeber

Harvard Business School and IZA

JANUARY 2021

Any opinions expressed in this paper are those of the author(s) and not those of IZA. Research published in this series may include views on policy, but IZA takes no institutional policy positions. The IZA research network is committed to the IZA Guiding Principles of Research Integrity.

The IZA Institute of Labor Economics is an independent economic research institute that conducts research in labor economics and offers evidence-based policy advice on labor market issues. Supported by the Deutsche Post Foundation, IZA runs the world's largest network of economists, whose research aims to provide answers to the global labor market challenges of our time. Our key objective is to build bridges between academic research, policymakers and society.

IZA Discussion Papers often represent preliminary work and are circulated to encourage discussion. Citation of such a paper should account for its provisional character. A revised version may be available directly from the author.

ISSN: 2365-9793

IZA – Institute of Labor Economics

Schaumburg-Lippe-Straße 5–9
53113 Bonn, Germany

Phone: +49-228-3894-0
Email: publications@iza.org

www.iza.org

ABSTRACT

Intertemporal Altruism*

Standard consumption utility is linked in time to a consumption event, whereas the timing of prosocial utility flows is ambiguous. Prosocial utility may depend on the actual utility consequences for others – it is consequence-dated – or it may be related to the act of giving and is thus choice-dated. Even though most prosocial decisions involve intertemporal trade-offs, existing models of other-regarding preferences abstract from the time signature of utility flows, limiting their explanatory scope. Building on a canonical intertemporal choice framework, we characterize the behavioral implications of the time structure of prosocial utility. We conduct a high-stakes donation experiment that allows us to identify non-parametrically and calibrate structurally the different motives from their unique time profiles. We find that the universe of our choice data can only be explained by a combination of choice- and consequence-dated prosocial utility. Both motives are pervasive and negatively correlated at the individual level.

JEL Classification: C91, D12, D64, D90

Keywords: altruism, donation, intertemporal decision-making, time inconsistency

Corresponding author:

Armin Falk
Institute on Behavior and Inequality (briq)
Schaumburg-Lippe-Straße 5-9
D-53113 Bonn
Germany
E-mail: armin.falk@uni-bonn.de

* The experiments in this paper were approved by the Ethics Committee of the Economics Department at the University of Bonn (reference no. 2016-02). For helpful comments and discussions we are grateful to Alexander Cappelen, Bertil Tungodden, Christine Exley, Florian Zimmermann, James Konow, Johannes Abeler, Jörgen Weibull, George Loewenstein and Nicola Lacetera. Armin Falk acknowledges financial support from the German Research Foundation through the Leibniz Program as well as European Research Council Project 340950—Institutions and Morality.

1 Introduction

In prosocial decision-making, choices and consequences are typically separated in time. For example, monetary donations or climate-friendly behavior create immediate costs to the donor and delayed benefits for others. When committing to voluntary work, both the costs to the donor and the benefits to others are delayed. Repeated interactions such as reciprocal exchange naturally involve intertemporal considerations. I may expect to reciprocate a favor from someone else later on, trading off an earlier benefit against a delayed cost. The inherent intertemporal nature of prosocial choice raises questions about how choice environments affect the timing and level of prosocial choices, as well as how we should generally think about the timing of the utility flows associated with prosocial decisions.

Notably, the existing literature on other-regarding preferences abstracts from the time dimension of utility flows. For example, outcome-based models of inequity aversion do not specify how to evaluate inequality that occurs across two points in time (see e.g. Fehr and Schmidt, 1999; Bolton and Ockenfels, 2000). To illustrate, consider a simple donation or dictator game where the payment to the recipient is delayed. Do inequity-averse donors discount the corresponding recipient's utility in the same way as they discount their own utility? Do their social preferences apply to the discounted utility stream (of self and recipient) or do they care about period-specific inequality? These timing-related considerations are not unique to inequity aversion but apply to other forms of social preferences alike. In formal models of reciprocity (Charness and Rabin, 2002; Falk and Fischbacher, 2006; Dufwenberg and Kirchsteiger, 2004), social interactions are conceptualized as being inherently "time-less." Implicitly, returning a favor one year later is just as worthwhile as returning a favor now, simply because the potential role of delays is not accounted for. The concept of warm glow (Andreoni, 1989, 1990) explicitly suggests that utility may derive from the act of choice itself rather than the prosocial externality, although the corresponding theories do not distinguish between the timing of choice and potentially-delayed consequences.¹ Similarly, models of image concerns (Bénabou and Tirole, 2006) do not specify whether image utility accrues at the point of prosocial choice or if it is tied to the timing of its consequences or observability.²

¹Despite the absence of time, some scholars have been aware of its relevance. For example, Andreoni and Payne (2003) hinted at this idea in the context of charitable donations, where "[...] the benefits can flow before the costs are paid".

²Despite being left unspecified in theory, one may argue that different psychological motives are indeed associated with distinct time profiles of utility flows. For example, *social* image utility requires the presence of an "audience" and thus its timing may be depend on the visibility to the audience. However, with respect to *self*-image, utility may be related to the timing of choice. The concept of "warm glow" is explicitly linked to the act of giving and as such it might occur at the time of choice. Reciprocity requires some degree of forecasting others' behavior and corresponding utility flows may be more closely linked to actual consequences.

These examples illustrate that existing models of other-regarding preferences are incomplete unless choices and consequences occur immediately. Intuitively, an atemporal model delivers arbitrary predictions that follow from the auxiliary assumptions required to account for the timing of choices and consequences. The common practice of modeling prosocial behavior as atemporal therefore severely limits our scope for understanding prosocial behavior in practice, which typically features a separation of choices and consequences over time. This gap in the literature calls for more discipline on the role of delays in theoretical and empirical work on prosocial behavior.

To shed light on the intertemporal nature of prosocial preferences, this paper studies self-other trade-offs with consequences that are spread out over time. For this purpose, we proceed in three steps. First, we develop a conceptual distinction between *consequence-dated* and *choice-dated* utility in modeling intertemporal prosocial choice. In the former case, utility accrues with a delay that corresponds to when the actual utility consequences for others materialize, while in the latter case utility is realized in temporal proximity to the act of giving.³ We derive qualitative predictions for choice- and consequence-dated decisions involving three types of trade-offs: only within a single domain (self or other), self-other trade-offs that do not involve differently-dated consequences, and situations that require joint self-other and intertemporal trade-offs. While consequence-dated prosocial utility naturally nests the canonical discounted utility model, we characterize the implications of choice-dated utility as a departure from standard intertemporal choice theory. Second, we conduct a laboratory study and establish a set of baseline patterns in atemporal and intertemporal donation behavior in light of these model predictions. For this purpose, we implement a fully-crossed study design of choices involving payments to the subjects and charitable donations with (a) a cross-attribute or no cross-attribute trade-off and (b) an intertemporal or atemporal trade-off. Third, we examine these patterns quantitatively using structural calibrations and link our findings back to research on the underlying prosocial motivations.

To experimentally study the intertemporal dimension of prosocial choice in a meaningful way, we implement a choice paradigm with far-ranging real-world implications. In our incentivized, high-stakes donation paradigm, each participant could save human lives by individually causing donations of up to 800 Euro for the treatment of tuberculosis patients by a designated charity, and earn up to 200 Euro for themselves. The unusually high incentives serve to render both the donation context and the implemented delays meaningful to subjects. The experiment comprises two sections: a series of intertemporal choice tasks in which participants decided between dated certain payments

³Take the example of donating to a charity today: choice-dated utility refers to an altruistic donor who experiences a positive utility today, whereas a consequence-dated motivation means that they care about some time in the future when the donation actually benefits the recipient.

to themselves or the charity for delays of up to twelve months,⁴ and a series of atemporal risky choice tasks to characterize participants' multi-attribute utility function representing preferences for "self-Euro" and "charity-Euro". The first section on intertemporal choice comprises three blocks. Across blocks, we vary whether choices present trade-offs (a) between earlier and later payments in a single utility domain (only self-Euro or only charity-Euro), (b) trade-offs between payments in different domains that involve a unique, common payment date either now or in the future, and (c) trade-offs across domains and time dates, requiring multi-attribute comparisons across time. This setup systematically examines behavior when either only time matters, (a), only cross-attribute comparisons matter, (b), or both, (c) providing a particularly rich set of data that allows for sharp tests of the canonical discounted utility model of intertemporal choice in the multi-attribute case. We deliberately use a design with monetary pay-offs because *prosocial* utility flows are rarely associated with primary consumption by the decision-maker such as food or effort; because our focus is on the application of monetary donations; and because our interest includes time horizons in excess of one month, which have not been implemented using real-effort designs.⁵ The recent methodological review by Cohen et al. (2019) discusses situations in which money designs may be preferable to real-effort paradigms, which we believe includes our case of studying prosocial utility flows that are typically not yoked to primary consumption by the decision-maker.⁶ Our design deliberately abstracts from the issue of present bias and the phenomenon of extreme short-run impatience by implementing payments as wire transfers. Even the soonest possible experimental payment was subject to a delay of three days, which is conventionally considered to be part of the future. For all choice tasks, we use a variant of the well-established multiple price list methodology.⁷ For the risky choice section, we implement a *risk apportionment* approach (Eeckhoudt and Schlesinger, 2006; Deck

⁴A potential concern about delaying a donation is that the timing may not affect the operations of a liquidity-unconstrained charity. However, the charity *Operation ASHA* that we work with has a flexible operative model appointing field workers "on demand", and assured that funds received through this experiment would affect their field operations within very short time horizons. This was conveyed to subjects in the experimental instructions. Moreover, our empirical results clearly indicate that subjects found the variation in delays of donations relevant.

⁵Real effort experiments have only been conducted for short time horizons of up to a few weeks for logistical reasons, such as trust issues and attrition (Augenblick, 2019; Augenblick and Rabin, 2018).

⁶Outside of the topic of other-regarding preferences, it has been pointed out that money designs may confound the timing of payments with the timing of primary consumption (Cubitt and Read, 2007; Chabris et al., 2008). The emergent view in this literature may be that subjects tend to treat money like consumption (perhaps due to narrow bracketing), except for very short time horizons (Cohen et al., 2019; Augenblick, 2019; Halevy, 2015; Balakrishnan et al., 2020).

⁷There are alternative methodologies, including the recent innovation of convex time budgets (Andreoni and Sprenger, 2012). While convex time budgets do not require a separate estimation of the utility function, we prefer the "double multiple price list" method of characterizing the atemporal utility function using separate choices (e.g. Andersen et al., 2008) to examine the features of the multi-attribute atemporal utility function in more detail and circumvent the issue of bunching at the boundaries and choice inconsistencies frequently observed with convex time budgets (Chakraborty et al., 2017).

and Schlesinger, 2010, 2014), which provides direct tests for the form of multi-attribute utility at any order without parametric assumptions. At the same time, our data allow flexibly calibrating a wide range of utility specifications by placing additional structural assumptions on the utility function. We collect data on second- and third-order risk aversion, as well as multivariate risk aversion (Richard, 1975) between payments to the self and the charity.

We separate our main results into reduced-form and structural findings. Our reduced-form findings comprise non-parametric evidence compatible with consequence-dated but not pure choice-dated prosocial utility, and choice patterns that are specifically in line with choice-dated but not consequence-dated prosocial utility for any possible discount function.

With respect to the first finding, in smaller-sooner, larger-later choices involving either only self-Euro or only charity-Euro, subjects not only discount delayed self-Euro but also delayed charity-Euro payments. The notion that delayed donations are worth less to subjects implies that valuations of charity-Euro are linked to their payment date. This is the core prediction of consequence-dated prosocial utility: charitable contributions have delayed consequences for others that are linked to the timing of donations. This qualitative devaluation pattern of delayed donations obtains for *all* intertemporal decisions that involve a time trade-off between the two choice options, including cross-attribute intertemporal decisions. Next, and more strikingly, net present values measured for delayed self-Euro and delayed charity-Euro are statistically indistinguishable. In fact, non-parametric analyses imply that our combined data from atemporal choices and choices involving time trade-offs are specifically in line with the discounted utility specification of consequence-dated utility, i.e. an intertemporal utility function that applies the same discount function to future utility streams generated by self-Euro and charity-Euro payments.⁸ At the same time, the delay-dependent valuation of donations in choices with time trade-offs contradicts pure choice-dated utility.

With respect to the second reduced-form finding, we report that when contemporaneous, identically-dated self-Euro and charity-Euro payments are delayed into the future, subjects become increasingly willing to give up self-Euro than charity-Euro as the delay increases. These choices that create a cross-attribute but no time trade-off imply a declining subjective exchange rate between charity-Euro and self-Euro. To our knowledge, ours is the first dataset that allows documenting such a pattern based on experimental variation. This finding is incompatible with a stationary flow utility function as posited by the discounted utility model: because identically-dated utility flows

⁸Non-parametric tests of risky choice patterns indicate that the marginal utility function representing utility from self-Euro and charity-Euro have the same curvature and only differ by a multiplicative constant. Identical net present values as displayed in Panel A then imply a domain-independent discount function.

are subject to the same discount factor, the effect of discounting cancels out. Instead, the forward exchange rate finding suggests that the utility of donating has a component that is not subject to discounting. If prosocial utility from donating (partly) accrues at the time of choice and is independent from the timing of the actual payment, a declining subjective exchange rate can be rationalized. In fact, assuming a stationary date-of-payment-related prosocial utility, the only way to rationalize a declining subjective exchange rate is to have a choice-dated component of prosocial utility, a direct violation of the stationarity axiom of discounted utility.

Our reduced-form findings hence suggest the presence of both types of prosocial utility, namely choice-dated and consequence-dated utility. None of the existing models of prosocial preferences are compatible with this combination of motives. In fact, the assumed psychological mechanisms typically suggest the presence of only one type of utility. For example, models assuming warm glow or self-image concerns are consistent with the notion of choice-dated gratification related to the act of giving, which explains the exchange rate finding.⁹ Likewise, consequence-dated motivations such as "pure altruism" are a natural contender for subjects' devaluation of delayed donations when time trade-offs are involved.¹⁰ In view of the limitations of existing prosocial preference models, we propose a simple model of intertemporal prosocial choice that separately accommodates both consequence-dated and choice-dated utility flows. We fit this model to our data using structural estimations at both the population and subject level.

The structural analysis provides two key insights. First, it reconfirms and complements the reduced-form findings. Our estimates of standard preferences parameters are quantitatively in line with previous work, i.e. we obtain a median subject-level parameter estimate of 0.906 for the one-year discount factor and an estimate of relative risk aversion of 0.661. More compellingly, we estimate plausible magnitudes for the parameters characterizing consequence-dated prosociality (median parameter estimate of the weight on charity-Euro of 0.353) and choice-dated prosociality (median parameter estimate implies choice-dated utility of 0.481). The calibrated structural model replicates the distinctive choice patterns identified in our reduced-form analysis and adds a quantitative interpretation. For example, the model yields a declining forward exchange rate because the relative weight of choice-dated utility in the discounted prosocial utility

⁹Adding to this, the shape of the forward exchange rate sheds light on the role of impatience as a potential "excuse" to behave selfishly. A growing body of literature finds that charitable giving is sensitive to the presence of excuses and people frequently "adjust" their preferences such as risk attitudes (Exley, 2015) or their propensity to commit reasoning errors (Exley and Kessler, 2019) as fudge factors operating as a "veil" to hide their selfish motives. A decreasing exchange rate has the *opposite* implication: as a common delay to self-Euro and charity-Euro payments is introduced, people implicitly behave as if they are more patient about charity-Euro, meaning that introducing the flexibility of discounting different outcomes differentially *increases* prosociality here.

¹⁰"Pure altruism" captures a person's genuine concern for the utility consequences of their decision for others (e.g. Warr, 1982; Roberts, 1984; Bergstrom et al., 1986).

increases and thus overall prosocial utility declines less quickly in the delay than the discounted utility from equally-delayed self-Euro. In our baseline estimations, the utility of a 50-Euro donation exceeds that of a 50-Euro payment to the subject for delays in excess of 8.5 years. Second, the structural analysis sheds light on the individual-level variation of parameters, revealing that the different forms of prosociality display marked heterogeneity. We find that 80% of subjects exhibit meaningful positive consequence-dated and just below 60% of subjects exhibit meaningful positive choice-dated prosociality. Strikingly, the two parameters are strongly negatively correlated at the subject level, with a Spearman correlation coefficient of -0.42. This negative relationship indicates that differently-dated prosocial motivations might characterize distinct “types” of subjects. Some are primarily driven by consequence-dated motives such as pure altruism, whereas others seem to follow choice-date motivations such as image concerns or the feeling of warm glow.

This paper makes three contributions. First, it provides the first comprehensive experimental dataset on intertemporal prosocial behavior using a fully-crossed design of choices involving single vs. cross-attribute trade-offs – self-Euro vs. charity-Euro payments – and short vs. long delays. The concept of a “forward exchange rate” characterizes behavior for increasing, *common* delays, which provides a non-parametric test of the discounted utility model. Accordingly, our experimental approach allows us to address questions about the nature of intertemporal prosocial trade-offs that cannot be answered with a subset of this data. Previous research focuses on partial delays of payoffs in dictator games (Dreber et al., 2016; Kovarik, 2009) or the effect of a possible commitment to future donations (Bremner, 2011; Rogers and Bazerman, 2008). Other related experimental work analyzes the role of time inconsistency and present bias in prosocial choice (Kölle and Wenner, 2018). While our account also rationalizes the bulk of the evidence provided, it does so via the time pattern of flow utility rather than a hyperbolic shape of the discount function.

Second, our distinction between consequence-dated and choice-dated prosocial motives complements existing research on what motivates contributions to public goods and charitable giving. While departing from existing work in terms of our focus on the time dimension rather than – for example – the impact of one’s generosity and the corresponding “neutrality” hypothesis (Andreoni, 1989), we view the distinction drawn here as a natural extension and re-interpretation of the work on warm glow and pure altruism. Focusing exclusively on intertemporal arguments leads us to conclude the existence of mixtures of both motives, which provides an independent affirmation of previous work that similarly reports mixed motivations, i.e. “impure altruism” (Andreoni, 1993; Bolton and Katok, 1998; Konow, 2006). Our finding of correlation aversion – i.e. that the marginal utilities of self-Euro and charity-Euro payments are not independent –

leads to the substantive interpretation that own earnings and donations are partial substitutes. This underscores the emerging consensus on a relationship between income, wealth and charitable giving (Meer and Priday, 2020).

Third, our findings inform work on intertemporal multi-attribute utility more generally. The literature has only recently started to explore the ramifications of multi-attribute utility functions for modeling intertemporal choice (Andersen et al., 2018). Related empirical work studies the patterns of multi-attribute, intertemporal choices (Cubitt et al., 2018), but looks at typical consumption goods rather than self-other trade-offs and – unlike our paper – does not quantify the effects using structural calibrations. While our results from single-domain discounting choices are in line with a unique, domain-general discount function, which is a key assumption of the discounted utility model, previous studies report discounting patterns that sometimes differ across goods (Chapman, 1996; Frederick, 2006; Hardisty and Weber, 2009; Kim et al., 2013; McClure et al., 2007). These studies have different objectives from ours and consequently they do not separately account for the shape of the atemporal utility function and do not rely on high-stakes experimental designs.

Section 2 lays out a theoretical framework for our argument. Section 3 describes the experimental design and procedures. We present our reduced-form results in Section 4 and the structural analyses in Section 5. Finally, Section 6 concludes.

2 Conceptual framework

Standard economic analysis assumes that utility is derived from primary consumption such as food. Prosocial choices such as donations are usually not associated with primary rewards, requiring additional assumptions about the sources of utility. For example, research in psychology allows for a broader notion of consumption that is not limited to physical consumption but rather involves forms of “conceptual consumption” that occur entirely in the mind (e.g. Ariely and Norton, 2009; Schelling, 1988). The economics literature on prosocial preferences puts forward a variety of motives such as intentions (Falk and Fischbacher, 2006) or image concerns (Bénabou and Tirole, 2006) that are similarly independent of primary consumption by the decision-maker. The variety of existing prosocial motivations naturally lends itself to a distinction in terms of the time structure of corresponding utility flows. We apply the canonical notion of dated period utility from intertemporal choice theory and disentangle two constituent elements of prosocial behavior: the act of making a prosocial choice, and the consequences of this choice for others. Prosocial utility flows are choice-dated if they realize in temporal proximity to the act of giving itself, or they are consequence-dated if they accrue closer to

when the actual utility consequences for others materialize. What does this basic conceptual distinction imply for intertemporal prosocial choice, and conversely what can be learned from intertemporal choice patterns about the nature of prosocial preferences?

To address this question, we discuss the implications of models in which decision-makers receive (i) only consequence-dated prosocial utility or (ii) only choice-dated prosocial utility. While actual prosocial utility may encompass both forms, we introduce the extreme cases as an instructive simplification, which serves as the basis for considering mixed forms.

Let t index the current period in which a choice is made and τ denote the time relative to the period of choice. Let $x_{t+\tau}$ represent a dated payment to the decision-maker at time $t + \tau$ (“self-Euro”). Moreover, let $g_{t+\tau}$ denote a dated payment to a fixed charity at time $t + \tau$ (“charity-Euro”). The decision-maker has preferences over dated payment streams $z = (x_{t+\tau}, g_{t+\tau})_{\tau \in \mathbb{N}}$ that can be represented by an intertemporal utility function, $U(z)$. We do not assume a specific form of prosocial preferences at this stage and treat self-Euro $x_{t+\tau}$ and charity-Euro $g_{t+\tau}$ as direct inputs to the utility function.¹¹ To simplify the following analysis, we interpret payment dates as representing the corresponding consumption dates.

Note that our approach of specifying payments to others as a direct input into the utility function of the decision-maker is consistent with the interpretation that the decision-maker’s prosocial utility truly depends on the *utility* – rather than the pay-off – consequences for others: under the assumption that the recipient’s utility is monotonic in the payments that they receive and approximated in time by the payment dates, our conclusions remain the same. We merely abstain from explicitly specifying the recipient’s utility function for simplicity.¹²

2.1 Consequence-dated prosocial utility

First, consider the case of consequence-dated prosocial utility. The defining feature of these models is that the prosocial utility of a donation to charity $g_{t+\tau}$ at time $t + \tau$ will also accrue at $t + \tau$, even if it was caused by a choice at an earlier point in time t . Thus, making a choice between two dated payments to charity with different payment dates requires an intertemporal comparison of prosocial utility. This allows us to apply

¹¹Here we make the assumption that payments directly enter the utility function for simplicity. As our primary interest is in the timing of utility consequences for others, this can be interpreted as payment dates serving as a proxy for the conversion of money into utility for the self or others, or as (sufficiently delayed) monetary payments being treated as consumption goods for practical purposes, which is commonly argued in the literature on intertemporal choice (Balakrishnan et al., 2020; Halevy, 2015). See also the related discussion on discounting financial flows versus utility in Section 3.

¹²If we assume that the other person’s utility is – ceteris paribus – a monotone function $v(g)$ of donations, we can substitute $v(g)$ for g in the utility function and study the reduced form.

a theoretical foundation to which economic tools are already well adapted, assuming that the decision-maker behaves as if she maximizes her *discounted* intertemporal utility. Models of consequence-dated prosocial utility are then subsumed by the intertemporal utility function

$$U_t = \sum_{\tau=0}^{\infty} D(\tau)u(x_{t+\tau}, g_{t+\tau}). \quad (1)$$

We make the standard assumptions (Cohen et al., 2019) that there is a stationary discount function, $D(\tau)$, that applies to future utility flows represented by a stationary flow utility function, $u(x_{t+\tau}, g_{t+\tau})$, which captures the decision-maker’s concern for herself and others.

Two remarks about this specification are in order. First, while we remain deliberately agnostic about the precise psychological motives underlying consequence-dated prosocial utility, *pure altruism* provides a natural interpretation of Equation (1). A pure altruist cares about the welfare consequences of their choices, which in the model is determined by $g_{t+\tau}$. Any self-other trade-off then involves interpersonal utility comparisons, suggesting the interpretation of u as the decision-maker’s subjective welfare function for evaluating contemporaneous consequences of her choices to the self and others.¹³ Second, a complementary perspective on the intertemporal utility function in Equation (1) is the natural extension of the workhorse model of intertemporal choice – *discounted utility* – to the multi-attribute case, because it conceptualizes self-Euro and charity-Euro as conventional arguments of a flow utility function. This means that interpreting prosocial behavior in an intertemporal context through the lens of multi-attribute discounted utility is akin to adopting the perspective of consequence-dated prosocial utility.

2.2 Choice-dated prosocial utility

By contrast, the defining feature of choice-dated prosocial utility is that the prosocial utility of a dated donation $g_{t+\tau}$ accrues in the period t in which it was *caused* through a choice, even if the payment is executed at a later date $t+\tau$. Choice-dated prosocial utility encompasses a range of motives, most prominently including the feeling of “warm glow” that is explicitly defined as being related to the act of giving (Andreoni, 1989, 1990), as well as self-image or social image concerns that are routinely characterized as being linked in time to the act of donating rather than the instrumental value of charitable funds. We do not take a stance on the psychological micro foundations of choice-dated utility and its specific relationship to the size of a donation. We instead assume as its defining feature that it is unaffected by the timing of donation payments, implying that

¹³Note that this interpretation nests the decision-maker’s preferences over self-Euro if we set $g_{t+\tau}$ to zero.

earlier and later donations to charity generate the same utility to the decision-maker. This is a theoretical distinction between consequence-dated and choice-dated prosocial utility that allows us to obtain sharp qualitative predictions.¹⁴ We can then represent choice-dated prosocial utility with the following intertemporal utility function:

$$U_t = \sum_{\tau=0}^{\infty} \alpha(g_{t+\tau}) + \sum_{\tau=0}^{\infty} D(\tau)u(x_{t+\tau}) \quad (2)$$

where $\alpha(g_{t+\tau})$ is the choice-dated and immediate prosocial utility that results from causing a future donation today.¹⁵

2.3 Qualitative predictions

What do models of choice-dated and consequence-dated prosocial utility predict for intertemporal choices involving self-Euro and charity-Euro? We discuss their predictions for each of the three trade-offs depicted in Figure 1 in turn: pure time trade-offs (univariate discounting, UD_{τ}), pure across-domain trade-offs (subjective exchange rates, F_{τ}) and mixed across-time and across-domain trade-offs (multivariate discounting, MD_{τ}).¹⁶

We begin with the horizontal axes in Figure 1, which capture the standard case of *univariate discounting* (UD). To fix ideas, suppose that the decision-maker can choose between receiving m_t charity-Euro (self-Euro) at time t or receiving a larger payment of $m_{t+\tau}$ charity-Euro (self-Euro) at a later time $t + \tau$. The prediction of consequence-dated prosocial utility – or any model of multi-attribute discounted utility – is that the value of charity-Euro (self-Euro) decreases by $D(\tau)$ with the additional delay τ . While choice-dated prosocial utility necessarily makes the same qualitative prediction of univariate discounting of self-Euro, the immediate gratification from giving to charity, $\alpha(g)$, is not subject to discounting because it accrues immediately.

Prediction 1. *Delayed charity-Euro are discounted in consequence-dated models but not in choice-dated models of prosocial behavior. Both models predict discounting of delayed self-Euro.*

¹⁴For example, if immediate choice-dated utility from giving a fixed amount g at time $t + \tau$ decreases in τ similar to the discount factor, $D(\tau)$, the decision-maker behaves as if his preferences can be represented by a model of consequence-dated prosocial utility. On the other hand, if immediate choice-dated prosocial utility from a dated donation to charity at time $t + \tau$ devalues at a lower rate than the discount factor, the value of giving will appear relatively more stable – and even constant for large τ – compared to the value of the same donation in a model with consequence-dated prosocial utility as in Equation (1). This motivates our first-order approximation.

¹⁵As in the previous case, we abstract from issues related to intertemporal utility comparison by assuming that the decision-maker discounts future utility from self-Euro.

¹⁶In Section B in the Appendix, we discuss the case of choice-dated prosocial utility more extensively under weaker assumptions, and obtain qualitatively similar predictions.

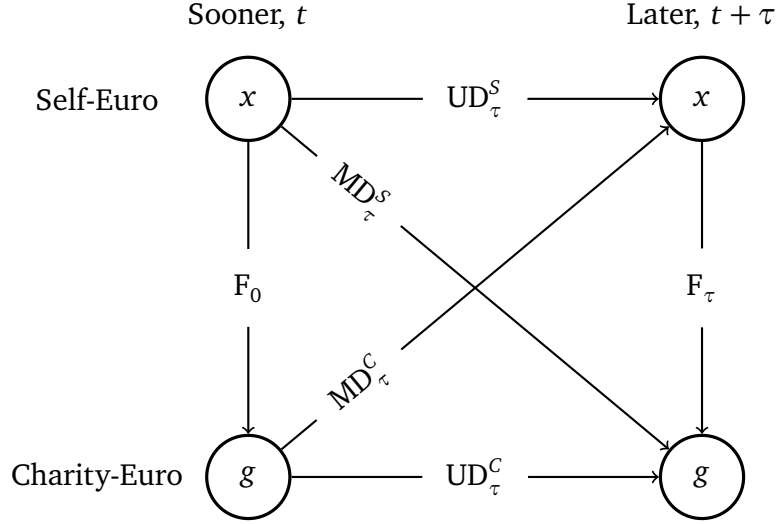

Figure 1: This figure displays three intertemporal self-other trade-offs.

Next, we turn to the vertical axes in Figure 1, i.e. the (forward) exchange rate F_τ , which describes the decision-maker's subjective conversion rate between contemporaneous self-Euro and charity-Euro in τ periods. It is defined as $F_\tau = g_{t+\tau}^*/x_{t+\tau}$ whenever the decision-maker is indifferent between $g_{t+\tau}^*$ and $x_{t+\tau}$.¹⁷ The corresponding indifference condition in consequence-dated models is

$$D(\tau)u(x_{t+\tau}, 0) = D(\tau)u(0, g_{t+\tau}^*). \quad (3)$$

As the discount factor $D(\tau)$ cancels from this expression, the exchange rate F_τ does not depend on τ . Note that this holds irrespective of the shape of the flow utility function, providing the distinctive prediction of a constant exchange rate for models of consequence-dated prosocial utility. By contrast, the defining equation of the exchange rate takes the following form for models of choice-dated prosocial utility, where we focus on the relevant trade-off and hence ignore other donations:

$$D(\tau)u(x_{t+\tau}) = \alpha(g_{t+\tau}^*) \quad (4)$$

As the delay τ of both payments increases, the decision-maker discounts the value of self-Euro on the left-hand side while the choice-dated prosocial utility remains unaffected by any delay. Thus, $g_{t+\tau}^*$ decreases, causing the exchange rate F_τ to decrease in τ .

¹⁷The exchange rate will depend on the level of payments unless it satisfies homogeneity, but we omit the dependence for ease of exposition.

Prediction 2. *Consequence-dated models predict a constant exchange rate, whereas choice-dated models of prosocial behavior predict a declining exchange rate.*

Finally, we turn to the diagonal axes in Figure 1, which capture *multivariate discounting* (MD). Similar to the exchange rate, this intertemporal trade-off only arises in the multi-attribute case. To fix ideas, suppose that the decision-maker will receive m_t self-Euro (charity-Euro) at time t and is asked to state the dated payment $m_{t+\tau}$ of charity-Euro (self-Euro) to be received at a later time $t + \tau$ that would make her indifferent. This involves a choice between payments to different recipients at different points in time, and provides an implicit multivariate discount factor of $m_t/m_{t+\tau}$. As in the case of univariate discounting, consequence-dated models will discount the value of the later payment, irrespective of whether it is denominated in self-Euro or charity-Euro. In both cases, we expect to see multivariate discounting.¹⁸ For models of choice-dated prosocial utility, we obtain the same prediction of multivariate discounting only when the early payment is denoted in charity-Euro, because then the value of delayed self-Euro is also discounted. However, we expect no multivariate discounting if the early payment involves self-Euro. The reason is again that the immediate, choice-dated prosocial utility is unaffected by the delay τ of charity-Euro.¹⁹

Prediction 3. *Consequence-dated models predict multivariate discounting, whereas choice-dated models of prosocial behavior predict multivariate discounting if the later payment involves self-Euro, and no multivariate discounting if the later payment involves charity-Euro.*

We conclude this conceptual discussion noting that it is straightforward to obtain qualitative predictions for the mixed case of both choice-dated and consequence-dated prosocial utility. With a mixture of both preferences, we expect to see (i) univariate discounting of self-Euro and charity-Euro, (ii) a declining exchange rate and (iii) multivariate discounting for both types of cross-attribute intertemporal conversions. This stands in contrast to pure consequence-dated prosocial utility, which predicts (i) and (iii), and choice-dated models, which only predict (ii). The qualitative predictions can be tested non-parametrically given suitable variation in choice data.

¹⁸This is evident from the indifference conditions. If the earlier payment involves self-Euro, it is $u(m_t, 0) = D(\tau)u(0, m_{t+\tau})$. The right-hand side decreases with τ , while the left-hand side is constant, causing multivariate discounting. In the other case, we have the symmetric condition $u(0, m_t) = D(\tau)u(m_{t+\tau}, 0)$.

¹⁹In this case, the indifference is characterized by $u(m_t, 0) = \alpha(m_{t+\tau})$.

3 Experimental design and procedures

Studying donation behavior from an intertemporal perspective requires a donation paradigm that creates variation in the possible size of donations that subjects consider meaningful even with a substantial delay and a tightly controlled experimental setup that allows a precise manipulation of payment dates, including a credible implementation of future payments and donations.

3.1 Saving a Life donation paradigm

To make delays in experimental outcomes meaningful to subjects, our design attempts to take prosocial decision-making in a controlled setting to the limits. We developed a high-stakes donation paradigm in cooperation with the Indian non-profit organization *Operation ASHA* (<http://www.opasha.org>), which specializes in the treatment of tuberculosis, an infectious disease caused by bacteria. Tuberculosis constituted the deadliest infectious disease in 2016, with an estimated global death toll of 1.7 million people.²⁰ Operation ASHA's model to treat tuberculosis has received extensive public acclaim and its work has been covered by the media worldwide.²¹ We estimated the all-inclusive cost of a life saved by Operation ASHA based on public information on the charity's operations in combination with estimates from peer-reviewed epidemiological studies on tuberculosis mortality (Straetemans et al., 2011; Tiemersma et al., 2011; Kollappan et al., 2008). Under conservative assumptions, a donation of 350 Euro – roughly 400 US Dollars at the time – covered all costs incurred by Operation ASHA to identify, treat and cure five more patients, which is equivalent to saving one *additional* human life in expectation. All donations were conferred as a restricted grant, ensuring that (i) no money could be used to cover overhead costs and (ii) the donations would flow immediately into scaling up the flexible field operations of Operation ASHA's treatment model. The disease tuberculosis, its causes, prevalence and implications, as well as the organization Operation ASHA were described in detail to subjects (see experimental instructions in the Appendix). All information on tuberculosis was verifiable and came from acknowledged sources, in particular the *World Health Organization*. If a subject's choices resulted in the donation of some amount to Operation ASHA, this amount was then transferred to the charity's bank account on the exact day specified in the experiment. Before making their first decision, we informed subjects that they could inspect a proof of the bank transfer of the donation as well as an official letter from Operation ASHA indicating the receipt of the donated amounts after the experiment. The experi-

²⁰World Health Organization. Tuberculosis fact sheet, <http://www.who.int/mediacentre/factsheets/fs104/en/> (2018).

²¹See <http://www.opasha.org/awards/>.

mental paradigm was approved by the Ethics Committee of the Economics Department at the University of Bonn (reference no. 2016-02).

3.2 Design

The experiment comprises two consecutive parts: intertemporal choices in Part A and atemporal choices under risk in Part B.

Three remarks about the experimental design are in order. First, we implement choices involving monetary payments to the subjects and the charity, rather than primary consumption such as effort or food. While most research on discounting behavior has relied on financial rewards, the recent experimental literature emphasizes that the discounted utility model posits discounting of *utility*, and that monetary payments only enter utility via primary consumption. Cohen et al. (2019) review this literature and conclude that studies using financial flows tend to find lower discount rates and a less hyperbolic discount function, implying smaller present bias. In the present study on self-other trade-offs in the context of donations, we use monetary payments because (i) most donations in practice are denominated in money, (ii) our interest lies in time horizons exceeding two months – which have not been studied using primary consumption due to the logistical complications – and (iii) because we aim to circumvent the issue of genuine present bias to identify choice-related utility flows. The differences between discounting of financial flows and primary consumption are most pronounced for very early rewards, and previous work has argued that monetary rewards that do not occur in the immediate future – i.e. which are delayed by at least three days – are treated as consumption (Augenblick, 2019; Halevy, 2015; Balakrishnan et al., 2020). Building on this debate, our deliberate design choice of avoiding utility consequences from consumption “in the present” allows for the simplifying assumption that delayed payments directly enter the utility function. Second, and complementing the preceding argument, even the earliest payment date in our experiment lies “in the future”. Specifically, we execute payments as bank transfers, with the earliest payment being available to subjects no earlier than three days following the day of the experiment. Third, we use the widely-established multiple price list method for all intertemporal and risky choice tasks (e.g. Attema et al., 2016; Holt and Laury, 2002; Schubert et al., 1999; Dohmen et al., 2017). On each decision screen, subjects faced a list of binary decisions between a fixed left-hand-side amount and a right-hand-side option with increasing amounts from the top to the bottom of the list. It is well established in the intertemporal choice literature that estimates of discount rates from simple “money earlier versus later” choices alone are confounded given pervasive evidence against linear utility even for small amounts. Several approaches address this issue (Montiel Olea and Strzalecki, 2014; Ericson and

Noor, 2015), including the recently popular paradigm of convex time budgets, which does not require a separate elicitation of the utility curvature (Andreoni and Sprenger, 2012). We instead rely on the “double price list method”, which estimates the shape of the atemporal utility function from separate risky choices, extending the approach of Andersen et al. (2008) to the multi-attribute case. While both methods have been shown to perform well in practice (Andreoni et al., 2015), we primarily resort to using separate risky choices due to our objective of precisely characterizing the multi-attribute atemporal utility function.²²

Across both parts of the experiment, each subject completed a total of 36 decision screens, 21 involving intertemporal choices and 15 involving choices under risk. In each part, one randomly-chosen row of the price list on a randomly-chosen decision screen was selected by the computer and added to the subject’s earnings.

3.2.1 Part A – Intertemporal choices

To study intertemporal choices involving payments of self-Euro and charity-Euro in a comprehensive way, we implement a fully-crossed design with decisions involving cross-attribute vs. no cross-attribute trade-offs, and differential delays vs. no differential delays. Using multiple price lists as shown in Appendix Figure A.1, we elicit indifference points between certain self-Euro or charity-Euro payments at different, exactly-specified delays. Part A comprises five stages presented in randomized order.

Univariate discounting. Univariate discounting includes two stages, *UD – SELF* and *UD – CHARITY*, in which we separately elicit net present values of delayed payments of self-Euro or charity-Euro, respectively. On each decision screen of stage *UD – SELF*, subjects face a list of binary choices between a fixed payment of 50 self-Euro to be received by bank transfer at the earliest possible payment date after three days, and increasing amounts of self-Euro at a fixed later point in time. The delay of the later payment varies across decision screens and included 1, 3, 6 and 12 months, in randomized order. Subjects complete four decision screens in stage *UD – SELF*. Stage *UD – CHARITY* is identical to *UD – SELF* except that both the earlier and later payments involve donations to charity, which would be made by bank transfer on the specified dates in a way that could be verified by subjects later on.

Note that these choices create trade-offs between two payments for the *same* recipi-

²²Note that both methods have practical disadvantages. While choices from convex time budgets produce substantial bunching at the boundaries and choice inconsistencies (Chakraborty et al., 2017), the price list methodology creates a substantial minority of subjects who switch multiple times in a single list, at odds with monotonic preferences (e.g. Bruner, 2011). Here we circumvent the complications associated with multiple switching points in the data by enforcing a unique switching point. This was implemented using an auto-completion function that filled in remaining choices as soon as a subject switched from the fixed left-hand-side option to the increasing right-hand-side option.

ent (either self-Euro or charity-Euro), but occurring at *different* points in time.

Subjective cross-domain exchange rates. We measure subjective exchange rates between self-Euro and charity-Euro payments at different points in times in stage *ER*. On each decision screen, subjects face a list of binary choices between a payment of 50 self-Euro at a specified point in time and increasing amounts of charity-Euro at the *same* point in time. Time points include bank transfers to be expected with the shortest delay of three days (the *spot exchange rate*), as well as in 1, 3, 6 and 12 months (*forward exchange rates*). These five decision screens provide measures of how many charity-Euro subjects demand per contemporaneous – i.e. identically-dated – self-Euro for different delays, from today’s perspective.

Note that these choices create trade-offs between two payments for *different* recipients, but occurring at the *same* points in time.

Multivariate discounting. We measure trade-offs between two payments – one denominated in self-Euro and one in charity-Euro – with different delays. Stages *MD – SELF* and *MD – CHARITY* thus capture the common situation where individuals face trade-offs between giving and taking, but the corresponding payment flows occur at different times. On each decision screen in stage *MD – SELF*, subjects face a list of binary choices between a fixed payment of 50 self-Euro at the earliest delay and increasing amounts of charity-Euro at a fixed later point in time. Conversely, in stage *MD – CHARITY*, subjects face a list of binary choices between a fixed payment of 50 charity-Euro at the earliest delay and increasing amounts of self-Euro at a fixed later point in time. As before, the later time points include 1, 3, 6 and 12 months.

Note that these choices create trade-offs between two payments for *different* recipients, occurring at *different* points in time.

Within Part A, both the order in which stages occurred and the order of decisions within each stage were randomized at the individual level.²³ Right-hand-side options in the price lists ranged from a simple annualized discount rate of 0% to 150% in steps of 5 percentage points for univariate discounting, from 0 Euro to 200 Euro in steps of 10 Euro for the exchange rates, and from 0 Euro to an annualized discount rate of 150% (relative to the 50 Euro left-hand-side option) in 25 steps in stages *MD – CHARITY* and *MD – SELF*.

3.2.2 Part B – Risk apportionment

The objective of Part B of the experiment is to characterize individuals’ multi-attribute utility functions using atemporal decisions, i.e. choices that do not involve differently-

²³To avoid confusion, all decision screens belonging to the same stage appeared consecutively (in randomized order).

dated payments. Note that the intertemporal choices in Part A only identify discounting behavior under the assumptions that flow utility is linear and additively separable in its attributes.

We adopt the recently-popularized experimental paradigm of risk apportionment, which allows testing conditions on the nature of the utility function non-parametrically. Second-order risk aversion and third-order risk aversion (i.e. prudence) are typically defined in terms of specific conditions on the (second and third) derivatives of the utility function under expected utility maximization. Eeckhoudt and Schlesinger (2006) provide an alternative definition based on observable choices in risk apportionment tasks. Risk apportioning has the desirable feature that the measurement remains valid even if expected utility theory fails (Ebert and van de Kuilen, 2015; Starmer, 2000). At the same time, data from risk apportionment choices allow calibrating specific utility specifications under additional parametric assumptions.

We measured univariate risk version individually for self-Euro and for charity-Euro (stages $RA - SELF$ and $RA - CHARITY$, respectively), univariate prudence (stages $PR - SELF$ and $PR - CHARITY$), and multivariate risk aversion (stage $X - RA$). The latter stage is crucial as it delivers a non-parametric estimate of *correlation aversion* (Richard, 1975; Epstein and Tanny, 1980), which is a sufficient condition for assuming additive non-separability of the utility function.

In every risk apportionment task, subjects receive some endowment $\mathbf{e} = (x, y)$ of attributes X and Y and then make a decision between two lotteries. Each of these lotteries has two equally likely outcomes, e.g. it is based on a simulated flip of a fair coin by the computer. Assume further that there are two undesirable fixed amounts R_1 and R_2 with $R_i \preceq (0, 0)$. Accordingly, R_1 is a fixed univariate “reduction” in either X or Y , but not in both dimensions at the same time.²⁴ A preference for risk apportionment is the desire to disaggregate these unavoidable fixed reductions in wealth, R_1 and R_2 , across two equiprobable states of the world, as depicted in Figure 2.

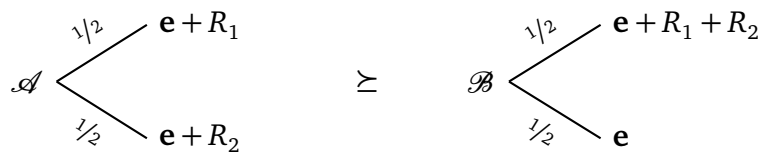

Figure 2: Preference for risk apportionment (cf. Ebert and van de Kuilen (2015))

The different stages in Part B vary depending on whether each attribute (X and Y) corresponds to self-Euro or charity-Euro. Concretely, we present subjects with choices between two lotteries as summarized in Figure 2. For conceptual consistency and to

²⁴The same holds for R_2 , but R_1 and R_2 do not necessarily affect the same attribute.

avoid confusing subjects, we employ the same price list methodology as for intertemporal choices in Part A.²⁵ On each decision screen, subjects make binary choices between a fixed lottery \mathcal{A} and a fixed lottery \mathcal{B} , where an additional, state-independent compensation payment m is added to lottery \mathcal{B} . This compensation payment m gradually increases across the rows of the choice list. The smallest amount for which the individual prefers lottery \mathcal{B} indicates the minimal compensation demanded for heaving both undesirable reductions in wealth clustered in a single state. An example choice screen is depicted in Appendix Figure A.2.

Table 1: Overview of risk apportionment choices

Task	Endowment		R_1		R_2		Expected value	
	Self (2)	Charity (3)	Self (4)	Charity (5)	Self (6)	Charity (7)	Self (8)	Charity (9)
RA – SELF	25		-10		-5		17.5	
	50		-20		-10		35	
	100		-40		-20		70	
PR – SELF	40		-10		(14, 0.5; -14, 0.5)		35	
	40		-10		(7, 0.8; -28, 0.2)		35	
	40		-10		(-7, 0.8; 28, 0.2)		35	
RA – CHARITY		25		-10		-5		17.5
		50		-20		-10		35
		100		-40		-20		70
PR – CHARITY		40		-10		(14, 0.5; -14, 0.5)		35
		40		-10		(7, 0.8; -28, 0.2)		35
		40		-10		(-7, 0.8; 28, 0.2)		35
X – RA	25	25	-10			-10	20	20
	50	50	-20			-20	40	40
	100	100	-40			-40	80	80

Note: All values are displayed in Euro. Columns labeled with “Self” indicate payments to the subject and columns labeled with “Charity” indicate payments to the charity. If R_1 or R_2 is a non-degenerate lottery, it is given as $(x_1, p_1; x_2, p_2)$ where x_i indicates the amount and p_i the probability of receiving it. Columns 8 and 9 show the expected payment to the subject and the expected payment to the charity, respectively.

Table 1 shows all fifteen choice situations presented to subjects. Note that for our measure of prudence, R_2 is a zero-mean lottery instead of a fixed reduction in wealth, i.e. R_2 only adds variance in this case. The grid of compensations offered in the choice lists varied with the endowments. Each choice list contained 21 rows, across which the compensation increased in constant step size. All grids were centered at zero.

²⁵Concretely, our design extends the procedure suggested in Ebert and Wiesen (2014) to a multi-attribute setting.

3.2.3 Procedures

We recruited 244 subjects from the student subject pool of the *BonnEconLab* at University of Bonn. Table A.1 provides summary statistics for the full sample. The experiment was conducted in the main auditorium at University of Bonn. We collected data in nine sessions from September 19 to September 22, 2016. The experiment was fully computerized and conducted using the software oTree (Chen et al., 2016). Subjects were seated in separate cubicles to create full privacy in a way that no other person could see their screen during the experiment. They could ask questions to an experimenter at all times. The average completion time was 65 minutes. Subjects received a fixed amount of 5 Euro for their participation in the experiment. All payments were made as bank transfers initiated on the precise day indicated for the payment. On average, each participant earned 59 Euro (39 Euro at the earliest delay and 20 Euro at later time points) and caused donations of 70 Euro (40 Euro at the earliest delay and 30 Euro at later time points). Average earnings and average donations together correspond to fifteen times the federal hourly minimum wage at the time, or more than 10% of the median monthly household income in our sample.

3.3 Econometric analysis

To make intertemporal choices comparable across tasks, we proceed as follows. For choices from the stages UD and MD, we calculate the net present value (expressed in today's numeraire) of a dated future payment of 1 Euro from subjects' smaller-sooner-larger-later choices. Specifically, the net present value is $50/m^*$, where m^* is the subject's switching point.²⁶ For choices from stage ER, we calculate the (forward) exchange rate $m^*/50$, i.e. the rate of charity-Euro per contemporaneous self-Euro.

In Section 4, we present the average net present values and exchange rates by task. We use non-parametric hypothesis tests (Wilcoxon signed-rank test, paired t test) for inference about differences in means. These tests exploit the within nature of our design and ignore the between-subject variation in choices. We apply the procedure developed by Morey (2008); Cousineau (2005) to construct the 95% confidence intervals in our figures. This procedure is best understood by considering the following auxiliary regression analysis of our results. Let $y_{i,j}$ denote an outcome of interest derived from subject i 's choice in task j . We then estimate the saturated regression model

$$y_{i,j} = \alpha_i + \beta \text{Domain}_j + \sum_{\tau} \gamma_{\tau} \text{Delay}_{\tau(j)} + \sum_{\tau} \delta_{\tau} \text{Domain}_j \times \text{Delay}_{\tau(j)} + \varepsilon_{i,j} \quad (5)$$

²⁶The value of the earlier payment (option A) in the multiple price list is always 50 Euro. We use the midpoint of the interval where the subjects switched from option A to option B.

separately for the stages UD, MD and ER. Here, α_i is a subject fixed effect, Domain_j is a binary variable taking the value of 1 if the earlier dated payment in task j is denoted in charity-Euro, $\text{Delay}_{\tau(j)}$ is a binary variable taking the value of 1 if the later dated payment in task j has a delay of τ months, and $\varepsilon_{i,j}$ denotes the individual error term. To account for the nature of the within design, we cluster standard errors at the subject level.

Morey (2008); Cousineau (2005) confidence intervals for differences in means across tasks will be similar to the confidence intervals obtained for the corresponding linear combination of regression parameters. For completeness, we report the estimates of Equation (5) in Table A.2 of the Appendix.

4 Reduced-form results

We present our findings in two sections. In this section, we document the main qualitative patterns in the data using non-parametric tests that allow us to disentangle between consequence-dated and choice-dated models of prosocial utility following the conceptual discussion in Section 2. Specifically, we analyze the comparative static predictions of these models in our data. In Section 5, we then use structural calibrations to assess relative effect magnitudes and their implications for different underlying prosocial motivations.

The reduced-form findings are split into two subsections, which correspond to the two parts of the experiment. We begin with our analysis of choices under risk as the results on atemporal multi-attribute trade-offs inform the interpretation of intertemporal choices.

4.1 Choice under risk

We characterize the shape of the flow utility function up to the third derivative from subjects' choices under risk. The cumulative distribution of the required compensation payments in the risk apportionment tasks is displayed in Figure 3. To render choices comparable across lotteries, we first normalize the required compensation payments in each lottery by their expected value. We then plot the cumulative distribution of the average normalized, required payment separately for each stage of the risk apportionment tasks. We document two main findings from this non-parametric analyses.

Result 1. *Subjects exhibit highly similar attitudes towards risk in payments of self-Euro and charity-Euro. This implies that the corresponding marginal (i.e. single-attribute) utility functions have equal curvature.*

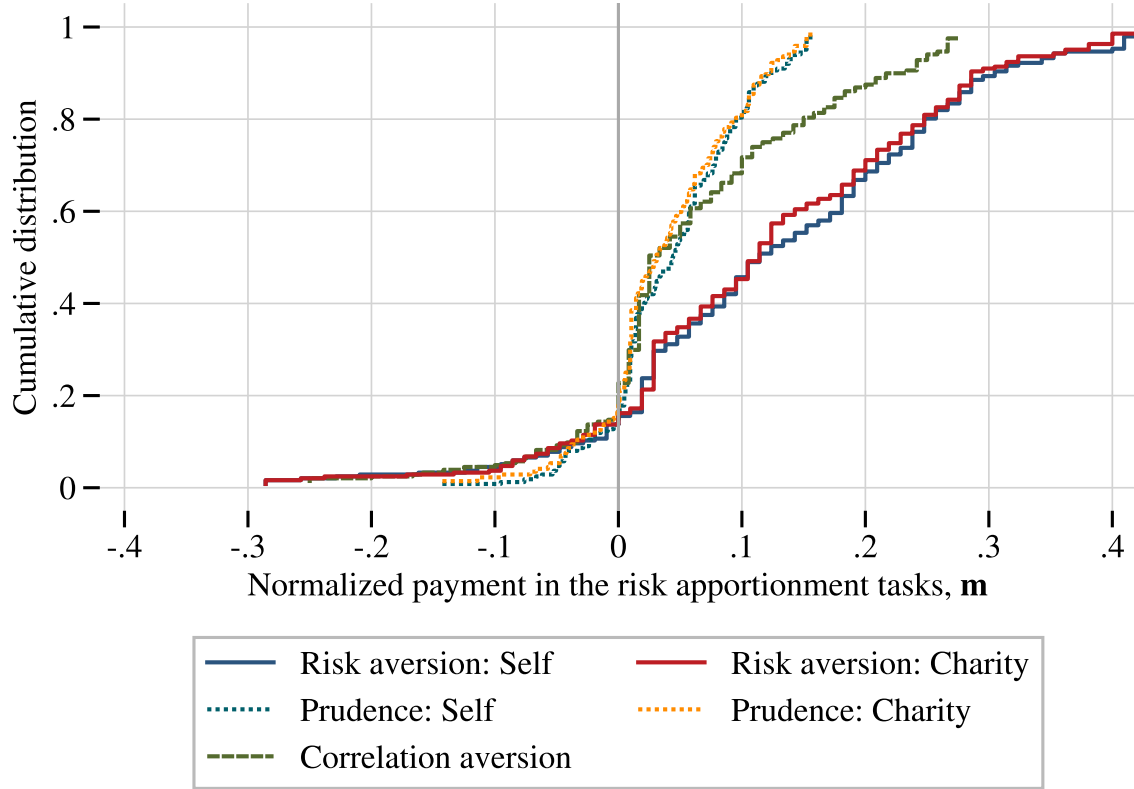

Figure 3: This figure plots the cumulative distribution function of normalized compensation payments in the five stages of the risk apportionment tasks. To obtain normalized payments, we divide the compensation payments by the expected value of the corresponding base lottery without compensation (see Table 1 for an overview of each stage). We then take the average of the three lottery choices within a stage and plot its cumulative distribution function ($N = 244$). “Risk aversion: Self” and “Risk aversion: Charity” show the distribution second-order risk attitudes over self-Euro and charity-Euro. “Prudence: Self” and “Prudence: Charity” show the distribution of third-order risk attributes over self-Euro and charity-Euro. “Correlation aversion” is a measure of multivariate risk aversion over self-Euro and charity-Euro that characterizes the sign of the cross-derivative of the atemporal part of the utility function.

More than 80% of subjects display second- and third-order risk aversion for self-Euro and charity-Euro (Figure 3). Crucially, we can neither reject the null hypothesis that people are on average *equally* risk averse in both domains (paired Wilcoxon signed-rank test, $p = 0.251$) nor that risk preferences in both domains are equally distributed (Kolmogorov–Smirnov test, $p = 0.786$). We further estimate a very strong Spearman correlation between subjects’ third-order risk aversion (prudence) in both domains ($\rho = 0.671$). The cross-attribute correlation of risk attitudes is illustrated in Figure 4. In the following, we will thus assume that the marginal utility functions representing utility from self-Euro and charity-Euro only differ by a multiplicative constant.²⁷

Result 2. *Subjects overwhelmingly display correlation aversion. This implies that the multi-attribute flow utility function is not additively separable, $u(w, g) \neq u'(w) + u''(g)$.*

²⁷The most commonly-used one- and two-parameter families of utility functions are pinned down (up to a linear transformation) by their second- and third-order risk aversion.

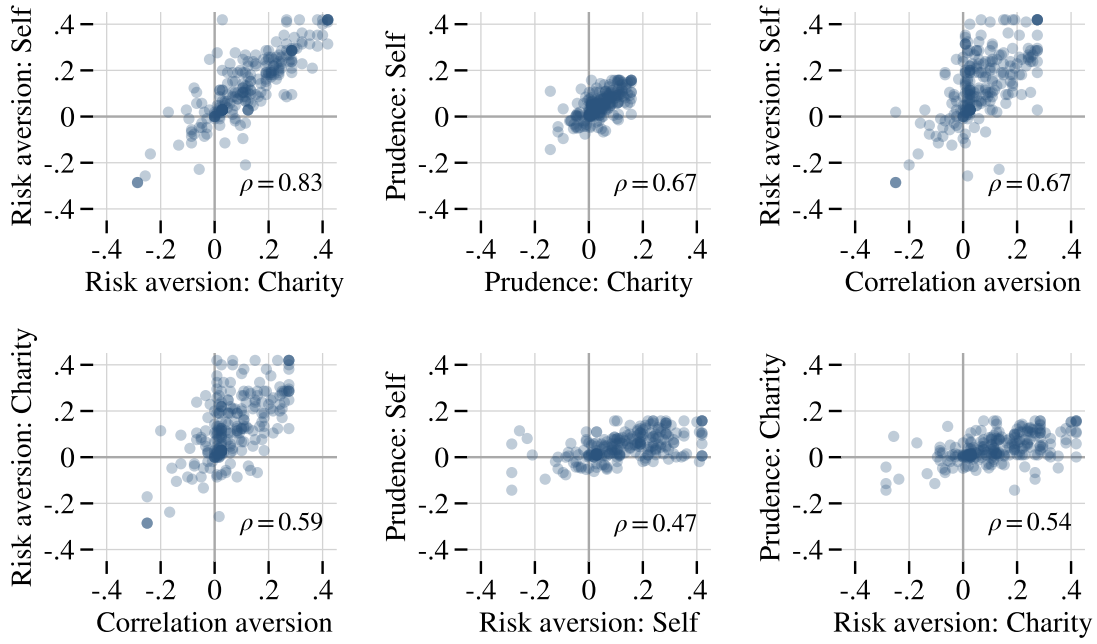

Figure 4: This figure plots measures of risk aversion, prudence and correlation aversion over self-Euro and charity-Euro ($N = 244$). The Spearman correlation, ρ , is shown in the lower right corner of each plot. Each measure is the average normalized compensation payment in the respective stage of the risk apportionment tasks. To obtain average normalized payments, we divide the compensation payments by the expected value of the corresponding base lottery without compensations (see Table 1 for an overview of each stage). We then take the average of the three lottery choices within a stage.

We classify more than 80% of subjects as correlation averse (Figure 3). The risk apportionment tasks deliver a non-parametric measure of the condition for correlation aversion, namely that the cross-derivative with respect to payments in self-Euro and charity-Euro is negative, $\partial^2 u / \partial x_t \partial g_t < 0$.

The findings of the non-separability of multi-attribute utility and identical curvatures of the marginal utility functions directly inform the following analyses of intertemporal choice patterns.

4.2 Intertemporal choice

We test predictions 1 to 3 on the differences between consequence-dated and choice-dated prosocial utility. Harnessing our non-parametric finding that the univariate utility functions only differ by a multiplicative constant allows us to derive slightly more general conclusions than under the assumption of linear utility. The results naturally hold for the nested case of linear utility.

To foreshadow our key results and simplify the following model-oriented discussion, our main reduced-form findings can be summarized as follows: while declining net present values of delayed charity-Euro in univariate and multivariate discounting

tasks are compatible with consequence-dated but not choice-dated prosocial utility, a decreasing subjective forward exchange rate between self-Euro and charity-Euro is explicitly incompatible with consequence-dated but compatible with choice-dated utility. Put simply, we find evidence that is distinctively in line with consequence-dated utility and evidence that is only in line with choice-dated utility.

Recall that in the univariate discounting tasks (stages *UD-CHARITY* and *UD-SELF*), subjects only face a time trade-off, but no cross-domain trade-off. We document decreasing and identical net present values of delayed payments of self-Euro and charity-Euro. Accordingly, when we elicit the subjective valuation m^S in self-Euro for a payment of one self-Euro that is delayed by an amount of time τ , and separately measure the subjective valuation m^C in charity-Euro for a donation of one Euro that is also delayed by τ , the average stated amounts for m^S and m^C are statistically indistinguishable for all delays τ (paired Wilcoxon signed-rank test, $p > 0.58$ for any τ). This result is illustrated in Figure 5.

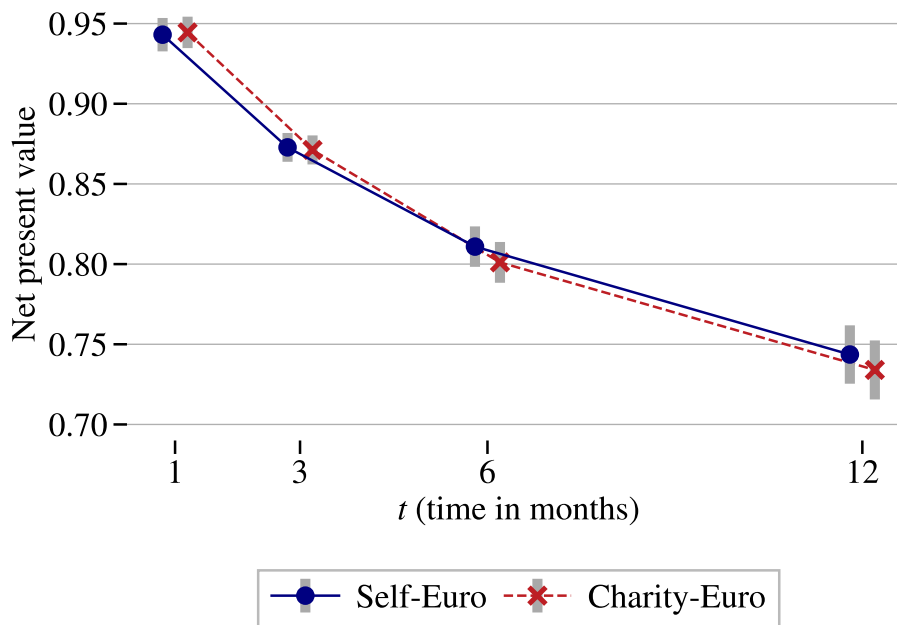

Figure 5: This figure displays the net present value of a dated payment of 1 self-Euro (blue markers) and the net present value of 1 charity-Euro (red markers) with different delays ($N = 244$). The net present values are calculated from choices between smaller-sooner and larger-later payments to the subjects or donations. 95% confidence intervals of the mean calculated according to Morey (2008); Cousineau (2005).

These choice pattern in univariate discounting tasks have three implications relating to prediction 1. First, a decreasing net present value for delayed charity-Euro payments is incompatible with the pure choice-dated model from Equation (2). Intuitively, if prosocial utility flows were entirely choice-dated – e.g. the only motivation for donating is warm glow – it would not matter whether the corresponding donation payment is actually implemented at the earlier or later future. Second, this same finding is directly

compatible with a consequence-dated structure of prosocial utility flows, e.g. pure altruism. Third, and more compellingly, the discounted utility version of consequence-dated utility can accommodate both (i) identical net present values for delayed self-Euro and charity-Euro and (ii) identical curvatures of the marginal utility functions (Result 1). These non-parametric findings imply that the same discount factors, $D(\tau)$, are applied to future utility from self-Euro and charity-Euro.²⁸

Result 3. *In univariate discounting tasks, net present values for delayed self-Euro and charity-Euro payments are identical and decreasing in the delay. These patterns are consistent with consequence-dated but not with choice-dated prosocial utility.*

Next, recall that in the choice tasks designed to determine subjective exchange rates between self-Euro and charity-Euro for different delays (stage *ER*), subjects face a cross-attribute trade-off but no time trade-off, since the two payments occur simultaneously. Figure 6 displays how subjects resolved this trade-off.

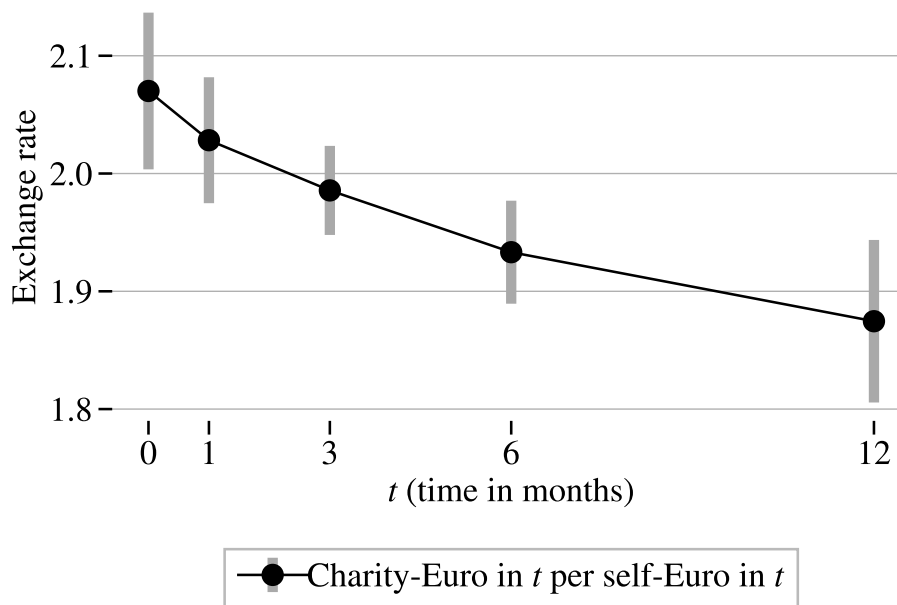

Figure 6: This figure displays the estimated subjective exchange rates between contemporaneous payments to the subjects and donations, i.e. the number of charity-Euro per contemporaneous self-Euro. Note that “0 months” indicates payments initiated after 3 days. 95% confidence intervals of the mean are calculated according to Morey (2008); Cousineau (2005).

The level of the subjective exchange rate is above one throughout, indicating – unsurprisingly – that subjects on average prefer payments to themselves over equally sized donations (paired *t* tests at each delay, $p < 0.001$). For the earliest payment date of only

²⁸An alternative explanation for identical required rate of returns in both domains would require that there are separate discount factors $D(\tau)^c$ and $D(\tau)^s$ for each domain and the univariate utility functions for self-Euro and charity-Euro have different curvatures, which contradicts the non-parametric result 1 from risky lottery choices.

three days, subjects exhibit an exchange rate of approximately 2.07, indicating that they value one self-Euro slightly more than twice as much as one charity-Euro.

More strikingly, we find that the valuation of a self-Euro per contemporaneous charity-Euro decreases in the delay τ (paired t tests for the change in delay τ relative to base period, $p_1 = 0.245$, $p_3 = 0.031$, $p_6 = 0.003$, $p_{12} < 0.001$). This means that when the common delay of two payments – one denominated in self-Euro and one in charity-Euro – increases, our subjects develop a relative preference for charity-Euro. Put differently, in these types of choices that only involve a single delay τ that applies to both domains, self-Euro are discounted more strongly than charity-Euro.

A declining forward exchange rate has two implications regarding prediction 2. First, this pattern cannot be rationalized by the discounted utility version of consequence-dated prosocial utility. If a common discount function is applied to discount utility from self-Euro and charity-Euro, the discount factors cancel out in this situation with identical delays.²⁹ Second, this finding is compatible with choice-dated prosocial utility. Intuitively, if delayed self-Euro payments generate delayed utility flows that are discounted, but delayed donations are only associated with choice-dated utility flows, an increase in the common delay affects the discounted utility from self-Euro while leaving the utility derived from donations unaffected.

Note that we do not have to invoke the shape of the utility function for this argument: the exchange rate finding is incompatible with discounted utility irrespective of utility curvatures.

Result 4. *Subjective exchange rates between self-Euro and charity-Euro are declining over time, i.e. a common delay makes self-Euro relatively less valuable than charity-Euro. This pattern is explained by choice-dated but not consequence-dated prosocial utility.*

Finally, recall that choice tasks on multi-attribute discounting (stages *MD – CHARITY* and *MD – SELF*) combine a cross-attribute trade-off with a time trade-off within a single decision. Our participants had to decide what amount in one domain payable at a later date would make them indifferent to a given amount in the other domain payable at an earlier date. We document three qualitative patterns in the data, as show in Figure 7.

First, subjects on average demand a lower compensation in self-Euro at the earlier date for giving up a donation at a later date than vice versa (paired t test for each delay,

²⁹Abandoning the defining assumption of the discounted utility model that the flow utility function is stationary could also explain this finding, although it raises a question about the origin of the non-stationarity, something that is outside the theory of intertemporal choice. By contrast, choice-dated prosocial utility rationalizes this finding *and* leads to a failure of the assumption of a stationarity flow utility function.

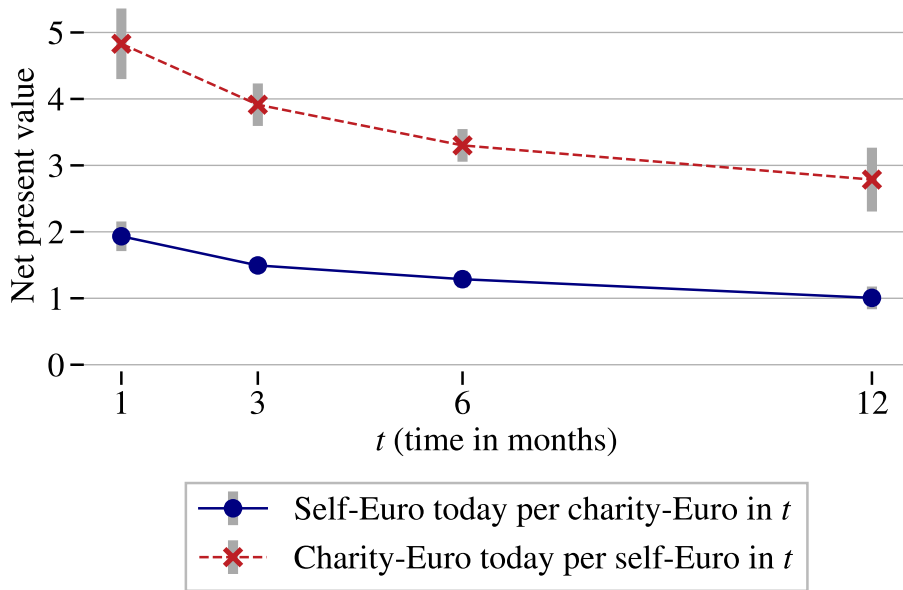

Figure 7: This figure displays estimated net present values of delayed payments ($N = 244$). Red markers indicate the net present value of 1 delayed self-Euro when expressed in charity-Euro today. Blue markers indicate the net present value of 1 delayed charity-Euro when expressed in self-Euro today. 95% confidence intervals of the mean calculated according to Morey (2008); Cousineau (2005).

$p < 0.01$).³⁰ Intuitively, given that subjects value one self-Euro roughly twice as much as a contemporaneous charity-Euro, they will require a lower compensation in their preferred category (self-Euro) than in the inferior category (charity-Euro).

Second, the net present values decrease in the delay of the later payment, implying that payments of both self-Euro and charity-Euro are valued less as their delay increases (paired t-tests between adjacent delays, $p < 0.01$).

Third, we find that the net present value of delayed charity-Euro decreases less quickly in the delay τ than the net present value of delayed self-Euro (paired t-tests for the difference in rates of changes for compensations in self-Euro and charity-Euro, for each time difference, $p < 0.01$).

These non-parametric results relate to prediction 3 as follows: a decreasing net present value of delayed charity-Euro is at odds with pure choice-dated prosocial utility, as the payment date of charity-Euro should be inconsequential in that case. However, all three patterns are compatible with consequence-dated prosocial utility. A decreasing net present value of more delayed donations naturally follows from stronger discounting. The level differences as well as the difference in slopes are predicted by a lower marginal utility from charity-Euro.

Result 5. *In cross-attribute intertemporal decisions, net present values of delayed charity-*

³⁰Specifically, the average WTA for giving up self-Euro today for charity-Euro tomorrow (WTA_{τ}^{sc}) is higher than the average WTA for giving up charity-Euro today for self-Euro tomorrow (WTA_{τ}^{cs}). In particular, we have $\min_{\tau} WTA_{\tau}^{sc} > \max_{\tau} WTA_{\tau}^{cs}$.

Euro payments are decreasing in their delay, and they are lower and decrease less quickly than required rates of return on delayed self-Euro. These patterns are explained by consequence-dated but not choice-dated prosocial utility.

In summary, the non-parametric analyses provide strong evidence for the existence of *both* choice-dated and consequence-dated components of prosocial utility.

This raises the question of internal consistency: can the results 3, 4 and 5 jointly be rationalized by utility maximization? For example, are both the implied conversion factor between self-Euro today and self-Euro in τ months *and* the forward exchange rate between self-Euro and charity-Euro in τ consistent with the implied multivariate conversion factor from stage MD-S? The naive approach of comparing the product of the former two with the multivariate conversion factor would implicitly assume that utility from money is linear, which conflicts with result 1. Instead, our structural approach in the next section shows that these reduced-form findings can be internally consistent with utility maximization given a single set of preferences.

5 Structural estimation

The structural analysis of our experimental data has three objectives (DellaVigna, 2018). First, while the reduced-form results of Section 4 provide distinctive *qualitative* evidence for models of consequence-dated and choice-dated prosocial utility, they do not allow making inferences about whether these models make *quantitatively* plausible predictions. We aim to take the implications of models of intertemporal prosocial utility seriously by testing whether the calibration of magnitudes under parametric assumptions delivers reasonable values. Is our model a likely explanation of the data, or does it merely produce the right comparative statics? Second, structural estimation can deliver insights into the underlying behavioral motivations. Specifically, it suggests a way to assess (i) whether the evidence for choice-dated utility is quantitatively meaningful or so small that it can be safely ignored, and (ii) how choice-dated and consequence-dated utility compare magnitude-wise. For example, how important is warm glow relative to pure altruism? Third, we view the present example as a prime application of the approach proposed by DellaVigna (2018), who suggests that the goal of conducting structural analyses can inform the experimental design in the first place. As detailed in Section 3, we deliberately set up the design such that it allows for structural estimations next to non-parametric reduced-form analyses.

5.1 Setup

We build on the conceptual considerations in Section 2 and the findings presented in Section 4. We proceed with the following parametric form of the intertemporal utility function,

$$U_t = \alpha \mathbb{1} \left(\sum_{t=0}^{\infty} g_{t+\tau} > 0 \right) + \sum_{t=0}^{\infty} \delta^\tau (w x_{t+\tau}^\beta + (1-w) g_{t+\tau}^\beta) \quad (6)$$

in which the first part represents choice-dated prosocial utility from the act of giving itself and the second part captures payment-dated utility.

In this formulation, α is the choice-dated prosocial utility from giving; δ is the one-month utility discount factor, $1 - w$ is the pure altruism parameter as it captures the relative value of 1 charity-Euro to a contemporaneous self-Euro, and $1 - \beta$ is the coefficient of *univariate* relative risk aversion.

We motivate this functional form as follows.³¹ First, result 4 provides non-parametric evidence of choice-dated utility, which we model following Equation (2). Second, results 3 and 5 imply consequence-dated utility, which we capture as suggested in Equation (1) and discussed in detail in Section 2. Third, with respect to the flow utility function, we document strong evidence that the curvature of the univariate utility from self-Euro and the univariate utility from charity-Euro differ only in scale, i.e. they have the same curvature (result 1). We therefore assume a common parameter, β , to capture the curvature of the utility function when choices involve only one recipient. Fourth, we assume standard exponential discounting as (i) our data only includes payment dates in the future, allowing us to abstract from present bias, (ii) our main interest is not the specific shape of the discount function, and (iii) to economize on parameters in our baseline specification. However, note that our data allow flexibly estimating alternative, multi-parameter specifications of the discount function. Fifth, we find strong evidence of multivariate risk aversion (result 2), implying a non-additively separable flow utility function in the second part of Equation (6). While it is possible to explicitly incorporate a parameter of correlation aversion in the functional form, our primary focus is on intertemporal prosocial utility. Indeed, correlation aversion should only affect 3 out of 36 choices. As such, we abstain from modeling correlation aversion and exclude all choices from stage *X - RA* in our estimation. A non-negligible share of subjects display a very high degree of risk aversion in the stages *RA - SELF* and *RA - CHARITY*. The CRRA functional form has difficulties matching this behavior, as highlighted by Wakker (2008). As constant relative risk aversion greater than 1 is outside the theoretical range of our structural model, we exclude 44 subjects with an average normalized switching point greater than 0.9 in

³¹Similar functional forms have been used in previous work (Andreoni and Miller, 2002; Andersen et al., 2018; Fisman et al., 2007).

the stages *RA – SELF* and *RA – CHARITY* to avoid corner solutions.³²

5.2 Estimation

We estimate the structural parameters of our model using a minimum-distance estimator (Newey and McFadden, 1994). Let $m(\theta)$ denote the moments predicted by our structural model, and \hat{m} the vector of observed moments. The minimum-distance estimator selects the parameters $\hat{\theta}$ that minimize the distance

$$(m(\theta) - \hat{m})'W(m(\theta) - \hat{m}) \quad (7)$$

where W is a positive definite weighting matrix. We chose a minimum-distance estimator over a maximum likelihood estimator because it is more robust to outliers that are unlikely according to the model, as a concern that is particularly relevant in the context of charitable giving (see the discussion in DellaVigna, 2018). Moreover, it is more transparent in the sense that it only fits the specified set of empirical moments.

As a vector of moments \hat{m} , we use the average normalized switching point in each of our 33 price lists (excluding stage *X – RA*). We normalize individual switching points by applying a linear transformation that maps each price list onto the unit interval, so that $\hat{m} \in [0, 1]$ ³³. For the choice of the weighting matrix, we follow common practice in using the diagonal of the inverse of the variance-covariance matrix of our empirical moments.³³

To calculate the minimum-distance estimator $\hat{\theta}$, we employ the L-BFGS-B algorithm, which is appropriate for constrained optimization (Byrd et al., 1995).³⁴ We impose the following box constraints: $\delta \in (0, 1]$ (positive discounting), $\beta \in [0, 5]$, $\alpha \in [0, 5]$ (non-negative choice-dated utility) and $w \in [0, 1]$ (altruism weight between 0 and 1). As local minima are a natural concern in any structural estimation, we repeatedly estimate our model using ten randomly-chosen initial values from a uniform distribution over the parameter space. Moreover, we always include as initial values at least one parameter draw where $\alpha = 1 - w = 0$ to ensure that purely selfish preferences were in the consideration set of the estimator. As our final parameter estimate, $\hat{\theta}$, we choose the estimate with the minimum weighted distance among all ten estimates. We also conducted Monte

³²An alternative approach is to include these subjects in the structural estimation and set the curvature parameter β close to 0. While this would not affect our structural results qualitatively, the overall model fit would decrease as the calibrated value of $\beta \approx 0$ is unable to capture the empirically observed risk aversion of these subjects. See Wakker (2008) for a more comprehensive discussion.

³³While the efficient weighting matrix is the full inverse of the variance-covariance matrix, it has the drawback that it can lead to numerical instability of the estimator (Altonji and Segal, 1996).

³⁴We use a Python implementation of this estimation routine (Gabler, 2020).

Carlo experiments to increase our confidence in the estimation procedure.³⁵ We obtain standard errors from an estimator of the asymptotic variance-covariance matrix of the estimator:

$$(\hat{G}'W\hat{G})^{-1}(\hat{G}'W\hat{\Lambda}W\hat{G})(\hat{G}'W\hat{G})^{-1} \quad (8)$$

where $\hat{G} = N^{-1} \sum_{i=1}^N \nabla_{\theta} m_i(\hat{\theta})$ and $\hat{\Lambda} = \text{Var}[m(\hat{\theta})]$. In our baseline specification, we estimate a *representative agent* model and assume no heterogeneity in parameters. In a second step, we leverage the rich within-subject variation and explore idiosyncratic variation in preferences by estimating the intertemporal multi-attribute utility function *at the subject level*. That is, we separately estimate preferences θ_i for each subject i .³⁶ The estimation strategy is identical for the two cases.

5.3 Identification

The experiment is purposefully designed in such a way that our data from atemporal risky choices and intertemporal choices jointly identify the four parameters $\theta = (\alpha, \beta, \delta, w)$ in Equation (6). Univariate risk aversion, $1 - \beta$ is identified from the risky choices in Part B. Conditional on $1 - \beta$, the discount factor δ is separately identified from the univariate discounting stage in Part A of the experiment. The subjective exchange rate from stage ER provides identifying variation for the choice-dated prosocial utility parameter, α . The pure altruism parameter, $1 - w$, is identified from choices involving trade-offs between self-Euro and charity-Euro, such as stage *MD - SELF*, *MD - CHARITY* and *ER*.

5.4 Results

First, we consider the representative agent model, which abstracts from between-subject heterogeneity in preferences. Figure 8 displays the point estimates and the corresponding 95% confidence intervals for the model parameters of Equation (6).

We make three observations. First, the estimated levels of the two parameters characterizing the atemporal utility function are quantitatively in line with previous findings. We estimate a one-month discount factor of 0.991, corresponding to a one-year discount factor of 0.906,³⁷ and a univariate relative risk aversion parameter of 0.808.

³⁵We simulate the choices of $N = 200$ agents with preferences θ_0 for randomly-chosen values of θ_0 . For each θ_0 , we start our estimation procedure at a perturbed initial value of $\theta_0 + \xi$. The minimum-distance estimator is able to back out θ_0 in our simulation experiments.

³⁶Structural estimations in behavioral economics are most frequently conducted at the population level, as subject-level estimations are much more demanding to the data. See Fisman et al. (2007); Augenblick and Rabin (2018) for other examples of a subject-level estimation approach.

³⁷For example, Andersen et al. (2018) structurally estimate a one-year discount factor of 0.89 assuming a CRRA atemporal utility function.

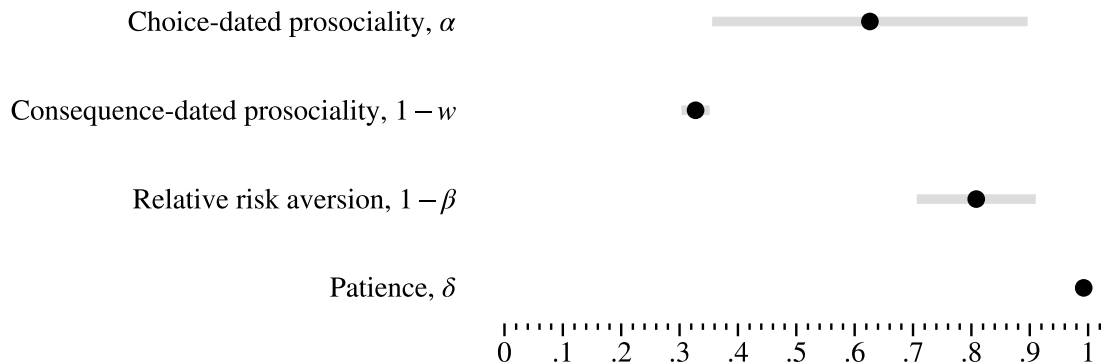

Figure 8: This figure displays the point estimates (black marker) and 95% confidence intervals (gray lines) of the representative agent parameter estimation ($N = 200$). α is the marginal choice-dated prosocial utility from giving, $1 - w$ is the weight on utility from charity-Euro in the stationary flow utility function, $1 - \beta$ is the coefficient of univariate relative risk aversion, and δ is the one-month discount factor.

Second, we estimate positive consequence-dated prosocial utility in line with pure altruism. A value of 0.327 implies that a donation of 50 Euro provides roughly half (i.e. $\frac{1-w}{w}$) of the utility of an identically-dated 50-Euro payment to the subject, consistent with our reduced-form estimate of the subjective exchange rate.

Third, we estimate positive choice-dated utility for a representative agent. A value of 0.626 implies that a donation of 50 Euro in one month additionally provides about 40% of the utility provided by a 50-Euro payment to the subject in one month.³⁸

Next, we turn to the subject-level estimation, which sheds light on the heterogeneity of the parameter distribution in our sample. The corresponding empirical and estimated moments are shown in Figure A.3 in the Appendix. We report three findings.

First, as illustrated by the marginal parameter distributions in Figure 9, we document substantial variation in estimated individual-level parameters. The median subject exhibits a consequence-dated prosociality parameter of 0.353, slightly exceeding the estimate for the representative agent. However, while not being exactly zero, the top right panel of Figure 9 shows that about 20% of respondents have parameter estimates that suggest almost no concern for the consequences of their decisions for others. Similarly, slightly fewer than 60% of our subjects have parameter estimates that suggest the presence of choice-dated prosociality, but among this group the degree of choice-dated motivation is widely dispersed with a median parameter estimate of 0.481.

Second, we find a substantial Spearman correlation of -0.417 between estimated individual parameters that is masked by Figure 9 and shown in Appendix Figure A.4. This

³⁸Note that α is not bounded between 0 and 1, and the larger confidence interval is the result of preference heterogeneity that the subject-level estimation will be able to take into account later.

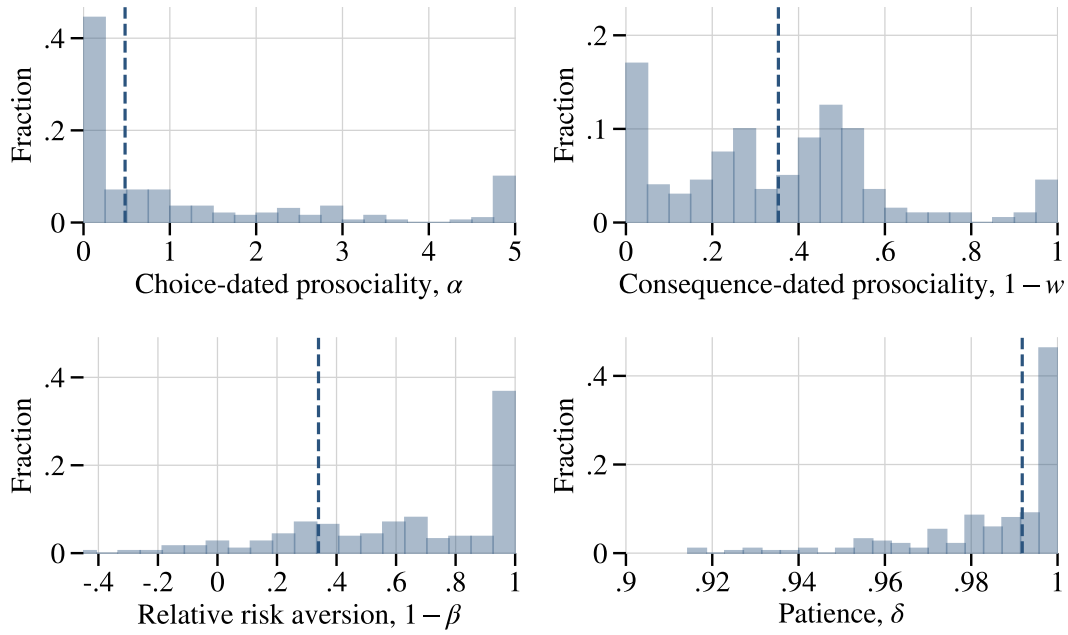

Figure 9: This figure plots the marginal distribution of the model parameters at the subject-level ($N = 200$). It shows the fraction of the sample that is contained in each bin. The dashed vertical line indicates the median of the distribution. The distribution of $1 - \beta$ excludes fifteen subjects with a coefficient of relative risk aversion smaller than -0.50 . The distribution of for δ excludes twelve subjects with a one-month discount factor below 0.90 .

suggests that the prosocial motivations underlying these differently-dated utility flows are substitutes rather than complements at the individual level. Put differently, warm glow and pure altruism might be thought of as motivations that characterize different “types” of people. Our data are compatible with the interpretation that while some people donate out of pure altruism, others are driven by the feeling of warm glow.

Third, we find that the calibrated model replicates the key reduced-form pattern of a declining subjective exchange rate. Recall that – according to Equation (6) – consequence-dated utility flows are discounted as they become delayed into the future, but the choice-dated utility flow is not. Take the following examples to illustrate the median flows of utility estimated by our model, illustrated in Figure 10. Consider first two payments executed in a month from today. A 50-Euro payment to the subject in one month provides 2.42 units of discounted utility to a subject, whereas a 50-Euro donation in one month provides 1.32 utils from consequence-dated utility flows and 0.48 utils from the choice-dated utility flow. Next, consider two payments executed in a year from today. A 50-Euro payment to the subject in a year provides 2.21 discounted utils to a subject, whereas a 50-Euro donation in a year provides only 1.21 utils from consequence-dated utility flows and but still 0.48 utils from the choice-dated utility flow. This suggests that (i) the relative weight of choice-dated utility in the discounted prosocial utility increases

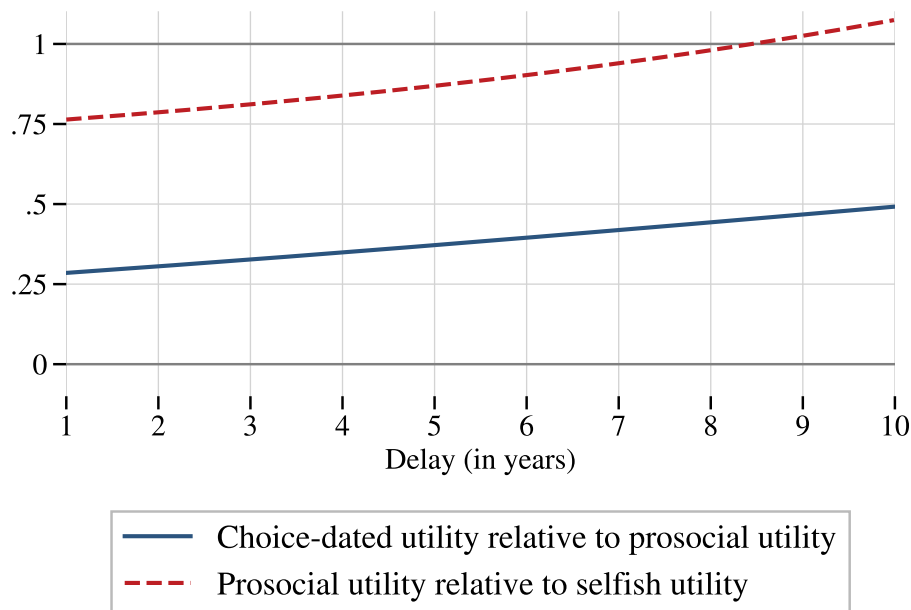

Figure 10: This figure shows a numerical example. We calibrate the model parameters to the median estimates from the individual-level estimation. We then compute (1) the “selfish” utility from 50 self-Euro, (2) the choice-dated prosocial utility from 50 charity-Euro and, (3), the consequence-dated prosocial utility from 50 charity-Euro at various delays. The blue solid line is the ratio of (2) and (2+3). The dashed red line is the ratio of (2+3) and (1).

in the delay, rising from 26.7% to 28.5% in this example,³⁹ and (ii) that the discounted utility value of payments to the subject decline more quickly with delay than the discounted prosocial utility from donations, replicating our reduced-form result 4. In fact, taking the interpretation of the model parameters to the limit, our estimates imply that (i) despite the smaller median parameter characterizing choice-dated than consequence-dated utility in Figure 9, choice-dated exceeds discounted consequence-dated prosocial utility because of the diminishing marginal consequence-dated prosocial utility (as captured by β), and (ii) the overall discounted prosocial utility of a 50-Euro donation exceeds the value of a 50-Euro payment to the subject for a common delay of more than 8.5 years.⁴⁰

We summarize the structural calibration in light of its motivation outlined at the beginning of this section as follows. First, our results reconfirm and complement our reduced-form findings by delivering insights on their quantitative plausibility. Our estimates are quantitatively in line with previous estimates from the literature whenever

³⁹This implies a decrease of the forward exchange rate (at the median estimates) by 0.28 Euro when payments are executed in a year from today rather than now, which is close to the observed decrease of 0.20 Euro in our experiment.

⁴⁰Note that we see this merely as a thought experiment to highlight the logic of the model and the implications of the structural calibration, but we do not intend to give this literal interpretation excessive emphasis. A number of simplifying assumptions affect this calculation, such as linear transformation between self-Euro and charity-Euro, constant choice-dated prosocial utility, the CRRA form of the univariate utility functions, and the assumption of exponential discounting.

such exist, and the numerical calibrations deliver reasonable results about the relative strength of selfish vs. prosocial motivations as well as choice-dated and consequence-dated utility. Second, the results imply that the magnitude of choice-dated utility is quantitatively meaningful, suggesting that the part of the prosocial utility that is not subject to discounting is non-negligible and of first-order importance for modeling intertemporal utility streams.

6 Conclusion

This paper explores the intertemporal dimension of prosocial behavior. Conceptually, we suggest a distinction between choice-dated and consequence-dated flows of prosocial utility. This distinction generalizes differences between different psychological motivations explored in the existing literature and delivers testable implications for intertemporal prosocial behavior. Empirically, we conduct a high-stakes donation experiment that provides a comprehensive characterization of the intertemporal multi-attribute utility function using both reduced-form and structural analyses. We find that the majority of our experimental subjects exhibit both choice-dated and consequence-dated prosocial utility, both motives are quantitatively meaningful, and their incidence is strongly negatively correlated at the individual level.

We conclude with three comments on the limitations and potential promise of the approach taken in this paper. First, the proposed conceptual distinction between consequence-dated and choice-dated utility is deliberately chosen to bridge theoretical work on intertemporal choice with largely empirical work on specific prosocial motivations such as warm glow and pure altruism. At the same time, this taxonomy remains a reduced-form perspective on the psychological mechanisms underlying prosocial behavior. For example, our analysis does not shed light on the sources of pure time preferences about the outcomes of others. First, why do people prefer helping others sooner rather than later? Second, we abstract from the implications of our approach for time-inconsistent behavior, whereby this topic has received significant attention following work on present-biased preferences and has been the focus of related work. Third, while the present paper introduces a toolkit for analyzing the time structure of prosocial utility flows and hints at the usefulness of this approach for understanding prosocial decision-making, it does not provide definite evidence on the underlying prosocial motivations in any particular application. A potential avenue for future research is to harness insights into the time structure of prosocial utility flows to cleanly disentangle the different psychological driving forces of prosocial behavior put forward in the literature.

References

- Altonji, Joseph G. and Lewis M. Segal**, “Small-Sample Bias in GMM Estimation of Covariance Structures,” *Journal of Business & Economic Statistics*, 1996, 14 (3), 353–366.
- Andersen, Steffen, Glenn W. Harrison, Morten I. Lau, and E. Elisabet Rutström**, “Eliciting Risk and Time Preferences,” *Econometrica*, 2008, 76 (3), 583–618.
- , —, —, and —, “Multiattribute Utility Theory, Intertemporal Utility and Correlation Aversion,” *International Economic Review*, 2018, 59 (2), 537–555.
- Andreoni, James**, “Giving with Impure Altruism: Applications to Charity and Ricardian Equivalence,” *Journal of Political Economy*, 1989, 97 (6), 1447–1458.
- , “Impure Altruism and Donations to Public Goods: A Theory of Warm-Glow Giving,” *The Economic Journal*, 1990, 100 (401), 464–477.
- , “An Experimental Test of the Public-Goods Crowding-Out Hypothesis,” *American Economic Review*, 1993, 83 (5), 1317–1327.
- and **A. Abigail Payne**, “Do Government Grants to Private Charities Crowd Out Giving or Fund-raising?,” *American Economic Review*, 2003, 93 (3), 792–812.
- and **Charles Sprenger**, “Estimating Time Preferences from Convex Budgets,” *American Economic Review*, 2012, 102 (7), 3333–56.
- and **John Miller**, “Giving According to GARP: An Experimental Test of the Consistency of Preferences for Altruism,” *Econometrica*, 2002, 70 (2), 737–753.
- , **Michael A. Kuhn, and Charles Sprenger**, “Measuring time preferences: A comparison of experimental methods,” *Journal of Economic Behavior & Organization*, 2015, 116, 451–464.
- Ariely, Dan and Michael I. Norton**, “Conceptual Consumption,” *Annual Review of Psychology*, 2009, 60, 475–499.
- Attema, Arthur E., Han Bleichrodt, Yu Gao, Zhenxing Huang, and Peter P. Wakker**, “Measuring Discounting without Measuring Utility,” *American Economic Review*, 2016, 106 (6), 1476–1494.
- Augenblick, Ned**, “Short-Term Time Discounting of Unpleasant Tasks,” *Working Paper, UC Berkeley*, 2019.

- **and Matthew Rabin**, “An Experiment on Time Preference and Misprediction in Unpleasant Tasks,” *Review of Economic Studies*, 2018, 86 (3), 941–975.
- Balakrishnan, Uttara, Johannes Haushofer, and Pamela Jakiela**, “How soon is now? Evidence of present bias from convex time budget experiments,” *Experimental Economics*, 2020, 23 (2), 294–321.
- Bénabou, Roland and Jean Tirole**, “Incentives and prosocial behavior,” *American Economic Review*, 2006, 96 (5), 1652–1678.
- Bergstrom, Theodore C., Lawrence E. Blume, and Hal R. Varian**, “On the private provision of public goods,” *Journal of Public Economics*, 1986, 29 (1), 25–49.
- Bolton, Gary and Axel Ockenfels**, “ERC: A theory of equity, reciprocity, and competition,” *American Economic Review*, 2000, 90 (1), 166–193.
- **and Elena Katok**, “An experimental test of the crowding out hypothesis: The nature of beneficent behavior,” *Journal of Economic Behavior & Organization*, 1998, 37 (3), 315–331.
- Breman, Anna**, “Give more tomorrow: Two field experiments on altruism and intertemporal choice,” *Journal of Public Economics*, 2011, 95 (11), 1349–1357.
- Bruner, David M.**, “Multiple switching behaviour in multiple price lists,” *Applied Economics Letters*, 2011, 18 (5), 417–420.
- Byrd, Richard H., Peihuang Lu, Jorge Nocedal, and Ciyou Zhu**, “A Limited Memory Algorithm for Bound Constrained Optimization,” *SIAM Journal on Scientific Computing*, 1995, 16 (5), 1190–1208.
- Chabris, Christopher F., David Laibson, Carrie Morris, Jonathon Schuldt, and Dmitry Taubinsky**, “Individual Laboratory-Measured Discount Rates Predict Field Behavior,” *Journal of Risk and Uncertainty*, 2008, 37 (2-3), 237–269.
- Chakraborty, Anujit, Evan M. Calford, Guidon Fenig, and Yoram Halevy**, “External and internal consistency of choices made in convex time budgets,” *Experimental Economics*, 2017, 20 (3), 687–706.
- Chapman, Gretchen B.**, “Temporal discounting and utility for health and money,” *Journal of Experimental Psychology: Learning, Memory, and Cognition*, 1996, 22 (3), 771.
- Charness, Gary and Matthew Rabin**, “Understanding Social Preferences with Simple Tests,” *Quarterly Journal of Economics*, 2002, 117 (3), 817–869.

- Chen, Daniel L., Martin Schonger, and Chris Wickens**, “oTree—An open-source platform for laboratory, online, and field experiments,” *Journal of Behavioral and Experimental Finance*, 2016, 9, 88–97.
- Cohen, Jonathan D., Keith Ericson, David Laibson, and John Miles White**, “Measuring time preferences,” *Journal of Economic Literature*, 2019.
- Cousineau, Denis**, “Confidence intervals in within-subject designs: A simpler solution to Loftus and Masson’s method,” *Tutorials in Quantitative Methods for Psychology*, 2005, 1 (1), 42–45.
- Cubitt, Robin and Daniel Read**, “Can Intertemporal Choice Experiments Elicit Preferences for Consumption,” *Experimental Economics*, 2007, 10 (4), 369–389.
- , **Rebecca McDonald, and Daniel Read**, “Time Matters Less When Outcomes Differ: Unimodal vs. Cross-Modal Comparisons in Intertemporal Choice,” *Management Science*, 2018, 64 (2), 873–887.
- Deck, Cary and Harris Schlesinger**, “Exploring higher order risk effects,” *Review of Economic Studies*, 2010, 77 (4), 1403–1420.
- and —, “Consistency of higher order risk preferences,” *Econometrica*, 2014, 82 (5), 1913–1943.
- DellaVigna, Stefano**, “Structural Behavioral Economics,” in B. Douglas Bernheim, Stefano DellaVigna, and David Laibson, eds., *Handbook of Behavioral Economics*, Vol. 1 of *Applications and Foundations 1*, North-Holland, 2018, pp. 613–723.
- Dohmen, Thomas, Armin Falk, David Huffman, and Uwe Sunde**, “The Robustness and Pervasiveness of Sub-Additivity in Intertemporal Choice,” *Working Paper*, 2017.
- Dreber, Anna, Drew Fudenberg, David K. Levine, and David G. Rand**, “Self-Control, Social Preferences and the Effect of Delayed Payments,” *SSRN Working Paper*, 2016.
- Dufwenberg, Martin and Georg Kirchsteiger**, “A theory of sequential reciprocity,” *Games and Economic Behavior*, 2004, 47 (2), 268–298.
- Ebert, Sebastian and Daniel Wiesen**, “Joint measurement of risk aversion, prudence, and temperance,” *Journal of Risk and Uncertainty*, 2014, 48 (3), 231–252.
- and **Gijs van de Kuilen**, “Measuring multivariate risk preferences,” *SSRN Working Paper*, 2015.

- Eeckhoudt, Louis and Harris Schlesinger**, “Putting risk in its proper place,” *American Economic Review*, 2006, 96 (1), 280–289.
- Epstein, Larry G. and Stephen M. Tanny**, “Increasing Generalized Correlation: A Definition and Some Economic Consequences,” *Canadian Journal of Economics*, 1980, 13 (1), 16–34.
- Ericson, Keith Marzilli and Jawwad Noor**, “Delay Functions as the Foundation of Time Preference: Testing for Separable Discounted Utility,” *NBER Working Paper*, 2015.
- Exley, Christine L.**, “Excusing Selfishness in Charitable Giving: The Role of Risk,” *Review of Economic Studies*, 2015, 83 (2), 587–628.
- and **Judd B. Kessler**, “Motivated Errors,” *National Bureau of Economic Research*, 2019.
- Falk, Armin and Urs Fischbacher**, “A theory of reciprocity,” *Games and Economic Behavior*, 2006, 54 (2), 293–315.
- Fehr, Ernst and Klaus M. Schmidt**, “A theory of fairness, competition, and cooperation,” *Quarterly Journal of Economics*, 1999, 114 (3), 817–868.
- Fisman, Raymond, Shachar Kariv, and Daniel Markovits**, “Individual Preferences for Giving,” *American Economic Review*, 2007, 97 (5), 1858–1876.
- Frederick, Shane**, “Valuing future life and future lives: A framework for understanding discounting,” *Journal of Economic Psychology*, 2006, 27 (5), 667–680.
- Gabler, Janos**, “A Python Tool for the Estimation of (Structural) Econometric Models.,” 2020. <https://github.com/OpenSourceEconomics/estimagic>.
- Halevy, Yoram**, “Time Consistency: Stationarity and Time Invariance,” *Econometrica*, 2015, 83 (1), 335–352.
- Hardisty, David J. and Elke U. Weber**, “Discounting future green: Money versus the environment,” *Journal of Experimental Psychology: General*, 2009, 138 (3), 329.
- Holt, Charles A. and Susan K. Laury**, “Risk Aversion and Incentive Effects,” *American Economic Review*, 2002, 92 (5), 1644–1655.
- Kim, Hyunji, Simone Schnall, and Mathew P. White**, “Similar psychological distance reduces temporal discounting,” *Personality and Social Psychology Bulletin*, 2013, 39 (8), 1005–1016.

- Kolappan, C., R. Subramani, V. Kumaraswami, T. Santha, and P. R. Narayanan**, “Excess mortality and risk factors for mortality among a cohort of TB patients from rural south India,” *The International Journal of Tuberculosis and Lung Disease*, 2008, 12 (1), 81–86.
- Kölle, Felix and Lukas Wenner**, “Time-Inconsistent Generosity: Present Bias Across Individual and Social Contexts,” *Working paper*, 2018.
- Konow, James**, “Mixed feelings: Theories and evidence of warm glow and altruism,” *Available at SSRN 980349*, 2006.
- Kovarik, Jaromir**, “Giving it now or later: Altruism and discounting,” *Economics Letters*, 2009, 102 (3), 152–154.
- McClure, Samuel M., Keith M. Ericson, David I. Laibson, George Loewenstein, and Jonathan D. Cohen**, “Time Discounting for Primary Rewards,” *Journal of Neuroscience*, 2007, 27 (21), 5796–5804.
- Meer, Jonathan and Benjamin A. Priday**, “Generosity Across the Income and Wealth Distributions,” *NBER Working Paper*, 2020.
- Morey, Richard**, “Confidence intervals from normalized data: A correction to Cousineau (2005),” *Tutorials in Quantitative Methods for Psychology*, 2008, 4 (2), 61–64.
- Newey, Whitney K. and Daniel McFadden**, “Large sample estimation and hypothesis testing,” in R. F. Engle and D. L. McFadden, eds., *Handbook of Econometrics*, Vol. 4, Elsevier, 1994, pp. 2111 – 2245.
- Olea, José Luis Montiel and Tomasz Strzalecki**, “Axiomatization and measurement of quasi-hyperbolic discounting,” *Quarterly Journal of Economics*, 2014, 129 (3), 1449–1499.
- Richard, Scott F.**, “Multivariate Risk Aversion, Utility Independence and Separable Utility Functions,” *Management Science*, 1975, 22 (1), 12–21.
- Roberts, Russell D.**, “A Positive Model of Private Charity and Public Transfers,” *Journal of Political Economy*, 1984, 92 (1), 136–148.
- Rogers, Todd and Max H. Bazerman**, “Future lock-in: Future implementation increases selection of ‘should’ choices,” *Organizational Behavior and Human Decision Processes*, 2008, 106 (1), 1–20.

- Schelling, T. C.**, “The mind as a consuming organ,” in David E. Bell, Howard Raiffa, and Amos Tversky, eds., *Decision Making: Descriptive, Normative, and Prescriptive Interactions*, Cambridge University Press, 1988, pp. 343–357.
- Schubert, Renate, Martin Brown, Matthias Gysler, and Hans Wolfgang Brachinger**, “Financial Decision-Making: Are Women Really More Risk-Averse?,” *American Economic Review*, 1999, 89 (2), 381–385.
- Starmer, Chris**, “Developments in Non-expected Utility Theory: The Hunt for a Descriptive Theory of Choice under Risk,” *Journal of Economic Literature*, 2000, 38 (2), 332–382.
- Straetemans, Masja, Philippe Glaziou, Ana L. Bierrenbach, Charalambos Sismanidis, and Marieke J. van der Werf**, “Assessing Tuberculosis Case Fatality Ratio: A Meta-Analysis,” *PLOS ONE*, 2011, 6 (6), 1–13.
- Tiemersma, Edine W., Marieke J. van der Werf, Martien W. Borgdorff, Brian G. Williams, and Nico J. D. Nagelkerke**, “Natural History of Tuberculosis: Duration and Fatality of Untreated Pulmonary Tuberculosis in HIV Negative Patients: A Systematic Review,” *PLOS ONE*, 2011, 6 (4), 1–13.
- Wakker, Peter P.**, “Explaining the characteristics of the power (CRRA) utility family,” *Health Economics*, 2008, 17 (12), 1329–1344.
- Warr, Peter G.**, “Pareto optimal redistribution and private charity,” *Journal of Public Economics*, 1982, 19 (1), 131–138.

Appendix

A Tables and Figures

Table A.1: Summary statistics

	Observations	Mean	Std. dev.	Min	25th	Median	75th	Max
Age	244	25	5.5	18	22	23	26	61
Female	244	.57	.5	0	0	1	1	1
Household income	244	1,446	1,133	0	650	1,000	2,000	4,000
Savings	244	.54	.5	0	0	1	1	1
Education (years)	244	16	3.5	3	15	16	18	29
Student	244	.91	.29	0	1	1	1	1
Political orientation	244	2.3	1.3	0	1	2	3	6
Siblings	244	1.5	1.2	0	1	1	2	7
Raven score	244	6.1	1.7	0	5	6	7	10

Note: This table shows summary statistics for the full sample. “Household income” is the self-reported total monthly household income after taxes and transfers (in Euros); “Savings” is a binary variable taking the value of 1 if the subject reported that she is able to save money each month; “Education (years)” are the subject’s total years of education starting from primary school; “Student” is a binary variable taking value of 1 if the subject is enrolled at a university degree program; “Political orientation” is measured on a scale from 1 (“rather left”) to 7 (“rather right”); “Siblings” are the total number of siblings; “Raven score” is the number of correctly solved Raven matrices out of ten.

Table A.2: Regression analysis of intertemporal choices

	Univariate discounting			Multivariate discounting			Exchange rate
	(1)	(2)	(3)	(4)	(5)	(6)	(7)
charity-Euro	-0.005 (0.008)		0.001 (0.004)	2.277 (0.535)		2.897 (0.758)	
1 month							-0.042 (0.036)
3 months		-0.072 (0.004)	-0.070 (0.005)		-0.678 (0.158)	-0.439 (0.109)	-0.084 (0.039)
6 months		-0.138 (0.006)	-0.132 (0.008)		-1.087 (0.193)	-0.646 (0.158)	-0.137 (0.045)
12 months		-0.205 (0.009)	-0.199 (0.011)		-1.485 (0.250)	-0.927 (0.181)	-0.195 (0.054)
3 months \times charity-Euro			-0.003 (0.006)			-0.478 (0.320)	
6 months \times charity-Euro			-0.011 (0.009)			-0.883 (0.373)	
12 months \times charity-Euro			-0.011 (0.013)			-1.117 (0.471)	
Constant	0.843 (0.004)	0.944 (0.004)	0.943 (0.005)	1.430 (0.268)	3.381 (0.140)	1.933 (0.308)	2.070 (0.030)
N	1952	1952	1952	1952	1952	1952	1220
R^2	0.386	0.620	0.621	0.428	0.404	0.437	0.921
Subject FE	Yes	Yes	Yes	Yes	Yes	Yes	Yes

Note: This table shows pooled OLS regression estimates where the unit of observation are subject-choices. In columns 1–3, we include all choices from the two univariate discounting stages (UD-S, UD-C). The dependent variable is the net present value $y_{i,\tau,d}$ of the delayed payment where i denotes the subject, τ the delay in months, and d is the numéraire of the payments (self-Euro or charity-Euro). Columns 4–6 include all choices from from the two multivariate discounting stages (MD-S, MD-C). The dependent variable is the net present value $y_{i,\tau,d}$ of the delayed payment using the type d of the earlier payment (self-Euro or charity-Euro) as numéraire. In column 7, we include all choices from the exchange rate stage ER. The dependent variable is the implied (forward) exchange rate $y_{i,\tau}$ at different delays τ . “charity-Euro” is a binary indicator variable taking the value of 1 if the numéraire of the earlier payment are charity-Euro; “ τ month(s)” is a binary indicator variable taking the value of 1 if the later payment is received with a delay of τ month(s), where $\tau = 1$ month is the omitted category in columns 1–6 and “0 months” is the omitted category in column 7. All regressions include subject fixed effects for the 244 subjects. Standard errors are clustered at the subject level and shown in parentheses.

Treffen Sie jetzt Ihre Entscheidung

Bitte geben Sie für jede Zeile in der folgenden Tabelle an, ob Sie **Option A** oder **Option B** wählen.

	Option A		Option B
	50,00 € heute selbst erhalten.	<input type="radio"/> <input type="radio"/>	0,00 € in 6 Monaten an Operation ASHA spenden.
	50,00 € heute selbst erhalten.	<input type="radio"/> <input type="radio"/>	10,50 € in 6 Monaten an Operation ASHA spenden.
	50,00 € heute selbst erhalten.	<input type="radio"/> <input type="radio"/>	21,00 € in 6 Monaten an Operation ASHA spenden.
	50,00 € heute selbst erhalten.	<input type="radio"/> <input type="radio"/>	31,50 € in 6 Monaten an Operation ASHA spenden.
	50,00 € heute selbst erhalten.	<input type="radio"/> <input type="radio"/>	42,00 € in 6 Monaten an Operation ASHA spenden.
	50,00 € heute selbst erhalten.	<input type="radio"/> <input type="radio"/>	52,50 € in 6 Monaten an Operation ASHA spenden.
	50,00 € heute selbst erhalten.	<input type="radio"/> <input type="radio"/>	63,00 € in 6 Monaten an Operation ASHA spenden.
	50,00 € heute selbst erhalten.	<input type="radio"/> <input type="radio"/>	73,50 € in 6 Monaten an Operation ASHA spenden.
	50,00 € heute selbst erhalten.	<input type="radio"/> <input type="radio"/>	84,00 € in 6 Monaten an Operation ASHA spenden.
	50,00 € heute selbst erhalten.	<input type="radio"/> <input type="radio"/>	94,50 € in 6 Monaten an Operation ASHA spenden.
	50,00 € heute selbst erhalten.	<input type="radio"/> <input type="radio"/>	105,00 € in 6 Monaten an Operation ASHA spenden.
	50,00 € heute selbst erhalten.	<input type="radio"/> <input type="radio"/>	115,50 € in 6 Monaten an Operation ASHA spenden.
	50,00 € heute selbst erhalten.	<input type="radio"/> <input type="radio"/>	126,00 € in 6 Monaten an Operation ASHA spenden.
	50,00 € heute selbst erhalten.	<input type="radio"/> <input type="radio"/>	136,50 € in 6 Monaten an Operation ASHA spenden.
	50,00 € heute selbst erhalten.	<input type="radio"/> <input type="radio"/>	147,00 € in 6 Monaten an Operation ASHA spenden.
	50,00 € heute selbst erhalten.	<input type="radio"/> <input type="radio"/>	157,50 € in 6 Monaten an Operation ASHA spenden.
	50,00 € heute selbst erhalten.	<input type="radio"/> <input type="radio"/>	168,00 € in 6 Monaten an Operation ASHA spenden.
	50,00 € heute selbst erhalten.	<input type="radio"/> <input type="radio"/>	178,50 € in 6 Monaten an Operation ASHA spenden.
	50,00 € heute selbst erhalten.	<input type="radio"/> <input type="radio"/>	189,00 € in 6 Monaten an Operation ASHA spenden.
	50,00 € heute selbst erhalten.	<input type="radio"/> <input type="radio"/>	199,50 € in 6 Monaten an Operation ASHA spenden.
	50,00 € heute selbst erhalten.	<input type="radio"/> <input type="radio"/>	210,00 € in 6 Monaten an Operation ASHA spenden.
	50,00 € heute selbst erhalten.	<input type="radio"/> <input type="radio"/>	220,50 € in 6 Monaten an Operation ASHA spenden.
	50,00 € heute selbst erhalten.	<input type="radio"/> <input type="radio"/>	231,00 € in 6 Monaten an Operation ASHA spenden.
	50,00 € heute selbst erhalten.	<input type="radio"/> <input type="radio"/>	241,50 € in 6 Monaten an Operation ASHA spenden.
	50,00 € heute selbst erhalten.	<input type="radio"/> <input type="radio"/>	252,00 € in 6 Monaten an Operation ASHA spenden.
	50,00 € heute selbst erhalten.	<input type="radio"/> <input type="radio"/>	262,50 € in 6 Monaten an Operation ASHA spenden.

Automatische Ausfüllhilfe: Damit Sie weniger klicken müssen, haben wir eine Ausfüllhilfe aktiviert, die automatisch Auswahlfelder für Sie ausfüllt.

Weiter

Figure A.1: This is an example of the decision screen as seen by subjects in stage *MD – SELF* of the intertemporal choice part of the experiment. The original instructions in German are shown. In each row, subjects indicate whether they prefer option A or option B by selecting the appropriate circle in each row. Option A on the left-hand side offers 50 self-Euro today. Option B on the right-hand side offers increasing amounts of charity-Euro from 0 to 262.50 Euro. The amount will be wired to *Operation ASHA* in six months. All price lists in the intertemporal choice part of our experiment are presented in this format. We vary only (i) the amount offered in option B, (ii) the timing of payments (both for option A and option B), and (iii) whether payments are denoted in self-Euro or charity-Euro. The decision screens are otherwise identical.

Entscheidung

Ihre **Ausgangsausstattung** für die folgende Entscheidung:

- 40,00 € als **Auszahlung an Sie**, und
- 0,00 € als **Spendenauszahlung** an die Organisation *Operation ASHA*.

Zusätzlich müssen Sie sich nun zwischen **Lotterie A** und **Lotterie B** entscheiden.

Lotterie A

10,00 € weniger
Auszahlung an Sie

Wenn Kopf
geworfen wird:

Wenn Zahl
geworfen wird:

Zusatzlotterie für Ihre Auszahlung
Mit 20% Wahrscheinlichkeit: Gewinn von 28 € für Sie
Mit 80% Wahrscheinlichkeit: Verlust von 7 € für Sie

Lotterie B

10,00 € weniger
Auszahlung an Sie

UND

Wenn Kopf
geworfen wird:

Wenn Zahl
geworfen wird:

Zusatzlotterie für Ihre Auszahlung
Mit 20% Wahrscheinlichkeit: Gewinn von 28 € für Sie
Mit 80% Wahrscheinlichkeit: Verlust von 7 € für Sie

UND X € zusätzliche
Auszahlung an Sie

X € zusätzliche
Auszahlung an Sie

Hinweis: X € wird also immer dann gezahlt, wenn Sie **Lotterie B** wählen, und zwar unabhängig davon, ob **Kopf** oder **Zahl** geworfen wird.
Ob X positiv (ein Gewinn) oder negativ (ein Verlust) ist, hängt von der Entscheidungssituation ab.

Lotterie A	<input type="radio"/>	<input type="radio"/>	Lotterie B mit X = -5,00 €
Lotterie A	<input type="radio"/>	<input type="radio"/>	Lotterie B mit X = -4,50 €
Lotterie A	<input type="radio"/>	<input type="radio"/>	Lotterie B mit X = -4,00 €
Lotterie A	<input type="radio"/>	<input type="radio"/>	Lotterie B mit X = -3,50 €
Lotterie A	<input type="radio"/>	<input type="radio"/>	Lotterie B mit X = -3,00 €
Lotterie A	<input type="radio"/>	<input type="radio"/>	Lotterie B mit X = -2,50 €
Lotterie A	<input type="radio"/>	<input type="radio"/>	Lotterie B mit X = -2,00 €
Lotterie A	<input type="radio"/>	<input type="radio"/>	Lotterie B mit X = -1,50 €
Lotterie A	<input type="radio"/>	<input type="radio"/>	Lotterie B mit X = -1,00 €
Lotterie A	<input type="radio"/>	<input type="radio"/>	Lotterie B mit X = -0,50 €
Lotterie A	<input type="radio"/>	<input type="radio"/>	Lotterie B mit X = 0,00 €
Lotterie A	<input type="radio"/>	<input type="radio"/>	Lotterie B mit X = 0,50 €
Lotterie A	<input type="radio"/>	<input type="radio"/>	Lotterie B mit X = 1,00 €
Lotterie A	<input type="radio"/>	<input type="radio"/>	Lotterie B mit X = 1,50 €
Lotterie A	<input type="radio"/>	<input type="radio"/>	Lotterie B mit X = 2,00 €
Lotterie A	<input type="radio"/>	<input type="radio"/>	Lotterie B mit X = 2,50 €
Lotterie A	<input type="radio"/>	<input type="radio"/>	Lotterie B mit X = 3,00 €
Lotterie A	<input type="radio"/>	<input type="radio"/>	Lotterie B mit X = 3,50 €
Lotterie A	<input type="radio"/>	<input type="radio"/>	Lotterie B mit X = 4,00 €
Lotterie A	<input type="radio"/>	<input type="radio"/>	Lotterie B mit X = 4,50 €
Lotterie A	<input type="radio"/>	<input type="radio"/>	Lotterie B mit X = 5,00 €

Automatische Ausfüllhilfe: Damit Sie weniger klicken müssen, haben wir eine Ausfüllhilfe aktiviert, die automatisch Auswahlfelder für Sie ausfüllt.

Weiter

Figure A.2: This is an example of the decision screen as seen by subjects in stage *RA – SELF* of the risky choice part of the experiment. The original instructions in German are shown. At the top of the screen, subjects are informed about their initial endowment e of 40 self-Euro and 0 charity-Euro. Next, subjects see two boxes that contain a visual representation of lottery A and lottery B. In each box, the upper part explains the consequences when the simulated coin toss yields head, whereas the lower part explains the consequences if it yields tails. In the lower part of the screen, subjects indicate whether they prefer lottery A or lottery B by selecting the appropriate circle in each row. The right-hand side shows the compensation amounts m that are to be added to lottery B. They range from -5.00 self-Euro to 5.00 self-Euro. All decisions in the risky choice part of our experiment are presented in this format. We vary only (i) the lotteries (ii) the range of the compensation amounts. The decision screens are otherwise identical.

clearpage

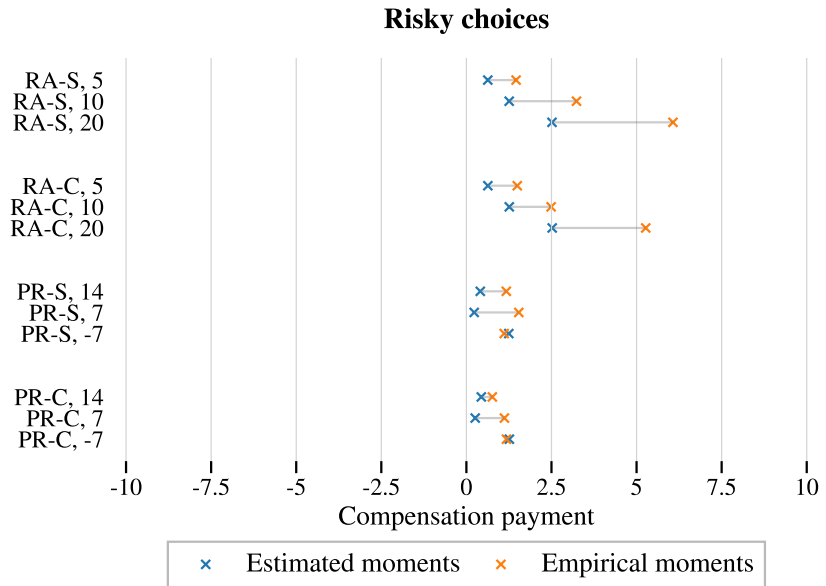
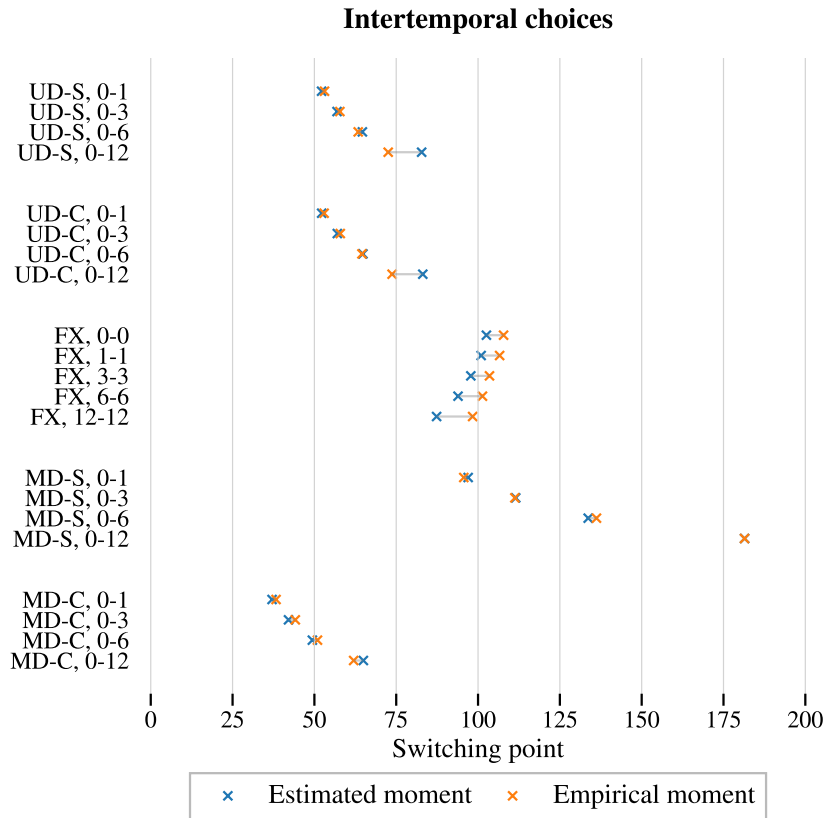

Figure A.3: This figure plots the empirical and the estimated moments for our estimation sample ($N = 200$). The moments are the average switching point in each of our 33 price lists. The upper panel shows moments for intertemporal choices, while the lower panel reports moments for risky choices from part B of the experiment. For intertemporal choices, labels on the vertical axis groups task by their stage (UD-S, UD-C, FX, MD-S, MD-C) and indicate the delay of the sooner and the later payment. For example, “6-6” means that both payments were made 6 months after the experiment. For risky choices, we indicate the size of the deduction R_2 (see Table 1 for more details).

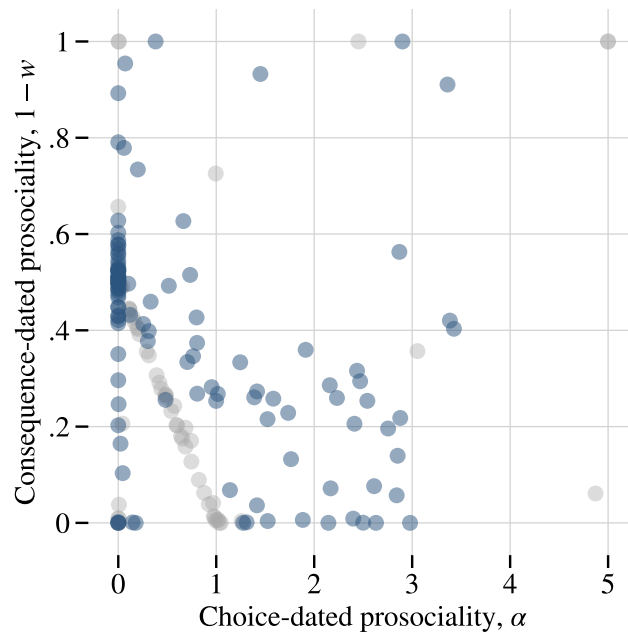

Figure A.4: This figure shows the joint distribution ($N = 200$) of the choice-dated prosociality parameter, α , and the consequence-dated prosociality parameter, $1 - w$. The circles in dark gray indicate the subsample of subjects with a degree of risk aversion that is outside the range of the structural model, i.e. they have a coefficient of relative risk aversion greater than 0.90. The Spearman correlation is -0.417 in the full sample and -0.447 in the subsample.

B Conceptual framework

We briefly discuss choice-dated prosocial utility and conditions that imply a declining forward exchange rate. Recall that t denotes the current period, τ indexes time relative to t , $x_{t+\tau}$ denotes a dated payment to the decision-maker to be received at $t + \tau$, and $g_{t+\tau}$ represents a donation to charity that was caused at time t and will be received by the charity in τ periods. Suppose that the decision-maker's preferences are given by

$$U_t = \alpha(\mathbf{g}) + \sum_{\tau=0}^{\infty} D(\tau)u(x_{t+\tau}), \quad (9)$$

where $\alpha(\cdot)$ captures the choice-dated prosocial utility derived from the stream of future donations $\mathbf{g} = (g_{t+\tau})_{\tau}$ that has been *caused* in t . As we are mainly interested in the effect of delays, we replace α by a linear approximation

$$\alpha(\mathbf{g}) \approx a \sum_{\tau=0}^{\infty} D^c(\tau)g_{t+\tau} \quad (10)$$

where $D^c(\tau)$ can be interpreted as an implicit “discount factor” that describes how choice-dated prosocial utility from causing a future charitable donation depreciates with the delay of the donation. We provide a sufficient condition for an asymptotically declining forward exchange rate:

Assumption 1. *The implicit discount factor $D^c(\tau)$ declines at a lower rate than the subjective discount factor $D(\tau)$, i.e. $\lim_{\tau \rightarrow \infty} D^c(\tau)/D(\tau) = \infty$.*

Intuitively, this implies that the choice-dated prosocial utility from the act of giving itself is less sensitive to the delay τ than the utility from payments to the self.¹ Thus, for large τ , the choice-dated prosocial utility will be insensitive to the delay τ relative to the sensitivity of utility from self-Euro: the forward exchange rate will converge to 0.

We provide a simple example to illustrate why we would expect this condition to hold. Suppose that causing a delayed donation $g_{t+\tau}$ at time t provides an immediate feeling of warm glow (Andreoni, 1989), $\bar{\alpha}$, independent of the size of the donation itself, in addition to other sources of choice-dated prosocial utility, i.e. suppose that the choice-dated prosocial utility generated by $g_{t+\tau}$ is:

$$\bar{\alpha}\mathbb{1}(g_{t+\tau} > 0) + v_{\tau}(g_{t+\tau}) \quad (11)$$

where $v_{\tau}(g_{t+\tau})$ is a family of positive function. Today, the decision-maker prefers a de-

¹If we are willing to assume exponential discounting, i.e. $D^c(\tau) = \delta_c^{\tau}$ and $D(\tau) = \delta^{\tau}$, the assumption is equivalent to $\delta_c > \delta$.

layed donation $g_{t+\tau}$ in τ periods to an equally delayed amount $x_{t+\tau}$ of self-Euros if

$$\bar{\alpha} + v_{\tau}(g_{t+\tau}) \geq D(\tau)u(x) \iff \underbrace{\frac{\bar{\alpha}}{D(\tau)u(x)}}_{\rightarrow \infty} + \underbrace{\frac{v_{\tau}(g_{t+\tau})}{D(\tau)u(x)}}_{\geq 0} \geq 1 \quad (12)$$

Thus, for large τ , the decision-maker will prefer the donation to contemporaneous self-Euro, implying a asymptotically declining forward exchange rate. Note that we only need the existence of an (arbitrarily small) positive lower bound on the utility from the act of giving itself to obtain this result:

Proposition 1. *Suppose that the choice-dated prosocial utility from causing a dated donation g at time t that will be received by the charity at $t + \tau$ is bounded from below by $\bar{\alpha} > 0$. Then, the forward exchange rate converges to zero.*

Intuitively, the subjective discount factors imply that the present value of future self-Euro becomes negligible for large τ and eventually falls below the lower bound on the immediate choice-dated prosocial utility (e.g. “warm glow”). In particular, we do not need any additional assumptions on the source of prosocial utilities.

C Experimental Instructions

The original instructions used in the laboratory experiment are in German. Here, we provide a translation of the instructions into the English language. The experiment has two parts. Each part consists of five different stages and each stage contains multiple price lists. To avoid repetitions, we only include the translation of one price list per stage. Within a stage, the instructions are constant across price lists except for changes in the monetary amounts or the number of months until a payment is made. See Section 3 of the paper for more details on how price lists were constructed. The following sections contain the translations:

C.1 Introduction

Welcome and thank you for your interest in this study!

For your participation you will receive a fixed payment of 10.00 €, which will be paid to you by bank transfer after the study. In this study you will take decisions on the computer. Depending on how you decide you can earn additional money.

During the entire study it is not allowed to talk to other participants. Please turn off your mobile phone now, so that other participants will not be disturbed. Please only use the designated functions on the computer and make your entries using the keyboard and the mouse. If you have any questions, please make a hand signal. Your question will be answered at your seat.

On the next screens you will see detailed information concerning the study. After reading this information you can confirm or refuse your participation.

To proceed click "Next".

[end of screen]

Information on Participation in this study of the *BonnEconLab*

The following information have been sent to you via email together with the confirmation of your registration for this study. You receive this information again now. Once you have read the subsequent declaration of consent you can confirm your participation by clicking on "I agree".

[followed by mandated exclusion restrictions for participation in this study]

[end of screen]

Information

In the following you will see important information, which are relevant for your subsequent decisions. They are about the disease tuberculosis and its possible treatment. Please read all information carefully.

[end of screen]

Information about Tuberculosis

What is tuberculosis?

Tuberculosis – also called consumptiveness or White Death – is an infectious disease, which is caused by bacteria. Roughly one third of all humans are infected with the pathogen of tuberculosis. Active tuberculosis breaks out among 5 to 10% of all those infected. Tuberculosis is primarily airborne. This is also why a quick treatment is necessary.

What are the symptoms of tuberculosis?

Tuberculosis patients often suffer from very unspecific symptoms like fatigue, feeling of weakness, lack of appetite and weight loss. At an advanced stage of lung tuberculosis, the patient coughs up blood, leading to the so-called rush of blood. Without treatment a person with tuberculosis dies with a probability of 43%.

How prevalent is tuberculosis?

In the year 2014, 6 million people have been recorded as falling ill with active tuberculosis. Almost 1.5 million people die of tuberculosis each year. This means more deaths due to tuberculosis than due to HIV, malaria or any other infectious disease.

Is tuberculosis curable?

Today tuberculosis is curable. Treatment is administered by giving antibiotics several times each week over a period of 6 months. It is important that there is no interruption of treatment. In the years 2000 to 2014 approximately 43 million human lives could be saved due to an effective diagnosis and treatment of tuberculosis. The success rate of treatment for a new infection is often above 85%. The preceding numbers and information are provided by the World Health Organization (WHO), the United Nations' institution for the international public health, and are freely available. You can check this information on the web page of the WHO after this study.

[end of screen]



Figure C.1: Typical appearance of a tuberculosis patient

Your decision

In the course of this study you can choose between options that have different consequences. In particular, you can choose between options with the following consequences:

Additional Payment: If you choose this option, you will receive an additional payment.

Saving a Human Life: If you choose this option, you will not receive an additional payment. This option has another consequence: You save one human life.

After it has emerged which option will be implemented for you, it will be carried out exactly as described. On the next tab you will receive more information about the implementation of Saving a Human Life.

[end of screen]

Information about saving a human life

How will the human life be saved?

Depending on how you decide, a human life can be saved. A human life will be saved by arranging a donation of 350.00 € to an organization which identifies and treats people suffering from tuberculosis on your behalf. This donation will be executed for you by the BonnEconLab after the study. The entire donation amount will be used by the organization for the direct treatment of tuberculosis.

What does it mean to "save a life"?

To save a human life here means the successful cure from tuberculosis for one person, who *otherwise* would have died due to his tuberculosis. That means in particular: The donation amount is sufficient to identify and cure as many sick persons such that there is at least one person among these, who would otherwise have died from tuberculosis in expectation. The calculation of the amount accommodates the fact that there are other ways (e.g., the national health care system) through which people can be cured. That means: **The amount of 350.00 € was calculated in such a way that the organization can save at least one additional human from death.**

On the next tab you will receive additional information about the possible saving of a human life and details about the organization that treats tuberculosis patients.

[end of screen]

Operation ASHA

Your decisions can save a human life. Depending on how you decide, an amount of 350.00 € will be transferred to the organization *Operation ASHA* after the study.

Operation ASHA is a charity organization specialized since 2005 on treating tuberculosis in disadvantaged communities. The work of *Operation ASHA* is based on the insight that the biggest obstacle for the treatment of tuberculosis is the interruption of the necessary 6-month-long regular intake of medication. For a successful treatment the patient has to come to a medical facility twice a week – more than 60 times in total – to take the medication. An interruption or termination of the treatment is fatal, because this strongly enhances the development of a drug-resistant form of tuberculosis. This form of tuberculosis is much more difficult to treat and almost always leads to death.

To overcome this problem, *Operation ASHA* developed a concept that guarantees the regular treatment through immediate spatial proximity to the patient. A possible non-adherence is additionally prevented by visiting the patient at home. By now *Operation ASHA* runs more than 360 treatment centers, almost all of which are located in the poorer regions of India. More than 60,000 sick persons have been identified and treated that way.

Operation ASHA is an internationally recognized organization, and their successes have been covered by the New York Times, BBC and Deutsche Welle, for example. The MIT and the University College London have already conducted research projects about the fight against tuberculosis in cooperation with *Operation ASHA*. The treatment method employed by *Operation ASHA* is described by the World Health Organization (WHO) as “highly efficient and cost-effective”.

[end of screen]



Figure C.2: An employee of Operation ASHA provides medicine to a tuberculosis patient.

What determines the donation amount for saving a human life?

The donation amount makes sure that at least one human life is saved in expectation.

The information used for the calculation of the donation amount exclusively consists of public statements by the World Health Organization (WHO), peer-reviewed research studies, statistical releases from the Indian government as well as published figures from *Operation ASHA*. In the calculation all information was interpreted in a conservative way and more pessimistic estimates were used in case of doubt, such that the donation amount of 350.00 € is, if anything, higher than the actual costs associated with saving a human life. Moreover, the calculation was based on the treatment success rate of *Operation ASHA*, the mortality rate of an alternative treatment by the national tuberculosis program in India, and different detection rates for new cases of tuberculosis have been accounted for.

Based on a very high number of cases, one can illustrate the contribution of your donation as follows:

With your donation *Operation ASHA* can treat 5 additional tuberculosis patients.

If these 5 sick persons would not be treated by *Operation ASHA*, one patient would die in expectation. If 5 persons are treated by means of your donation, no patient dies in expectation. Based on these expected values this means that one human life will be saved with your donation. This relationship is depicted in the following diagram.

a) Without treatment by *Operation ASHA*, one of 5 persons sick of tuberculosis will die in expectation.



b) With the donation 5 persons sick of tuberculosis can be treated by *Operation ASHA* and nobody none of these persons will die in expectation.



An agreement with *Operation ASHA* for the purpose of this study ensures that 100 % of the donation amount will exclusively be used for the diagnosis and treatment of tuberculosis patients. That means that every euro of the donation amount will directly go into saving human lives and no other costs will be covered with it.

[end of screen]

Summary

Tuberculosis

The success rate of medical treatment for a new infection is very high. Nevertheless, 1.5 million people die from tuberculosis each year. The biggest obstacle for the cure of tuberculosis is a possible termination of the regular treatment with antibiotics. The concept of *Operation ASHA* is therefore based on the direct spatial proximity to their patients and on the control and recording of the regular intake of medication.

Your decision

In the course of this study you can choose between options that have different consequences. In particular, you can choose between options with the following consequences: You can choose the additional monetary payment. If you choose the other option, you will not receive an additional monetary payment, but you can save a human life. Concretely, by choosing the other option you will cause a donation. The donation of 350.00 € will be paid on your behalf, which is sufficient not only to cure one person, but to actually save that person from death by tuberculosis.

How is the human life saved?

The donation amount of 350.00 € already accounts for the fact that a sick person could also have survived without treatment by *Operation ASHA*; or that he could instead have been treated by the national health care system. This is why the amount is sufficient for the diagnosis and complete treatment of several affected persons.

Please note: **This is not a hypothetical game.** The option to be implemented for you will actually be carried out – exactly as described – on behalf of the *BonnEconLab*. As a proof you will receive the money in case you choose the additional monetary payment; in case you choose to save a human life we will allow inspection of the confirmed bank transfer to the organization *Operation ASHA* on request.

If you have individual questions, you can also direct these by email after the study to nachbesprechung@uni-bonn.de. You find this email address on the back of your seating card. You can take it home with you. Click on "Next", if you have carefully read the information on this page. Please note: You can only click on the button "Next" once you have spent at least 5 minutes on the seven tabs of this page.

[end of screen]

Information on the next part of this study

In the next part of this study, we will ask you to make a series of decisions in which you can choose between two monetary payments. The dates at which the two monetary payments are made can differ.

About this part of the study

This part of the study consists of 5 parts. In each part, you will make a decision in 5 different decision-making contexts. At the beginning of each part, you will receive information that is relevant for this part. At the beginning of each decision-making context, you will also receive additional information for this particular decision-making context.

Payments in this part of the study

All monetary payments in this part of the study will be made by bank transfer. Each bank transfer will be made at exactly the date that was indicated for the monetary payments. If, for example, a decision is about a monetary payment today, the corresponding monetary amount will be sent to you by a bank transfer today. If the decision involves a monetary payment in 1 month, a bank transfer with the corresponding amount will be made exactly one month from now.

In what follows, you will face a series of decision-making contexts. One of these decision-making contexts will be randomly selected by the computer at the end of this study. Your decision in *this* decision-making context will be implemented at the end of this study.

Remember:

- Every decision-making context can be relevant for your monetary payment.
- Your decisions in this part determine both **to whom** the monetary payment will go and **at which date** the monetary payment will be made.
- All monetary payments will be made by bank transfer.

[end of screen]

What does it mean that a donation will be made earlier or later?

If a donation is made earlier because of your decisions, help will be available earlier and hence people can be saved from death earlier.

If a donation is made later, for example only in 1 year from now, then help will only be available later and hence people can only be saved from death later. It is possible that this means that the donation will be too late to help some patients. In this case, patients who got sick at a later date will receive treatment instead.

The **size of the donation** is important because more people can be helped with more money.

When making the following decisions, you should therefore take into account **when** the donation will be made and **how much** will be donated based on your decisions.

[end of screen]

C.2 Experiment Part A

C.2.1 UD-S

Information for the current part

In the following, you will see a series of decision-making contexts in which you can choose between Option A and Option B.

- **Option A:** A **smaller** monetary payment **to you** at an **earlier** date.
- **Option B:** A **larger** monetary payment **to you** at a **later** date.

Thus, you can make a decision about a payment to yourself. You have the choice between a monetary payment that is smaller and made earlier; and a monetary payment that is larger but made later.

Please note:

- Each of the following decisions could be the one that is actually implemented.
- **All** monetary payments will be made by **bank transfer**.

[end of screen]

Information for the decision-making context on the next page

[Box that repeats the relevant information for the current part of the study]

On the next page, you will see a list of choice between

- **Option A:** A smaller monetary payment to you today.
- **Option B:** A larger monetary payment to you in 12 months.

You can thus decide whether you are willing to wait to receive a larger monetary payment.

[end of screen]

You can now make your decision

Please indicate in each row of this table whether you choose **Option A** or **Option B**.

Option A Option B

50.00 € for you today	<input type="radio"/>	50.00 € for you in 12 months
50.00 € for you today	<input type="radio"/>	52.50 € for you in 12 months
50.00 € for you today	<input type="radio"/>	55.00 € for you in 12 months
...	<input type="radio"/>	...
50.00 € for you today	<input type="radio"/>	120.00 € for you in 12 months
50.00 € for you today	<input type="radio"/>	122.50 € for you in 12 months
50.00 € for you today	<input type="radio"/>	125.00 € for you in 12 months

Automatic completion: We have activated a fill-in aid that automatically fills out the remaining rows so you don't have to click as much.

[end of screen]

C.2.2 UD-C

Information for the current part

In the following, you will see a series of decision-making contexts in which you can choose between Option A and Option B.

- **Option A:** A **smaller** monetary payment to *Operation ASHA* at an **earlier** date.
You are making a smaller contribution to saving lives and the contribution is made earlier.
- **Option B:** A **larger** monetary payment to *Operation ASHA* at a **later** date.
You are making a larger contribution to saving lives. However, the contribution is made later, so there is a delay.

Thus, you can choose whether you want to make a smaller donation at an earlier date to save fewer human lives, or whether you want to wait to make a larger donation at a later date to save more human lives.

Please note:

- Each of the following decisions could be the one that is actually implemented.
- All monetary payments will be made by **bank transfer**.

[end of screen]

Information for the decision-making context on the next page [Box that repeats the relevant information for the current part of the study]

On the next page, you will see a list of choice between

- **Option A:** A smaller monetary payment to *Operation ASHA* today.
- **Option B:** A larger monetary payment to *Operation ASHA* in 12 months.

100 % of the donation amount will be used to save human lives.

You can thus decide whether you prefer to save fewer human lives at an earlier date in the immediate future, or whether you want to help save more human lives in the future, but with a greater delay.

[end of screen]

You can now make your decision

Please indicate in each row of this table whether you choose **Option A** or **Option B**.

Option A	Option B
50.00 € for Operation ASHA today <input type="radio"/>	<input type="radio"/> 50.00 € for Operation ASHA in 12 months
50.00 € for Operation ASHA today <input type="radio"/>	<input type="radio"/> 52.50 € for Operation ASHA in 12 months
50.00 € for Operation ASHA today <input type="radio"/>	<input type="radio"/> 55.00 € for Operation ASHA in 12 months
... <input type="radio"/>	<input type="radio"/> ...
50.00 € for Operation ASHA today <input type="radio"/>	<input type="radio"/> 120.00 € for Operation ASHA in 12 months
50.00 € for Operation ASHA today <input type="radio"/>	<input type="radio"/> 122.50 € for Operation ASHA in 12 months
50.00 € for Operation ASHA today <input type="radio"/>	<input type="radio"/> 125.00 € for Operation ASHA in 12 months

Automatic completion: We have activated a fill-in aid that automatically fills out the remaining rows so you don't have to click as much.

[end of screen]

C.2.3 ER

Information for the current part

In the following, you will see a series of decision-making contexts in which you can choose between Option A and Option B.

- **Option A:** Monetary payment **to you** at a **given** date.
- **Option B:** Monetary payment **to Operation ASHA** at the **same** date.

You are making a contribution to saving human lives at the same date at which you would have received your monetary payment if you had chosen **Option A**.

Thus, you can choose whether you prefer a monetary payment to yourself at a given date, or whether you prefer to make a donation to help save human lives at the same date.

Please note:

- Each of the following decisions could be the one that is actually implemented.
- **All** monetary payments will be made by **bank transfer**.

[end of screen]

Information for the decision-making context on the next page [Box that repeats the relevant information for the current part of the study]

On the next page, you will see a list of choice between

- **Option A:** A monetary payment to *you* in 12 months.
- **Option B:** A monetary payment to *Operation ASHA* in 12 months.

100 % of the donation amount will be used to save human lives.

You can thus decide whether you are willing to forego a monetary payment to yourself in 12 months in order to save human lives.

[end of screen]

You can now make your decision

Please indicate in each row of this table whether you choose **Option A** or **Option B**.

Option A Option B

50.00 € for you in 12 months	◦	◦	0.00 € for Operation ASHA in 12 months
50.00 € for you in 12 months	◦	◦	10.00 € for Operation ASHA in 12 months
50.00 € for you in 12 months	◦	◦	20.00 € for Operation ASHA in 12 months
...	◦	◦	...
50.00 € for you in 12 months	◦	◦	180.00 € for Operation ASHA in 12 months
50.00 € for you in 12 months	◦	◦	190.00 € for Operation ASHA in 12 months
50.00 € for you in 12 months	◦	◦	200.00 € for Operation ASHA in 12 months

Automatic completion: We have activated a fill-in aid that automatically fills out the remaining rows so you don't have to click as much.

[end of screen]

C.2.4 MD-S

Information for the current part

In the following, you will see a series of decision-making contexts in which you can choose between Option A and Option B.

- **Option A:** A monetary payment to **you** at an **earlier** date.
- **Option B:** A monetary payment to **Operation ASHA** at a **later** date.

You are making a contribution to saving lives. However, the contribution is made later, so there is a delay.

Thus, you can choose whether you prefer a monetary payment to yourself at an earlier date, or whether you prefer to wait to make a larger donation to help save human lives at a later date.

Please note:

- Each of the following decisions could be the one that is actually implemented.
- **All** monetary payments will be made by **bank transfer**.

[end of screen]

Information for the decision-making context on the next page

[Box that repeats the relevant information for the current part of the study]

On the next page, you will see a list of choice between

- **Option A:** A monetary payment to *you* today.
- **Option B:** A monetary payment to *Operation ASHA* in 12 months.

100 % of the donation amount will be used to save human lives.

You can thus decide whether you are willing to forego a monetary payment to yourself at an earlier date to save human lives at a later date.

[end of screen]

You can now make your decision

Please indicate in each row of this table whether you choose **Option A** or **Option B**.

Option A	Option B
50.00 € for you today	0.00 € for Operation ASHA in 12 months
50.00 € for you today	15.00 € for Operation ASHA in 12 months
50.00 € for you today	30.00 € for Operation ASHA in 12 months
...	...
50.00 € for you today	345.00 € for Operation ASHA in 12 months
50.00 € for you today	360.00 € for Operation ASHA in 12 months
50.00 € for you today	375.00 € for Operation ASHA in 12 months

Automatic completion: We have activated a fill-in aid that automatically fills out the remaining rows so you don't have to click as much.

[end of screen]

C.2.5 MD-C

Information for the current part

In the following, you will see a series of decision-making contexts in which you can choose between Option A and Option B.

- **Option A:** A monetary payment to **Operation ASHA** at an **earlier** date.
You are making a contribution to saving lives at an earlier date.
- **Option B:** A monetary payment to **you** at a **later** date.

Thus, you can choose whether you prefer a donation to help save human lives at an earlier date, or whether you prefer to wait to receive a monetary payment to yourself at a later date.

Please note:

- Each of the following decisions could be the one that is actually implemented.
- **All** monetary payments will be made by **bank transfer**.

[end of screen]

Information for the decision-making context on the next page

[Box that repeats the relevant information for the current part of the study]

On the next page, you will see a list of choice between

- **Option A:** A monetary payment to *Operation ASHA* today.
- **Option B:** A monetary payment to *you* in 12 months.

100 % of the donation amount will be used to save human lives.

You can thus decide whether you are willing to forego saving human lives at an earlier date to receive a monetary payment at a later date.

[end of screen]

You can now make your decision

Please indicate in each row of this table whether you choose **Option A** or **Option B**.

Option A Option B

50.00 € for Operation ASHA today	○	○	0.00 € for you in 12 months
50.00 € for Operation ASHA today	○	○	5.00 € for you in 12 months
50.00 € for Operation ASHA today	○	○	10.00 € for you in 12 months
...	○	○	...
50.00 € for Operation ASHA today	○	○	115.00 € for you in 12 months
50.00 € for Operation ASHA today	○	○	120.00 € for you in 12 months
50.00 € for Operation ASHA today	○	○	125.00 € for you in 12 months

Automatic completion: We have activated a fill-in aid that automatically fills out the remaining rows so you don't have to click as much.

[end of screen]

C.3 Experiment Part B

Task description

In the following part of the study, we ask you make a series of decisions involving a choice between two lotteries, **Lottery A** and **Lottery B**. Both lotteries will be determined by a fair coin toss. That means that there is a 50 % chance that it lands on heads, and a 50 % chance that it lands on tails.

Before each lottery choice, you will receive information about the initial endowment in this decision. This initial endowment consists of two parts:

- A monetary payment **for you**
- A monetary payment **for Operation ASHA**. 100 % of this amount will be used to save human lives.

After you have received information about the initial endowment, you can make your choice between **Lottery A** and **Lottery B**.

Please note:

- The lotteries will change the monetary payments to you and/or the organization. You will learn exactly how the initial endowments will change if, for example, you choose Lottery A and the coin toss lands on heads.
- **Thus, how the monetary payments to you and the organization change depends both on which lottery you choose and the result of the coin toss.** The coin toss will be carried out by the computer.

Payments in this part of the study

All monetary payments in this part of the study will be made by bank transfer. In the following decision-making situations, monetary payments are made either to you or to the organization *Operation ASHA*. If you are the receiver, a bank transfer to your account will be made today. If *Operation ASHA* is the receiver of the monetary payment, a bank transfer to the organization's account will be made today. 100 % of the amount that is transferred to the organization's account will be used to save people from death by tuberculosis, as described previously.

In what follows, you will face a series of decision-making situations. One of these decision-making situations will be randomly selected by the computer at the end of this study. Your decision in *this* decision-making context will be implemented by a bank transfer

at the end of this study. Your decisions in this part of the study thus determine *which* lottery is played at the end of this study.

Remember:

- Every decision-making context can be relevant for your monetary payment.
- Your decisions in this part determine both **to whom** the monetary payment will go and **at which date** the monetary payment will be made.
- All monetary payments will be made by bank transfer.

[end of screen]

Example

In the following decision-making situations, you can choose between **Lottery A** and **Lottery B**. On this page, we use an example to illustrate the choice between both lotteries.

In the following decision-making situations, you will see a page that looks like this:

Ihre **Ausgangsausstattung** für die folgende Entscheidung:

- 100,00 € als Auszahlung an Sie, und
- 0,00 € als Spendenauszahlung an die Organisation Operation ASHA.

Zusätzlich müssen Sie sich nun zwischen **Lotterie A** und **Lotterie B** entscheiden.

Jede der beiden Lotterien wird durch einen Münzwurf entschieden, sodass mit 50% Wahrscheinlichkeit **Kopf** ausgewählt wird, und mit 50% Wahrscheinlichkeit **Zahl**.

Lotterie A		Lotterie B					
Wenn Kopf geworfen wird:	40,00 € weniger Auszahlung an Sie	Wenn Kopf geworfen wird:	40,00 € weniger Auszahlung an Sie	UND	20,00 € weniger Auszahlung an Sie	UND	X € zusätzliche Auszahlung an Sie
Wenn Zahl geworfen wird:	20,00 € weniger Auszahlung an Sie	Wenn Zahl geworfen wird:					X € zusätzliche Auszahlung an Sie

On such a page, you will see information about the initial endowment, and how these endowments change depending on which lottery you choose and what the result of the coin toss is.

In the picture below, we explain the elements of this page in more detail:

Ihre **Ausgangsausstattung**

Ihre **Ausgangsausstattung** für die folgende Entscheidung:

- 100,00 € als Auszahlung an Sie, und
- 0,00 € als Spendenauszahlung an die Organisation Operation ASHA.

Zusätzlich müssen Sie sich nun zwischen **Lotterie A** und **Lotterie B** entscheiden.

Jede der beiden Lotterien wird durch einen Münzwurf entschieden, sodass mit 50% Wahrscheinlichkeit **Kopf** ausgewählt wird, und mit 50% Wahrscheinlichkeit **Zahl**.

Lotterie A		Lotterie B					
Wenn Kopf geworfen wird:	40,00 € weniger Auszahlung an Sie	Wenn Kopf geworfen wird:	40,00 € weniger Auszahlung an Sie	UND	20,00 € weniger Auszahlung an Sie	UND	X € zusätzliche Auszahlung an Sie
Wenn Zahl geworfen wird:	20,00 € weniger Auszahlung an Sie	Wenn Zahl geworfen wird:					X € zusätzliche Auszahlung an Sie

Wenn Sie **Lotterie A** wählen, und **Zahl** geworfen wird, beträgt die Auszahlung an Sie:
 $100€ - 20€ = 80€$

Wenn Sie **Lotterie B** wählen, und **Kopf** geworfen wird, beträgt die Auszahlung an Sie:
 $100€ - 40€ - 20€ + X€ = 40€ + X€$

Wenn Sie **Lotterie B** wählen, und **Zahl** geworfen wird, beträgt die Auszahlung an Sie:
 $100€ + X€$

In each decision-making situation where you have to choose between **Lottery A** and **Lottery B**, we will show you an amount $X \text{ €}$. The picture below illustrates how your decision would look like if $X = 10.00 \text{ €}$. By selecting the left or right circle, you can choose between **Lottery A** and **Lottery B**.

Lotterie A		Lotterie B				
Wenn Kopf geworfen wird:	40,00 € weniger Auszahlung an Sie	40,00 € weniger Auszahlung an Sie	UND	20,00 € weniger Auszahlung an Sie	UND	X € zusätzliche Auszahlung an Sie
Wenn Zahl geworfen wird:	20,00 € weniger Auszahlung an Sie					X € zusätzliche Auszahlung an Sie
<input type="radio"/> Lotterie A		<input checked="" type="radio"/> Lotterie B mit X = 10,00 €				

To proceed click "Next".

[end of screen]

Exercise 1

On this and the following page, you can check whether you have correctly understood all the necessary information for this part of the study. For the first exercise, take a look at the following initial endowment:

The initial endowment for the following situation:

- 25.00 € for you, and
- a donation of 25.00 € to the organization Operation ASHA.

In addition, you also have to choose between **Lottery A** and **Lottery B**.

Imagine that, given the initial endowments above, you had to make a decision between the following two lotteries:

Lotterie A		Lotterie B					
Wenn Kopf geworfen wird:	10,00 € weniger Spendenzahlung	Wenn Kopf geworfen wird:	10,00 € weniger Spendenzahlung	UND	10,00 € weniger Auszahlung an Sie	UND	X € zusätzliche Auszahlung an Sie
Wenn Zahl geworfen wird:	10,00 € weniger Auszahlung an Sie	Wenn Zahl geworfen wird:					X € zusätzliche Auszahlung an Sie
Lotterie A <input type="radio"/>		Lotterie B mit X = 2,00 € <input checked="" type="radio"/>					

- Lottery A:
 - If the coin toss is heads: 10.00 € smaller donation.
 - If the coin toss is tails: 10.00 € smaller monetary payment to you.
- Lottery B:
 - If the coin toss is heads: 10.00 € smaller donation AND 10.00 € smaller monetary payment to you AND an additional X € for you
 - If the coin toss is tails: an additional X € for you
 - $X = 2.00 \text{ €}$

To test whether you have understood how your choice between Lottery A and Lottery B as well as the outcome of the coin toss affects the monetary payments, please provide answers to the following questions:

- If I choose **Lottery A** and the coin toss is *heads*, the monetary amount that I will receive, including the initial endowment, is (in €): [blank field]

- If I choose **Lottery B** and the coin toss is *heads*, the monetary amount that I will receive, including the initial endowment, is (in €): [blank field]
- If I choose **Lottery B** and the coin toss is *heads*, the size of the donation, including the initial endowment, is (in €): [blank field]
- If I choose **Lottery B** and the coin toss is *tails*, the monetary amount that I will receive, including the initial endowment, is (in €): [blank field]

[end of screen]

Exercise 2

For the first exercise, take a look at the following initial endowment:

The initial endowment for the following situation:

- 40.00 € for you, and
- a donation of 0.00 € to the organization Operation ASHA.

In addition, you also have to choose between **Lottery A** and **Lottery B**.

Some decisions involve a so-called **additional lottery**. Every additional lottery has a possible positive outcome (the monetary payment increases) and a possible negative outcome (the monetary payment decreases). The outcome of the **additional lottery** will also be randomly determined by the computer.

Note: Pay attention to the probabilities in the **additional lottery**.

Imagine that, given the initial endowments above, you had to make a decision between the following two lotteries:

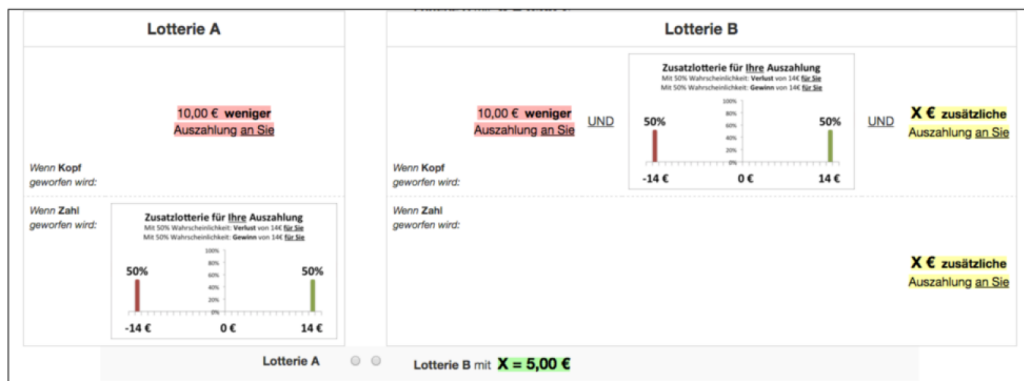

- Lottery A:
 - If the coin toss is heads: 10.00 € smaller donation.
 - If the coin toss is tails: Additional lottery for **your** monetary payment.
 - * With a probability of 50%: You lose 14 €.
 - * With a probability of 50%: You win 14 €.
- Lottery B:
 - If the coin toss is heads: 10.00 € smaller donation AND an additional X € for you AND an additional lottery for **your** monetary payment:
 - * With a probability of 50%: You lose 14 €.

- * With a probability of 50%: You win 14 €.
- If the coin toss is tails: an additional X € for you
- $X = 5.00$ €

The additional lottery thus has a possible negative outcome of -14.00 € and a possible positive outcome of +14.00 €. Both outcomes are equally likely, that is, they both have a probability of 50 %.

To test whether you have understood how your choice between Lottery A and Lottery B as well as the outcome of the coin toss affects the monetary payments, please provide answers to the following questions:

- If I choose **Lottery A**, the coin toss is tails, and the outcome of the additional lottery is +14 €, I will receive a monetary payment, including the initial endowment, of: [blank field] (in €)
- If I choose **Lottery B**, the coin toss is heads, and the outcome of the additional lottery is -14 €, I will receive a monetary payment, including the initial endowment, of: [blank field] (in €)

[end of screen]

Your task begins on the next page

On the next page you will see the first decision-making situation. From now on, the decisions you make are longer an exercise. That means that any of your following decisions could be implemented with all its consequences.

Remember:

- Every decision-making context can be relevant for your monetary payment.
- Your decisions in this part determine both **to whom** the monetary payment will go and **at which date** the monetary payment will be made.
- All monetary payments will be made by bank transfer.

To proceed click "Next".

C.3.1 RA-Self

The initial endowment for this decision is:

- 25.00 € for you, and
- a donation of 0.00 € to the organization Operation ASHA.

In addition, you also have to choose between **Lottery A** and **Lottery B**.

Both lotteries will be decided by a coin toss, which means that there is a 50 % chance of heads and a 50 % chance of tails.

[Description of the lotteries]

On the next page you will see a list where each row represents a different decision-making situation between Lottery A and Lottery B. Each row indicates the value of **X** in that particular decision-making situation. To proceed click "Next".

[end of screen]

Decision

The initial endowment for this decision is:

- 25.00 € for you, and
- a donation of 0.00 € to the organization Operation ASHA.

In addition, you also have to choose between **Lottery A** and **Lottery B**.

[Description of the lotteries]

Note: X € will be paid to you whenever you choose **Lottery B**, independently of whether the coin toss is heads or tails. Whether X is positive (a gain) or negative (a loss) depends on the decision-making situation.

Lottery A **Lottery B** with $X = -5.00$ €

Lottery A **Lottery B** with $X = -4.50$ €

Lottery A **Lottery B** with $X = -4.00$ €

... ...

Lottery A **Lottery B** with $X = 4.00$ €

Lottery A **Lottery B** with $X = 4.50$ €

Lottery A **Lottery B** with $X = 5.00$ €

Automatic completion: We have activated a fill-in aid that automatically fills out the remaining rows so you don't have to click as much.

[end of screen]

C.3.2 RA-Charity

The initial endowment for this decision is:

- 0.00 € for you, and
- a donation of 25.00 € to the organization Operation ASHA.

In addition, you also have to choose between **Lottery A** and **Lottery B**.

Both lotteries will be decided by a coin toss, which means that there is a 50 % chance of heads and a 50 % chance of tails.

[Description of the lotteries]

On the next page you will see a list where each row represents a different decision-making situation between Lottery A and Lottery B. Each row indicates the value of **X** in that particular decision-making situation. To proceed click "Next".

[end of screen]

Decision

The initial endowment for this decision is:

- 0.00 € for you, and
- a donation of 25.00 € to the organization Operation ASHA.

In addition, you also have to choose between **Lottery A** and **Lottery B**.

[Description of the lotteries]

Note: **X**€ will be paid to you whenever you choose **Lottery B**, independently of whether the coin toss is heads or tails. Whether **X** is positive (a gain) or negative (a loss) depends on the decision-making situation.

- Lottery A Lottery B with X = -5.00 €
- Lottery A Lottery B with X = -4.50 €
- Lottery A Lottery B with X = -4.00 €
-
- Lottery A Lottery B with X = 4.00 €
- Lottery A Lottery B with X = 4.50 €
- Lottery A Lottery B with X = 5.00 €

Automatic completion: We have activated a fill-in aid that automatically fills out the remaining rows so you don't have to click as much.

[end of screen]

C.3.3 X-RA

The initial endowment for this decision is:

- 25.00 € for you, and
- a donation of 25.00 € to the organization Operation ASHA.

In addition, you also have to choose between **Lottery A** and **Lottery B**.

Both lotteries will be decided by a coin toss, which means that there is a 50 % chance of heads and a 50 % chance of tails.

[Description of the lotteries]

On the next page you will see a list where each row represents a different decision-making situation between Lottery A and Lottery B. Each row indicates the value of **X** in that particular decision-making situation. To proceed click "Next".

[end of screen]

Decision

The initial endowment for this decision is:

- 25.00 € for you, and
- a donation of 25.00 € to the organization Operation ASHA.

In addition, you also have to choose between **Lottery A** and **Lottery B**.

[Description of the lotteries]

Note: **X**€ will be paid to you whenever you choose **Lottery B**, independently of whether the coin toss is heads or tails. Whether **X** is positive (a gain) or negative (a loss) depends on the decision-making situation.

- Lottery A Lottery B with X = -5.00 €
- Lottery A Lottery B with X = -4.50 €
- Lottery A Lottery B with X = -4.00 €
-
- Lottery A Lottery B with X = 4.00 €
- Lottery A Lottery B with X = 4.50 €
- Lottery A Lottery B with X = 5.00 €

Automatic completion: We have activated a fill-in aid that automatically fills out the remaining rows so you don't have to click as much.

[end of screen]

C.3.4 PR–Self

The initial endowment for this decision is:

- 40.00 € for you, and
- a donation of 0.00 € to the organization Operation ASHA.

In addition, you also have to choose between **Lottery A** and **Lottery B**.

Both lotteries will be decided by a coin toss, which means that there is a 50 % chance of heads and a 50 % chance of tails.

[Description of the lotteries]

This decision entails the possibility of an **additional lottery**. For example, if you choose Lottery A and the coin toss is tails, the additional lottery will be played. The outcome of the additional lottery will be determined by the computer.

On the next page you will see a list where each row represents a different decision-making situation between Lottery A and Lottery B. Each row indicates the value of **X** in that particular decision-making situation. To proceed click "Next".

[end of screen]

Decision

The initial endowment for this decision is:

- 40.00 € for you, and
- a donation of 0.00 € to the organization Operation ASHA.

In addition, you also have to choose between **Lottery A** and **Lottery B**.

[Description of the lotteries]

Note: **X**€ will be paid to you whenever you choose **Lottery B**, independently of whether the coin toss is heads or tails. Whether **X** is positive (a gain) or negative (a loss) depends on the decision-making situation.

Lottery A Lottery B with X = -5.00 €
Lottery A Lottery B with X = -4.50 €
Lottery A Lottery B with X = -4.00 €
... ...
Lottery A Lottery B with X = 4.00 €
Lottery A Lottery B with X = 4.50 €
Lottery A Lottery B with X = 5.00 €

Automatic completion: We have activated a fill-in aid that automatically fills out the remaining rows so you don't have to click as much.

[end of screen]

C.3.5 PR–Charity

The initial endowment for this decision is:

- 0.00 € for you, and
- a donation of 40.00 € to the organization Operation ASHA.

In addition, you also have to choose between **Lottery A** and **Lottery B**.

Both lotteries will be decided by a coin toss, which means that there is a 50 % chance of heads and a 50 % chance of tails.

[Description of the lotteries]

This decision entails the possibility of an **additional lottery**. For example, if you choose Lottery A and the coin toss is tails, the additional lottery will be played. The outcome of the additional lottery will be determined by the computer.

On the next page you will see a list where each row represents a different decision-making situation between Lottery A and Lottery B. Each row indicates the value of **X** in that particular decision-making situation. To proceed click "Next".

[end of screen]

Decision

The initial endowment for this decision is:

- 0.00 € for you, and
- a donation of 40.00 € to the organization Operation ASHA.

In addition, you also have to choose between **Lottery A** and **Lottery B**.

[Description of the lotteries]

Note: **X**€ will be paid to you whenever you choose **Lottery B**, independently of whether the coin toss is heads or tails. Whether **X** is positive (a gain) or negative (a loss) depends on the decision-making situation.

Lottery A Lottery B with X = -5.00 €
Lottery A Lottery B with X = -4.50 €
Lottery A Lottery B with X = -4.00 €
... ...
Lottery A Lottery B with X = 4.00 €
Lottery A Lottery B with X = 4.50 €
Lottery A Lottery B with X = 5.00 €

Automatic completion: We have activated a fill-in aid that automatically fills out the remaining rows so you don't have to click as much.

[end of screen]