

Cameretti, Maria Cristina

Article

Modelling of a Hybrid Solar Micro-Gas Turbine fuelled by biomass from agriculture product

Energy Reports

Provided in Cooperation with:

Elsevier

Suggested Citation: Cameretti, Maria Cristina (2020) : Modelling of a Hybrid Solar Micro-Gas Turbine fuelled by biomass from agriculture product, Energy Reports, ISSN 2352-4847, Elsevier, Amsterdam, Vol. 6, Iss. 3, pp. 105-116,
<https://doi.org/10.1016/j.egy.2019.10.026>

This Version is available at:

<https://hdl.handle.net/10419/243984>

Standard-Nutzungsbedingungen:

Die Dokumente auf EconStor dürfen zu eigenen wissenschaftlichen Zwecken und zum Privatgebrauch gespeichert und kopiert werden.

Sie dürfen die Dokumente nicht für öffentliche oder kommerzielle Zwecke vervielfältigen, öffentlich ausstellen, öffentlich zugänglich machen, vertreiben oder anderweitig nutzen.

Sofern die Verfasser die Dokumente unter Open-Content-Lizenzen (insbesondere CC-Lizenzen) zur Verfügung gestellt haben sollten, gelten abweichend von diesen Nutzungsbedingungen die in der dort genannten Lizenz gewährten Nutzungsrechte.

Terms of use:

Documents in EconStor may be saved and copied for your personal and scholarly purposes.

You are not to copy documents for public or commercial purposes, to exhibit the documents publicly, to make them publicly available on the internet, or to distribute or otherwise use the documents in public.

If the documents have been made available under an Open Content Licence (especially Creative Commons Licences), you may exercise further usage rights as specified in the indicated licence.



<https://creativecommons.org/licenses/by-nc-nd/4.0/>

Tmrees, EURACA, 04 to 06 September 2019, Athens, Greece

Modelling of a Hybrid Solar Micro-Gas Turbine fuelled by biomass from agriculture product

Maria Cristina Cameretti

Department of Industrial Engineering - University of Naples Federico II, Via Claudio21, Naples, Italy

Received 19 September 2019; accepted 25 October 2019

Available online 14 November 2019

Abstract

Sustainable biomass exploitation for combined heat and power (CHP) generation is fundamental to address concerns about climate changes related to energy conversion systems. The aim of the work is to design a power plant able to satisfy energy demands exclusively through renewable resources. A layout of a hybrid micro-gas turbine–solar plant fed by biomass from agriculture products (olive pits) is modelled. It provides the coupling between a gasifier, dedicated to the biomass conversion and a micro gas turbine, optimized for the operation with syngas. In particular, the MGT plant is integrated with a solar tower field, able to provide a partial or complete fuel heating replacement depending on the amount of solar heat provided to the working fluid reaching the turbine inlet temperature. After the solar field design able to reduce fuel consumption during diurnal hours, a gasifier was integrated to obtain a syngas from biomass in place of the traditional natural gas. A parametric analysis aimed to define the gasifier parameters is reported and allowed to obtain a syngas able to satisfy the power demands of the MGT with good performances. The *Thermoflex*[®] commercial software is used to model the full plant. The results in terms of efficiency and environmental impact are reported and compared to those obtained with the traditional natural gas-fuelled MGT. © 2019 Published by Elsevier Ltd. This is an open access article under the CC BY-NC-ND license (<http://creativecommons.org/licenses/by-nc-nd/4.0/>).

Peer-review under responsibility of the scientific committee of the Tmrees, EURACA, 2019.

Keywords: Biomass; Gasification; Micro gas turbine; Solar energy; Syngas

1. Introduction

The present paper focuses the attention on the respect of the principles concerning the improvement of the energy efficiency, the reduction of the greenhouse gas emissions and the dependence upon traditional energy sources, by considering the possibility of biomasses exploitation as renewable energy sources possibly combining it with solar energy [1]. Sustainable biomass exploitation for combined heat and power (CHP) generation is fundamental to address concerns about climate changes induced by energy conversion processes, hence to contribute to the so-called resilient economy [2]. After all, countries in the Mediterranean area have the potential to be major contributors of renewable energy in the world through the use of biomass.

A layout of a hybrid micro-cogeneration plant with solar tower fed by biomass from Agriculture product (olive pits) is modelled. It provides the coupling between a gasifier, dedicated to the biomass conversion and a micro

E-mail address: mc.cameretti@unina.it.

<https://doi.org/10.1016/j.egy.2019.10.026>

2352-4847/© 2019 Published by Elsevier Ltd. This is an open access article under the CC BY-NC-ND license (<http://creativecommons.org/licenses/by-nc-nd/4.0/>).

Peer-review under responsibility of the scientific committee of the Tmrees, EURACA, 2019.

Nomenclature

CHP	Combined Heat and Power
CSP	Concentrated Solar Power
ER	Equivalent Ratio
\dot{m}	Mass Flow Rate
MGT	Micro Gas Turbine
NG	Natural Gas
P	Power
RISP	Energy Saving in the Italian legislation
ST	Solar Tower
TIT	Turbine Inlet Temperature
1	Compressor inlet
2	Compressor outlet
2r	Recuperator outlet (cold side)
2s	Sola field outlet
3	Combustor outlet
4	Turbine outlet
4r	Recuperator outlet (hot side)
α	Air/fuel ratio

gas turbine, optimized for the operation with syngas. Micro gas turbines (MGTs) represent an efficient, widely diffused solution both for smart-generation systems and integration with renewable energy sources. The operational flexibility offered by gas turbines makes natural the coupling to a variable energy source, such as solar thermal energy, and then eases the integration of the MGT plant to the solar tower field. Such layout allows to partially meet the heat addition requirement or totally replace the fuel in the case that the only solar heat input is enough to ensure that the working fluid reaches the TIT [3,4]. Among the various CSP technologies [5], over the last ten years, solar tower technology has gained considerable development. In a solar tower system, the power collected from the elliptical field is strictly dependent on the height of the tower and its position with respect to the field. The presence of the tower allows fuel saving during the diurnal hours while the system can operate in a pure combustion mode during night hours. In a previous work [6], the author considered a hybrid plant MGT/solar tower performing an economic-thermodynamic analysis to design the solar field. Numerical results are compared with the data available from standard micro gas turbine plant.

An attractive renewable energy to comply with the problems such as fossil fuel depletion and environmental pollution is the biomass resource. Biomass gasification directly produces a syngas that replaces fossil fuel, mainly through thermochemical conversion of biomass waste [7]. To convert biomass into gaseous fuels there are essentially three thermochemical methods: gasification, pyrolysis and combustion. Many authors [8–16] are considering and applying the gasification that presents many advantages especially if the power plant is integrated with a solar energy system [17]. A state of the art of the fluidization technology for the biomass gasification is reviewed in [18], where different gasifier types, technologies and influence of process parameters on the syngas are discussed. Through gasification it is possible to produce a syngas for heat or electricity production in engines with low emissions compared to the traditional combustion. Moreover, it is possible to obtain a fuel with a high amount of hydrogen in addition to components such as CO, CO₂ and CH₄. The gasification can produce a better fuel (syngas with higher LHV) if pure oxygen is exploited [8]. Many authors investigated the bio-hydrogen production via biomass air gasification focusing on agricultural wastes and olive kernels by bubbling fluidized bed gasifier [19,20]. The gasification process at higher temperatures reported higher carbon conversion and gas yield, despite decreasing the LHV of the gas when increasing the air flow rates [21,22].

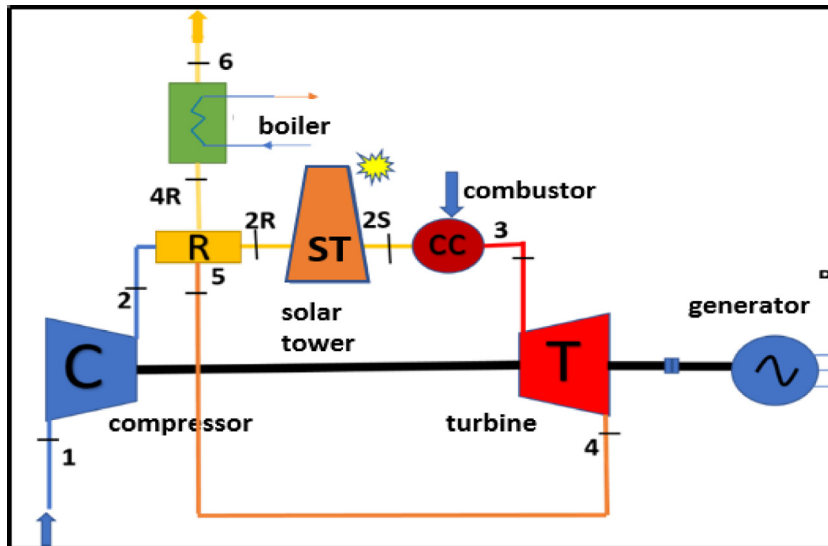

Fig. 1. Layout of MGT power plant with the solar tower integration.

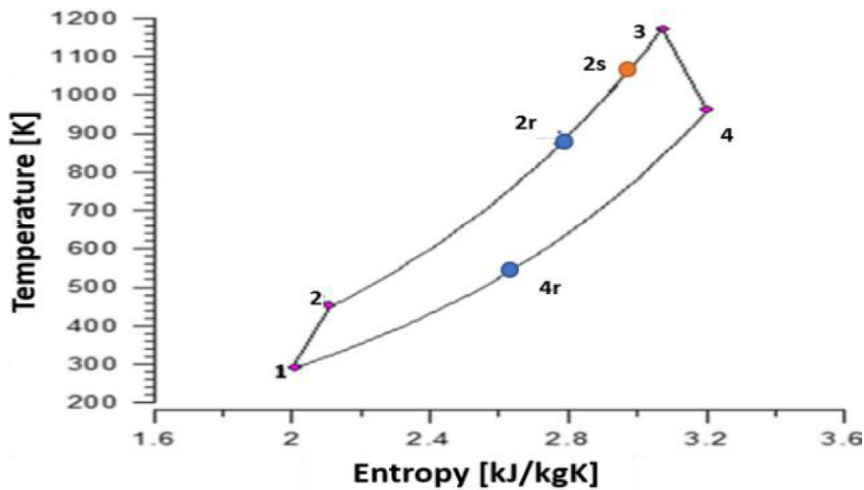

Fig. 2. MGT thermal cycle.

2. Hybrid cogenerative plant with CSP–MGT integration

In this section, the CHP plant, object of the research, is described and an energy balance performed. The plant is designed to produce electric power and hot-water by using a cogenerative micro gas turbine (MGT). The micro gas turbine plant in Fig. 1 shows also the presence of a solar tower (ST) along the air flow path after the recuperator (R), and in Fig. 2 the thermal cycle is reported. In this way, higher temperature levels of the air entering combustor were obtained, reducing fuel consumption. The system can operate in a pure combustion mode when solar irradiance is weak or completely absent such as during the winter or night, respectively. The analysis is based on the simulation of the overall plant by the *Thermoflex* software able to realize a model with several components. The power unit is a 30 kW Capstone micro gas turbine and Table 1 shows its datasheet. In previous papers [3,4,6] the authors demonstrated that the plant response is directly affected by the daily and yearly variations in solar irradiance and temperature. In particular, in [6] a thermo-economic analysis has been made in order to choose and size appropriately the solar system considering both the environmental impact and the overall cost. At present, a new design of the solar plant has been realized and several calculations have been performed to simulate the hybrid MGT–solar plant by varying

Table 1. C30 micro gas turbine datasheet.

MGT characteristics	
Recuperator Efficiency	0.877
Electric efficiency	26 (± 2)%
Pressure Ratio	3.45
Turbine inlet temperature (K)	1173
Net Power output	28 kW(+/-1)
Exhaust Mass flow (kg/s)	0.3
Speed (rpm)	96000
Exhaust gas temperature (K)	548
Compressor polytropic efficiency	0.78
Turbine polytropic efficiency	0.80

Table 2. Solar design parameters.

Solar field characteristics	Value	Unit
Heliostats number	5	–
Field surface	237.2	m ²
Solar tower Thermal power	104.3	kW

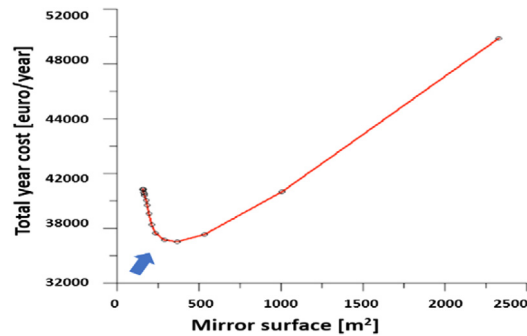
**Fig. 3.** Total year cost vs solar field surface.

the operating conditions with the aim to identify the optimum sizing of the solar system that reduces the overall annual costs. The calculations were referred to a year (2016) and latitude (Naples, Italy), by changing the surface area of the mirrors, in the diurnal hours and considering the ambient temperature variation. The target was to obtain an air outlet temperature (T_{2s}) equal to TIT (1173K) to save fuel during the solar hours. The design condition was identified with the minimum point of the total cost function versus mirror surface, as shown in Fig. 3, obtained by the annual consumption of natural gas (NG) fuel and plant costs. The solar design parameters are summarized in Table 2. In Table 3 the results are summarized in terms of annual costs, power and year average CO₂ emissions. The latter result shows that during solar hours the emissions are considerably reduced compared to the night value when the tower does not work. As a matter of fact, comparing the two plants with (Table 3) and without solar field (Table 4), a 67% reduction of CO₂ in the daily hours through the solar tower system is observed. In Fig. 4, the carbon dioxide emissions during a year are represented: as expected, the daily amount varies from month to month, due to the solar irradiance change and, as a consequence, to the different specific fuel. The electric power (Fig. 5) available in diurnal hours is 25.9 kW (Table 3), so lower than the one obtained by the nominal MGT fuelled only by natural gas (Table 4), due to flow losses through solar tower. The efficiency calculated by Eq. (1) decreases during diurnal hours when solar tower works and its average value is of 23.7% versus the 25.2% during the night hours.

$$\eta = \frac{Net\ Power}{Solar\ Heat + Fuel\ Heat} \quad (1)$$

Table 3. Hybrid MGT+Solar plant results.

Results	Value	Unit
Year fuel cost	31023	€/year
Total year cost	35655	€/year
Specific year cost	0.15	€/kWh
Average diurnal electric power	25.9	kW
Average night electric power	29.9	kW
Average electric power	27.9	kW
Average diurnal CO ₂ emissions	0.386	kg/kWh
Night CO ₂ emissions	0.813	kg/kWh
RISP	615.40	MWh

Table 4. MGT without solar Tower results.

Results	Value	Unit
Total year cost (fuel cost)	21104	€/year
Specific year cost	0.079	€/kWh
Average electric power	28.0	kW
Average CO ₂ emissions	0.849	kg/kWh
RISP	96.74	MWh

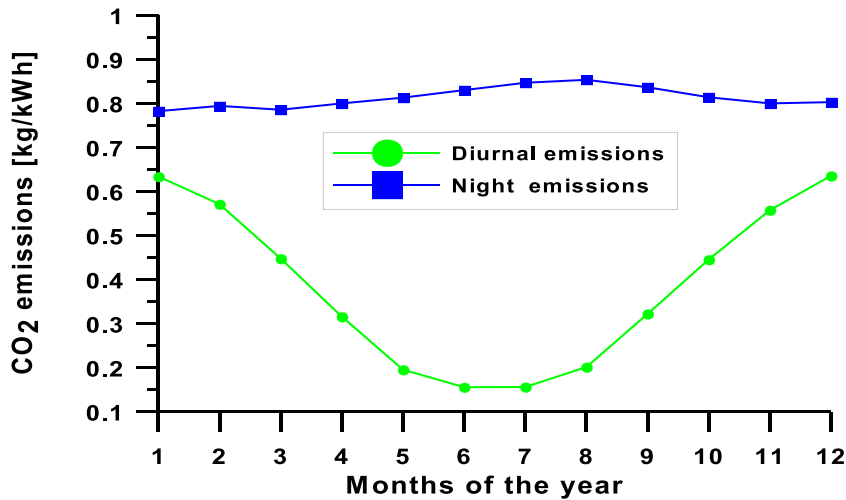
**Fig. 4.** CO₂ emissions trend in a year.

Finally, the energy saving (named RISP, Eq. (2)), the primary energy saving achieved by the cogeneration unit, is reported in the same Table 3 and it is equal to 615MWh.

$$RISP = \frac{E_{CHP}}{\eta_{eREF}} + \frac{H_{CHP}}{\eta_{thREF}} - F_{CHP} \quad (2)$$

Where: E_{CHP} is the electricity produced by the cogeneration unit [MWh]; H_{CHP} is the useful thermal energy, produced by the cogeneration unit [MWh]; η_{eREF} is the conventional electric efficiency; η_{thREF} is the conventional thermal efficiency; F_{CHP} is the fuel energy used by the cogeneration unit [MWh].

3. Hybrid MGT–solar plant with gasifier

In a second step of the work, a gasifier was introduced in the hybrid CHP plant to produce a syngas by olive pits to feed the plant in the night hours or when the solar irradiance is not enough to supply the desired thermal power, replacing natural gas fuel. A thermodynamic analysis was made to design a power system which produces

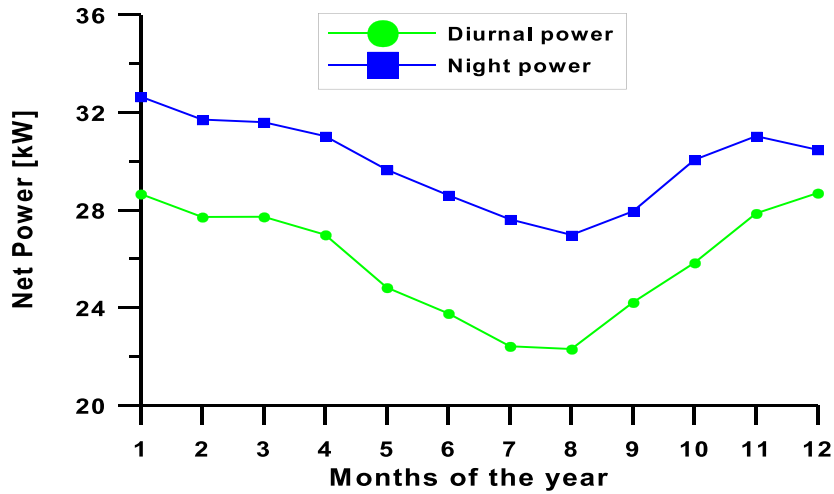

Fig. 5. Power trend in a year.

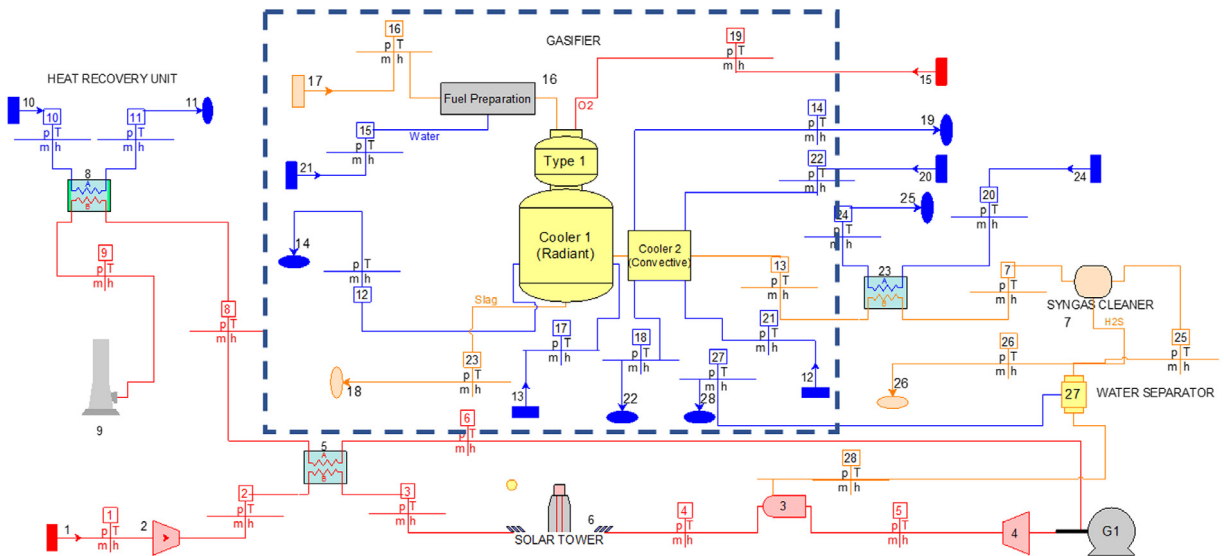

Fig. 6. Hybrid MGT-solar power plant with olive pits gasifier.

electrical energy and heat exclusively from renewable sources. The *Thermoflex* software is used to model the olive pits gasification process too. In Fig. 6 the complete plant is represented and in Table 5 the biomass characteristics are reported. A one-stage slurry gasifier with two coolers was chosen from software library and the equivalent ratio was imposed. The air/fuel equivalence ratio, defined as ratio of the air used in the system to the stoichiometrically demanded air, constitutes a significant factor because it influences the process. In fact, both temperature and ER significantly affect the gasification process and the heating value of the produced syngas [22]. Its value typically ranges from 0.2 to 0.4 for biomass gasification as reported in [23]. To evaluate the air amount to be introduced in gasifier, the stoichiometric ratio was calculated as reported in [24]:

$$\alpha_{st} = \left(\frac{\dot{m}_{air}}{\dot{m}_{fuel}} \right)_{stoch} = \frac{4.31 * (8w_H + 2.667w_C + w_S - w_O)}{100} = 6.3 \quad (3)$$

in which w_H , w_C , w_S , w_O are hydrogen, carbon, sulphur and oxygen mass fractions respectively.

Table 5. Biomass characteristics.

Fuel Name: Olive Pits		
Total LHV + Sensible heat @ 25C	18758	kJ/kg
Ultimate Analysis (weight %)		
Moisture	6.08	%
Ash	1.62	%
Carbon	49.57	%
Hydrogen	6.28	%
Nitrogen	0.42	%
Chlorine	0.04	%
Sulphur	0.05	%
Oxygen	35.94	%
Total	100	%

The Equivalence Ratio being equal to: $ER = \frac{\dot{m}_{air}}{\dot{m}_{fuel}}$

$$\alpha = \frac{\dot{m}_{air}}{\dot{m}_{fuel}} = ER * \left(\frac{\dot{m}_{air}}{\dot{m}_{fuel}} \right)_{stoich} \quad (4)$$

Assuming $ER = 0.2$, after a sensitivity analysis, the air/fuel ratio $\alpha = 1.26$

In this condition, the gasifier works at 652 °C, with an efficiency of 89%; at design point the maximum syngas flow rate (night hours) is of 0.0163 kg/s and it exits from the first syngas cooler at 320 °C and then leaves the second cooler at 250 °C. The syngas presents an LHV (Lower Heating Value) equal to 7506 kJ/kg and its composition is shown in Table 6. A third syngas cooler (block 23 in the plant scheme) is inserted in the system to lower the syngas temperature entering the cleaning system able to reduce H_2S contents upstream the MGT combustor. The latter heat exchanger produces hot-water at 60 °C too. Moreover, the presence of the liquid water in syngas entering combustor (see Table 6) at 15 °C, imposed a water separator too, as shown in the scheme of Fig. 6. It is worth noting that combustor of this MGT adapts very well to biomass derived fuels, as demonstrated in previous papers [25,26].

Table 6. Syngas composition.

Species	Mole%
CO	22.03
CO ₂	12.36
CH ₄	12.17
H ₂	11.90
H ₂ S	0.0002
H ₂ O	3.164
COS	0.001
N ₂	37.91
Ar	0.4545

3.1. Results

In this section, the results referred to hybrid plant with gasifier carried out by using the *Thermoflex* software are reported. At first, the performance of the plant in this new configuration with biomass supply is taken into consideration. The electrical net power versus day hours is reported in Fig. 7, calculated for a specific day on July, as an example, by varying the solar irradiance value and ambient temperature. The syngas fuel, although presenting a lower LHV value, allowed to reach the gas turbine nominal power. At the same time, the compressor is kept inside its operating domain, without modifications to the current plant configuration despite the higher fuel flow rates with respect to natural gas. Once the plant has been designed, it works in off-design mode, considering the characteristics of the compressor, turbine and exchangers. In Fig. 8 the air mass flow rate through the compressor versus hours of the day is reported. In this case, power reduction is basically due to high temperature and solar tower losses, rather than the air flow rate decrease. In fact, in this specific day, the situation is particularly critical for

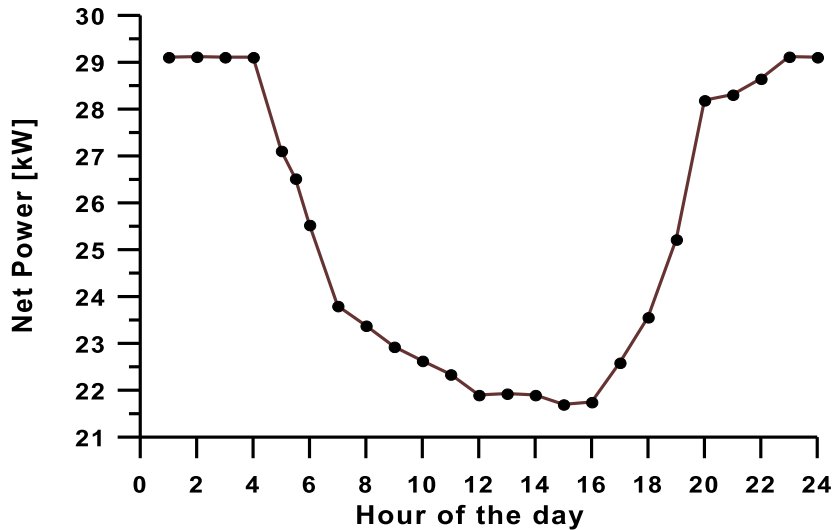

Fig. 7. Net Power versus hours of the day.

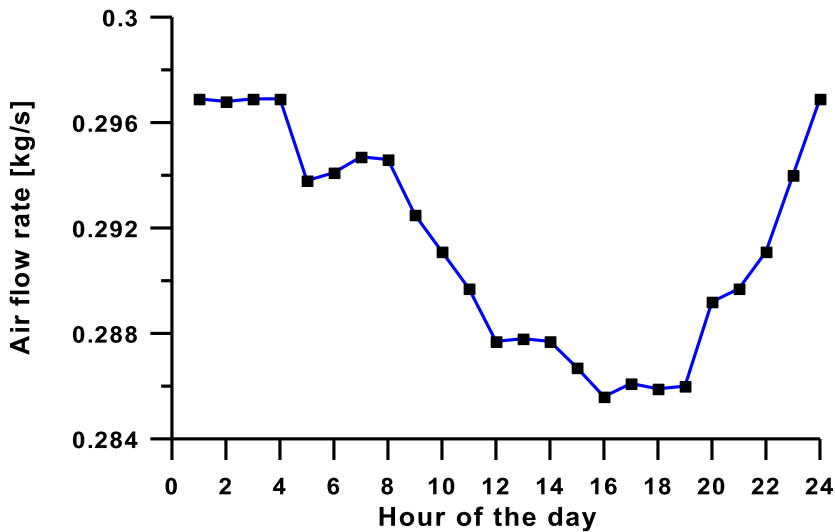

Fig. 8. Compressor air flow rate versus hours in a day.

the gas turbine since the ambient temperature is very high, resulting in a reduction of the specific work. Actually, the ambient temperature influences the gas turbine operation and therefore the net power, as expected.

In Fig. 9 the syngas fuel input entering combustor, compared with natural gas input, is reported: the first presents a higher amount respect to natural gas heat power.

In Fig. 10 the plant efficiency is reported during the same day, according to Eq. (1), where for this plant the fuel heat represents the fuel source (biomass) entering gasifier. In this new configuration, the average plant net electric efficiency is equal to 21.26% during the night hours calculated in a year, when the tower is out of service and only gasifier works, therefore lower than the average value (25.2%) obtained by original MGT plant fuelled by natural gas. This difference is due to the presence of the gasifier that introduces additional losses. It is important to note that the efficiency is lowered when the tower heat contribution is strongly reduced (for example at 5 a.m.), introducing predominantly losses. In these hours with a very low solar irradiance, it would be advisable to bypass the tower to maintain high efficiency values around 21%. When irradiance increases, a global efficiency rising is observed (Eq. (1)) and in particular when solar irradiance is enough to allow gas turbine to reach the fixed TIT, the gasifier

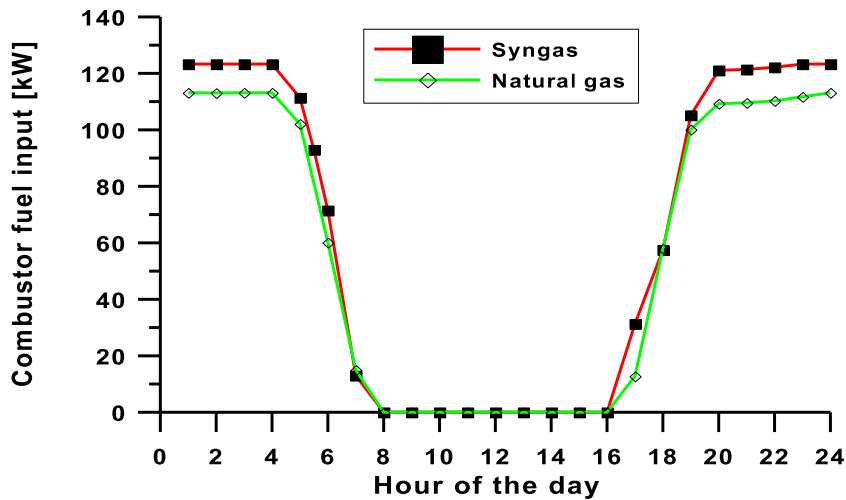

Fig. 9. Fuel input during a day.

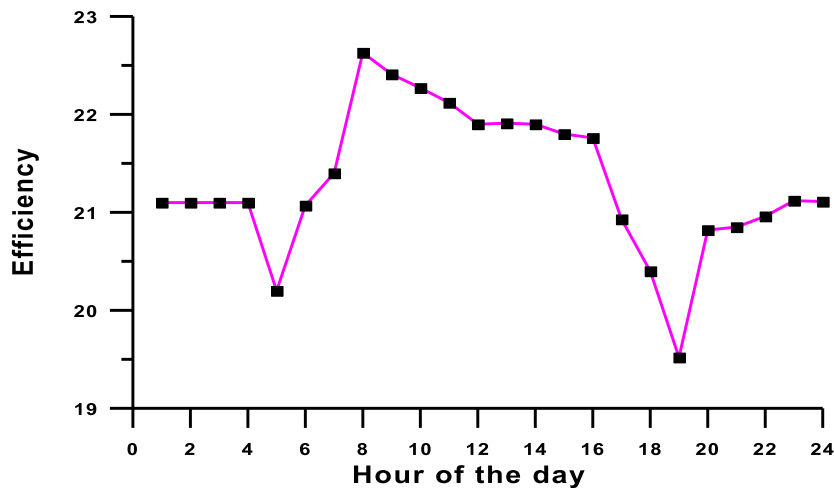

Fig. 10. Global efficiency versus hours of a day.

goes out of service and the efficiency strongly increases. Both heat inputs are represented in Fig. 11 distinguishing the contribution of the solar tower from that of the biomass entering the gasifier.

An increase in thermal power from the third exchanger (block 23 in Fig. 6) downstream of the gasifier is added to the heat recovery unit, already present in the basic configuration of CHP plant producing an average heat power of 55 kW. This additional thermal power, varying during the hours of the day and months of the year based on the gasification system operating conditions, presents an average value of 2.77 kW in the diurnal hours and of 8.8 kW during the night hours. The trend obtained in a year is reported in Fig. 12 by varying irradiance value and naturally during the summer the amount of heat obtained from this exchanger is reduced, the work of the solar tower prevailing.

Finally, Fig. 13 shows the comparison of CO₂ mass flow rate, in dependence of syngas and natural gas fuels, for the same day of the year. There, an increase of CO₂ mass flow rate is observed for the former fuel, due to the high amount of this specie in the syngas composition and to the increase of fuel consumption. In Fig. 14, the CO₂ emission in kg/kWh is plotted as a function of the months of the year. As expected, the amount of CO₂ increases in the winter period with reduced solar irradiance, showing in any case a higher value than that obtained with natural

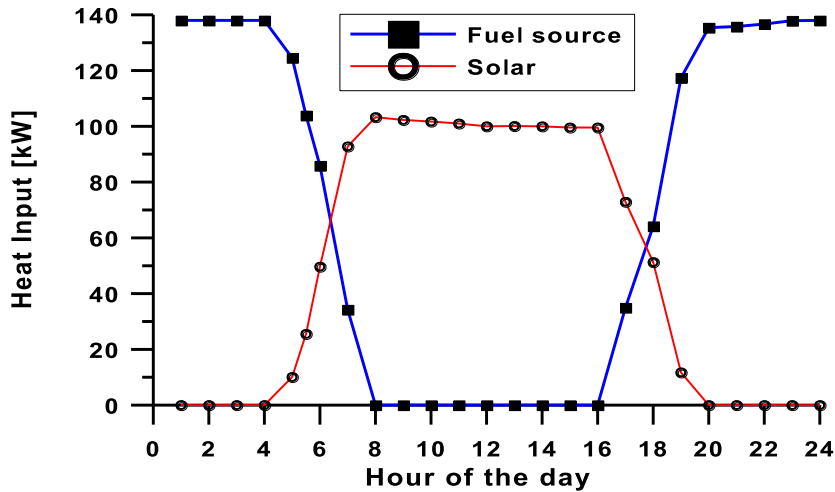

Fig. 11. Heat input versus hours of a day.

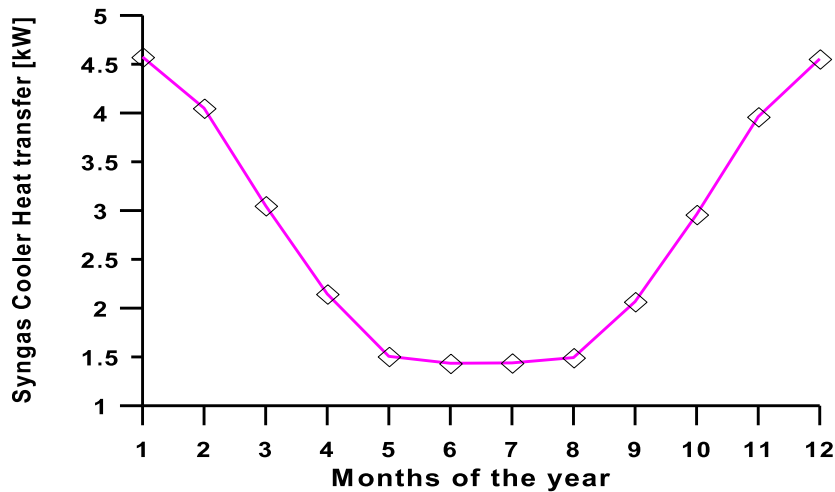

Fig. 12. Syngas cooler heat transfer during a year.

gas (see Fig. 4). The average value in a year is now 0.815 kg/kWh in diurnal hours and 1.656 kg/kWh in night hours, higher respect to the values reported in Table 3 for natural gas fuel.

4. Conclusions

In the current preliminary research an early MGT-solar system, optimized by following a thermo-economic approach, was made totally “green” with the integration of a biomass gasifier. It produces a syngas by olive pits replacing natural gas as fuel. The response of the syngas-fuelled plant can be considered as satisfactory in terms of net power obtained at the expense of overall efficiency referred to biomass input, because of the losses in the gasification process. Besides, the characteristics of the syngas are very different from natural gas with a smaller LHV value leading to an increase in fuel flow rates displacing the operating point of dynamic machines, without inducing critical situations in several plant operating conditions.

In the plant with gasifier, there is also a further heat availability, which is added to that already obtainable from the CHP base plant. This promotes cogeneration and improves the primary energy saving factor.

As expected, the CO₂ emissions will be greater than those produced by the original plant fuelled by natural gas, due to the presence of this specie in the fuel composition and higher fuel consumption. Anyway, the biomass is

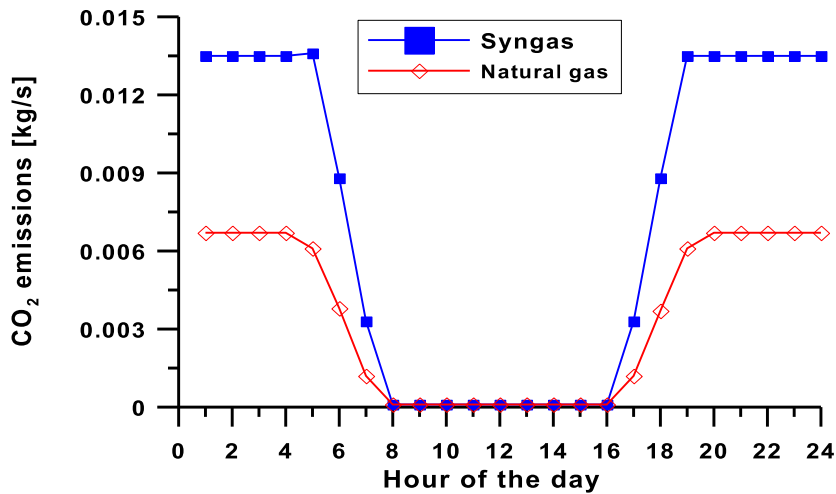

Fig. 13. Comparison of CO₂ emissions in a day with two fuels.

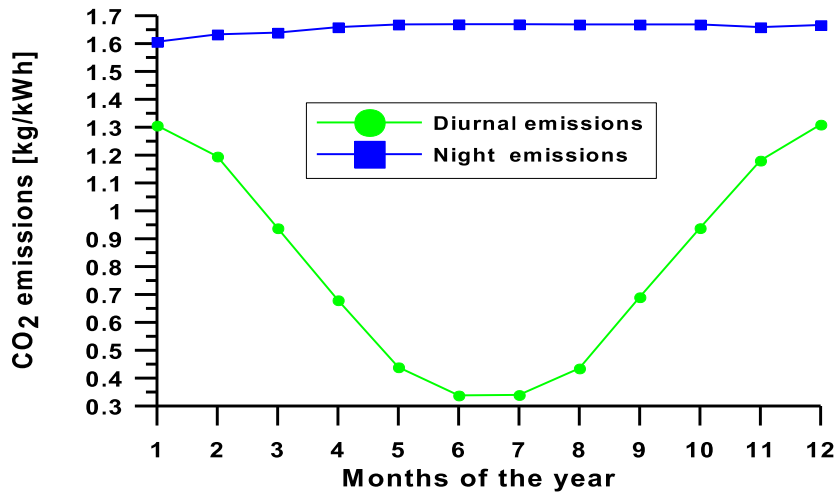

Fig. 14. CO₂ emissions trend in a year.

considered to be a CO₂-neutral fuel because plants absorb CO₂ from the atmosphere through photosynthesis, and it emits the same amount of CO₂ from burning.

In this study the profitability of the investment of the whole hybrid MGT–solar plant with gasifier was not considered but positive results are expected in future works investigating the sold energy, government incentives and the cogeneration for industrial or residential heat demand.

Acknowledgement

The plant simulations are performed by the *THERMOFLEX* software, licenced by Thermoflow Inc.

References

- [1] Singh A, Baredar P. Techno-economic assessment of a solar PV, fuel cell, and biomass gasifier hybrid energy system. *Energy Rep* 2016;2:254–60. <http://dx.doi.org/10.1016/j.egy.2016.10.001>.
- [2] Marc-Alain Mutombo N, Numbi BP. Assessment of renewable energy potential in Kwazulu-Natal province, South Africa. *Energy Rep* 2019;5:874–81. <http://dx.doi.org/10.1016/j.egy.2019.07.003>.

- [3] Abagnale C, Cameretti MC, De Robbio R, Tuccillo R. Thermal cycle and combustion analysis of a solar-assisted micro gas turbine. *Energies* 2017;10(6). <http://dx.doi.org/10.3390/en10060773>, art. no. 773.
- [4] Cameretti MC, Langella G, Sabino S, Tuccillo R. Modeling of a hybrid solar micro gas-turbine power plant. *Energy Procedia* 2015;62:833–40. <http://dx.doi.org/10.1016/j.egypro.2015.11.820>.
- [5] Amadei CA, Allesina G, Tartarini P, Wu Yuting. Simulation of GEMASOLAR-based solar tower plants for the Chinese energy market: influence of plant downsizing and location change. *Renew Energy* 2013;55:366–73.
- [6] Cameretti MC, De Robbio R, Pirone E, Tuccillo R. Thermo-economic analysis of a hybrid solar micro gas turbine power plant. *Energy Procedia* 2017b;126:667–74. <http://dx.doi.org/10.1016/j.egypro.2017.08.295>.
- [7] Arena U. Process and technological aspects of municipal solid waste gasification. a review. *Waste Manage* 2012;32:625–39.
- [8] Bhattacharya A, Bhattacharya A, Datta A. Modeling of hydrogen production process from biomass using oxygen blown gasification. *Int J Hydrog Energy* 2012;37(24). 18782e90.
- [9] Allesina G, Pedrazzi S, Allegretti F, Morselli N, Puglia M, Santunione G, Tartarini P. Gasification of cotton crop residues for combined power and biochar production in Mozambique. *Int J Hydrogen Energy* 2018;43. 14214e14225.
- [10] Hwang IH, Kobayashi J, Kawamoto K. Characterization of products obtained from pyrolysis and steam gasification of wood waste, RDF, and RPF. *Waste Manage* 2014;34(2). 402e10.
- [11] Cheng G, He PW, Xiao B, Hu ZQ, Liu SM, Zhang LG, et al. Gasification of biomass micron fuel with oxygen-enriched air: thermogravimetric analysis and gasification in a cyclone furnace. *Energy* 2012;43(1). 329e33.
- [12] Kuba M, He HB, Kirnbauer F, Skoglund N, Dan B, Ohman M, et al. Mechanism of layer formation on olivine bed particles in industrial-scale dual fluid bed gasification of wood. *Energy Fuel* 2016;30(9). 7410e8.
- [13] Pei Haipeng, Wang Xiaojia, Dai Xin, Jin Baosheng, Huang Yaji. A novel two-stage biomass gasification concept: design and operation of a 1.5 MWth demonstration plant. *Bioresour Technol* 2018;267:102–9.
- [14] Vilches TB, Marinkovic J, Seemann MC, Thunman H. Comparing active bed materials in a dual fluidized bed biomass gasifier: olivine, bauxite, quartz-sand and ilmenite. *Energy Fuel* 2016;30(6). 4848e57.
- [15] Borello D, Pantaleo AM, Caucci M, De Caprariis B, De Filippis P, Shah N. Modeling and experimental study of a small scale olive pomace gasifier for cogeneration: energy and profitability analysis. *Energies* 2017;(10):1930. <http://dx.doi.org/10.3390/en10121930>.
- [16] Fiori L, Florio L. Gasification and combustion of grape marc: comparison among different scenarios. *Waste Biomass Valor* 2010;1:191–200. <http://dx.doi.org/10.1007/s12649-010-9025-7>.
- [17] Nixon JD, Dey PK, Davies PA. The feasibility of hybrid solar-biomass power plants in india. *Energy* 2012;46:541–54.
- [18] Dupont C, Boissonnet G, Seiler JM, Gauthier P, Schweich D. Study about the kinetic processes of biomass steam gasification. *Fuel* 2007;(86):32–40. <http://dx.doi.org/10.1016/j.fuel.2006.06.011>.
- [19] Wan Ab Karim Ghani WA, Moghadam RA, Mohd Salleh MA, Alias AB. Air gasification of agricultural waste in a fluidized bed gasifier: hydrogen production performance. *Energies* 2009;2(2):258–68. <http://dx.doi.org/10.3390/en20200258>.
- [20] Skoulou V, Koufodimos G, Samaras Z, Zabaniotou A. Low temperature gasification of olive kernels in a 5-kw fluidized bed reactor for H₂-rich producer gas. *Int J Hydrog Energy* 2008;33:6515–24.
- [21] Qian K, Kumar A, Patil K, Bellmer D, Wang D, Yuan W, Huhnke RL. Effects of biomass feedstocks and gasification conditions on the physiochemical properties of char. *Energies* 2013;6:3972–86. <http://dx.doi.org/10.3390/en6083972>.
- [22] Damartzis Th, Michailos S, Zabaniotou A. Energetic assessment of a combined heat and power integrated biomass gasification–internal combustion engine system by using aspen plus[®]. *Fuel Process Technol* 2012;95:37–44. <http://dx.doi.org/10.1016/j.fuproc.2011.11.010>.
- [23] Kirsanovsa V, Žandeckis B, Blumbergac D, Veidenbergs I. The influence of process temperature, equivalence ratio and fuel moisture content on gasification process: A review. In: 27st international conference on efficiency, cost, optimization, simulation and environmental impact of energy systems; 2014.
- [24] Mendiburu AZ, Carvalho Jr JA, Coronado CJR. Thermochemical equilibrium modelling of biomass downdraft gasifier: stoichiometric models. *Energy* 2014;66:189–201. <http://dx.doi.org/10.1016/j.energy.2014.05.010>.
- [25] Cameretti MC, De Robbio R, Tuccillo R. CFD study of a micro - Combustor under variable operating conditions. In: Proceedings of the ASME Turbo Expo 8. USA: American Society of Mechanical Engineers (ASME); ISBN: 9780791850954, 2017a, <http://dx.doi.org/10.1115/GT2017-63661>.
- [26] Abagnale C, Cameretti MC, De Robbio R, Tuccillo R. CFD Study of a MGT combustor supplied with syngas. *Energy Procedia* 2016;101:933–40. <http://dx.doi.org/10.1016/j.egypro.2016.11.118>.