

Martín-García, Íñigo et al.

Article

Hydrogen as an energy vector to optimize the energy exploitation of a self-consumption solar photovoltaic facility in a dwelling house

Energy Reports

Provided in Cooperation with:

Elsevier

Suggested Citation: Martín-García, Íñigo et al. (2020) : Hydrogen as an energy vector to optimize the energy exploitation of a self-consumption solar photovoltaic facility in a dwelling house, Energy Reports, ISSN 2352-4847, Elsevier, Amsterdam, Vol. 6, Iss. 3, pp. 155-166, <https://doi.org/10.1016/j.egy.2019.10.034>

This Version is available at:

<https://hdl.handle.net/10419/243988>

Standard-Nutzungsbedingungen:

Die Dokumente auf EconStor dürfen zu eigenen wissenschaftlichen Zwecken und zum Privatgebrauch gespeichert und kopiert werden.

Sie dürfen die Dokumente nicht für öffentliche oder kommerzielle Zwecke vervielfältigen, öffentlich ausstellen, öffentlich zugänglich machen, vertreiben oder anderweitig nutzen.

Sofern die Verfasser die Dokumente unter Open-Content-Lizenzen (insbesondere CC-Lizenzen) zur Verfügung gestellt haben sollten, gelten abweichend von diesen Nutzungsbedingungen die in der dort genannten Lizenz gewährten Nutzungsrechte.

Terms of use:

Documents in EconStor may be saved and copied for your personal and scholarly purposes.

You are not to copy documents for public or commercial purposes, to exhibit the documents publicly, to make them publicly available on the internet, or to distribute or otherwise use the documents in public.

If the documents have been made available under an Open Content Licence (especially Creative Commons Licences), you may exercise further usage rights as specified in the indicated licence.



<https://creativecommons.org/licenses/by-nc-nd/4.0/>

Tmrees, EURACA, 04 to 06 September 2019, Athens, Greece

Hydrogen as an energy vector to optimize the energy exploitation of a self-consumption solar photovoltaic facility in a dwelling house

Íñigo Martín-García^a, Enrique Rosales-Asensio^a, Alberto González-Martínez^a,
Stefano Bracco^b, Federico Delfino^b, Miguel de Simón-Martín^{a,*}

^a Dept. of Electric, Systems and Automatics Engineering, Universidad de León, Campus de Vegazana s/n, 2407 León, Spain

^b Dept. of Naval, Electrical, Electronic and Telecom Engineering, University of Genoa, Savona Campus, Via Magliotto 2, 1700 Savona, Italy

Received 19 September 2019; accepted 28 October 2019

Available online 2 November 2019

Abstract

Solar photovoltaic (PV) plants coupled with storage for domestic self-consumption purposes seem to be a promising technology in the next years, as PV costs have decreased significantly, and national regulations in many countries promote their installation in order to relax the energy requirements of power distribution grids. However, electrochemical storage systems are still unaffordable for many domestic users and, thus, the advantages of self-consumption PV systems are reduced. Thus, in this work the adoption of hydrogen systems as energy vectors between a PV plant and the energy user is proposed. As a preliminary study, in this work the design of a PV and hydrogen-production self-consumption plant for a single dwelling is described. Then, a technical and economic feasibility study conducted by modeling the facility within the Homer Energy Pro energy systems analysis tool is reported. The proposed system will be able to provide back not only electrical energy but also thermal energy through a fuel cell or refined water, covering the fundamental needs of the householders (electricity, heat or cooling and water). Results show that, although the proposed system effectively increases the energy local use of the PV production and reduces significantly the energy injections or demands into/from the power grid, avoiding power grid congestions and increasing the nano-grid resilience, operation and maintenance costs may reduce its economic attractiveness for a single dwelling.

© 2019 Published by Elsevier Ltd. This is an open access article under the CC BY-NC-ND license (<http://creativecommons.org/licenses/by-nc-nd/4.0/>).

Peer-review under responsibility of the scientific committee of the Tmrees, EURACA, 2019.

Keywords: Hydrogen; Solar photovoltaics; Energy vector; Power storage; Smart grids; Nano-grids

1. Introduction

Fortunately, wider consciousness on climate change in the society and policy makers is currently moving traditional energy systems, mainly based on fossil fuels, to the use of the so-called clean energies or renewable energies. This applies to all sectors, from electricity generation to the domestic supply energy systems [1–3]. The

* Corresponding author.

E-mail address: miguel.simon@unileon.es (M. de Simón-Martín).

<https://doi.org/10.1016/j.egy.2019.10.034>

2352-4847/© 2019 Published by Elsevier Ltd. This is an open access article under the CC BY-NC-ND license (<http://creativecommons.org/licenses/by-nc-nd/4.0/>).

Peer-review under responsibility of the scientific committee of the Tmrees, EURACA, 2019.

Nomenclature

AC	Alternating Current.
AEM	Alkaline anion Exchange Membrane.
CAPEX	Capital Expenditures.
COE	Cost of Energy.
COP	Coefficient of Performance.
DC	Direct Current.
EJ/year	Exa-Joules (10^{12} J) per year.
Non-RES	Non Renewable Energy Sources.
RES	Renewable Energy Sources.
H ₂	Hydrogen.
H ₂ O	Water.
NPC	Net Present Cost.
OPEX	Operation (and Maintenance) Expenditures.
PEM	Proton Exchange Membrane.
ppm	Parts per million.
PV	Solar photovoltaic.
Wp	Watt peak power.

advantages from using renewable energies are widely known, highlighting that they are resources free of charge, globally distributed and they do not produce greenhouse gas emissions. The use of these systems in combination with saving and efficiency measures in the building sector will, undoubtedly, reduce the human footprint on Earth (it must be considered that, as it can be seen in Figure 1, the primary energy consumed in the buildings sector achieves almost one third of the national internal total consumed primary energy in a developed country, such as Spain). However, the adoption of Renewable Energy Sources (RES) to supply the domestic sector has still to face many challenges. One of the most important ones is the fact that RES are variable and their production is associated with a high degree of uncertainty [4]. Thus, energy storage systems are needed to adequate the consumption profile to the generation profiles (which is also called “energy shifting” or “power allocation”) [5–7]. In the case of electricity, currently several improvements in the developing of electrochemical batteries are making this technology feasible for a mid-scale energy storage [8], but these systems are still expensive for householders and they show a limited lifespan (between 7 and 12 years) [9,10]. On the other hand, in the case of thermal energy, hot and warm water tanks have been used for a long time. These tanks storage thermal energy produced by gas boilers or other sources in the form of hot water, which later can be used for heating or providing hot water. However, these systems are usually inefficient and, if they are not appropriately isolated, show a large amount of energy losses [11–13].

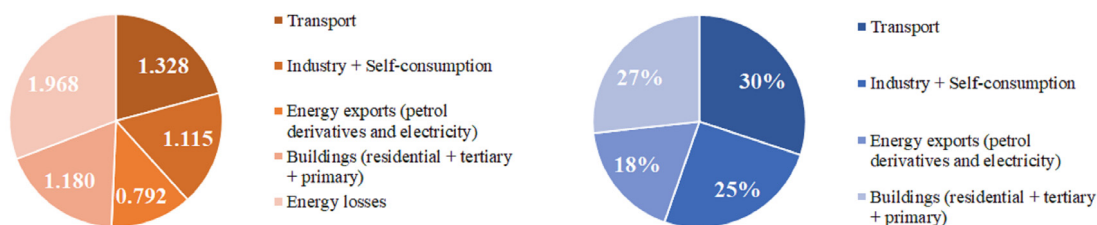

Fig. 1. Energy consumption in Spain for 2017 expressed in total primary energy in [EJ/year] (a) and as percentage of total primary energy without considering energy losses (b).

Source: Own elaboration. Data from: [14].

Then, in order to attend the typical householders needs, which include electricity, heating, cooling and hot water, by renewable energy sources, the energy vector between these sources and the final consumption results of key

importance. Several options, such as the described ones, are available. In this paper, it is analyzed in deep if a hydrogen-based system can be a feasible candidate for this purpose. It has been investigated its application in industrial systems, but still very few studies have been conducted to examine its application in the domestic sector.

Hydrogen can be considered as an energy vector which increases the consumers' possibilities not only for thermal or power energy generation, but also for transport [15,16]. Moreover, energy storage through hydrogen can boost RES distributed generation allowing each "prosumer" (energy consumer and producer) to become more independent from the power grid, and increasing his/her options to interact with it by providing power demand shifting services or selling surplus energy generated according to the power grid necessities, among other [17]. Moreover, it can contribute to decrease power losses in the power grid and take better advantage of non-RES [18,19].

Some recent projects are considering the possibility of using natural gas pipelines to transport hydrogen, well mixed with natural gas or alone [20–22]. Thus, a hydrogen grid could be created, allowing that grid users to distribute produced hydrogen and take it from the grid decreasing (or even eliminating) the hydrogen storage, which is one of the most disadvantages of its use, due to involved costs, space requirements and potential safety problems. Other international projects are getting great advantages in hydrogen transport applications, rising new needs to supply this source of energy to domestic users for a successful deployment [23].

In this work, as a previous approach to the analysis of a complete hydrogen prosumers distribution grid, it has been sized and analyzed the behavior of a hydrogen-based system to feed a dwelling house, comparing the previous situation with a conventional system, based on a connection to the power grid and a natural gas boiler for thermal energy consumption (heating and hot water production). Data have been taken from a real case study in Spain and the complete system has been modeled by using Homer Energy Pro software, which is an optimization and numerical simulation tool. With the developed model, a complete year in hourly steps simulation was conducted and then, a basic analysis was performed, which is of great interest for further and more complex designs.

This paper is organized into three more sections. Next section, Materials and Methods, describes both the system design, all its components and the characteristics of the evaluated case study. Then, in the Results and Discussion section, obtained results from the simulation are presented and discussed. Finally, the paper ends with the Conclusions section where the authors summarize the main obtained conclusions and define future lines of the work.

2. Material and methods

Hydrogen (H_2) is the first element in the Periodic Table. In normal conditions it is a non-colored, odorless and tasteless gas, which is formed by diatomic molecules. Hydrogen is the most abundant element in the Universe and, in Earth, most part of it can be found in chemical compounds, such as water (H_2O) or hydrocarbons. In Earth it is the 15th most abundant element [24].

Currently, hydrogen production can be achieved by several methods [25], mainly related with industrial processes that separate it from other compounds where it is present, as in normal conditions, elemental hydrogen is very scarce on Earth (it is present in a fraction lower than 1 ppm in the atmosphere due to it has so low mass than easily escapes from gravity). These industrial methods are:

- Water thermolysis from nuclear reactions.
- Photochemical or photobiological processes.
- Water electrolysis.
- Fossil fuels decarbonization.
- Biomass processes (pyrolysis, gasification, fermentation or reformation of bio-derivates).
- Reformation of natural gas.
- Thermal decomposition of natural gas or petroleum derivates.
- Carbon pyrolysis or gasification.
- High temperature electrolysis or thermochemical cycles of uranium.

From all these technologies, electrolysis is one of the most common processes for hydrogen production and it shows the advantage of being produced by an electrical process in a compact unit (electrolyzer) which is an intrinsic condition for domestic use [24]. The electricity origin in this case can be from renewable or not renewable sources. If it is obtained from a RES, some authors call it as "green hydrogen" [26]. It must be noticed that reformation

processes of hydrocarbons are more efficient and lower costless for this purpose and, thus, electricity from non-RES is not usually used.

Water electrolysis was developed by Michael Faraday in 1820 and it is considered one of the cleanest, simplest and most intuitive processes to obtain hydrogen. As it is widely known, the electrolysis process is based on the separation of a water molecule into oxygen and hydrogen thanks to a direct electricity current (DC) in an electrolytic cell (electrolyzer) like the one it can be seen in Fig. 2 [27].

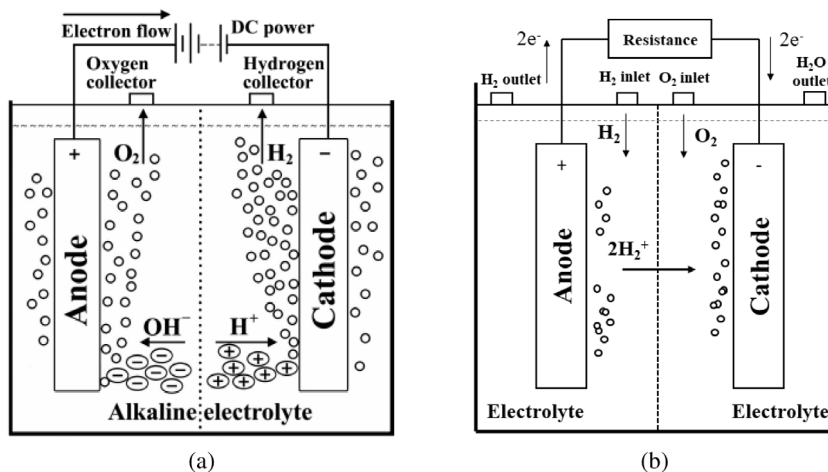

Fig. 2. Electrolytic cell scheme (a) and hydrogen fuel cell (b).

Source: Adapted from: [27].

In a reversed way, electricity from hydrogen can be obtained through the so-called as “fuel cell” or “hydrogen cell”. In this case, hydrogen is introduced as a fuel in the system which, in combination with pure oxygen, produces water (H_2O), a positive DC current between the electrodes and heat.

Although efficiencies must be considered in the electrolyzer and fuel cell, it must be reminded that hydrogen can be stored easily and with low cost in a fuel tank (or even injected to a grid) and recovered later, which constitutes a great advantage [28].

2.1. Dwelling house demand

As case study, a dwelling house has been selected. As expected, householders have both an electrical and thermal energy demands. For providing thermal energy, the house accounts with a gas boiler which satisfies a hot water demand and heating needs. In total, the heating demand is estimated in 3570 kWh/year of final usable energy, which corresponds to 3966 kWh/year of natural gas energy.

On the other hand, the electrical facilities are characterized by an average consumption of 1225 kWh/year and a rated power of 4.7 kW. The energy demand profiles along a complete year can be observed in Fig. 3.

With the new proposed installation, thermal demand from the gas boiler will be substituted by an electric heat pump with a seasonal COP (Coefficient of Performance) of 2.5. This means that the 3966 kWh/year of natural gas consumption will be substituted by 1428 kWh/year of extra electrical consumption when the electrical heat pump will provide the heating and hot water needs of the householders. Thus, under the new configuration, a total consumption of 2652 kWh/year of electrical power has been estimated in the design.

2.2. Solar photovoltaic plant

The hydrogen generation will be made by a commercial electrolyzer plant fed by solar photovoltaic energy. It must be noticed that, for the case study, it has been considered that the hydrogen production can be made only with PV energy, while the connection to the power grid will be used only to supply the electricity needs not satisfied by the hydrogen-based system.

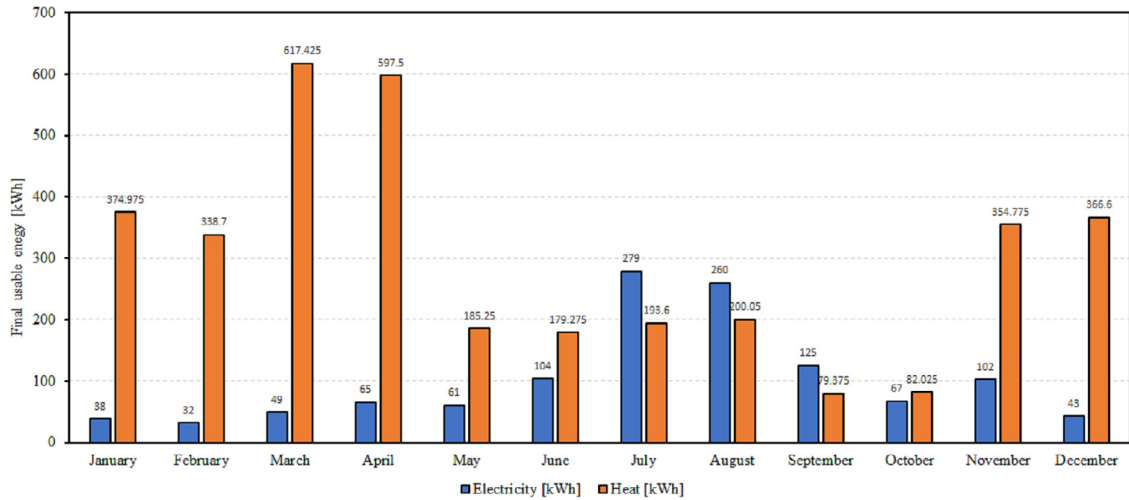

Fig. 3. Demand profiles of the dwelling house.
 Source: Own elaboration.

The solar PV generation plant is installed in the rooftop of the dwelling house and, thus, it is restricted by the available surface. In this case two different orientations rooftop surfaces were considered, according to the construction restrictions of the house. One PV plant will be installed in a rooftop surface oriented +60 degrees in the Southwest direction, while the other will be placed just the opposite (−120 degrees — Northeast direction). Each installation surface is limited to 41 m², being the total available surface 82 m². In order to optimize the solar PV production, auxiliary racks for mounting the PV modules have been considered allowing an optimal inclination of 34 degrees (with the horizontal).

The PV field will be composed by single Silicon PV modules with a peak rated power of 500 Wp and a surface of 3.55 m² each. This means that the PV facility will account with 16 kWp which will produce up to 15 733 kWh/year, as shown in Fig. 4.

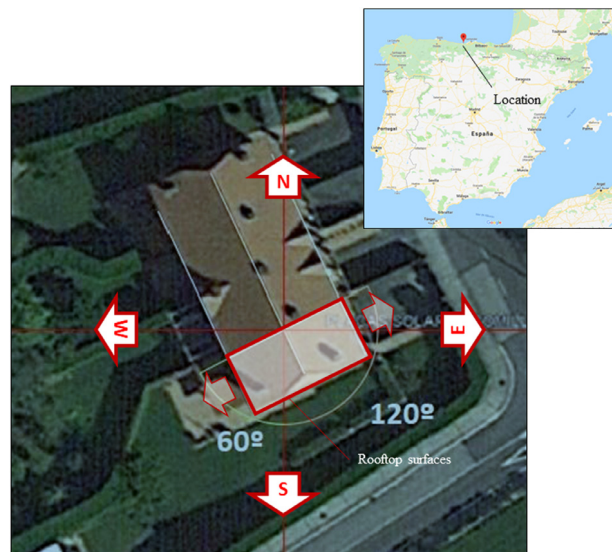

Fig. 4. Facilities location and available space for solar photovoltaic fields.
 Source: Own elaboration.

2.3. Electrolyzer

Water electrolysis will be made at low temperature, so a PEM electrolyzer has been chosen as the most appropriate technology in this case as it allows significantly higher current densities in comparison with alkaline or AEM electrolyzers [29–31].

For initial sizing of the fuel cell, it has been considered that an electrolyzer unit has a typical voltage of 1.7 V and, by applying the Faraday's equation and considering an ideal efficiency (Eqn. (1)).

$$\begin{aligned} W &= n \cdot F \cdot E = 2 \frac{\text{mol e}}{\text{mol H}_2} \cdot 96458 \frac{\text{C}}{\text{mol e}} \cdot 1.7 \text{ V} = 328049 \frac{\text{J}}{\text{mol H}_2} \\ &= 15.56 \frac{\text{kWh}}{\text{kg H}_2} = 3.72 \frac{\text{kWh}}{\text{Nm}^3 \text{H}_2}, \end{aligned} \quad (1)$$

where n is the number of mols of electrons per mol of hydrogen, F is the electrical charge of a mol of electrons and E the electromotive force of a cell. According to the previous result, which establishes the limit, a commercial electrolyzer was selected with a maximum peak power of 7.2 kW and 30 bar outlet pressure. This device is able to produce up to 0.1063 kg of hydrogen per hour with an electrical consumption of 5.53 kWh per Nm³ of produced hydrogen or, i.e. 67.70 kWh per kg.

2.4. Hydrogen storage tank

In case of no access to a hydrogen distribution grid is available, hydrogen storage must be done locally. Although there exist several methods, the most appropriate for domestic cases is the mechanical storage into compressed tanks. These tanks must have low traction resistance, low density and be made of materials not reactive with hydrogen. These restrictions reduce the possible tanks to only two types: Type III (epoxy + carbon fiber) and Type IV (metal + epoxy + carbon fiber). In our case, due to they are much more economic and no high-pressure rates must be supported, a Type III storage tank has been selected. A maximum storage volume of 25 m³ has been set.

On the other hand, some industrial hydrogen generation facilities add a compressor to increase hydrogen density and, thus, the stored hydrogen in lower volume. In our case, the storage tank is small enough to be placed in the dwelling house and the working pressures of the electrolyzer and the fuel cells are sufficient to avoid this element, which is costly (both in capital and operation and maintenance expenditures) and adds a new source of possible failures and malfunctions.

2.5. Fuel cell

In order to conduct a successful transition to the proposed scheme, the fuel cell must provide the sufficient instantaneous power (4.7 kW) and the maximum required energy (2653 kWh/year). It must be noticed at this point that the energy demand is purely electric, as the heating/cooling needs will be supplied by an electrical heat pump in the new proposed scheme. The energy needs were translated into hydrogen generation needs by applying the Faraday's equation (as previously seen for the sizing of the electrolyzer). For this energy demand, 141.40 kg of hydrogen will be necessary to supply to the dwelling yearly in an ideal fuel cell with an overall performance of 100%. One of the closest commercial feasible fuel cells, which has been selected for the case study, is the *Fcgen* — *H2PM* device, which consumes a peak power of 5 kW and has a volumetric fuel consumption of 0.8 Nm³ of hydrogen per produced kWh, i.e. 0.07142 kg of H₂ per kWh. As shown in Eqn. (2), according to these values, real fuel needs for the new configuration are:

$$m_{\text{H}_2} = 2653 \frac{\text{kWh}}{\text{yr}} \cdot 0.07142 \frac{\text{kg H}_2}{\text{kWh}} = 189.46 \frac{\text{kg H}_2}{\text{yr}}. \quad (2)$$

Thus, at least 190 kg of hydrogen must be produced to feed the system.

2.6. DC–AC converter

Generated electricity both in the PV plant and in the fuel cell is in DC, which is appropriate also for the electrolyzer. However, they work at different voltage levels and it must be considered that most power consuming devices are AC. Thus, a DC–AC converter is included in the scheme in such a way the power energy distribution is made in AC (230 V, 1 phase) and each DC device has its own rectifier adjusted to its optimal DC voltage level.

This converter is especially relevant for the installation simulation with the Homer Energy Pro software as it will be seen in following sections.

2.7. Heat pump

Gas boiler has been substituted in the proposed scheme by an electrical aerothermal heat pump. Although this device in particular is not the target of the study, it must be highlighted that the use of heat pumps is highly recommended as they show high efficiencies (common COP values are in the range between 2 and 4) and they can “pump” heat in a highly renewable way from different sources, including external ambient air (aerothermal heat pumps), ground (geothermal heat pumps) or even grounded water (hydro heat pumps). According to the working temperatures, this system will be more or less efficient and, depending of the origin of the electric power which feeds the device, it would be considered more or less renewable. If they are connected to the external power grid, the European Union makes mandatory a minimum seasonal equivalent COP of 2.5 (which is the value it has been chosen in this study), while, if the origin of the electricity feeding the device is renewable, then the heat pump will be 100 % renewable (as it would be the case in our work). An electrical boiler is supposed to supply hot water in the case study.

Although aerothermal heat pumps are less expensive than other types, especially in contrast with geothermal heat pumps, its performance is highly dependent on the external air temperatures and then, they could be not appropriate for certain locations.

2.8. System modeled in Homer Energy Pro

Homer Energy Pro is a powerful software that allows high detailed simulations with hourly time steps for energetic installations. It was specially designed for distributed generation systems and microgrids and it allows not only the system simulation, but also the optimal components sizing, the optimal energy dispatch and conduct sensitivity analysis. It is highly appreciated by professionals and researchers for its features allowing to easily simulate a large number of different configurations even under market uncertainties.

The representative scheme implemented in the software is represented in Fig. 5 where it can be easily observed the three main energy paths: the hydrogen line, the DC line and the AC line.

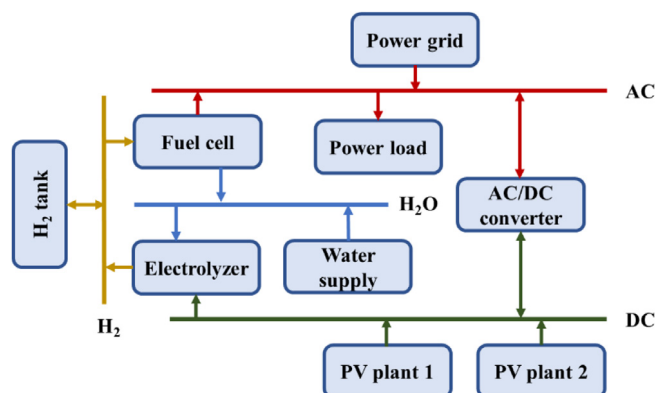

Fig. 5. Implemented scheme in Homer Energy Pro. Source: Own elaboration.

The connection between the DC and AC parts is made with a AC–DC converter which allows to feed the electrolyzer with energy from the power grid in case the PV plants cannot supply this device (although the energy manager will consider this option the last one). On the other hand, the AC–DC bidirectional converter can also supply energy to the power load directly from the PV plants in case of a power surplus or unusually high peak power demand of the power load that cannot be supplied by the fuel cell (and the power grid is not available or it is not desirable to use it).

It must be also considered the controller of the system, which is the part in charge of the energy management of the complete installation. It implements the optimal algorithm which decides the most profitable operation of the devices included in the microgrid. In this case, the selected dispatch algorithm is “*Load Following*” in order to prioritize the power loads needs satisfaction.

3. Results and discussion

After performing the corresponding simulations, the optimal design of the microgrid has been arranged. Parameter values can be seen in Table 1. For more detailed information, it must be considered Figs. 6–11 which show the simulated performance in time of the different components.

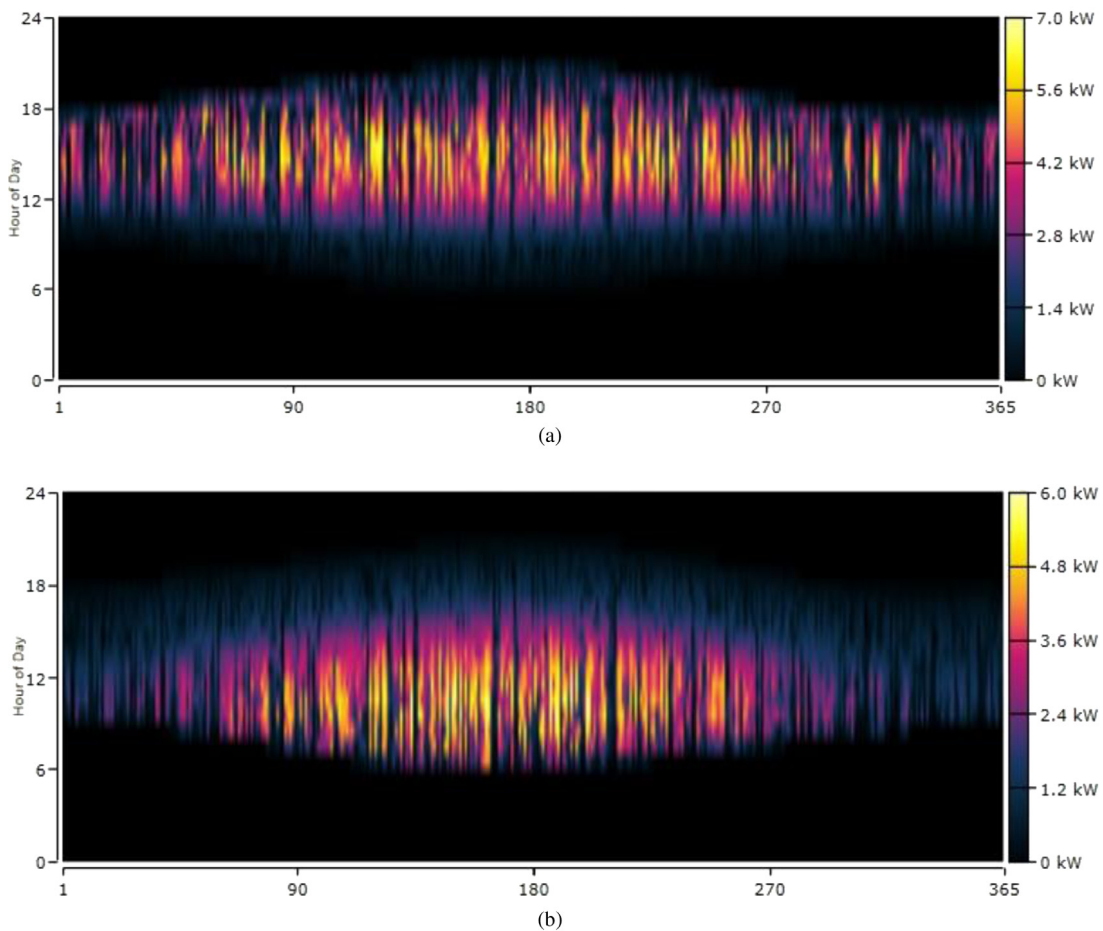

Fig. 6. Solar photovoltaic production: (a) PV plant facing the Southwest direction, (b) PV plant facing the Northeast direction. Source: Own elaboration.

Fig. 6 shows by heat maps, the electricity production for each hour of the simulated year from the two PV plants.

It can be seen that, due to the location’s latitude, significant variance between the summer and winter seasons can be found. Peak power productions are 7 and 6 kW respectively, which are achieved at noon for the Southwest facing facility and before noon for the Northeast facing facility.

On the other hand, Figs. 7 and 8 show the monthly (Fig. 7) and typical daily (Fig. 8) hydrogen productions of the electrolyzer. It can be observed the coupling of the hydrogen production with the PV generation, as the controller prioritizes the use of PV energy for hydrogen production. Maximum production is achieved in June and July, while the minimum is registered in December. Average electrolyzer output is 0.05 kg/h.

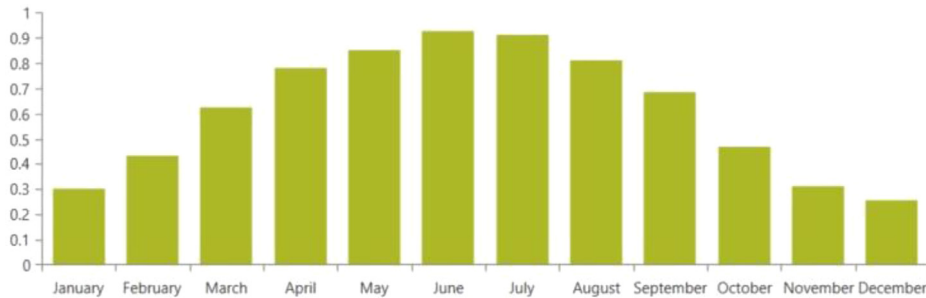

Fig. 7. Relative to maximum monthly hydrogen production.
Source: Own elaboration.

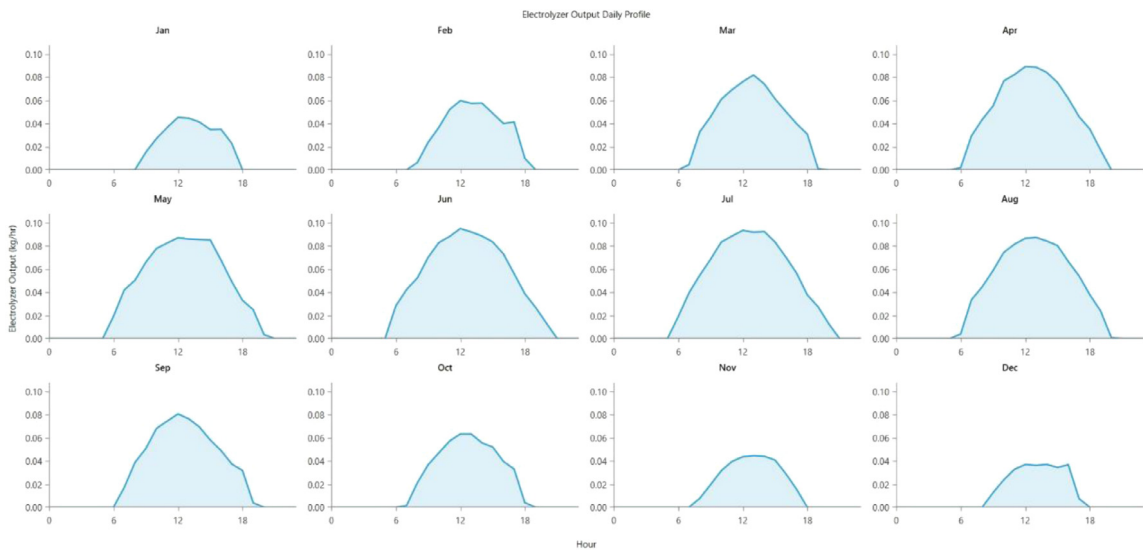

Fig. 8. Typical daily production profiles of the electrolyzer.
Source: Own elaboration.

On the other hand, Fig. 9 shows the operation of the fuel cell during the simulated year. According to the hydrogen production, peak periods are also registered in summer, while lower activity periods correspond to the winter season. Moreover, according to Fig. 10, the average hydrogen consumption of the electrolyzer is 0.02 kg/h with high variances during peak consumption hours (up to 0.085 kg/h).

Differences between hydrogen production in the electrolyzer and consumption in the fuel cell are explained by the level variation of the hydrogen storage tank. It results remarkable that the highest-level values (close to 50 kg) are registered in the autumn season, while the lowest can be seen during winter. This means that real-time hydrogen production in winter is not sufficient enough to supply the power demand and, thus, the hydrogen tank (or the access to a hydrogen supply grid) results fundamental for the technical feasibility of the system.

The optimal configuration of the system allows to storage up to 244 kg of hydrogen while it has a surplus of almost 40 kg, which could be derived either to a hydrogen grid or to the power grid by transforming it in the fuel cell.

In financial terms, the Net Present Cost of the installation (NPC), without considering the energy savings with respect the previous system, is estimated in €115 847 considering 25 years of useful lifespan and the components

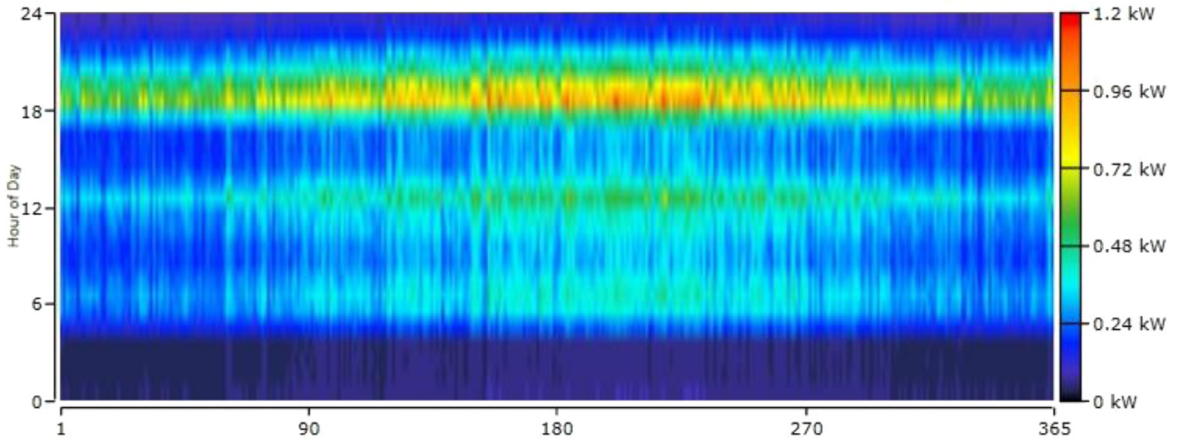

Fig. 9. Operation of the fuel cell.
 Source: Own elaboration.

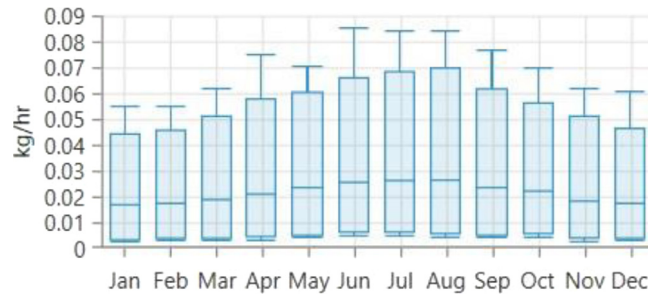

Fig. 10. Hydrogen consumption from the electrolyzer.
 Source: Own elaboration.

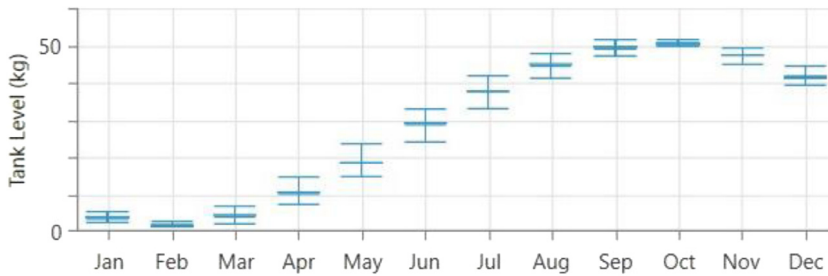

Fig. 11. Hydrogen tank level evolution with time.
 Source: Own elaboration.

salvage value at the end of the lifespan of the project, while the Energy Cost (COE) is 3.65 €/kWh. These results are obtained considering total Capital Expenditures (CAPEX) of € 75 856; Operation and Maintenance costs (OPEX) of € 634 per year and a Real Discount Rate of 6.72%.

Moreover, the project saves 919 kg/yr of carbon dioxide emissions and 3.40 kg/yr and 1.66 kg/yr of sulfur dioxide and nitrogen oxides emissions to the atmosphere, respectively.

4. Conclusions

Designed system shows that hydrogen can act as a feasible energy vector between a renewable solar energy source and a typical dwelling energy demand, both satisfying electrical and heating needs of the householders. Current

Table 1. Results summary of optimal sizing and operational values.

Source: Own elaboration.

Quantity	Value	Quantity	Value	Quantity	Value
PV power plants					
PV plant 1 rated capacity	8.00 kW	Mean power outputs	0.973/0.806 kW	Minimum power output	0/0 kW
PV plant 2 rated capacity	8.00 kW	Mean energy outputs	23.4/ 19.3 kWh/day	Maximum power output	6.71/5.98 kW
Operation	4 377/4 387 h/yr	Levelized Cost of Electricity	0.264 €/kWh	Overall system efficiency	14%
Electrolyzer					
Rated capacity	7.20 kW	Mean input	1.72 kW	Minimum input	0 kW
Max. output	7.20 kW	Energy input	15 087 kWh	Capacity Factor	23.9%
Operation	4 387 h/yr	Mean output	0.0255 kg/h	Min. output	0 kg/h
Max. output	0.107 kg/h	Total production	224 kg	Specific cons.	67.4 kWh/kg
Fuel cell					
Rated capacity	5.00 kW	Operation	8 760 h/yr	Operational life	6.85 yr
Capacity Factor	6.07%	Elec. production	2 657 kWh/yr	Mean elec. out.	0.303 kW
Min. elec. out.	0.0351 kW	Max. elec. out.	1.20 kW	Fuel cons.	190 kg/yr
Specific fuel consumption	0.0714 kg/kWh	Fuel energy input	6 327 kWh/yr	Mean electrical efficiency	42.0%
Hydrogen storage tank					
Tank capacity	55 kg	Energy storage	1 833 kWh	Tank autonomy	6 044 h
Content at beginning	5.50 kg	Content at end of year	39.5 kg	Levelized Cost of Hydrogen	35.2 €/kg

prices of solar photovoltaic modules make feasible to include more expensive components, such as electrolyzers and fuel cells, increasing competitiveness with electrochemical storage systems. Nevertheless, the main advantage of the proposed configuration lays in the possibility to interconnect energetic systems not only by the power grid, but also by gas grids at the time the final usable energy demand is satisfied with renewable energy sources in a larger amount. Furthermore, hydrogen-based technologies are increasing in recent years and several projects all around the world are working on vehicle applications as an alternative to pure electric vehicles, which reinforce the needs of integrating it in the building sector.

However, it has been observed that the cost of produced energy can result excessive at the time energy surpluses, both in the production of hydrogen and electricity are generated. It results remarkable the low efficiency of the complete system, as almost 4 kWh of produced PV energy are needed to satisfy 1 kWh of power load demand. Thus, it is proposed to test this configuration in larger communities where energy resources can be managed in an aggregated way with higher efficiency.

Further research lines in this topic must be conducted to optimal integrate hydrogen as energy vector with electrochemical storage systems, demand response and vehicle to home schemes.

References

- [1] Bracco S, Delfino F, Pampararo F, Robba M, Rossi M. A pilot facility for analysis and simulation of smart microgrids feeding smart buildings. *Renew Sustain Energy Rev* 2016;58:1247–55. <http://dx.doi.org/10.1016/j.rser.2015.12.225>.
- [2] Elsieid M, Ouakour A, Gualous H, Hassan R. Energy management and optimization in microgrid system based on green energy. *Energy* 2015;84:139–51. <http://dx.doi.org/10.1016/j.energy.2015.02.108>.
- [3] Obara S, Morel J. *Clean energy microgrids*, vol. 1. 1st ed. United Kingdom: IET - The institution of Engineering and Technology; 2017.
- [4] Abdi H, Beigvand SD, Scala ML. A review of optimal power flow studies applied to smart grids and microgrids. *Renew Sustain Energy Rev* 2017;71:742–66. <http://dx.doi.org/10.1016/j.rser.2016.12.102>.
- [5] Damm M, Lukic M, Mahlkecht S, Haase J, Grimm C, Malbasa V. Shifting of thermal and schedulable loads based on abstract cost profiles. In: 2012 3rd IEEE PES innovative smart grid technologies Europe; 2012 p. 1–8. <https://dx.doi.org/10.1109/ISGTEurope.2012.6465842>.
- [6] Albadi MH, El-Saadany EF. A summary of demand response in electricity markets. *Electr Power Syst Res* 2008;78:1989–96. <http://dx.doi.org/10.1016/j.epsr.2008.04.002>.

- [7] Allouhi A, El Fouih Y, Kousksou T, Jamil A, Zeraoui Y, Mourad Y. Energy consumption and efficiency in buildings: current status and future trends. *J Cleaner Prod* 2015;109:118–30. <http://dx.doi.org/10.1016/j.jclepro.2015.05.139>.
- [8] Kyriakarakos G, Piromalis DD, Arvanitis KG, Dounis AI, Papadakis G. On battery-less autonomous polygeneration microgrids: Investigation of the combined hybrid capacitors/hydrogen alternative. *Energy Convers Manage* 2015;91:405–15. <http://dx.doi.org/10.1016/j.enconman.2014.12.027>.
- [9] Bahceci S, Dogan A, Yalcinoz T, Daldaban F. Energy storage system location selection for smart grid applications on distribution networks. *Electr Eng* 2017;99:357–66. <http://dx.doi.org/10.1007/s00202-016-0416-z>.
- [10] Darby SJ. Smart electric storage heating and potential for residential demand response. *Energy Effic* 2018;11:67–77. <http://dx.doi.org/10.1007/s12053-017-9550-3>.
- [11] Wong S, Pinar J. Opportunities for smart electric thermal storage on electric grids with renewable energy. *IEEE Trans Smart Grid* 2017;8:1014–22. <http://dx.doi.org/10.1109/TSG.2016.2526636>.
- [12] Manzano-Agugliaro F, Montoya FG, Sabio-Ortega A, García-Cruz A. A review of bioclimatic architecture strategies for achieving thermal comfort. *Renew Sustain Energy Rev* 2015;49:736–55. <http://dx.doi.org/10.1016/j.rser.2015.04.095>.
- [13] Kuchroo P, Singh J, Sidhu E. Autonomous dynamic thermoelectric energy harvesting system for water heating purposes. In: 2016 International conference on automatic control and dynamic optimization techniques; 2016. p. 759–62. <https://dx.doi.org/10.1109/ICACDOT.2016.7877688>.
- [14] Diagramas Sankey del sector energético español n.d. 2019, https://www.comillas.edu/Documentos/BP/sankey_energy.html, [Accessed 31 August 2019].
- [15] Gutiérrez-Martín F, Guerrero-Hernández I. Balancing the grid loads by large scale integration of hydrogen technologies: The case of the Spanish power system. *Int J Hydrogen Energy* 2012;37:1151–61. <http://dx.doi.org/10.1016/j.ijhydene.2011.09.116>.
- [16] Glenk G, Reichelstein S. Economics of converting renewable power to hydrogen. *Nat Energy* 2019;4:216–22. <http://dx.doi.org/10.1038/s41560-019-0326-1>.
- [17] Kästel P, Gilroy-Scott B. Economics of pooling small local electricity prosumers—LCOE & self-consumption. *Renew Sustain Energy Rev* 2015;51:718–29. <http://dx.doi.org/10.1016/j.rser.2015.06.057>.
- [18] Guandalini G, Campanari S, Romano MC. Power-to-gas plants and gas turbines for improved wind energy dispatchability: Energy and economic assessment. *Appl Energy* 2015;147:117–30. <http://dx.doi.org/10.1016/j.apenergy.2015.02.055>.
- [19] Guinot B, Montignac F, Champel B, Vannucci D. Profitability of an electrolysis based hydrogen production plant providing grid balancing services. *Int J Hydrogen Energy* 2015;40:8778–87. <http://dx.doi.org/10.1016/j.ijhydene.2015.05.033>.
- [20] Qadrdan M, Abeysekera M, Chaudry M, Wu J, Jenkins N. Role of power-to-gas in an integrated gas and electricity system in Great Britain. *Int J Hydrogen Energy* 2015;40:5763–75. <http://dx.doi.org/10.1016/j.ijhydene.2015.03.004>.
- [21] Buchholz OS, van der Ham AGJ, Veneman R, Brilman DWF, Kersten SRA. Power-to-gas: Storing surplus electrical energy. A design study. *Energy Proced* 2014;63:7993–8009. <http://dx.doi.org/10.1016/j.egypro.2014.11.836>.
- [22] Götz M, Lefebvre J, Mörs F, McDaniel Koch A, Graf F, Bajohr S, et al. Renewable Power-to-Gas: A technological and economic review. *Renew Energy* 2016;85:1371–90. <http://dx.doi.org/10.1016/j.renene.2015.07.066>.
- [23] Garmsiri S, Rosen MA, Smith GR. Integration of wind energy, hydrogen and natural gas pipeline systems to meet community and transportation energy needs: A parametric study. *Sustainability* 2014;6:2506–26. <http://dx.doi.org/10.3390/su6052506>.
- [24] Santos DMF, Sequeira CAC, Figueiredo JL. Hydrogen production by alkaline water electrolysis. *Quim Nova* 2013;36:1176–93.
- [25] De Saint Jean M, Baurens P, Bouallou C, Couturier K. Economic assessment of a power-to-substitute-natural-gas process including high-temperature steam electrolysis. *Int J Hydrogen Energy* 2015;40:6487–500. <http://dx.doi.org/10.1016/j.ijhydene.2015.03.066>.
- [26] Gahleitner G. Hydrogen from renewable electricity: An international review of power-to-gas pilot plants for stationary applications. *Int J Hydrogen Energy* 2013;38:2039–61. <http://dx.doi.org/10.1016/j.ijhydene.2012.12.010>.
- [27] Slaughter G, Kulkarni T. Enzymatic glucose biofuel cell and its application. *J Bioeng Bioelectron* 2015;5. <http://dx.doi.org/10.4172/2153-0777.1000110>.
- [28] Staffell I, Scamman D, Abad AV, Balcombe P, Dodds PE, Ekins P, et al. The role of hydrogen and fuel cells in the global energy system. *Energy Environ Sci* 2019;12:463–91. <http://dx.doi.org/10.1039/C8EE01157E>.
- [29] Zakeri B, Syri S. Electrical energy storage systems: A comparative life cycle cost analysis. *Renew Sustain Energy Rev* 2015;42:569–96. <http://dx.doi.org/10.1016/j.rser.2014.10.011>.
- [30] Jülch V. Comparison of electricity storage options using levelized cost of storage (LCOS) method. *Appl Energy* 2016;183:1594–606. <http://dx.doi.org/10.1016/j.apenergy.2016.08.165>.
- [31] Kroniger D, Madlener R. Hydrogen storage for wind parks: A real options evaluation for an optimal investment in more flexibility. *Appl Energy* 2014;136:931–46. <http://dx.doi.org/10.1016/j.apenergy.2014.04.041>.