

Olabode, Oluwasanmi; Ojo, Temiloluwa; Oguntade, Tomiwa; Oduwole, Doyin

Article

Recovery potential of biopolymer (B-P) formulation from *Solanum tuberosum* (waste) starch for enhancing recovery from oil reservoirs

Energy Reports

Provided in Cooperation with:

Elsevier

Suggested Citation: Olabode, Oluwasanmi; Ojo, Temiloluwa; Oguntade, Tomiwa; Oduwole, Doyin (2020) : Recovery potential of biopolymer (B-P) formulation from *Solanum tuberosum* (waste) starch for enhancing recovery from oil reservoirs, Energy Reports, ISSN 2352-4847, Elsevier, Amsterdam, Vol. 6, pp. 1448-1455,
<https://doi.org/10.1016/j.egy.2020.05.027>

This Version is available at:

<https://hdl.handle.net/10419/244135>

Standard-Nutzungsbedingungen:

Die Dokumente auf EconStor dürfen zu eigenen wissenschaftlichen Zwecken und zum Privatgebrauch gespeichert und kopiert werden.

Sie dürfen die Dokumente nicht für öffentliche oder kommerzielle Zwecke vervielfältigen, öffentlich ausstellen, öffentlich zugänglich machen, vertreiben oder anderweitig nutzen.

Sofern die Verfasser die Dokumente unter Open-Content-Lizenzen (insbesondere CC-Lizenzen) zur Verfügung gestellt haben sollten, gelten abweichend von diesen Nutzungsbedingungen die in der dort genannten Lizenz gewährten Nutzungsrechte.

Terms of use:

Documents in EconStor may be saved and copied for your personal and scholarly purposes.

You are not to copy documents for public or commercial purposes, to exhibit the documents publicly, to make them publicly available on the internet, or to distribute or otherwise use the documents in public.

If the documents have been made available under an Open Content Licence (especially Creative Commons Licences), you may exercise further usage rights as specified in the indicated licence.



<https://creativecommons.org/licenses/by-nc-nd/4.0/>



Research paper

Recovery potential of biopolymer (B-P) formulation from Solanum tuberosum (waste) starch for enhancing recovery from oil reservoirs



Oluwasanmi Olabode*, Temiloluwa Ojo, Tomiwa Oguntade, Doyin Oduwole

Department of Petroleum Engineering, Covenant University, Ota, Nigeria

ARTICLE INFO

Article history:

Received 26 June 2019

Received in revised form 5 May 2020

Accepted 28 May 2020

Available online xxxx

Keywords:

Oil recovery

Biopolymer

Polymer flooding

ABSTRACT

Enhanced Oil Recovery (EOR) is a researching area targeted at mobilizing reservoir trapped oil. Several applications of EOR technology provides an added possibility to squeeze out more oil from the reservoir, perhaps about 20%. However, need for innovation in production at a cost effective method and environmentally friendly is required. Polymer flooding is one of the best EOR methods, and is primarily employed to increase oil recovery by sweep improvement.

The aim of this research work is primarily the designing of a specific biopolymer product with emphasis on polymer in-situ rheology and polymer flow performance examined in Enhanced oil recovery. This research involves the injection of potato peel (*Solanum tuberosum*) derived biopolymer solution at different concentrations by performing simultaneous experiments at ambient conditions using a reservoir permeability testing equipment (RPT). In this novel polymer formulation, *Solanum tuberosum* (waste) Starch (most abundant, naturally occurring biodegradable polymers) was hydrolyzed chemically.

Experimental results show that viscosity of B-P solution increases at every increment of polymer quantity reducing the mobility ratio. Several runs of flooding experiments were achieved the Reservoir permeability tester (RPT).

The incremental oil recoveries vary 52%, 60%, to 74% of original oil in place (OOIP) subject to the polymer concentration.

© 2020 The Authors. Published by Elsevier Ltd. This is an open access article under the CC BY license (<http://creativecommons.org/licenses/by/4.0/>).

1. Introduction

Drilling of new oil wells after abandonment of older ones seems not to be a remedial for increase in oil production. In fact, the oil amount gotten from new wells before chemical injection is about 20%–40% of the potential, and hence there is immobile 60%–80% oil trapped in the reservoir. Application of EOR technology contributes an extra chance to acquire about 5%–30% additional oil from the reservoir. Recently, [John et al. \(2017\)](#) identified that the need to recover more residual oil and also reduce damages and operational costs has led to the evolution of chemical enhanced oil recoveries because conventional secondary recoveries (mainly water and gas injection), gave recoveries that are low. Several oil flooding processes engaging the application of polymer solution has resulted in additional recoveries over the years reducing aqueous phase mobility and consequently causing improvement in sweep efficiency ([Abhijit Samanta, 2013](#)). [Ojo](#)

and [Fadairo \(2017\)](#) applied the use of a bio-surfactant from plant seed oil for oil recovery, the surfactant blend causes foam formation to displace oil from the pores by altering its affinity to the rock and influencing oil/brine interfacial tension.

[Sun et al. \(2017\)](#) reported that a number of other chemicals such as emulsion, biopolymers, foam and carbon dioxide activated silica gel, have the ability to increase the viscosity of water. Polymers particularly have the ability to lower mobility by reducing the relative permeability to water as well as increasing its viscosity (an index of mobility ratio improvement).

In many EOR projects around the world, Polymer flood has been confirmed to be technically and economically successful. [Wang and Dong \(2009\)](#) with increased recoveries of 12%–15%. [Wang et al. \(2002\)](#), [Wang and Dong \(2009\)](#)

[Clarke et al. \(2016\)](#) stated that the addition of polymer increases the viscosity of the aqueous phase, which reduces the mobility of the phase. The presence of polymer does not reduce residual oil saturation except few polymers.

Polymers derived from plant waste have proved to be a game player based on its role in improving sweep efficiency separately from synthetic polymers also the viscosity of polymer solutions is related to the molecular weight, polymer concentration, water salinity, temperature ([Ayoola, 2018](#)). Although the use of polymer

* Corresponding author.

E-mail addresses: oluwasanmi.olabode@covenantuniversity.edu.ng (O. Olabode), temiloluwa.ojo@covenantuniversity.edu.ng (T. Ojo), tomiwa.oguntade@covenantuniversity.edu.ng (T. Oguntade), doyinsolaoduwole@gmail.com (D. Oduwole).

Table 1
Characterization of core samples.

Samples	Diameter (cm)	Length (cm)	Dry Core weight (g)	Saturated Core weight (g)	Pore volume	Bulk volume (cm ³)	Porosity (%)	Permeability (mD)
Core A1	3.7	7	161.9	178.9	17	75.27	22.58	291.32
Core A2	3.7	7	151.1	171.8	20.7	75.27	26.7	293.1
Core A3	3.7	7	150.4	170.5	20.1	75.27	26.71	293.11

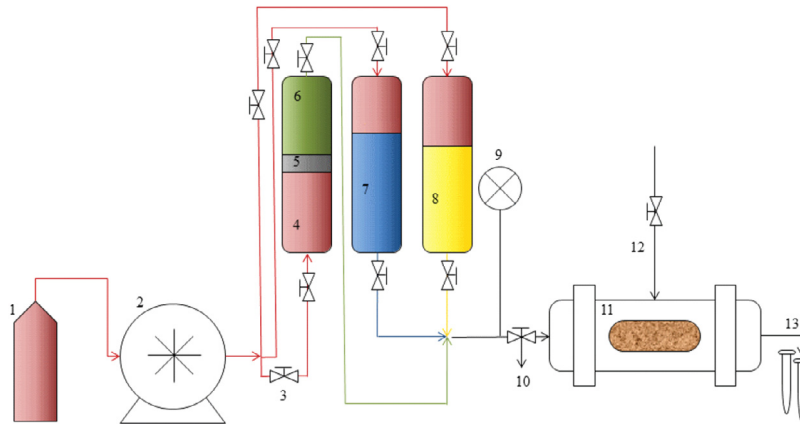

Fig. 1. Experimental core flood setup apparatus.

flooding as a chemical method has increased in oil reservoirs, the occurrence of high shear rates in reservoirs during polymer flooding easily results in degradation of polymers, decreasing their viscosity and overall oil recovery Cheraghian et al. (2014).

Due to the adsorption rates of polymers on reservoir rocks, an improvement on John et al. (2017) experiment can be obtained by initializing a design of experiment such as described by Olabode et al. (2018) to obtain a variety of Nano particle (bio or non-bio) polymer concentration for oil recovery purposes. Also, for proper and effective comparative analysis in measuring trends of oil recoveries based on recovery schemes, it is expedient to estimate oil recoveries from various methods of secondary injection schemes (Olabode, 2020) and compare with those of polymer injection. This experiment is done to ascertain the effectiveness of cheap bio polymers on oil recovery.

2. Experimental procedures

2.1. Materials

An overview of the laboratory experiments performed based on this work is discussed. Included in this overview is the description of the materials, apparatus used for generating result for this work. The success of this research required the use of these following materials in implementing the experimental procedure. The materials used are:

Core plugs, crude oil, Polymer (Bio-polymer derived from banana peels), Banana peels as raw material, Produced water (Brine), Acetone/Toluene and Chemical reagents (Sodium hydroxide, Hydrochloric acid and Plasticizer).

The equipment used for the experiment are:

Reservoir Permeability tester, Soxhlet extractor, Manual saturator, Pycnometer, Glass capillary viscometer, Desiccator.

2.2. Core flood (Reservoir Permeability Tester RPT)

Permeability is one crucial factor used in analyzing and obtaining a producing reservoir's flowing capabilities. This equipment comprises operating using a high temperature, high pressure test apparatus which gives an estimation and demonstration of

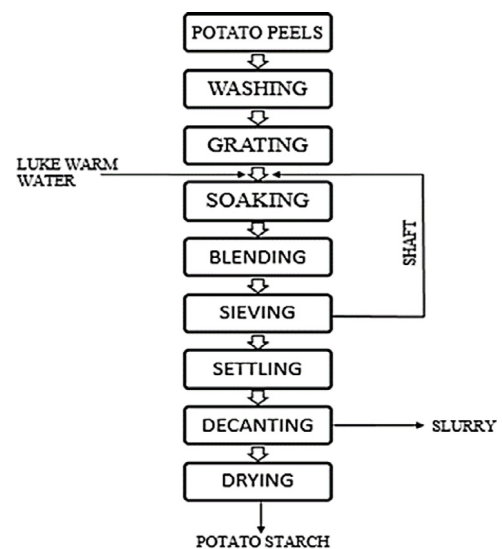

Fig. 2. Steps for bio-polymer production from waste.

measurements of individual reactions of reservoir core samples to the presence of oil, gas, acid and brine. The core flood setup has been designed to drive towards fulfilling the aim of the research's experimental procedure which is to improve residual oil recovery and enhance production, this is done by analyzing how the oil recovery tends to respond towards change in the permeability of the core as well as the polymer concentration. This setup comprises of three different compartments which are either filled up with crude oil, brine or the polymer solution. Fig. 2 describes the main RPT equipment used for this study.

Fig. 1 shows descriptive schematics of a permeability tester with the following Respective labeling: (1) Pump fluid, (2) Pump, (3) Valves, (4) Displacing reservoir fluid, (5) Isolating piston, (6) Crude oil, (7) Brine, (8) Bio-polymer, (9) Pressure gauge, (10) Bypass valve, (11) Hassler cell holder.

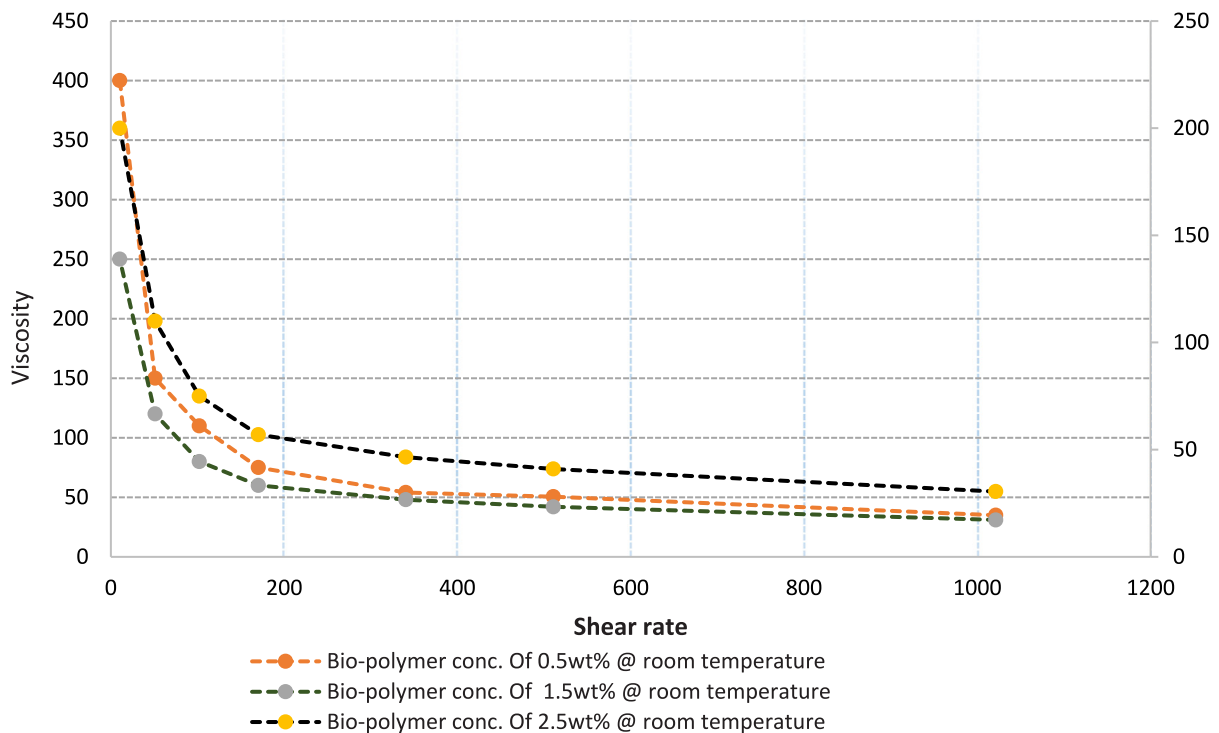

Fig. 3. Apparent viscosity and shear rate relationship @ 0.5wt%, 1.5wt%, 2.5wt% biopolymer.

Most of the data acquired for this experimental work was acquired through this equipment. The core flooding results are highlighted below in the result and discussion session.

2.3. Characterization of core samples

The cores were flooded with only water (single fluid) to discern the absolute permeability of the core plugs. Continuous Flooding process until complete saturation. This depicts steady state condition of fluid that flow through the core. Then permeability values were recorded for each core sample as stated in Table 1.

2.4. Bio-polymer preparation and rheological characterization

In this activity, a bio-polymer from **Solanum tuberosum** starch was formulated. **Solanum tuberosum** starch is a polymer made of long chains of glucose units joined together.

It actually contains two polymers:

- i. Amylose, which is a straight chain of glucose units
- ii. Amylopectin, which is a branched polymer, also made of glucose units.

The amylopectin prevents the starch from becoming plastic-like. Hydrochloric acid is used to break down the amylopectin and change the structure and properties of the polymer. The steps employed for the polymer formulation are described in Fig. 2.

2.5. Bio-polymer rheological studies

The viscosity measurement of each polymer solution highlights the rheological studies especially at various bio-polymer concentration. This rheological characterization for each concentration examination shows it demonstrates non-Newtonian behavior. The viscosity of the varied concentrations of the biopolymer in water was measured, with rheometer (DMA 850). The

Table 2

Oil recovery result generated for Core A1.

Concentration (wt%)	Time (mins)	% Recovery	Oil recovered (cc)
Water flooding	3	3.26	0.0326
	6	9.85	0.0985
	9	10.26	0.1026
	12	12.33	0.1233
	15	15.22	0.1522
	18	27.5	0.275
	21	30.63	0.3063
	24	32.15	0.3215
	27	35.72	0.3572
	30	35.72	0.3572
33	35.72	0.3572	
B-P@0.5wt%	36	37.2	0.372
	39	38.56	0.3856
	42	40.2	0.402
	45	40.2	0.402
	48	40.2	0.402
	51	40.2	0.402
B-P@1.5wt%	54	40.85	0.4085
	57	42.1	0.421
	60	42.1	0.421
	63	42.1	0.421
	66	48.43	0.4843
	69	48.43	0.4843
	72	48.43	0.4843
B-P@2.5wt%	75	49.43	0.4943
	78	50.43	0.5043
	81	51.43	0.5143
B-P@3.0wt%	84	52.43	0.5243
	87	52.43	0.5243
	90	52.43	0.5243

dial readings from the rheometer were obtained and the shear strain of the readings were calculated. The effect of polymer concentration on viscosity in Fig. 3, indicates a huge increase in the viscosity as individual shear rate increases.

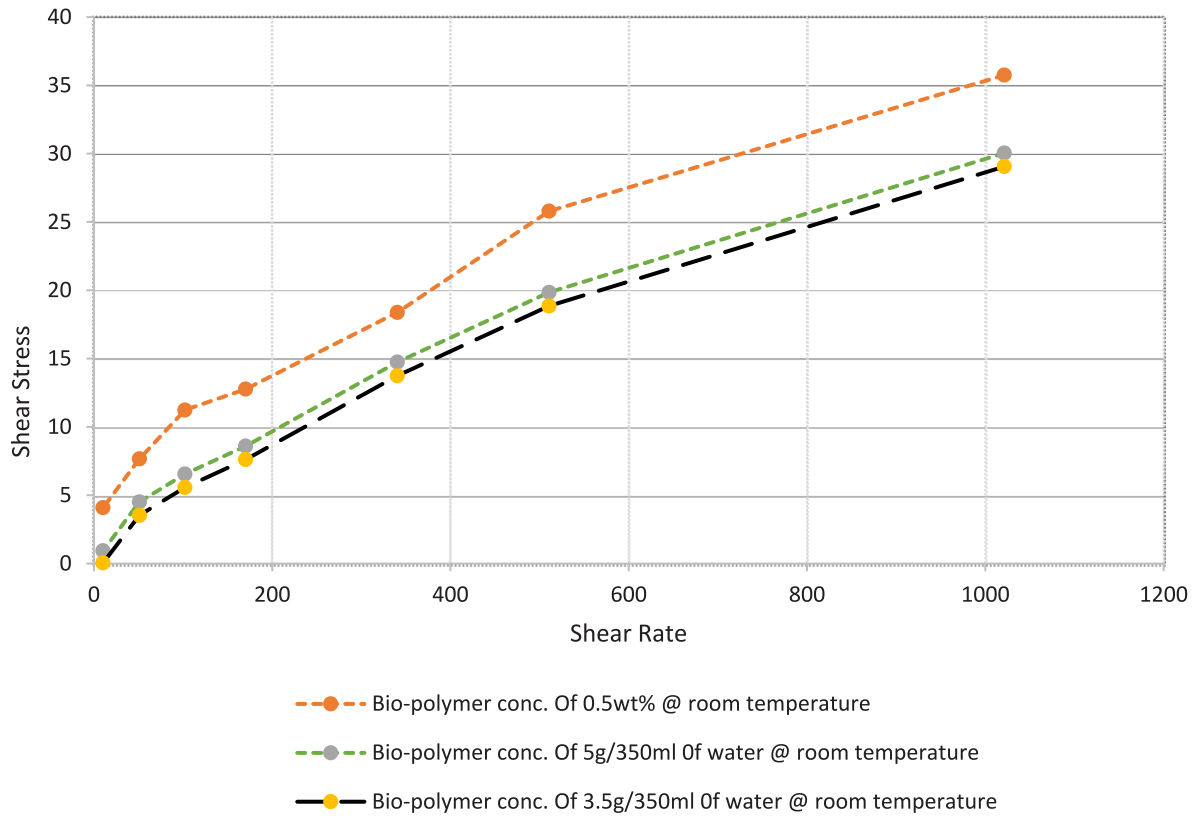

Fig. 4. Shear stress and shear rate relationship @ 0.5wt%, 1.5wt%, 2.5wt% bio-polymer.

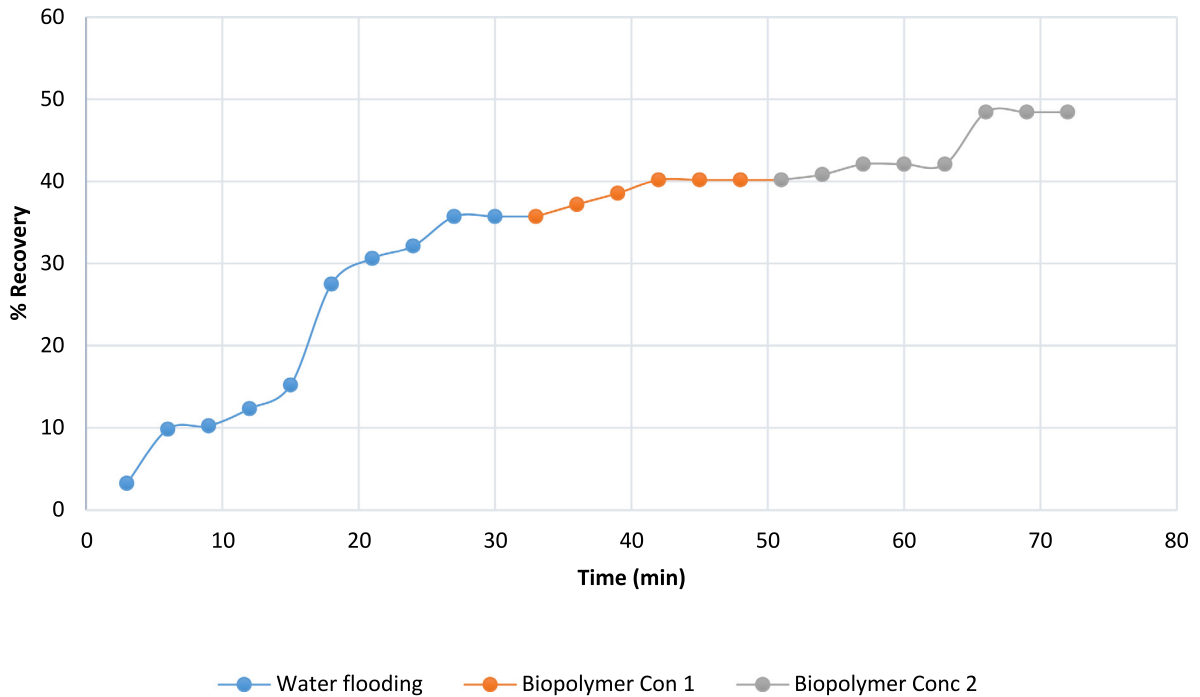

Fig. 5. Core A1 water and biopolymer flooding.

Presenting a correlation amid the shear rate and shear stress of this Biopolymer indicate two major deviations from Newtonian behavior, which are shear thinning and shear thickening as shown in Fig. 4. Shear thinning behavior of biopolymer is observed

when the flow curve passes through the origin. Fig. 3 shown that viscosity reduces with increasing shear rate, this illustration is sometimes referred to as thixotropy. The Biopolymer is seen to be a non-Newtonian fluid.

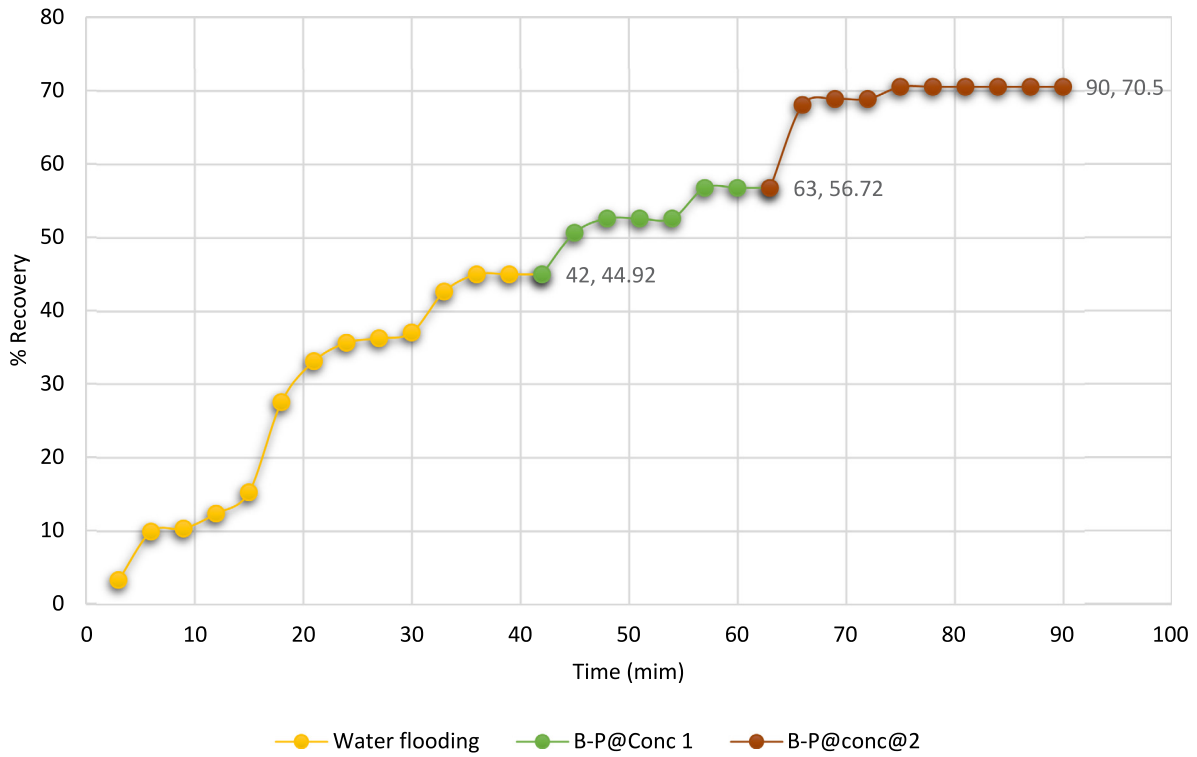

Fig. 6. Core A2 water and biopolymer flooding.

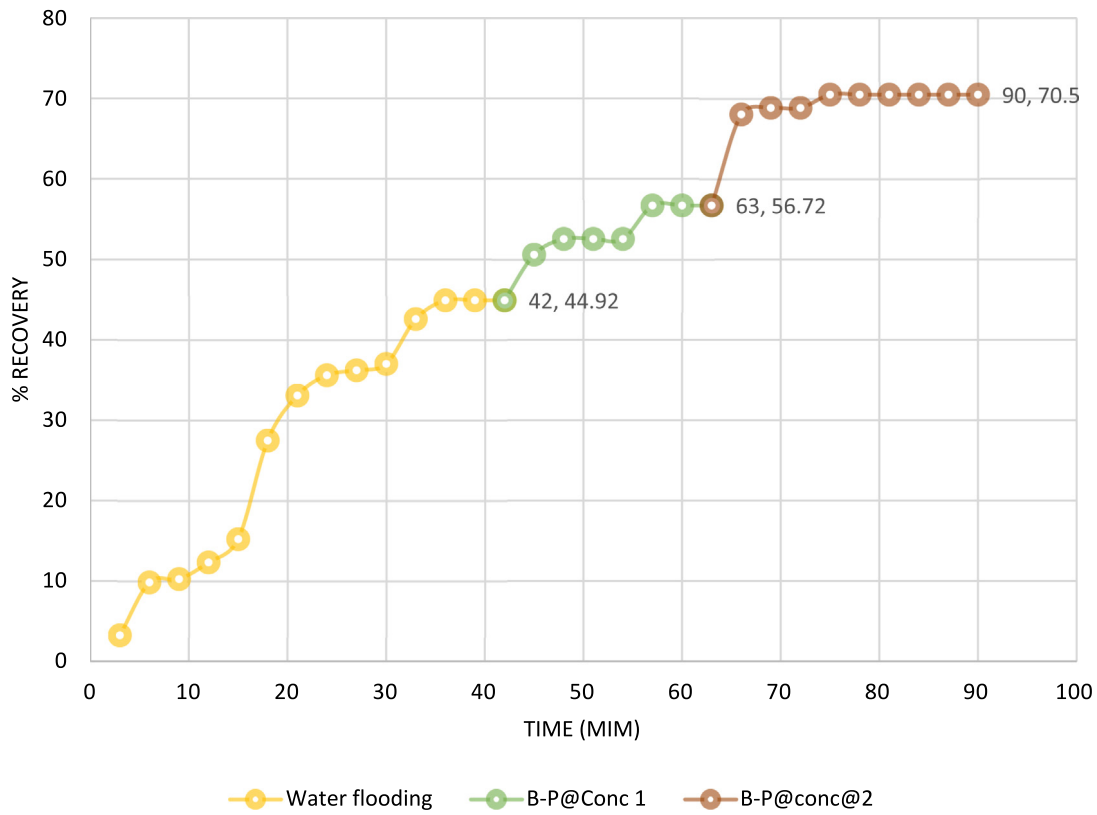

Fig. 7. Core A3 water and biopolymer flooding.

3. Results and conclusion

Flooding procedures on Core Sample (A1), (A2), (A3)

Core Sample (A1), (A2), (A3) were all subjected to secondary water flooding (brine injection). The Injection of brine was done at an injection rate of 1.5 cc/min measured from the Reservoir

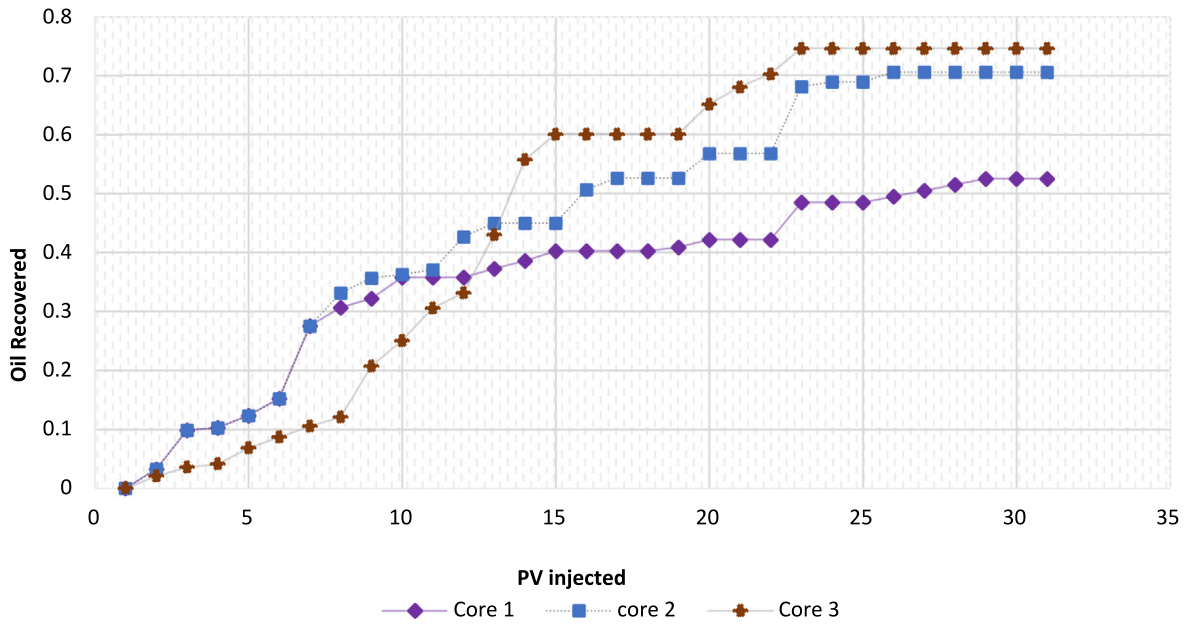

Fig. 8. Recovery against pore volumes injected.

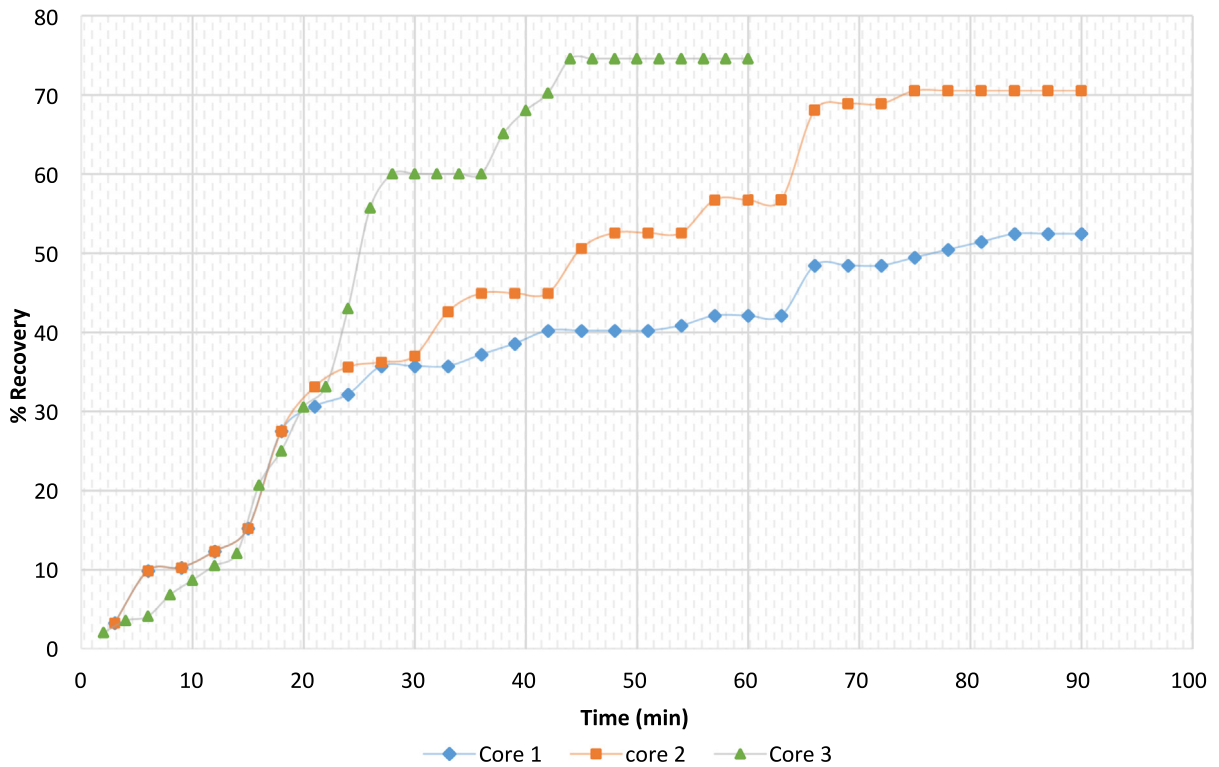

Fig. 9. Oil recovery performances of the injected polymer flooding recovery against time (Flooding analysis of Core Sample (A1), (A2), (A3)).

Permeability Tester (RPT), to mobilize oil and Obtain the residual oil saturation.

After the residual oil saturation has been attained, Imbibition process was conducted for up to 45 min. The confining pressure as observed from the RPT was up to 700 psi and 200 psi for the back pressure. Crude oil is collected in the separator.

Crude oil produced during injection period is monitored by taking note of the oil brine interface. Injection is carried out until crude oil is no longer produced (change in interface level)

The analysis here was observed after several flooding attempts of different concentrations of bio-polymer (0.5wt%, 1.5wt%, 2.5wt%) on each core samples.

Table 3
Oil recovery result generated for Core A2.

Concentration (wt%)	Time	% Recovery	Oil recovered	
Water flooding	3	3.26	0.0326	
	6	9.85	0.0985	
	9	10.26	0.1026	
	12	12.33	0.1233	
	15	15.22	0.1522	
	18	27.5	0.275	
	21	33.1	0.331	
	24	35.61	0.3561	
	27	36.22	0.3622	
	30	37.01	0.3701	
	33	42.6	0.426	
	B-P@0.5wt%	36	44.92	0.4492
		39	44.92	0.4492
42		44.92	0.4492	
45		50.6	0.506	
48		52.55	0.5255	
51		52.55	0.5255	
B-P@1.5wt%	54	52.55	0.5255	
	57	56.72	0.5672	
	60	56.72	0.5672	
	63	56.72	0.5672	
	66	68.03	0.6803	
	69	68.85	0.6885	
	72	68.85	0.6885	
	B-P@2.5wt%	75	70.5	0.705
78		70.5	0.705	
81		70.5	0.705	
B-P@3.0wt%	84	70.5	0.705	
	87	70.5	0.705	
	90	70.5	0.705	

- I. **Core A1**, at 0.5wt%, 1.5wt%, 2.5wt%, 3.0 wt% oil recovered against time were 40.2%, 48.4%, 51.4% and 52.4% respectively and each injection cycle was carried out until no additional crude oil was produce from the core.
- II. **Core A2**, at 0.5wt%, 1.5wt%, 2.5wt%, 3.0 wt% oil recovered against time were 52.55%, 68.85%, 70.5% and 70.5% respectively and each injection cycle was carried out until no additional crude oil was produce from the core.
- III. **For core**, at 0.5wt%, 1.5wt%, 2.5wt%, 3.0 wt% oil recovered against time were 60.0%, 68.8%, 74.5% and 74.5% respectively and each injection cycle was carried out until no additional crude oil was produce from the core.

Oil recovery after water flooding for core A1, A2 and A3 was 35.72%, 44.92% and 60% respectively. Figs. 5–7 shows the trend of incremental oil recovery results from water flooding to a (0.5% wt. and 1.5% wt.) biopolymer concentrations the core samples. However, due to viscous fingering, water by-passed some oil before bio-polymer was injected and was trapped in the core plug which an increment in concentration of polymer assisted its mobility. Meanwhile after the optimum concentration, at different pore volumes, and polymer flood could no longer be able to produce oil. This indicated a huge mobilization of the trapped oil after a contact of the first, second and third concentration of bio-polymer with the core sample. This totally brings and incremental recovery during each flooding process. The volume of oil produced is calculated in cc against time and against pore volumes injected. The result from water and biopolymer flooding for cores A1, A2 and A3 are recorded in Tables 2–4 while Fig. 8 compares the oil recoveries of the core samples after been subjected to different B-P concentrations. Also, oil recovery increased as the pore volume injected increased with time as shown in Fig. 9.

Table 4
Oil recovery result generated for Core A3.

Concentration (wt%)	Time (mins)	% Recovery	Oil recovered	
Water flooding	2	2.05	0.0205	
	4	3.55	0.0355	
	6	4.1	0.041	
	8	6.82	0.0682	
	10	8.66	0.0866	
	12	10.5	0.105	
	14	12.05	0.1205	
	16	20.68	0.2068	
	18	25	0.25	
	20	30.53	0.3053	
	22	33.1	0.331	
	24	42.96	0.4296	
B-P@0.5wt%	26	55.7	0.557	
	28	60	0.6	
	30	60	0.6	
	32	60	0.6	
	34	60	0.6	
	36	60	0.6	
B-P@1.5wt%	38	65.09	0.6509	
	40	68	0.68	
	42	70.2	0.702	
	44	74.55	0.7455	
	46	74.55	0.7455	
	48	74.55	0.7455	
	B-P@2.5wt%	50	74.55	0.7455
		52	74.55	0.7455
54		74.55	0.7455	
B-P@3.0wt%	56	74.55	0.7455	
	58	74.55	0.7455	
	60	74.55	0.7455	

4. Conclusion

Formulation of bio-polymer from *Solanum tuberosum* (waste) starch is a novel polymer for oil recovery processes which serve as a justifiable substitute to chemically synthesized polymers. Its ability to withstand high reservoir temperature (thermal stability), good rheological properties and mobility has demonstrated that the polymer can be successfully used for EOR applications.

5. Recommendation

Analysis of oil recovery from various biopolymers at different concentrations can be made by incorporating the rheological properties of the crude samples and biopolymer concentration in a reservoir simulator. The results can be compared with other simulation studies on the enhanced oil recovery schemes such as foam injection as described by Olabode et al. (2018).

Declaration of competing interest

The authors declare that they have no known competing financial interests or personal relationships that could have appeared to influence the work reported in this paper.

References

- Abhijit Samanta, K.O., 2013. Mobility control and enhanced oil recovery using partially hydrolysed polyacrylamide (PHPA). *Int. J. Oil Gas Coal Technol.*
- Ayoola, A.A.S.S., 2018. Production of a novel bio-polymer for enhanced oil recovery and modelling the polymer viscosity using artificial neural network (ANN). *Int. J. Mech. Eng. Technol.* 563–574.
- Cheraghian, Goshtasp, Nezhad, Seyyed Shahram Khalili, Kamari, Mosayyeb, Hematti, Mahmood, Mooshem, Masihi, Bazghi, Saeed, 2014. Adsorption polymer on reservoir rock and role of the nanoparticles, clay and SiO₂. *International Nano Letters* <http://dx.doi.org/10.1007/s40089-014-0114-7>.

- Clarke, Andrew, Howe, Andrew, Mitchell, Jonathan, Staniland, John, Hawkes, Lawrence, 2016. How viscoelastic-polymer flooding enhances displacement efficiency. *SPE Journal* SPE-174654-PA.
- John, Felix, Olabode, Oluwasanmi, Ojo, Temiloluwa, Egeonu, Gerald, 2017. Enhanced oil recovery of medium crude oil (310 api) using nanoparticles and polymer. *Int. J. Appl. Eng. Res.* 8425–8435.
- Ojo, T.I., Fadairo, A., 2017. Effect of jatropha bio-surfactant on residual oil during enhanced oil. *Int. J. Appl. Eng. Res.* 10036–10042.
- Olabode, Oluwasanmi, 2020. Effect of water and gas injection schemes on synthetic oil rim models. *Journal of Petroleum exploration and Production Technology* 19, <http://dx.doi.org/10.1007/s13202-020-00850-3>.
- Olabode, Oluwasanmi, Orodu, Oyinkepreye, Isehunwa, Sunday, Rotimi, Tosin, Mamudu, Angela, 2018. Effect of foam and WAG (water alternating gas) injection on performance of thin oil rim reservoirs. *Journal of Petroleum Science and Engineering* 20, 234–241. <http://dx.doi.org/10.1016/j.dib.2018.07.071>.
- Olabode, Oluwasanmi, et al., 2018. Production Forecast for Niger Delta Oil Rim Synthetic Reservoirs. *Data in brief* 19, <http://dx.doi.org/10.1016/j.dib.2018.06.115>.
- Sun, Xiaofie, Zhang, Yanyu, Chen, Guangpeng, Gai, Zhiyong, 2017. Application of nanoparticles in enhanced oil recovery: a critical review of recent progress. *Energies* 10, <http://dx.doi.org/10.3390/en10030345>.
- Wang, D., Cheng, J., Wang, G., Wu, J., 2002. Experiences learned after production of more than 300 million barrels of oil by polymer flooding in daqing oil field. In: *SPE Annual Technical Conference and Exhibition*. Society of Petroleum Engineers, San Antonio, Texas, p. 10.
- Wang, J., Dong, M., 2009. Simulation of o/w emulsion flow in alkaline/surfactant flood for heavy oil recovery. In: *Canadian International Petroleum Conference*. Petroleum Society of Canada, Calgary, Alberta, p. 13.