

Rosen, Sherwin; Rosenfield, Andy

Working Paper
Ticket Pricing

Working Paper, No. 120

Provided in Cooperation with:

George J. Stigler Center for the Study of the Economy and the State, The University of Chicago
Booth School of Business

Suggested Citation: Rosen, Sherwin; Rosenfield, Andy (1995) : Ticket Pricing, Working Paper, No. 120, The University of Chicago, Center for the Study of the Economy and the State, Chicago, IL

This Version is available at:

<https://hdl.handle.net/10419/262522>

Standard-Nutzungsbedingungen:

Die Dokumente auf EconStor dürfen zu eigenen wissenschaftlichen Zwecken und zum Privatgebrauch gespeichert und kopiert werden.

Sie dürfen die Dokumente nicht für öffentliche oder kommerzielle Zwecke vervielfältigen, öffentlich ausstellen, öffentlich zugänglich machen, vertreiben oder anderweitig nutzen.

Sofern die Verfasser die Dokumente unter Open-Content-Lizenzen (insbesondere CC-Lizenzen) zur Verfügung gestellt haben sollten, gelten abweichend von diesen Nutzungsbedingungen die in der dort genannten Lizenz gewährten Nutzungsrechte.

Terms of use:

Documents in EconStor may be saved and copied for your personal and scholarly purposes.

You are not to copy documents for public or commercial purposes, to exhibit the documents publicly, to make them publicly available on the internet, or to distribute or otherwise use the documents in public.

If the documents have been made available under an Open Content Licence (especially Creative Commons Licences), you may exercise further usage rights as specified in the indicated licence.

Working Paper No. 120

Ticket Pricing

Sherwin Rosen
Andy Rosenfield

George J. Stigler Center
for the Study of
the Economy and the State

The University of Chicago

WORKING PAPER SERIES NO. 120

Ticket Pricing

**Sherwin Rosen
Andy Rosenfield**

September 18, 1995

George J. Stigler Center
for the Study of the Economy and the State
The University of Chicago
1101 East 58th Street
Chicago, Illinois 60637

Center papers are distributed in limited numbers
for comments only and should not be
quoted without written permission.

Abstract

We analyze several forms of price discrimination in ticket sales when aggregate demand is known and individual preferences are private information. The problem has both monopolist and competitive elements because the optimal policy always can be implemented by a competitive auction market for those seats the seller makes available. Serving customers with less intense demand creates substitution opportunities across classes that limit the seller's ability to extract surplus from buyers with the largest demand intensities. Discrimination is greatest in the class of service with the largest variance in demand prices among all potential buyers. The seller's incentives to change the quality of service classes to limit substitution, and the pricing of complementary goods on the premises to effect a greater degree of price discrimination also are analyzed. The need to compare "marginal" and "average" customers in these two problems has many interesting parallels with the analysis of public goods. Finally, when capacity limitations require sequential servicing of buyers in "batches" (e.g., for theatrical productions) intertemporal price discrimination requires prices to slowly decline over time, so that customers with the greatest demand intensities buy higher priced tickets to earlier performances rather than wait for later performances. Under some circumstances the optimal policy requires constant prices over time and nonprice rationing.

JEL: D4

Key Words: Price Discrimination, Ticket Prices, Monopoly, Pricing Complementary Goods

Sept 18, 1995

TICKET PRICING

Sherwin Rosen and Andy Rosenfield¹

I. Introduction and Summary

The pricing of tickets is an inexhaustible source of interesting microeconomic problems. What sets it apart is an inherent indivisibility---a capacity constraint---in the production technology. Once the service has been set up (the airplane, concert hall, sports facility, or theater), the marginal cost of another customer is much smaller than average cost unless capacity is full. We analyze how a seller rationally exploits price distinctions on seat quality, class of service, or the timing of purchase in the optimal utilization of capacity. This problem has natural similarities to the use of two-part pricing in decreasing cost industries, but it contains important competitive market elements. In many ways, what appears to be price discrimination either across seat quality or intertemporally, is what a competitive auction market would achieve for the seats the seller makes available.

It is useful to distinguish two cases, one where demand is contemporaneous with production and another where production occurs in batches and customers are queued and served in groups of limited size until all demand is satisfied. These correspond to spatial and intertemporal aspects of seat allocation and pricing. Examples of the first kind include the allocation of seats on an airplane or train of fixed size on a particular route, or the sale of tickets to a unique concert or sporting event. In such problems manipulating prices of different classes of service (first and second class; box seats and bleachers; court side or third balcony) enables the seller to extract the most profit. Indeed, if such "discrimination" wasn't practiced at the box office, it would be effected by resale and "scalping" in a competitive secondary market. An example of the second kind is a theatrical production, where theater size constraints generate backlogs of customers who must be served sequentially through repeat performances. Here the seller exploits distinctions in the timing of purchase rather than the quality of seat. Nonetheless, the two problems are closely related.

Following established traditions, analysis is confined to the standard economic specification

¹University of Chicago and Lexecon, Chicago, IL, respectively.

of preferences. Reservation prices are assumed to be strictly private and personal subjective values, defined independently of other people's preferences or purchases and the timing of purchase. There are no fads, fashions or addictions. We show that the more ardent customers pay more and purchase seats of superior quality or attend earlier performances. Serving less ardent customers affects the seller's ability to discriminate against the more ardent buyers, because it opens up possibilities for the most eager customers to purchase the bargains necessary to attract the less eager. In the seller's optimal pricing policy, the most ardent buyers always are left with the largest consumer surplus from purchasing. The least ardent buyers are left with minimal surplus.

The next section considers pricing different classes of service, one of the classic problems in the theory of price discrimination [Dupuit(1844), Hotelling(1931)]. It illustrates the basic sorting of customers to service class in the simplest way. A number of results are obtained:

- If demand is so large that capacity is full, the seller's optimal pricing policy is equivalent to a competitive auction market for seats. If capacity is sufficiently large prices are set above the marginal cost of a seat and some seats are left vacant.
- There is a sense in which the seller discriminates more against the buyers of the service for which the variance of customers' valuations is largest. Under plausible circumstances this turns out to be the first class seats, though greater discrimination against second class service is a real possibility, depending on the distribution of tastes in the population..
- The seller has incentives to alter quality differences between classes of service, to deter substitution and increase the first-class price premium. Sometimes this reduces second-class seat quality to much lower level, and sometimes it increases first-class seat quality to unusually luxurious accommodations.
- It usually pays to manipulate prices of complementary goods sold on the premises (e.g. food and drinks) to achieve a higher degree of price discrimination when all tickets must be offered on the same terms to all potential buyers. The price of complements is set above marginal cost and ticket prices lowered when the average ticket buyer consumes more complementary goods than the marginal ticket buyer. Complements are subsidized (sold below cost) and ticket prices are raised when marginal ticket buyers are more ardent

consumers of complements than the average ticket buyer.

Section II treats the case where the measure of heterogeneity in consumer preferences exceeds the number of service classes. It also considers the determination of seat quality and the pricing of complementary goods. Section III extends the analysis in the other direction, when the measure of inherent variation in seat quality is very large. The spatial aspects of the problem are precise in this case. Equilibrium prices are convex in seat quality: the highest quality seats sell for proportionately more than lower quality seats.

Section IV deals with intertemporal pricing and ticket allocations in a batch processor. If customers are impatient and the interest rate is smaller than the rate of time preference, the equilibrium solution generally requires that prices fall over time to expedite a kind of price discrimination, inducing those with the greatest reserve prices to buy expensive tickets to earlier performances. One might think that prices would have to fall over time, to, in effect, pay customers for waiting and buying tickets to later production. However, if customers have the same reserve spot prices for tickets, the seller shuts down the implicit waiting market. A constant price policy is maintained over the length of the run and tickets are rationed by queue or other nonprice means, irrespective of the distribution of rates of time preference among buyers.

Section V briefly discusses uncertainty and more general specifications of preferences involving group externalities. When the seller takes account of resale and demand is known, all scalping opportunities are eliminated. Hence scalping either requires uncertainty of demand or a different specification of preferences.

II. Class of Service Pricing

1. The Basic Argument

To set ideas, consider a facility of fixed size with two kinds of seats, high quality or first class, H, and low quality or second class, L. The number of seats of each type is n_h and n_l . The analysis in this section is timeless in the sense that customer arrivals are geared to specific services and they are served on the spot. Buyers do not choose the timing of purchase--it is all or nothing. This is true of many single event entertainments such as concerts with specific performers, prizefights, and the like, and to a lesser extent of continuously repeated production, such as daily airplane or train rides between two cities, where seats are differentiated by class of service. Each type of service quality is known and similarly perceived by all potential customers. All prefer first to second class service though individual willingness to pay for either type of ticket may vary among customers. Let r_h and r_l be the reserve prices of a person for a seat of quality H or L.

The seller knows that demand prices are distributed according to frequency $f(r_h, r_l)$, but cannot identify the demand prices of specific buyers. Prices must be set in advance and posted on equal terms to all buyers irrespective of type. The seller chooses prices of each class of service to maximize total revenue, knowing how buyers of each type make their choices given the prices they are offered. It is implicit in what follows that the seller takes account of possible resale opportunities each pricing policy presents to buyers. We assume the seller is selfish and ex ante does not allow others to gain financially from resale.

If p_h and p_l are the prices charged for each kind of seat, a buyer with a specific value of (r_h, r_l) chooses to purchase a ticket if either $r_h - p_h > 0$ or $r_l - p_l > 0$. When surplus is nonnegative and a ticket is bought, the person chooses service class H or L according to

$$(1) \quad \max \{r_h - p_h, r_l - p_l\}$$

From equation (1), a price policy (p_h, p_l) partitions the (r_h, r_l) plane into the three regions shown in figure 1. All people whose reserve prices are less than p_h and p_l do not purchase. Those whose reserve prices fall in the region marked H purchase a first class ticket, and those in the region marked

L purchase a second class ticket.

Figure 2 shows how changing the prices of each ticket type affects the partition of customers in the three regions. If p_h is increased to p'_h and p_l is held constant, some people who previously purchased a high quality seat decide not to attend (those whose reserve prices fall in the area marked 1 of figure 2). Others, whose reserve prices for low quality service are high enough, switch to second class service instead (those in area marked 2). If p_l is increased to p'_l and p_h is held constant, some people who previously bought a low quality ticket choose not to attend (area marked 3); and other

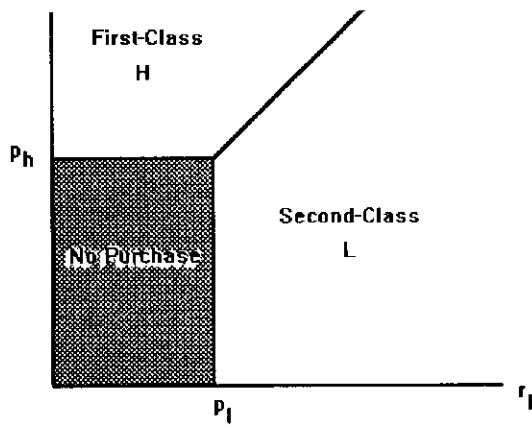

Figure 1

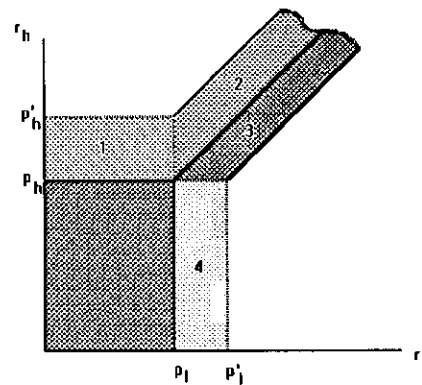

Figure 2

low quality ticket buyers switch to a higher quality seat (area marked 4). The seller's problem is to partition the reservation price distribution to maximize revenue, subject to seat capacity constraints of each service type. The basic solution is most easily illustrated in the case where there are only a few types. It is trivial when there is only one type of buyer, for then the frequency distribution degenerates to a point mass in the (r_h, r_l) plane, say (r_{1h}, r_{1l}) , the monopolist sets $p_h = r_{1h}$ and $p_l = r_{1l}$, and extracts all surplus. Both kinds of seats are rationed by availability and prices are so high that buyers are indifferent as to whether or not they attend.

The problem is more interesting with two types of potential customers. Suppose there are also type 2 buyers located at point (r_{2h}, r_{2l}) in figure 3, with the second type less willing to pay for either class of service. The seller must decide whether to lower prices sufficiently to induce the less ardent types to purchase. Notice that the interesting price strategies are limited to only a few possibilities.

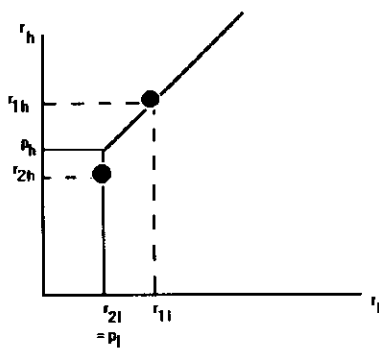

Figure 3

One is to maintain the prices at (r_{1h}, r_{1l}) as before. At those prices type 2 buyers choose not to attend, the seller serves only type 1 buyers, and extracts all of their surplus. This is the optimal policy if there are enough members of type 1 relative to seat capacity. It may imply some empty seats in each class, though it is never optimal to leave an H seat empty if all L seats are filled.

If there are not enough type 1 buyers to fill up the seats and the seller wants to serve type 2 customers,

the price of second class service must be reduced to r_{2l} or less. However, if p_h is maintained at its previous price of p_{1h} , all type 1 buyers would fall into area 3 in figure 2 and none would be willing to purchase a high quality seat. High quality seats would be unsold. This is why catering to type 2 buyers affects the terms on which tickets can be sold to type 1 buyers. As usual, the cross elasticity of demand plays an important role in the optimal policy. To insure that type 1 buyers continue to purchase the better seats while simultaneously inducing type 2 customers to enter the market, the seller must reduce the price of both the high and low quality tickets.

Figure 3 depicts the revenue maximizing policy that caters to both types. All rent is extracted from type 2 buyers, who strictly prefer the low quality seats. Type 1 customers are indifferent between high and low quality seats, but get an equal amount of surplus from either kind. It is impossible to fully extract surplus from type 1 buyers if type 2 buyers are to be served: type 1 customers are willing to pay more than the quoted price for any seat they buy. The seller chooses to sell to both types if the number of enthusiastic buyers is small relative to capacity and there are lots of cheap seats and many less enthusiastic buyers.

Surprisingly, the seller's optimum policy does not always induce persons with the highest valuations to purchase the best seats, as in figure 3. Differences in the marginal willingness to pay for H and L between types determine this. Figure 4 differs from figure 3 in that differences between types in the willingness to pay for H are relatively small and differences in the willingness to pay for L are large. Serving type 2 buyers now requires that they occupy the best seats and that type 1

customers occupy L (some might also purchase H as well). This example illustrates a well known point in the economics of selection, that the relative variances in value among service qualities, as well as valuation levels, affect pricing policy. In figure 4 all surplus is extracted from customers with the lowest valuations though they occupy the best seats, not the worst. High valuation customers still pay less than their reserve prices, in spite of the fact that some of them are sitting in low quality seats.

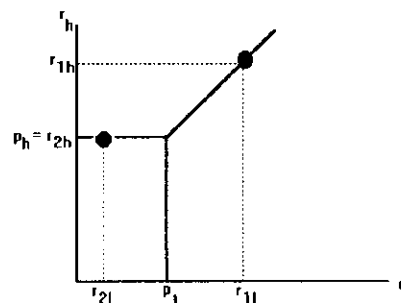

Figure 4

A. Where is monopoly power greatest?

Generalizing to a large set of customer types compared to classes of service, superimpose the contour map of the frequency function $f(r_h, r_l)$ on the partition of figure 1, and compute the demand functions for each class as the integrals of $f(r_h, r_l)$ over the indicated regions². Denote these demand functions by $N_h(P_h, P_l)$ and $N_l(P_h, P_l)$. Figure 2 reveals that the own effects of changing prices decompose into two components. Some customers leave the market entirely (areas 1 or 4), and others switch from one class to the other (areas 2 or 3). The cross demand effects consist only of switchers and are symmetrical across the two classes, so $\partial N_h / \partial P_l = \partial N_l / \partial P_h$. Writing U_h and U_l for the leavers component of the own price effects in each class (the integrals over regions 1 or 4), it follows that $U_h = \partial N_h / \partial P_h + \partial N_l / \partial P_h$ and $U_l = \partial N_l / \partial P_l + \partial N_h / \partial P_l$ (see appendix). Since fixed capacity constraints make measuring monopoly power ambiguous, we can lend more precision by answering the following question. If the venue could be reconfigured at cost $C(N_h, N_l)$ with marginal costs C_h and C_l both nonnegative, what is the optimal configuration of classes, given demand conditions $f(\cdot)$?

The problem is to maximize net revenue $P_h N_h + P_l N_l - C(N_h, N_l)$ subject to the demand

² Note the family resemblance of this image to bundling problems, Adams and Yellin(1977), Schmalensee(1981), McAfee, et. al. (1989). Here the customer is presented with a variety of choices and buys at most one of them, never a bundle.

functions implied by f. The first order conditions are

$$(2) \quad (P_h - C_h)\partial N_h/\partial P_i + (P_l - C_l)\partial N_l/\partial P_i = N_i \quad \text{for } i = h, l$$

Second order conditions require $\Delta = (\partial N_h/\partial P_h)(\partial N_l/\partial P_l) - (\partial N_h/\partial P_l)(\partial N_l/\partial P_h) > 0$. Solve the pair of equations in (2) for $(P_h - C_h)$ and $(P_l - C_l)$, use the restrictions above and rearrange terms to obtain,

$$(3) \quad (P_h - C_h) - (P_l - C_l) = [(U_l/N_l) - (U_h/N_h)] \cdot N_h N_l / \Delta$$

The terms U_l/N_l and U_h/N_h are the fractions of class L and H consumers who leave the market rather than switch to the other class when their own prices rise. Measured by the price/cost spread, greater monopoly power is exercised in the class where relatively fewer customers drop out of the market, where more are in a sense “trapped” by preferring to switch to another class of service rather than not participate at all.

This result is also related to the relative variances in reserve prices. Figure 5 shows two potential distributions of preferences with positive covariance. In the one marked A, the variance in preferences for first class is greater than the variance for second class: marginal buyers of first class seats are more likely to switch to second class rather than not purchase anything when P_h rises. The difference between price and marginal

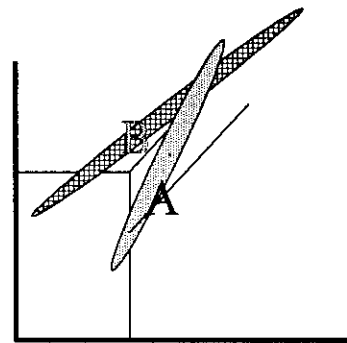

Figure 5

cost is greater in H than in L in such a case. For distribution B, the marginal second class buyers are less likely to cease purchasing. Now these second-class buyers are trapped and the price-marginal

cost spread is larger for them³.

2. The Configuration of Service Classes

How would the seller invest up front in such things as fancy accommodations and other nonpecuniary conditions to change the quality of each type of service? Dupuit (1844) thought that railroad companies of his day took drastic actions to widen quality differences between classes of service in order to deter the rich from buying cheaper tickets. He claimed that third class passenger rail service was excessively uncomfortable, crowded, and dirty, and that the quality of first class services was excessively plush, uncrowded, and comfortable, so that rich customers would be scared off from buying cheaper tickets. "...having deprived the poor of what is necessary, first class customers are given what is superfluous" [quoted in Ecklund (1970)]. Louis Phlips (1985) quotes Walras to the same effect. Extravagant differences between steerage and first class accommodations on ocean liners (airplanes?), boxes and standing room tickets at the opera, skyboxes and bleachers at ball games and many other examples illustrate the idea.

It is intuitively clear that the seller gains by widening quality differences, reducing substitution between classes, and charging higher prices to those who are willing to pay the most. Modern results in standard production models [Mussa and Rosen (1978), Phlips (1985)] conclude that it is optimal to produce the socially efficient qualities for customers with the greatest willingness to pay, but to reduce the qualities offered (relative to efficient levels) to lower valued customers. Things are more complicated here.

A. One class of service

There is an essential public goods aspect of this problem that is best illustrated when there is only one class service. Whether or not the seller sets the quality of service at the socially efficient level in this case depends on comparing differences in preferences for quality between the average and marginal consumer. The seller caters to the marginal customer's preferences for quality,

³ A one-factor representation of preferences is analyzed in the appendix. The underlying factor is the intensity of taste for the primary service, different factor loadings in each class map tastes into different reserve prices, "trapping" is extreme and the problem is fully recursive. The seller chooses the price spread between classes to get the optimal partition of customers and then chooses the level of price to set the extensive margin.

whereas the efficient quality level caters to the average customer's preferences. Quality is inefficient to the extent that the average and marginal customers have different tastes.

Consider a venue with capacity N' . Let r be the maximum price a person is willing to pay for a seat of quality q . Given q , r is distributed as $f(r, q)$, with cumulative distribution $F(r, q)$. Higher quality is preferred, in the sense that no one would be willing to pay less and most would pay more, so $F(r, q_0) \geq F(r, q_1)$ if $q_1 > q_0$. The seller incurs cost $c(q)$ per occupied seat to change quality, with $c'(q) > 0$. Demand for tickets of quality q is $N = \int_p f(r, q) dr$, the seller's profit is $\int_p (P - c(q)) f(r, q) dr$, and is constrained by capacity, $N \leq N'$. Let λ be the multiplier on the capacity constraint. Assuming that the problem is concave, the seller chooses P and q to satisfy

$$(4) \quad \begin{aligned} N - f(P, q)[P - c(q) + \lambda] &= 0 \\ -c'(q)N(p, q) + \int_p f_q(r, q) dr [P - c(q) + \lambda] &= 0 \end{aligned}$$

with $\lambda = 0$ if $N' > N$. Eliminating λ , the choice of quality satisfies

$$(5) \quad c'(q) = \int_p f_q(r, q) dr / f(P, q) = -(\partial N / \partial q) / (\partial N / \partial P) = dP / dq$$

where the second and third equalities follow from totally differentiating the demand function. Equation (5) indicates that the marginal benefit of quality to the seller is the equilibrium size of the audience times the amount the marginal customer is willing to pay for an increment of quality.

By contrast, the socially efficient quality levels maximize consumer surplus $\int_{r^*} [r - c(q)] f(r, q) dr$, where r^* is defined by $\int_{r^*} f(r, q) dr = N'$. Letting λ' be the multiplier on the constraint, the first order conditions are

$$(6) \quad \begin{aligned} -[r^* - c(q) - \lambda'] f(r^*, q) &= 0 \\ -c'(q)N(p, q) + \int_{r^*} [r - c(q) - \lambda'] f_q(r, q) dr &= 0 \end{aligned}$$

The social value of marginal customers [$\lambda' f(r^*, q)$ in the first equation in (6)] is the consumer surplus of the lowest valued customer who attends. The private value of marginal customers [$\lambda f(P, q)$ in the first equation in (4)] is the marginal revenue to the seller---the consumer surplus of marginal customers adjusted for the loss of revenue on inframarginal customers from lowering the price. Combining expressions in (6), the socially optimum quality solves

$$(7) \quad c'(q) = \int_{r^*} (r - r^*) f_q(r, q) dr \div \int_{r^*} f(r, q) dr.$$

The numerator in (7) is the increased consumer surplus of greater quality. The denominator is the number of customers, so the right hand side is the average consumer surplus, the average amount customers who attend are willing to pay for an increment of quality. For the private calculation it is the marginal willingness to pay that determines quality. Quality is greater or less than the socially efficient level as average willingness to pay exceeds or falls short of marginal willingness to pay.⁴

An interesting application for the entertainment industry is the choice of repertoire in “high” culture productions. Greater market size always is more profitable to the seller (see Rosen(1981)). Popular arts have much larger markets than the classical arts because they are less costly to the buyer in terms of prior investments, exposure and so forth. However, within the classical music arts, it is well known that the performed repertoire is highly concentrated on certain works of remarkably few composers. If the marginal customer is more likely to be attracted by the familiar than the average customer, observed performances may have less variance over the entire repertory than is socially efficient.

⁴ It is not possible to make general statements about whether quality is higher or lower than the efficient level without further structure. Nonetheless, this formulation helps clarify a confusing literature on such questions. The result of Swan (1970) and Sieper and Swan (1973) that a monopolist chooses the socially efficient durability of a reproducible good is true when the average and marginal willingness to pay for nonprice replacement costs are equal for all buyers. If these costs (value of time and installation for durable goods) differ among customers, the marginal and average customers differ and durability is inefficiently provided. There is no general presumption that actual durability exceeds or falls short of the efficient level. Of course one expect several durabilities to arise, to cater to different types of consumers in this case. Our “public good” analysis has certain formal similarities to the recent treatment of advertising by Becker and Murphy (1993).

B. Two classes of service

The important idea in the previous section, that sellers cater to their marginal customers whereas efficient choices would cater to “representative” customers carries over to multiple service classes. Like other bundling problems, few generalizations about the direction of differences between privately and socially optimum choices are available. However, we illustrate the basis of Dupuit’s intuition on the widening of service quality, by analyzing preference distributions of the form depicted in figure 5, where preferences for service classes are reasonably well ordered.

With such preferences customers with the most intense preferences would rather switch to the other class rather than not purchase anything when prices of their most preferred seat increases. They are “captive” or trapped in the sense discussed above. The seller wants to charge them more and deter substitution to the other class by widening the interclass difference in quality. For preference distribution A in figure 5, where the variance in r_h exceeds the variance in r_l , these forces tend to reduce the quality of second class service. However, for preference distribution B in figure 5 they tend to reduce the quality of first class service. These examples point to one of the reasons why it is so difficult to get general results.

The joint frequency of preferences now is $f(r_h, r_l; q_h, q_l)$ where q_i is the quality of service class I. An increase in q_h pushes the cloud of points in figure 5 generally upward. An increase in q_l pushes it generally rightward. Applying the partition from figure 1 to this distribution, the demand for each class of service depends on q_h and q_l . Moreover, with figure 5 type preferences the number of tickets demanded by customers with the most intense preferences depends only on the price difference $\Delta p = p_h - p_l$ (notice that the intercept of the price line that partitions the distribution is Δp and all customers above that line purchase a ticket). The problem neatly decomposes. For A-preferences in figure 5, p_l sets the extensive margin between those who purchase a ticket of some kind and those who purchase nothing; while Δp sets the intensive margin among those who buy first and second class seats. For B-preferences, p_h sets the extensive margin because H is the “marginal” class of service. Hence A implies $N_h = N_h(\Delta p, q_h, q_l)$ and $N_l = N_l(\Delta p, p_l, q_h, q_l)$. B implies $N_h = N_h(\Delta p, p_h, q_h, q_l)$ and $N_l =$

$N_i(\Delta p, q_h, q_l)$.⁵

Consider the case of A preferences. The seller's profit is $\pi = [\Delta p - c_h(q_h) + c_l(q_l)]N_h + [p_l - c_l(q_l)]N_l$, where the c 's are the unit costs of improving quality of seats. For a given quality configuration, the seller chooses Δp and p_l to maximize profits. Then qualities are chosen given their effects on prices. Assuming that some low valued customers are excluded at the optimal policy, the marginal conditions for the q 's work out to be

$$(8) \quad c'_h N_h = -N_h[\partial N_h/\partial q_h \div \partial N_h/\partial \Delta p] - (N_h + N_l)[(\partial N_h/\partial q_h + \partial N_l/\partial q_h) \div \partial N_l/\partial p_l]$$

$$= N_h[d\Delta p/dq_h] + (N_h + N_l)[dp_l/dq_h]$$

$$(9) \quad c'_l N_l = -N_h[\partial N_h/\partial q_l \div \partial N_h/\partial \Delta p] - (N_h + N_l)[(\partial N_h/\partial q_l + \partial N_l/\partial q_l) \div \partial N_l/\partial p_l]$$

$$= N_h[d\Delta p/dq_l] + (N_h + N_l)[dp_l/dq_l]$$

These generalizations of equation (5) balance marginal costs and benefits of increments of service quality. The first term on the rhs of (8) is the amount by which an increment of first class service quality increases the price spread between first and second class tickets. The second term is the extent to which extra first class service allows the price of second class tickets to rise due to lesser class substitution. It is grossed up over all seats because it raises the absolute price of both classes. Both of these terms are positive. By contrast, the first term on the rhs of (9) is negative. An increase in second class quality decreases the price spread between classes. This tends to lower second class seat quality. An increase in second class quality increases second class prices, which tends to increase it. Conceivably the negative cross effect could be so large that the seller has incentives to willfully reduce the quality of second class seats beyond their "natural" levels.

⁵ Close inspection of figures 2 and 5 reveals that for A-preferences $\partial N_h/\partial \Delta p$, $\partial N_h/\partial q_l$, $\partial N_l/\partial p_l$, and $\partial N_l/\partial q_h$ are negative, while $\partial N_h/\partial q_h$, $\partial N_l/\partial \Delta p$, and $\partial N_l/\partial q_l$ are positive. These inequalities with the subscripts permuted hold for B-preferences.

Conditions analogous to (8) and (9) for B-preferences reverse the roles of H and L. In that case the seller has incentives to increase second class quality (because that is where the highest taste customers sit) and the negative cross effect goes to the first class seats. For more general distributions, the total effects would involve a balancing of frequency mass in these various regions, as well as the effects of high reserve price customers dropping out of the market rather than switching to a different class of service. We have not found workable general restrictions on preference distributions that guarantee a systematic outcome.

The effect on efficient quality levels requires comparing (8) and (9) with the consumer surplus maximizing solution (sketched in the appendix). The cross terms in the socially optimum marginal benefit terms turn out to be symmetric. Both are negative. An increase in one service quality reduces the consumer surplus in the other quality, cet. par., even when preferences are ordered the way they are in figure 5. Nevertheless, the averaging or public good character of the social optimality conditions makes precise comparisons difficult without further specification of preferences, as in the simpler one-class of service case.

3. Pricing Complementary Goods

Ticket holders usually are given the rights to purchase complementary goods while seated (food, drinks, recordings, and parking at concerts and ball games, popcorn at the movies). The physical presence of the ticket holder at the venue creates a captive audience for complementary goods sold there. To what extent is it in the interests of the seller to “gouge” customers purchasing these additional services, to give them away as promotional material, or just sell them at marginal cost?

Exerting monopoly power in pricing auxiliary services reduces the extent to which rents can be extracted from admission charges [Oi(1971)]. When customers have the same tastes it is optimal for the seller to charge marginal cost prices for services. But if consumers’ preferences are private and heterogeneous, section II.1 shows that the seller cannot extract all surplus through admission charges alone. Profit may be larger by charging more or less than marginal cost for services⁶ and

⁶ There is a presumption in the literature that price normally exceeds marginal cost. See Carlton and Perloff (1990), Tirole (1988) but that has been questioned lately by Cassout and Hause (1994). In this

adjusting ticket prices accordingly. This also turns out to be a marginal and average comparison. Services are sold at more than marginal costs if demand for auxiliary services by inframarginal customers is greater than for marginal customers, and conversely.

The analysis for a single class of service readily extends to multiple classes, so we examine it first. Let $u(x,z,\theta)$ denote the preferences of a person who purchases a ticket, where x is all other goods consumed, z is the purchase of complementary goods at the venue, and θ is a taste parameter, distributed in the population as $A(\theta)$. A consumer with income y who pays p for a ticket can purchase z on the premises at price w , so the budget constraint is $y - p = x + wz$ if a ticket is purchased. Once inside, the person chooses z to maximize u , requiring $u_z/u_x = w$, which, along with the budget constraint implies a demand function $z = z(w,y-p,\theta)$. If the person doesn't attend, utility is $v(x,\theta)$ and the budget is $y = x$.

Let r be the maximum price a person of type θ will pay for the right to enter and buy the complementary good at price w . It is defined by the indifference condition $u(y-r-wz, z, \theta) = v(y,\theta)$, or $r = r(w,y,\theta)$. The envelope theorem implies that $-dr/dw = z$: raising the price of concessions reduces the amount the customer is willing to pay for admission by the amount of concessions purchased. We assume that $r(w,y,\theta)$ is uniquely ordered in θ , with $r_\theta > 0$.⁷ If the seller charges price p for admission and sells concession goods at price w , people with preferences θ^* defined by $r(w,y,\theta^*) = p$ are indifferent to attending and the taste distribution $A(\theta)$ is partitioned into two parts. All those for whom $\theta \geq \theta^*$ choose to attend and those for whom $\theta < \theta^*$ do not attend. Differentiating the definition, we have $\partial\theta^*/\partial w = z/r_\theta > 0$ and $\partial\theta^*/\partial p = 1/r_\theta > 0$. Raising either price reduces attendance.

Let k be the (constant) marginal cost of supplying z . Then the seller's total profit is

$$(10) \quad \int_{\theta^*(p,w)} [p + (w-k)z(w,y-p,\theta)] dA(\theta)$$

problem: it can go either way.

⁷ The joint distribution of y and θ should be considered. This straightforward and is ignored.

Differentiating with respect to p and w and combining terms (see appendix)

$$(11) \quad w - k = \int_{\theta^*} [z(\theta) - z(\theta^*)] dA(\theta) \div \int_{\theta^*} -[\partial z^s / \partial w + (z(\theta) - z(\theta^*)) \partial z / \partial y] dA(\theta)$$

The numerator in equation (11) is $[E(z(\theta) | \theta \geq \theta^*) - z(\theta^*)]$ multiplied by audience size. Its sign depends on whether the average ticket holder buys more or less of the concession good than the marginal customer. The first term in the denominator is the slope of the compensated demand function for complements. The second term is the covariance between the income effect on concession demand from raising ticket prices and concession consumption. About this little can be said.

The denominator in (11) is positive if either the income effect or the correlation are small. Then the price of concessions is larger or smaller than marginal cost according as the average person consumes more or less z than the marginal person. In the first case, the seller extracts more rent (relative to marginal cost pricing of complements) by taxing the diehards' consumption of them, who attend anyway, and reducing the admission price to attract marginal customers, who don't buy many concessions. It's an imperfect form of price discrimination when ticket prices must be offered at the same terms to all potential buyers. If the marginal customer desires more concessions goods than the average customer, it pays to subsidize such goods and give them away, or at least price them below cost and raise ticket prices. This does not unduly deter marginal customers from entering, while extracting greater rent from those with more intense preferences for the primary good who don't care about concessions.⁸

When there is more than one class of service and the seller can charge different concession prices to each class while preventing resale between classes, the analysis above carries over to each

⁸ An example of the second kind is bat day at ball games--a selective way of reducing price for (marginal) customers with children. Perhaps most "promotions" of consumer goods are of this kind (free mugs at MacDonalds). An example of the first is the high price of popcorn at the movies. Marginal customers apparently have smaller taste for it than do average customers. Were it feasible to charge different prices for different quality seats in the movies, we suspect that the price of popcorn would be closer to marginal cost. See Locay and Rodriguez (1993) for another approach based on group consumption.

class separately. More often resale or other constraints require the seller to offer concession goods to all customers on the same terms independent of class. The resulting marginal condition is similar to (9) but involves weighted averages over classes of the within class terms in (9) in both numerator and denominator (appendix). To the extent that these average and marginal comparisons conflict across classes, prices of concessions tend to be driven closer to marginal costs.

III. Spatial Price Discrimination

1. Seat Location at Distance

Imagine seats venue arranged, like an amphitheater, in a (semi-)circular configuration with the performer at the focus. The number of seats available at distance d is proportional to the circumference of a circle of radius d , or to $2\pi d$. Closer seats inherently are scarcer than worse seats. Let $s = s(d)$ be seat quality, with $s'(d) < 0$, with $s_b = s(0)$ the best seat available and $s_w = s(d_w)$ the worst seat available, where d_w is the greatest distance from the focus.

Preferences are $U(x,s)$, where x is an outside good. If y is income in units of x and $p(s)$ is the price of a seat of quality s , the budget constraint is $y = x + p(s)$. The consumer purchases a seat of quality s (possibly none at all) to maximize $U(y-p(s),s)$, so $U_s/U_x = p'(s)$ and $p'(s) > 0$ is necessary in any equilibrium. Preferences are heterogeneous if U_s/U_x differs among potential buyers. The argument is simplified by assuming a linear form $U(x,s) = x + \xi s$, where ξ is distributed in the population according to $h(\xi)$. ξ is the intensity of demand.

Let $\rho(s)$ be the maximum amount a person is willing to pay for seat of quality s . It is the reservation price function. When $y \geq s_b/\xi$ then $\rho(s) = \xi s$ with linear utility. But $y < s_b/\xi$ implies that the reservation price function has two linked pieces, $\rho(s) = \xi s$ if $s < s^*$ and $\rho(s) = \xi s^*$ if $s \geq s^*$, where $s^* = y/\xi$. Consider the unconstrained case. Then $\rho(s) = \xi s$ defines a family of increasing functions in the (ρ,s) plane (rays from the origin defined over the range $[s_b, s_w]$). People with greater intensity of demand are willing to pay more for any given seat quality. The extra amount they are willing to pay is increasing in s .

The seller's problem is to sell each available seat at its maximum possible price. The general nature of the solution is clear: Charge prices that cause customers with the greatest demand intensity

to purchase the better seats. The price gradient on s is bounded by the possibilities for customers with more intense demands to purchase cheaper seats. This limits the seller's ability to extract rents from the highest ξ customers.

As before, the solution is very simple when there are just a few types and no income constraints (i.e., $y \geq s_i/\xi$). Consider two types. Then the distribution $h(\xi)$ is binomial at values ξ_1 and ξ_2 , with $\xi_2 < \xi_1$. Reserve prices are shown in figure 6. Since $\rho(s; \xi_2) < \rho(s; \xi_1)$, the seller sets $p'(s) = \xi_1$ for seats in the neighborhood of s_b (the best seats) and "walks" down the index of demand intensity while moving toward the back row. If there are enough people of type ξ_1 to exhaust capacity, then $p(s) = \xi_1 s$ for all s in the set of seat availabilities, type ξ_2 buyers do not purchase and all surplus is extracted from the ξ_1 types.

Assume now that the number of high intensity buyers is smaller than capacity. If seats are to be sold to type ξ_2 customers, then the price must be smaller than $\xi_1 s$ for at least some values of s . After all, type 2 customers are only willing to pay $\xi_2 s$ and this is strictly smaller than $\xi_1 s$ for each value of s . Evidently, the seller must lower the price of lower quality seats below $\xi_1 s$ to induce type 2 buyers to attend. But having to do this means that it is no longer possible to sell the higher quality seats to type 1 buyers on the same terms as before. Lowering prices of poor quality seats opens up new options for buyers who value s the most to obtain greater surplus.

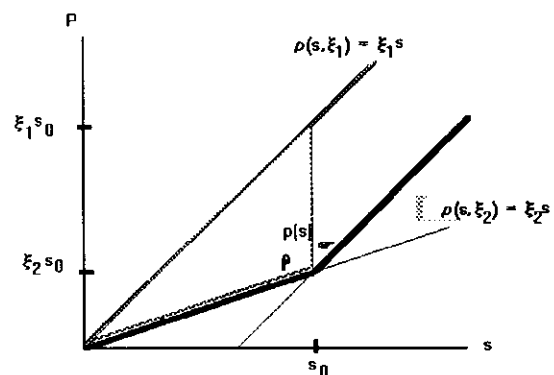

Figure 6

For example, consider what happens if the seller attempted to extract all surplus from both types of customers, setting $p(s) = \xi_2 s$ for $s \leq s_0$ and $p(s) = \xi_1 s$ for $s > s_0$, where s_0 is some value between s_w and s_b . Type 2 customers are willing to buy seats of quality s_0 or less on these terms and their net surplus is zero. However, type 1 customers are not willing to buy seats of quality larger than s_0 . Rather, figure 6 reveals that they strictly prefer to buy a seat of quality s_0 for they enjoy surplus $(\xi_1 - \xi_2)s_0$ instead of buying a seat quality greater than s_0 at price $\xi_2 s$, where surplus is zero. This

pricing strategy causes all type 1 buyers to mass their demand on s_0 seats and leave all seats of higher quality unsold. This cannot be optimal for the seller because exiting seats are costless and selling them at any positive price increases revenue. It is impossible to achieve first degree price discrimination for both groups separately. Furthermore, the equilibrium price cannot jump at any value of s that is not at the upper or lower limits of seat quality. Otherwise some potential profitable high quality seats would remain unsold.

This point holds for all quasi-concave utility functions, not just linear ones: $p(s)$ cannot jump at assignment separation points between groups if seats on both sides of that point are occupied. $p(s)$ is made continuous by pasting the two price line segments together at points such as s_0 in figure 6, with the lower intensity demander's reservation price schedule serving as anchor. With two kinds of customers, $p(s)$ equals the reservation price schedule of type 2 buyers at seat quality below s_0 . Above that point $p(s)$ follows the slope of the reservation price of type 1 buyers, but is shifted down to connect to the reservation price of type 2 buyers at s_0 (the heavy lines in figure 6). Type 1 buyers are indifferent to all seats in the high quality range and all of them are occupied, but all high intensity buyers receive net surplus from attending. The equilibrium price schedule is a convex function of s as a natural result of the sorting process. If there are N_1 buyers of type 1, then s_0 is determined by the condition $N_1 = \int_{s_0}^{s_b} n(s) ds$, where $n(s)$ is the number of seats available at s .

The seller wants to cater to buyers who will pay the most, and does so by getting them to buy the highest quality seats. However, if buyers with less intense demand are served, not all surplus can be extracted from buyers with more intense demand. Whether or not type 2 customers are served comes down to a kind of marginal revenue calculation. Serving them requires reducing ticket prices sold to all type 1 customers in high quality seats by the constant amount $\xi_2 s_0$. However, this allows revenues to be collected from lower quality seats in amount $\xi_1 s$, because these seats otherwise would be unsold.

Serving buyers with less willingness to pay is more likely the smaller is $\xi_1 - \xi_2$, for then the price reduction on high quality seats is small, and the larger the number of type 2 buyers. Notice that there may be unsold low quality seats in equilibrium, that ticket prices on these lower quality seats appear to be too high, even though the marginal social cost of filling them is zero. The point is that

the private marginal revenue of selling them may be negative due to the infra-marginal price adjustments required on higher quality seats, much like the standard zero cost monopoly pricing problem.

This result generalizes to an arbitrary number of groups. There is a chain-letter effect of serving the marginal group because it affects the terms on which prices can be charged to all groups with more intense demands on an ordered, pair-wise basis. The seller extracts all surplus from the marginal group. Consumer surplus is increasing in ξ . Though price is increasing in ξ , seat quality is effectively increasing by more.

2. "Income Effects"

This formulation allows for income effects in a very general way, for instance, higher income people might have steeper and absolutely greater reserve price functions in the market equilibrium and purchase the highest quality tickets. The constrained case where $y/\xi < s_b$ and the reserve price function has two pieces produces another kind of income effect. The sense of this condition is that some customers have limited means available to spend on the service. For example, the most ardent customers at some rock concerts are children whose parents strictly control spending.

Such constraints put ceilings on reservation price schedules and can cause "flats" in the posted price schedule, where $p'(s) = 0$ over some range of s . In these cases ticket prices over a contiguous range of qualities are sold at a single price and must be rationed by nonprice means. To illustrate, let there be two types of customers, ξ_1 and ξ_2 , with $\xi_1 > \xi_2$. However, suppose that $y_1 < y_2$ with y_1 so small that $y_1/\xi_1 < s_b$. In figure 7, the reserve price for type 2 customers is a straight line as before, but the reservation price function for type 1 is kinked with a flat portion for all $s > y_1/\xi_1$.

If there are enough type 1 buyers relative to capacity, then $p(s)$ just follows the kinked reserve price curve of type 1 buyers. All seats of quality greater than the limit y_1/ξ_1 must sell for the same price---the maximum these customers are willing to pay. Every buyer would prefer a better seat to a worse one in the flat range, but there is no way of rationing them by price (and no

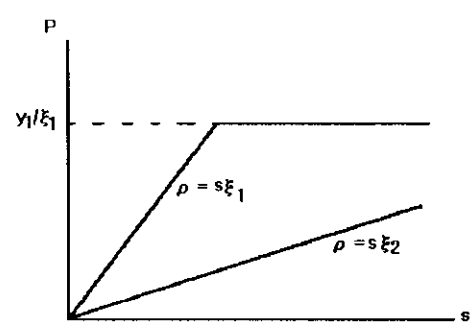

Figure 7

scalping opportunities!) because the seller has extracted everything that is available. These tickets are rationed by queue or lot. When they are exhausted, remaining customers willingly, but grudgingly, purchase lower quality seats on the sloped part of their reservation price schedules.

If there are not enough customers of this type, the argument proceeds as before, with type 2 customers occupying the inferior seats and receiving no surplus. Still the high quality seats are nonprice rationed and some buyers are better off than others (there is "regret" among those who wind up with lower quality seats). Finally, if the income constraint is so tight that the limit price for type 1 buyers is less than $\xi_2 s_b$, the flat occurs on the interior of seat availability, with type 2 buyers occupying both the best and the worst seats, and type 1 customers fighting over mid-range quality seats.

IV. Intertemporal Price Discrimination

This section analyzes intertemporal pricing in situations when capacity constraints require that the service must be rendered sequentially. Theatrical production is a leading example of a "batch processor" where K customers are served at a time, and the show runs till all demand is satisfied. It is essential for this analysis that buyer and seller require face-to-face contact for any transaction to occur (the play needs an audience in a theater of fixed size). Otherwise the interesting intertemporal aspects vanish. Assume that K is large enough that buyers do not communicate with each other and that preferences are time invariant. Then the seller's degree of monopoly power does not significantly change over time, and any gain in bargaining power of buyers toward the end of the run is trivial and can be ignored. That having been said, normalize capacity K at each production point to unity, and since seat quality issues have been discussed above, assume that all seats are of equal quality.

1. Homogeneous Preferences

To begin, assume there are large number of identical customers. All have spot reservation price for the service today, r , and with the same time discount factor D . Each person is willing to pay r if the service is obtained today, rD if it is obtained the day after, rD^2 the day after that, etc. Were the seller to sell all tickets up front (before the first performance) for time-dated services, the market clearing prices would be r for a ticket to the first performance, rD for a ticket to the second performance, and rD^t on performance t . Customers would be indifferent as to which day the service

was obtained. Those attending later performances would be paid to wait, getting their tickets at lower prices. The seller prefers this method if the rate of interest earned on the front money exceeds the rate of time preference of customers.

The answer is much different in the more relevant case (for entertainment services) when the time discount rate is larger than the interest rate. Then the seller does better if tickets are held back till the day of performance and not sold in advance, because the price will not decline over time. The implicit market for waiting is shut down and tickets are rationed by queues or other nonprice means.

If tickets are sold on the day of performance, consider what happens at the last performance. Evidently the seller charges price r , the reserve price of buyers on that day. Now consider the performance before the last. If customers expected the seller to reduce price tomorrow by $r(1-D)$, an "orderly market" for that day's performance would seem to occur. For if buyers expected this intertemporal price pattern, they would be indifferent to going to the current performance at price r or to tomorrow's performance at price rD . However, the price cannot be rD when the day of the last performance arrives. The seller charges r at the next performance, because the buyer who isn't served today values the service at r (and rD the day after that). Bygones are bygones, and all surplus is extracted by charging r once again. Buyers cannot credibly expect price to fall to rD on the next performance.⁹

Working backwards, the only feasible equilibrium requires a "disorderly" market for tickets to the next-to-last performance. Knowing the price will be r for the last performance, each buyer will scramble on the day prior to purchase that day's ticket. However, the price on that day cannot be greater than r because no one will buy at a spot price higher than that. Therefore a ticket to the day before the last performance must also sell for r . The argument extends to any number of periods. There is always excess demand for tickets to earlier performances when spot reserve prices are identical across customers. Excess demand declines over time as more and more customers are

⁹ The point is related to the intertemporal inconsistency problem that arise in durable goods monopoly problems. See Bulow (1986) for the context closest to our problem. The capacity constraint and sequential batch processing make ours a kind of "durability" problem.

served, but nonprice rationing (scalping is not implied here even though there is excess demand--the price is as high as it will go) is the seller's optimal policy. There is no other solution under the circumstances.

The technology requires that customers be served sequentially. Some people necessarily must wait for future performances. By not paying the compensation necessary to get buyers to willingly wait, the producer extracts all surplus and charges r for each performance. There is an important sense in which this solution is "forced" on the seller. For the equilibrium price in later periods must be r whether the theater is selling the ticket at that point or someone else has tickets in their possession and offers them for sale. If some other party owns one, the equilibrium price is r when each day comes along, so long as a person whose reserve price is r does not hold it. Why should the seller give a gift to someone else by selling a lower priced ticket in advance? Why not just hold it and sell for r when the time comes? Equivalently, the seller credibly commits to selling a ticket to any future performance at price r .

A. Pre-performance queues

A simple application is to the disposition of tickets for single performance events. When a popular event is announced (a team makes the playoffs, a popular performer announces one performance in a city on a nationwide tour, etc.), people who expect a sell-out queue up at the box office to buy tickets, sleeping a night or two near the premises to be first in line, etc.. Isn't this inefficient? Why not announce a declining price schedule up to event time, so those who value the tickets the most can get them? The problem is that the seller does not know the personal identities of who values them the most. If buyers with low values somehow get possession of tickets, they will sell them to others who have higher valuations. The price cannot credibly decline in the interval between when the event is announced and when it occurs. The ticket price must remain unchanged over the interval and be allocated by nonprice means, such as queuing.

B. Differences in time preference.

Organizing a market for waiting is impossible even if customers differ in their rates of time preference. Suppose all buyers have the same spot reservation price r , but that some are more impatient than the others and that the impatience parameter is private information. In this case it is

socially efficient for the impatient buyers to attend earlier performances and the more patient ones to attend later performances. However, it is not always possible to achieve this outcome. The reason is the same as before. The price of later performances at the time the service is rendered must be r whether impatient or patient persons buy them. But then everyone will bid r for early performances irrespective of their impatience. The patient person has no incentive to wait because waiting cannot be compensated.

2.Heterogeneous Buyers

The waiting market does operate when buyers differ in their spot reservation price r . The end period unraveling problem doesn't prevent market separation between high and low reservation value customers except in the final period. Falling prices over time effects a kind of intertemporal price discrimination (Stokey (1979)) that allows different preference groups to be served sequentially, in much the same way that seat quality does for a spatial pricing problem. The basic idea is that people who desire the service the most are willing to reveal their preferences and buy early if they expect that the price will not fall too quickly. Sorting customers by preference types in this way allows the seller to extract greater surplus from all customers as a whole, so the policy is time-consistent.

Assume two groups of buyers, one with reserve price r_1 and the other with reserve price r_2 , with $r_1 > r_2$. To simplify, assume that everyone has the same rate of time preference. The seller knows the number of each kind of customers, but cannot identify them individually. With no loss of generality assume that the marginal cost of each performance (production batch) is zero.

The problem for customers is to time their purchases optimally. Should they buy now, later or not at all? The problem for the seller is to maximize total revenue, given that buyers choose their time of purchase optimally. We find the rational expectations solution to this problem. First, observe that ticket prices cannot be rising over time. For if they did, all buyers desire early performances, and there would be gains from resale at higher prices by people who managed to obtain early performance tickets. The seller would be giving money away to others by adopting such a policy.

Next, observe that type 2 customers do not purchase unless price is less than or equal to r_2 . Any constant price policy that charges more than r_2 is not credible, for when all type 1 customers have been served, the seller has incentives to reduce the price to pick off the business of type 2 buyers.

But if type 1 buyers anticipate this, they delay purchase and no one is served at all. Hence any constant price policy that caters to type 2 buyers can only charge r_2 , leaving substantial rents available to type 1 buyers that the seller would like to squeeze out. Any constant price policy pools buyer types in the timing of their purchase because all prefer early performances. The seller would be giving money away by adopting this policy.

The only policy worth thinking about is one where the price declines over time, where type 1 customers purchase early at a price larger than r_2 , and type 2 customers purchase later at price r_2 . This extracts more surplus from type 1 customers, but their option to delay purchase limits the extent to which they can be exploited. To see this, assume the existence of a pricing policy that serves consumer types sequentially. We know from above that once all type 1 customers have consumed the good, the seller faces a homogenous group of type 2 buyers and rationally prices all tickets at r_2 from that date forward. Production ceases when all such buyers have been served.

Now consider the rational pricing policy when all but K type 1 customers have been served (recall K is venue size, so this is the last performance where type 1 customers will buy). At that point any price above r_2 excludes type 2 customers. However, the remaining type 1 customers know that price will fall to r_2 on the next day. If the seller tried to charge r_1 , all of these people would defer purchase because they would anticipate positive rent of $(r_1 - r_2)D$ the next day and no rent on the day in question. Define P_0 as the maximum price the seller can charge today to induce purchase by type 1 customers? It requires equal surplus of type 1 buyers on either day: $r_1 - P_0 = (r_1 - r_2)D$, or

$$(12) \quad P_0 = r_1 - (r_1 - r_2)D < r_1.$$

Were all buyers alike, the backward logic led us to conclude that the price on prior performances could not rise because it was already at the limit price. However, P_0 is not a limit of that kind for type 1 customers. Consider the optimal price P_1 on the next-to-last day before all type 1 customers are served. Now there are two performances remaining for the remaining $2K$ type 1 buyers. Since earlier performances are always preferable to later ones, the seller can extract more money at the first of these two production dates. The equal surplus condition between the two

performance is $(r_1 - P_1) = (r_1 - P_0)D$, or

$$(13) \quad P_1 = r_1 - (r_1 - r_2)D^2$$

Continuing in this way, if there are $t+1$ consecutive performances remaining at which only type 1 buyers will be served, then

$$(14) \quad P_t = r_1 - (r_1 - r_2)D^{t+1}.$$

The overall rational pricing policy is depicted in figure 8. If there were a third group with a larger reservation price, the optimal price for that group is anchored in an equation like (12) at the last performance they attend.

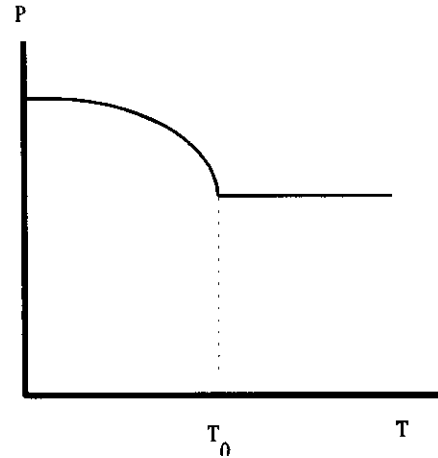

Figure 8

Notice again that there is a “chain-letter” effect of extending the run to include lower reservation value customers, for these expectations affect the terms on which higher value customers are willing to pay. For instance, the price is r_1 in figure 8 if the seller can commit to closing the show after all type 1 customers have been served. This may yield more profit than extending performances to type 2 customers, if r_2 is small enough or there aren't many of them. One way a performer can commit to limiting live performances is by organizing a national tour, selling tickets to precisely identified venues and concert dates in advance (“one performance only” per city). With limited substitution across city/venues on the tour, customer expectation of no repeat performances enables the promoter to avoid serving those with small demand prices in each city. Those with high demand prices have no incentives to wait for prices to fall, so the seller can rise ticket prices closer to the higher reservation levels of the more enthusiastic buyers.

V. Fashion, Uncertainty and Related Matters

It is always possible to think of monopoly price determination as the outcome of competition

among customers for the inelastically supplied, restricted quantities the seller makes available to them¹⁰. That artifice is useful here because the competitive, arbitrage-like elements in the spatial or intertemporal sorting of customers to seats a competitive bidding or as-if auction market for available seats. We got pretty far in describing a number of commonly observed features of these markets by this “competitive” analysis with straight-ahead preferences. More elaborate specifications of preferences or technology yield more refined implications.

For example, preferences for new theatrical productions and movies are not so well defined because consumers have limited knowledge of what they will see. Elaborate institutions have evolved to provide information about new products to potential customers. Virtually all of them rely on opinions of persons who have attended earlier performances, either by professionals who sell their views to the public for profit, or by previous consumers whose information spreads by word of mouth. These produce group externalities--contagion-like aspects of consumption--because information the volume of other customers' purchases affects the valuation of individual customers. Usually it is in the seller's interest to actively manipulate prices as well as quantities in these cases.

It is known that group externalities can create nonconvexities that have interesting consequences. For instance, the market equilibrium might display what appears to be a relatively high price and excess demand, but no unexploited scalping opportunities (see Becker's (1991) example, a result that we obtained by a much different route in section IV). Another approach is to directly model information flows among customers. The elements of such a model differ so much in technique and style from the present analysis that we cannot develop the argument in detail here. However, the basic idea is easily stated.

Think of a market for information services in which informed customers (those who had seen the production already) are paid fees to register their opinions, and those who desire to receive this information must pay a fee to examine the register. Earlier customers are an input into the total value of future output, the joint product of information services and future performances. Earlier customers must be paid for services rendered. The supply price of this service is affected by such things as risk

¹⁰ One can interpret Lott and Roberts' (1991) "revisionist" views on price discrimination largely in this manner.

aversion of earlier customers, prior reputation of the producers, and so forth. Typically there is heterogeneity and comparative advantage in supplying information. The hip trend setters, who get extra utility from providing these services have lower supply prices and more eagerly attend earlier performances.

The public nature of this kind of information makes it difficult for these services to be supplied efficiently by independent intermediaries. It is in the producer's interest to act as an information intermediary, setting somewhat lower prices for earlier performances--to in effect buy the services of the trend setters, and charging higher prices for later performances (should the production be successful) as a return on prior information investments. The analysis is formally similar to a learning-by-doing problem, where cumulated output is a demand shifter (Rosen, 1972). These kinds of forces reduce the rate of decline of prices required for intertemporal sorting of customers by taste, and are one of the reasons why prices in theatrical productions and movies seem to decline so slowly over time.¹¹

Finally, the market analogy needs to be extended to include genuine stochastic elements of preferences and customer arrival rates. Fully rational, nonstochastic models cannot explain ticket scalping for instance. Many potential explanations for scalping have been proposed. It may be useful for manipulating limited information on the quality of limited run productions, e.g., hearing that some have paid an extraordinary price may affect one's own valuation. Some scalping is the result of prohibitions on resale needed to enforce bundling options offered by the seller to customers. For instance, bundling season tickets for team sports invariably entails much variance in the value of individual events, and the desirable price discrimination virtues of bundling are undone if the package can be untied.

We think the most promising approach conceptually is in terms of full contingent claims

¹¹ Casual observation suggests that price declines occur through discrete changes in marketing format, e.g., release to videotape, foreign venues, and outlying theaters for movies, out-of-town productions for Broadway, and the like. The economics is based on capacity constraints among first-run venues. For if a current production is not very successful, there is much option value in yanking it from the first-run theater. Rather than lowering price, it is better to try an unknown new production that is waiting in the queue, for it might be much more successful. The product is shifted to another market.

markets [McCain (1987), Harris and Raviv (1981), and especially Courty (1995)], which essentially extends the competitive market analogy to include uncertainty. In that view scalping generally is the result of market incompleteness and errors in pricing due to imperfect information. In many ways the problem is related to public utility and priority pricing with capacity constraints and uncertainty [see Wilson (1993) for most known results]. That approach, however, cannot account for legal restrictions on scalping, reiterating a point made at the beginning of this paper, that the pricing of tickets is an inexhaustible source of interesting economic problems.

REFERENCES

Adams, W. and Janet Yellin (1976) "Commodity Bundling and the Burden of Monopoly," Quarterly Journal of Economics 90: 475-498.

Becker, Gary S. (1991), "A Note on Restaurant Pricing and Other Examples of Social Influences on Prices," Journal of Political Economy 99:1109-16.

Becker, Gary S. and Kevin M. Murphy (199), "A Simple Theory of Advertising as a Good," Quarterly Journal of Economics.

Bulow, Jeremy (1986), "An Economic Theory of Planned Obsolescence," Quarterly Journal of Economics 729-49.

Carlton, Dennis W and Jeffrey M. Perloff (1990), Modern Industrial Organization. Glenview, Il: Scott, Foresman and Co.

Cassout, Stephen and John Hause (1995) "Pricing Below Marginal Cost: Revisiting Disneyland," SUNY Stony Brook.

Courty, Pascal (1995), "Equilibrium Under Random Demand and Advanced Production," University of Chicago.

Dupuit, Jules (1844) "On the Measurement of the Utility of Public Works," translation by R.H. Barbak, International Economic Papers 2.

Ekelund, R. B. (1970), "Price Discrimination and Product Differentiation in Economic Theory: An Early Analysis," Quarterly Journal of Economics 84:268-278.

Harris, Milton and Arthur Raviv (1981), "A Theory of Monopoly Pricing Schemes with Demand Uncertainty," American Economic Review 71:347-65

Hotelling, Harold (1932), "Edgeworth's Taxation Paradox and the Nature of Demand and Supply Functions," Journal of Political Economy 40:577-616.

Locay, Luis and Alvaro Rodriguez (1993), "Price Discrimination in Competitive Markets," Journal of Political Economy 100:954-66.

Lott, John R., and Russell D. Roberts, (1991) "A Guide to the Pitfalls of Identifying Price Discrimination," Economic Inquiry 14-23.

McAfee, R, Preston, John McMillan and Michael D. Whinston (1989), "Multiproduct Monopoly, Commodity Bundling, and Correlation of Values," Quarterly Journal of Economics 103:371-383.

McCain, Roger A. (1987), "Scalping: Optimal Contingent Pricing of Performances in the Arts and Sports," Journal of Cultural Economics, 11:1-21.

Mussa, Michael and Sherwin Rosen (1978), "Monopoly and Product Quality," Journal of Economic Theory 18:301-317

Oi, Walter (1971), "A Disneyland Dilemma: Two-Part Tariffs for a Mickey Mouse Monopoly," Quarterly Journal of Economics 85: 77-96.

Phlips, Louis (1983), The Economics of Price Discrimination. Cambridge: Cambridge Univ. Press.

Rosen, Sherwin (1972), "Learning by Experience as Joint Production," Quarterly Journal of Economics 86:366-82.

_____ (1981) "The Economics of Superstars," American Economic Review 71:845-58.

Schmalensee, Richard (1984), "Gaussian Demand and Commodity Bundling," Journal of Business 57 (supplement) s211-s235.

Stokey, Nancy (1981), "Intertemporal Price Discrimination," Quarterly Journal of Economics 93: 355-371.

Swan, Peter L. (1970), "Durability of Consumer Goods," American Economic Review 60:884-894.

Tirole, Jean (1988). The Theory of Industrial Organization. Cambridge: MIT Press.

Wilson, Robert B. (1993), Nonlinear Pricing. Oxford: Oxford University Press.

Walras, L. (1875/1980), "The State and the Railways," Trans. P. Holmes, Journal of Public Economics 13:81-100. Originally published in 1875.

APPENDIX

1. Solution for One-Factor Representation of Tastes

Define a "taste" for the service variable, T , distributed according to some known frequency $g(T)$ in the population of potential buyers. The reserve prices are given by

$$(A1) \quad \begin{aligned} r_h &= \alpha_h + \beta_h T \\ r_l &= \alpha_l + \beta_l T \end{aligned}$$

where $\alpha_h, \beta_h, \alpha_l,$ and β_l are fixed parameters. Assuming the "factor loadings" β_h and β_l are positive, the "T-factor" represents a person's intensity of demand. It follows that reserve prices are distributed over a positively sloped line in the (r_h, r_l) plane defined by

$$(A2) \quad \beta_l r_h + \alpha_l \beta_h = \beta_h r_l + \alpha_h \beta_l$$

Since T increases in passing from left to right over the line, the partition in figure 1 implies that if any buyers are priced out of the market, it must be those with the smallest values of T . Customers with the most intense preferences buy the expensive seats if the "factor loadings" line up as $\beta_h > \beta_l$. Customers with the most intense preferences purchase the less expensive seats if factor loadings line up as $\beta_h < \beta_l$.

The first panel in figure A1 shows the equilibrium when $\beta_h > \beta_l$. The second panel shows how $g(T)$ is partitioned in that equilibrium. All those above T_1 (the area marked N_h) purchase high class service, those between T_0 and T_1 (the area marked N_l) purchase low class service, and the rest (in the area marked N_0) do not purchase anything. T_1 is the taste value that yields equal surplus between H and L at these prices: $r_h - p_h = r_l - p_l$. T_0 is the taste value yielding zero surplus $r_l = p_l$. Substituting from (A1) and (A2),

$$(A3) \quad \begin{aligned} T_1 &= \{(p_h - p_l) - (\alpha_h - \alpha_l)\} / (\beta_h - \beta_l) \\ T_0 &= (p_l - \alpha_l) / \beta_l \end{aligned}$$

Writing $G(T) = \int_0^T g(t)dt$ as the cumulative distribution, with $G(\infty) = N$, where N is the number of people with positive tastes for either type of service, the demand functions for each class of service are

$$(A4) \quad N_h = N - G(T_1) \quad \text{and} \quad N_l = G(T_1) - G(T_0)$$

(A3) implies that the demand functions (A4) depend on the first class price premium, $\Delta p = (p_h - p_l)$, and the price of a second class ticket, p_l . In the interesting case where tickets of both classes are sold, the cut-point T_1 and the number of high quality service users N_h is solely determined by Δp --see the first panel of figure A1. The problem has a recursive structure. The seller sets Δp to get the desired number of H-service buyers, and then chooses the level of prices (both p_l and p_h) to get the desired extensive margin at the low end. From (A3) and (A4), $\partial N_h / \partial p_h = \partial N_h / \partial \Delta p = -\partial N_l / \partial \Delta p$; $[\partial N_h / \partial p_l]_{\Delta p} = 0$; and $[\partial N_l / \partial p_l]_{\Delta p} = -\partial N_0 / \partial p_l$, where $N_0 = N - N_h - N_l$.

Choosing Δp and p_l to maximize total revenue $p_h N_h + p_l N_l$ yields marginal conditions

$$(A5) \quad \begin{aligned} \partial(p_h N_h + p_l N_l) / \partial \Delta p &= N_h + \partial N_h / \partial \Delta p \geq 0 \\ \partial(p_h N_h + p_l N_l) / \partial p_l &= (N_h + N_l) + p_l (\partial N_l / \partial p_l)_{\Delta p} \geq 0 \end{aligned}$$

with equality if the capacity constraints are not binding.

The structure is recursive because the cross effect is not present in the first condition in (A5) but appears in the form of the term in N_h in the second condition (if $\beta_h < \beta_l$, the recursion goes in the opposite direction, from second to first class). Assuming second order conditions, the first equation in (A5) determines Δp uniquely. Then p_l is chosen to exclude some L buyers. As p_l is increased, it increases the revenue of both classes of service because p_h is adjusted conformably to hold the difference constant. This is why N appears in the second equation. Marginal revenues are driven down to zero if capacity constraints aren't binding. Marginal revenue cannot be negative. If a capacity constraint binds, marginal revenue is positive, but cannot be reduced any further because no tickets are left.

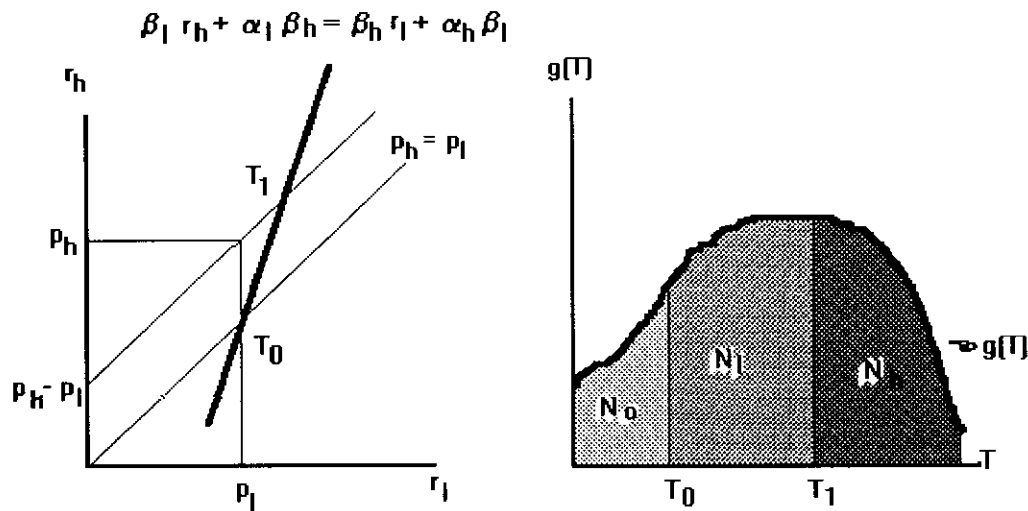

2. Demand functions

Following the text, we have

$$N_h = \int_0^{p_l} \int_{p_h}^{\infty} f(r_h, r_l) dr_h dr_l + \int_{p_l}^{\infty} \int_{p_h - p_l - r_l}^{\infty} f(r_h, r_l) dr_h dr_l$$

$$N_l = \int_{p_l}^{\infty} \int_0^{p_h - p_l - r_l} f(r_h, r_l) dr_h dr_l$$

Taking care to differentiate all the terms under the integrals

$$\frac{\partial N_h}{\partial p_h} = - \int_0^{p_l} f(p_h, r_l) dr_l - \int_{p_l}^{\infty} f(p_h - p_l + r_l, r_l) dr_l \equiv - \frac{\partial N_h}{\partial p_l} + U_{lh}$$

$$\frac{\partial N_h}{\partial p_l} = \int_{p_l}^{\infty} f(p_h - p_l + r_l, r_l) = \frac{\partial N_l}{\partial p_h}$$

$$\frac{\partial N_l}{\partial p_l} = - \int_{p_l}^{\infty} f(p_h - p_l + r_l, r_l) dr_l - \int_0^{p_h} f(r_h, p_l) dr_h \equiv - \frac{\partial N_l}{\partial p_h} + U_{ll}$$

3. The Quality of Service

With Figure 5 preferences consumer surplus is defined as

$$\begin{aligned} Surplus &\equiv \int_{r_l^*}^{\infty} \int_{\Delta r^* + r_l}^{\infty} (r_h - C_h(q_h)) f(r_h, r_l; q) dr_h dr_l \\ &+ \int_{r_l^*}^{\infty} \int_0^{\Delta r^* + r_l} (r_l - C_l(q_l)) f(r_h, r_l; q) dr_h dr_l \end{aligned}$$

where $\Delta r^* = r_h^* - r_l^*$ and the marginal customers satisfy $r_h^* = C_h(q_h)$ and $r_l^* = C_l(q_l)$. Taking care to differentiate under the double integrals,

$$\begin{aligned} \frac{\partial Surplus}{\partial q_h} &= -C_h'(q_h) N_h + \int_{r_l^*}^{\infty} \int_{\Delta r^* + r_l}^{\infty} (r_h - C_h) \frac{\partial f}{\partial q_h} dr_h dr_l \\ &+ \int_{r_l^*}^{\infty} \int_0^{\Delta r^* + r_l} (r_l - C_l) \frac{\partial f}{\partial q_l} dr_h dr_l = 0 \end{aligned}$$

$$\begin{aligned} \frac{\partial Surplus}{\partial q_l} &= -C_l'(q_l) N_l + \int_{r_l^*}^{\infty} \int_{\Delta r^* + r_l}^{\infty} (r_h - C_h) \frac{\partial f}{\partial q_l} dr_h dr_l \\ &+ \int_{r_l^*}^{\infty} \int_0^{\Delta r^* + r_l} (r_l - C_l) \frac{\partial f}{\partial q_l} dr_h dr_l = 0 \end{aligned}$$

If $dq_h > 0$ shifts $f(r_h, r_l)$ up and $dq_l > 0$ shifts it to the right, close inspection of figure 5 reveals that the cross derivatives in these expressions tend to be negative.

4. Pricing Complements

The first-order conditions for maximizing (8) with respect to p and w are

$$\int_{\theta^*}^{\infty} dA(\theta) - pa(\theta^*)/r_{\theta} + (w-k) \left[\int_{\theta^*}^{\infty} \frac{\partial z(\theta)}{\partial w} dA(\theta) - z(\theta^*)/r_{\theta} \right] = 0$$

$$\int_{\theta^*}^{\infty} z(\theta) dA(\theta) - pz(\theta^*)a(\theta^*)/r_{\theta} + (w-k) \left[\int_{\theta^*}^{\infty} \frac{\partial z(\theta)}{\partial w} dA(\theta) - z(\theta^*)^2/r_{\theta} \right] = 0$$

where $a(\theta)$ is the density of $A(\theta)$. Multiply the first equation by $z(\theta^*)$ and subtract it from the second to get

$$\int_{\theta^*}^{\infty} [z(\theta) - z(\theta^*)] dA(\theta) + (w-k) \int_{\theta^*}^{\infty} \left[\frac{\partial z(\theta)}{\partial w} - z(\theta^*) \frac{\partial z(\theta)}{\partial p} \right] dA(\theta) = 0$$

Noting that $\partial z/\partial p = -\partial z/\partial(y-p)$ is an income effect and that $\partial z^*/\partial w = \partial z/\partial w + z(\partial z/\partial y) = \partial z/\partial w = -z(\partial z/\partial p)$ is the compensated own price effect gives the equation in the text.

For two classes of service let the utility function in the text refer to first class service, so that θ is the ordering variable for r_h when w is changed for complementary services to first class customers. Define an analogous utility function if the person occupies a second class seat, with r_l and ϕ as reservation price and intensity ordering corresponding to complementary service price w , with $\partial r_l/\partial \phi > 0$. Denoting the joint distribution by $A(\theta, \phi)$, and using the partition in figure 1 over θ and ϕ , profit is

$$\begin{aligned} & \int_0^{\phi^*} \int_{\theta^*}^{\infty} (p_h - (w-k)z_h(\theta, w, p_h)) dA + \int_{\phi^*}^{\infty} \int_{\theta^* - \phi^* + \phi}^{\infty} [p_h - (w-k)z_h(\theta, w, p_h)] dA \\ & + \int_{\phi^*}^{\infty} \int_0^{\theta^* - \phi^* + \phi} [p_l + (w-k)z_l(\phi, w, p_l)] dA \end{aligned}$$

where z_h and z_l refer to consumption of those occupying H-class and L-class seats, $p_h = r_h(\theta^*, w)$ and $p_l = r_l(\phi^*, w)$. If w can be chosen for each class separately the formula in the text holds within each class. If w must be the same for all, the equivalent condition boils down to a kind of average

$$w-k = \frac{\iint_H (z_h(\theta) - z_h(\theta^*)) dA + \iint_L [z_l(\phi) - z_l(\theta^*)] dA}{-\iint_H \left[\frac{\partial z_h^s}{\partial w} + (z_h - z_h^*) \frac{\partial z_h}{\partial p_h} \right] dA - \iint_L \left[\frac{\partial z_l^s}{\partial w} + (z_l - z_l^*) \frac{\partial z_l}{\partial p_l} \right] dA}$$