

Chapman, Duane

Working Paper

Energy Conservation, Employment, and Income

Staff Paper, No. SP 77-06

Provided in Cooperation with:

Charles H. Dyson School of Applied Economics and Management, Cornell University

Suggested Citation: Chapman, Duane (1977) : Energy Conservation, Employment, and Income, Staff Paper, No. SP 77-06, Cornell University, Charles H. Dyson School of Applied Economics and Management, Ithaca, NY,
<https://doi.org/10.22004/ag.econ.184416>

This Version is available at:

<https://hdl.handle.net/10419/276497>

Standard-Nutzungsbedingungen:

Die Dokumente auf EconStor dürfen zu eigenen wissenschaftlichen Zwecken und zum Privatgebrauch gespeichert und kopiert werden.

Sie dürfen die Dokumente nicht für öffentliche oder kommerzielle Zwecke vervielfältigen, öffentlich ausstellen, öffentlich zugänglich machen, vertreiben oder anderweitig nutzen.

Sofern die Verfasser die Dokumente unter Open-Content-Lizenzen (insbesondere CC-Lizenzen) zur Verfügung gestellt haben sollten, gelten abweichend von diesen Nutzungsbedingungen die in der dort genannten Lizenz gewährten Nutzungsrechte.

Terms of use:

Documents in EconStor may be saved and copied for your personal and scholarly purposes.

You are not to copy documents for public or commercial purposes, to exhibit the documents publicly, to make them publicly available on the internet, or to distribute or otherwise use the documents in public.

If the documents have been made available under an Open Content Licence (especially Creative Commons Licences), you may exercise further usage rights as specified in the indicated licence.

ENERGY CONSERVATION, EMPLOYMENT,
AND INCOME

By

Duane Chapman

May 1977

No. 77-6

Abstract

Energy Conservation, Employment, and Income

The problem considered is whether energy conservation has in aggregate positive or negative effect upon employment and national income. The macroeconomic study of the national economy has conventionally assumed that resource availability is not relevant to national policy or aggregate income. The emphasis in macroeconomics on cyclical fluctuations of a few quarters or years duration has meant that structural characteristics in particular kinds of activities are difficult to isolate in a manner relevant to public policy. As a consequence, macroeconomics has focused upon tax, expenditure, and monetary policies to stimulate or restrain investment, consumption, and government activities without regard to the nature or composition of that which is the object of policy. By inference, the utilization of the Phillips curve concept will predict that an exogenous source of energy price increases (such as OPEC oil pricing or declining U.S. resource availability) will result in higher levels of unemployment for every inflation rate. Macroeconomics generally implies that energy use and investment must both increase if employment and income are to grow.

In contrast, recent microeconomic studies of the relationship between energy, labor, and capital in manufacturing conclude (in general) that broad possibilities for substitution between factors exist in the long run. We may anticipate that macroeconomics will begin to reflect the potential for factor substitution and the importance of resource limitations.

Since the oil price increase in 1974, the U.S. economy has experienced the greatest disemployment in energy using sectors, and the greatest price increases have taken place in these same sectors. Also since 1974, real petroleum product prices have declined while natural gas, coal, and electricity prices have risen. Present capital tax subsidies lower the effective prices of capital and energy, while employment taxes raise the effective cost of labor. Given the existence of substitutability between labor, energy, and capital, these price distortions reduce employment and stimulate energy use. The present business recovery is influenced by conventional macroeconomic fiscal policy, by existing factor price distortions, and by the three year decline in real petroleum product prices. As a consequence, it is probable that the nature of the current recovery will make the future transition to a less energy intensive economy more difficult.

ENERGY CONSERVATION, EMPLOYMENT,
AND INCOME

By

Duane Chapman*

This essay has been prepared for my colleagues on the Energy Demand and Conservation Panel of the National Academy of Science Committee on Nuclear and Alternative Energy Systems, and for the session on Energy Policy Models at the San Francisco meeting of The Institute of Management Science and the Operations Research Society of America, May 10, 1977. Acknowledgement is due the Cornell University College of Agriculture and Life Sciences, the Department of Agricultural Economics, and to Kate Livingston, Ellen Hornig, Clark Bullard, Ernst Berndt, Tim Mount, and Joseph Baldwin for their assistance and comments.

*Associate Professor of Resource Economics, Department of Agricultural Economics, Cornell University, Ithaca, New York 14853.

Energy Conservation, Employment, and Income

1. Conservation
2. Macroeconomic Theory
 - The IS-LM Model
 - OPEC Pricing and the Phillips Curve
 - Empirical Models: Brookings, BEA, Wharton
3. Substitutability in Energy, Capital, and Labor
 - Berndt and Wood
 - Hudson and Jorgenson
 - Griffin and Gregory
 - Hannon and Bullard
 - Distortion in Factor Prices
4. The Energy-GNP Ratio
5. Post-Embargo Developments
 - Energy Induced Inflation
 - Disemployment
 - Capital Intensity
 - Investment in Conservation
6. Prospective Policies
 - Capital Tax Subsidies
 - Employment Decumulation
 - Absence of Substitutes
 - Energy Taxes

1. Conservation

The meaning of conservation is primarily philosophical, an attitude about the human community and the natural environment. Throughout America's history it has had two emphases which have often been in conflict. One line of thought, developed in the early part of this century by John Muir and the Sierra Club, saw the natural environment as having special significance for humanity's adaptation to society. Natural environments, this view holds, often merit their own special rights and privileges which should protect them from major development activities.

The second view of conservation is represented by Gifford Pinchot. It holds that development of natural resources is in general a positive thing, but asserts a public interest in the matter which is in addition to (or in conflict with) private rights to development.

Sometimes the two viewpoints will coincide: to promote strip mine regulation, or advocate continued Federal ownership of Federal forest land. At other times the two aspects of conservation are in sharp conflict. In fact, these two views of conservation first entered into serious opposition over an energy problem, the Hetch-Hetchy project. Simply stated, the one view valued the Hetch-Hetchy valley as the equal of the other Yosemite, Yosemite Valley. The second view valued the site for its potential as an inexpensive source of water and power.^{1/}

It seems that the development of the concept of energy conservation is a modern marriage of the earlier schools of thought. Energy conservation seems to presume that energy is necessary for economic welfare, but at the same time it carries an important element of "less is better." This latter tendency probably relates the use of finite energy resources (uranium, gas, oil, coal) to environmental impact, and perhaps as well to unarticulated values about social structure.

Economics tries to unite each view of conservation while working with the economics of private development. Economists have developed the concepts of amenity rights, options, and generational equity to reflect the values of the first school. And the public regulation and development perspective has led to the development of benefit-cost analysis and other methods which attempt to weigh public and private gains and losses.

The basic purpose has been to develop criteria for overall economic efficiency which consider relevant aspects of monetary and non-monetary values. It should be noted that the analysis of the interaction of public and private values has a long tradition in economics, being expressed in a comprehensive manner by Ciriacy-Wantrup in 1952^{2/} and arising out of earlier work in the United States and Europe. It should not be presumed that economics has succeeded in this endeavor of creating a ledger for the debits and credits of wilderness, health, income, and assets. I mean only to say that economics has addressed the problem.

^{1/} John Muir, "Let Everyone Help to Save the Famous Hetch-Hetchy Valley," San Francisco, 1909.

^{2/} S. V. Ciriacy-Wantrup, Resource Conservation: Economics and Policies, Berkeley, 1952.

All this is introductory to the problem of defining energy conservation in an economic framework. Darmstadter and Schipper seem to mean that energy conservation is any act that reduces energy use, or reduces it below what was otherwise anticipated.^{3/} This is the view we noted above. If energy prices rise and less energy is used, energy conservation is taking place. But does this mean that if an energy price falls and demand rises that waste is taking place? If energy conservation is a positive attribute of social behavior, what is its negative, its opposite? Do we value equally growth or decline in use of clean and dirty fuels, or renewable and finite resources?

An economist is unlikely to provide interesting answers. Our approach is to attempt to place these things in the calculus of public and private gain and loss, and to see if there may be clear conditions under which specific actions may promote or retard economic efficiency. (Again, recall that we mean efficiency in the context of both, and perhaps conflicting, public and private values.)

In economic terms, at least six types of energy conservation can be described. Energy conservation could mean shifting demand functions with unchanged coefficients, greater long run energy price response or lesser income response, reduced demand in reaction to price increases, or a reduction in the time required for demand to adjust to new circumstances. Finally, in a broad context, we could consider conservation to be any lower level of energy use than that which had been expected. These six concepts are shown in Figure 1.

Figure 1-A shows a shift in an energy demand function in which the parameters (and price and income elasticities) are unchanged.^{4/} Less energy is consumed at the same price level. This is the Mount/Tyrrell finding with respect to energy demand functions in 1974.^{5/} Figure 1-B shows demand function D_1 with a greater responsiveness to price than function D_0 . In fact, there are indications that price responsiveness itself increases as prices rise.^{6/} Figure 1-C shows demand function D_1 with a lesser income response. In a manner analogous to the price response, the income response may decline as incomes rise.^{7/} Figure 1-D simply shows a fixed demand function with less

^{3/} "Energy Demand and Conservation," Energy Demand and Conservation Panel Report, National Academy of Science Committee on Nuclear and Alternative Energy Systems, Ch. 2, draft, April 1977; also Lee Schipper and Joel Darmstadter, "What is Energy Conservation?" Lawrence Berkeley Laboratory, January 4, 1977.

^{4/} An elasticity is approximately defined as the percentage change in demand caused by a one percent increase in an economic factor. For example, if an income elasticity is +0.5, a 1% increase in income causes an increase in demand of one-half of 1%.

^{5/} Tim Mount and Tim Tyrrell, "Energy Demand: Conservation, Taxation, and Growth," Appendix B in Energy Demand and Conservation Panel Report, *op cit.*

^{6/} T. D. Mount et al., "Electricity Demand in the United States: An Econometric Analysis," Oak Ridge National Laboratory, Oak Ridge, Tenn., June 1973, p. 10. Suppose $Q = \alpha P^\beta$. In Fig. 1-A, the shift in demand means α_1 is less than α_0 , but the price response β is unchanged. Fig. 1-B has β_1 (the price response) with a greater magnitude than β_0 in the range of actual demand.

^{7/} Idem.

FIGURE I. ENERGY CONSERVATION

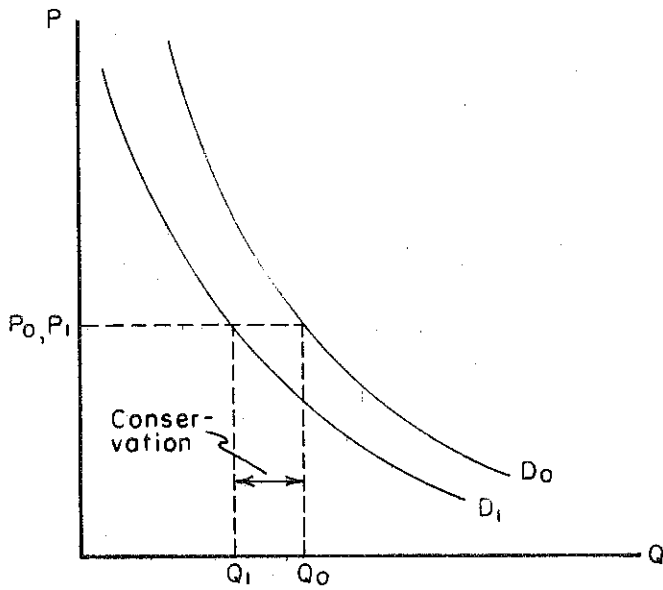

Fig. I-A Shift in demand

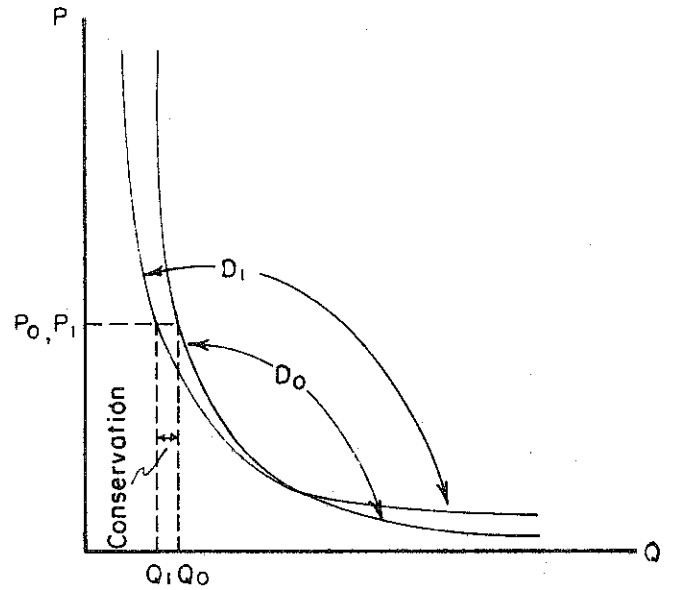

Fig. I-B Greater price response

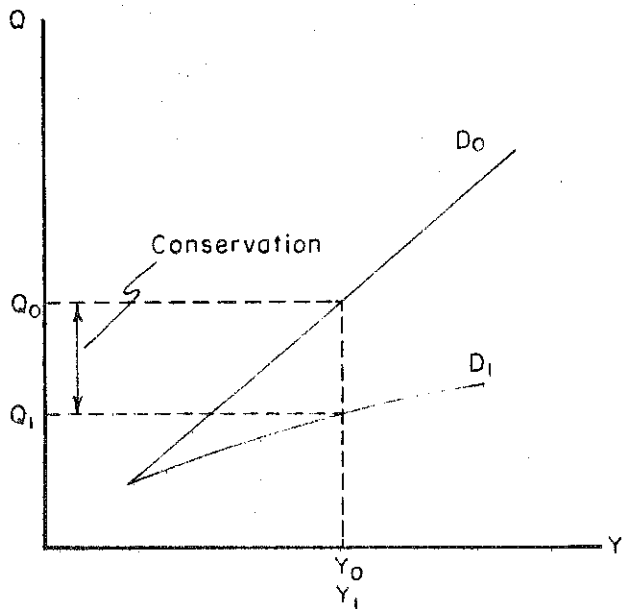

Fig. I-C Lesser income response

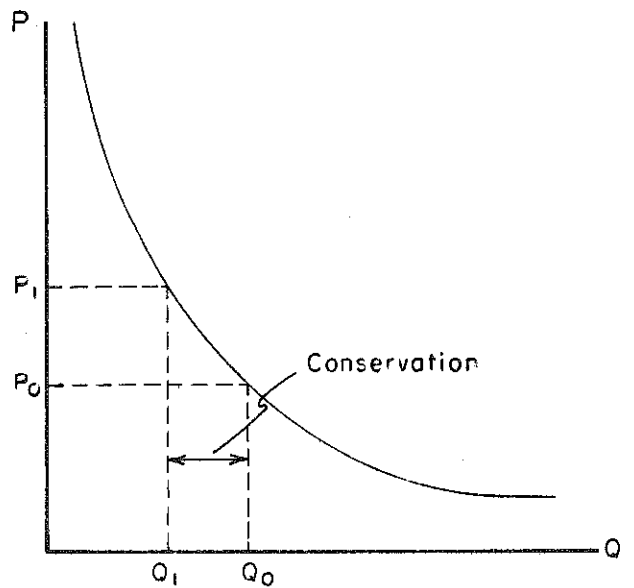

Fig. I-D Price response

FIGURE 1. CONTINUED

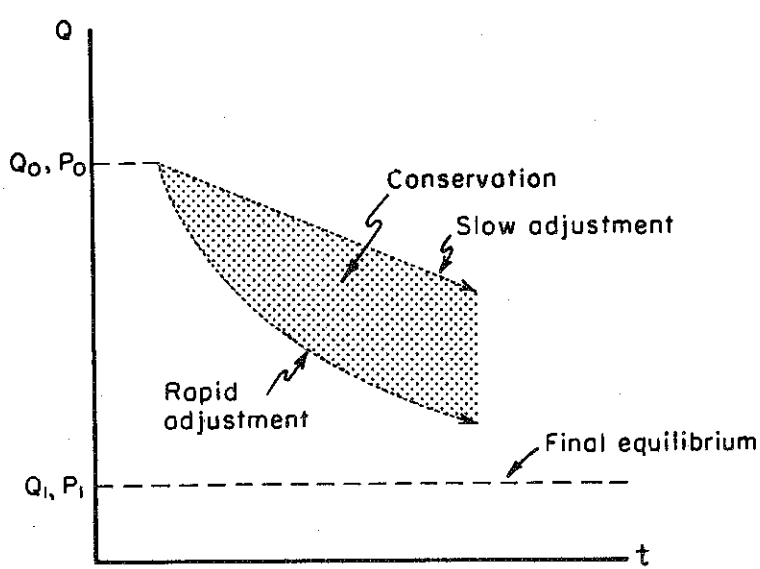

Fig. 1-E Reduced lag in response

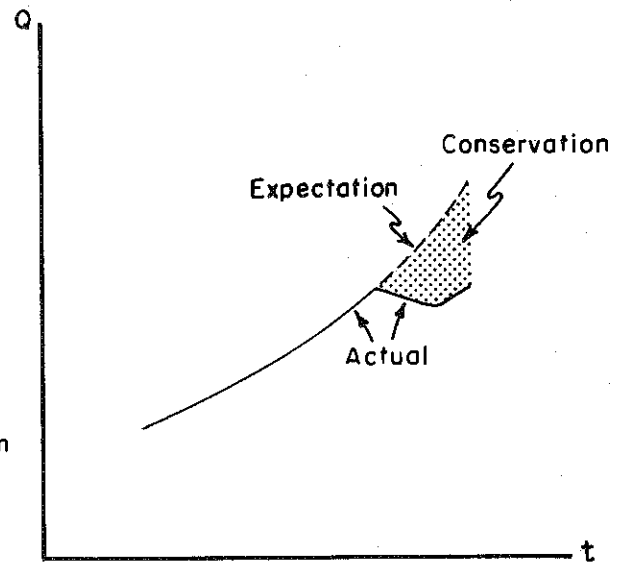

Fig. 1-F Less than expected demand

Figures 1-A to 1-D show new energy Q_1 resulting from the various types of conservation. The amount of conservation is always the difference between Q_0 and Q_1 . In Figures 1-E, 1-F, conservation is the product of changing energy use over time and is equal to the shaded area.

energy being purchased at the higher price. This latter phenomenon explains much of the geographic variation in energy use and part of the recent change in energy growth rates.

Figure 1-E shows differential change over time in response to different lengths of time necessary for adjustment in consumption. Starting in year 0 with price P_0 and energy use Q_0 , the price increases to P_1 . The new equilibrium level of use (other things being constant, which of course they are not) is Q_1 . In general, because of the slow rate of replacement of machines, vehicles, and appliances, and the time necessary for consumer classes to determine their responses to changed economic conditions, the movement from Q_0 to Q_1 is not immediate but takes place over many years. If the time necessary for adjustment is short, energy use will be lower in succeeding years than with a longer adjustment period, although both paths eventually reach Q_1 .^{8/} Public education programs may have substantial effect upon this time lag in response, and this lag may itself decline as prices rise.

Figure 1-F simply shows conservation defined as departure from previous trends. In addition to the economic influences enumerated here, Figure 1-F may reflect temporary climatic or business cycle variation, or long run societal changes in birth rate, household formation, geographic patterns, and so on.^{9/}

Thus it is apparent that in considering the effect of energy conservation on employment or income, we must consider the economic mechanisms by which energy is conserved. If energy use falls because of a decline in income levels, the relationship between energy conservation and employment will be quite different than the case where energy prices rise and energy use falls in a period of rising incomes.

In determining the effect on employment of energy conservation, we may easily construct countervailing examples which illustrate positive and negative impact. In transportation, higher energy prices result in higher costs for vehicles, roadways, terminals, and fuel. In intercity transportation of freight and passengers by truck and bus, much higher diesel fuel costs make lower operating speeds more efficient. With constant loads and labor paid a time rate, it becomes

^{8/} In its simplest form, the geometric adjustment function is

$$Q_t = \lambda Q_{t-1} + \sum_{j=1}^n \beta_j X_{jt}$$

This is an equation in logarithms, with Q_t being energy demand in year t , λ the lag coefficient, X_j 's the n economic influences, and β_j 's the short run elasticities. A relationship where $\lambda = .9$ will take much longer to adjust than if $\lambda = .6$.

^{9/} These influences could be defined in such a way as to appear in Figure 1-A or elsewhere in Figure 1.

profitable to employ more drivers (even with a fixed stock of vehicles) operating at slower, more fuel efficient speeds. For a fleet with constant vehicle miles, reducing the actual speed from 75 mph to 60 mph should increase the labor requirement on the average by 20%. However, it is evident that vehicle miles may not stay constant. Passengers and freight may shift from motor vehicles to train, car, or air modes. The labor intensity of these transportation forms vary, and the net employment effect will reflect the change in composition and level of transportation.

In agriculture, much higher diesel oil, tractor, and equipment prices may simultaneously reduce efficient manhours and efficient equipment use for a given acreage. A corn farmer in western New York may simply drop one application of herbicide from his cultivation schedule, thus reducing labor, energy, capital, and output.

In industry, much higher natural gas and petroleum prices may make some kinds of operations such as chemical manufacture too costly to continue in some parts of the country. As a consequence, employment is eliminated in the industries which are discontinued.

We have developed two aspects of the labor substitution question here. First, how constant or variable is the relationship of labor and energy in each type of production? Second, how do energy prices influence employment by influencing product prices, the demand for different kinds of products, and therefore the labor used in production? While different illustrations can show positive or negative effects, the major question here is the net employment effect upon the economy.

2. Macroeconomic Theory

Consider a simple macroeconomic model^{10/} with 20 economic variables as expressed in these relationships:

$$(1) \quad s(y, t, a) + t(y) + f(y, P_y, P_f) = i(r, y) + g + x(P_y, P_x)$$

$$(2) \quad \frac{M(r; x - f)}{P_y} = m(r, y)$$

$$(3) \quad m(r, y) = l(r) + k(y)$$

$$(4) \quad y = y(N, K)$$

$$(5) \quad W^D = P_y \cdot f(N)$$

$$(6) \quad W^S = h(P_y, N)$$

$$(7) \quad W^D = W^S$$

$$(8) \quad c = y - s - t$$

Equation (1) indicates that savings, taxes, and imports equal investment, government expenditures, and exports: $s + t + f = i + g + x$. Savings are positively related to real Gross National Product (y), but negatively related to taxes. Savings decline with higher levels of real assets (a). Taxes rise with real GNP.

^{10/} See William H. Branson, Macroeconomic Theory and Policy, Harper and Row, 1972.

Investment (i) is negatively related to interest rates (r) but positively related to real GNP. The demand for imports (f) grows with higher GNP and higher domestic prices (P_y).

However, the demand for imports may either rise or fall in response to increases in foreign prices (P_f). If the demand for imported oil is in the short run relatively unresponsive to the price paid, then an increase in this price will cause a small reduction in the physical quantity imported but a very large increase in total revenue collected by foreign groups selling oil to the United States. Conversely, if the demand for imported oil is very responsive to the price change, a higher price P_f will lower the dollar value of imports.

These relationships, taken together, define the Investment-Savings (IS) equilibria which link real GNP to interest rates. In Figure 2-A, the different feasible levels of y and r are shown in detail. Figure 2-B expands the IS curve in the first quadrant.

Assume that the demand for imported oil is relatively insensitive to price P_f in the short run. An increase in the OPEC price will shift the investment-savings equilibria in such a way that lower real GNP will be associated with each interest rate level. Beginning in the southeast quadrant of Figure 2-A, an increase in dollars spent on imported oil will rotate the $s + t + f$ ray clockwise, meaning that for every level of real GNP there is now a greater demand for savings, taxes, and imports. This results from the reduced consumption demand and the increased savings demand as well as the greater import expenditures.

In the very short run, export levels are unaffected and the $i(y) + g + x$ function is unchanged. The immediate effect of imported oil price increases, then, is to shift the IS relationship leftward. Inevitably some of these newly transferred funds will be put to use to purchase American exports, and the $i(y) + g + x$ function in the northwest quadrant will shift outward, causing an influence on IS opposite to the import/savings effect. In the long run, if imported oil demand was very sensitive to P_f , f might decrease, reversing cause and effect.

However, in the short run of one to five years, higher imported oil prices raise f more than x and place IS in a new position: compare original IS and later IS* in Figure 2-B.^{11/}

In Equation (2), the real supply of money is equal to the nominal supply of money $M(r; x - f)$ deflated by the price level P_y . The nominal supply of money^{12/} is influenced by two factors: the interest rate r and net exports $x - f$. The nominal money supply rises with interest rates. Suppose there is a

^{11/} An alternative explanation with the same result would view the higher oil prices as a tax collected by the OPEC countries. The $s + t + f$ ray would again move clockwise, and the analysis would continue to the same conclusion.

^{12/} Here money supply M can be viewed as currency in circulation outside of banks and checking account deposits. For some purposes savings account deposits may be included in the definition of money supply.

FIGURE 2. THE INVESTMENT-SAVINGS RELATIONSHIP

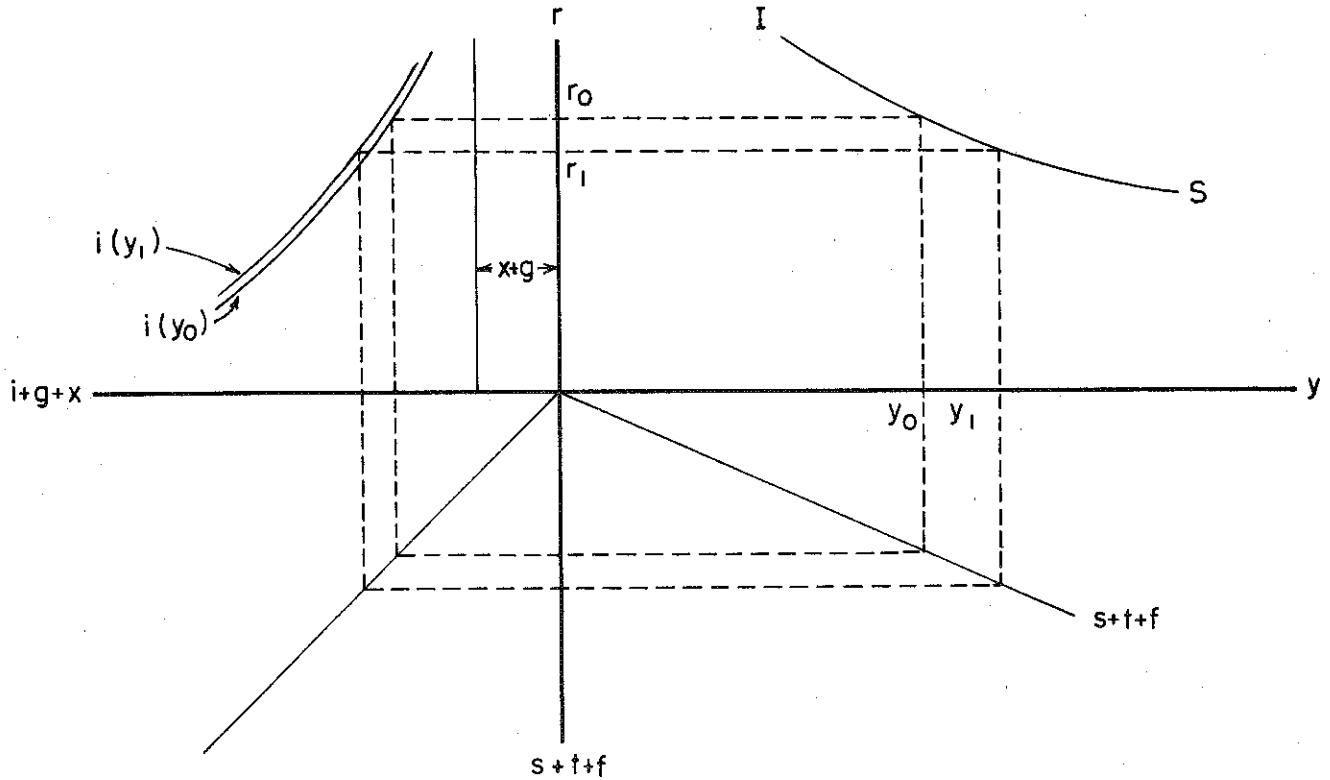

Fig. 2-A With government expenditure and exports fixed, the investment function shifts according to the income level. The equality of savings plus taxes plus imports to investment plus government expenditure plus exports defines the relationship between income and interest rates.

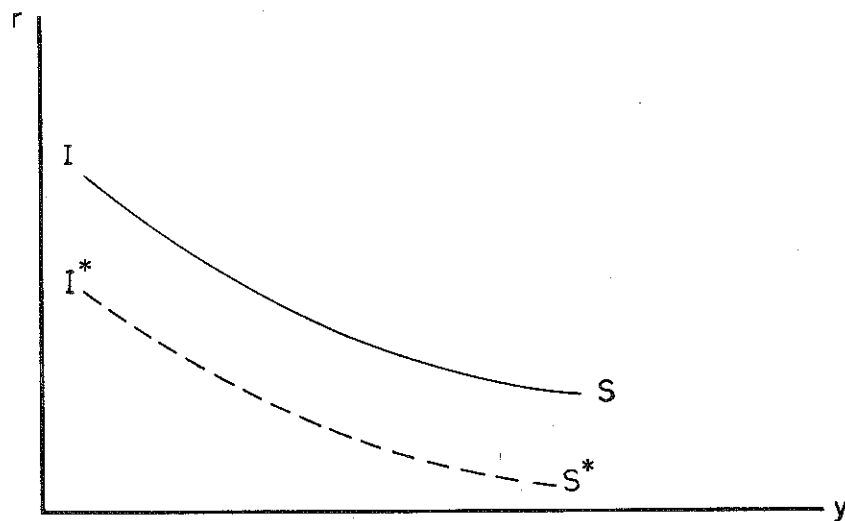

Fig. 2-B The northeast quadrant of Fig. 2-A: the I S relationship.

balance of trade surplus with exports greater than imports.^{13/} These surpluses eventually accumulate as foreign exchange deposits by U.S. banks with the Federal Reserve System, and this expands the money supply.

The real supply of money must equal the real demand $m(r, y)$. Money demand in equation (3) has two components: a liquidity demand for money kept on hand $l(r)$ which falls as business and families bank money when interest rates are higher and a transactions demand $k(y)$ which rises with real GNP.

Figure 3-A shows money market equilibria for these monetary factors, defining an equilibrium relationship between real GNP and interest rates in money markets: the LM relationship.

Assume LM in Figure 3 represented the original money market equilibria relationships before an OPEC oil price increase with exports equal to imports. The price of imported oil rises sharply, causing a balance of payments deficit and a contraction in the money supply. The new LM* is above the earlier equilibria.

Figure 4 summarizes the equilibrium for this simple macroeconomic model. The economy is originally characterized by the investment-savings relationship IS and the money market pattern LM, resulting in equilibrium Gross National Product y and interest rate r .

The other Equations (4) - (7) define employment relationships. Equation (4) states that real GNP depends upon employment N and capital K . Equation (5) shows the demand for labor: profit seeking employers will seek more workers with higher prices but will offer less employment at higher wage levels. In (6), labor supply will be characterized by responding positively to higher wages and negatively to higher prices. Equation (7) requires labor market equilibrium.

So the original IS-LM equilibrium for interest rates and real GNP in Figure 4 also defines the associated levels of employment, wages, and consumption.^{14/}

Now consider the different relationships in the investment-savings and money markets which were associated with the higher oil prices. The new IS* and LM* in Figure 4 define a lower level of real output at a slightly higher interest rate. As a consequence, employment falls.

The illustration given here is somewhat similar to the interpretation of the recent recession given by Arthur Okun.^{15/} Okun attributed the recession to the effects of higher oil prices and higher import expenditures on real disposable income, the reduction in overall consumer demand caused by general inflation, the negative impact of the rise in interest rates on home construction, and the deflationary influence of a declining real money supply.

^{13/} Here considering transfer payments to foreigners and net capital outflow to be kinds of imports which are not explicitly discussed.

^{14/} The emphasis here has been on the savings-investment relationship in Equation (1) and Figure 2. Obviously, Equation (8) suggests that the same result might be achieved by emphasizing consumption. A term for net transfer payments to foreigners is properly required on the right hand side of Equation (8).

^{15/} Arthur M. Okun, "A Postmortem of the 1974 Recession," Brookings Papers on Economic Activity, 1975:1, pp. 207-221.

FIGURE 3. MONEY AND INTEREST RATES: THE LM RELATIONSHIP

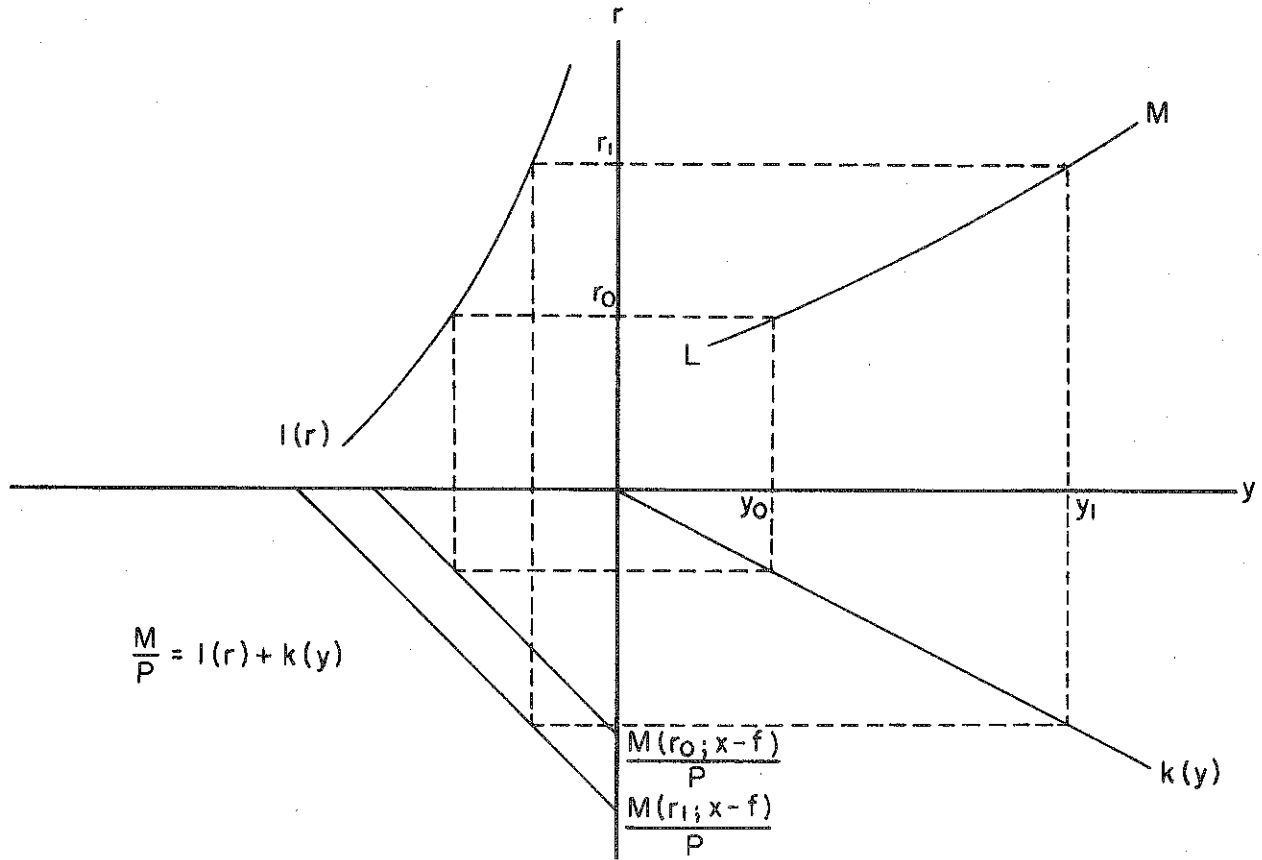

Fig. 3-A Money supply increases with higher interest rates and trade surpluses. Since the sum of transactions and liquidity demand equals money supply, a monetary relationship exists between income and interest rates.

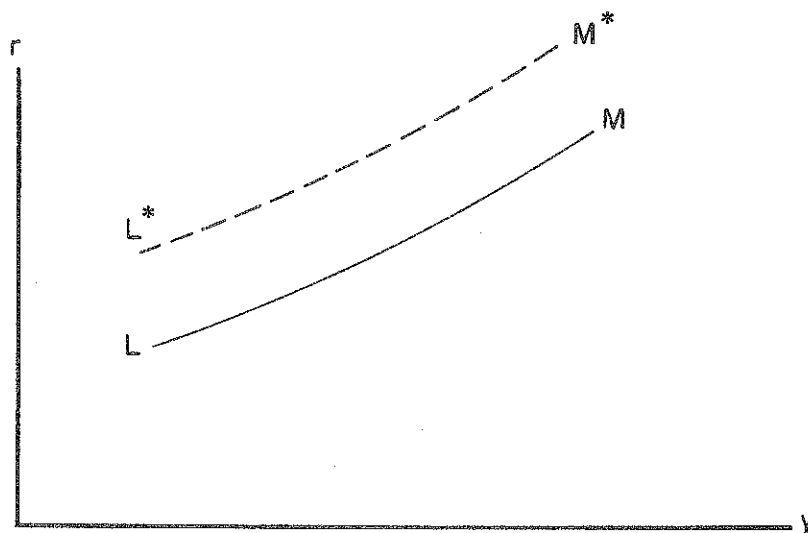

Fig. 3-B The northeast quadrant of Fig. 3-A: the LM relationship.

FIGURE 4. EQUILIBRIUM IN LABOR, MONEY, AND INVESTMENT MARKETS

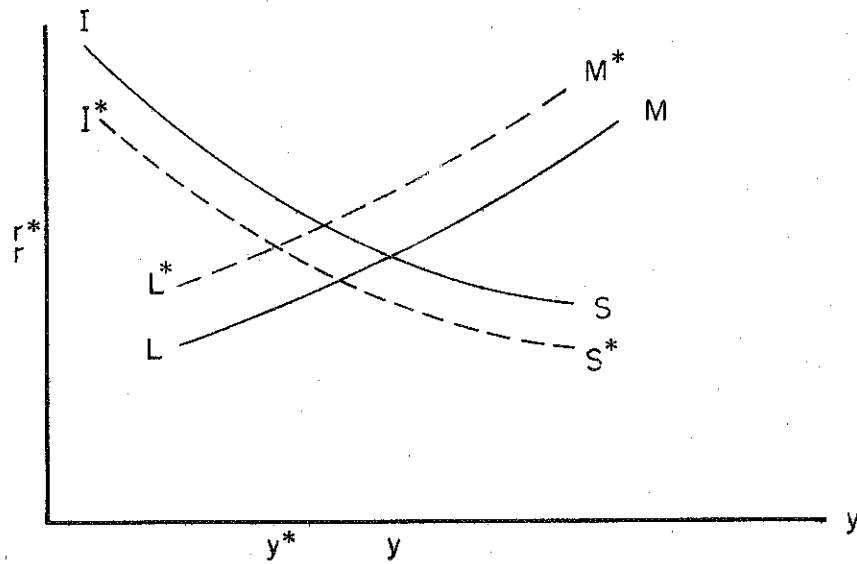

Fig. 6 shows the interaction of IS relationship (Fig. 2B) with the LM relationship (Fig. 3B). The resulting real income and the price level define employment and consumption as well.

Fried and Schultze emphasized other points: monetary and fiscal policy might have maintained output and employment in the face of the shock of higher oil prices by utilizing a policy on income shares. Since no income shares policy existed, the dilemma was a choice between price stability or unemployment. Monetary policy emphasized price stability causing employment and output to fall and unemployment to increase.^{16/}

Macroeconomic theory, then, seems to suggest that higher oil prices mean less employment and real income than would otherwise be the case. The focus is clearly upon a few quarters or years, and the question of long run adjustment is essentially beyond the conventional scope of recent macroeconomics. The appropriate policy responses are seen to be those which stimulate consumption and investment in the face of the shock of higher energy prices.

It might be argued that this assessment is too harsh: the succeeding discussion of the Phillips curve and of recent empirical macroeconomic modeling will buttress these points.

OPEC Pricing and the Phillips Curve

Traditionally, the rise in prices of imported oil is seen as reducing both GNP and employment. The first effects of an increase in imported oil prices are to raise the overall price level, reduce consumption, and reduce the demand for aggregate output. As a consequence, real GNP falls and unemployment grows. Since energy is "conserved" by having energy prices rise as in Figure 1-D, we see the kind of logic which commonly leads to the conclusion that energy conservation, lower GNP, and unemployment are linked.

It should be emphasized that this reasoning is circumstantial. The macroeconomic approach says higher oil prices cause (1) reduced energy use (i.e., "conservation"), (2) lower aggregate demand and production, and (3) less employment. Therefore, we conclude, macroeconomics says energy use and employment move together.

This linkage between inflation (energy-related or not) and unemployment is given special status in the "Phillips" curve^{17/} in Figure 5. According to this reasoning, rising energy prices mean more unemployment to maintain a given overall inflation rate.

With respect to the impact of imported oil prices, it may be argued that this source of inflation is unaffected by U.S. economic circumstances, and, as a result, the Phillips curve shifts outward. An unpleasant consequence is that the post-1974 curve requires greater unemployment to attain the same inflation goal.

^{16/} Edward R. Fried and Charles L. Schultze, Ch. 1, "Overview," in Fried and Schultze, eds., Higher Oil Prices and the World Economy, 1975, p. 57.

^{17/} The relationship is named from the work of A. W. Phillips.

FIGURE 5. OIL PRICES, INFLATION, AND UNEMPLOYMENT: THE PHILLIPS CURVE

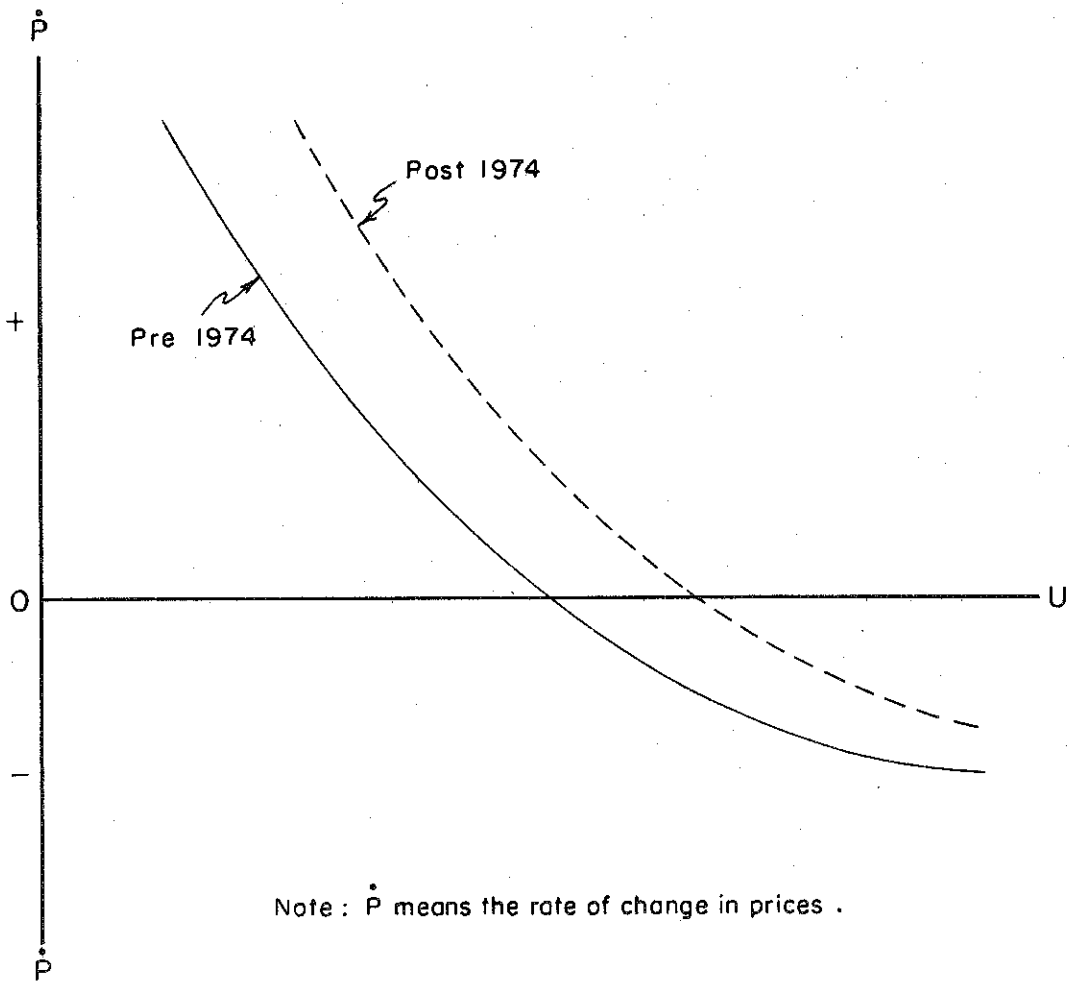

Empirical Models: Brookings, BEA, Wharton

Empirical work is guided by the theory summarized above. In general, applied macroeconomists have reached conclusions similar to those suggested by the theoretical summary above.

The Brookings Institute does not possess a single view on these issues; it publishes work from a variety of participating scholars. Considering this fact, the similarity in view may be somewhat surprising. The first issue in 1975 of the Brookings Papers on Economic Activity^{18/} focused upon the recession.

Modigliani and Papademos^{19/} present a version of the Phillips curve as shown here:

$$(9) \dot{P}_{n,t} = 0.42 + \frac{8.2}{U_t} + 0.68\dot{P}_{n,t-1} - .024\dot{\pi}_t + .081\dot{P}_{mn,t} + .059\dot{P}_{f,t-1}$$

$\dot{P}_{n,t}$ is the inflation rate in the non-food consumer price index (CPI) in year t , $\dot{\pi}$ productivity growth in non-farm business, $\dot{P}_{mn,t}$ is inflation in non-food imports, $\dot{P}_{f,t-1}$ is the past year's inflation in food products, and U_t is the "adjusted" current unemployment rate. (Unemployment is standardized to the 1955 economy, lowering nominal unemployment rates by 1/2% to 1%.)

Rising imported oil prices are reflected in $\dot{P}_{mn,t}$. It is evident that this equation has precisely the structure noted above and shown in Figure 4. Assuming a constant goal for overall inflation $\dot{P}_{n,t}$, price increases in imported oil (and thus a higher rate of $\dot{P}_{mn,t}$) dictate a higher unemployment rate. Other things equal, higher rates of growth in energy prices make higher unemployment appear desirable.

Gramlich^{20/} analyzes a Phillips curve similar to Figure 5. A base case relationship is:

$$(10) \frac{P_t - P_{t-1}}{P_{t-1}} = a_0 + \frac{a_1}{U_t} + \sum_{j=1}^6 b_j \frac{(P_{t-j} - P_{t-j-1})}{P_{t-j-1}} + e_t$$

Here P_t is the overall price level, say, the GNP deflator. U_t is current unemployment. The summation term reflects the continuing impact of inflation over a six year period. Once again, rising energy prices predict greater unemployment for a given inflation rate. Suppose e_t represents a major exogenous increase in energy prices. Then, in succeeding years, unemployment must be higher to reach price stability goals.

Perhaps we should emphasize here that the Phillips curve is a policy-related construct. Crudely put, decision makers select desirable inflation rates and economists indicate the unemployment rates necessary to create the selected inflation rates.

18/ Brookings Papers on Economic Activity, 1975:1.

19/ Franco Modigliani and Lucas Papademos, "Targets for Monetary Policy in the Coming Year," Brookings, op cit., pp. 141-166. The subject of their paper is proper money supply growth: they attribute the recession to faulty monetary policy.

20/ Edward M. Gramlich, "The Optimal Timing of Unemployment in a Recession," Ibid., pp. 167-82.

In the U.S. Bureau of Economic Analysis (BEA) and the Wharton macroeconomic models, aggregate relationships similar to Equations (1) through (8) and the Phillips curve concept are developed.^{21/} The last published version of the BEA model postulated this basic relationship for total output, capital, and labor:

$$(11) \quad \text{PGNP}_t = e^{-.56} e^{.002t} K_t^{.3} L_t^{.7}$$

This is similar to Equation (4). PGNP is potential private gross national product less housing, K is capital stock, and L is potential civilian employment.

First, note the absence of any terms related to energy or natural resources. Basically, the national economy runs on capital and labor. Second, by assumption, the sum of the exponents is 1.0, meaning constant returns to scale. Third, technical progress takes place at 2/10 of 1% per quarter.

By definition and assumption, neither labor nor capital are substitutable for energy. Energy prices enter this model by--when rising--causing inflation in personal consumption price indices, which in turn lowers demand for personal consumption goods, which, in turn, lowers aggregate production and employment.

By implication, this kind of macroeconomic model seems to require energy to be complementary with capital, labor, and income. Increased energy use is apparently required for all three to increase.

The last published version of the Wharton macroeconomic model is similar in concept to the BEA model, although the Wharton model is more developed with respect to structural detail. It defined employment in manufacturing and mining after 1965 as:

$$(12) \quad \ln L_t - \ln L_{t-1} = 0.192 + .430 \ln Q_t - .235 \ln Q_{t-1} - .134(\ln L_{t-1} + .547 \ln K_{t-1})$$

While the exact derivation of this relationship is not clear, it does appear to have these characteristics: (1) It is derived from an assumption of production relationships similar to the BEA equation, a Cobb-Douglas function of the form $Q = \alpha_0 L^{\alpha_1} K^{\alpha_2}$ (2) There is a time path of response to changes

in each factor. (3) Technical change takes the form of a continuing decline in labor requirements for given amounts of capital and output.

As in the BEA model, neither energy nor natural resources entered the production relationships.

Both the BEA and Wharton models have modified versions of the Phillips curve discussed in the theoretical outline above. Both have unemployment lowering wages and lower wages causing less inflation. As we expected, the empirical macroeconomic models imply that growth in oil import prices requires

^{21/} U.S. Bureau of Economic Analysis Staff Paper, No. 22, "The BEA Quarterly Econometric Model," July 1973. Michael D. McCarthy, The Wharton Quarterly Econometric Forecasting Model Mark III, University of Pennsylvania, 1972. Empirical macroeconomic models have more appropriately complex or realistic specifications of the kind indicated in our theoretical summary. The published version of the Wharton model discussed here had 300 variables and 200 structural and accounting equations.

Table 1. Macroeconomic Model Predictions of the Consequences of
Continued High Oil Prices, Differences in the Fourth Quarter, 1977

	Federal Reserve Board Model	University of Michigan Model
Real GNP, billions	-\$49	-\$58
Real exports, billions	+\$17	+\$19
Real disposable personal income, billions	-\$56	-\$63
Unemployment rate, percentage points	+2.4	+1.3
Treasury interest rate, percentage points	+2.6	+1.0
Inflation, GNP deflator, %	+4.6	+5.2

Source: George Perry (see text).

higher unemployment to meet a given goal for price stability.^{22/}

The implications derived here from examination of the structure of national income, employment, and prices in macroeconomic theory and analysis becomes explicit in the work of George Perry.^{23/} Perry worked with Jared Enzler and Saul Hymans to apply the Federal Reserve Board and University of Michigan econometric models to the problem of the macroeconomic response to higher oil prices. Table 1 shows the effects of continued high oil prices through 1977. As expected on the basis of the preceding discussion, the models both forecast lower output and income and higher unemployment, inflation, and interest rates.

This selected summary of macroeconomic theory and analysis has led to three conclusions of interest. First, the nature of the approach is to focus economic policy upon large aggregates. It supposes that economic welfare may be guided by fiscal and monetary policy which stimulates or restrains investment, consumption, or government activity. Second, energy and resource limitations and use have not been explicit parts of aggregate relationships in published work. Apparent substitutability between labor and capital has been limited, in part by the manner of model specification. Third, the present macroeconomic approach to inflation links it to unemployment by means of the Phillips curve concept. Since inflation and unemployment are both policy goals, this approach predicts that an exogenous source of inflation in OPEC pricing or decreasing domestic energy sources must raise the necessary unemployment associated with each inflation rate. These three conclusions, in turn, may lead to a position which holds that energy conservation may reduce income and employment.

In the next section, the microeconomic evidence is reviewed which, in general, arrives at opposite conclusions.

3. Substitutability in Energy, Capital, and Labor

Original work by Berndt and Wood^{24/} has focused upon the empirical nature of observed interactions between energy, labor, capital, and income. They

^{22/} Also, BEA, Wharton, and other models assume that wages may increase as fast as productivity without increasing inflation, and that expectations play a role in price formation.

^{23/} George L. Perry, "The United States," Ch. 2 in Fried and Schultze, *op cit.*, Perry assumed that the average crude oil price of near-\$10/bl in late 1974 would continue through 1977, and compared this to a forecast with a continuation of the \$4/bl price of mid-1973.

^{24/} E. R. Berndt and D. Wood, "Technology, Prices, and the Derived Demand for Energy," Review of Economics and Statistics, August 1975, 57, pp. 259-68, and "Technological Change, Tax Policy, and the Demand for Energy," mimeo, Univ. of British Columbia, 1975. Edward Hudson, Dale Jorgenson, Berndt, and Wood have shown unusual judgment in perceiving the significance of this subject and undertaking empirical investigation of it some years ago.

employ a derivative of a quadratic function to represent manufacturing output relationships:

$$(13) \quad \ln C/Q = \alpha_0 + \sum_{i=1}^4 \alpha_i \ln P_i + 1/2 \sum_{i=1}^4 \sum_{j=1}^4 \gamma_{ij} \ln P_i \ln P_j$$

C is the total cost of manufacturing output, Q is manufacturing output, α_0 is a constant, P_i is the price of factor i, and α and γ represent coefficients. The function in Equation (13) is sometimes termed the "transcendental logarithmic function," or translog function. From this relationship, Berndt and Wood derive the market shares for each production factor:

$$(14) \quad M_k = \frac{P_k K}{C} = \alpha_k + \gamma_{kk} \ln P_k + \gamma_{kl} \ln P_l + \gamma_{ke} \ln P_e + \gamma_{km} \ln P_m$$

M_k is capital's share of manufacturing cost. Labor, energy, and materials have similar functions. Two points should be noted here. First there are always constant returns to scale. Average cost C/Q in (13) is unaffected by the level of Q. Second, in the definition of substitutability, demand for manufacturing output does not fall if factor prices rise.

The emphasis of this work is the degree to which energy is substitutable with capital and labor. This is measured as the elasticity of substitution:

$$(15) \quad \sigma_{ek} = \frac{\gamma_{ek} + M_e M_k}{M_e M_k}$$

σ_{ek} is the substitution elasticity for energy and capital. It is the microeconomic concept often used to investigate the employment/energy/capital question.^{25/} The significance of this measure is shown in Figure 6.

If two factors may each substitute for the other, they are competitive. This is the illustration in Figure 6-A. The demand for each may be unaffected by the price of the other although the ratio of one to the other changes; this is Figure 6-B. Another possibility is that fixed proportions are required, Figure 6-C. Finally, energy and capital might be complementary, in that they must increase or decrease together, and might as a pair be substitutes for labor. Figure 6-D shows energy and capital to be complementary in variable proportions.

Table 2 shows the substitution elasticities computed by Berndt and Wood for U.S. manufacturing for 1971, based upon data for 1947-71. The results are in clear disagreement with the implications of the macroeconomic approach. Labor and energy were moderately substitutable ($\sigma_{le} = 0.68$), but capital and energy were not ($\sigma_{ke} = -3.53$). According to these statistics, increasing energy use reduces employment and requires greater capital.

Another method of representing these relationships is to portray the effect of an energy price increase on labor demand as in Figure 7. Again, possible relationships are competitive, independent, and complementary. The sign of these cross price elasticities will always be the same as the substitution elasticities, although relative magnitudes will change. Table 2 also shows the values for B/W.

^{25/} More precisely, Berndt and Wood work with a version of the Allen elasticity of substitution. As explained by Berndt (personal communication, February 1977), $\sigma_{ek} = \epsilon_{ek} / M_k$ with ϵ_{ek} being the cross price elasticity.

This $\epsilon_{ek} = \partial \ln E / \partial \ln P_k + M_k \eta$ where η represents the price elasticity of demand for output. Berndt points out that the η term is omitted from the substitution studies.

FIGURE 6. SUBSTITUTION ELASTICITIES

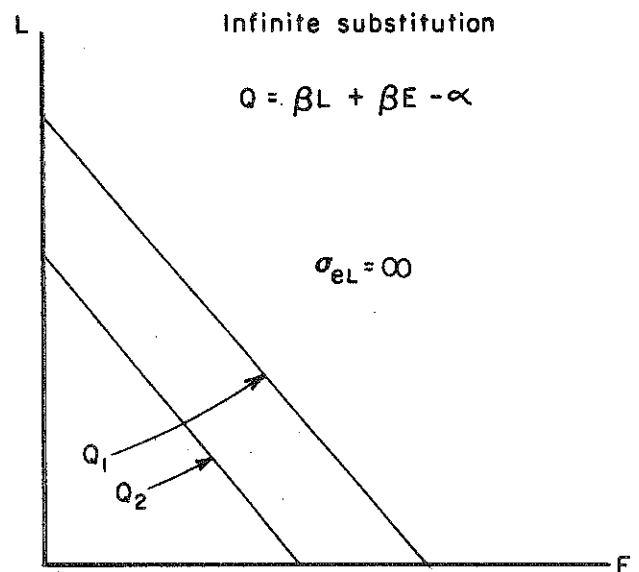

Fig. 6-A Energy can completely replace labor.

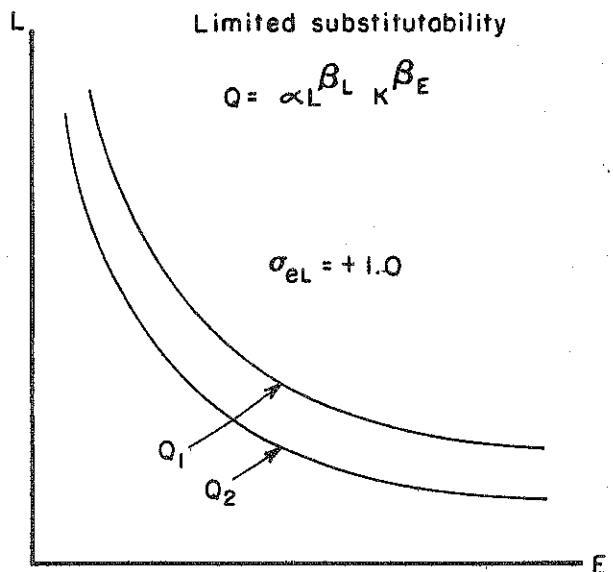

Fig. 6-B Either energy or labor can be used. Best proportions depend upon prices.

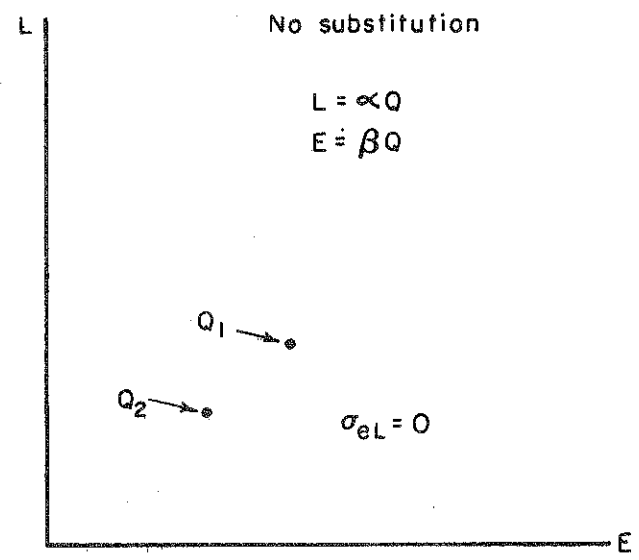

Fig. 6-C Energy and labor are each required in fixed proportions regardless of prices.

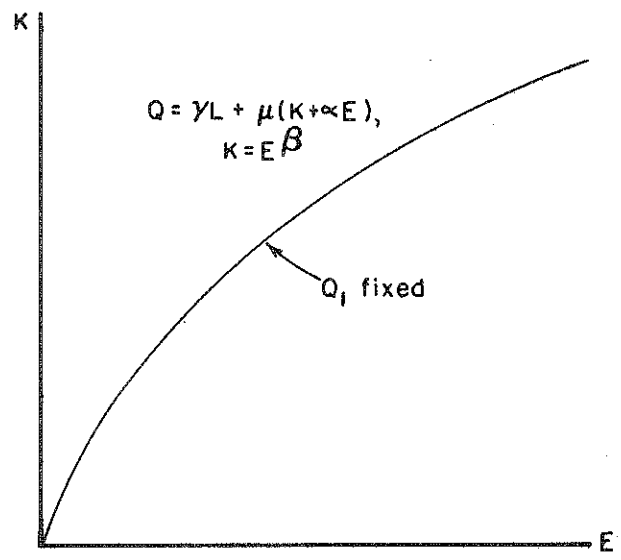

Fig. 6-D Energy and capital are complementary, and both substitute for labor.

Table 2. Berndt-Wood Estimates of Substitutability in
U.S. Manufacturing, 1971, from 1947-71 Data

	<u>Substitution Elasticities</u>		
	Labor	Energy	Materials
Capital	1.01	-3.53	0.49
Labor		0.68	.61
Energy			.75

Quantity/Price	<u>Demand Elasticities</u>			
	Capital	Labor	Energy	Materials
Capital	-.44	.30	-.16	.30
Labor	.05	-.45	.03	.37
Energy	-.17	.20	-.49	.46
Materials	.02	.18	.03	-.24

Note: A positive value means one factor may replace another. A negative value means the absence of substitutability: the two factors are complements and must rise or fall together.

FIGURE 7. SUBSTITUTION EFFECTS: LABOR DEMAND AND ENERGY PRICE

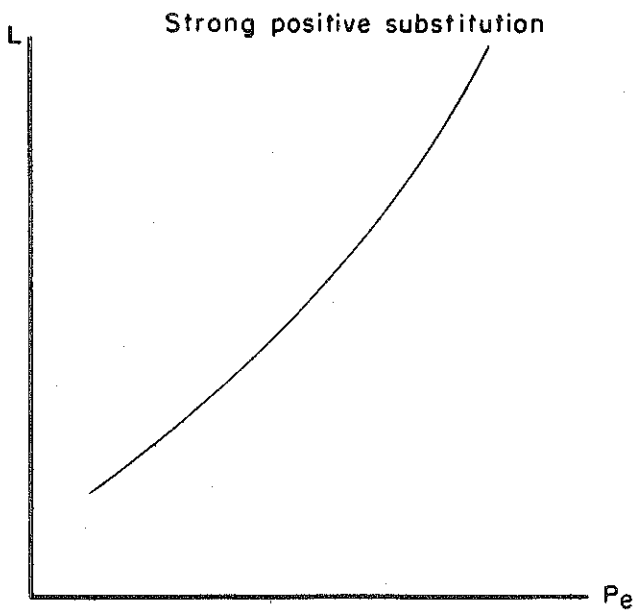

Fig. 7-A Rising energy prices increase employment.

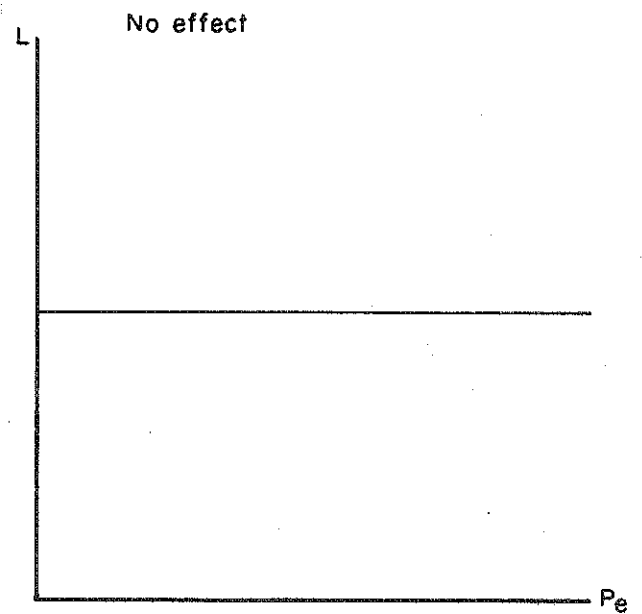

Fig. 7-B Rising energy prices do not affect employment, but may lower E/L ratio.

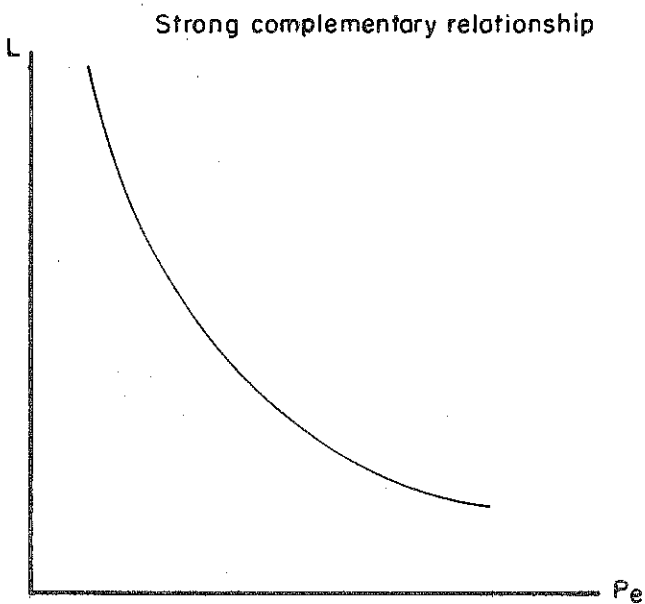

Fig. 7-C Rising energy prices cause employment to fall.

Note that the row sums are all zero: if all prices increase proportionally, factor demand is unchanged. This is a characteristic of the model, not an empirical result. Obviously, if all factor prices increase in manufacturing but less in other types of activity, the demand for manufacturing output will decline causing demand for all factors to fall.

The demand elasticity for energy is $-.5$, high for a short run, annual estimate and probably low for a long run value.

Low capital prices reduce demand for labor and materials and increase energy demand. If the long run values were 5 times the annual values in Table 1, a capital subsidy^{26/} of 10% implies an approximate reduction in labor demand in manufacturing of 3%. A subsidy of 25% to energy prices implies a reduction in labor demand of 4%, and an increase in capital of 26%.^{27/}

Edward Hudson and Dale Jorgenson, colleagues of Berndt and Wood in earlier work, have applied the same methodology to similar U.S. manufacturing data for the same period. Their^{28/} findings appear in Table 3 and generally coincide with the B/W results.

The problem suggested by the absence of a time path of response in the preceding studies was the basis for an international comparison of 8 European countries and the U.S. for 4 selected years in the 1955-69 time span, giving 32 international observations. However, Griffin and Gregory^{29/} were not satisfied with their materials data and excluded it from their analysis.

The results appear to contradict the two other studies. Summarizing both substitution elasticities and demand elasticities, Griffin and Gregory do not find capital and labor to be substitutes (in contrast to B/W and H/J), and Griffin and Gregory do not find capital and energy to be complements (again, in contrast to B/W and H/J). However, all three find labor and energy to be substitutes.

Griffin and Gregory make a methodological advance in analyzing international data with wide variation in capital, labor, and energy use. However, two major problems mitigate the value of this advance. First, the standard errors are high for the important terms. The absolute ratios of coefficients to standard errors are 1.1 for β_{le} , and .07 for β_{ke} . While the coefficient for β_{kl} is 4.2 the value of its standard error, the errors for the substitution and demand elasticities between labor and capital are all larger than the estimated values. These are larger standard errors in estimation than are

^{26/} A capital subsidy is a government tax or expenditure policy which specifically lowers the cost of capital to users. Examples are accelerated depreciation allowances and investment tax credits. This is discussed in greater detail in examining factor market distortions below.

^{27/} A long run elasticity 5 times the values derived from annual data would be equivalent to a lag coefficient of .8 in a geometric lag equation. A long run elasticity of .15 (equal to 5 times the $E_{L,Pe}$ of .03) interacts with an energy price subsidy of 25% as

$$(Q_1/Q_0) = (P_1/P_0)^\beta, \text{ or } (Q_1/Q_0) = (.75)^{.15} = .96$$

^{28/} Cited in James M. Griffin and Paul R. Gregory, "An Intercountry Translog Model of Energy Substitution Responses," American Economic Review, 66:55, pp. 845-57. Unfortunately the original Hudson-Jorgenson paper (Bell Journal of Economics, Autumn 1974, pp. 461-514) does not itself report substitution elasticities.

^{29/} Griffin and Gregory, op. cit.

Table 3. Hudson-Jorgenson and Griffin-Gregory Estimates of Substitutability in U.S. Manufacturing, 1965, from Post-War Data

Quantity/Price	<u>Substitution Elasticities</u>						
	Labor		Energy				
	<u>H/J</u>	<u>G/G</u>	<u>H/J</u>	<u>G/G</u>			
Capital	1.09	.06	-1.39	1.07			
Labor			2.16	.87			

Quantity/Price	<u>Demand Elasticities</u>						
	Capital		Labor		Energy		Materials
	<u>H/J</u>	<u>G/G</u>	<u>H/J</u>	<u>G/G</u>	<u>H/J</u>	<u>G/G</u>	<u>H/J only</u>
Capital	-.42	-.18	.29	.05	-.02	.13	.15
Labor	.14	.01	-.45	-.12	.04	.11	.27
Energy	-.18	.15	.57	.64	.07	-.79	-.46

Note: While Berndt/Wood and Hudson/Jorgenson both analyze U.S. manufacturing data in the post-World War II period, Berndt and Wood (according to Berndt) include petroleum refining in their definition of manufacturing, and Hudson/Jorgenson do not.

usually considered acceptable as a basis for substantive interpretation. The standard errors reported for the Berndt and Wood substitution elasticities are much smaller than the calculated values of the elasticities.^{30/}

Second, Griffin and Gregory, by excluding materials, place 73% of the cost of U.S. manufacturing in 1965 as labor cost;^{31/} Berndt and Wood estimate labor cost at 28%, and Hudson and Jorgenson at 26%. There is wide variation in calculated market shares for energy, being 4% in B/W, 1% or 2% in H/J, and 12.5% in G/G.^{32/}

There is surprisingly little variation over time in factor shares in U.S. manufacturing, according to B/W and G/G. Griffin and Gregory report significant differences between countries.

My interpretation of these results is that the Griffin and Gregory findings may be vitiated by methodological problems. The best technique might combine both the B/W - H/J and the G/G approaches.^{33/}

To summarize the substitution studies at this point, we have seen three studies of labor/capital/energy substitutability arrive at differing conclusions. Two, based upon annual data for U.S. manufacturing, find capital and energy to be complements. The third, an international study, finds capital and energy to be substitutes. As Griffin and Gregory argue, capital in manufacturing and energy may be forced to move together in the short run, but may be long run substitutes.

A similar interpretation of these results is offered by Berndt and Wood in their recent review of substitutability studies.^{34/} They suggest that the 1947-73 era may be characterized as having experienced technological change which saw new capital designed to use more energy and less labor. Their analysis leads them to the same conclusion given above: capital and energy may have been complements in the past and be substitutes with each other and with labor in the future.

On the question of energy-labor substitutability, all three agree. All three probably understate substitution elasticities because their method requires sectoral output to be constant.

^{30/} As reported by G/G, p. 851. Hudson/Jorgenson do not report standard errors for their estimates in the material discussed here.

^{31/} "Intercountry Price and Input Share Data," provided by James Griffin, fall, 1976.

^{32/} For Griffin and Gregory, the denominator for market shares is apparently value added plus expenditures on energy. For B/W and H/J, the denominator is apparently value of shipments plus inventory change.

^{33/} Perhaps using combined cross section and time series data with explicit lag response, applied both within the U.S. and internationally, and with examination of both physical and price variables unrestricted by functional specification. This approach is in part being taken by Ellen Hornig in her study "The Effect of Energy Pricing on Employment in New York State Manufacturing."

^{34/} Ernst Berndt and David Wood, "Notes on Interactions between Consistent Projections of Energy Demand and Aggregate Economic Growth," draft, Jan. 1977, prepared for the Energy Demand and Conservation Panel, *op cit.* In their terminology, the relevant concept is utilized capital, a composite index of energy and capital.

Comparing this information to our discussion of macroeconomics, we recall that the assumed nature of the Phillips curve implies that energy price inflation necessitates higher unemployment, and that capital and labor are substitutable (but not much).^{32/}

However, these substitution studies have not provided information on an important subject. What is the impact of compositional changes: will energy conservation, for example, reduce employment in manufacturing but increase it in services or agriculture and natural resource industries? The Hudson-Jorgenson work has given published answers to this query. In the original article, they reported a 50¢/million Btu tax as having these economy-wide results in 1980: 7.8% reduction in energy use, 0.6% increase in employment, 0.5% increase in capital use, consumer and GNP price increases of about 1%, and reductions in real consumption and GNP on the order of 0.5%.^{36/} However, the basic patterns of economic growth and employment are essentially assumed in this work. In other words, they hypothesize that the labor force and capital stock will be utilized and examine the impact of higher energy prices in this context.

Hannon and Bullard have worked with input-output data for the United States for 1963 and 1967.^{37/} This has two obvious limitations. One is the linear nature of the method; within any industry, capital, labor, energy, and materials must be in fixed proportions (as in Figure 6-C) unless by assumption they are varied. Second, 10 year old data may be irrelevant. However, it is possible that increases in energy intensity since 1967 would accelerate the effects found by them. The time problem is placed in better perspective by noting that Griffin and Gregory's latest data year was 1969, and both B/W and H/J had 1971 as the latest observed year.

The first step in the input-output approach is to calculate the ratios of total energy (direct and indirect) and total labor (direct and indirect) to dollars of final demand for 360 industries. In other words, they estimated the energy/GNP and labor/GNP ratios for each industry. Figure 8 illustrates these estimates. It is not an actual relationship, but a representation of their data.^{38/} What this shows is moderate substitutability (e.g. Figure 6-B) throughout the U.S. economy between energy and labor. A dollar spent on farm products will require more labor and less energy than a dollar spent on chemicals.

^{35/} The elasticity of substitution between labor and capital in the BEA macroeconomic model is always 1.0 as in Figs. 6-B and 7-B. Recall this means capital prices directly affect capital used, but not labor used. The labor/output ratio is unaffected.

^{36/} Hudson-Jorgenson, pp. 504-506. Similar results were reported by D. Behling, R. Dullien, and E. Hudson, The Relationship of Energy Growth under Alternative Energy Policies, March 1976, pp. 135-166.

^{37/} Hugh Folk and Bruce Hannon, "An Energy, Pollution, and Employment Policy Model," Center for Advanced Computation, University of Illinois (Urbana), Feb. 10, 1973; also in Energy Demand, Conservation, and Institutional Problems, M. Macrakis, MET Press, 1974. Clark W. Bullard III and Bruce Hannon, "Energy Growth in the U.S. Economy," April 1976.

^{38/} Figure 8 is based upon Folk and Hannon, 1973, Fig. 3, and represents 1963 relationships. Bullard and Hannon report (personal communication, May 4, 1977) that the 1967 input-output data show the same pattern. Hannon believes the small horizontal branch represents services with high wage activities (e.g., doctors) near the origin and low wage categories (e.g., hospital workers) toward the end. The vertical branch has industries paying low energy prices further from the origin.

FIGURE 8. ENERGY AND EMPLOYMENT INTENSITY IN THE U.S.

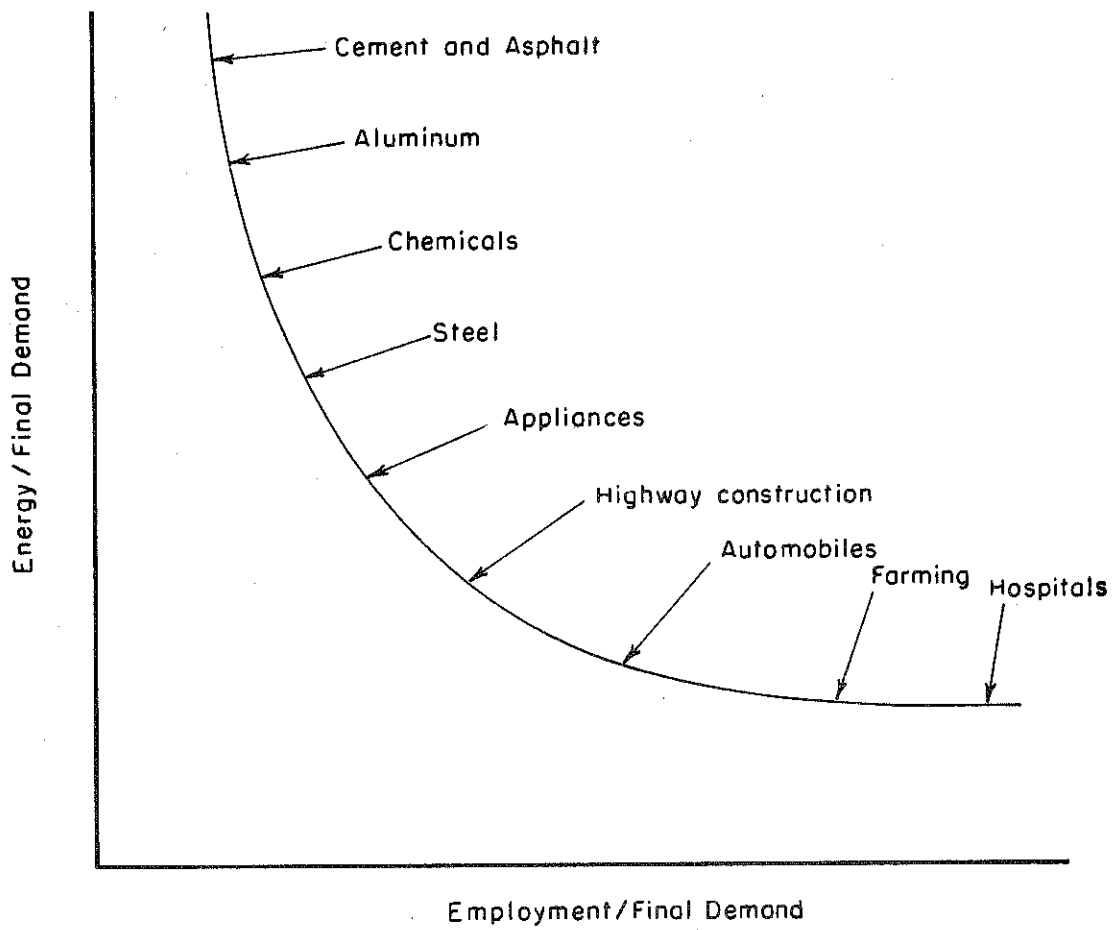

Note: This is a representation of a graph published by Folk and Hannon.

We must remember that this relationship in the Hannon-Bullard work arises only through comparisons of sectors. It does not permit energy and labor to vary within sectors, and may therefore understate substitutability.^{39/}

Three kinds of economic models have been examined: macroeconomic models (and theory), the microeconomic substitution studies, and the input-output analysis of labor and energy intensity in final demand. A heuristic conclusion would utilize the strengths of one kind of model to supersede the weaknesses of another. On this basis, my findings in the matter are as follows: (1) Current macroeconomic concepts are appropriate in the sense that--in the absence of changes of a structural nature--rising energy prices cause unemployment, income loss, and inflation, certainly in the short run of one to five years and possibly for a longer period. (2) The substitution studies point to an underlying economic reality whereby in the long run employment in productive activity may increase to replace energy, and income levels are unchanged or only slightly lessened. (3) The input-output work serves to delineate the changes in composition of consumption which are associated with increased demand for labor intensive goods and services and lessened demand for those that are energy intensive.

There is nothing inherent in the study of macroeconomics which precludes recognition of resource limitations, substitutability, and structural transformation. Nevertheless, until such concepts become part of the working tools of macroeconomics, we may ignore the apparent long run complementarity of employment, energy use, capital investment, and income which characterizes recent macroeconomic analysis. Conversely, we must not adopt the substitutability conclusions from the microeconomic studies as accurate descriptions of short run response.

Distortion in Factor Prices

If, as we have concluded here, employment, energy, and capital interact in manufacturing and throughout the economy, then it follows that the prices of these factors affect their relative attractiveness to business and government.

We might address the question of the nature of pricing decisions in the energy industry in order to determine whether relevant markets and industries might be characterized as competitive, conventional monopolies, or growth monopolies.^{40/} The question could be rephrased in more technical terms as a problem of whether pricing policies are properly characterized as competitive (marginal cost pricing), conventionally monopolistic (marginal revenue-marginal cost pricing), or growth oriented (average cost pricing). While relevant and of interest in its own right, the subject is beyond the scope of this discussion.

However, the question of the tax treatment of factor costs is directly relevant. As we shall see below, the energy industry is particularly capital intensive in the sense of assets per employee, and a very significant part of current gross private domestic investment is energy related.

^{39/} Intermediate industries have only small fractions of GNP final demand. Hannon and Bullard, incidentally, do not report numerical results.

^{40/} See Exxon Corporation, "Competition in the Petroleum Industry," May 1975; John M. Blair, The Control of Oil, 1976; D. Chapman, et al., The Structure of the U.S. Petroleum Industry: A Summary of Survey Data, U.S. Senate Interior Committee Subcommittee on Integrated Oil Operations, 1976.

If we express the annual user cost of capital without tax considerations, it is simply

$$(16) \quad C_K = \frac{r}{1 - (1+r)^{-AL}} = a$$

Here C_K equals an amortization rate for a capital investment which is used productively for its actual life AL , and then retired without salvage value. The interest rate is r .

But the imposition of the corporate income tax rate and the various capital subsidies associated with it result in a new annual cost of capital:

$$(17) \quad C_K = \frac{a(1 - s - uD - ubr)}{1 - u}$$

The corporate income tax rate is u , the investment tax credit is s , D is the discounted impact of accelerated depreciation for tax purposes, and b is the fraction of capital eligible for interest charge deduction either as borrowed capital or as an allowance for equity funds used during construction.^{41/}

The effect of social insurance taxes on the cost of labor is analogous:

$$(18) \quad C_L = w + sib$$

The paid out wage rate is w , and the social insurance tax rate is sib . Mandatory social security, workmen's compensation, and unemployment insurance may be 6% to 8% of salaries and wages in aggregate. Retirement, health, and other insurance benefits may raise the actual employer cost of sib to 25% to 33% of wages. (We may suppose that industries with unions have on the average higher employer contributions.)

Suppose we illustrate distortions in factor prices by reference to a decision faced by an imaginary National General Corporation. National General's production process now requires teams of three workers each using tools, and being paid \$15,000 per year in wages. National General may purchase a machine to replace them at a cost of \$200,000; the machine (lasting 25 years) uses \$5,000 worth of electricity per year at an average price of 2¢/KWH, and requires one operator at \$15,000 per year.

If there are no capital tax subsidies--no investment tax credit, accelerated depreciation, or equity deductions--the user cost of capital will be based on the corporate income tax rate (.48) and the interest rate (say, .09). The user cost of capital is 19.6% per year, or \$39,200 for the machine. Total annual cost for the machine, its operator, and the electricity is \$59,200.

Without the social insurance tax, annual wages for the alternative three-worker team are \$45,000.

If $sib = .3$, labor costs for the three workers would be \$58,500. The machine operator's cost to the employer would rise also, and total machine cost would now be \$63,700.

^{41/} Preston, Coen, and Hall and Jorgenson use in Equation (16) $C_K = r + \delta$ where $\delta = 1/AL$. Typically, $r + \delta$ is about .03 higher than a . See Ross Preston, The Wharton Annual and Industry Forecasting Model, 1972; R.M. Coen, "The Effects of Tax Policy on Investment in Manufacturing," American Economic Review, Proceedings, v. 58, May 1968, pp. 200-211; R.E. Hall and Jorgenson, "Tax Policy and Investment Behavior," American Economic Review, v. 57, June 1967, pp. 391-414.

National General, then, would find the three workers to be less costly than the machine, given the corporate income tax and employer contributions to social insurance.

However, the capital subsidies will reverse this result. Suppose the investment tax credit is 11%, the machine has a tax life of 16 years, sum of years' digits tax depreciation is used, and 50% of capital investment is eligible for interest or equity deductions. The user cost of capital is now 11.1% per year for a capital charge for the machine of \$22,200 per year. The electric utility may be able to lower the price of electricity by $3/4\phi$ per KWH^{42/} reducing annual electricity costs to \$3,125 per year. The operator's labor cost remains at \$19,500 with employer's contributions. Total cost: \$44,825 per year for use of the machine, clearly less costly than the three-worker team.

It is precisely this kind of event which present capital subsidy and employer contributions cause: capital costs are lowered, energy costs are lowered, and labor costs are raised.

Since energy industries are particularly capital intensive, present capital subsidies lower energy prices relative to prices of goods which are less energy intensive. For example, New York's private utilities in 1974, by means of the capital tax subsidies noted here, reduced their Federal income tax liability to 8/10 of 1% of their pre-tax net income. If their tax rate had been 48% of pre-tax net income, and if this had been collected from electric utility customers, it would have raised the price per KWH by $1/2\phi$ per KWH.

Earlier in the discussion the possibility of non-competitive markets was excluded from present considerations as a possible source of factor price distortion. (Remember, non-competition may either decrease or increase prices.)

Similarly, we should note that environmental costs have not been considered. Consider the hypothetical possibility that energy use causes significant weather modification, environmentally induced cancer, mine and worker health and safety problems, air pollution damage, and automobile accidents. If this were to be so, the unwilling recipients of these events are subsidizing energy users and energy prices. At present I have no satisfactory gauge for the actual magnitude of these things, but note that if they are important, then energy prices are subsidized.

^{42/} The tax life of a nuclear plant is 16 years. With an actual life of 25 years, a capacity factor of 65%, and a cost of \$650 per KW, the capital subsidies reduce annual capital charges for nuclear power by 1ϕ per KWH.

4. The Energy-GNP Ratio

The ratio of energy consumption to Gross National Product has attracted considerable attention from observers concerned that energy conservation policies may cause income decline. This concern is based in part upon the stability of energy use per dollar of GNP during a period in which GNP rose dramatically. In 1972 dollars, the ratio was 61,000 Btu per dollar in 1953 and 59,900 Btu per dollar in 1975. There was little variation over this 23 year period, the highest value being 62,400 and the lowest, ⁵⁷/₄₃500. At the same time, real GNP approximately doubled, as did energy use.

To some extent the energy-GNP ratio is a cousin to the expectation that electricity demand doubles every 10 years. Both concepts arose from real historical experience and resulted from the complex interaction of technology, economics, and social behavior.

From the preceding discussions of types of conservation, macroeconomics, and substitution studies, it seems evident that there is no particular significance to the concept. Evidently, with given or assumed income levels, energy use may vary widely according to energy prices, population, climate, social structure, and so on. This is patent on an international basis where it has been shown that there is wide variation in energy-GNP ratios at various levels of GNP per capita. ⁴⁴/₄₄

Nordhaus' position is almost certainly correct. He analyzed the value to consumers of wide variations in future energy use and compared this to assumed GNP. His result is that variation in value to consumers associated with variation in energy use is a very small fraction of GNP. ⁴⁵/₄₅ If total energy use in 2010 were to be at its 1974 level (implying a reduction in per capita use), economic welfare would apparently be unaffected.

While this is a valuable insight, it should not be assumed that the economic problem has been solved. As I shall argue in the next section, current economic policy does not draw upon the insight provided by the material reviewed here. In fact, the opposite may be the case, and recent developments may needlessly aggravate the necessary transition to an economy with greater energy conservation and greater employment.

⁴³/₄₃ U.S. Department of Interior, "Annual Energy Use Drops Again," April 5, 1976, Table 9.

⁴⁴/₄₄ See Chapter II, Energy Demand and Conservation Panel, *op cit.*, L. Schipper and A. J. Lichtenberg, "Efficient Energy Use and Well-Being: the Swedish Example," *Science*, Dec. 3, 1976, 194:1001-1012.

⁴⁵/₄₅ William D. Nordhaus, "What is the 'Tradeoff' Between Energy Consumption and Real Income?" draft, Nov. 1, 1976. His method was to calculate the sum of consumers' and producers' surplus in each energy sector and compare this to assumed GNP of \$4.5 trillion in 2010. With total energy consumption changing from 137.6 quadrillion Btu in 2010 to 73.0 quadrillion Btu (because of an energy tax of \$3.19 per million Btu), the sum of consumers' and producers' surplus declined \$103 billion--2% of the GNP value.

5. Inflation, Energy Conservation, and Employment: Post-Embargo Developments

Since 1973, the major sources of inflation have been energy prices and the prices of goods embodying significant energy. Similarly, major reductions in employment are generally in the same industries. Tables 4 and 5 illustrate this relationship. We may infer that increased energy costs reduced the demand for energy intensive goods and services. At least in the short run, ^{46/} employment and energy use in manufacturing appear to have been complementary.

It is questionable whether the decline in housing construction is energy related in any degree. It is generally believed that income, business cycles, and interest rates are the major factors. However, higher energy prices have raised the costs of extraction, processing, and transporting of all building materials, and higher automobile transportation costs and heating costs have made suburban housing more expensive to operate.

We may accept the general proposition that the effectiveness of the 1973-74 embargo and subsequent OPEC pricing are made possible by the depletion of inexpensive oil and gas in the United States. Simultaneously, costs of producing energy in the United States rise from both effects--both depletion of U.S. resources and OPEC pricing. Investment requirements per Btu in oil, gas, coal, nuclear power, and electricity are all rising.

These points are introductory to Table 6 which shows the current dependence of investment upon energy. Apparently, one-half of current private business investment in plant and equipment is in energy related industries. Another \$64 billion is in the purchase of automobile output.

If industry is over-estimating growth in demand for energy and energy-related goods, the present level of investment will have been unjustified. This realization, if it occurs, will have a major deflationary impact. In New York, for example, ^{47/} the summer peak load for electricity in 1976 was 19.3 thousand megawatts. Capacity as of December 31 was 30.5 thousand megawatts. Allowing a 20% reserve margin over 20.0 thousand megawatts, 6.5 thousand megawatts were in excess. Valued at \$650 per KW, this would be \$4.2 billion in excess capacity in New York at the end of 1976.

While the discussion here has shown the apparent contemporaneous complementarity of energy, labor, and capital, recent research on energy conservation has resulted in a clarification of the relationship between original investment and energy in end uses. Figure 9 shows the capital and cost necessary to achieve better fuel economy in automobiles. ^{48/} At present gasoline prices, the least expensive car over its lifetime would use 27 miles per gallon. Buyers of many present cars are presumably reducing their personal investment but losing discounted future fuel savings. If gasoline prices rise to \$1.10 per gallon, somewhat greater investment in fuel economy will result in minimum cost.

^{46/} In Table 5-A, the increase in mining employment of 150 thousand is equal to the increased employment in coal, oil, and natural gas.

^{47/} Peak demand in 1975 was 20.0 thousand MW; the highest to date was 20.4 in 1973.

^{48/} Chapter 5, Energy Demand and Conservation Panel Report, op cit., Figure V-5, Scenario C.

Table 4A. Wholesale Price Increases, October 1973 to October 1976

Gas fuels	2.4805	All commodities	1.3276
Chemicals, industrial	2.1045	Heating equipment	1.3253
Agricultural chemicals	1.9426	Motor vehicles	1.3250
Fuels and related products and power	1.8405	Electrical machinery and equipment	1.3248
Petroleum products, refined	1.8167	Gypsum products	1.2298
Chemicals and allied products	1.6717	Drugs, pharmaceuticals	1.2970
Coal	1.6430	Finished goods	1.2967
Electric Power	1.6162	Fruits, vegetables, processed	1.2867
Iron and steel	1.5786	Appliances, household	1.2860
Construction machinery and equipment	1.5260	Nondurable goods	1.2859
Paper	1.5176	Furniture and household durables	1.2607
Tires and tubes	1.4996	Consumer finished goods	1.2585
Metal and metal products	1.4709	Furniture, household	1.2500
Agricultural machinery and equipment	1.4604	Footwear	1.2420
Metalworking machinery and equipment	1.4565	Dairy products	1.2142
Nonmetallic mineral products	1.4446	Leather products	1.2016
Rubber, plastic products	1.4430	Hides, skins and leather products	1.1878
Pulp, paper and allied products	1.4420	Lumber and wood products	1.1847
Beverages and beverage materials	1.4407	Fruits, vegetables	1.1845
Industrial commodities	1.4375	Apparel	1.1720
Intermediate materials, supplies, etc.	1.4309	Textile products and apparel	1.1619
Producer finished goods	1.4181	Lumber	1.1455
Machinery and equipment	1.4151	Foods, feeds, processed	1.1424
Prepared paint	1.4040	Cereal and bakery products	1.1296
Durable goods, mfg.	1.3930	Crude materials for further processing	1.0985
Durable goods	1.3855	Farm products, processed food	1.0755
Total manufacturing	1.3647	13 raw materials	1.0718
Concrete products	1.3473	22 commodities	1.0234
Transportation equipment	1.3460	Home electronic equipment	.9967
Nonferrous metals	1.3390	Farm products	.9904
Nondurable goods, mfg.	1.3353	Meat, poultry, fish	.9900
Clay products	1.3339	Hides and skins	.9809
		9 foodstuffs	.9570
		Fats and oils, inedible	.9201
		Livestock	.8415
		Grains	.8153
		Live poultry	.7955

Source: Survey of Current Business. The overall index rose 32.8%

Table 4B. Consumer Price Increases, October 1973 to October 1976

Fuel and coal	1.7938
Gas and electricity	1.5220
Used cars	1.5181
Fuel and utilities	1.4502
Private transportation	1.3849
Transportation	1.3672
Household furnishings and operation	1.3489
Medical care	1.3435
Services less rent	1.3140
Housing	1.3041
Services	1.2947
Personal care	1.2875
Home ownership	1.2858
All items less food	1.2832
Durables	1.2808
Commodities less food	1.2727
All items less shelter	1.2714
All items	1.2687
Nondurables less food	1.2677
Fruits and vegetables	1.2644
All items less medical care	1.2639
Dairy products	1.2578
Shelter	1.2578
Health and recreation	1.2574
Commodities	1.2539
Nondurables	1.2445
New cars	1.2431
Food	1.2237
Public transportation	1.2218
Reading and recreation	1.2068
Rent	1.1668
Apparel and upkeep	1.1644
Meats, poultry and fish	1.0240

The overall index rose 26.9%

Table 5A. Change in Total Employment, 1973 to September 1976
(thousands; seasonally adjusted)

	<u>1973</u>	<u>Sept 1976</u>	<u>change</u>
Contract construction	4028	3331	-697
Durable goods, manufacturing, production workers	8673	7979	-694
Nondurable goods, manufacturing, production workers	6080	5794	-286
Armed Forces	2326	2145	-181
Agriculture	3452	3286	-166
Transportation, communication, electric, gas, etc.	4646	4495	-151
Nondurable goods, manufacturing nonproduction workers	2160	2174	+ 14
Durable goods, manufacturing nonproduction workers	3141	3166	- 25
Federal government	2663	2751	+ 88
Mining	638	788	+150
Wholesale trade	4118	4305	+187
Finance, insurance, real estate	4075	4345	+270
Retail trade	12547	13336	+789
Self-employed	4124	4972	+848
Services	12986	14755	+1769
Unemployed	4304	7384	+3080
Total Labor Force	91040	97348	+6308

Table 5 B. Changes in Manufacturing Employment, 1973 to
September 1976 (thousands; seasonally adjusted)

Electrical equipment and supplies	-176
Transportation equipment	-150
Apparel, textile products	-126
Fabricated metal products	- 98
Primary metal industries	- 90
Stone, clay and glass	- 60
Textile mill products	- 54
Rubber and plastic products	- 50
Furniture and fixtures	- 42
Ordnance and accessories	- 30
Miscellaneous manufacturing	- 30
Lumber and wood products	- 22
Printing and publishing	- 19
Paper and allied products	- 19
Leather and leather products	- 17
Tobacco	- 2
Chemicals and allied products	0
Petroleum and coal products	+ 10
Food and kindred products	+ 10
Instruments and related products	+ 14
Machinery except electrical	+ 16

Table 6. Current Investment in New Plant and Equipment, Expected Fourth Quarter Expenditure, 1976, Billion Dollars Annual Rate

<u>Economic Sector</u>	<u>Amount</u>	<u>Total</u>
I. Energy Producing Industries		39.6
Petroleum, including gas	11.8	
Electric Utilities	20.0	
Gas and other utilities	3.8	
Mining including coal mining	4.0	
II. Energy Using Industries		22.7
Primary metals	5.8	
Electrical machinery	2.9*	
Paper	4.1	
Chemicals	7.1	
Rubber	1.0*	
Cement, glass, and stone	1.8	
III. Transportation		11.1
Motor vehicles	3.2	
Aircraft, missiles, and space	1.1	
Railroad	2.0*	
Air transportation	1.5*	
Other transportation, inc. pipelines	3.3	
IV. All Industry, including other		127.9
V. Actual gross private investment, second quarter 1976 excluding residential and inventories, including all industry, agriculture, lumber, education, etc.		165.6
VI. Auto output		63.9
Domestic, new cars	51.3	
Foreign, new cars	12.0	
VII. Investment in autos, energy producing and using industries, and transportation as percent of actual nonresidential private investment plus auto output		60%

*Decline in nominal (current) dollars from 1974. Electrical machinery unchanged.

Source: Survey of Current Business, Dec. 1976, Mar. 1977.

FIGURE 9. CAPITAL AND ENERGY COSTS IN AUTOMOBILE TRAVEL

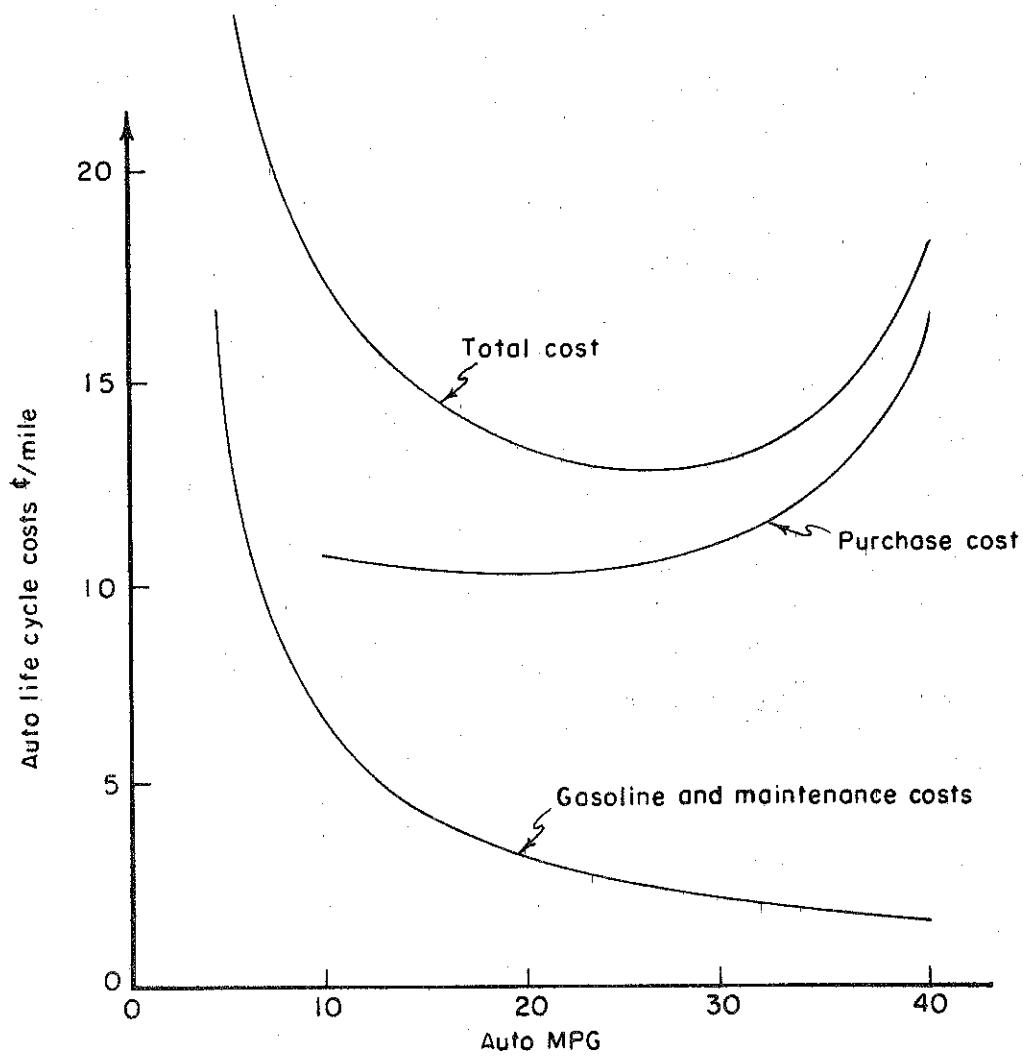

Note the substitution of investment cost for energy cost. Minimum total cost points towards more expensive, more efficient cars.

Similarly for household space heating energy use. Hirst and others^{49/} report that energy conservation may be purchased by increased capital cost as shown in Figure 10. They also report a similar kind of relationship for refrigerators, Figure 11.^{50/}

Their conclusion--identical in form to the automobile economy Figure 9-- is that there is a basic relationship between energy conservation and investment cost. They postulate a mild substitutability of the kind exemplified above by Figure 6-B. I interpret these data to imply that in end uses capital and energy are substitutable.

Therefore we may have both capital/energy complementarity in energy production and substitutability in energy conservation. Whether one or the other is promoted or retarded by public policy depends in part upon the distortions in factor markets cited above.

Assume that dollars expended in energy conservation through investment have direct employment impact equivalent to the all industry value in Table 7. As illustration, \$200,000 in energy conservation investment might employ 5 persons; it would employ less than one person in utility operation. Considering the asset costs per employee in energy producing industries, stimulating employment through investment in these industries seems the most expensive possible remedy for unemployment.

6. Prospective Policies

My reading of the present consensus on expected economic policies is the following: (1) maintain or increase present investment tax credits and accelerated depreciation provisions in corporate taxation, (2) a corporate tax credit based upon social insurance contributions, (3) a personal income tax reduction to stimulate employment through increased purchases of consumer goods and housing, (4) continued growth in state and Federal conservation programs.

In my opinion, (4) reduces energy and increases employment and income. Item (2) increases employment and income. The first set of policies (1) stimulate investment and employment in the short run, and in the long run increase energy use and reduce employment. I suspect we have a "decumulation effect" working with these capital subsidies. As the macroeconomic discussion indicates, the immediate effect over a few years is to increase construction and new equipment activity, increase employment, and raise total output. However, as the substitution studies show (except Griffin and Gregory), the long run effect is less employment. Hence the final employment decumulation curve in Figure 12. With reference to Tables 6 and 7, it appears that the current high investment in energy production industries would be followed by relatively little employment in operations, and this would be a major component of the employment decumulation effect.

^{49/} Eric Hirst, et al., "An Improved Engineering Economic Model of Residential Energy Use," April 1977, p. 31

^{50/} Idem.

FIGURE 10. IMPROVED HEAT RETENTION AND COST

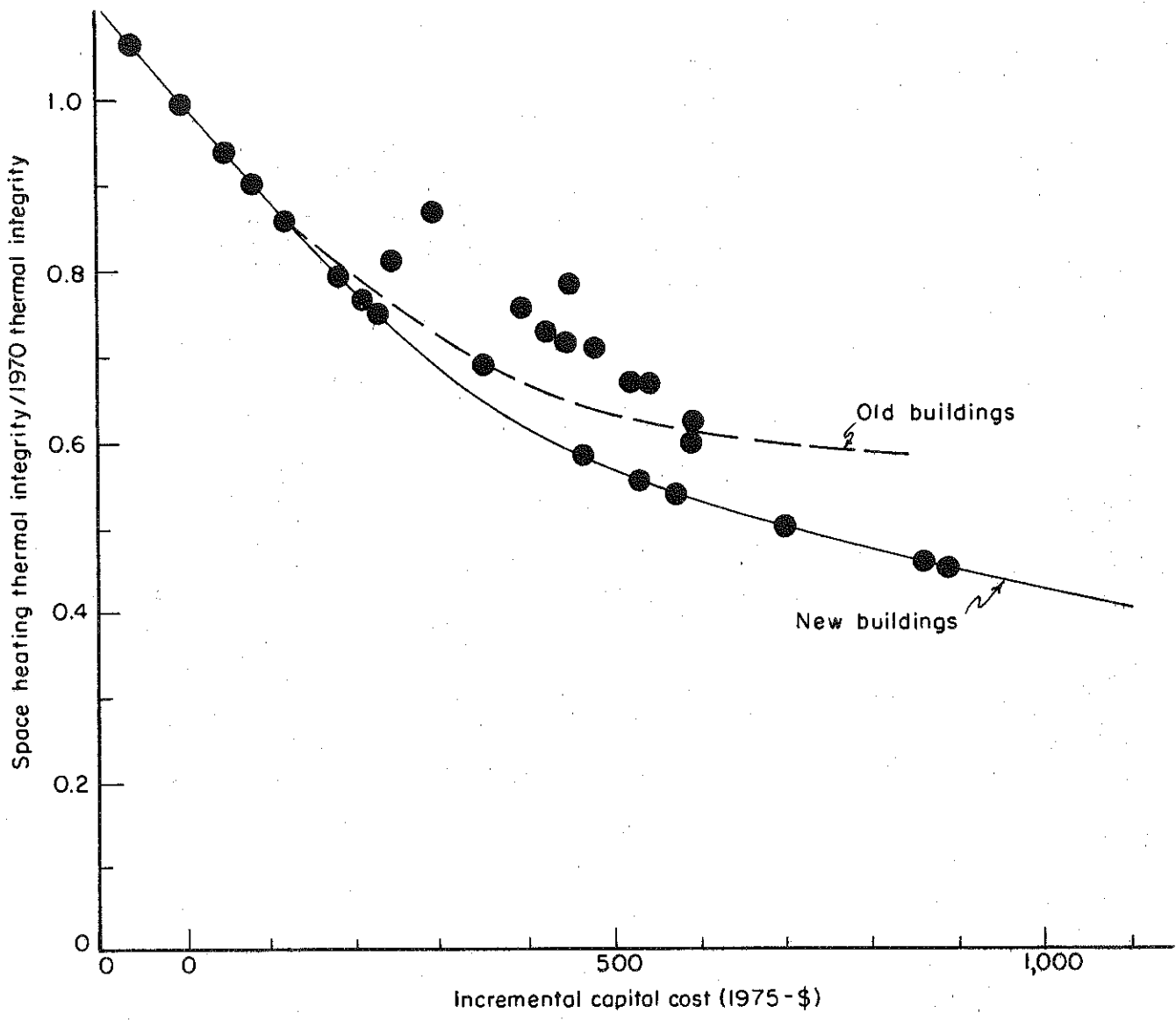
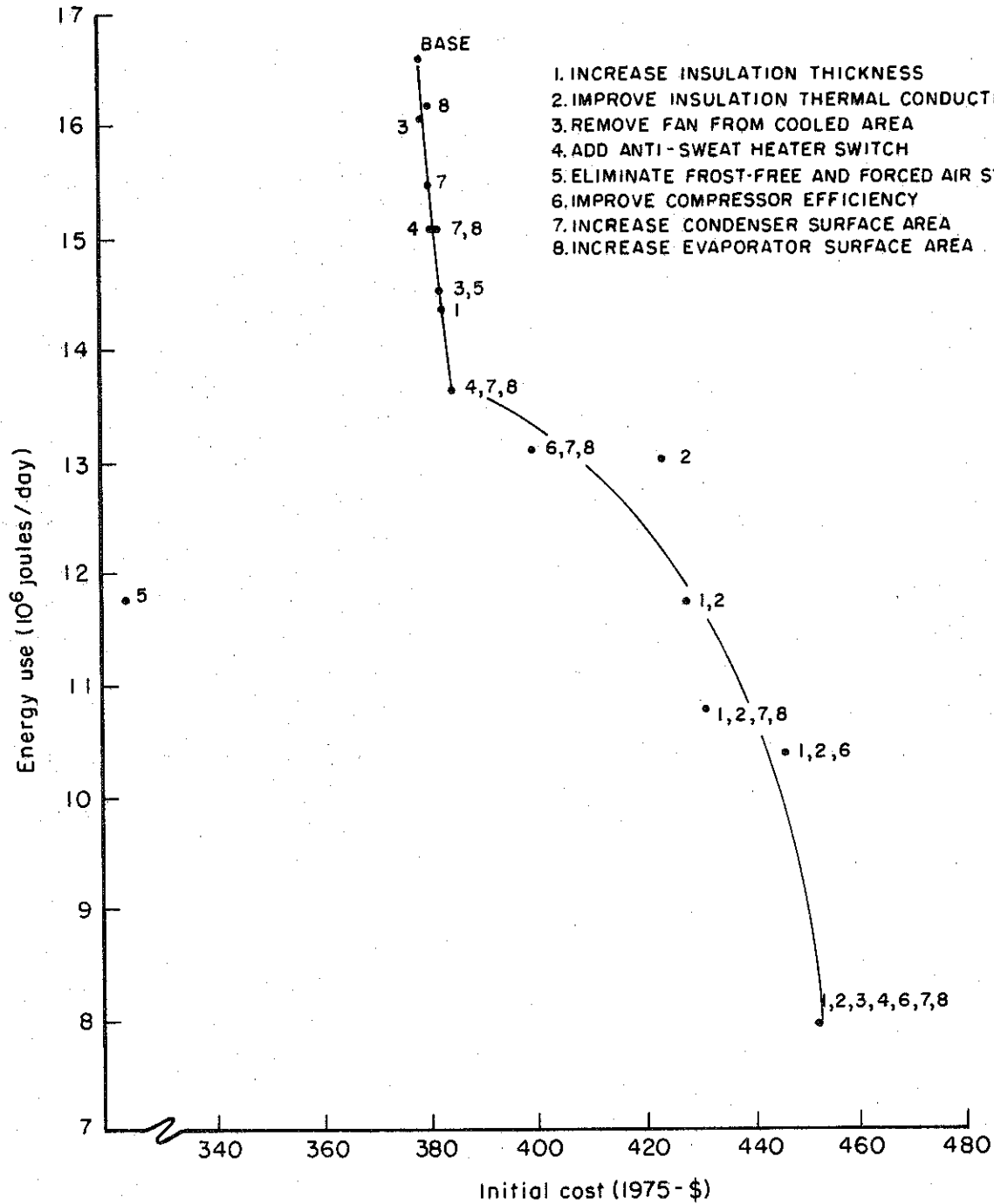

Fig. 12 Space heating thermal integrity (TI) for single-family units as a function of increased capital cost. Each data point represents a different combination of ceiling insulation, wall insulation, floor insulation, storm windows, and storm doors for new construction. Incremental capital costs for new construction include increases for materials and labor minus savings for smaller heating and cooling equipment. The dashed line shows the relationship between TI and incremental capital cost for existing structures. Source: Eric Hirst (see text).

FIGURE 11. ENERGY USE AND COST IN REFRIGERATORS



Electricity use versus retail price for a 0.45m^3 (16ft^3) top-freezer refrigerator. Source: Eric Hirst (see text).

Table 7. Assets per Employee, 1975, Fortune 500 Median Values

Electric and gas utilities, New York ^{1/}	\$270,000
Petroleum refining	197,000
Mining and crude oil production ^{2/}	115,000
Broadcasting and motion pictures	70,000
Beverages	69,000
All industries	38,000

1/ From annual reports of New York's seven utilities.

2/ Combined, presumably because of overlapping ownership.

Source: "The Fortune Directory of the 500 Largest U.S. Industrial Corporations," (by Sales), Fortune, May 1976.

FIGURE 12. THE EMPLOYMENT DECUMULATION EFFECT

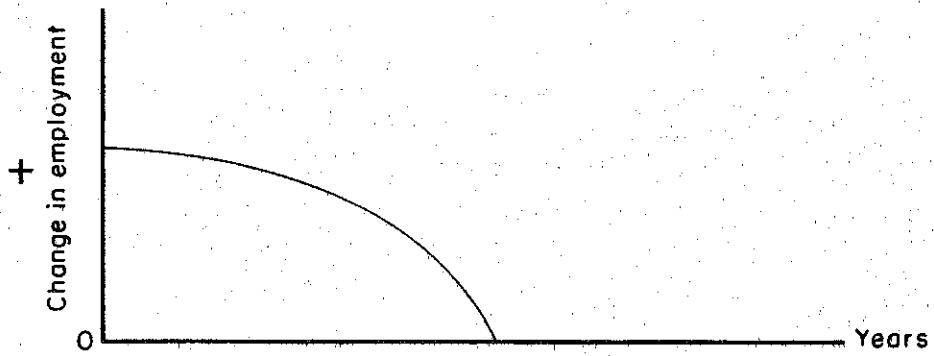

As the new plant and equipment is completed, related employment declines

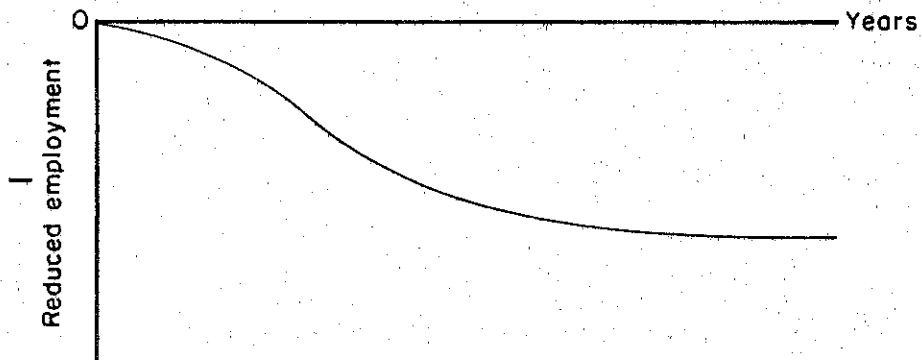

The new after-tax capital cost results in a net reduction in operating employment

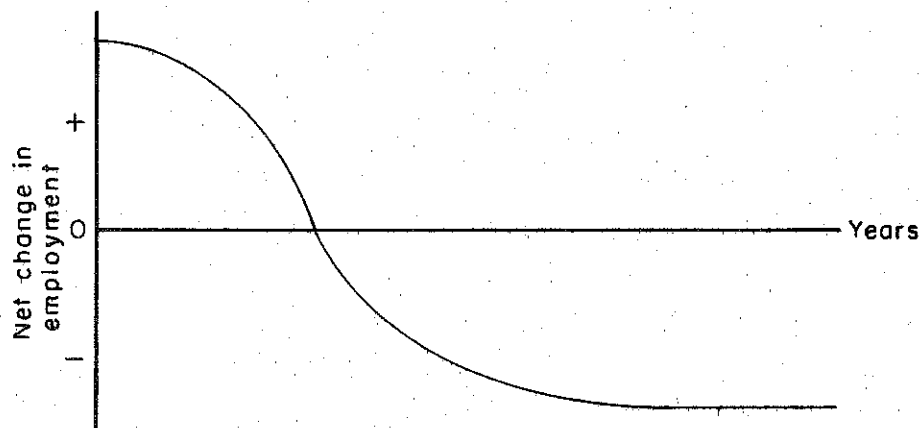

The net effect: positive in the short run, negative in the long run

The impact of a personal income tax reduction will depend in part upon the simultaneous path of energy prices. As Figures 13 and 14 show, petroleum product prices have been declining in real terms since 1974. The latest OPEC decision seems certain to continue this decline for the very near future.

However, suppose energy prices resume their inevitable growth. Then the positive effect on consumer demand of a tax reduction must work against the negative effect on demand of higher energy prices. Let us assume that the long run income elasticity of consumption demand for energy related goods is .8, and the long run price elasticity is -1.51 .^{51/} If real energy prices grow regularly--say 3-1/2% per year--this means an illustrative decline of nearly 3-1/2% per year in the demand for these goods. It seems to me unlikely that any conceivable combination of technological change and tax policy could by itself exceed this effect. Inevitably, when real energy prices resume their growth, consumer demand must shift to other activities.

A serious national problem has arisen because of the apparent absence of major growth in activities which would become substitutes for energy intensive goods and services. We have not seen major growth in activities which are close substitutes for the high inflation, high unemployment sectors in Tables 4 and 5. Both consumer and investment activity have been complacent in the security of the recent declines in real petroleum product prices.

In Table 6, it is apparent that rail investment is less now than in 1974. Rail passenger traffic declined from 1974 to 1975.^{52/} There is probably a minimum scale for rail transportation to be cost effective compared to trucks, buses, and automobiles. I am uncertain to what extent this depends on diesel oil costs, and of different labor and corporate practices. My judgment is that this scale has not been met, and rail passenger operations remain largely uneconomic.

Similarly, there is no shift from automotive to urban transit.^{53/}

The current recovery seems to be built on these factors: (1) higher automobile sales and production, (2) growth in suburban housing in the south and west, and (3) investment in energy producing and using plant and equipment. In a general way, this is a typical recovery, made possible by the three year decline in petroleum product prices (see Figures 13 and 14).

It is not a firm basis for stable growth. I consider it to be quite fragile, and expect that a lesser petroleum price increase than that of 1974 would have a greater deflationary effect. Further, I expect that minimum unemployment in this cycle will be higher than the 1973 level of 4.9%.

^{51/} As Tjalling Koopmans has shown, with continually rising energy prices and incomes, long run price elasticities must be more negative than -1, and income elasticities less than +1.

^{52/} U.S. Interstate Commerce Commission, Transport Economics

^{53/} U.S. Department of Transportation, "National Transportation System Activity."

FIGURE 13. RESIDENTIAL ENERGY PRICES, MAY 1976 DOLLARS

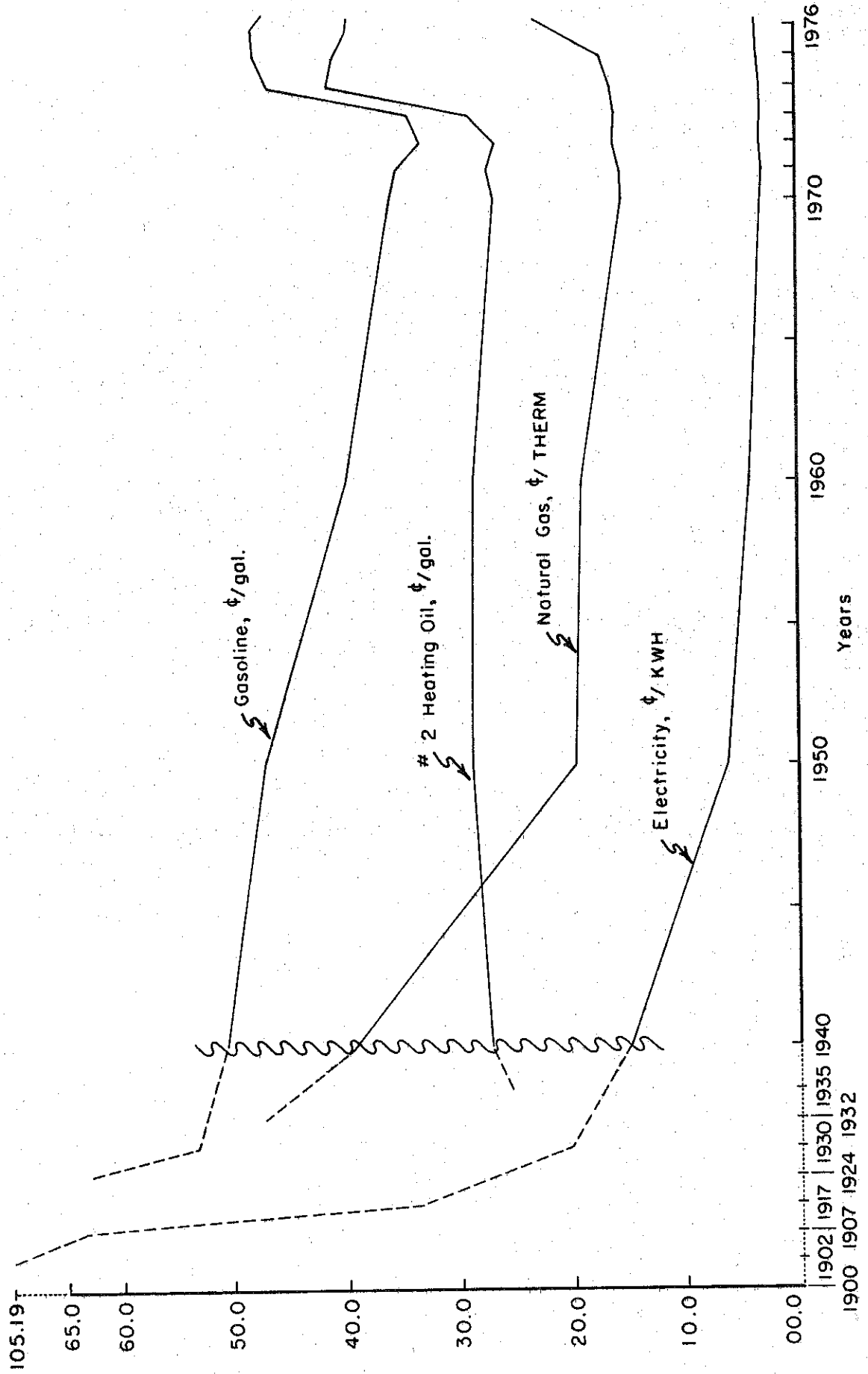
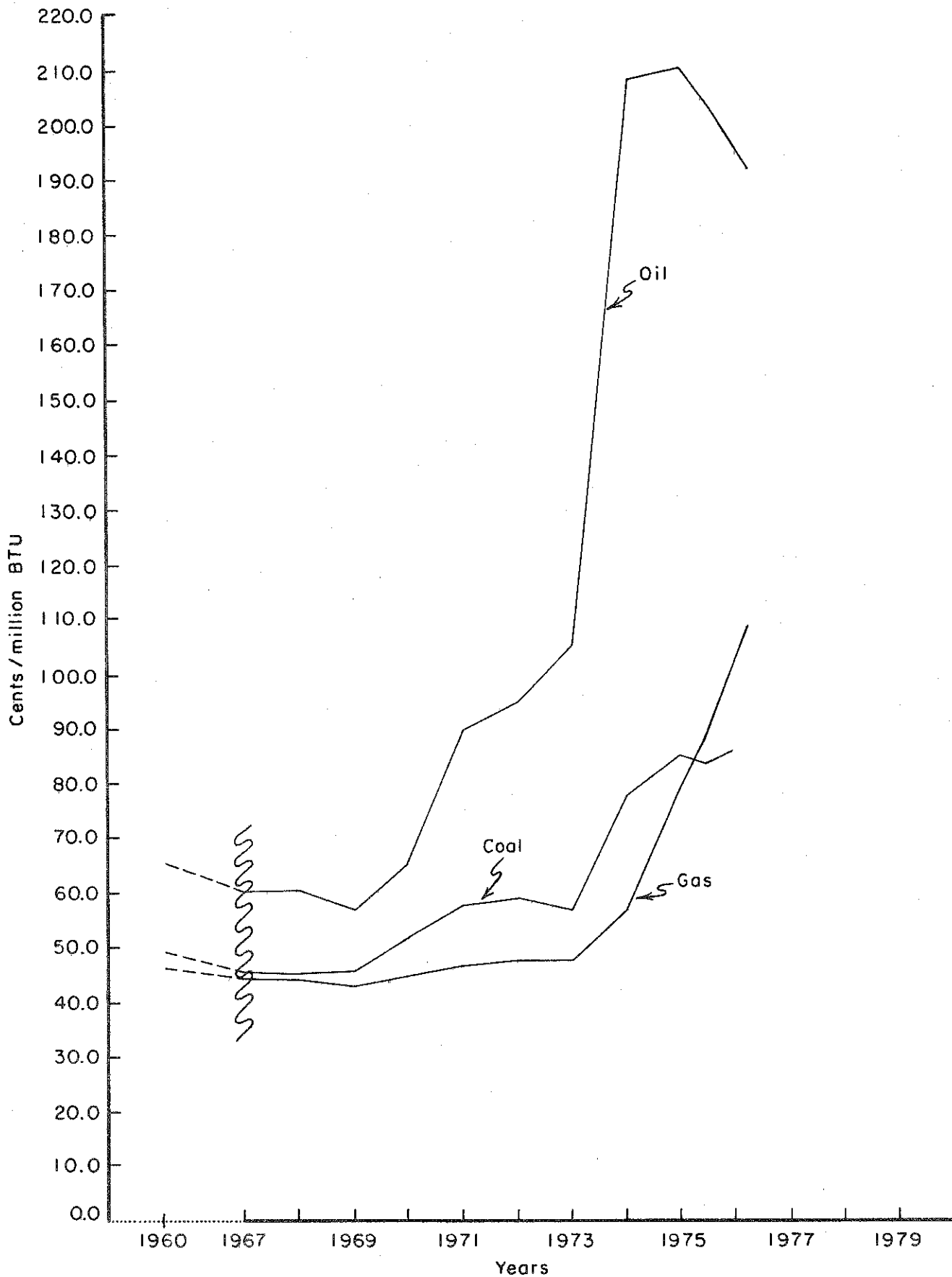

FIGURE 14. UTILITY ENERGY COST, ¢/MBTU, MAY 1976 DOLLARS



Quite apart from long run OPEC policy, we must expect domestic energy to become more expensive. In 1976 dollars, Alaskan crude oil delivered on the West Coast will probably cost \$15 to \$20 per barrel.^{54/} Delivery to Midwest, Gulf, or Eastern refineries will be more costly. As Alaskan oil is averaged into product costs, domestic petroleum product prices must reverse the decline of the past three years. Of course, this cost factor may be important to the oil companies and OPEC in setting prices for OPEC oil.

While domestic gas prices continue to seek to rise to levels which are comparable on a Btu basis to oil products and coal, there should be no anticipation that gas production in the Southwest will increase. The real price of gas sold by utilities rose 56% from the second quarter of 1973 to 1976. Gas sales fell from 3.9 to 3.3 quadrillion Btu's over this three year period. Annually, gas production has fallen each year since 1971. Since natural gas prices in early 1977 remain below the values of competitive fuels, we may expect continued price increases, regardless of whether the economic rent is collected publicly or privately. We may not, however, anticipate increased production from the lower 48 states.

In coal, nuclear power, and electricity, we may anticipate that rising worker health and safety requirements and environmental standards will raise production costs and prices.

Real energy prices, then, will continue or resume growth. The present energy tax proposals and related policies^{55/} merely reflect these underlying realities, attempting to accelerate the process and transfer a major portion of energy industry income from corporations to the public sector.

The economic policies which are promoting the present recovery do not seem to reflect the same realities. In the absence of an economic program which is complementary to the energy program, the probable outcome is a new--and perhaps unnecessary--recession. An offsetting influence is the potential employment generated by the conservation and environmental sections of the energy proposals. On balance, I think this positive influence is not sufficient to exceed the negative impact of the tax proposals on automobile and appliance output, residential construction, and investment in conventional energy producing and using industries. (Again, this interpretation must be seen as assuming no major changes in capital subsidies or employment penalties, and no major expansion of public or private sector activity in urban housing and public transportation.)

To recapitulate: Conservation in a philosophical sense has taken two partly contradictory meanings, one emphasizing the preservation of natural environments and the other giving its concern to the public interest in the proper management and development of natural resources. Energy conservation is a concept which embodies both of the earlier perspectives. In economic terms, energy conservation must be decomposed into its constituent parts since the relationship of energy conservation to employment, income, and prices will depend upon the particular economic influences associated with specific types of energy conservation.

^{54/} Author's estimate based upon unpublished information.

^{55/} Office of the White House Press Secretary, "The President's Energy Program," April 20, 1977. Also, "National Energy Act," communication from the President of the United States transmitting a draft of proposed legislation to establish a comprehensive national energy policy. April 29, 1977, Washington, D.C.

Macroeconomic analysis suggests that energy conservation is not particularly relevant to the health of the national economy, and fiscal and monetary policies may stimulate growth in consumption and investment without particular concern for the composition and nature of goods and services produced. Further, the Phillips curve concept implies that energy price inflation requires greater unemployment to maintain price stability. The microeconomic studies of the interaction of energy, labor, and capital contradict these inferences, and in general find a substantial potential for substitution over a long time period. It should be expected that the macroeconomics of the future will consider factor substitution and resource use.

Present tax policy distorts factor prices by lowering capital costs and raising labor costs. This has particular significance for energy, since energy industries are the most capital intensive kinds of manufacturing activity.

In contrast, investment opportunities for energy conservation by consumers are at present unaffected by tax policy. Although the new energy program proposes tax credits for energy conservation actions, the net effect of present tax policy interacts with potential substitutability on a long run basis to stimulate capital investment and restrain energy conservation and employment.

The economic recovery of 1976-77 seems conventional, resting upon growth in investment in energy producing and using industries, automobile production and sales, and suburban housing. Given the certainty of increases in real energy prices, the present recovery may be short lived and is unlikely to make satisfactory reductions in energy-related inflation and disemployment.

In my opinion, present and future circumstances require policies which will promote growth and employment in activities which conserve energy in transportation, housing, and industry. A firm national emphasis on economic growth in these activities is not a question of preference; it is imperative.

REFERENCES

- Behling, D., Dullien, R., and Hudson, E., The Relationship of Energy Growth under Alternative Energy Policies, March 1976, pp. 135-166.
- Berndt, Ernst, and Wood, David, "Notes on Interactions between Consistent Projections on Energy Demand and Aggregate Economic Growth," prepared for the Energy Demand and Conservation Panel, National Academy of Science Committee on Nuclear and Alternative Energy Systems, draft, January 1977.
- , "Technological Change, Tax Policy, and the Demand for Energy," mimeo, University of British Columbia, 1975.
- , "Technology, Prices, and the Derived Demand for Energy," Review of Economics and Statistics, v. 57, August 1975, pp. 259-268.
- Blair, John M., The Control of Oil, Pantheon Books, 1976.
- Branson, William H., Macroeconomic Theory and Policy, Harper and Row, 1972.
- Bullard, Clark W., and Hannon, Bruce, "Energy Growth in the U.S. Economy," Center for Advanced Computation, University of Illinois (Urbana), April 1976.
- Chapman, Duane, et al., The Structure of the U.S. Petroleum Industry: A Summary of Survey Data, U.S. Senate Interior Committee Subcommittee on Integrated Oil Operations, Washington, D.C., 1976.
- Ciriacy-Wantrup, S.V., Resource Conservation: Economics and Policies, Berkeley, 1952.
- Coen, R. M., "The Effects of Tax Policy on Investment in Manufacturing," American Economic Review, Proceedings, v. 58, May 1968, pp. 200-211.
- Darmstadter, Joel, and Schipper, Lee, "Energy Demand and Conservation," Chapter 2, Energy Demand and Conservation Panel Report, National Academy of Science Committee on Nuclear and Alternative Energy Systems, draft, April 1977.
- Exxon Corporation, "Competition in the Petroleum Industry," May 1975.
- Folk, Hugh, and Hannon, Bruce, "An Energy, Pollution, and Employment Policy Model," Center for Advanced Computation, University of Illinois (Urbana), Feb. 10, 1973; also in M. Macrakis, Energy Demand, Conservation, and Institutional Problems, MIT Press, 1974.
- Fried, Edward R., and Schultze, Charles L., "Overview," in Fried and Schultze, eds., Higher Oil Prices and the World Economy, 1975.
- Granlich, Edward M., "The Optimal Timing of Unemployment in a Recession," Brookings Papers on Economic Activity, 1975:1, pp. 167-182.

- Griffin, James M., and Gregory, Paul R., "An Intercountry Translog Model of Energy Substitution Responses," American Economic Review, v. 55, 1965, pp. 845-857; and "Intercountry Price and Input Share Data," unpublished.
- Hall, R.E., and Jorgenson, D.W., "Tax Policy and Investment Behavior," American Economic Review, v. 57, June 1967, pp. 391-414.
- Hirst, Eric, et al., "An Improved Engineering Economic Model of Residential Energy Use," Oak Ridge National Laboratory, Oak Ridge, Tenn., April 1977.
- Hornig, Ellen, "The Effect of Energy Pricing on Employment in New York State Manufacturing," in preparation.
- Hudson, Edward A., and Jorgenson, Dale W., "U.S. Energy Policy and Economic Growth, 1975-2000," Bell Journal of Economics, v. 5, No. 2 (Autumn 1974), pp. 461-514.
- Koopmans, Tjalling, "Constant and Variable Elasticities," unpublished note, Aug. 6, 1976.
- McCarthy, Michael D., The Wharton Quarterly Econometric Forecasting Model Mark III, University of Pennsylvania, 1972.
- Modigliani, Franco, and Papademos, Lucas, "Targets for Monetary Policy in the Coming Year," Brookings Papers on Economic Activity, 1975:1, pp. 141-166.
- Mount, T.D., et al., "Electricity Demand in the United States: An Econometric Analysis," Oak Ridge National Laboratory, Oak Ridge, Tenn., June 1973.
- Mount, Tim, and Tyrrell, Tim, "Energy Demand: Conservation, Taxation, and Growth," Appendix B in Energy Demand and Conservation Panel Report, National Academy of Science Committee on Nuclear and Alternative Energy Systems, draft, April 1977.
- Muir, John, "Let Everyone Help to Save the Famous Hetch-Hetchy Valley," pamphlet, San Francisco, 1909.
- Nordhaus, William D., "What is the 'Tradeoff' Between Energy Consumption and Real Income?" draft, Nov. 1, 1976.
- Office of the White House, "National Energy Act," communication from the President of the United States transmitting a draft of proposed legislation to establish a comprehensive national energy policy. April 29, 1977, Washington, D.C.
- Office of the White House Press Secretary, "The President's Energy Program," April 20, 1977, Washington, D.C.
- Okun, Arthur M., "A Postmortem of the 1974 Recession," Brookings Papers on Economic Activity, 1975:1, pp. 207-221.
- Perry, George L., "The United States," Chapter 2 in Fried and Schultze, eds., Higher Oil Prices and the World Economy, 1975.

- Preston, Ross, The Wharton Annual and Industry Forecasting Model, 1972.
- Schipper, Lee, and Dardstadter, Joel, "What is Energy Conservation?" Lawrence Berkeley Laboratory, January 4, 1977.
- Schipper, Lee, and Lichtenberg, A.J., "Efficient Energy Use and Well-Being: the Swedish Example," Science, Dec. 3, 1976, 194:1001-1012.
- U.S. Bureau of Economic Analysis Staff Paper, No. 22, "The BEA Quarterly Econometric Model," July 1973.
- U.S. Department of Interior, "Annual Energy Use Drops Again," April 5, 1976.
- U.S. Department of Transportation, "National Transportation System Activity," 1976.
- U.S. Interstate Commerce Commission, Transport Economics, 1976.