

Keniston, Maura; Pratt, James E.; Stephenson, Mark W.; Novakovic, Andrew M.

**Working Paper**

## Disaster Planning in the Dairy Industry: Conceptual Issues and a Spatial Modelling Approach

Staff Paper, No. SP 90-13

**Provided in Cooperation with:**

Charles H. Dyson School of Applied Economics and Management, Cornell University

*Suggested Citation:* Keniston, Maura; Pratt, James E.; Stephenson, Mark W.; Novakovic, Andrew M. (1992) : Disaster Planning in the Dairy Industry: Conceptual Issues and a Spatial Modelling Approach, Staff Paper, No. SP 90-13, Cornell University, Charles H. Dyson School of Applied Economics and Management, Ithaca, NY, <https://doi.org/10.22004/ag.econ.121540>

This Version is available at:

<https://hdl.handle.net/10419/276823>

**Standard-Nutzungsbedingungen:**

Die Dokumente auf EconStor dürfen zu eigenen wissenschaftlichen Zwecken und zum Privatgebrauch gespeichert und kopiert werden.

Sie dürfen die Dokumente nicht für öffentliche oder kommerzielle Zwecke vervielfältigen, öffentlich ausstellen, öffentlich zugänglich machen, vertreiben oder anderweitig nutzen.

Sofern die Verfasser die Dokumente unter Open-Content-Lizenzen (insbesondere CC-Lizenzen) zur Verfügung gestellt haben sollten, gelten abweichend von diesen Nutzungsbedingungen die in der dort genannten Lizenz gewährten Nutzungsrechte.

**Terms of use:**

*Documents in EconStor may be saved and copied for your personal and scholarly purposes.*

*You are not to copy documents for public or commercial purposes, to exhibit the documents publicly, to make them publicly available on the internet, or to distribute or otherwise use the documents in public.*

*If the documents have been made available under an Open Content Licence (especially Creative Commons Licences), you may exercise further usage rights as specified in the indicated licence.*

CORNELL  
AGRICULTURAL ECONOMICS  
STAFF PAPER

*DISASTER PLANNING IN THE DAIRY INDUSTRY:  
CONCEPTUAL ISSUES AND A  
SPATIAL MODELLING APPROACH*

by

Maura M. Keniston, James E. Pratt,  
Mark W. Stephenson, and Andrew M. Novakovic

February 1992

No. 90-13 (Revised)

Department of Agricultural Economics  
Cornell University Agricultural Experiment Station  
New York State College of Agriculture and Life Sciences  
A Statutory College of the State University  
Cornell University, Ithaca, New York, 14853

#### ABSTRACT

Natural disasters in the U.S. demonstrate the lack of and need for integrated disaster plans for the U.S. dairy industry. It is demonstrated how a spatial model of the Northeast dairy industry can be used to assess and analyze potential impacts of local and regional disasters on market levels in the industry. A hypothetical radioactive release from a nuclear power plant reactor in the Northeast provides an example.

## PREFACE

Maura Keniston, James Pratt, and Andrew Novakovic are Research Support Specialist, Assistant Professor, and Associate Professor, respectively, in the Department of Agricultural Economics, Cornell University. Mark Stephenson is an Assistant Professor in the Department of Agricultural Economics, University of Wisconsin, River Falls.

This paper was a selected paper presented at the annual meeting of the Northeastern Agricultural and Resource Economics Association, June 18-20, 1990, in Truro, Nova Scotia.

Computations were conducted using the Cornell National Supercomputer Facility, a resource of the Center for Theory and Simulation in Science and Engineering at Cornell University. The Center is funded in part by the National Science Foundation, New York State, and the IBM Corporation as well as by members of the Corporate Research Institute. Funding for this project was provided in part by the U.S. Department of Agriculture through the National Institute for Livestock and Dairy Policy.

The authors wish to thank Mr. Jim Jones of the Oswego County Emergency Management Office for making available the Interactive Rapid Dose Assessment Model. We also thank Wendy Barrett for her expertise in putting all the pieces together and formatting this paper for publication.

Requests for additional copies of this publication should be directed to:

Ms. Bonnie Gloskey  
Publications Office  
Department of Agricultural Economics  
Cornell University  
Ithaca, NY 14853-7801

## OVERVIEW

Although various federal, state, and local agencies have provisions and plans dealing with disasters generally, little attention is given to the needs and concerns of specific food industries, such as the dairy industry. In the event of a catastrophe, food supply and distribution quickly become key concerns. Events in California and the Carolinas and the 1986 Chernobyl reactor explosion demonstrate the need for developing integrated disaster plans for the food industry, including the farm, processing, and retail distribution sectors. A brief description of disaster planning theory is given and a model of the Northeast dairy sector is used to illustrate the issues and provide concrete examples for a hypothetical release from a nuclear power plant operation in Oswego County, New York.

In practice, disaster planning in the United States is a function provided by local and state governmental agencies, and consequently the quality of such planning varies across the country. The Federal Disaster Relief Act of 1974 provides for federal assistance and intervention only when the scope of the disaster is greater than the combined capabilities of both state and local authorities to manage effectively (U.S. Congress 1987). The Federal Emergency Management Agency (FEMA) has been criticized repeatedly by the General Accounting Office, among others, for its "poor implementation of programs in such areas as hurricane preparedness, earthquake mitigation and preparedness...as well as in preparedness and mitigation efforts in general" (Waugh 1988, 121). Although it has been named as the lead agency for a number of different types of disasters, FEMA itself considers its role in disaster mitigation to be supplementary.

Disaster researchers classify disaster planning in terms of four general categories: preparation, response, recovery, and prevention (Quarantelli 1987). Preparation planning can be defined as "activities closest to the onset of a disaster which minimize damage and enhance disaster response operations" (Waugh, 113). Efforts such as stockpiling supplies, setting up telephone notification networks and organizing personnel can all be characterized as preparation activities.

Response planning pertains to those activities that occur immediately after a disaster and are considered primarily the responsibility of local (and sometimes state) emergency response personnel. Firemen responding to a fire at a chemical dump, or paramedics tending to victims of a tornado are both examples of response activities.

Recovery planning - dealing with the aftermath of a disaster - is the level at which the federal government agencies, such as FEMA and the U.S. Department of Agriculture (USDA), and private agencies, such as the Red Cross, operate, providing monetary and material assistance to disaster-stricken areas. However, well-intentioned plans may, and often do, run afoul of unforeseen problems. The USDA made government stocks of nonfat dry milk available to the Red Cross for distribution after the October 1989 earthquake in California. However, the shortage of potable water in a number of areas made reconstitution difficult. In fact, a number of dairy plants, on an unorganized and voluntary basis, sent in tank trucks filled with water to help alleviate the shortage.

Prevention planning, among other things, involves zoning and land use restrictions in floodplains, coastal areas and geologically active sites, in an attempt to limit the number of people and industries exposed to the kind of disasters to which some areas are known to be prone. Prevention planning is not very popular because it tends to restrict economic choices in the short-run.

Given the schema above, it is clear that disaster planning for the dairy industry would most logically fit into the response and recovery categories. With the exception of a FEMA guidance on monitoring radiation levels in milk after a commercial nuclear power plant reactor accident (FEMA REP-12), there is no planning in place specifically for the dairy industry on either the federal or state level.

To the extent that any disaster planning takes place, it is generally incident-specific. In the wake of the October 1989 earthquake, several of California's dairy cooperatives began to discuss the need for independent contingency planning that addresses the larger concerns of the industry. Such a planning effort in any part of the country would need to take into account the three basic market levels of the industry, namely, farm milk production, milk processing, and dairy product consumption. As a preliminary step in this planning process, a spatial model is used to assess and analyze potential impacts of local and regional disasters on each sector of the dairy industry. As a disaster example, a radioactive release from a nuclear power plant located on Lake Ontario is used. Potential impacts are analyzed within the framework of the Northeast Dairy Sector Simulator.

#### THE NORTHEAST DAIRY SECTOR SIMULATOR

The Northeast Dairy Sector Simulator (NEDSS) is a highly disaggregated transshipment and plant location model that combines network flow and facilities location methods (Pratt et al. 1986). The model draws on the dairy plant location formulation described by King and Logan in 1964, and modified in later dairy sector analyses by Beck and Goodin (1980), Boehm and Conner (1976), Buccola and Conner (1979), Kloth and Blakley (1971), and Thomas and DeHaven (1979). It builds on the plant location application discussed by Fuller, Randolph, and Klingman (1976), on the transshipment model described by McLean et al. (1982), and on the dairy sector networks constructed by Babb et al. (1977) and Novakovic et al. (1980).

NEDSS differs from its precursors in the degree of its spatial aggregation; it is considerably more disaggregated when compared to similar models. This is made possible by the use of recently developed solution algorithms (Grigoriadis 1986) and access to the computational capabilities of a supercomputer. Typically, dairy plant location models have been forced to severely restrict the size of the problems that they analyzed. Normally, this required limiting the numbers of possible supply or processing points, or independent analyses of each dairy product class. In addition, the movements of processed products from processing to consumption points were ignored in most earlier analyses.

The problem solved by NEDSS can be described as a single commodity transshipment problem. A transshipment problem is a network flow problem in which there are supply, demand, and transshipment nodes that are connected by directed arcs. A directed arc is an ordered pair of nodes  $(i, j)$  which represents

the possibility of a flow ( $X_{i,j}$ ) (milk or milk products in this problem) from the first node to the second. For example, in Figure 1, circles, triangles and squares represent supply, processing, and consumption nodes respectively. Directed arcs, represented by arrows, connect pairs of nodes of each type. Directed arcs from supply (circles) to processing (triangles) represent the assembly of milk from farms and delivery to processing plants in bulk form. Associated with each arc is a bulk milk transportation cost per unit ( $a_{i,j}$ ) and a capacity ( $c_{i,j}$ ). Arcs connecting processing nodes (triangles) to processing nodes (triangles) represent the conversion of farm milk into consumable dairy products at each processing location. These arcs also have associated per unit processing costs and processing capacities. Arcs connecting processing (triangles) and consumption (squares) represent the distribution of processed dairy products to consumption centers. These also have associated distribution costs and capacities.

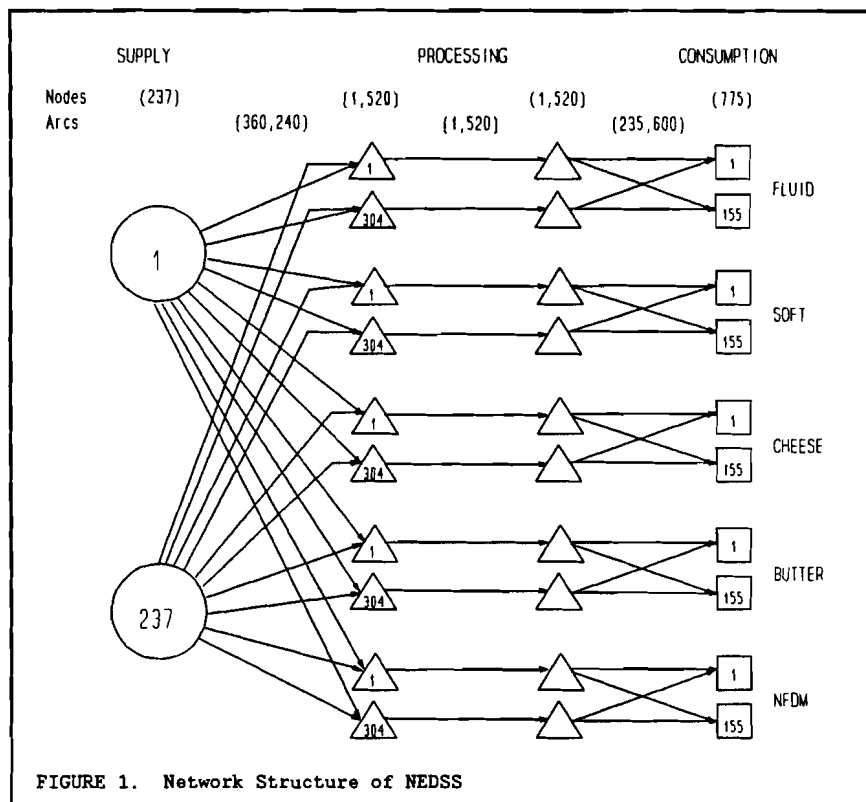

For each node  $i$ , there is an associated number  $b_i$  such that

$$\sum_j X_{ji} - \sum_j X_{ij} \geq b_i.$$

If  $b_i < 0$ , then node  $i$  is a supply node (circle). If  $b_i > 0$ , then node  $i$  is a demand node (square). Finally, if  $b_i = 0$ , then node  $i$  is a transshipment node (triangle).

The network flow problem is

$$\begin{aligned} & \text{minimize } \sum_i \sum_j a_{ij} X_{ij} \\ & \text{subject to } \sum_j X_{ji} - \sum_j X_{ij} = b_i \\ & \qquad \qquad 0 \leq X_{ij} \leq C_{ij} \end{aligned}$$

where  $b_i$  is negative for supply, positive for demand and zero for transshipment nodes. A solution to the transshipment problem is feasible if the flow on each arc is no larger than the capacity of that arc, and the sum of flows in to any node minus the sum of flows out of that node is equal to the associated  $b_i$  for that node. The cost of the network is equal to the sum, over all the arcs, of the flow on each arc times its cost. A transshipment problem is solved when a feasible solution of minimum cost is found.

NEDSS allocates raw milk and manufactured product supplies among processing and consumption centers on the basis of transportation costs (both milk assembly and dairy product distribution), and on the basis of individual plant processing costs and capacities. Farm milk production, dairy product processing, and consumption centers, as well as the flows of milk and milk products between these centers, can be constrained to simulate the effects of a disaster at either a single or multiple market level.

The Northeast dairy industry is viewed at three market levels: production, processing, and consumption, as shown in Figure 1. To represent the farm milk production in the Northeast, 236 points representing single counties or aggregations of counties in a 13-state area were chosen, as shown in Figure 2. At the processing level, milk is assumed to be processed into one of five product classes. Class I consists of fluid milk products, and includes whole, 2%, skim, buttermilk, and flavored milk drinks. Class II consists of 'soft' products and includes half and half, light cream, heavy cream, sour cream, cottage cheese, and frozen desserts. Class III is hard cheese, Class IV is butter, and Class V is nonfat dry milk.

A concerted effort was undertaken to identify actual dairy processing facilities in the study area. Three hundred twenty-three fluid plants, 98 soft product plants, 74 cheese plants, and 13 butter and nonfat dry milk plants were catalogued. Each plant was assigned to one of 303 city locations used in the model, with some cities functioning as the site of two or more plants. In this manner, 147 of the 303 city locations were permitted to function as potential processors of Class I products in the following scenarios. Similarly, 71, 47, and 11 city locations were permitted to process Classes II, III, and combined IV & V products, respectively. These aggregated processing centers for each product class are shown in Figures 3 to 6. All product groups from each class are assumed to be consumed at the retail level, and 153 dairy product consumption centers, representing single or multiple counties, were chosen within the 13-state area, as shown in Figure 7. Milk production, processing, and dairy product consumption activities outside the Northeast region are accounted for in the model, and are depicted as points outside the region (in Figure 9 and following figures). No extra-regional Class I processing is allowed to occur.



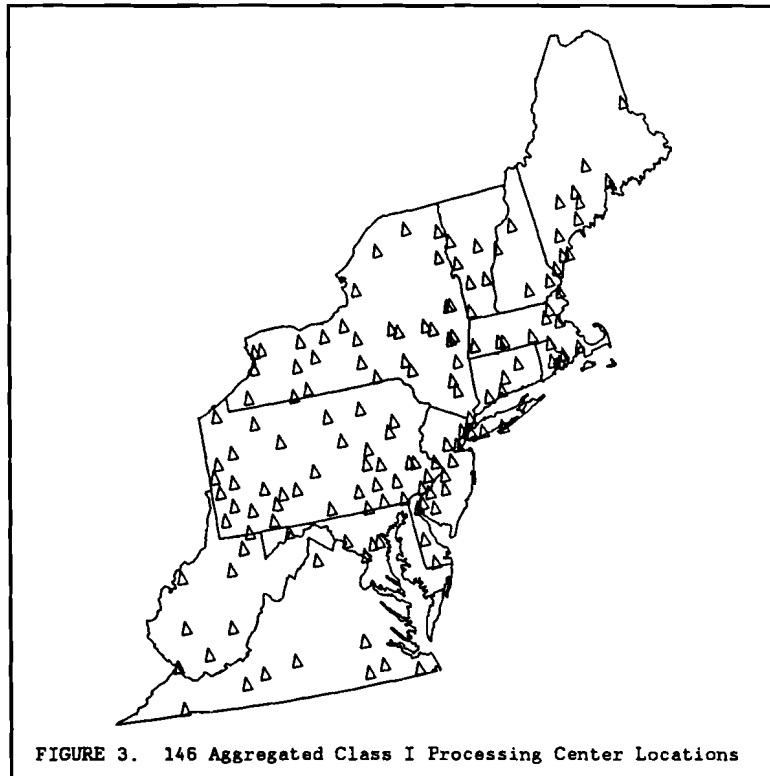
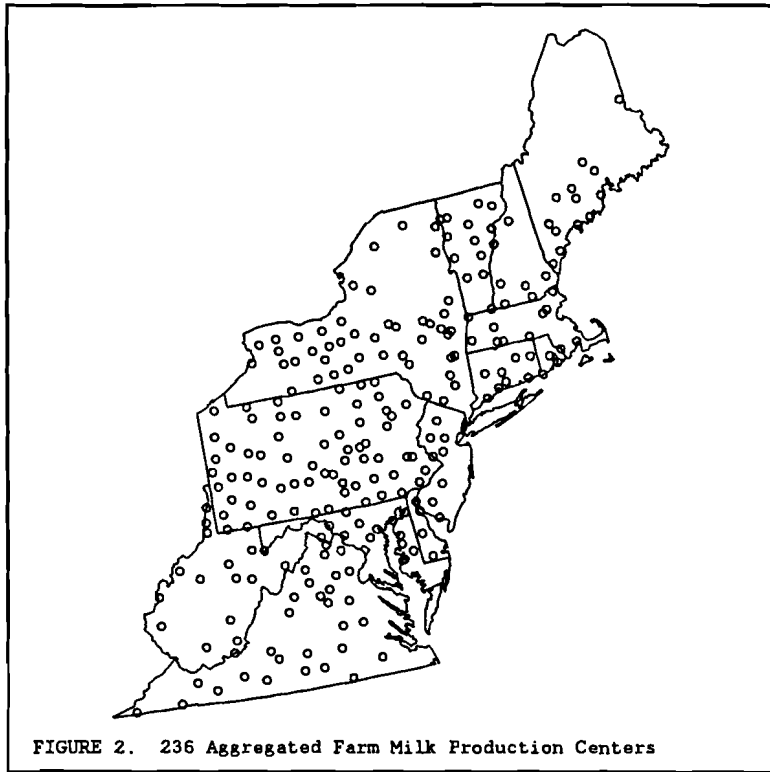

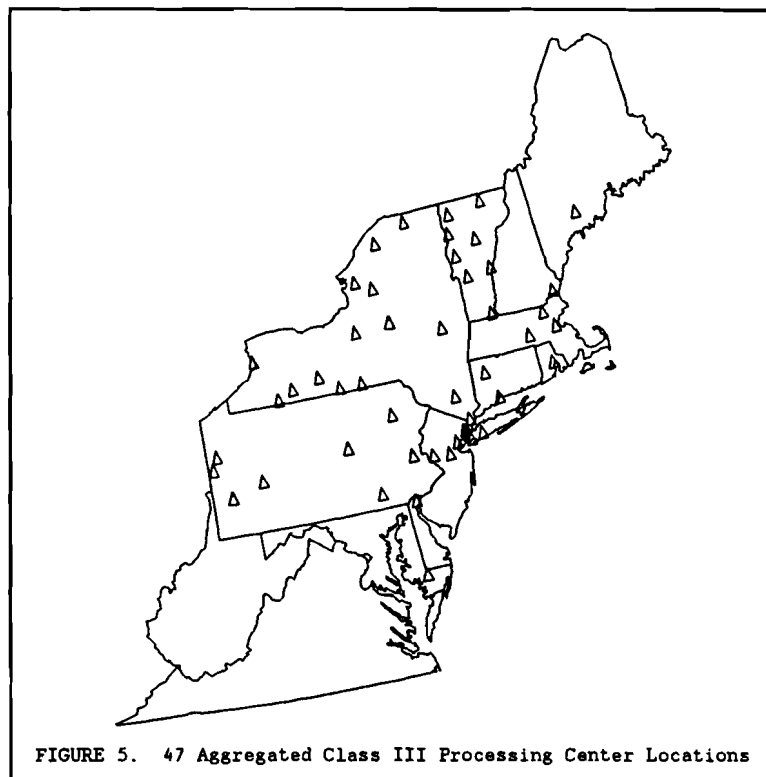
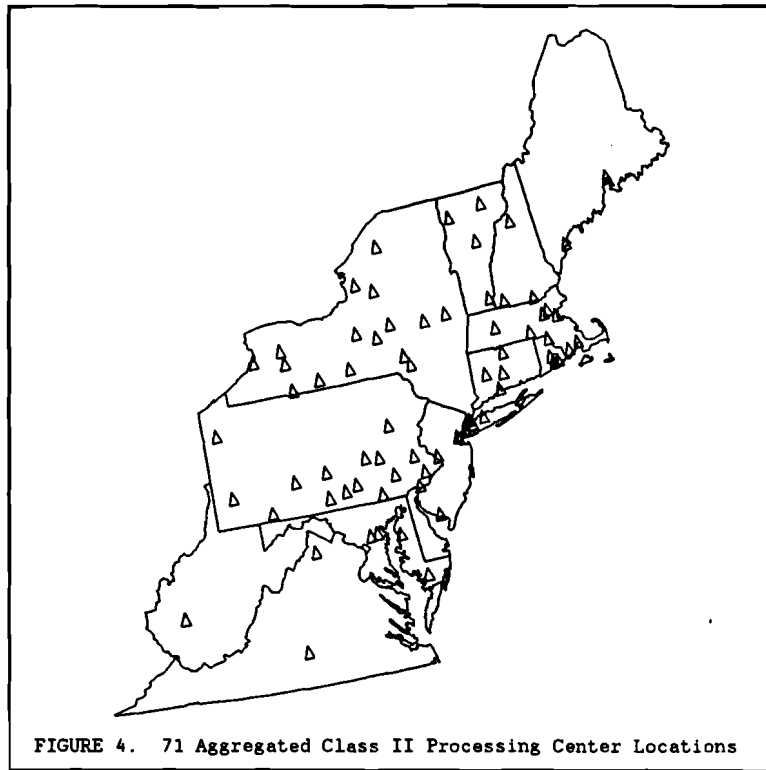

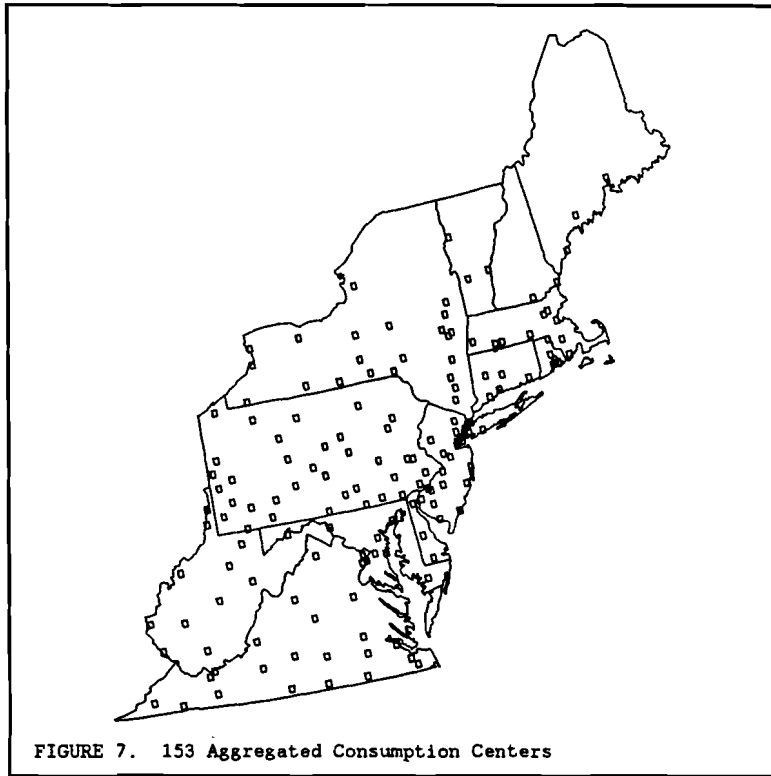
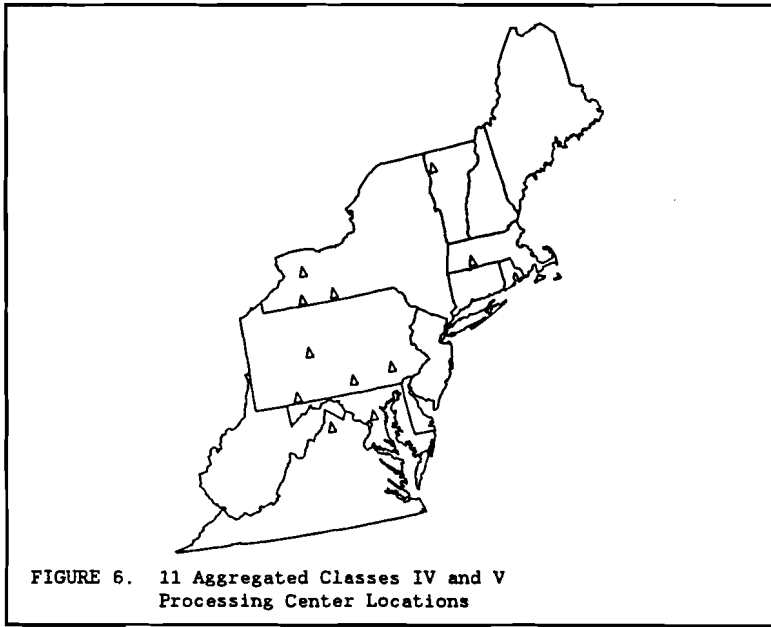

## BASE SCENARIO

A base scenario, in which processing locations were optimized for least manufacturing and transportation costs, is shown in Figures 8 to 11 for all product classes. Weighted average milk assembly and distribution distances within the study region for each product class are reported in Table 1. Figure 8 depicts Class I supply to processing and processing to consumption movements. The longest supply center to processing location distance was 266 miles, between Wellsboro, PA and Levittown, NY, while the longest processing to consumption distance was 82 miles, from Abingdon, VA to Bluefield, WV. Figures 9, 10 and 11 depict assembly and distribution movements for Classes II, III, and combined IV & V, respectively. The longest Class II distribution movement, 369 miles between Canton, NY and Boston, MA, was over two and a half times greater than the longest Class II assembly movement. Similar patterns exist for cheese, butter, and nonfat dry milk. The longest distribution movement for butter was nearly ten times greater than the longest butter assembly movement. This reflects that fact that it is less costly to transport the finished product (ice cream, cheese, butter, or powder) than the bulk milk used in its manufacture.

## PLUME SCENARIO

To illustrate the use of the model, a radioactive release from the Nine Mile Point Nuclear Station Unit 2 reactor in Oswego, N.Y. is postulated. Nine Mile 2 is a steam turbine boiling water reactor (Energy Information Administration 1990), and is located, as shown in Figure 12, in an area in which dairying is an important agricultural activity, Figures 13. Oswego County and its six neighboring counties accounts for nearly 25% of New York's total milk production. A significant release of radioactive material that included iodine-131, strontium-90 and cesium-137 (the isotopes of most concern in milk), would certainly have devastating impacts on the regional milkshed.

Although design differences between Soviet and American reactors make a Chernobyl-type accident impossible in the U.S., other design flaws found in U.S. plants could produce effects similar in kind to Chernobyl. Nine Mile Point has had a history of operating problems, the most recent of which (August, 1991) resulted in the declaration of a Site Area Emergency, the second most serious emergency classification category possible, and one which has only been invoked a total of three times since the classification system was created in the wake of the Three Mile Island accident in 1979. On August 13th, 1991, according to reports, a transformer failed at the facility, causing a power surge which tripped circuit breakers for the main turbine and major power system. Safety monitors, main control room equipment and the main computer were knocked out (Schneider August 14). Although there were two independent backup systems that were supposed to provide an alternate power source in the event of just such a failure, both of them failed as well (Wald, August 15). The Nuclear Regulatory Commission is conducting an investigation of the mishap, and investigators have indicated that the flaws found in Nine Mile Station's electrical system may be extant in other nuclear plants as well. No radioactive material was released during this event.

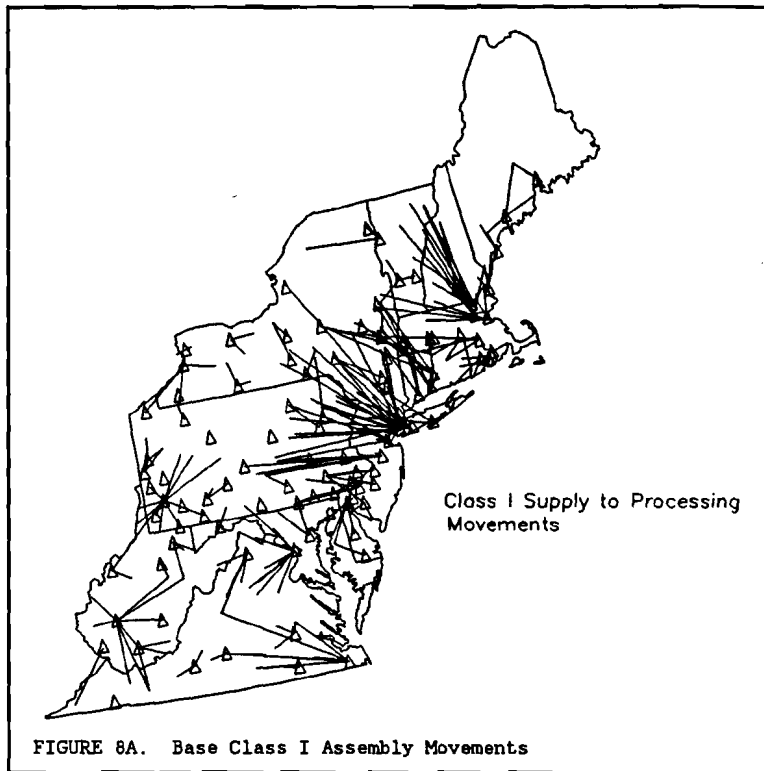

FIGURE 8A. Base Class I Assembly Movements

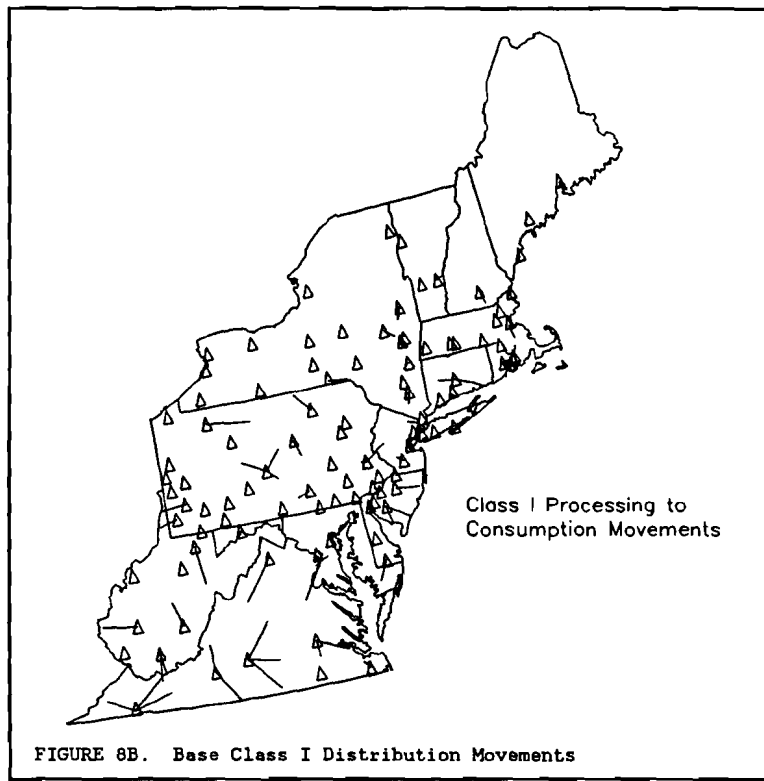
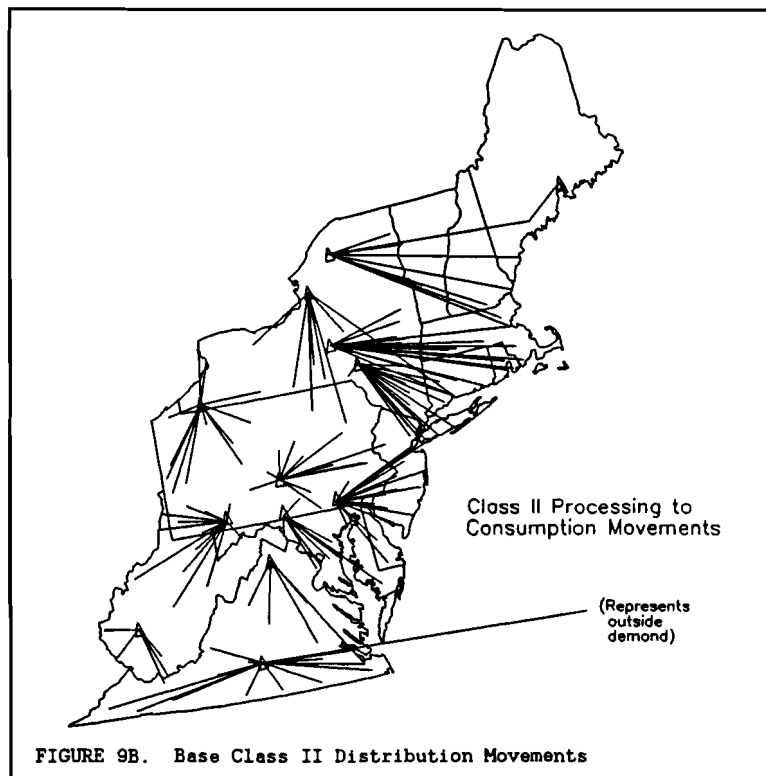
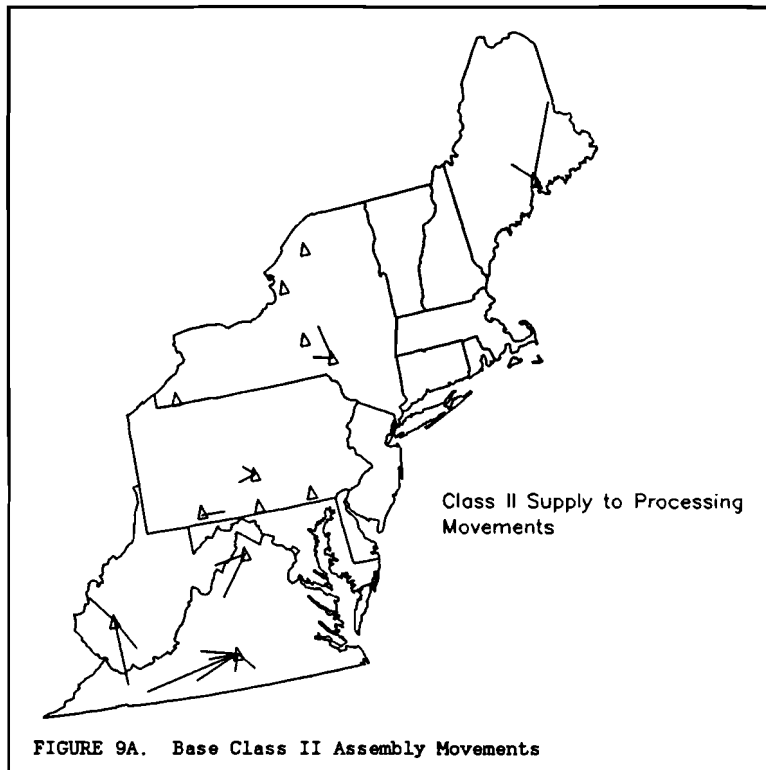
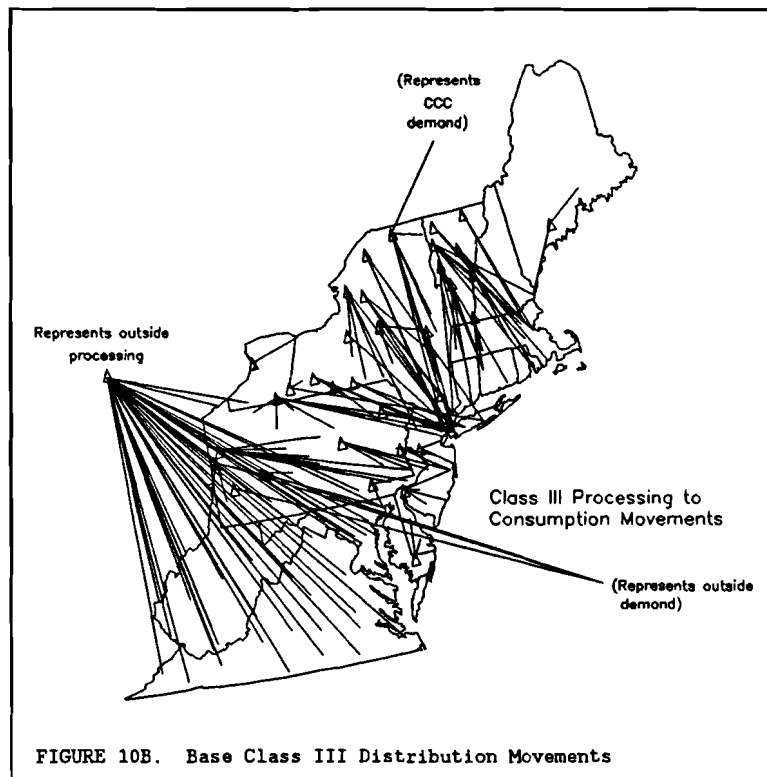
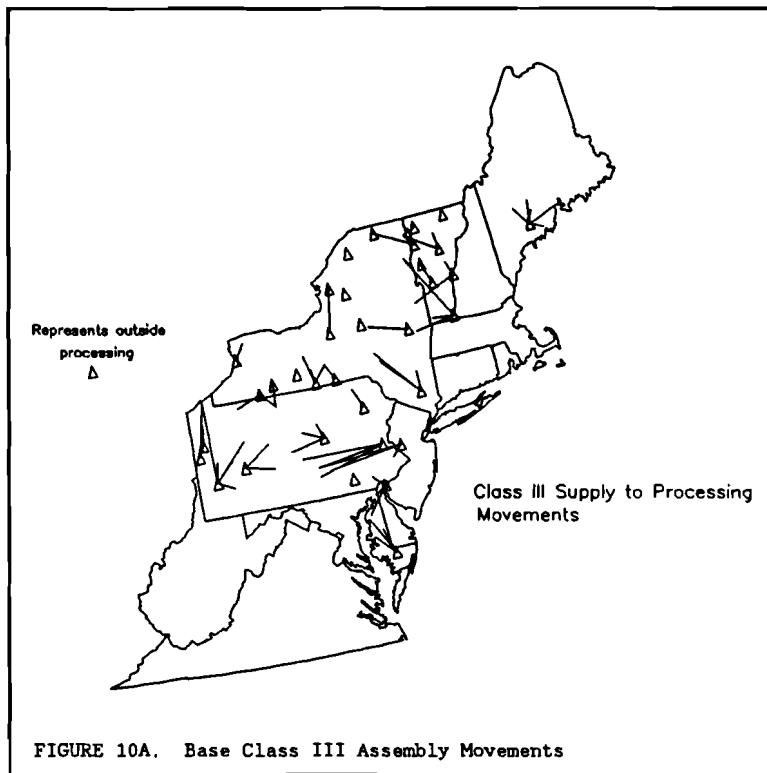
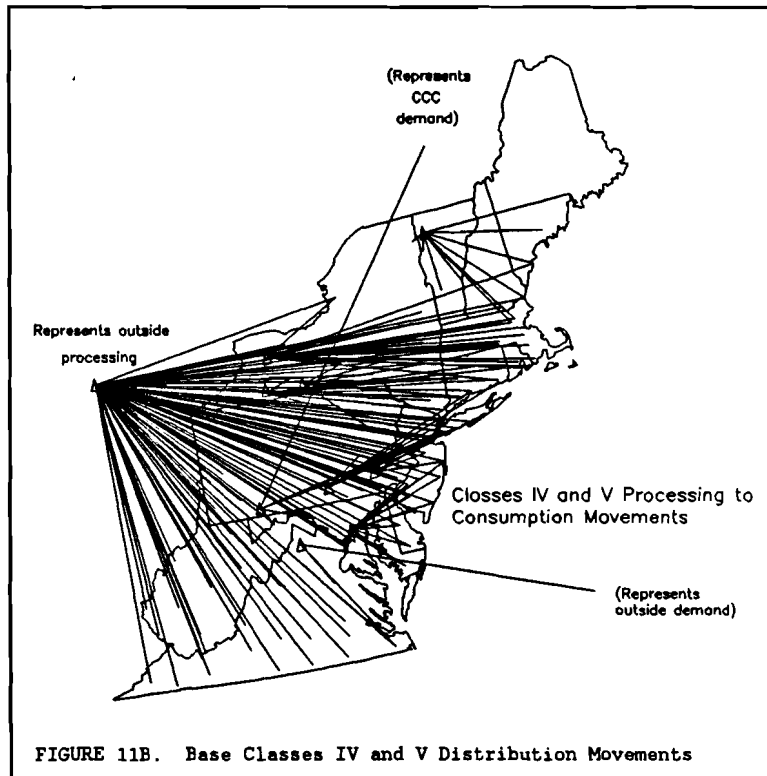
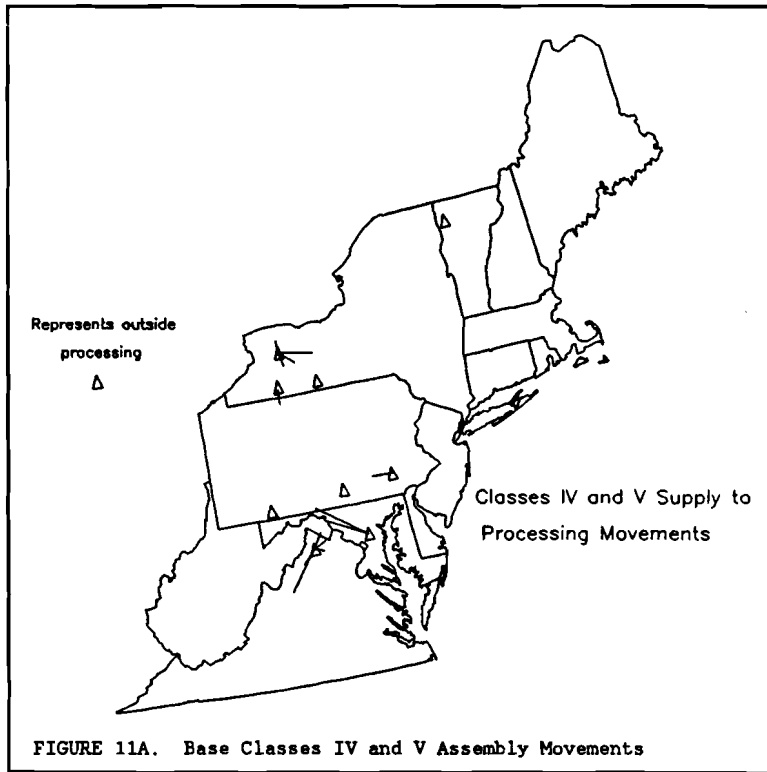

FIGURE 8B. Base Class I Distribution Movements









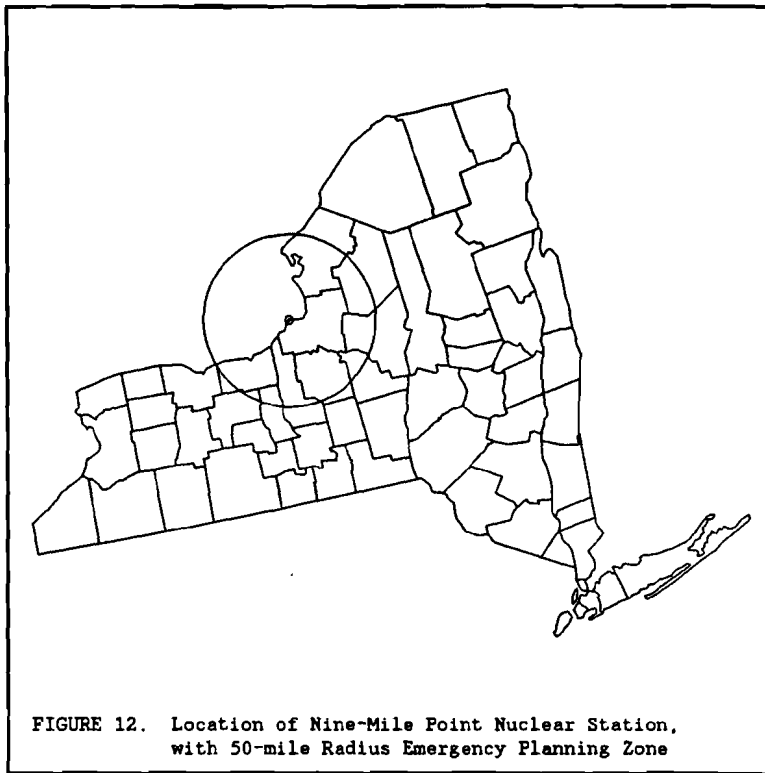

Table 1. Base Milk Assembly and Distribution Movements	Weighted Average Assembly Distance (mi.)	Weighted Average Distribution Distance (mi.)
Class I	84.2	5.9
Class II	17.5	143.6
Class III	27.5	160.1
Class IV	21.4	346.7
Class V	27.5	197.5
Note: In calculating the weighted average distances, movements to or from extra-regional points were excluded.		

For the purpose of this analysis, the release quantity and composition, shown in Table 2, was selected to exceed federal Protective Action Guide emergency levels. The PAG levels are established for what the federal government calls "critical populations." For radioiodine, the critical population consists of newborn infants, (including fetuses); while for all other isotopes, the critical population is infants under one year old. The total release chosen for the scenario was twenty-five million curies of radiation, delivered over sixty hours. The release quantity and duration are roughly one quarter of that estimated for the Chernobyl accident of 1986. Calculations for infant thyroid and whole body dose rates and totals, as well as an estimated plume path were generated using a Nuclear Regulatory Commission public domain computer software program called IRDAM (Interactive Rapid Dose Assessment Model). Centerline dose calculations are shown in Table 3; the plume path is depicted in Figure 14. It was assumed that the wind was blowing steadily from the northwest at fifteen miles per hour for the duration of the release. It is important to emphasize that the magnitude of the release was not chosen for its likelihood but rather for its impact. While an accident on that scale is theoretically possible, it is considered unlikely by emergency management planning personnel.

Table 2. Release Characterization

Release Duration: 60 hours                      Gross Release: 25,000,000 Ci  
 Total Release: 115.74 Ci/sec

**ISOTOPIC MIXTURE (Ci/sec)**

Isotope	Ci	Isotope	Ci
*Krypton-83m	4.40	*Xenon-135	4.46
*Krypton-85m	4.46	*Xenon-137	4.46
*Krypton-85	4.46	*Xenon-138	4.46
*Krypton-87	4.46	Cesium-134	5.79
*Krypton-88	4.46	Cesium-137	5.79
*Krypton-89	4.46	Iodine-131	37.00
*Xenon-131m	4.46	Iodine-132	2.31
*Xenon-133m	4.46	Iodine-133	2.31
*Xenon-133	4.46	Iodine-134	2.31
*Xenon-135m	4.46	Iodine-135	2.31

\*Noble gases.

Table 3. Centerline Dose Calculation

Downwind Distance (mi)	Travel Time (hr:min)	Whole Body		Infant Thyroid	
		(rems/hr)	(rems)	(rems/hr)	(rems)
0.3	0:1.2	1.0500	63.000	2850.000	171,000
0.6	0:2.4	10.0296	17.700	801.667	48,100
1.2	0:4.8	0.0835	5.010	226.667	13,600
2.0	0:8.0	0.0330	1.980	889.667	5,380
5.0	0:20.0	0.0063	10.376	17.000	1,020
10.0	0:40.0	0.0018	0.108	4.883	293

**FDA Emergency Protective Action Guides**

Iodine-131- 15 rem (thyroid)  
 Cesium-134- 5 rem (whole body)  
 Cesium-137- 5 rem (whole body)

(Interactive Rapid Dose Assessment Model)

Milk from farms found to be contaminated with radioactive isotopes and therefore unfit for immediate consumption can be either disposed of (dumped) or processed into storable form (butter or nonfat dry milk), depending on the degree and kind of contamination. Radionuclides begin to appear in milk within 10-12 hours after the ingestion of contaminated forage. Radioactivity levels peak between 24 hours and several days after the release. Therefore, pasture and animal monitoring must begin as soon after the release event as possible, in order to prevent contaminated milk from entering the human food chain. Iodine-131 has a relatively short half-life (eight days) and if the isotope is present in fairly low concentrations, it is safe to process contaminated milk into nonfat dry milk and store it until the radioactivity decays. However, cesium isotopes have a considerably longer half-life (on the order of years, not days), and if concentrated, as would be the case in manufactured products, would render storage problematic.

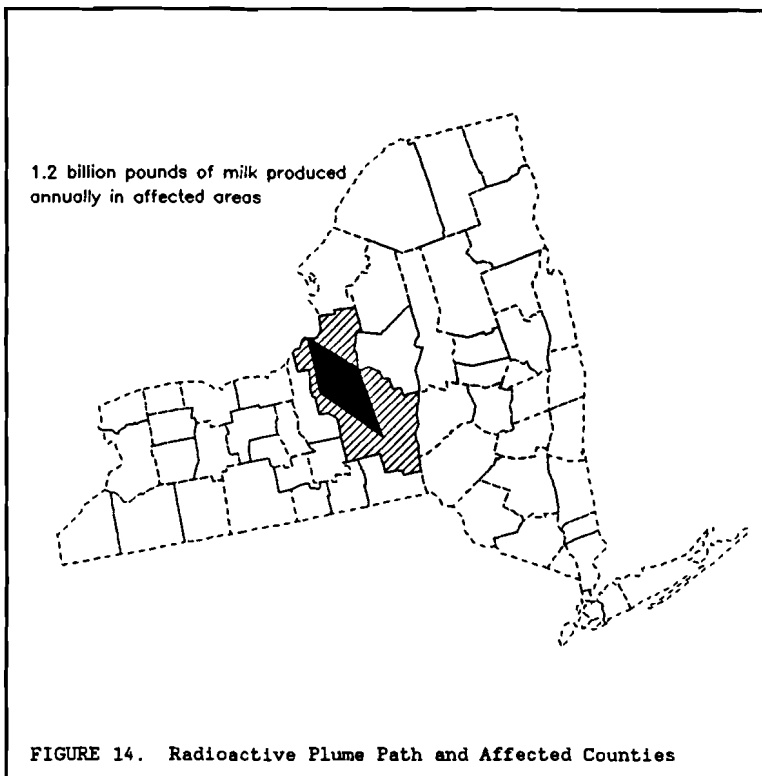
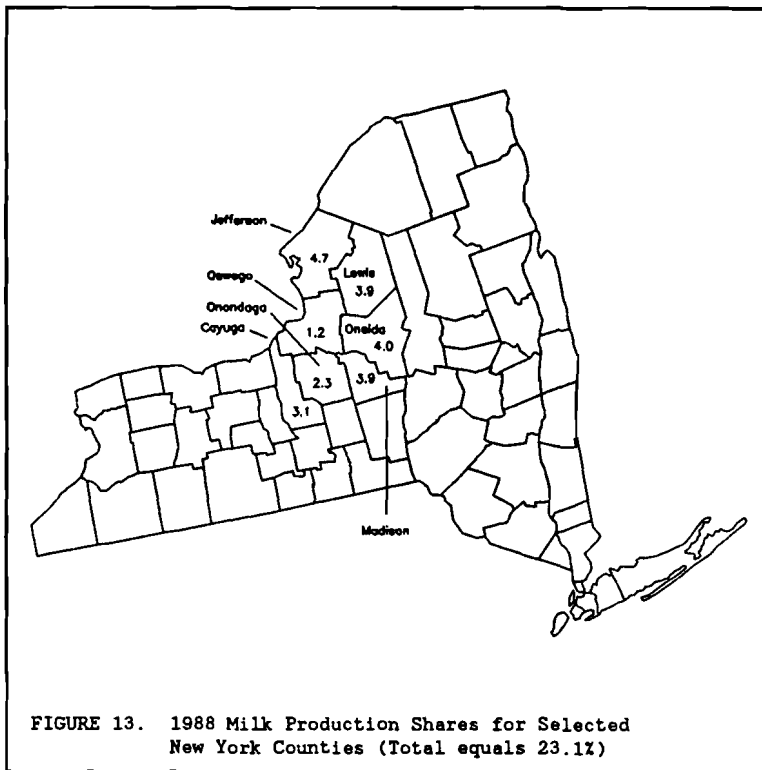

Whether consumers would be willing to consume products made from this milk is another question. In the wake of Chernobyl, a number of countries set newly stringent radiation level regulations for milk product imports. Products made from milk tainted by Chernobyl fallout were refused entry into Brazil and Malaysia because of government and consumer safety fears. Shipments of nonfat dry milk from seven European countries (Austria, Ireland, Belgium, Denmark, France, the Netherlands, and Britain) to Brazil were found to contain levels of radioactive cesium far in excess of the maximum levels permitted for use in Europe (New York Times 12 Jan. 1987). As late as January 1988, nearly two years after the disaster, a West German export company was embroiled in a scandal over plans to ship heavily contaminated milk powder to Angola and Egypt. The company contended that its understanding was that the powder destined for Angola would be mixed with other ingredients and used for animal feed only, while the official Angolan press agency reported that it was to have been used in hunger relief (New York Times 10 Jan. and 31 Jan. 1988). However, the severity of the contamination discussed here precludes the use of the affected milk supply in any way. The milk supply located under the plume path, which on an annual basis is equal to 1.2 billion pounds, is assumed to be dumped. Populations in the affected counties are held constant, although the model is capable of incorporating the results of crisis relocation plans by reallocating the population numbers of affected counties to the appropriate host counties.

The results suggest that the consequences of such a significant drop in New York State's milk supply are felt through the entire region, for all product classes. Table 4 delineates the optimal number of processing locations in both the base and disaster solutions. While there was a net loss of one location for Class I processing (resulting in a million pound increase in average pounds processed per plant), a new location in Pennsylvania became active in the plume scenario. Class II activity changed substantially on the state level. Maine, Pennsylvania, and West Virginia increased activity, while New York and Virginia decreased. Although the quantity processed was unchanged, average pounds processed per plant dropped from 327 million to 303 million pounds. This change was the result both of an additional processor entering the solution, and the model-determined downsizing of the largest processor from 838 million pounds to 775 million pounds. Activity in Class III processing within the region showed a decrease of 505 million pounds (6.6%), which was absorbed by outside processing. Maryland Class III processing declined by over 40%, with Maine, New York, and Vermont down significantly. The remaining classes of products showed a consistent gain in outside processing at the expense of regional activity. Class IV changes resulted in the loss of all Vermont processing as well as an increase in average pounds processed per plant of 50% -- from 1.695 billion to 2.543 billion pounds. Class V processing decreased significantly in Maryland and Pennsylvania (by 21 and 25 percent respectively).

Preliminary comparisons of assembly and distribution costs before and after disaster indicate that for Class I, costs for milk assembly were less expensive in the plume scenario, by approximately \$1.4 million, but much more expensive to distribute (by approximately \$1.2 million). For Class II, the converse is true. Assembly costs were greater in the plume scenario (by \$.2 million), but distribution costs were about \$1.2 million less than in the base scenario. Assembly costs associated with outside processing of Classes III, IV and V are not calculated; hence it is not possible to compare changes in total assembly

Table 4. Number of Northeast Dairy Processing Facilities		
Class	Base	Plume
Class I	102	101
Class II	13	14
Class III	35	33
Class IV	3	2
Class V	10	9
Total	163	159

versus distribution costs. One obvious effect is that more dairy products must be obtained from outside the region.

#### CONCLUSIONS

The reorganized structure suggested by NEDSS could be used as a guideline in response and recovery activities. The model incorporates a highly detailed road network system that is used in calculating least cost transportation routes. The road system is also used in determining alternative milk and product routing in the event that roads are closed or inaccessible. Additions to the road system in the form of other road segments are easily incorporated.

The scenario outlined as an example could apply to any of the 33 states in which the nation's 111 operating commercial nuclear reactors (as of December, 1990) are located. Figure 15 illustrates the number of reactors in each state. All of the top ten dairy states (shaded in the figure) contain commercial nuclear reactors. Just over two-thirds of the nation's milk are produced in these ten states, which are also home to just over one-third of the nation's reactors. In a wider sense, all states are vulnerable. As Chernobyl proved, accidents of this kind are not confined by arbitrary, man-made boundaries. Moreover, many of the nation's nuclear facilities are near the end of their estimated thirty year economically viable operating life (Heinze-Fry 1990). As they age, they become more vulnerable to component stresses and failure. There were a total of 33 operating reactors in the Northeast at the end of 1990, 30 percent of the U.S. total. Of these, five reactors went on-line for the first time in the 1960s. The county locations of reactors in the Northeast are shown in Figure 16.

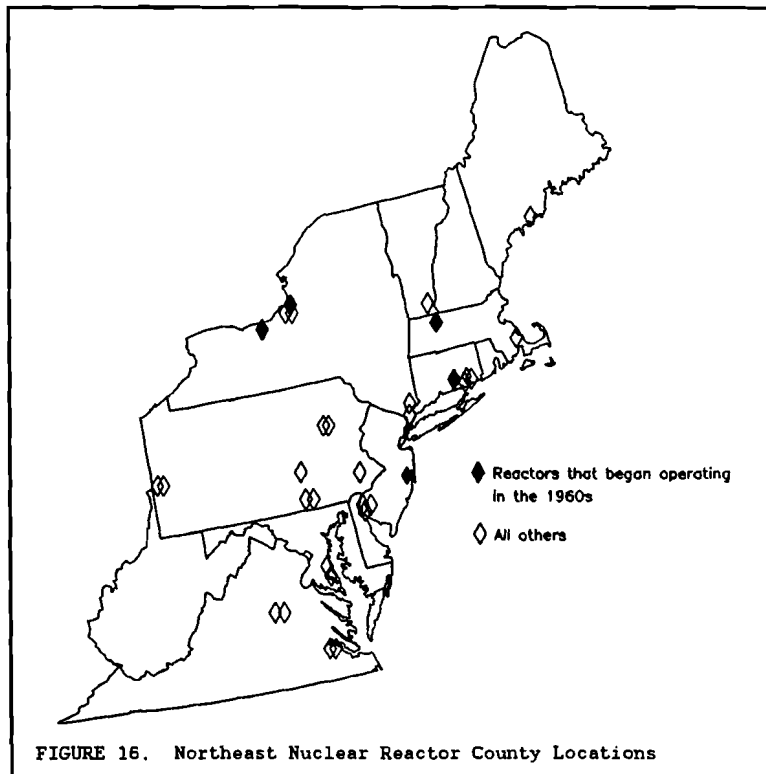
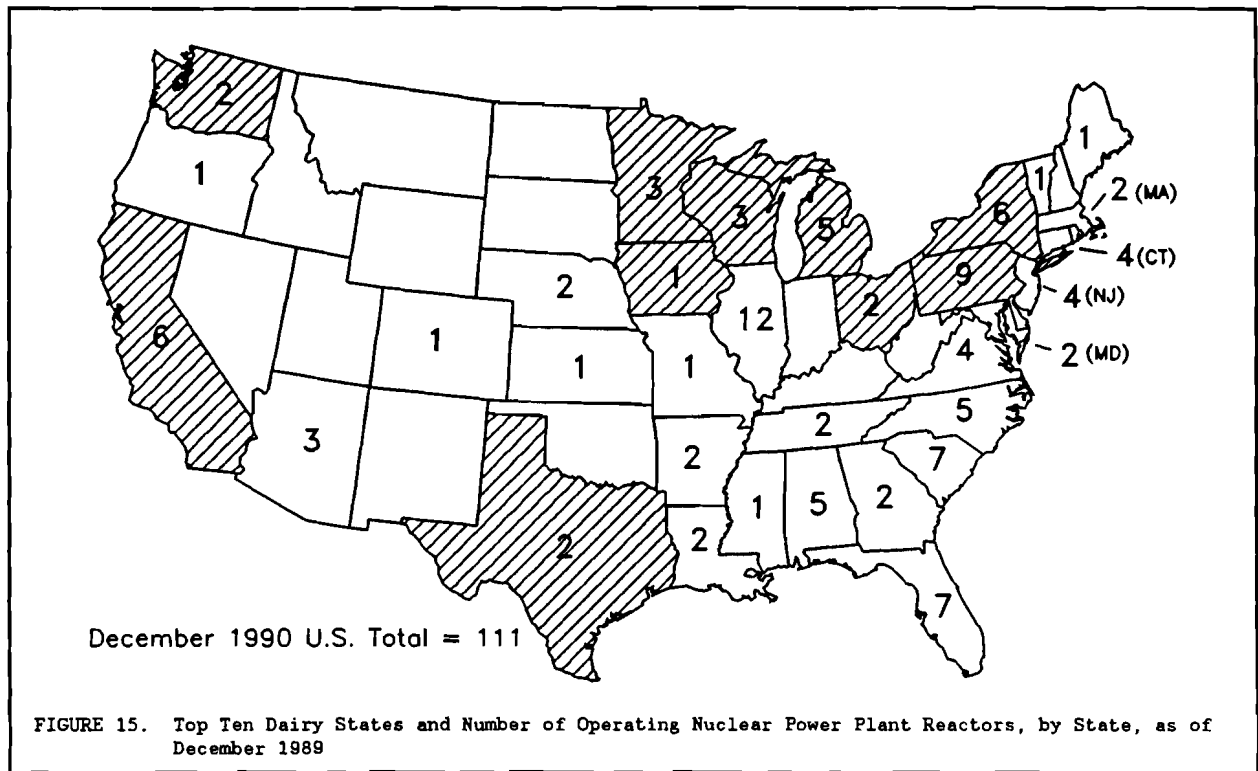

The disaster example given is only one scenario to which the model could be applied. The effects of other disasters, such as earthquakes, hurricanes, or widespread feed contamination (as happened in Michigan in the early 1970s) are others. Impacts can be assessed on a daily, weekly, monthly, or longer operational basis. Nuclear incidents of the scale discussed have foreseeably long-term effects on animals and the environment, making a major restructuring of the dairy sector over a longer period advisable or desirable. Other kinds of disasters, such as the ones mentioned above, have great short-term consequences, but less or no effect in the long run. The October 1989 earthquake in California, for example, disrupted transportation linkages in the Bay area for months. Some dairy plants reported that delays in delivery time because of bridge, highway, and road damage from the quake, as well as power outages at the plants resulted in large cost burdens for the processors. Rerouting trucks around closed roads took more time, meaning that additional trucks and trailers were rented in order to deliver product on time; more overtime costs for workers were also incurred. A number of plants reported that even when they made deliveries of packaged milk products to their store customers, a number of stores were so damaged by the earthquake that they were unable to receive the shipments.

Disaster researchers predict more and worse disasters in the future. The dairy industry, by virtue of its size and geographic diversity will eventually be confronted by the effects of a major disaster, whether man-made or natural, that will be too large for it to handle without some kind of planning and preparation. Given the current dearth of federal and state effort focused on disaster planning in the industry, it is unlikely that the dairy industry can depend on governmental agencies to address it in the future. More research is needed on general disaster planning and mitigation strategies for the dairy industry. Use of the NEDSS model provides a tool for assessing potential impacts of specified types of disasters, and a means of suggesting appropriate response and recovery strategies.



## Bibliography

- Babb, Emerson M., D.E. Banker, O. Goldman, D.R. Martella, and J.E. Pratt. 1977. Economic Model of Federal Milk Marketing Order Policy Simulator--Model A. Sta. Bulletin no. 158, Purdue University, West Lafayette, IN.
- Beck, Robert L., and J. Don Goodin. 1980. "Optimum Number and Location of Manufacturing Milk Plants to Minimize Marketing Costs." *Southern Journal of Agricultural Economics*, July, pp. 103-8.
- Boehm, William T., and M.C. Conner. 1976. Technically Efficient Milk Assembly and Hard Product Processing for the Southeastern Dairy Conference Dairy Industry. Research Div. Bulletin No. 122, VPI and SU, Blacksburg, VA.
- Buccola, Steven T., and M.C. Conner. 1979. Potential Efficiencies Through Coordination of Milk Assembly and Milk Manufacturing Plant Location in the Northeastern United States. Research Div. Bulletin No. 149, VPI and SU, Blacksburg, VA.
- Dynes, R., A. Purcell, D. Wenger, P. Stern, R. Stallings and Q. Johnson. October 1979. Staff Report to the President's Commission on the Accident at Three Mile Island. Washington, D.C.: U.S. Government Printing Office.
- Energy Information Administration. 1990. Inventory of Power Plants in the United States 1989. Washington, D.C.: U.S. Department of Energy.
- Federal Emergency Management Agency. FEMA REP-12/September 1987. Guidance on Offsite Emergency Radiation Measurement Systems: Phase 2 - The Milk Pathway. Washington, D.C.: Federal Emergency Management Agency.
- Fuller, Stephen W., Paul Randolph, and Darwin Kingman. 1976. "Optimizing Subindustry Marketing Organizations: A Network Analysis Approach." *American Journal of Agricultural Economics*, August, pp. 425-36.
- Grigoriadis, M.D. 1986. An Efficient Implementation of the Network Simplex Method. *Mathematical Programming Study* 26. March, pp. 83-111.
- Heinze-Fry, Gene Richard. 1989. The Economics of Nuclear Power Plants as They Age: Production (Capacity Factors), Variable Costs, and Retirement. Unpublished Ph.D diss. Ithaca, NY: Cornell University.
- King, Gordon A., and Samuel H. Logan. 1964. "Optimal Location, Number and Size of Processing Plants With Raw Product and Final Product Shipments." *Journal of Farm Economics*, 46(3):94-108.
- Kloth, Donald W., and Leo V. Blakley. 1971. "Optimum Dairy Plant Location With Economies of Size and Market Share Restrictions." *American Journal of Agricultural Economics*, August, pp. 461-66.
- McLean, Stuart, Alan Kezis, James Fitzpatrick, and Homer Metzger. 1982. Transshipment Model of the Maine Milk Industry. Technical Bulletin No. 106, University of Maine, Orono.

- Novakovic, Andrew M., E.M. Babb, D.R. Martella, and J.E. Pratt. 1980. An Economic and Mathematical Description of the Dairy Policy Simulator. A.E Res. 80-21, Cornell University Agr. Exp. Sta., Ithaca, NY.
- Pratt, J.E., A.M. Novakovic, G.J. Elterich, D.E. Hahn, B.J. Smith, and G.K. Criner. 1986. An Analysis of the Spatial Organization of the Northeast Dairy Industry. Search: Agriculture, Ithaca, NY: Cornell Univ. Agr. Exp. Sta. No. 32.
- Pratt, J.E., A.M. Novakovic, and M.M. Keniston. Forthcoming. The U.S. Dairy Sector Simulator: A Tool for Spatial Analysis of the Dairy Industry. Ithaca, NY: Cornell University.
- Quarantelli, E.L. 1987. Research in the Disaster Area: What Is Being Done and What Should Be Done? Disaster Research Center: University of Delaware.
- Thomas, William A., and R. Kenneth DeHaven. 1977. Optimum Number, Size, and Location of Fluid Milk Processing Plants in South Carolina. South Carolina Agricultural Experiment Station Bulletin No. 603, Clemson University, Clemson, S.C.
- U.S. Congress. House. Committee on Public Works and Transportation. Subcommittee on Water Resources. Hearing on the Reauthorization of the Federal Disaster Relief Program. 100th Congress, 1st sess., 1987.
- Waugh, William L. Jr. 1988. "Current Policy and Implementation in Disaster Preparedness" in Managing Disaster: Strategies and Policy Perspectives. Durham: Duke University Press.

#### Newspaper Articles

- Simons, Marlise. "Brazil Court Bans Milk From Europe." New York Times. 12 January 1987.
- Tagliabue, John. "A Nuclear Taint in Milk Sets Off German Dispute." New York Times. 31 January 1987.
- Brooke, James. "After Chernobyl, Africans Ask If Food Is Hot." New York Times. 10 January 1988.
- Schneider, Keith. "New York A-Plant Shut Down By Staff As Instruments Fail." New York Times. 14 August, 1991.
- Wald, Matthew L. "Power Failure Left A-Plant In Confusion." New York Times. 15 August, 1991.
- Wald, Matthew L. "New Fears on A-Plant Mishap." New York Times. 16 August, 1991.