

De Santis, Roberta; Esposito, Piero; Jona-Lasinio, Cecilia

**Working Paper**

## Environmental regulation and productivity growth: main policy challenges

LEQS Paper, No. 158

**Provided in Cooperation with:**

London School of Economics and Political Science (LSE), European Institute

*Suggested Citation:* De Santis, Roberta; Esposito, Piero; Jona-Lasinio, Cecilia (2020) : Environmental regulation and productivity growth: main policy challenges, LEQS Paper, No. 158, London School of Economics and Political Science (LSE), European Institute, London

This Version is available at:

<https://hdl.handle.net/10419/303441>

**Standard-Nutzungsbedingungen:**

Die Dokumente auf EconStor dürfen zu eigenen wissenschaftlichen Zwecken und zum Privatgebrauch gespeichert und kopiert werden.

Sie dürfen die Dokumente nicht für öffentliche oder kommerzielle Zwecke vervielfältigen, öffentlich ausstellen, öffentlich zugänglich machen, vertreiben oder anderweitig nutzen.

Sofern die Verfasser die Dokumente unter Open-Content-Lizenzen (insbesondere CC-Lizenzen) zur Verfügung gestellt haben sollten, gelten abweichend von diesen Nutzungsbedingungen die in der dort genannten Lizenz gewährten Nutzungsrechte.

**Terms of use:**

*Documents in EconStor may be saved and copied for your personal and scholarly purposes.*

*You are not to copy documents for public or commercial purposes, to exhibit the documents publicly, to make them publicly available on the internet, or to distribute or otherwise use the documents in public.*

*If the documents have been made available under an Open Content Licence (especially Creative Commons Licences), you may exercise further usage rights as specified in the indicated licence.*



THE LONDON SCHOOL  
OF ECONOMICS AND  
POLITICAL SCIENCE ■



LSE 'Europe in Question' Discussion Paper Series

# Environmental regulation and productivity growth: main policy challenges

Roberta De Santis, Piero Esposito & Cecilia  
Jona-Lasinio

LEQS Paper No. 158/2020

August 2020







## **Editorial Board**

Dr Bob Hancké  
Dr Vassilis Monastiriotis  
Dr Sonja Avlijas  
Dr Cristóbal Garibay-Petersen  
Dr Pieter Tuytens  
Mr Toon Van Overbeke

All views expressed in this paper are those of the authors and do not necessarily represent the views of the editors or the LSE.

© Roberta De Santis, Piero Esposito and Cecilia Jona-Lasinio



# Environmental regulation and productivity growth: main policy challenges

Roberta De Santis \*, Piero Esposito \*\* & Cecilia Jona-Lasinio \*\*\*

## Abstract

In this paper, we investigate the environmental regulation-productivity nexus for 14 OECD countries over the years 1990-2015 and discuss its main policy challenges. Our findings support the hypothesis that environmental policies generate positive productivity returns through innovation as suggested by Porter and Van Der Linde (1995). We find that environmental policies have a productivity growth-promoting effect. Both market and non-market based policies exert a positive but differentiated impact on labour and multifactor productivity growth. Environmental policy measures generate also potentially mixed redistributive impacts. As for specific policies, green taxes display the largest effect on multifactor productivity although with potentially negative redistributive impact. We also find that environmental regulation exerts indirect positive effect on productivity growth fostering capital accumulation especially in high ICT intensive countries.

**Keywords:** Environmental regulation, productivity, innovation, Porter hypothesis

**JEL Codes:** D24, Q50, Q55, Q47, Q31

---

\* Italian National Statistical Institute and Luiss University

Email: [rdesantis@istat.it](mailto:rdesantis@istat.it)

\*\* University of Cassino and Southern Lazio & Luiss School of European Political Economy

Email: [pesposito@luiss.it](mailto:pesposito@luiss.it)

\*\*\* Italian National Statistical Institute and Luiss University

Email: [cjonalasinio@istat.it](mailto:cjonalasinio@istat.it)



# Table of Contents

1. Introduction.....	1
2. Dataset and descriptive analysis .....	5
3. Econometric model strategy .....	8
4. Regression results and robustness check.....	9
5. Impulse-Response Analysis .....	12
6. Conclusion .....	15
References.....	17



# Environmental regulation and productivity growth: main policy challenges

## 1. Introduction

The environmental regulation-competitiveness nexus is a significant challenge to policymakers. It became central in the international policy debate especially after the global financial crisis when the so-called “green economy” and “green new deal” paradigms emerged.

The investigation of the mechanisms through which environmental policy affects innovation and productivity, as well as the factors strengthening this relationship, is key to implement compelling policies for environmentally sustainable growth. In this context, the role of policies is pivotal as both pollution and innovation generate market failures requiring a well-designed public intervention to avoid that firms pollute too much and innovate too little compared with the social optimum. Further, as environmental policy measures have mixed and complex impacts both on supply and demand sides of the economy the analysis must consider also the effects on the overall distribution of economic resources.

The aim of this paper is to provide a contribution in this respect testing the so-called Porter Hypothesis (PH) for 14 OECD countries over the period 1990-2015 and evaluating its main policy challenges. The conventional perception about environmental policy stringency is that it imposes additional costs on firms, which may reduce their global competitiveness with negative effects on growth and employment. But, at the same time, more tight environmental policies can stimulate



innovations that may over-compensate for the costs of complying with these policies (Porter and Van der Linde 1995). Following this approach, we consider three versions of the PH, namely the weak, strong, and narrow (Jaffe and Palmer 1997)<sup>1</sup>. The weak hypothesis assumes that regulation induces innovation, which in turn stimulates productivity. But this result is not guaranteed as productivity might not improve if the opportunity costs of additional innovation offsets productivity gains.

The strong version suggests that the benefits from higher innovation induced by environmental regulation overcome its costs eventually raising the overall productivity. Finally, the narrow hypothesis indicates that, market-based instruments, such as taxes or tradable permits, are more likely to foster innovation and productivity growth as they leave relatively more freedom to the firm in choosing the best technological solution to minimize compliance costs compared to non-marked based instruments.<sup>2</sup>

Existing empirical studies on the relation between environmental regulations and productivity or competitiveness are rather heterogeneous and developed mainly in the context of international trade. Empirical findings are typically very context-specific and focused on diverse indicators of efficiency and innovation (e.g. multifactor productivity, patent counts or efficiency score). Therefore, the size and the sign of the identified effects are hardly comparable. Only few studies, testing the Porter Hypotheses, documented the impact of more stringent environmental regulation on productivity and environmental innovation adopting a cross-country perspective, but the empirical evidence is inconclusive<sup>3</sup>. Some authors do not find empirical support the Porter hypotheses. Their argument is that despite improving the environment, stricter environmental policies may imply additional costs for

---

<sup>1</sup> See table A1 in the appendix.

<sup>2</sup> The correlation of environmental stringency indicator with green patents is significantly higher for the market-based component, which maybe a sign of the higher effectiveness of market-based instruments to stimulate “green” innovation (as in Johnstone et al., 2010; OECD, 2010). See also Fischer, Parry and Pizer (2003), Jaffe and Palmer (1997).

<sup>3</sup> For a recent survey see Martinez Zarzoso et al. 2019.

pollution abatement, alter investment decisions, and restrict the availability of inputs for the production process as well as the set of available technologies (Ambec et al. 2013, Dechezleprêtre and Sato 2017). So, at least in the short-run, higher compliance costs may negatively affect both international competitiveness and productivity growth.

Other research efforts instead, support the strong Porter hypothesis suggesting that well-designed environmental regulations, along with environmental quality, can improve competitiveness promoting product and process innovation (Ambec and Barla 2002; André et al. 2009). Additionally, Albrizio et al (2017) indicate that a tightening of environmental policy in the OECD countries is associated with a short-term increase in industry level productivity growth only in the most technologically advanced countries.

Empirical evidence supporting the weak Porter hypothesis, shows that well-designed environmental policy generate positive effects on innovation (Carrión-Flores and Innes 2010; Lanoie et al. 2011), but the impact on productivity growth remains indefinite (Brännlund and Lundgren 2009; Cohen and Tubb 2018).

Eventually, other studies find robust support for the strong PH but the results for the weak and narrow PHs remain ambiguous<sup>4</sup>. Martinez Zarzoso et al (2019), use panel data models and quantile regressions to test the “weak” and “strong” hypotheses, for 14 OECD countries over the period 1990-2011. Consistently with the weak PH, their findings indicate that stringent environmental regulations exert a positive effect on R&D expenditure, the number of patent applications and total factor productivity. De Santis and Jona Lasinio (2016), using a panel data approach for a sample of European countries, found that the “narrow” Porter hypothesis cannot be rejected, and that market based environmental measures are the most suitable instrument to stimulate innovation and productivity growth. Finally, this literature rarely

---

<sup>4</sup>See for example Ambec et al. 2013; Franco and Marin 2017 and Yang et al. 2012.

considers the distributive effects of environmental policies that is a substantial matter for policy evaluation (Akshaya, et al 2019).

We contribute to existing literature as follows: first, we adopt a country-level analysis to capture the variation both across policies and across outcomes, as well as possible spillover effects. Compared to industry or firm level studies suffering from the lack of generality a country-level approach is best suited for international policymaking. Second, we disentangle the mediating effect of ICT and non-ICT capital on productivity coherently with the Porter hypothesis. Third, we use a Panel Vector Autoregressive (PVAR) approach to estimate the weak and strong Porter Hypotheses in a single framework. By doing so, we can simultaneously assess the direct and indirect impact of environmental policy on productivity evaluating also the effect of technology adoption through capital accumulation. Finally, to explore more deeply the role of ICT capital we estimate direct and mediated impacts of EPS separately for high and low ICT-intensive countries.

Our findings support the hypothesis that environmental policies in OECD countries had a growth-promoting effect on productivity (strong PH hypothesis validated). Compared to the recent literature finding mixed empirical evidence, this result supports the relevance of aggregate analysis to take into account cross sectional heterogeneity and spillover effects. We find that productivity increases resulting from changes in the environmental regulation pass through a stimulus to capital accumulation and that this effect is concentrated in high ICT intensive countries (weak PH hypothesis validated). We provide evidence that both market and non-marked based policies exert a positive impact on productivity although with potentially heterogeneous redistributive effects (narrow PH hypothesis ambiguous).

The paper is organized as follows: section II describes the data and shows some descriptive evidence and section III illustrates the empirical strategy. Sections IV and V show estimation results and robustness checks while section VI concludes.

## 2. Dataset and descriptive analysis

Our analysis covers 14 OECD economies (Austria – Aut., Canada – Can., Denmark – Dnk., Finland – Fin., France – Fra., Germany – Deu., Greece – Gre., Italy – Ita., Portugal – Por. , Spain – Esp., Sweden – Swn., The Netherlands – Ndl. , Great Britain – Grb. and USA). These countries have been selected as they are among those that have followed the OECD environmental guidelines closely. Notice that the OECD has been very active in the design of effective environmental regulation policies since the beginning of the 1970s<sup>5</sup>.

In this paper we focus on productivity<sup>6</sup> and test environmental adjusted productivity indicators accounting for the use of natural capital (currently including 14 types of fossil fuels and minerals) and for the emission of pollutants as negative by-products (currently including 8 types of greenhouse gases and air pollutants).

We measure environmental adjusted labor productivity as environmental adjusted GDP for pollution abatement in per hour terms. The adjustment approach considers country's technological capabilities (e.g. innovative ways to abate pollution) and changes in economic structure (e.g. less emission-intensive industries)<sup>7</sup>.

---

<sup>5</sup> The OECD strongly supported the achievement of the two United Nations climate treaties. The OECD was also among the main promoters of the Paris Agreement at the COP21 in Paris, which went into force in November of 2016.

<sup>6</sup> Other studies have analyzed the effects of environmental regulation on several different measures of competitiveness (i.e. impacts on business performance, trade flows, FDI, and employment).

<sup>7</sup> Traditional indicators are biased in two ways. First, while income generated with domestic natural assets is fully reflected, no account is taken of the natural resource input (in terms of the resource rents). Increased natural resource use is therefore wrongly interpreted as a rise in productivity. Second, while the costs of investing in pollution abatement are fully captured (in terms of factor inputs including labour and produced capital), no account is taken of the benefits of such investments because pollution is not considered as an output of the production process. Increased abatement efforts therefore make productivity appear falsely low. (See Brandt et al., 2014; 2013).

To investigate the Environmental regulation-productivity nexus we use the Environmental Policy Stringency (EPS) composite index, developed for the OECD countries by Botta and Koźluk (2014) as an indicator of environmental policy<sup>8</sup>.

EPS index is well suited for testing the narrow Porter Hypothesis as it distinguishes between: i) market-based instruments providing market incentives to the reduction or removal of negative environmental externalities and ii) non market based instruments that are mostly regulatory provisions.

**Figure 1.**  
Environmental policy index (2008-2015)

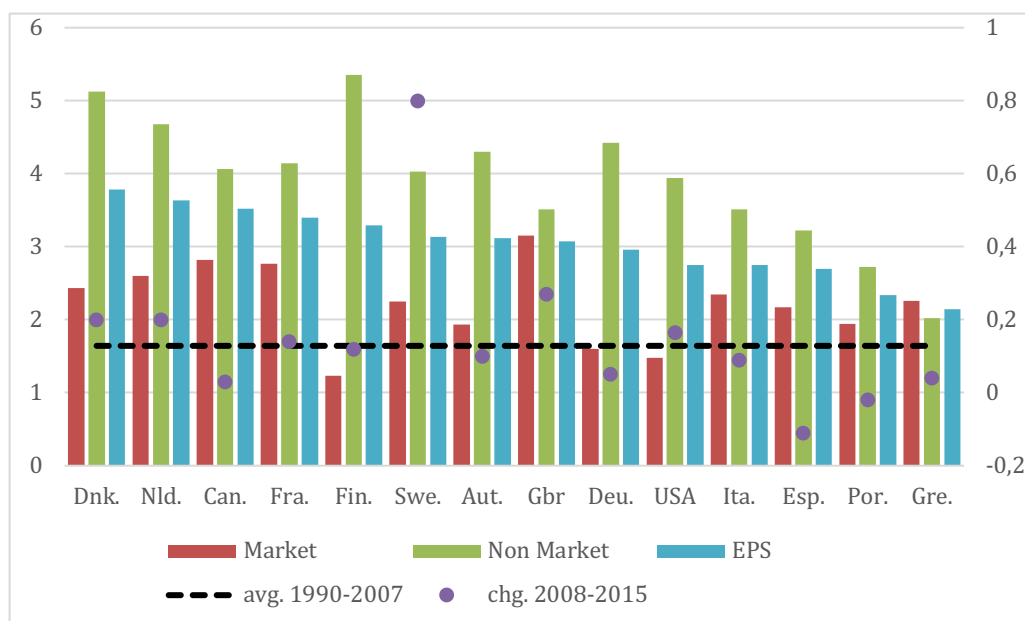

Source: OECD STAT

The dynamics of EPS indicate a tightening trend both at the aggregate level and individually across countries since the beginning of the 90s. At the same time,

<sup>8</sup> The EPS covers 24 OECD countries over the period 1990-2013. The indicator is based on the taxonomy developed by De Serres et al. (2010) and the sub-components are all weighted equally. A market-based subcomponent groups instruments, which assign an explicit price to the externalities (taxes: CO<sub>2</sub>, SO<sub>x</sub>, NO<sub>x</sub>, and diesel fuel; trading schemes: CO<sub>2</sub>, renewable energy certificates, energy efficiency certificates; feed-in-tariffs; and deposit-refund-schemes), while the non-market component clusters command-and-control instruments, such as standards (emission limit values for NO<sub>x</sub>, SO<sub>x</sub>, and PM, limits on Sulphur content in diesel), and technology-support policies, such as government R&D subsidies.

dispersion increased across countries (Figure 1)<sup>9</sup>. Over the past two decades, there has been an extension of the number of market-based policy instruments (i.e. the emission trading system in EU countries in 2005) (see figure A2 in the appendix) as opposed to the non-market-based that remained the same just becoming more stringent compared to the 1990s. Figure 2 shows productivity growth versus market and non-market-based EPS indicators. The relation between EPS and productivity is rather heterogeneous across countries.

**Figure 2.**  
Productivity market vs non-market EPS

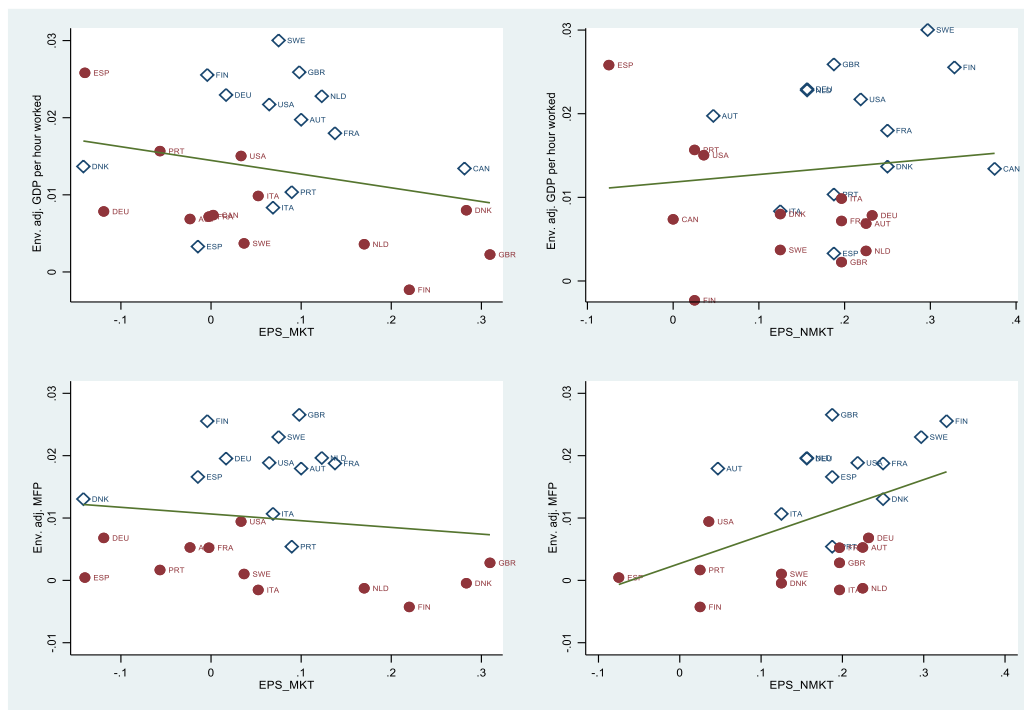

Note: 1990–2007 blue open diamonds; 2008–2015 red closed circles (source: OECD STAT)

The data suggest that Multifactor productivity (MFP) has a stronger and positive correlation with non-marked based EPS as opposed to market-based EPS. This evidence is coherent with the strong Porter hypothesis but does not support its

<sup>9</sup> For the period 2008–2015 three country groups can be distinguished with regard to their aggregate regulatory stance, although incremental differences are relatively small (Figure 1): at the lower end of the spectrum, Greece, Italy, Portugal and USA; in the middle Germany, Great Britain, Austria and Sweden and with the highest regulatory stance Finland, France, Canada, the Netherlands and Denmark.

Narrow version. However, simple bivariate associations neither account for the effect of other variables, nor can be interpreted as causal relations deserving a more formal test of the PHs as discussed in the next sections.

### 3. Econometric model strategy

To test the Porter Hypotheses (PH), we use a Panel VAR (PVAR) approach consisting in a system of equations where each variable is expressed as a dynamic function of lagged values of (endogenous) variables. PVAR, alongside single equation GMM-based dynamic panels, became standard in the estimation of production function coefficients as it controls for reverse causality and simultaneity bias among variables. These endogeneity issues are typical features of production functions where inputs are jointly determined with output. As for the relation between Environmental policy stringency index (EPS) and productivity, endogeneity issues might stem from measurement errors and unobserved components affecting both environmental regulation and productivity growth (Mobius 2018).

The Panel VAR representation as a system of equations is the following:

$$\Delta Prod_{i,t}^k = \beta_0 \Delta Prod_{i,t-1}^k + \beta_1 \Delta kict_{i,t-1} + \beta_2 \Delta knoict_{i,t-1} + \beta_3 \Delta EPSI_{i,t-1}^j + \varepsilon_{i,t}^1 \quad (2a)$$

$$\Delta kict_{i,t} = \beta_4 \Delta Prod_{i,t-1}^k + \beta_5 \Delta kict_{i,t-1} + \beta_6 \Delta knoict_{i,t-1} + \beta_7 \Delta EPSI_{i,t-1}^j + \varepsilon_{i,t}^2 \quad (2b)$$

$$\Delta knoict_{i,t} = \beta_8 \Delta Prod_{i,t-1}^k + \beta_9 \Delta kict_{i,t-1} + \beta_{10} \Delta knoict_{i,t-1} + \beta_{11} \Delta EPSI_{i,t-1}^j + \varepsilon_{i,t}^3 \quad (2c)$$

$$\Delta EPS_{i,t} = \beta_{12} \Delta Prod_{i,t-1}^k + \beta_{13} \Delta kict_{i,t-1} + \beta_{14} \Delta knoict_{i,t-1} + \beta_{15} \Delta EPSI_{i,t-1}^j + \varepsilon_{i,t}^4 \quad (2d)$$

where *Prod* refers to the log of two different (k=2) productivity indicators: environmentally adjusted labour productivity (output per hour worked, *HLPea*); and environmentally adjusted multifactor productivity (*MFPea*);

As for the regressors, *kict* is the log-stock of ICT capital and *knoict* is the log-stock of non-ICT capital both per hour worked in volume terms.  $EPSI_j$  is our environmental legislation indicator, with  $j$  changing from 1 to 8, where:  $j_1$ = total EPS index (EPSI),  $j_2$ = Market Based EPS (EPSIMB);  $j_3$ = Non-Market Based EPS (EPSINMB);  $j_4$ = taxes (TAX);  $j_5$ = Feed in tariffs (FIT);  $j_6$ = Trading Schemes (TS);  $j_7$ = Standards (STD); and  $j_8$ = R&D Subsidies (RDS).

The Panel VAR system of equations (2a)-(2d) is estimated with a GMM approach where lagged variables are instrumented with their first lag, so that equations are exactly identified, thus avoiding the excessive proliferation of instruments typical of GMM-based estimates.<sup>10</sup>

Once the VAR coefficients are estimated, it is possible exploring the dynamic impact of an exogenous shock in EPS (i.e. a shock on  $\varepsilon^4_t$ ) through impulse-response functions (IRF). The identification strategy to guarantee the exogeneity of the shock is based on the Cholesky decomposition whereby a shock in EPS affects capital stocks and productivity with a lag.

## 4. Regression results and robustness check

The results of the Panel VAR estimates for the productivity equations (a) are shown in Table 1 whereas the results for the other equations are shown in Table A3 in the Appendix. Estimated coefficients represent the initial impact of a shock on a specific variable and are similar to IRF when there is no persistence of the shocks.

The estimation results support the validity of the augmented production function estimates: both ICT and non-ICT capital intensity coefficients are positive and significant, coherently with the empirical literature (Spiezia, 2012; Timmer et al. 2010; Corrado et al. 2017).

---

<sup>10</sup> The estimation procedure transforms variables in forward orthogonal deviation to eliminate fixed effects and removes cross sectional dependence (CSD) by using cross sectional averages of all variables.



**Table 1.** Estimation results for equation (2a)

Hourly Labour Productivity								
	<i>EPSI</i>	<i>EPSIMKT</i>	<i>EPSINMB</i>	<i>TAX</i>	<i>FIT</i>	<i>RDS</i>	<i>STD</i>	<i>TS</i>
	<i>HLPea</i>	<i>HLPea</i>	<i>HLPea</i>	<i>HLPea</i>	<i>HLPea</i>	<i>HLPea</i>	<i>HLPea</i>	<i>HLPea</i>
<b><math>\Delta prod_{t-1}</math></b>	0.443***	0.422***	0.434***	0.424***	0.415***	0.423***	0.421***	0.445***
	[0.107]	[0.110]	[0.104]	[0.105]	[0.103]	[0.109]	[0.103]	[0.097]
<b><math>\Delta knoict_{t-1}</math></b>	0.138*	0.142*	0.152**	0.129*	0.157**	0.157**	0.145*	0.136*
	[0.078]	[0.079]	[0.077]	[0.078]	[0.077]	[0.078]	[0.075]	[0.077]
<b><math>\Delta kict_{t-1}</math></b>	0.018*	0.021**	0.019*	0.022**	0.023**	0.020**	0.021**	0.021**
	[0.010]	[0.010]	[0.010]	[0.010]	[0.010]	[0.010]	[0.010]	[0.010]
<b><math>\Delta EPS_{t-1}</math></b>	0.010**	0.004	0.006**	0.009	-0.002	0.002	0.004*	0.004**
	[0.004]	[0.004]	[0.002]	[0.007]	[0.002]	[0.001]	[0.002]	[0.002]
<b>N</b>	242	242	242	242	242	242	242	242
Multifactor Productivity								
	<i>EPS</i>	<i>EPSIMKT</i>	<i>EPSINMB</i>	<i>TAXES</i>	<i>FIT</i>	<i>RDS</i>	<i>STD</i>	<i>TS</i>
	<i>MFPea</i>	<i>MFPea</i>	<i>MFPea</i>	<i>MFPea</i>	<i>MFPea</i>	<i>MFPea</i>	<i>MFPea</i>	<i>MFPea</i>
<b><math>\Delta prod_{t-1}</math></b>	0.662***	0.632***	0.640***	0.638***	0.611***	0.626***	0.620***	0.635***
	[0.093]	[0.091]	[0.094]	[0.088]	[0.092]	[0.094]	[0.092]	[0.090]
<b><math>\Delta knoict_{t-1}</math></b>	0.201**	0.204**	0.221**	0.189**	0.224**	0.226**	0.215**	0.212**
	[0.087]	[0.087]	[0.089]	[0.086]	[0.089]	[0.089]	[0.088]	[0.088]
<b><math>\Delta kict_{t-1}</math></b>	0.028**	0.032**	0.030**	0.032***	0.033**	0.031**	0.032**	0.032**
	[0.010]	[0.010]	[0.010]	[0.010]	[0.011]	[0.010]	[0.010]	[0.011]
<b><math>\Delta EPS_{t-1}</math></b>	0.012**	0.006*	0.006**	0.012*	0	0.002	0.004**	0.004*
	[0.004]	[0.004]	[0.003]	[0.006]	[0.002]	[0.002]	[0.002]	[0.002]
<b>N</b>	242	242	242	242	242	242	242	242

\*significant at 10% level; significant at 5% level; significant at 1% level. EPS=environmental protection stringency; averages; EPSIMB=market based EPS index; EPSINMB=non-market based EPS index; TAX=environmental taxation index; FIT=feed in tariffs index; RDS=R&D subsidies index; STD= environmental standards index; TS= trading schemes index; kict=log-ICT capital per hour worked; knoict=log non-ICT capital per hour worked. Source: own estimates on OECD data.

The EPS coefficient is positive and significant for both productivity measures, coherently with the Strong Porter hypothesis assumptions. The decomposition between market and non-market based policies suggest that the correlation of environmental regulation with labour productivity is driven by non-market based measures (columns 2-3 and 10-11) whereas both indicators provide a significant contribution to explain MFP (i.e. the Narrow PH is not verified).

However, if we distinguish the impact of the different policies within two sub-indicators, we notice that both standards (non-market measure) and trading schemes (market-based measure) display a positive and significant coefficient with similar magnitude for labour productivity. As for multifactor productivity taxes turn significant (alongside standards and trading schemes) too. This suggests that, although VAR coefficients should be interpreted with caution. Again, the Narrow PH cannot be validated at this stage.

A deeper analysis of the contribution of ICT capital is provided in Table 2 showing the Panel VAR estimates of equation (2a) testing the effect of EPS independently for high and low ICT-intensive countries.

We identify two main group of countries according to the average level of ICT capital per hour worked: high ICT intensive countries are those with above average ICT intensity while the remaining countries are classified as low ICT intensive.<sup>11</sup>

---

<sup>11</sup> High ICT capital countries are Austria, Germany, Denmark, Finland, France, the Netherlands and Sweden; low ICT capital countries are Canada, Spain, UK, Greece, Italy, Portugal and USA. The dichotomization of the impact allows to avoid the introduction of non-linear terms (i.e. the interaction between EPS and ICT levels) and maintain the methodology simple and intuitive. Cross validation analyses (available upon request) show that estimated coefficients are mostly insensitive to group switches of countries close to the average value.

**Table 2.** Panel VAR estimates for equation (2a): testing EPS in high and low ICT intensive countries.

	<i>HLP ea</i> <i>ESPI</i>	<i>EPS MKT</i>	<i>EPS NMKT</i>	<i>MFP EA</i> <i>ESPI</i>	<i>EPS MKT</i>	<i>EPS NMKT</i>
<b><math>\Delta prod_{t-1}</math></b>	0.438*** [0.108]	0.422*** [0.108]	0.432*** [0.103]	0.660*** [0.093]	0.632*** [0.091]	0.638*** [0.093]
<b><math>\Delta knoict_{t-1}</math></b>	0.139* [0.077]	0.145* [0.079]	0.152** [0.077]	0.202** [0.086]	0.205** [0.087]	0.221** [0.088]
<b><math>\Delta kict_{t-1}</math></b>	0.018* [0.010]	0.021** [0.010]	0.019* [0.010]	0.028** [0.010]	0.032** [0.010]	0.029** [0.010]
<b><math>\Delta EPS_{hi\ t-1}</math></b>	0.014** [0.006]	0.008 [0.006]	0.006** [0.003]	0.014** [0.007]	0.008 [0.006]	0.007* [0.004]
<b><math>\Delta EPS_{low\ t-1}</math></b>	0.004 [0.004]	-0.001 [0.004]	0.005 [0.004]	0.009** [0.005]	0.004 [0.004]	0.005 [0.005]
<b>N</b>	242	242	242	242	242	242

\*significant at 10% level; significant at 5% level; significant at 1% level. EPS=environmental protection stringency; averages; EPSIMB=market-based EPS index; EPSINMB=non-market-based EPS index; kict=log-ICT capital per hour worked; knoict=log non-ICT capital per hour worked. Source: own estimates on OECD data.

Our findings are coherent with Albrizio et al (2017) and support our assumptions: EPS is positive and significant in high ICT intensive countries whereas, with few exceptions, it is not significant in low ICT intensive countries. Overall, these findings suggest that ICT capital is a strategic factor to exploit productivity gains under stricter environmental regulations. This can be considered an alternative approach to test the weak PH whereby the focus is on technology adoption through capital accumulation rather than on innovation activities such as R&D expenditure and patents.

## 5. Impulse-Response Analysis

Panel VAR coefficients do not properly account for the impact of an exogenous shock on EPS. They represent the impact in t+1 of a shock in t but do not capture the persistence of the shock and the feedback loops from the other variables. To get a reliable measure for the effect of EPS on productivity, we need to estimate impulse response functions, calculated using a Cholesky decomposition where the chain of causality is as follows: EPS → Kict→Knoict→Prod.

IRFs results, showed in the Appendix (Figures A3-A6), support the coherence with the estimated coefficients: a shock to EPS significantly affects productivity in the following period but from  $t+2$  onwards the effect fades to zero; a similar result is found for *knoict* although with lower significance; finally, the impact on *kict* is first positive and then negative but, in both cases, highly insignificant.

To summarize the main results, in Table 3 we show the responses after 10 years to a shock in EPS considering the two productivity measures and testing the impact of EPS on high and low ICT intensive countries. The total impact of a standard deviation increase in EPS on the standard deviation of productivity growth is 0.041 for *MFPea* and 0.018 for *HLPea*<sup>12</sup>.

The effect of EPS on *Knoict* ranges between 0.011 and 0.023 and the impact on productivity varies between 0.653 and 1.412. The relatively higher response to non-ICT capital suggests that a non-negligible portion of the effect of EPS on productivity takes place indirectly through capital accumulation. Turning to the distinction between high and low ICT intensive countries (middle and lower panels of Table 3), we find that the final impact of a shock to EPS on productivity ranges between 0.017 and 0.050 in high ICT intensive countries and between 0 and 0.023 in low ICT intensive countries. High ICT intensive countries are significantly affected by a shock to EPS via *knoict* as opposed to low-ICT intensive countries.

So far, the evidence on the effect of aggregate EPS suggests that productivity growth triggered by environmental regulation pass through a stimulus to (non-ICT) capital accumulation concentrated in high ICT intensive countries. This result is consistent with the Strong Porter hypothesis as the introduction of innovations stemming from the ICT sector requires investments in fiscal capital.

---

<sup>12</sup> Unadjusted measures show smaller impacts (0.013 in both cases).

**Table 3.** Impulse response functions after 10 years: average EPS, by countries ICT intensity

	<i>EPS on Prod</i>	<i>Kict</i>	<i>Knoict</i>	<i>Kict on Prod</i>	<i>Knoict on Prod</i>
<b>HLP ea</b>	<b>0.018</b>	-0.011	<b>0.011</b>	<b>0.059</b>	<b>0.653</b>
<b>MFP ea</b>	<b>0.041</b>	-0.033	<b>0.023</b>	<b>0.142</b>	<b>1.412</b>
<i>High ICT countries</i>					
	<i>EPS on Prod</i>	<i>Kict</i>	<i>Knoict</i>	<i>Kict on Prod</i>	<i>Knoict on Prod</i>
<b>HLP ea</b>	<b>0.017</b>	-0.007	<b>0.012</b>	<b>0.059</b>	<b>0.594</b>
<b>MFP ea</b>	<b>0.050</b>	-0.028	<b>0.030</b>	<b>0.137</b>	<b>1.373</b>
<i>low ICT countries</i>					
	<i>EPS on Prod</i>	<i>Kict</i>	<i>Knoict</i>	<i>Kict on Prod</i>	<i>Knoict on Prod</i>
<b>HLP ea</b>	-0.004	-0.007	0.012	<b>0.059</b>	<b>0.594</b>
<b>MFP ea</b>	<b>0.027</b>	-0.041	0.012	<b>0.137</b>	<b>1.373</b>

Standardized impacts. Bold numbers indicate 10% significant impacts. Source: own estimates on OECD data.

To assess the impact of the different policies, in Table 4 we show the responses of environmentally adjusted productivity measures to shocks in the different market and non-market-based policies. On aggregate, the distinction between market and non-market based seems to be irrelevant as they have comparable impact on both productivity measures. However, when considering separately each of the five subcomponents, green taxes (TAX) has the largest impact: a standard deviation increase in the change of TAX causes a change of 0.041 to MFP and of 0.017 to HLP. In addition, environmental tax policy is the unique driver behind the effect on non-ICT capital accumulation. As for the other components, Standards and Trading Schemes have a smaller although significant impact on MFP (0.015 and 0.011 respectively). The other components do not significantly affect HLP.

**Table 4.** Impulse response functions after 10 years from equation (1): EPS components

	<i>EPS on</i>			<i>EPS MKT on</i>		
	<i>Prod</i>	<i>Kict</i>	<i>Knoict</i>	<i>Prod</i>	<i>Kict</i>	<i>Knoict</i>
<b>HLP ea</b>	<b>0.018</b>	-0.011	<b>0.011</b>	<b>0.007</b>	-0.009	0.003
<b>MFP ea</b>	<b>0.041</b>	-0.033	<b>0.023</b>	<b>0.019</b>	-0.022	0.009
	<i>EPS NMKT on</i>			<i>TAX on</i>		
	<i>Prod</i>	<i>Kict</i>	<i>Knoict</i>	<i>Prod</i>	<i>Kict</i>	<i>Knoict</i>
<b>HLP ea</b>	<b>0.010</b>	-0.003	0.007	<b>0.017</b>	-0.012	0.009
<b>MFP ea</b>	<b>0.018</b>	-0.011	0.011	<b>0.041</b>	-0.034	<b>0.024</b>
	<i>FIT on</i>			<i>RDS on</i>		
	<i>Prod</i>	<i>Kict</i>	<i>Knoict</i>	<i>Prod</i>	<i>Kict</i>	<i>Knoict</i>
<b>HLP ea</b>	-0.003	0.005	0	0.003	-0.002	0.002
<b>MFP ea</b>	0.000	0.000	0	0.006	-0.004	0.004
	<i>STD on</i>			<i>TS on</i>		
	<i>Prod</i>	<i>Kict</i>	<i>Knoict</i>	<i>Prod</i>	<i>Kict</i>	<i>Knoict</i>
<b>HLP ea</b>	0.008	-0.002	0.007	0.007	-0.013	0.002
<b>MFP ea</b>	<b>0.015</b>	-0.007	0.009	<b>0.011</b>	-0.014	0.005

Standardized impacts. Bold numbers indicate 10% significant impacts. Source: own estimates on OECD data.

The relatively higher impact of green taxes on productivity corroborates the prescriptions of the Narrow Porter hypothesis and the findings in De Santis and Lasinio (2016). Notice that, despite green taxes generate several advantages (environmental effectiveness, economic efficiency, the ability to raise public revenue and transparency) they have also some shortcomings.

As the effective incidence of green taxes is likely to differ from their formal incidence (e.g. because of the pass-through to wages and prices) addressing their distributional concerns can be a significant challenge for policymakers.

## 6. Conclusion

In this paper we assessed the role of environmental policy stringency on environmentally adjusted productivity measures for a sample of 14 OECD countries between 1990 and 2015. We empirically tested the Strong and Narrow versions of the Porter hypothesis. Our findings suggest that the need to speed up the transition towards a “green economy” for environmental protection purposes is an opportunity to improve productivity.

Our results indicate that the Strong Porter hypothesis cannot be rejected. Environmental policies have a productivity growth-promoting effect and both

## *Environmental regulation and productivity growth: main policy challenges*

market and non-marked based policy measures positively affect labour and multifactor productivity growth.

Moreover, although the Narrow Porter hypothesis cannot be fully validated, among the subcomponents of environmental policy, green taxes has the largest effect on multifactor productivity. However, the use of green taxes for preserving the environment without damaging productivity requires complementary redistributive policies.

We also find that productivity increases resulting from changes in environmental policy pass through a stimulus to capital accumulation especially in high ICT intensive countries. This is coherent with the Strong PH assumptions that investment in high tech capital allows countries to better exploit the innovations opportunities provided by different stringency level environmental policies.

## References

- Albrizio S., Koźluk T. & Zipperer, V. (2014). 'Empirical Evidence on the Effects of Environmental Policy Stringency on Productivity Growth', *OECD Economics Department Working Papers 1179*, OECD Publishing.
- Ambec S, Cohen M., Elgie S. & Lanoie P. (2011). The Porter Hypothesis at 20: Can Environmental policy Enhance Innovation and Competitiveness? *RF Discussion Paper 11-01*, Washington DC: Resources for the Future
- Ambec S. and Barla P. (2002). 'A theoretical foundation of the Porter Hypothesis' *Economic letters*, 75, 355-360.
- André FJ., González P. & Porteiro N. (2009). 'Strategic quality competition and the Porter hypothesis', *Journal of Environmental Economics Management*, 57(2), 182–194.
- Akshaya J., Matthews, P. & Muller N. (2019). 'Does Environmental Policy Affect Income Inequality? Evidence from the Clean Air Act' *AEA Papers and Proceedings*, 109, 271-76.
- Botta, E. & Koźluk, T. (2014). 'Measuring Environmental Policy Stringency in OECD Countries – A Composite Index Approach', *OECD Economics Department Working Paper, No. 1177*, OECD Publishing.
- Brandt N., Schreyer, P. & Zipperer, V. (2014). 'Productivity Measurement with Natural Capital and Bad Outputs', *OECD Economics Department Working Papers, No. 1154*, OECD Publishing.
- Brännlund, R. & Lundgren, T. (2009). 'Environmental Policy Without Costs? A Review of the Porter Hypothesis', *International Review of Environmental and Resource Economics*, 3 (2), 75-117.
- Carrion-Flores, C. & Innes, R. (2010). 'Environmental innovation and environmental performance Journal of Environmental', *Economy and Management*, 59, 27–4.
- Cohen, M. & Tubb, A. (2018). 'The impact of environmental policy on firm and country competitiveness: a meta-analysis of the Porter hypothesis' *Journal of Association of Environmental Resources Economists*, 5(2), 371–399.
- Corrado C., Haskel, J. & Jona-Lasinio, C. (2017). 'Knowledge Spillovers, ICT and Productivity Growth', *Oxford Bulletin of Economics and Statistics*, Department of Economics, 79(4), 592-618.
- Dechezleprêtre, A. & Sato, M. (2017). 'The impacts of environmental policies on competitiveness', *Review of Environmental Economics and Policy*, 11(2), 183–206.



- De Santis, R. & Jona Lasinio, C. (2016). 'Environmental Policies, Innovation and Productivity in the EU', *The Global Economy Journal*, 16(4), 615-635.
- de Serres, A., Murin, F. & Nicoletti, G. (2010). 'A Framework for Assessing Green Growth Policies', *OECD Economics Department Working Papers*, No. 774, OECD Publishing.
- Fischer, C., Parry I. & Pizer, W. (2003). 'Instrument Choice for Environmental Protection When Technological Innovation Is Endogenous', *Journal of Environmental Economics and Management*, 45, 523-45.
- Franco C. & Marin, G (2017). 'The effect of within-sector, upstream and downstream environmental taxes on innovation and productivity', *Environmental Resources Economics* 66(2), 261-291.
- Greaker, M. (2006). 'Spillovers in the development of new pollution abatement technology: a new look at the Porter-hypothesis', *Journal of Environmental Economics and Management*, 52(1), 411-420.
- Jaffe, A. & Palmer, K. (1997). 'Environmental policy and Innovation: A Panel Data Study', *The Review of Economics and Statistics*, 79(4), 610-619.
- Kapetanios, G., Pesaran, M. & Yamagata, T. (2011). 'Panels with non-stationary multifactor error structures' *Journal of Economics*, 160(2), 326-348.
- Koluk, T. and Zipperer, V. (2014). 'Environmental Policies and Productivity Growth: A Critical Review of Empirical Findings', *OECD Journal: Economic Studies*, 1.
- Lanoie P., Patry, M. & Lajeunesse, R. (2008). 'Environmental policy and productivity: testing the Porter Hypothesis', *J. Prod. Anal.*, 30, 121-128.
- Lanoie P., Laurent-Lucchetti J., Johnstone N. & Ambec, S. (2011). 'Environmental policy, innovation and performance: new insights on the Porter Hypothesis', *Journal of Economics Management Strategy*, 20, 803-842.
- Managi, S., Opaluch, J.J., Jin, D. & Grigalunas, T. (2005). 'Environmental policies and technological change in the offshore oil and gas industry', *Land Economics*, 81, 303-319.
- Martinez, Zarzoso, I. (2019). 'Does environmental policy stringency foster innovation and productivity in OECD countries?', *Energy Policy*, 134.
- Mohor, R. (2002). 'Technical Change, External Economies, and the Porter Hypothesis', *Journal of Environmental Economics and Management*, 43, 158-168.
- Porter, M. (1991). 'America's green strategy', *Scientifics America*, 264, 168.

- Porter, M., & Van Der Linde, C. (1995). 'Toward a New Conception of the Environment- Competitiveness Relationship', *Journal of Economic Perspectives*, 9(4), 97–118.
- Solt, F. (2016). 'The Standardized World Income Inequality Database', *Social Science Quarterly*, 97(5), 1267-1281.
- Spiezia, V. (2012). 'ICT investments and productivity: Measuring the contribution of ICTS to growth', *OECD Journal of Economic Studies*, 1.
- Timmer, M., Inklaar, R., O'Mahony, M. & van Ark, B. (2010). 'Economic Growth in Europe: A Comparative Industry Perspective', Cambridge University Press.
- Yang, C., Tseng, Y. & Chen, C. (2012). 'Environmental policies, induced R&D, and productivity: evidence from Taiwan's manufacturing industries', *Resources Energy Economics*, 34(4), 514–532.

## Appendix

**Figure A1.** The Porter hypotheses causality chains

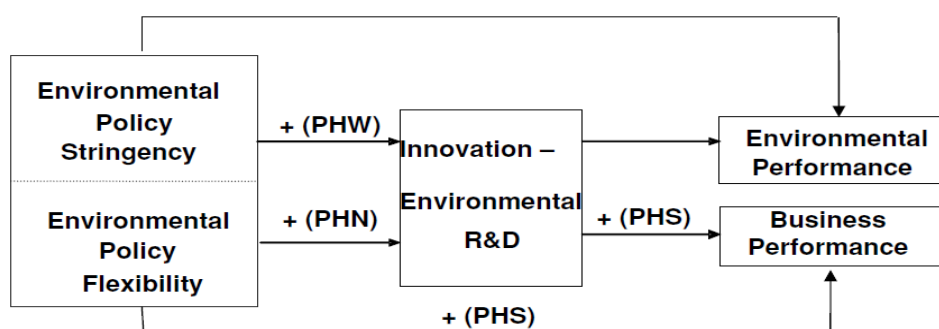

Source: Lanoie et al (2011)

**Table A1. Data description**

Variable	Description	Source
<b>HLP ea</b>	Environmentally adjusted hourly labour productivity growth: growth of environmentally adjusted GDP minus growth of total hours worked	OECD
<b>HLP</b>	Hourly labour productivity growth: growth of GDP per hour worked	OECD
<b>kict</b>	ICT capital stock per hour worked (in logs)	OECD, EUKLEMS
<b>knoict</b>	Non-ICT capital stock per hour worked (in logs)	OECD, EUKLEMS
<b>EPSI</b>	Environmental Policy Stringency Index	OECD
<b>EPSIMB</b>	Market-based Environmental Policy Stringency index	OECD
<b>EPSINMB</b>	Non Market-based Environmental Policy Stringency index	OECD
<b>TAX</b>	Environmental Policy Stringency Index: Taxation policy	OECD
<b>FIT</b>	Environmental Policy Stringency Index: Feed in tariffs policy	OECD
<b>RDS</b>	Environmental Policy Stringency Index: R&D subsidies policy	OECD
<b>STD</b>	Environmental Policy Stringency Index: Standards policy	OECD
<b>TS</b>	Environmental Policy Stringency Index: Trading Schemes policy	OECD

**Table A2.** Descriptive statistics

	mean	s.d.	min	Max
$\Delta hlp\_ea$	0.016	0.015	-0.054	0.060
$\Delta hlp$	0.013	0.016	-0.056	0.061
$\Delta kict$	0.041	0.109	-0.886	0.242
$\Delta knoict$	0.039	0.022	-0.033	0.145
$\Delta EPS$	0.102	0.295	-0.633	1.113
$\Delta EPS\_MKT$	0.070	0.377	-1.167	2.083
$\Delta EPS\_NMKT$	0.133	0.453	-1	1.875
$\Delta TAXES$	0.014	0.237	-0.5	1.5
$\Delta RD\_SUB$	0.063	0.716	-2	3
$\Delta STD$	0.203	0.549	0	3.5
$\Delta FIT$	0.111	0.908	-4	5.5
$\Delta TRADESCH$	0.086	0.749	-2	2.6

**Figure A2.** EPS sub-components

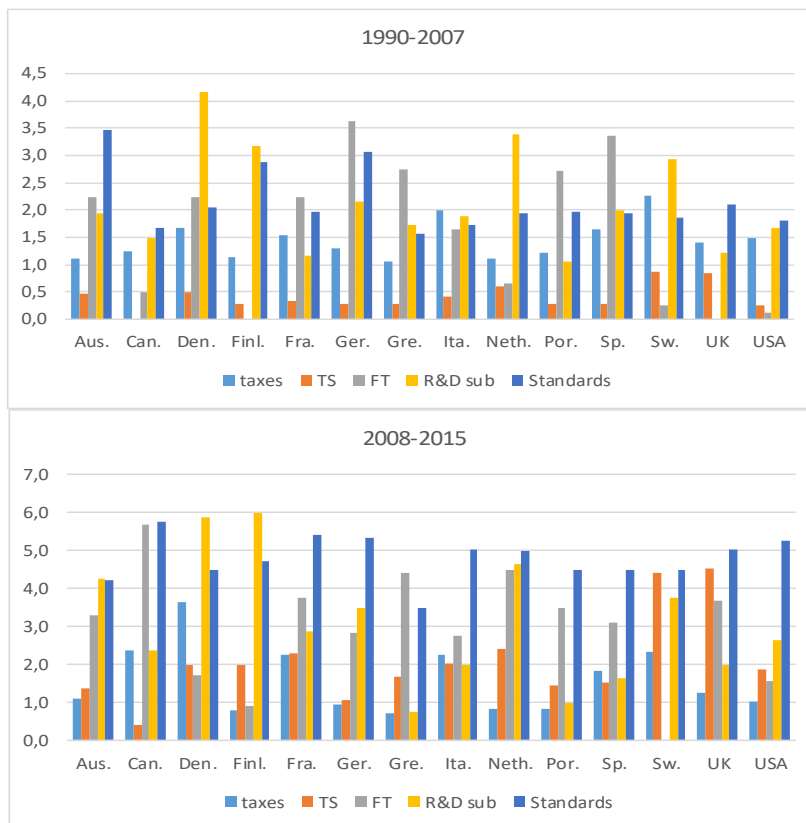

Source: OECD.Stat

**Figure A3.** Response to a shock in EPS: HLP EA

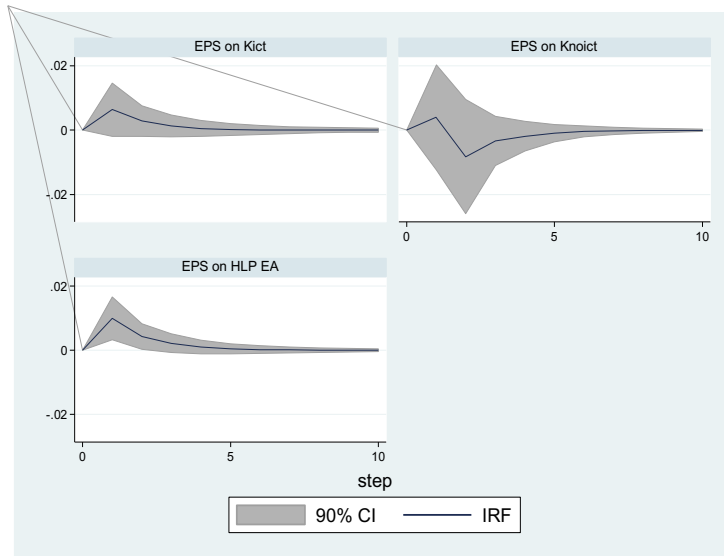

Source: author elaboration on OECDstat data

**Figure A4.** Response to a shock in EPS: MFP EA

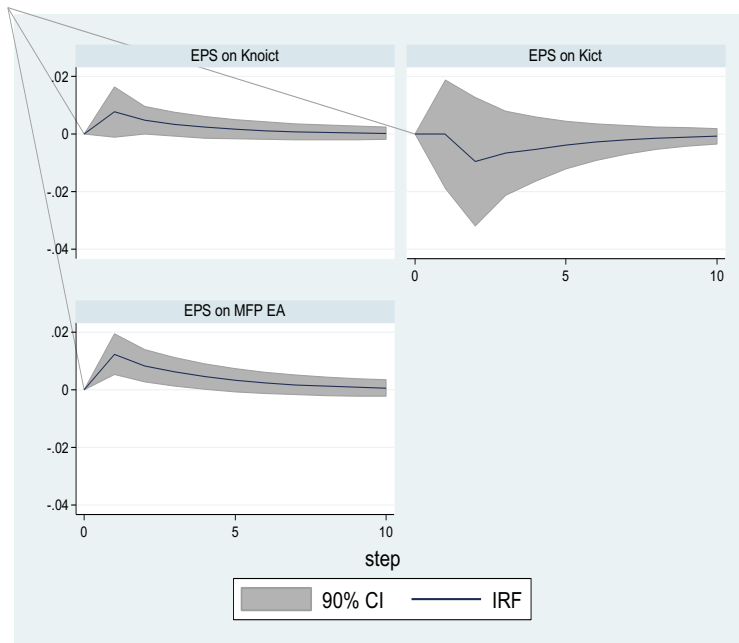

Source: author elaboration on OECDstat data

**Figure A5. Response to a shock in EPS: HLP**

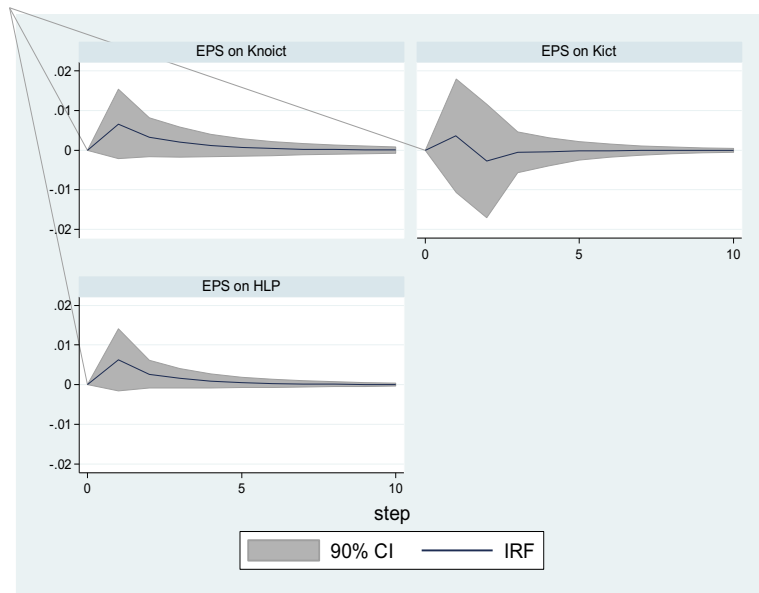

Source: author elaboration on OECDstat data

**Figure A6. Response to a shock in EPS: MFP**

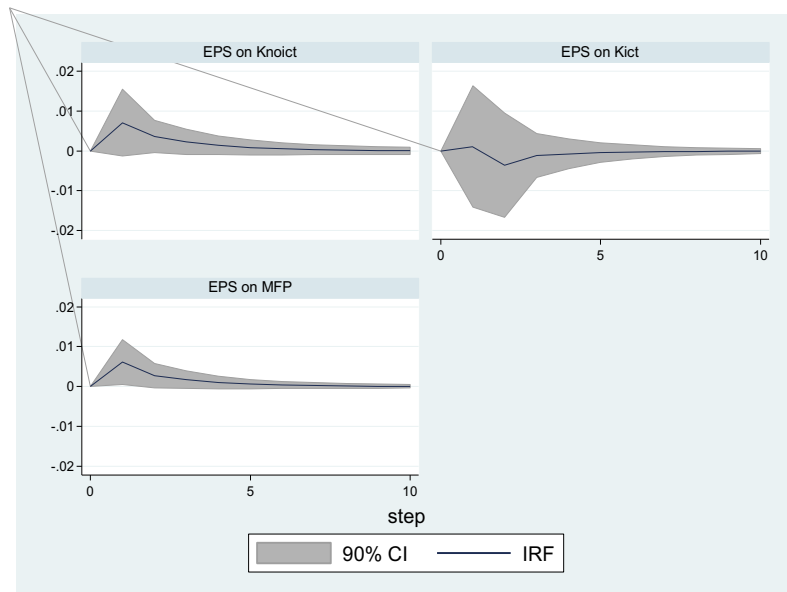

Source: author elaboration on OECDstat data

**Table A3.** Estimation results for equations (2b)-(2d).

Eq. (2b)	HLP			MFP		
	EPSI	EPSIMKT	EPSINMB	EPSI	EPSIMKT	EPSINMB
$\Delta prod_{t-1}$	0.028 [0.136]	0.013 [0.138]	0.025 [0.134]	0.185 [0.114]	0.162 [0.115]	0.175 [0.116]
$\Delta knoict_{t-1}$	0.498*** [0.130]	0.503*** [0.132]	0.507*** [0.130]	0.443*** [0.115]	0.449*** [0.116]	0.455*** [0.115]
$\Delta kict_{t-1}$	0.035** [0.011]	0.037** [0.011]	0.035** [0.011]	0.033** [0.011]	0.036*** [0.011]	0.034** [0.011]
$\Delta EPS_{t-1}$	0.006 [0.005]	0.002 [0.005]	0.004 [0.003]	0.008 [0.005]	0.003 [0.005]	0.005* [0.003]
Eq. (2c)	HLP			MFP		
	EPSI	EPSIMKT	EPSINMB	EPSI	EPSIMKT	EPSINMB
$\Delta prod_{t-1}$	-1.282 [1.028]	-1.298 [1.026]	-1.276 [1.024]	-1.196 [0.936]	-1.212 [0.930]	-1.178 [0.924]
$\Delta knoict_{t-1}$	0.750** [0.334]	0.762** [0.337]	0.755** [0.330]	0.675** [0.290]	0.691** [0.294]	0.673** [0.288]
$\Delta kict_{t-1}$	0.016 [0.044]	0.018 [0.044]	0.015 [0.044]	0.002 [0.049]	0.003 [0.049]	0 [0.049]
$\Delta EPS_{t-1}$	0.004 [0.010]	-0.002 [0.008]	0.005 [0.006]	0 [0.011]	-0.005 [0.009]	0.004 [0.006]
Eq. (2d)	HLP			MFP		
	EPSI	EPSIMKT	EPSINMB	EPSI	EPSIMKT	EPSINMB
$\Delta prod_{t-1}$	-3.565** [1.350]	-2.091 [1.737]	-5.148** [2.220]	-2.501* [1.482]	-0.879 [1.986]	-4.216* [2.272]
$\Delta knoict_{t-1}$	3.724** [1.467]	5.454** [2.030]	1.693 [2.138]	3.222** [1.317]	4.949** [1.822]	1.173 [1.940]
$\Delta kict_{t-1}$	0.394** [0.138]	0.726** [0.234]	0.098 [0.225]	0.344** [0.133]	0.690** [0.230]	0.032 [0.225]
$\Delta EPS_{t-1}$	-0.113 [0.073]	-0.003 [0.066]	-0.213** [0.082]	-0.118 [0.077]	-0.001 [0.068]	-0.216** [0.084]
<b>N</b>	242	242	242	242	242	242

\*significant at 10% level; significant at 5% level; significant at 1% level. EPS=environmental protection stringency; averages; EPSIMB=market based EPS index; EPSINMB=non-market based EPS index; kict=log-ICT capital per hour worked; knoict=log non-ICT capital per hour worked.

## Recent LEQS papers

- Tesche**, Tobias. 'The European Union's response to the coronavirus emergency: an early assessment' LEQS Paper, No. 157 June 2020
- Delanty**, Gerard. 'Six political philosophies in search of a virus: Critical perspectives on the coronavirus pandemic' LEQS Paper, No. 156 May 2020
- Karadima**, Maria and **Louri**, Helen. 'Bank competition and credit risk in the Euro area, 2005-2017: Is there evidence of convergence?' LEQS Paper, No. 155, April 2020
- Campos**, Nauro and **Macchiarelli**, Corrado. 'Brexit and the Euro' LEQS Paper, No. 154, March 2020
- Corazza**, Arthur. 'Power, interest and insecurity: A comparative analysis of workplace dualization and inclusion in Europe' LEQS Paper No. 153, February 2020.
- Bronk**, Richard and **Jacoby**, Wade. 'The epistemics of populism and the politics of uncertainty' LEQS Paper No. 152, February 2020
- Sojka**, Aleksandra, **Díaz-Lanchas**, Jorge and **Steinberg**, Frederico. 'The politicisation of transatlantic trade in Europe: Explaining inconsistent preferences regarding free trade and TTIP' LEQS Paper No. 151, January 2020.
- Laliotis**, Ioannis, **Moscelli**, Guiseppe, and **Monastiriotis**, Vassilis. 'Summertime and the drivin' is easy? Daylight Saving Time and vehicle accidents' LEQS Paper No. 150, December 2019
- Crescenzi**, Riccardo, **Di Cotaldo**, Marco and **Giuà**, Mara. 'It's not about the money! EU funds, local opportunities, and the Brexit vote' LEQS Paper No. 149, November 2019.
- D'Elia**, Enrico & **De Santis**, Roberta. 'Growth divergence and income inequality in OECD countries: the role of trade and financial openness' LEQS Paper No. 148, October 2019
- Monnet**, Eric, **Pagliari**, Stefano, & **Vallée**, Shahin. 'Beyond financial repression and regulatory capture: the recomposition of European financial ecosystems after the crisis' LEQS Paper No. 147, September 2019
- Craik**, P. B. 'The Weaponization of Postmodernism: Russia's New War with Europe' LEQS Paper No. 146, July 2019
- Hodson**, Dermot. 'The New Intergovernmentalism and the Euro Crisis: A Painful Case?' LEQS Paper No. 145, June 2019
- Codogno**, Lorenzo & **van den Noord**, Paul. 'The rationale for a safe asset and fiscal capacity for the Eurozone' LEQS Paper No. 144, May 2019
- Simoni**, Marco. 'Institutional Roots of Economic Decline: Lessons from Italy' LEQS Paper No. 143, April 2019
- De Santis**, Roberta. 'On Productivity Measurement and Interpretation: Some Insights on Italy in the European Context' LEQS Paper No. 142, March 2019





THE LONDON SCHOOL  
OF ECONOMICS AND  
POLITICAL SCIENCE ■



## LEQS

European Institute  
London School of Economics  
Houghton Street  
WC2A 2AE London  
Email: [euroinst.LEQS@lse.ac.uk](mailto:euroinst.LEQS@lse.ac.uk)



<http://www.lse.ac.uk/european-institute/research/leqs-discussion-paper-series>