

Kuramoto, Juana

Working Paper

Innovation, Research and Development, and Productivity: Case Studies from Peru

IDB Working Paper Series, No. IDB-WP-249

Provided in Cooperation with:

Inter-American Development Bank (IDB), Washington, DC

Suggested Citation: Kuramoto, Juana (2011) : Innovation, Research and Development, and Productivity: Case Studies from Peru, IDB Working Paper Series, No. IDB-WP-249, Inter-American Development Bank (IDB), Washington, DC

This Version is available at:

<https://hdl.handle.net/10419/89083>

Standard-Nutzungsbedingungen:

Die Dokumente auf EconStor dürfen zu eigenen wissenschaftlichen Zwecken und zum Privatgebrauch gespeichert und kopiert werden.

Sie dürfen die Dokumente nicht für öffentliche oder kommerzielle Zwecke vervielfältigen, öffentlich ausstellen, öffentlich zugänglich machen, vertreiben oder anderweitig nutzen.

Sofern die Verfasser die Dokumente unter Open-Content-Lizenzen (insbesondere CC-Lizenzen) zur Verfügung gestellt haben sollten, gelten abweichend von diesen Nutzungsbedingungen die in der dort genannten Lizenz gewährten Nutzungsrechte.

Terms of use:

Documents in EconStor may be saved and copied for your personal and scholarly purposes.

You are not to copy documents for public or commercial purposes, to exhibit the documents publicly, to make them publicly available on the internet, or to distribute or otherwise use the documents in public.

If the documents have been made available under an Open Content Licence (especially Creative Commons Licences), you may exercise further usage rights as specified in the indicated licence.



IDB WORKING PAPER SERIES No. IDB-WP-249

Innovation, R&D and Productivity:

Case Studies from Peru

Juana R. Kuramoto

June 2011

Inter-American Development Bank
Department of Research and Chief Economist

Innovation, R&D and Productivity:

Case Studies from Peru

Juana R. Kuramoto

Grupo de Análisis para el Desarrollo (GRADE)



Inter-American Development Bank

2011

Cataloging-in-Publication data provided by the
Inter-American Development Bank
Felipe Herrera Library

Kuramoto, Juana R.

Innovation, R&D and productivity: case studies from Peru / Juana R. Kuramoto.

p. cm. (IDB working paper series ; 249)

Includes bibliographical references.

1. Industrial productivity—Peru. 2. Technological innovations—Peru. 3. Industrial productivity—Effect of technological innovations on—Peru. 4. Research, Industrial—Peru. I. Inter-American Development Bank. Research Dept. II. Title. III. Series.

<http://www.iadb.org>

Documents published in the IDB working paper series are of the highest academic and editorial quality. All have been peer reviewed by recognized experts in their field and professionally edited. The information and opinions presented in these publications are entirely those of the author(s), and no endorsement by the Inter-American Development Bank, its Board of Executive Directors, or the countries they represent is expressed or implied.

This paper may be freely reproduced.

Abstract*

This paper analyzes quantitative findings on the innovative behavior of firms in the production chains of pisco and shoe manufacture in Peru, which are served by the network of Technological Innovation Centers (CITEs), the most important technology policy instrument available in Peru. These two chains, in low and medium-technology industries, are representative of Peru's manufacturing sector. Of particular interest is the role of technical standards as a means of technological diffusion, which is stressed in the work of the CITEs. For the pisco chain, that role involves the definition of the product itself, for which Peru is seeking a World Intellectual Property Organization (WIPO) denomination. In the shoe chain, the technical standard should act as a coordination mechanism that will help increase efficiency throughout the chain, which at present is often fractured.

JEL Classifications: O14, O25, O33

Keywords: Productivity, Innovation, Technical standards, Peru

* This paper was undertaken as part of the Latin American and Caribbean Research Network Project "Innovation, R&D Investment and Productivity in Latin American and Caribbean Firms."

1. Introduction

The purpose of the case studies is to analyze quantitative findings on the innovative behavior of firms in the production chains of pisco and shoe fabrication in Peru. We selected these two production chains because they are served by the network of Technological Innovation Centers (CITEs), the most important technology policy instrument available in Peru. In addition, these two chains are examples of low and medium-technology industries, which are the industries that characterize the manufacturing sector in Peru and that may induce certain technological behavior. Finally, the role of technical standards as a means of technological diffusion is stressed in the work of the CITEs and plays a different role in each of the chains. For the pisco chain, it represents the definition of the product itself, since a standard supports Peru's aim of obtaining a World Intellectual Property Organization (WIPO) denomination of origin for this product. In the shoe chain, the technical standard should act as a coordination mechanism that will help increase efficiency in the whole chain, which at present is often fractured.

2. Innovation in Low and Medium-Technology Industries

Debates on technological change have generally been focused on the performance of high-tech (HT) industries that are characterized by rapid technological change based on important R&D efforts and in which product innovation plays a crucial role. However, the reality is that these high-tech industries are not the most common in the industry mix of the majority of countries. In fact, low and medium technology (LMT) industries represent more than 90 percent of output in the European Union, the United States and Japan (Robertson, Smith and von Tunzelmann, 2009). In developing countries, the importance of these industries is even greater since they become the path to industrialization.

Innovation in LMT can be studied from a variety of angles. On the one hand, there is a close relationship between HT and LMT industries, the latter corresponding to Pavitt's (1984) class of "supplier-dominated sectors" that rely more on embodied technology than formal R&D to improve productivity (Robertson, Smith and von Tunzelmann, 2009; Heidenreich, 2009). On the other, adaptation plays a crucial role in LMT industries since they operate with different vintages of capital, which requires substantial adaptation and technological capabilities.

The two production chains selected for this study can be classified as LMT industries. Their innovation behaviors are based on process, organizational and marketing innovations

rather than product innovations, by weak internal innovation capabilities and strong dependence on the external provision of machines, equipment and software. Also, in these industries suppliers are the most important sources for information and knowledge and achieving production efficiency is more important than increasing the range of goods and services or having access to new markets (Heidenreich, 2009).

Innovation in LMT industries is based on transforming the general stock of knowledge into economically useful knowledge rather than based on the result of the latest scientific or technological knowledge (Santamaría, Nieto and Barge-Gil, 2009). In that sense, other innovation activities become more important than formal R&D, such as design, the use of advanced manufacturing technology, intensive training and external sources of innovation (Santamaría, Nieto and Barge-Gil, 2009).

The evidence of innovation in LMT industries comes mainly from industrialized countries. In developing countries, firms in LMT industries might have even weaker technological capabilities and devote even lesser resources to formal R&D. These firms might also have difficulties in identifying the useful knowledge they can apply in their production processes. In that sense, innovation policy instruments would aim to provide basic technological information that helps improve the quality of products and services or reach higher efficiency levels. One such instrument is technical norms that promote standardization. In general, standards have positive impacts on technical change, particularly the following: fostering compatibility among system elements; reducing information asymmetries; increasing the probability of market acceptance of new products; promoting cost reduction by facilitating scale production; and providing information on the status of a technology. However, they also have negative effects such as impeding the transition from old to new technologies, locking in technologies and reducing product variety (Blind, 2004).

3. Innovation in the Pisco Value Chain

Pisco is a spirit that has been produced in Peru since the late sixteenth century. In addition to being consumed domestically, it was exported to other countries from the port of Pisco, after which the spirit was named.

After three centuries of domestic consumption, pisco lagged behind the consumption of other kinds of alcoholic beverages like beer, whiskey and rum. At the same time, the crisis in

Peruvian agriculture¹ affected the country's vineyards, and some varieties used for pisco production almost disappeared. In the last decade, this industry has experienced a revival due to the recovery of coastal agriculture and of a government campaign that tries to differentiate Peruvian pisco from other spirits made from grapes. In fact, the Peruvian government is trying to register the pisco denomination of origin with the World Intellectual Property Organization (WIPO).

The results of these efforts have motivated Peruvian producers to increase pisco production and exports and make sustained improvement in product quality. This campaign is also increasing domestic consumption.

Besides private investment, this success story has at its basis the role played by the Technical Innovation Center (CITEvid), a government sponsored organization that provides technical assistance and infrastructure for wine and pisco producers.

3.1 Overview

Grapes can be grown in several regions of Peru, but wine and pisco producers have been concentrated in Ica and other southern departments since the beginning of Spanish colonization. These locations enjoy the dry and sunny weather that is particularly favorable for grape production. Over the centuries, producers located in the valleys of the departments of Lima, Ica, Arequipa, Moquegua and Tacna have accumulated the knowledge to produce wine and pisco in both artisanal and industrial processes.

The Pisco denomination of origin refers to the spirit obtained by the distillation of must from four varieties of non-aromatic grapes (quebranta, black grape, molar and uvina) and four aromatic varieties: Italia, muscatel, torontel and albilla. Most pisco, however, is made from quebranta.

At present, the Pisco denomination of origin is recognized by the countries of the Andean Community, El Salvador, Costa Rica, Guatemala, Nicaragua, Panama, Dominican Republic and Cuba. The recent free trade agreement signed with the United States also recognizes the denomination, and only spirits produced in Peru can be sold as Peruvian Pisco in the United States.

¹ The Agrarian Reform implemented in the late 1960s had a terrible impact. Most farms were given to peasants and workers who did not have technical expertise. In the case of grape farms, various grape varieties almost disappeared. The recovery of the grape and associated industries was possible after huge investments were made.

Peruvian Pisco production has more than tripled from 1.5 million liters in 2002 to 4.9 million liters in 2007 (see Figure 1), with output growth of 20 percent expected in 2008; these increases have resulted from investments in new technologies of cultivation and irrigation. Valleys in the department of Ica account for almost 60 percent of production.

Figure 1. Pisco Production 2002-2007

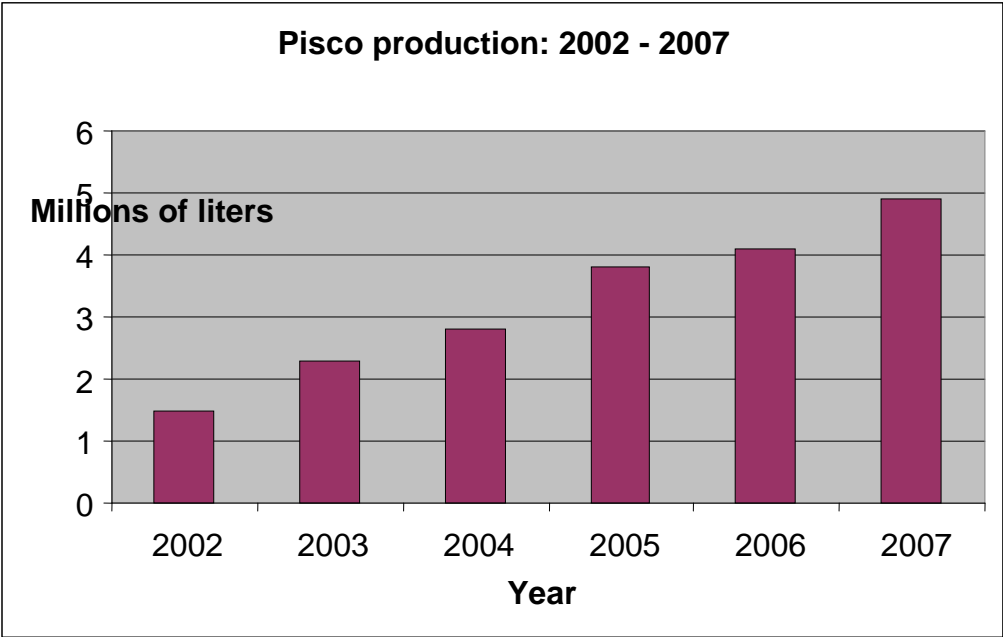

Source: CONAPISCO (2008).

Moreover, pisco exports have increased more than ten-fold, from US\$ 83,643 in 2002 to US\$ 1,003,613 in 2007 (see Figure 2). The exported volume has also increased, but to a lesser extent, indicating that the pisco *exported* is of high quality and is quoted at higher prices. Thus, 19,364 liters were exported in 2002 and 161,761 liters in 2007. Exports are sent to the United States, which accounts for 41 percent of all exports, followed by Chile (18 percent) and Spain (8 percent).

Figure 2. Exports of Pisco 2002-2007

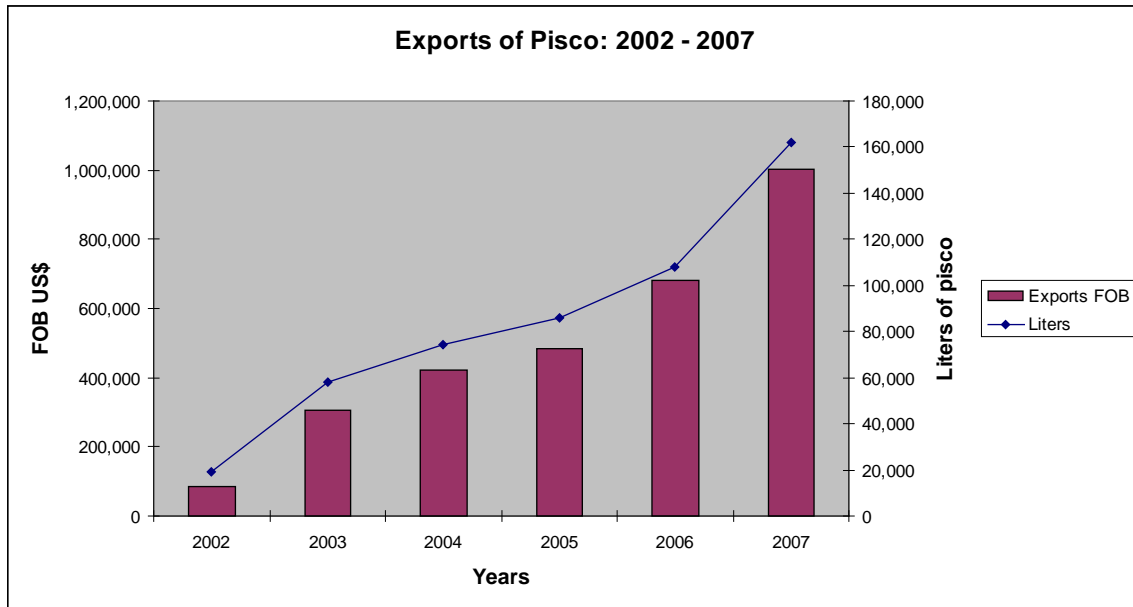

Source: CONAPISCO (2008).

The main pisco exporters in 2007 were all large pisco producers and winemakers: Bodegas Viñas de Oro (21 percent), Viña Tacama S.A. (11 percent), Puro Perú S.A.C. (9 percent), Santiago Queirolo S.A.C. (8 percent) and Viñas Ocucaje (8 percent). According to Ica’s Pisco Producers Association (APROPICA), production and exports by small pisco makers is expected to increase in the years ahead. For that purpose, the Development Funding Corporation (COFIDE) has designed a financial instrument to support small pisco makers with loans ranging between US\$ 30,000 and US\$ 50,000.

3.2 Main Actors

A variety of actors participate in the pisco value chain. In the area of production, there are three kinds of producers: i) large integrated pisco and wine producers, ii) specialized artisanal producers and iii) artisanal/informal producers. The first group consists of large industrial producers such as Viña Tacama, Viña Ocucaje and Santiago Queirolo, among others. These vertically integrated firms, which own their vineyards, are primarily wine producers for whom pisco represents a secondary line of production. However, their action in the pisco chain is very valuable since they have political clout and have promoted joint action in this production and value chain. These firms’ prestige has additionally given them advantages in the external market for pisco, since colonies of Peruvian expatriates demand their products.

The specialized artisanal producers, such as Agroindustrias Santo Tomás (Pisco Montesierpe) and Omnibeverages (Pisco Gran Cruz), have their own vineyards but complement their production with grapes bought from third parties, usually local producers. The small and medium firms in this group additionally establish long-term contracts with grape suppliers, facilitating access to working capital and providing assistance in agricultural practices.² Firms in this group produce for the domestic market but are aggressively targeting the external market as well.

The final group, artisanal/informal producers, are small pisco producers that usually do not follow any technical standard and produce a low-quality grape spirit. Given the increase of the domestic demand of pisco, demand for their product is rising as well. These producers compete on the basis of price.

An important actor upstream is the grape farmer. He is usually a farmer who owns small vineyards and offers his production to the wine and pisco producers. Given the growth of the wine and pisco markets, the in-farm price of grapes has increased substantially, from S/. 0.25 per kilo in 1991 to S/. 0.90 in 2001. Along with that, there has been an increase in grape production, both in area cultivated and yields.

There is also a set of different business organizations and institutions that have taken an active role in the pisco industry. As noted above, the large producers are usually representatives of business associations such as the Viticulture Committee at the National Industry Society or ProVid, an association of grape producers. At the institutional level, CONAPISCO is a council formed by pisco entrepreneurs, government representatives from the Ministries of Foreign Trade, Production and Foreign Affairs, as well as representatives from the Technological Innovation Center (CITEvid). This council promotes exports of pisco and has been very active in looking for external markets and in defending the Peruvian position of the denomination of origin.

3.3 Production Process and Main Technologies

3.3.1 Production Process

As mentioned above, spirits accorded the Pisco denomination of origin can only be produced from eight varieties of grapes, four aromatic and four non-aromatic. Four types of pisco are produced: non-aromatic pure pisco, which is produced from one variety of non-aromatic grape;

² The quality of pisco depends, among other things, on grape quality, which in turn depends on good agricultural practices.

aromatic pure pisco, produced from one variety of aromatic grape; pisco acholado, produced by a blend of non-aromatic and aromatic grapes; and mosto verde, produced with partially fermented grapes.

The production of Peruvian pisco follows the traditional distillation, as grape juice is fermented and then distilled to recover the alcohol. However, the production of Peruvian pisco has three characteristics that distinguish it from other grape spirits. First, Peruvian pisco is distilled from fresh new wine, as opposed to other brandies made from new wine with several months' fermentation or from old wines. Second, pisco is distilled in stop-and-go stills as opposed to continuous stills, which rectify and discard many aromatic elements that characterize Peruvian pisco. Third, the alcohol content is never reduced by adding water after distillation (Pisco Conqueror, 2009).

The former conditions secure the conservation of the typical sensory characteristics that come from natural impurities which are volatilized during distillation. The resulting spirit is transparent or slightly amber colored with an alcohol content of 38 to 48 percent.

3.3.2 Technical Standards

In order to pursue the denomination of origin and the differentiation from other grape spirits, the Peruvian government has defined 10 technical norms (i.e., NTPs, or Peruvian Technical Norms) to maintain the quality of Peruvian pisco. These norms are related to different stages of the production process, from labeling to the testing methods used to determine various chemical and physical characteristics of the spirit.

The interest of the Peruvian government in defining these technical standards is to attain a differentiated product from the Chilean spirit, which is sold in international markets as pisco. In the case of Peru, there are cultural, historic and geographic reasons to name the spirit as pisco.³ Table 1 shows the main differences between Peruvian pisco and the spirit produced in Chile. The main differences are the following: i) Chilean producers add rectifiers (purifying agents) in the fermentation process, while Peruvian producers do not; ii) Chilean producers age the spirit in wood, while Peruvian producers age the spirit in glass or stainless steel receptacles that do not change the characteristics of the resulting spirit; iii) the Chilean spirit can be diluted

³ The word pisco means "bird" in the indigenous Quechua language. Pisco is the name of the containers in which grape juice was fermented, and is also the name of the southern port where this spirit was ship to foreign markets. This spirit was produced since the XVI century by the Spanish settlers in the Viceroyalty of Peru.

with demineralized water to reach the established alcohol content, while Peruvian producers bottle the spirit right after the aging period.

Table 1. Main Differences between the Grape Spirits Produced in Peru and Chile

	PERU	CHILE
Definition	Liquor obtained exclusively from the distillation of recently fermented “pisco grapes” using methods which maintain the traditional principles of quality established in recognized production areas.	...is reserved to liquor produced and bottled, in consumable quantities, in Regions III (Atacama) and IV (Coquimbo) , produced by the distillation of genuine wine, originating from specified varietals, grown in said regions.
Grapes	Non-aromatic: Quebranta, Common Black, Mollar, Uvina Aromatic: Italia, Muscat, Albilla, Torontel	Yellow Muscat, White Early Muscat, Alexandria Muscat, Austrian Muscat, Frontignan Muscat, Hamburg Muscat, Black Muscat, Pink Muscat, Canelli Muscat, Orange Muscat, Pedro Jiménez, Torontel
Production	The fermentation process can be done with partial or total maceration of the grape, strictly controlling the temperature and decomposition of sugars.	The grape juice is fermented into wine containing 14% alcohol (28 proof).
	The fermented product is distilled in copper or stainless steel vessels to the desired alcoholic proof. No product may be added to alter the alcoholic proof, odor, flavor or color of the liquid.	The fermented product is distilled in copper vessels until an alcoholic proof of 55° to 60° is reached. Rectifiers must be added if the alcoholic proof is less than that specified.
	The pisco must be aged a minimum of three months in glass, stainless steel or other materials which do not alter the physical, chemical or organic properties before bottling.	The raw liquor is aged in wood for a short time, usually not more than a few months. Higher quality brands may be aged in oak barrels for a longer time.
	The pisco must be bottled directly after aging, without alteration or adding any product which could alter the odor, flavor or appearance.	The liquor from different distilleries is mixed, diluted with de-mineralized water in order to lower the alcoholic proof to the desired level, filtered and bottled.
Alcohol Content	38% to 48%° (76 to 96 proof)	30% to 50% (60 to 100 proof)
Designated Pisco Areas	Departments of Lima, Ica (Ica, Chincha, Pisco), Arequipa, Moquegua and the Locumba, Sama and Caplina valleys in the Department of Tacna.	Atacama, Coquimbo

Source: Wikipedia (<http://en.wikipedia.org/wiki/Pisco>), accessed 2009.

3.3.3 Technological Changes that Helped to Improve Quality

Although the whole strategy to position the Peruvian pisco in international markets was to preserve the traditional production process, there have been a series of technical improvements that made possible to improve and standardize the quality of pisco.

First, the Development Funding Corporation (COFIDE) has launched a financial instrument for grape farmers supplying pisco producers. These loans finance the technological upgrading and re-engineering of farms that produce any of the designated grape varieties. In this way, yields increased from 6 to 8 tons per hectare to 30 to 35 tons.⁴

Second, several agricultural practices are being implemented to improve vineyards' yield and quality. For example, producers are designing vineyards to maximize potential yield potential per hectare in a minimum amount of time, optimize vine performance, prevent soil erosion and facilitate management of vine canopies. In addition, some producers are establishing organic vineyards that can obtain premium prices and help increase efficiency in the conversion factor of grape kilos per liter of pisco.

Third, the technical norm (NTP 211.001) for pisco production specifies the distillation equipment that must be used, and only three types of still comply with the technical norm. While these types may be less efficient than others in recovering alcohol, they preserve the fruit and flower fragrances that characterize this spirit. This process results in three kinds of liquids: the head, heart and tailings. The head and tails are discarded because they contain undesirable fragrances.

The first and simplest type, the traditional copper still or *falca*, consists of a boiler, where the fermented must is heated, ending in a long neck that is in contact with water to produce condensation and is connected to a tap from which the pisco is poured into a final recipient (see Figure 3).

⁴ Although increasing yield is desirable, wine and pisco require very tasty grapes that are produced by limiting the number of clusters on each plant. The desired productivity per plant will depend on the specific variety and the factors collectively known as "terroir" (environmental conditions that include the soils, weather, water availability, altitude, age of the plant, etc.).

Figure 3. Traditional *Falca*

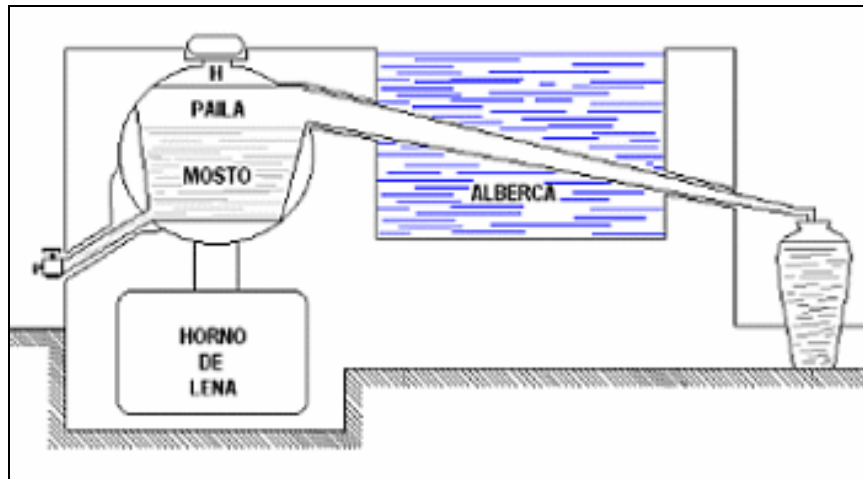

A second and more elaborate type of approved still is the alembic, which consists of a boiler connected to a hood with a swan neck. The vapors of the boiled fermented must pass through this swan neck, which leads to a serpentine where they are condensed (see Figure 4).

Figure 4. Alembic with Serpentine

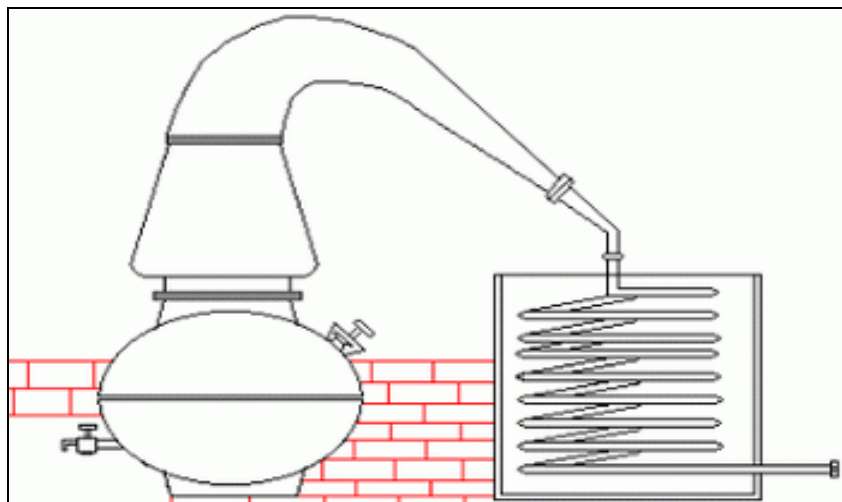

The third and most elaborate type of still approved for Peruvian pisco production is the alembic with wine heater, a design based on the French “charentaise” used in cognac production (see Figure 5). Once the fermented must is heated in the boiler, the vapors swirl to the alembic hood and to the swan neck that connects to a serpentine. The condensed liquid, which has a low

alcohol content, is distilled a second time. This final liquid, called “eau de vie” or pisco, will rest for at least three months before its consumption.

Figure 5. Alembic with Wine Heater

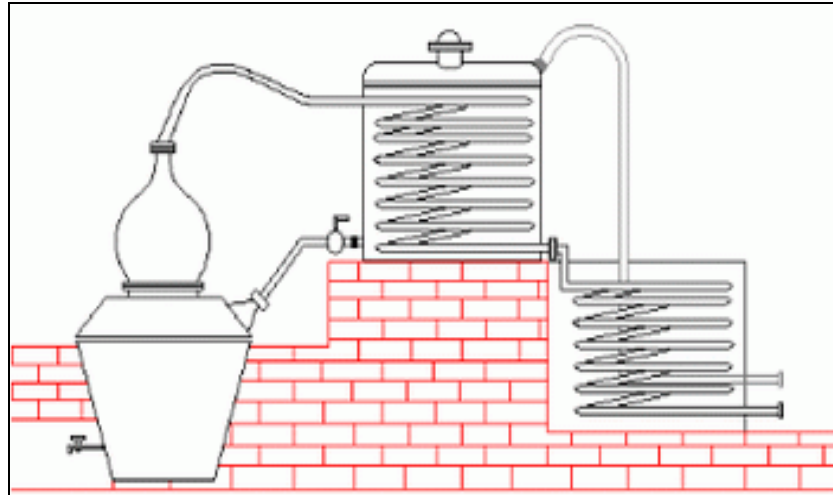

The technical norm has played a highly positive role in standardizing and improving the quality of the pisco produced in the geographic locations covered by the denomination of origin, allowing pisco producers to enter international markets and compete with the finest spirits in the world. Experts indicate, however, that the technical norm is still too ambiguous. For example, it allows a relatively wide range for alcohol content (from 38 percent to 48 percent), while cognac can only contain 40 percent alcohol (80 proof). In addition, there are no specific technical standards for pisco produced by different grapes. This ambiguity may act as a constraint on the WIPO’s approval of a denomination of origin.

Finally, it should be noted that experimentation is producing new pisco varieties through the use of grapes other than quebranta and blends of designated grapes. In addition, experimentation with temperature during the maceration and fermentation stage may give the final product different organoleptic (sensory) characteristics.

3.4 The Role of CITEvid

The network of Technological Innovation Centers (CITEs) is a policy instrument designed by the Ministry of Production to enhance firms’ innovation capabilities and foster their productivity and competitiveness. The CITEs provide a wide variety of services including technical assistance,

training, quality control of inputs and final goods, computer-assisted design and environmental management, among others.

The CITEs are interface institutions that connect different agents in the innovation system with firms in a specific production chain, and they are usually created in the midst of productive conglomerates so they can act as agents of technology transfer. At present, there are 14 CITEs, private and state-owned, that work in different production chains such as pisco and wine, leather and shoes, logistics, agroindustrial products, wood and furniture, textiles and apparel, metal mechanics and software.

3.4.1 Objective

CITEvid is a specialized institution in viticulture sponsored by the Ministry of Production and the Spanish Agency for International Cooperation (AECI). CITEvid was created in 2000, based on the model of the Spanish Technological Institutes.

The objective of CITEvid is to improve the quality, productivity, information and innovation of the different links in the pisco and wine-making chain, as well as support the domestic and international promotion of pisco (CITEvid, 2004).

Its main functions are to:

- Act as a support for the development of the Peruvian viticulture, stressing crop growing and sustainable management of grapes, as well as employment and wealth generation in pisco production and transforming regions.
- Develop research and promote technological innovation in the pisco and wine-making productive chain and in its related industries
- Establish agreements, promote entrepreneurship cooperation mechanisms and other association approaches that favor the development of this productive chain
- Facilitate the search of new markets for the pisco and wine products.

3.4.2 Main Actions Performed by CITEvid

During its first year of existence, CITEvid focused on establishing its demonstration vineyard and oenology laboratory, while pursuing a strategy of building among grape farmers and pisco producers. In 2001, once the pilot cellar and oenology lab were completed, CITEvid began offering training services with the support of the Research and Training Center of the Merced Ranch (Spain) and National Institute of Agrarian Technology of Mendoza (Argentina), and in 2002 CITEvid promoted the creation of the first Consortia of Pisco Small Producers in Ica, who jointly produced 50,000 liters of standardized pisco.

CITEvid currently participates actively in CONAPISCO (National Pisco Commission), a private initiative supported by PROMPEX (the Peruvian Agency of Exports Promotion), which seeks to promote the development of the pisco production chain at all levels. CITEvid has also promoted the participation of training and research institutions in its efforts to support this productive chain. Specific activities include an internship program sponsored by the Universidad San Luis Gonzaga (Ica) and the Universidad Nacional San Agustín (Arequipa) and training events sponsored by the Universidad Nacional Agraria (Lima). CITEvid has additionally supported research on the standardization of pisco, undertaken by the Universidad San Martín de Porres, and on the quebranta grape genome, undertaken by the Universidad Particular Cayetano Heredia, among other projects.

3.4.3 Services Offered and Demanded by Firms

CITEvid offers a wide variety of services in viticulture and oenology. Viticulture services include laboratory assays, vineyard design, technical assistance and training, information and sale of vines. Oenology services include the following: laboratory essays, physical and chemical tests for wines and pisco, microbiological tests, clarification and stabilization assays, research and development of new products, organoleptic tests, cellars design, technical assistance and training, information, and certification and cellar services for the production of wines and pisco.

Figure 6 shows the evolution of CITEvid revenues, which increased dramatically from S/. 16 thousand in 2001 to S/. 405 thousand in 2006. Following a peak of S/. 517 thousand soles in 2008, revenue has substantially declined, a trend related to changes in cellar services. In recent years, some CITEvid clients have invested in building their own distillation facilities, and their services come into direct competition with CITEvid. Moreover, these new distillation

service providers say that CITEvid represents unfair competition because it offers subsidized services. In fact, CITEvid cellar services are cheaper and include technical service because the aim of the institution is to promote and diffuse technology. Cellar services, however, are provided for a maximum of three years and a firm can only process 5,000 liters of pisco per growing season.

Figure 6. CITEvid Revenues

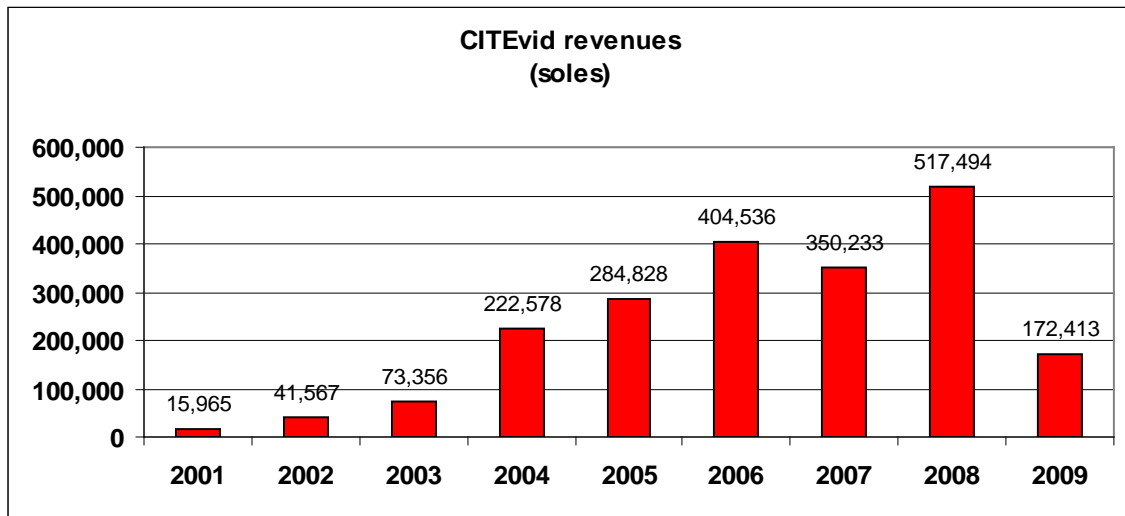

Source: Author's compilation based on CITEvid data.

Figure 7 shows the number of service requests that CITEvid's viticulture area received from firms. The most demanded service is information (449 requests), followed by the sale of plants (377 requests) and technical assistance (315 requests). CITEvid has become the main reference source for anyone who wants to enter in the pisco industry. The institution provides information about the basics of this industry (technical and economic information, regulations and standards, among other factors). It also sells plants that can be transplanted directly onto farms. Firms can ask for assistance in decide what kind of plant is best suited for their farms according to type of soil and availability of water, as well as information about the best agricultural practices to increase yield and avoid pests and diseases, among other types of assistance. There is less demand for other, more sophisticated services such as lab assays or training. However, since pisco producers concern themselves primarily with the oenological aspects of pisco production, having efficient agricultural management guarantees adequate yields and high-quality grapes.

Figure 7. Services Offered by Viniculture Area (2000-2008)

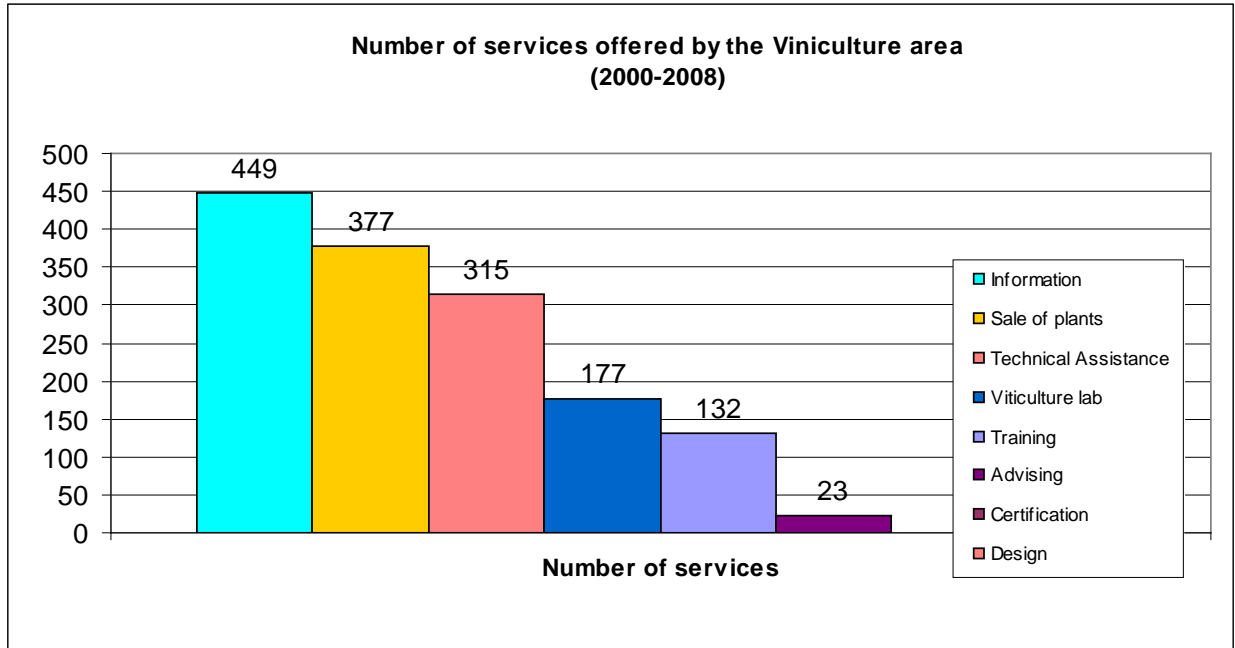

Source: Author's compilation based on CITEvid data.

Figure 8 shows that the most demanded services in the Oenology Area are cellar and information services (582 and 455 services, respectively). During the pisco-producing season, CITEvid cellar works in three shifts around the clock. The production of a 5,000-liter batch of pisco usually takes between one to two weeks depending on the type of pisco to be produced and the conditions of the raw material. Firms can produce a minimum of 1,000 liters and a maximum of 5,000 liters per year, for a maximum of three years. It is assumed that three years is an adequate period to master pisco production and after that firms can invest in their own cellars or manage the distillation process in contracted plants. Lab services were requested 259 times, mainly by firms that wanted to test their pisco for exporting or that wanted to apply for the National Institute for the Defense of Competition and Protection of Intellectual Property (INDECOPI) certification of pisco producer.

Figure 8. Number of Service Demanded by the Oenology Area (2000-2008)

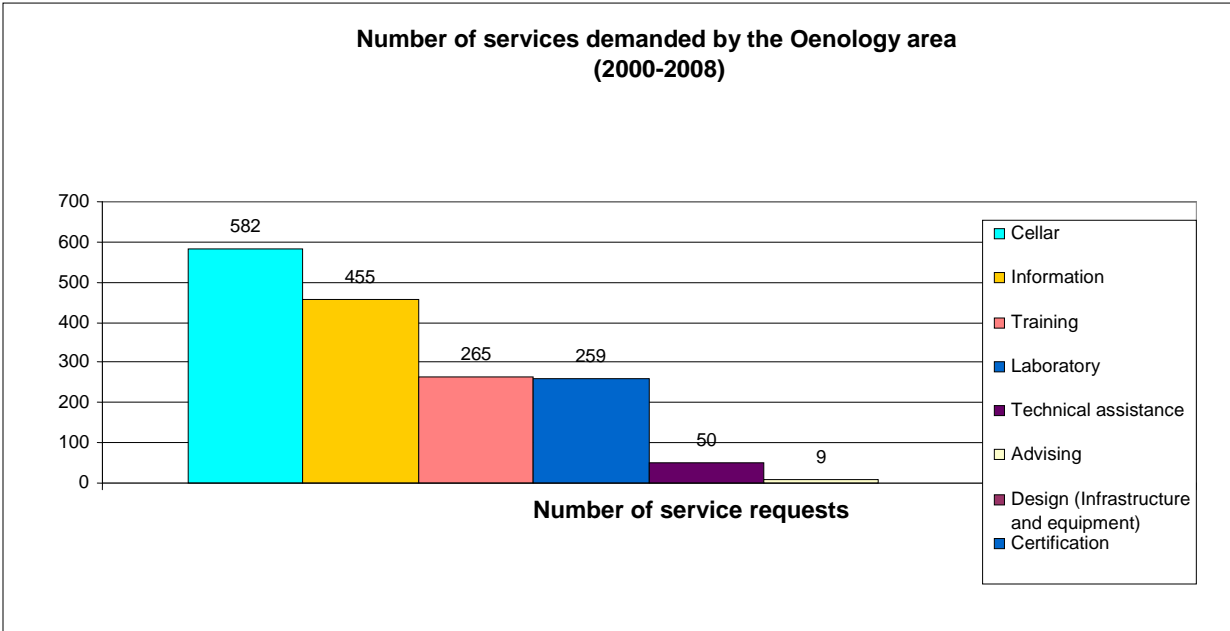

Source: Author’s compilation based on CITEvid data.

4. Innovation in the Shoe Value Chain

Leather and footwear production is a traditional and mature manufacturing sector in Peru. This labor-intensive industry has strong links to other manufacturing sectors and is made up of very heterogeneous firms.

At the international level, this industry has followed two patterns of development. On the one hand, there are large integrated firms with more than 300 workers, which produce shoe parts and other inputs in-house. They produce as many as 10,000 pairs of shoes per day and have well-known brands and a large international market; this model is followed in the United States, France and Germany. On the other hand, there are small specialized firms that participate in different links of the production chain. These firms have small outputs and produce a wide variety of items. The constraints associated with small size are overcome by a network of common services and through association schemes; this model is followed in Italy and Spain.

The Peruvian shoe industry follows the second model, although it suffers from a series of structural constraints and urgently requires technological upgrading.

4.1 Overview

The Peruvian shoe industry is mainly composed of small firms. In 1996, there were 4,318 shoe firms, 97.5 percent of which had fewer than 10 workers. While this pattern follows the Italian and Spanish model of small shoe and leather firms, firms in Peru are not specialized; they undertake multiple stages of production and are consequently inefficient. In addition, very few firms manufacture shoe components or provide services such as design. This underdevelopment at the firm level limits technological change, creativity and differentiation in the Peruvian shoe industry.

There are three major agglomerations of shoe firms. The first, in and near the Lima districts of San Juan de Lurigancho, Rímac, San Martín de Porres and Comas, account for 66 percent of all shoe firms in Peru. The second, located in the districts of El Porvenir in La Libertad, accounts for 12 percent of all shoe firms; the former has become a particularly important shoe district, and various non-government organizations have assisted its small shoe firms. Finally, the city of Arequipa accounts for 10 percent of the country's shoe firms, which are well connected to leather-producing firms, given the important meat and dairy industry in this department (MITINCI, 1998).⁵

The Peruvian shoe industry produces mainly for the domestic market. According to the Annual Economic Survey 1996, the gross production value of the industrial subsector of Manufacture of Shoes (CIU 1920) was US\$ 171.2 million, while total sales amounted to US\$ 143.4 million; exports represented only US\$ 0.377 million.

As shown in Figure 9, however, shoe exports have since then substantially increased, from a total of US\$ 3.3 million in 2000 to US\$ 17.3 million in 2008. Leather shoes (upper and soles) and shoes made of textile material (upper) are the most exported, with value sales of US\$ 4.6 and US\$ 7.5 million, respectively.

⁵ MITINCI was the former Ministry of Industry, Tourism and International Trade. In 2002, the Ministry of Production was created to regulate and design the policy in the manufacturing and fishing sectors, while the new Ministry of International Trade and Tourism will be responsible for its corresponding sectors.

Figure 9. Export of Shoes (2000-2008)

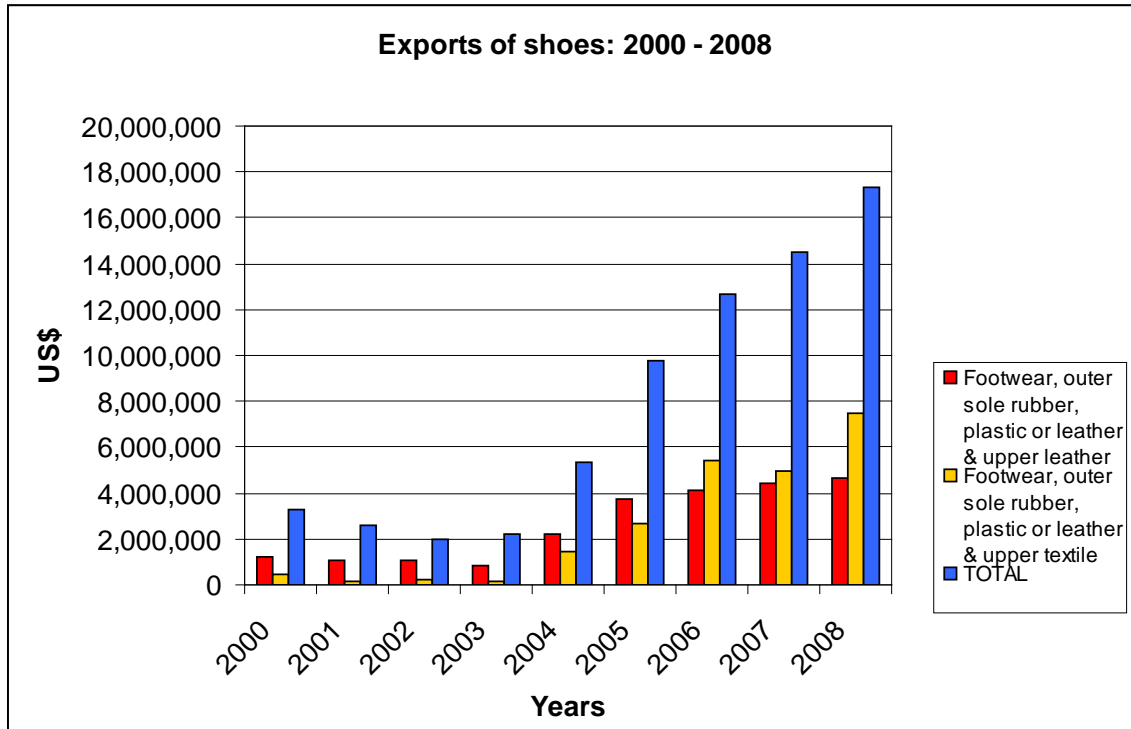

Source: Author's compilation based on MITINCI data.

As shown in Figure 10, Colombia has become the main export destination for Peruvian shoes, followed by Ecuador, Chile and the United States. The importance of Andean countries in this list may reflect the effect of lower tariffs. It should also be noted that demand varies among countries. Approximately 57 of Peru's leather shoes (upper) exports went to Colombia in 2008, while in that year 43 percent of footwear made with textile material (upper) went to Ecuador.

Figure 10. Destination of Shoe Exports

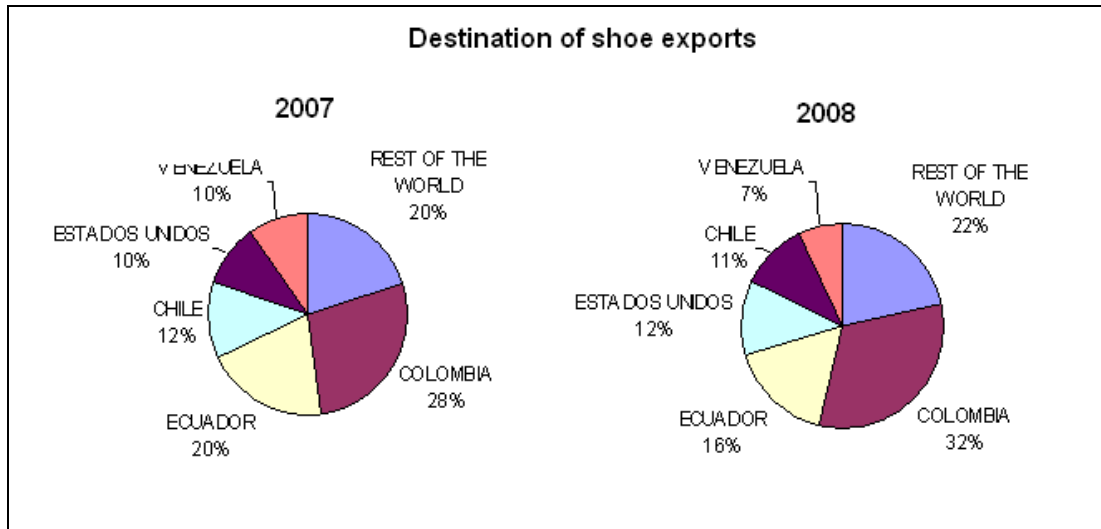

Source: Author's compilation based on MITINCI data.

4.2 Main Actors

As mentioned before, 97.5 percent of all shoe firms in Peru have fewer than 10 workers, and 99 percent of firms have fewer than 20 workers. These firms' limited technological capabilities are reflected in the low quality of their final products, which are sold in the domestic market. Fewer than 10 medium firms,⁶ most of them family-owned, export part of their production. The micro and small firms that make up almost the entirety of this sector receive support from several government programs such as BonoPyME, a subsidy for business development services.

This sector has business associations at both national and regional levels. The former include the Footwear and Accessories Producers Association (APEMEFAC) and the Leather, Shoe and Complements Corporation (CCCA). Also important is the Shoe Committee of the National Industry Society, which is very politically active. At the regional level, business associations usually represent the districts where agglomerations are located. In La Libertad these include the Association of Small Footwear Producers (APICALZA) and the Florentian Association of Footwear industrialists (AFINCAL).

Actors in the sector include both government institutions and non-governmental organizations (NGOs). Government institutions include the Technological Innovation Center (CITEccal), the Ministries of Production and Foreign Trade and the National Service for

⁶ A medium firm is defined as having 20 to 99 employees.

Industrial Training (SENATI). NGOs, which provide technical assistance and training, such as MINKA in Trujillo or DIACONIA in Lima. These NGOs receive support from development agencies such as German Technical Cooperation (GTZ) and Government of Switzerland Technical Cooperation (COTESU).

4.3 Production Process and Main Technologies

4.3.1 Production Process

While the production of a shoe involves between 90 and 200 steps, depending on the sophistication of the shoe, those steps fall under the larger categories of cutting, sewing, lasting and finishing. All of these are highly labor-intensive, especially sewing, in which the fancy details of the shoe are added.

As shown in Figure 11, the shoe industry has dense industrial links. The value chain of shoe manufacturing includes value-adding links such as design, pattern grading, cutting, sewing, pulling over and finishing touches. Since the complexity of this process implies that a high degree of coordination is required among its participants, technical standards should act as a coordination mechanism to increase the efficiency of the whole production chain.

Some of the main bottlenecks in the shoe production chain involve livestock practices. Farmers treat leather as waste rather than a byproduct, which results in very low quality skins, and unskilled slaughterhouse workers do not flay skin from carcasses in a way that would preserve its quality. Moreover, tanneries are constrained by inadequate technology and the lack of skilled workforce. The industry is consequently attempting to improve quality by standardizing the production of leather and leather goods. Specific measures include the introduction of sanitary measures in cattle-raising and livestock management, sanitary inspections in slaughterhouses, the implementation of technical standards for the commercialization of skins and leathers, the environmental regulation of tanneries, the definition of technical standards for specifications, and chemical and physical assays in leather manufacturing, shoe manufacturing and shoe components. High-quality shoe producers import leather from neighboring countries such as Colombia.

Figure 11. Footwear Value Chain

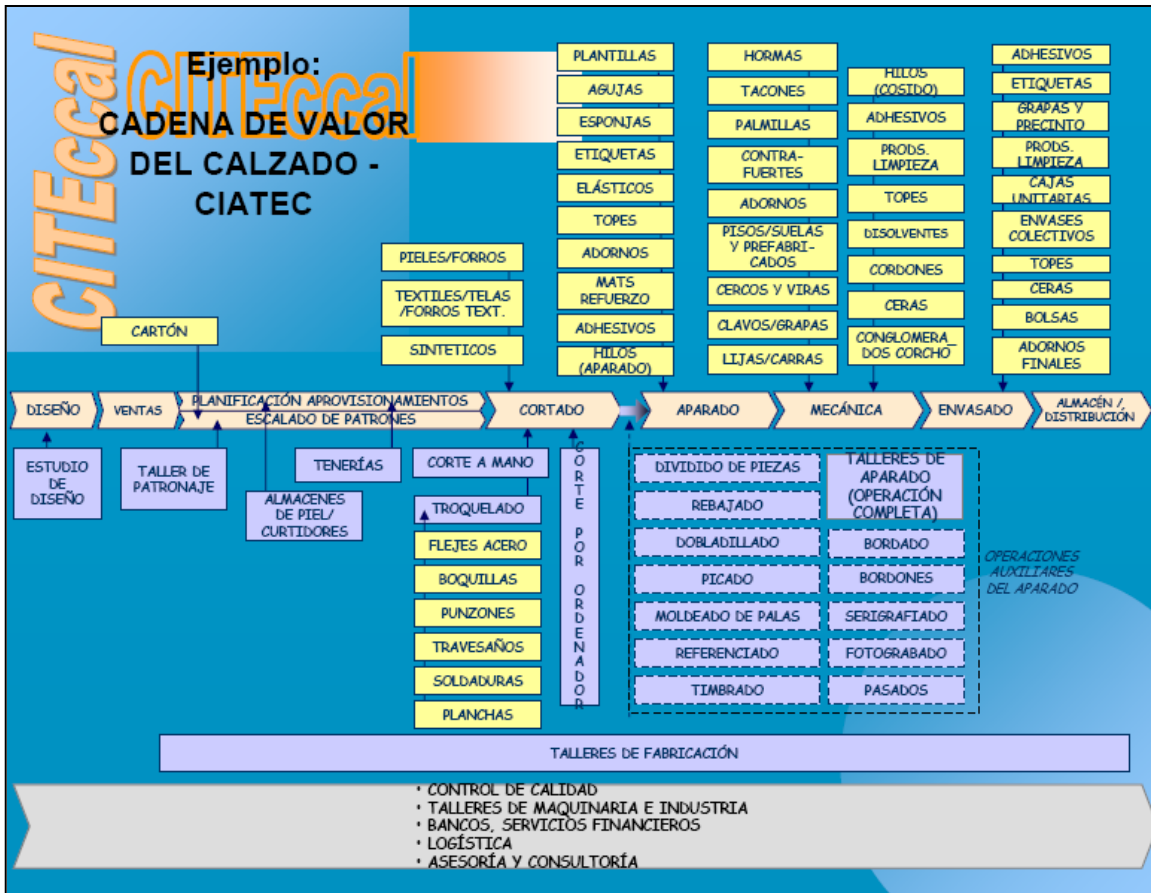

4.3.2 Technical Standards

The definition of technical standards in this industry has not followed a straight path. Even when firms' heterogeneity and informality limited the sector's overall global efficiency of the whole industry, the usefulness of technical standards as a coordination instrument was little known. This changed with the entry into the Peruvian market of cheap Chinese shoes that were sold as leather shoes but were in fact made with synthetic materials. While domestic firms initially sought and obtained technical norms in labeling as a non-tariff barrier to protect their domestic market, government institutions began to use labeling in the terms of reference in procurement bids. In this way, technical standards began to be applied as a requirement for the domestic market.

Since then, several standards have been defined for different segments of the leather and footwear production chain. Table 2 shows current technical standards in the production chain.

The 45 standards are supposed to secure compatibility among different components of the chain and thus assure the quality of final products. In reality, however, several agents in the chain do not meet these standards, and consumers are faced with final products of variable levels of quality. Footwear producers that sell in sophisticated markets, moreover, have to spend a great deal of time ensuring that their suppliers procure high-quality raw materials. At the end, the standards are not used by firms because they are not compulsory or, at least, because there are no enforcement mechanisms. However, footwear producers consider these technical norms useful. They are seen as helping to increase the quality of their products, promote entry into new markets and facilitate relationships with customers and suppliers.

Table 2. Technical Standards (NTP)

Segment	Technical standards (NTP)
Leather	<ul style="list-style-type: none"> ▪ Definitions and terms (1 standard) ▪ Physical assays (14 standards)
Footwear	<ul style="list-style-type: none"> ▪ Definitions and terms (1 standard) ▪ Types of footwear (7 standards)
Sampling	<ul style="list-style-type: none"> ▪ Sampling of leather (2 standards)
Chemical tests	<ul style="list-style-type: none"> ▪ Leather (8 standards) ▪ Labeling of leather products (1 standard)
Hair-on leather	<ul style="list-style-type: none"> ▪ Hides (11 standards)

Source: Author's compilation.

4.3.3 Technological Changes that Helped to Improve Quality

Mody et al. (1991) stated that the technologies that had the greatest impact on the footwear industry are computer-aided design (CAD) and the soft technologies related to internal quality control and inventory management (e.g., total quality control and just-in-time techniques). CAD systems help decrease significantly the lag time between design and production, a major consideration in a fashion-conscious market. CAD systems create the patterns required to produce the base shoes and then grades these patterns across all shoes sizes. CAD systems can also be interfaced with automation technologies in the production phase, including automatic cutting and stitching. Computer-aided manufacturing (CAM) has spread slowly, however, given the labor intensity of several steps in production. Soft technologies, for their part, have significantly raised efficiency and become the main drivers of change. They have helped to

“improve access to raw materials, their quality control, their inventory control and production scheduling, and the training and motivation of management and staff” (Mody et al., 1991).

The success of soft technologies implies an important component of learning by doing in this industry. Most changes required by these production improvement methods require continuous adaptation of the production process, not only internally but in the relationship of the firm with its suppliers and customers.

In general, this industry follows the innovation pattern of LMT in which there is a search for efficiency improvements rather than the launch of radical innovations. As mentioned before, most shoe firms are very small and have little mechanization. The natural path to mechanization of a small shoe firm is to buy second hand or adapted machinery⁷ to skive and sew the upper part of the shoe, which is the most labor-intensive part of the shoe-making process. Pressing machines to attach the molded lasts to the soles are also demanded by firms that want to invest in equipment. Firms that do not have enough resources to buy machinery can subcontract the skiving, sewing and lasting services, among others.

4.4 The Role of CITEccal

CITEccal was created in 1998 as the result of an agreement signed by the former Ministry of Industry, Tourism and International Trade, the Export Promotion Office and the Government of Spain. With the technical support of the Spanish Research Association for the Shoe and Related Industries (INESCOP), CITEccal aimed at the technological upgrading of Peruvian leather and footwear production.

For that purpose, CITEccal promotes the modernization of this industry via the use of more advanced technologies, the alignment of shoe and leather products with international standards, promoting the development of related industries, facilitating access to technological, market and design information and providing training and technical assistance.

Figure 12 shows the services that CITEccal offers to firms in the shoe and leather production chain. In the area of raw materials and inputs, CITEccal has been working to develop fish skin leather using paiche (also known as arapaima) and other Amazon fish species. It has

⁷ Although shoe producers value Italian, German and Brazilian machinery, some local manufacturers that have converted domestic sewing machines into skive machines (i.e. a machine that creates a specific profile on the edges of cut sheets of leather). According a survey by CENDO/MINKA in Trujillo, 47 percent of firms have foreign machines, 33.5 percent have mechanical machines produced with simple technology in metal workshops in Lima, and 13 have domestically produced machines.

additionally worked in promoting environmental best practices in the tannery process. In the shoe production, CITEccal has been very active in promoting services related to product design and grading patterns, as well as quality control methods. It also provides lab assays to test the resistance of leather and soles and helps firms to comply with technical standards. Finally, CITEccal has been very active in providing technical and market information to firms, as well as actively promoting joint actions in this sector.

Figure 12. Services Offered by CITEccal to Production Links in the Leather and Shoe Sector

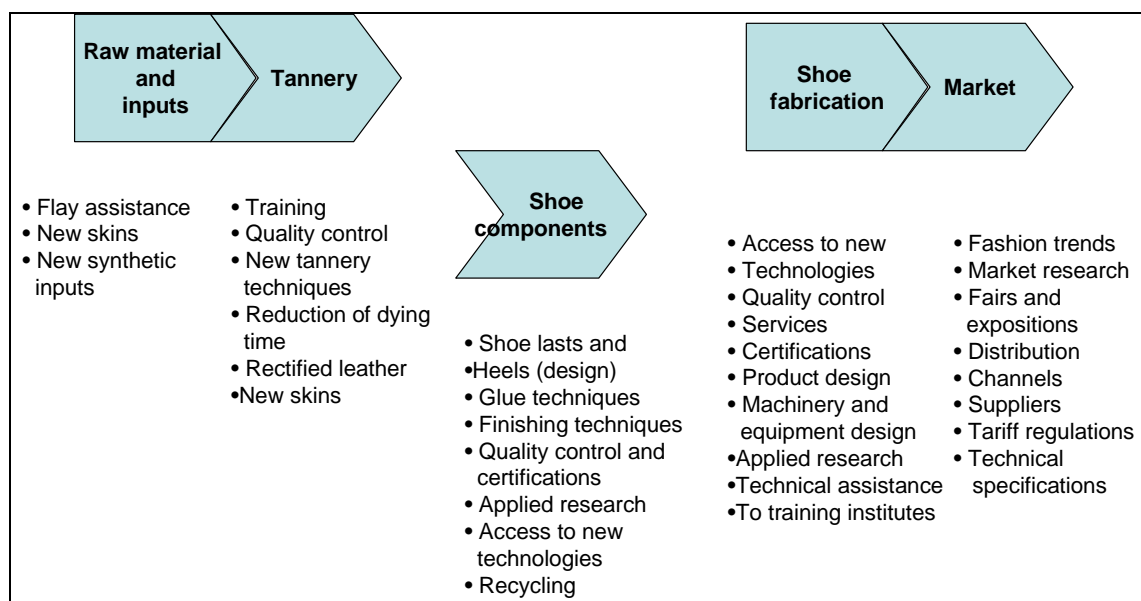

Source: Author's compilation based on CITEccal data.

CITEccal's revenues have averaged around US\$ 61,700 during the period 2001-2008, reaching a peak of US\$ 70,699 in 2004. These figures are somehow disappointing considering that, according to the latest Manufacturing Census, in 2007 there were 1,657 footwear producers in Lima and Callao, which means that the CITEccal's sales of services average only US\$ 37 per firm.

Figure 13 shows the evolution of sales broken down by type of service. Sales of services like Design Workshop,⁸ Training and Technical Assistance have declined since 2006. This may have resulted from an increased competition for grading and trading services, or from the end of

⁸ Services in the Design Workshop include modeling and grading.

the end of the BonoPyme program, which has reduced demand for technical assistance services and training. Sales for lab services have remained somehow stable because CITEccal is the only institution with a laboratory for performing specific tests for the leather and shoe sector.

Figure 13. CITEccal 2001-2003 Sale of Services

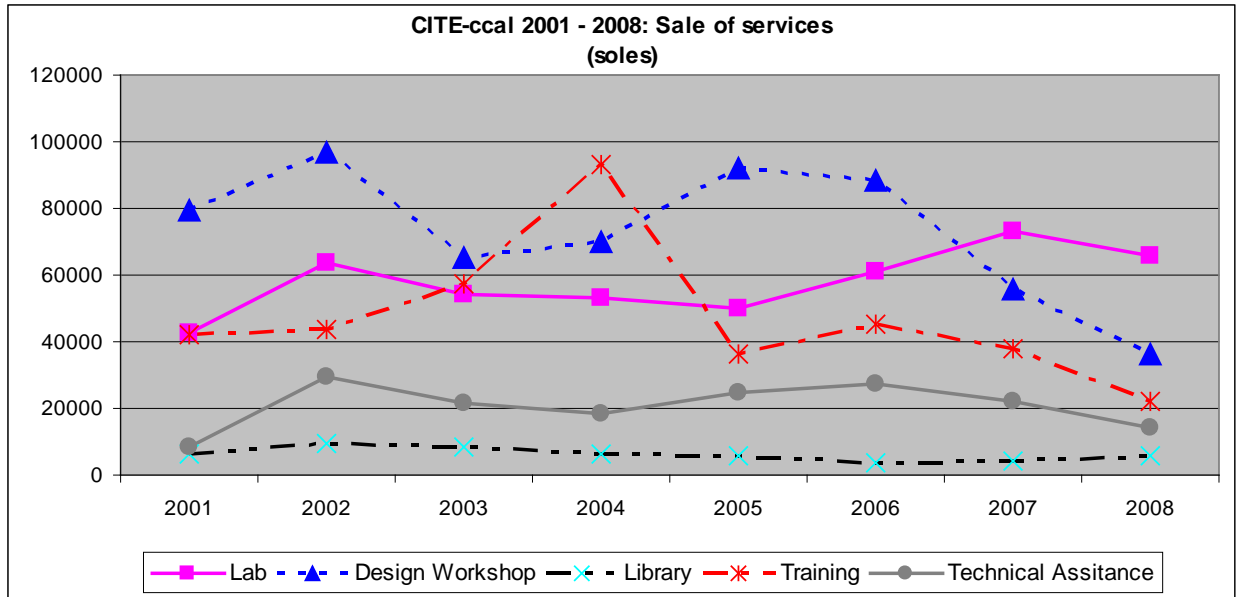

Source: CITEccal statistics.

Figure 14 shows the average amount paid for each type of service during 2008. The most expensive service is technical assistance, which was demanded 19 times at an average price of S/. 580. per service and was demanded 19 times in 2008. The second most expensive service was lab assays, which was solicited 99 times at a price of S/. 551 per request. The third most expensive service, grading patterns, was demanded 85 times at an average cost of S/. 325. It is interesting to note that firms paid almost the same amount of money for shoe pattern making as for training seminars and courses. It might be indicating that the former step is usually undertaken within firms. This is confirmed given that this service was demanded only 12 times in 2008.

Figure 14. Average Sale Amount per Type of Services

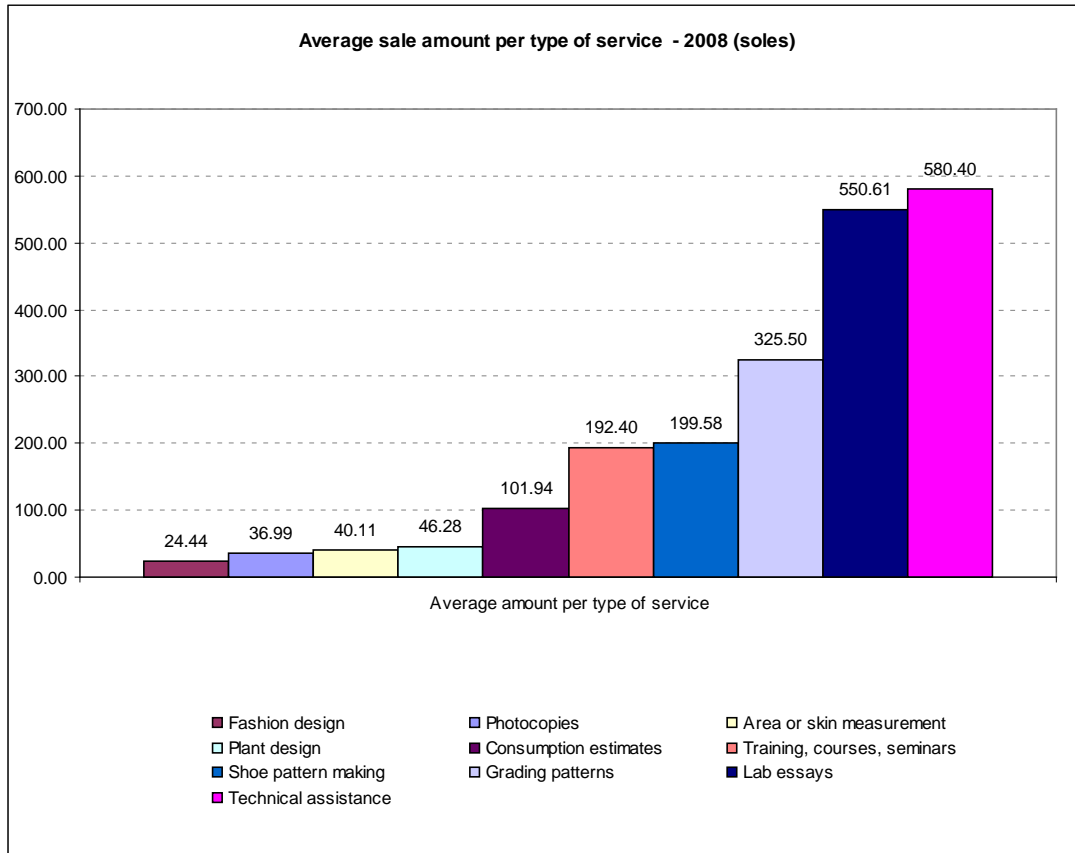

Source: CITEccal statistics.

Even though CITEccal is supposed to provide services to leather and footwear firms on a permanent basis, demand has remained slack. Table 3 shows that during the period 2001-2008, 91 percent of all firms requested CITEccal services from 1 and 10 times, and only 2 percent demanded services more than 100 times. In effect, even though some services like grading or certain lab assays should ideally be demanded every time a model is launched, firms are frequently not requesting them. On average, firms that requested services between 1 and 10 times have worked with CITEccal for an average of 1.2 years, while those that request service more than 100 times have worked with CITEccal for an average of 8.7 years.

Table 3. Firms by Number of Services Demanded (2001-2008)

Firms by number of services demanded: 2001-2008		
Minimum	Maximum	
1	10	1731
11	20	83
21	50	50
51	100	25
101	250	10

Firms by number of services demanded: 2001-2008		
Minimum	Maximum	
1	10	1731
11	20	83
21	50	50
51	100	25
101	250	10

Source: CITEccal statistics.

5. Field Interviews

The purpose of the fieldwork is to collect primary information from the clients of CITEvid and CITEccal about their innovative behavior, their relationship with these institutions and their perceptions about technical standards and the way the latter affect them.

5.1 Methodology

5.1.1 Questionnaire

The questionnaire, shown in Annexes 1 and 2, consists of seven sections (see Annexes 1 and 2). The first and second collected general information about firms. The third section asks firms about their degree and type of involvement in technological innovation and the main obstacles they faced.

The fourth through seventh sections asked about firms' relationship with their respective production chains, particularly the kind and frequency of services demanded. Additional questions involved payments made by firms and whether they were backed by any subsidy program. Finally, firms were asked if they made investments and whether they could identify learning effects or any additional impacts.

Section five explored the technical standards that affected each production chain and firms' perception of those standards. Firms were also asked how the CITEs or other institutions aided their compliance.

The final section explored firms' relationships with other agents in their production chain. Topics of particular interest included the existence of bottlenecks and the possibility of joint action in the production chain.

5.1.2 In-Depth Interviews

These interviews were recorded because firms' representatives would usually comment on different topics such as the situation of their specific production chain, the way public policy affects them, and shared attitudes among entrepreneurs. Another set of interviews was conducted with public and private sector representatives.

5.1.3 Selection of Firms

Firms were selected from the list of clients of both CITEs in order to learn about the behavior of innovative firms and whether client firms are concerned with learning about new technologies and practices. Firm information was obtained from the Annual Economic Survey (AES) in order to compare interviewed firms and control firms.

In the case of the pisco chain, CITEvid provided a list of clients that demanded services in various areas (i.e., laboratories, viticulture, oenology, cellars and standardization services), as well as a list of clients considered as specialized producers. Of the 10 firms interviewed, nine are located in the Ica region and eight are or have been clients of CITEvid.

In the footwear chain, we interviewed 19 firms, selected according to the number of times they demanded services from CITEccal. While we originally intended to select firms according to their share in the database during the period 2001-2008, it proved very difficult to do so because the firms that demanded services from 1 to 10 times were very reluctant to be interviewed. At the end, the sample was distributed as shown in Table 4. Firms in the first group are usually small and usually have little technological capacity. Firms in the latter groups, which are usually larger and have greater technological capacity, regularly demand pattern grading and laboratory services.

Table 4. Sample of Footwear Firms interviewed

Groups	Firms expected to be interviewed	Firms actually interviewed
From 1 to 10 times	13	8
Between 11 and 20 times	1	0
Between 21 and 50 times	2	2
Between 51 and 100 times	1	4
Between 101 and 250 times	2	4
TOTAL	19	18

Source: Author's compilation.

5.2 Results for the Pisco Chain

5.2.1 Main Features of Interviewed Firms

The sample consisted of 10 firms, broken down by 2008 sales revenue in Table 5. As noted above, eight of those firms have been clients of CITEvid, and nine are located in Ica, as are CITEvid's facilities. Although only one of the firms produces wine, all 10 firms produce more than one type of pisco, usually combining pure pisco and blended or aromatic varieties.

Table 5. Sample of Pisco-Producing Firms

2008 sales in US\$	Number of firms	Percentage (%)
Less than US\$ 33.3 thousand	3	30
Between US\$ 33.3 – 166.7 thousand	6	60
Between US\$ 166.7 – 833.3 thousand	1	10
More than US\$ 833.3 thousand	0	0
TOTAL	10	100

Source: Author's compilation.

Two of the firms fewer than 10 workers. Such firms are usually small grape farms of 1 or 2 hectares that decided to produce their own pisco because pisco cellars pay very little for the grapes. The remainder of the firms have more than 10 workers. It should be noted, however, that firms hire additional personnel during the pruning and harvesting seasons.

Six of the 10 firms surveyed export pisco, primarily to the U.S. market, although four sell in Europe. Producers state that the greatest constraint on exports is that, except for Peruvian expatriates, the liquor is not well-known abroad. In addition, producers cannot approach

commercializing firms, because the latter ask for larger volumes than any single producer can provide. As a result, pisco firms sell most of their production domestically.

As shown in Table 6, firms' main investments in 2008 were the purchase of capital goods, especially in firms with sales larger than US\$ 33.3 thousand, and the purchase of CITEvid services. Firms also hired personnel with higher skills and performed organizational and marketing changes. While pisco firms used to sell to regional markets, recent increases in product quality and quantity have allowed firm to target new markets like Lima and export destinations. This requires a different strategy to commercialize the product, from selling pisco in bulk to selling it directly in supermarkets.

Table 6. Firms that Invested in 2008

Firms that invested in 2008				
	Purchase of capital goods	CITEvid's services	Hiring of personnel with higher skills	Organizational or marketing changes
Less than US\$ 33.3 thousand	3	2	0	0
Between US\$ 33.3 and 166.7 thousand	5	2	3	2
Between US\$ 166.7 and 833.3 thousand	0	0	0	0
Total	8	4	3	2

Source: Author's compilation based on CITEvid data.

5.2.2 Innovation Behavior

Interviewed firms understood innovation as the introduction of improvements or novelties in their products or their productive processes. The production of a new kind of pisco, such as an aromatic variety, is considered a product innovation, while the introduction of new agricultural or distilling techniques is considered a process innovation.

All of the interviewed firms engaged in innovation. Eight of the firms reported launching product innovations, and all ten firms launched process innovations.

Table 7 shows that firms' main innovation activities are the purchase of capital goods and R&D. Although CITEvid and several private firms provide distillation services, distillation equipment accounted for the largest share of capital goods purchases. As expected, larger firms bought more equipment (five out of eight firms). In the case of R&D, pisco firms have to engage extensive experimentation to improve the quality of the spirit, as changes in temperature and length in each step of production can alter particular characteristics of the spirit. In viticulture,

firms experiment with the adaptation of new grapes that can lead to the production of new pisco varieties. Larger firms in the sample engage in more R&D, mainly because these firms have their own distillation facilities and can control each part of this process.

Table 7. Innovation Activities Performed by Firms

	Innovation activities performed by firms						
	R&D	Technology licensing	Purchase of capital goods	Engineering and industrial design	Training	Consulting	Management changes
Less than US\$ 33.3 thousand	2	0	3	1	1	1	0
Between US\$ 33.3 and 166.7 thousand	4	0	5	2	1	3	1
Between US\$ 166.7 and 833.3 thousand	1	0	0	0	0	0	0
Total	7	0	8	3	2	4	1

Source: Author's compilation.

With regard to the objectives of innovation, Figure 15 shows that firms innovate primarily to improve the quality of the product (9 out of 10). There is a culture of quality in the pisco industry; firms compete in local, national and international contests and are thus always willing to improve the organoleptic characteristics of the spirit they produce. Two other important objectives are to increase current market share and open new markets (seven of the 10 firms for each objective), a reflection of the pisco market, which is growing both nationally and internationally. Many pisco producers hope to export their product because of the high prices that can be paid in foreign markets, although this requires a very high-quality spirit.

Figure 15. Degree of Importance of Innovation Objectives

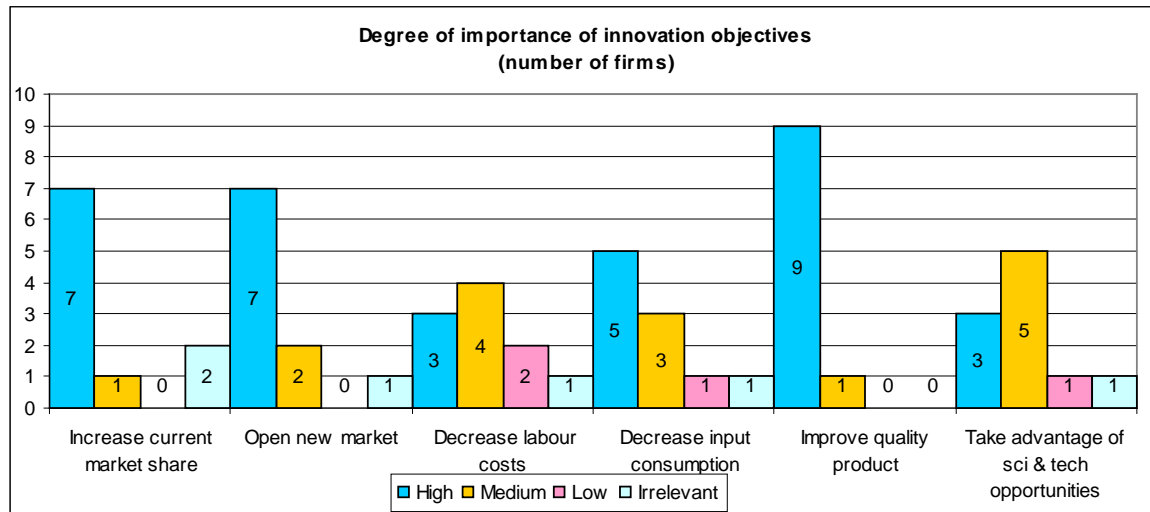

Source: Author's compilation.

In regard to reported obstacles to innovation, the greatest is, as shown in Figure 16, the lack of market information (six of 10 firms). Given the quality culture prevalent in the pisco industry, many producers think that a good quality product will sell itself, but that that is not the case. Some producers have reported that they were not able to sell their product even when it is of high quality. This problem is not confined to small producers. For example, a large firm not present in the sample did not produce in the 2009 season because it could not sell around 300,000 liters of spirit. The second major obstacle named by firms is the lack of technology development institutions (5 out of 10). Although CITEvid is a highly recognized technology institution, particularly experienced firms mentioned that CITEvid services did not cover their needs. They said that CITEvid is a good institution for learning, but it cannot offer more sophisticated services. In contrast to these two obstacles, firms reported that limited access to funding was of secondary importance. Some producers self-finance through personal savings or through subsidizing pisco production with other enterprises. For example, one producer mentioned that he paid for viticulture innovations with the earnings of a pecan plantation he also owns.

Figure 16. Degree of Importance of Innovation Obstacles

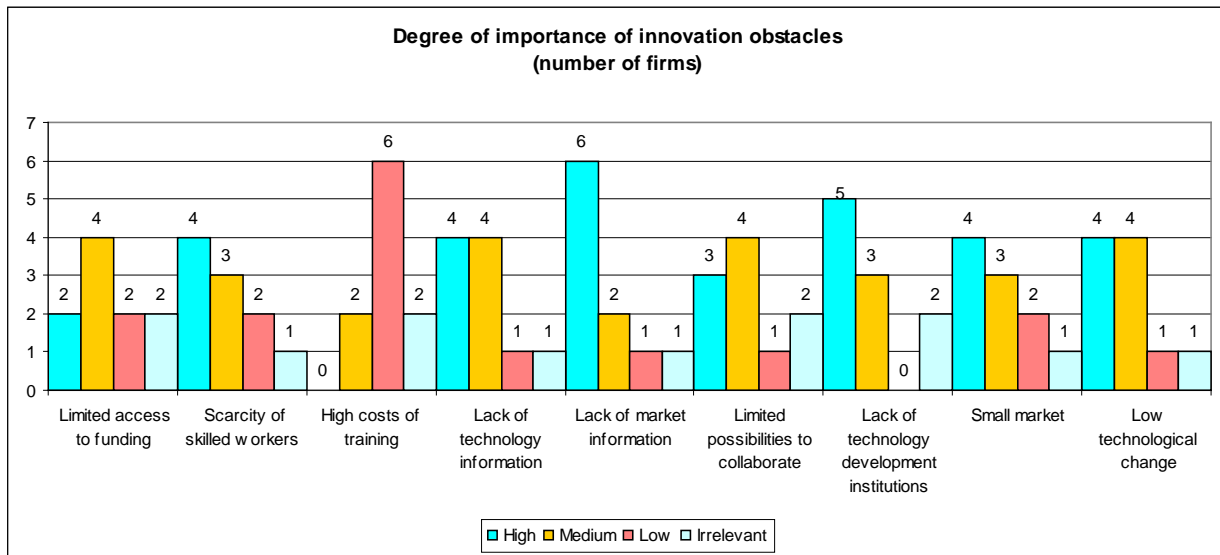

Source: Author's compilation.

Seven of the surveyed firms reported imitating other firms. Only two reported product imitation, but all seven mentioned imitation in the production process, a reflection of the diffusion process in this industry. CITEvid has also contributed to diffuse knowledge. Although pisco firms in Ica have long used traditional methods passed down for generations, the presence of CITEvid has encouraged them to try new techniques. Although technical standards have been established, there remains considerable room to experiment with different organoleptic characteristics; firms are consequently not worried about being imitated.

5.2.3 Relationship between Firms and CITEvid

Eighty percent of firms stated that the services offered by CITEvid were beneficial for them. Forty percent described these services as very good, 30 percent as good and 30 percent as fair. In general, firms mentioned that they learned the basics of production with CITEvid. On the other side, CITEvid's representatives noted that the production process of pisco is very complex and, as most firms were accustomed to traditional techniques, it was difficult to convince them that their processes could be changed or improved. In addition, firms may have followed certain production practices for a time but did not understand how or why these practices would contribute to a better quality, and in the short term they ignored CITEvid technical advice. Some firms returned to CITEvid for help when they faced a problem that could have been avoided by following the original advice.

Six of the 10 firms mentioned that CITEvid has helped them in their innovation process. Four of those firms sought consulting services to solve specific problems in their production process, and three sought technical information and training services. The events organized by CITEvid have also served to link pisco producers with both domestic and foreign providers of technology. One firm reported that CITEvid assisted in the licensing of technology, and another reported that CITEvid assisted in the purchase or sale of equipment. None of the firms demanded more sophisticated technology transfer services such as joint technological development, joint research projects or technological alliances.

Figure 17. Technology Transfer Mode Received by CITEvid

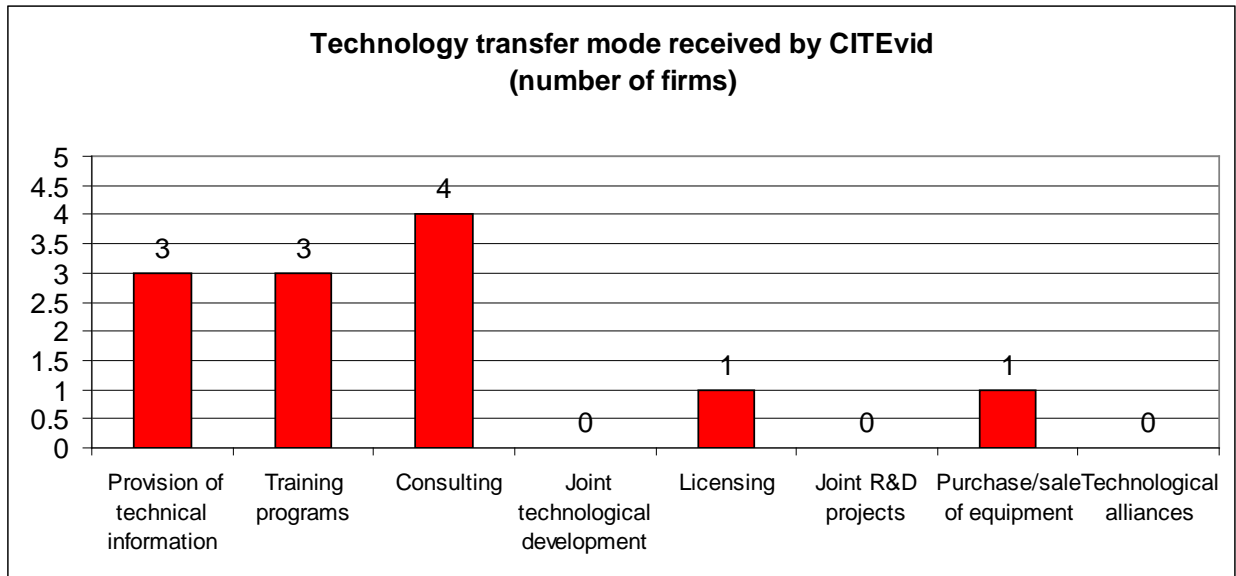

Source: Authors' compilation.

With regard to CITEvid's impact, all firms mentioned that its services have helped to improve the quality of their pisco. CITEvid therefore appears to be fulfilling one of its main objectives. In second place, nine of the 10 firms stated that CITEvid services helped them to achieve higher sales. This is closely related to improvement of quality, but CITEvid also provides marketing advice and help link firms with commercializing agents. In addition eight firms reported that CITEvid services helped them to comply with technical standards. Although CITEvid does not certify firms (a function performed by INDECOPI), it aided firms in meeting standards by providing lab assays and technical assistance. Seven firms mentioned as positive impacts increasing their share in the domestic market and increasing their production capacity. Five firms reported positive impacts on the reduction of labor and input consumption, both linked to technical advice. Better design vineyard and cellar design can reduce the need for labor, and the reduction in input consumption is linked to agricultural and plant practices. By postponing the grape harvest, for example, it is possible to eliminate sulfur⁹ and increase the yield of pisco (between five and seven kilos of grapes are needed to produce one liter of pisco).

⁹ Sulfur is a main component of fungicides. Once it is applied, it requires some time before the sulfur contents comply with the minimum levels permitted for wine and pisco production.

Figure 18. Impact of CITEvid Services

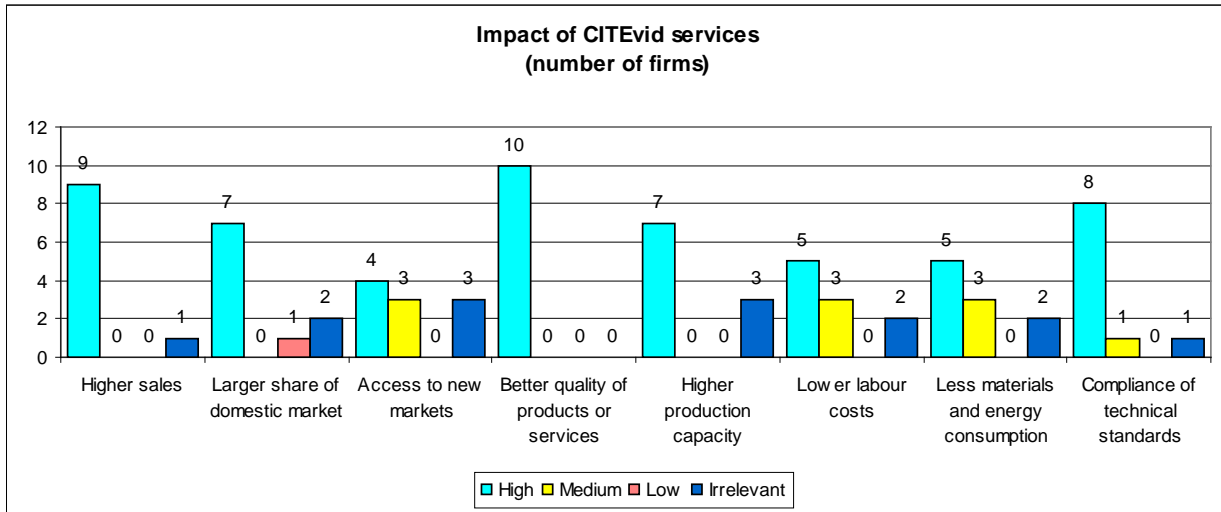

Source: Author's compilation.

With regards to the effects of CITEvid services in the learning process of firms, Figures 18 and 19 show that eight out of 10 firms reported that those services have helped increase their knowledge. As mentioned before, firms used to produce following traditional practices but had little idea of the technological reasons behind them. CITEvid, though, has helped firms to open the “black box,” and five of 10 firms mentioned that they incorporated experimentation as part of their routine. Although the pisco production process is widely known and the technical standards have normalized some of the characteristics and parts of the production process, there is still considerable room for experimentation in the search of specific organoleptic characteristics of the final product. Finally, four out of 10 firms reported the introduction of new procedures in the production process.

Figure 19. Effects of CITEvid on the Learning Process

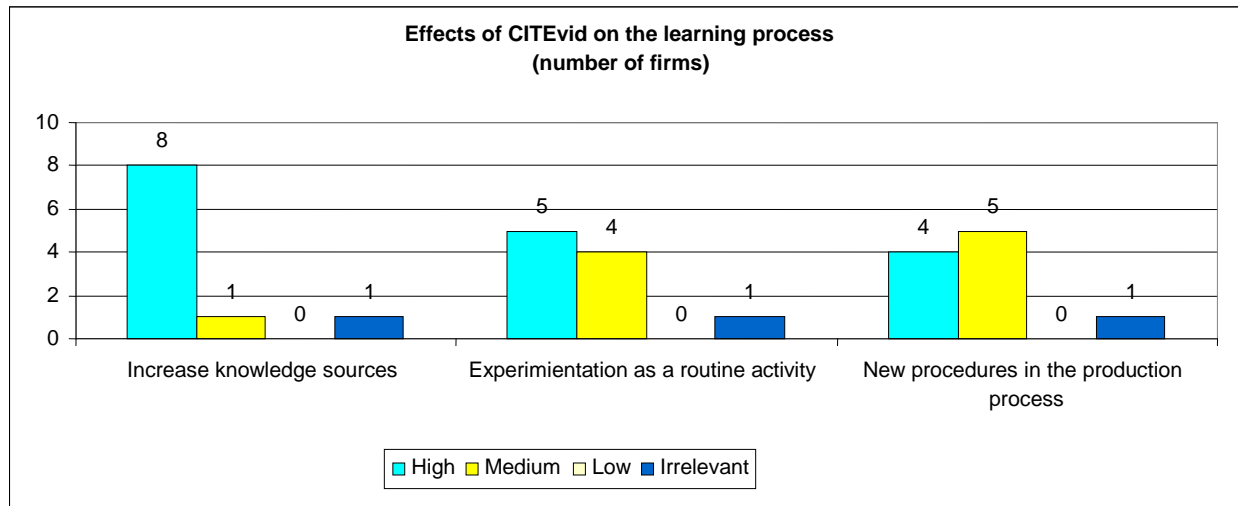

Source: Author's compilation.

5.2.4 Technical Standards

As mentioned before, technical standards have become crucial in this industry. Thus it is not surprising that all firms considered technical norms beneficial for the industry and reported that they use them. Nine firms stated that they had been granted certification of compliance, whereby the National Institute for the Defense of Competition and Protection of Intellectual Property (INDECOPI) certifies that facilities or production arrangements¹⁰ comply with the technical standards; this certification is valid for 10 years.

Table 8 shows that all firms, regardless of their size, considered technical standards to improve the quality of their products. In general, interviewed firms think that standards improve coordination in the pisco chain and open new market opportunities. It is important to mention that the largest firm in the sample does not perceive a positive effect on market opportunities because it is trying to sell in foreign markets and the firm is facing constraints because it has not found yet a commercialization strategy to enter high-end markets. This producer mentioned that quality is important but, since Peruvian pisco is not a positioned product, nobody knows the product in the market he is targeting.

¹⁰ Pisco producers with no distillation facilities can be granted certification as long as they prove that they use the services of a certified distillation plant.

Table 8. Reasons Why Technical Standards Are Beneficial

	Reasons why technical standards are beneficial				
	Improve quality of products	Improve product or process efficiency	Improve input provision	Open new market opportunities	Allows a better work with clients
Less than US\$ 33.3 thousand	3	3	2	3	3
Between US\$ 33.3 and 166.7 thousand	6	5	4	6	4
Between US\$ 166.7 and 833.3 thousand	1	1	1	0	1
Total	10	9	7	9	8

	Reasons why technical standards are beneficial				
	Improve quality of products	Improve product or process efficiency	Improve input provision	Open new market opportunities	Allows a better work with clients
Less than US\$ 33.3 thousand	3	3	2	3	3
Between US\$ 33.3 and 166.7 thousand	6	5	4	6	4
Between US\$ 166.7 and 833.3 thousand	1	1	1	0	1
Total	10	9	7	9	8

Source: Author's compilation.

5.2.5 Relationship of Firms and Other Actors

Surprisingly, nine out of 10 firms have a relationship with a university. As opposed to different production chains, universities have fostered links with firms and other pisco institutions such as CITEvid. Universities from Lima, such as the Agraria, San Martín de Porres and Cayetano Heredia are working in different areas to promote the diffusion of better agricultural practices, the normalization of pisco and genetic studies of pisco grapes. In addition, local universities in the Ica region are promoting better agricultural practices and are fostering links with CITEvid, such as an internship program for local students.

Only four firms, however, reported having a relationship with a technical training institution. Although the only training institution for the pisco and wine sector is located in the region of Moquegua, some firms have employees to that institute. This training institution, like CITEvid, has been set up by the Spanish Agency for Development Cooperation.

Seven firms reported belonging to a business association, usually the Association of Pisco Producers in Ica. Two of the largest firms in the sample belong to the Viticulture Committee at the National Society of Industries.

Finally, three firms reported participating in government programs such as Fondo Empleo (a fund that promotes projects that generate employment) and the Irrigation and

Technical Assistance Program, or PERAT (a program that promotes technologically upgraded irrigation).

5.3 Results for the Footwear Chain

5.3.1 Main Features of Interviewed Firms

The sample of shoe producers was composed of 18 firms. Table 9 shows the breakdown of firms by their sales revenues in 2008. There is a bias towards larger firms, because smaller ones were reluctant to be interviewed. Among the larger firms, there were producers of safety industrial shoes and rubber soles and textile (upper) shoes, whose production usually benefits from economies of scale.

Table 9. Sales Revenues in 2008 of Footwear Firms

2008 sales in US\$	Number of firms	Percentage (%)
Less than US\$ 33,3 thousand	3	15.8
Between US\$ 33.3 – 166.7 thousand	4	21.1
Between US\$ 166.7 – 833.3 thousand	7	36.7
More than US\$ 833.3 thousand	5	26.3
TOTAL	18	100

Source: Author's compilation.

Only 31.6 percent of the firms export their products, and sales to foreign markets represented only a small share of their output. Shoes for external markets must be resistant to heavy rain and difficult weather, and Peruvian shoes seldom meet that requirement. Exporting firms therefore use inputs that are different from those used for the domestic market (e.g., more resistant glue and waterproof soles).

Defining investments as expenditures that help upgrade production in different ways, Table 10 shows that 58 percent of firms invested in capital goods and 68 percent purchased CITEccal's services. Less common were hiring personnel with higher skills (37 percent) and executing organizational or marketing changes (26 percent). Expenditures vary notably by firm size. Smaller firms, for example, do not make expenditures in organizational and marketing changes, and larger firms generally hire personnel with higher skills than their smaller counterparts. The former might be reflecting that smaller firms are more concerned with

increasing production (i.e., purchasing capital goods) than increasing management or marketing efficiency, while the latter may indicate that larger firms value more highly skilled labor.

Table 10. Firms that Invested in 2008

Firms that invested in 2008				
	Purchase of capital goods	CITEccal's services	Hiring of personnel with higher skills	Organizational or marketing changes
Less than US\$ 33.3 thousand	2	1	1	0
Between US\$ 33.3 and 166.7 thousand	3	2	1	2
Between US\$ 166.7 and 833.3 thousand	3	5	2	1
More than US\$ 833.3 thousand	3	5	3	2
Total	11	13	7	5

Source: Author's compilation.

5.3.2 Innovation Behavior

Interviewed firms understood innovation as the introduction of improvements or new features in their products or their productive processes. The launch of a new shoe model, for example, is considered by these firms to be a product innovation, and the mechanization of steps in their processes is considered a process innovation. Most of the latter, however, involve the introduction of products or techniques long available in the Peruvian market. Only two firms reported filing a patent, which might indicate original innovation rather than upgrading.

According to this concept of innovation 94.7 percent of the firms were innovative, of which 88.9 percent undertook product innovations and 77.8 percent undertook process innovations.

Table 11 shows that the most prevalent innovation activities are R&D (14 out of 18 firms), the purchase of capital goods (13 out of 18) and training (11 out of 18). It is interesting to note that larger firms are more prone to engage in R&D and training. However, in most cases R&D must be understood as the routine search for new fashion trends and new inputs and capital equipment. Larger firms are the ones that pay for technology licensing, engineering and industrial design and consulting, which might be reflecting that larger firms used more sophisticated technology sources. In fact, these firms reported that they look for technology abroad in countries with more advanced leather and footwear industries like Brazil, Colombia and Mexico. These firms regularly attend fairs, buy both new and second-hand equipment abroad and hire foreign consultants. Finally, two medium firms (i.e., of more than 30 workers)

reported the importance of organizational changes. One has adopted ISO standards that have improved its practices in procuring materials and managing inventories and, of particular importance, establishing quality committees at various production steps that helped to reduce waste and minimize mistakes. The other firm reported that through a technical assistance program changed its plant layout and that reported in a more efficient production process.

Table 11. Innovation Activities Performed by Firms

	Innovation activities performed by firms						
	R&D	Technology licensing	Purchase of capital goods	Engineering and industrial design	Training	Consulting	Management changes
Less than US\$ 33.3 thousand	2	1	2	0	1	0	0
Between US\$ 33.3 and 166.7 thousand	3	0	4	1	2	1	0
Between US\$ 166.7 and 833.3 thousand	5	0	3	2	4	1	1
More than US\$ 833.3 thousand	4	2	4	3	4	2	1
Total	14	3	13	6	11	4	2

Source: Author's compilation.

With regards to innovation objectives, Figure 20 shows that 16 out of 18 firms reported that they innovate mainly to improve the quality of their products. This is not surprising since most of the shoe firms interviewed have experienced a similar growth pattern: they begin as very small firms with a limited product mix and while growing they buy equipment that allow them to increase their production and to improve the quality of their shoes. Firms also innovate to increase their current market share and to decrease input consumption (14 out of 18 firms, each). The former is not surprising since most firms just target the domestic market. The latter reflects the interest of improving production efficiency.

Figure 20. Degree of Importance of Innovation Objectives

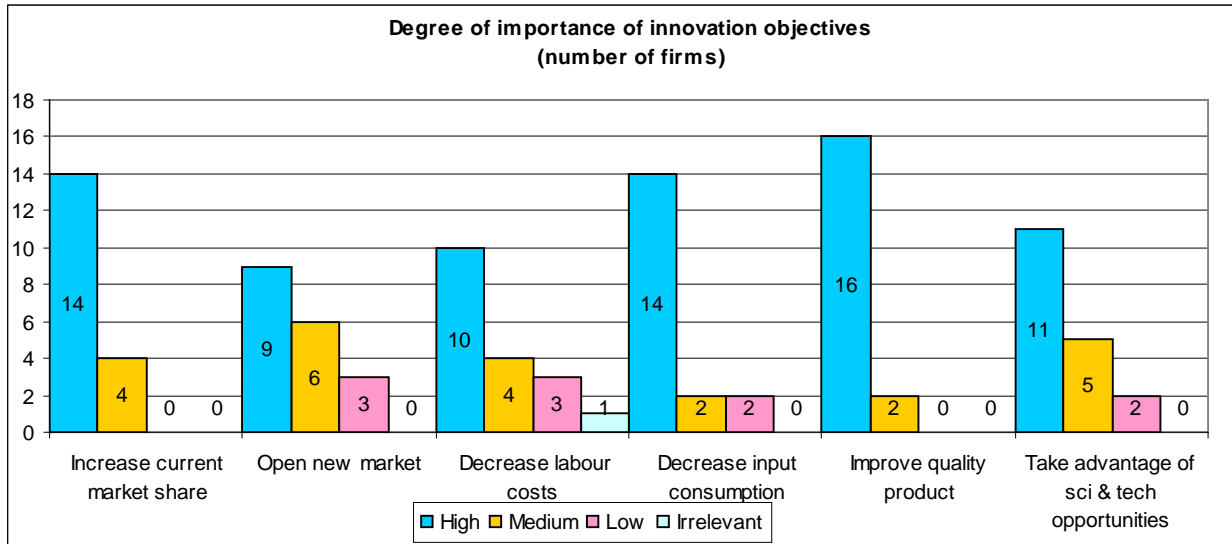

Source: Author's compilation.

With regards to innovation obstacles, Figure 21 shows that 17 out of 18 firms report that there is lack of technology development institutions. Although the vast majority of firms value CITEccal, they complained that there are not more such institutions. On the one hand, the smaller firms would like an institution that provides services for free and, on the other, the larger firms mentioned that they need more sophisticated services than those offered by CITEccal; some of the latter have looked for international technological institutions. The second most reported obstacle to innovation is the lack of technology information. Firms mentioned that sector institutions failed to provide the technology information they needed, including information on input providers. Smaller firms particularly noted that did they did not learn about materials that were new to them (if not the market) and new capital equipment. These firms mentioned that they have to look for providers instead of the other way around. The situation is similar for larger firms, but in this case firms go to international fairs to look for new technological advances. They also mentioned that there is a high degree of jealousy in the sector and that such information is not shared. The third obstacle mentioned by 11 firms, was low technological dynamism in the market; firms stated that the efforts to innovate are not rewarded by the market, which is driven by price competition. Some firms even mentioned that government asked for compliance with technical standards in its requests for bids but was unwilling to pay for that level of quality. Firms also complained about limited access to funding,

especially limited access to commercial loans for smaller firms, and the scarcity of skilled workers. The latter reflects a lack of training institutions in the leather and shoe industry, as firms say they prefer to hire people with no previous experience and train them in-house. Finally, smaller and medium firms mentioned that their market is very limited because they face stiff competition, especially from the informal sector.

Figure 21. Degree of Importance of Innovation Obstacles

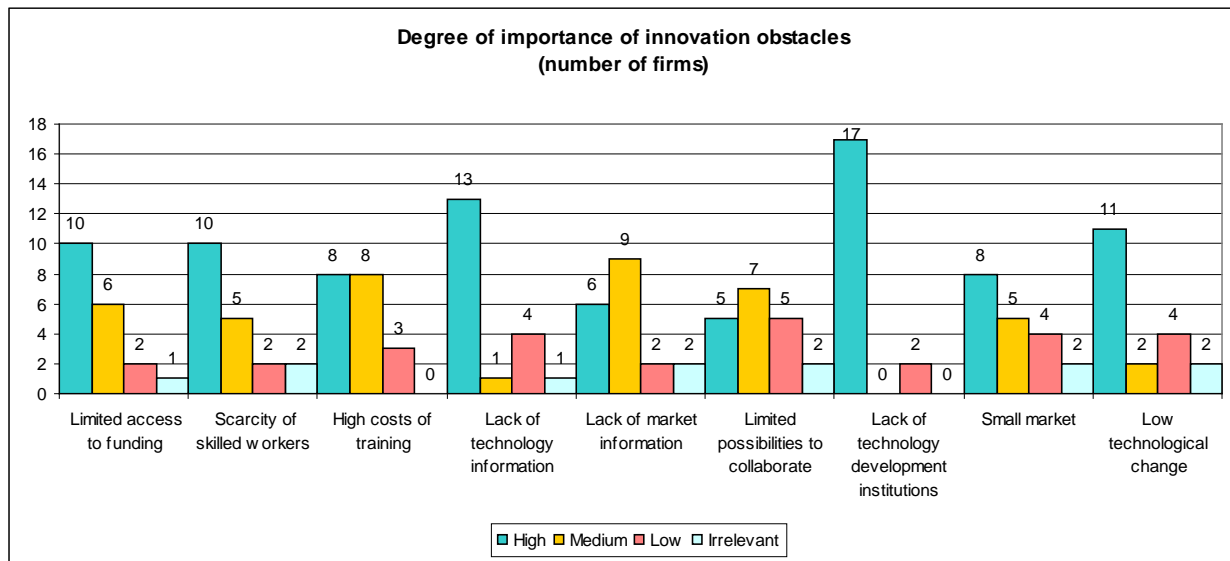

Source: Author's compilation.

Firms generally reported that they imitate other firms (16 out of 19), especially in products (13 out of 16) rather than in process (8 out of 16). Almost all mentioned, however, that they adapt imitations and that imitation is more common in the early stages of their business.

5.3.3 Relationship between Firms and CITEccal

The majority of firms reported that their relationship with CITEccal was beneficial (18 out of 19). They qualified its services as good (11 out of 19) or fair (7 out of 19). Only one firm rated the services as very good. The services used vary significantly according to firm size. Medium and large firms mentioned that they used CITEccal services when they were beginning the business in order to learn the basics. However, when firms grow and become more sophisticated, some CITEccal services are no longer useful for them; in particular, CITEccal's technological information is too basic for them. Another difference is that small firms request

services in fashion design, while larger firms report that they have their own sources of access to new designs such as the internet and specialized magazines. The latter complain that the CITEccal does not keep up with current fashion and cannot help firms that have to work in advance of the fashion seasons. Also, small firms demand more services related to training, while large firms report that they already have more knowledge than what CITEccal provides. Large firms do, however, demand laboratory services, testing both inputs and final products to ensure their quality. These services are heavily demanded by both producers and purchasing parties when firms participate in procurement bids.

Just over half of firms (10 out of 19) reported that CITEccal supported them in launching an innovation. Five of those firms mentioned that they had received technical information and participated in the institution’s training programs (see Figure 22), while two reported either participating in joint R&D with CITEccal or receiving the institution’s help in the purchase or sale of equipment. In fact, CITEccal organizes seminars or meetings in which equipment and input providers present their products. As shown in Figure 22, however, no firm reported using more sophisticated technology transfer modes such as joint technological development, licensing or technological alliances.

Figure 22. Technology Transfer Mode Received from CITEccal

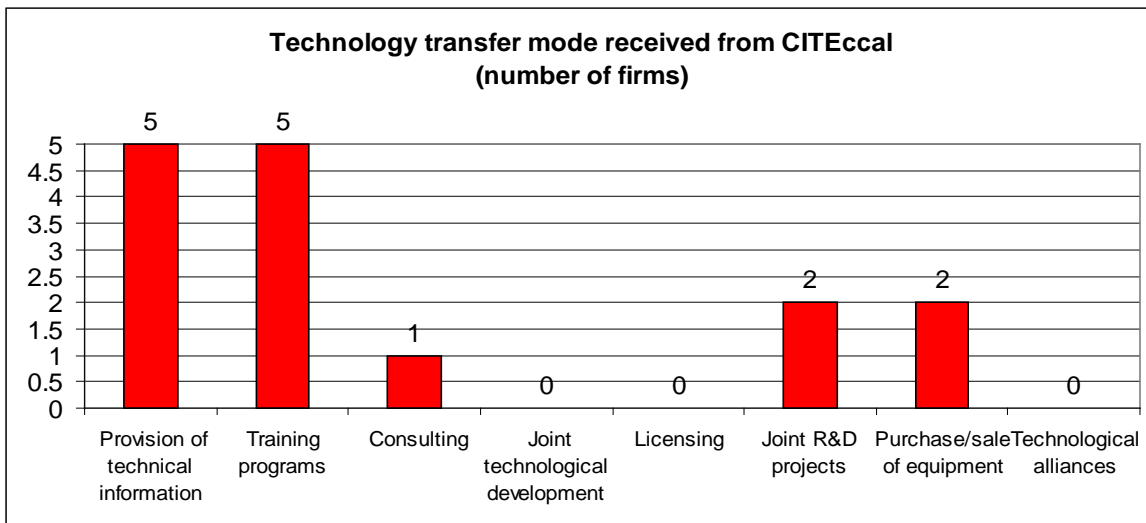

Source: Author’s compilation.

Figure 23 shows that firms viewed the most important impacts of CITEccal services as assistance with technical standards (11 out of 19) and improving the quality of their products or services (7 out of 19). It is noteworthy that the majority of firms do not perceive CITEccal as helping them to increase their sales (12), expand their market share (13), facilitate access to new markets (13) or improve the efficiency of their production processes. Firms viewed these results depend more on firms' general strategy than on their relationship with CITEccal.

Figure 23. Impact of CITEccal Services

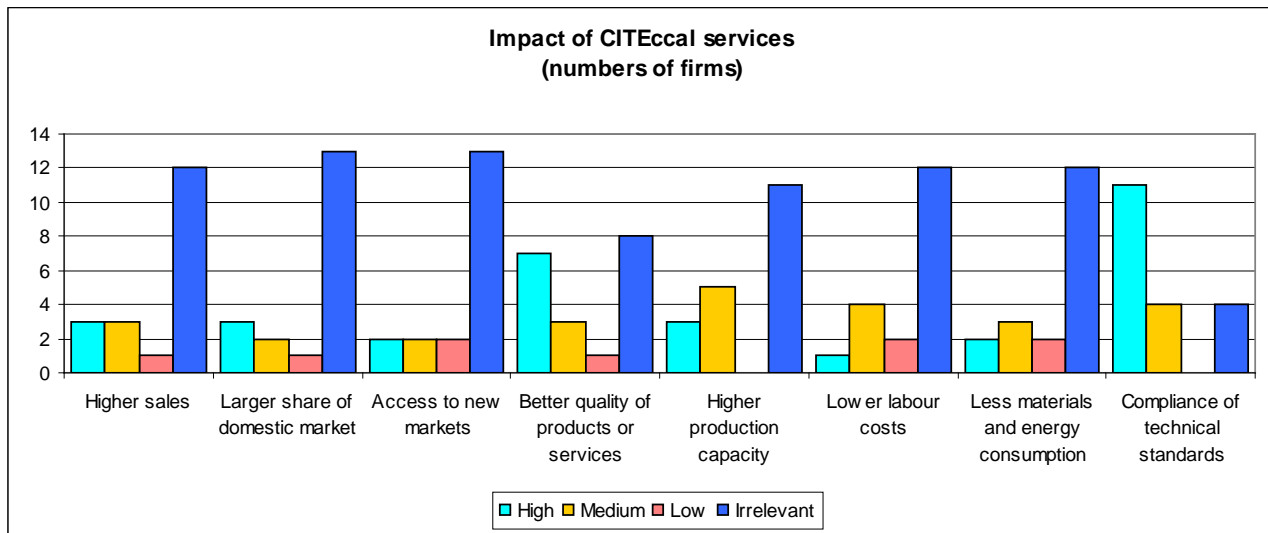

Source: Author's compilation.

While as a technological institution CITEccal should promote learning among clients, Figure 24 shows that most firms do not view CITEccal services as helping them increase their knowledge base (11 out of 19), incorporate experimentation as a routine activity within the firm (nine out of 19) or incorporate new procedures into their production processes. Although firms were introduced to the concept of learning, they do not appear to value continuous learning and are more concerned with day-to-day activities.

Figure 24. Effects of CITEccal Services on the Learning Process

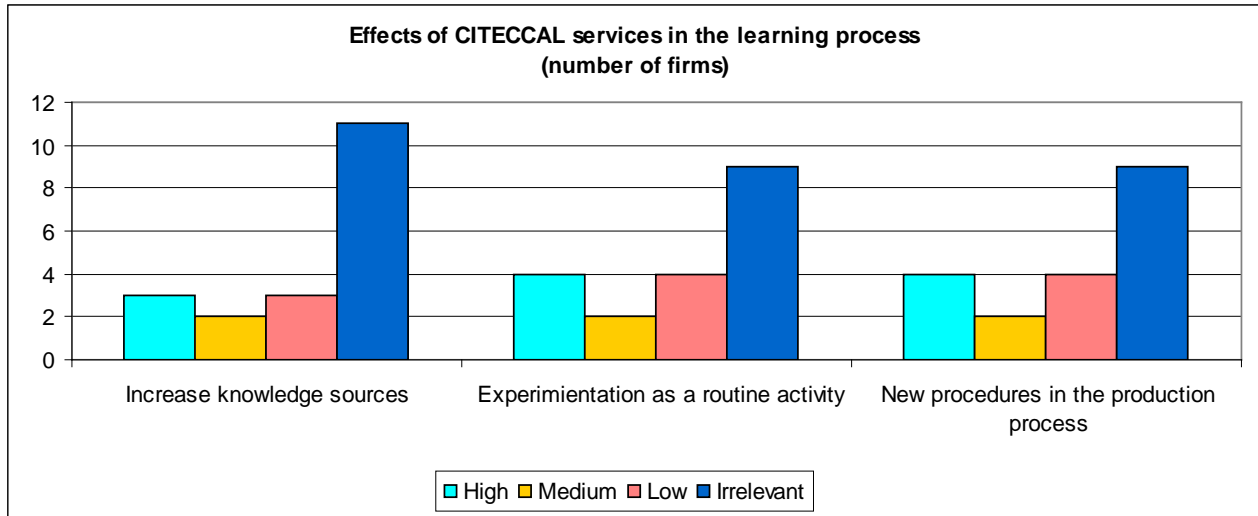

Source: Author's compilation.

5.3.4 Technical Standards

In the last decade, the leather and shoe industry has made great efforts to introduce technical standards to improve the quality of final products and inputs as well as improve coordination in the production chain. Firms generally viewed standards as beneficial for the sector (15 out of 19), and the vast majority report that they use them (17 out of 19); only six firms, however, reported having certification. The latter reflects the fact that technical standards are voluntary. While firms are not compelled to comply with the standard unless their clients require them to do so, most firms continue to apply them after initially adopting them. Lack of compliance with technical standards nonetheless remains widespread in the production chain. In fact, some firms mentioned that they had to test inputs because providers do not have certification, and then those firms have to test the final product. In the recent government procurement campaign (“A million school shoes”), very few producers were able to comply with the standards required for features including the quality of the upper leather, inner leather, laces, insoles, outsoles, and labels. In tests performed on a sample of 20 brands of school shoes, only one passed the abrasion resistance test, three passed the vamp flexion resistance test and two passed the sole flexion test (*El Comercio*, 2009).

As shown in Table 12, attitudes toward technical standards vary by firm size. Smaller firms, for instance did not value technical standards at all, viewing them as increasing costs and presenting a barrier to market access. This opinion may reflect the fact that small firms served

markets in which customers do not value quality but price. Most firms with sales larger than US\$ 33.3 thousand thought that technical standards improved the quality of products (13 out of 15) and help work better with clients (12 out of 15). Ten firms also stated that standards helped improve coordination in the production chain (improving product or process efficiency and improving input provision). Finally, nine of 15 firms state that standards open new market opportunities.

Table 12. Reasons Why Technical Standards Are Beneficial

	Reasons why technical standards are beneficial				
	Improve quality of products	Improve product or process efficiency	Improve input provision	Open new market opportunities	Allows a better work with clients
Less than US\$ 33.3 thousand	0	0	0	0	0
Between US\$ 33.3 and 166.7 thousand	3	3	3	2	4
Between US\$ 166.7 and 833.3 thousand	6	5	5	4	5
More than US\$ 833.3 thousand	4	2	2	3	3
Total	13	10	10	9	12

	Reasons why technical standards are beneficial				
	Improve quality of products	Improve product or process efficiency	Improve input provision	Open new market opportunities	Allows a better work with clients
Less than US\$ 33.3 thousand	0	0	0	0	0
Between US\$ 33.3 and 166.7 thousand	3	3	3	2	4
Between US\$ 166.7 and 833.3 thousand	6	5	5	4	5
More than US\$ 833.3 thousand	4	2	2	3	3
Total	13	10	10	9	12

Source: Author's compilation.

5.3.5 Relationship of Firms and Other Actors

The leather and footwear production chain is fragmented, and firms seldom cooperate commercially or technologically with each other. On the other hand, eight of the 19 firms reported having relationships with universities. Firms had links with the Universidad Nacional de Ingeniería, which offers lab services to test electricity conduction in safety shoes, and with the Universidad Católica, which also offers lab tests. Seven firms mentioned having links with training institutions such as SENATI,¹¹ which had a program to train technicians for the shoe industry, or other NGOs that offer training services. The relationship among firms was very

¹¹ SENATI is the National Service for Industrial Training.

weak. Only two firms reported relationships with other firms, and firms generally did not cooperate and tried to keep their knowledge away from others.

In other relationships, 10 of 19 firms reported belonging to a business association, especially the Leather and Shoe Committee of the National Society of Industries. In addition, seven firms reported their participation in government programs such as BonoPyME that provided subsidies for technical assistance and training. Firms used this subsidy to buy services from CITEccal.

6. Conclusions

This paper has analyzed the innovative behavior of the pisco and shoe production chains. Both production chains could be considered low or medium-technology industries and, in that sense, their innovative behavior would be focused towards the acquisition of embodied technology to improve productivity. In addition, they have the support of the Technological Innovation Centers (CITEvid and CITEccal), which have promoted the use of technical standards to improve the quality of their products and coordination within both production chains.

The pisco production chain has experienced a major recovery during the last 10 years. Production has tripled, and exports increased tenfold from 2004 to 2009. In addition, there has been a widespread improvement in quality, which has been recognized in international contests. The industry has also experienced some differentiation. There are now large integrated pisco and wine producers, specialized artisanal producers and artisanal/informal producers. To be certified as producers of Peruvian pisco, for which the government is seeking WIPO designation, they must meet the Peruvian Technical Standard in their industry.

The latter has likewise become an important coordination instrument within the shoe production chain, which has also experienced important growth. Exports have increased fivefold between 2000 and 2009, even though small producers (fewer than 10 workers) predominate in this production chain. Technical standards are defined for inputs and final products, but because of their voluntary nature they have had little impact on product quality.

The following sub-sections will describe the main findings of this paper and propose several policy recommendations.

6.1 Technological Change in the Pisco and Shoe Production Chains

Pisco production is a relative simple process that involves the distillation of young wine according to traditional principles to preserve quality. Technical standards have been defined to secure the quality of the spirit and to ease the recognition of a Peruvian pisco denomination of origin from WIPO. However, there is considerable room for technological improvement via the use of agricultural best practices, the use of different designated grape varieties and experimentation in different stages of the distillation process. Technological change via capital goods is limited, since this industry tries to preserve traditional production methods. However, efficiency gains can be obtained through the scale of equipment.

The definition of the technical standard has also contributed to creating a quality culture within the whole production chain that has put forward several initiatives such as the organization of different local and national competitions as well as the participation of universities to solve some of the problems found in this chain.

CITEvid, the technological institution that supports innovation and diffusion, has become a learning center and a specialized service provider (i.e. technological infrastructure) within this production chain. However, consolidated firms complain that CITEvid cannot offer the advanced technological services required to increase further the quality of pisco. For example, some producers mentioned that CITEvid lacks an oenologist capable of providing adequate organoleptic or product development services; this problem stems in part from financial limitations that prevent the hiring of highly skilled specialists.

In contrast to pisco, the footwear production is highly complex, involving a large number of production steps, input producers and service providers, and shoe producers complain about the bottlenecks in input provision. Several technical standards have been defined to secure quality levels and to improve coordination in the production chain, but they are voluntary rather than mandatory. As a result, there are very few input and shoe producers that fully comply with the established standards. Moreover, consumers do not value quality and prefer to buy cheap shoes.

Technological change in footwear is supplier dominated via the quality improvement of inputs (i.e., better glues, more resistant materials, etc.) and embodied technology. Firms follow a typical pattern of growth: they begin as small ventures and base their growth on acquisitions of equipment and efficiency improvements.

Although technical standards originally appeared as a non-tariff barrier to protect the domestic industry from Chinese imports, they have subsequently been used by the government in terms of reference for procurement. Technical standards are voluntary, however, and their diffusion within the production chain has been limited. They have therefore failed as means of coordination.

CITEccal is the main provider of technological services (i.e., technological infrastructure) for the shoe production chain, and it has served as a major promoter of technical standards. Its main clients are small firms that require modeling and grading patterns services. Medium and larger firms demand mostly lab services to test whether their shoes meet client requirements. These firms complain that CITEccal services are too basic for their needs and that this institution does not keep up with the advances in the leather and footwear industry at the international level.

6.2 Innovation Behavior

In the pisco production chain, firms innovate in both product and process. Product innovation takes the form of new pisco varieties. Although the technical standard establishes that pisco can be made from eight different grape varieties, most pisco is produced using quebranta grapes. Thus, firms have increased their product mix, incorporating other kinds of single-variety piscos as well as new blends (i.e., *acholados*) and *mosto verde* pisco elaborated with other grape varieties. Each of these new kinds of pisco has completely different organoleptic characteristics. Process innovation involves improvements in the agricultural management of vineyards and experimentation in the different stages of the distillation process. While there is not much room for radical innovation in capital equipment, since only three types of stills are included in the technical standards, some incremental innovations can be pursued.

The predominant innovation activities performed by firms are the purchase of capital equipment and internal R&D. Firms may begin producing pisco by purchasing distillation services from third parties such as CITEvid or private cellars, but as they grow they will buy their own equipment. Firms innovate primarily to increase the quality of their pisco, because domestic and foreign markets are willing to pay for those innovations. However, there is little information about new markets, and firms may encounter difficulties in selling their high-quality pisco. Also, as firms become more sophisticated they find it difficult to obtain technological

services. There is wide diffusion of process innovation, however, as firms report that they imitate specific practices from their competitors' production processes.

In the shoe production chain, firms also innovate in product and process. Product innovation is understood as the design of new shoe models, and firms are devoted to this activity on a permanent basis. As process innovation usually involves mechanization of operations, the purchase of capital equipment is the main innovation activity in the production chain. In this production chain, R&D involves the continuous search for fashion trends and new inputs, materials and capital equipments. Medium and large firms try to visit on a regular basis specialized fairs in countries with advanced leather and shoe industries.

Shoe-producing firms innovate mainly to improve the quality of their products, but also to increase their market share and decrease input consumption. Improving production efficiency is also a common objective among firms. The lack of technological information and development institutions to deliver it are the main innovation obstacles in this industry, and firms also complained that the market does not reward their innovation efforts.

6.3 Relationship between Firms and their Respective CITEs

In both production chains, the CITEs play an important role in diffusing technological information. However, as firms grow and begin demanding more sophisticated technological services, the CITEs cannot meet their demands. This has to do with insufficient funds to upgrade the CITEs' services and to hire high skill personnel.

The most common technology transfer modes used by CITE's clients in both production chain are the provision of technical information and training programs. It is interesting that in the pisco chain, firms also demand consulting services more than in the shoe chain.

The main impact of the CITEs services in both production chains is an increase in product quality and compliance with technical norms. Pisco firms reported positive effects on sales and market share, while shoe firms considered changes in those areas to depend more on the general strategy of their firms.

CITEvid has had a clear impact on learning processes in pisco, as firms reported that they have incorporated experimentation into their business as a routine activity. Shoe firms, on the other hand, seem not to value continuous learning or appear to be more concerned with day-to-day activities.

6.4 Technical Standards

As mentioned before, technical standards have different roles in these two production chains. In the pisco chain, those standards define the final product and there is a clear incentive to become a certified pisco producer: it can get higher prices for its product and can get access to new markets. In the shoe chain, technical standards are voluntary throughout the production chain, and the market does not value quality. Thus shoe producers are not willing to comply with the standard unless their clients require them to do so.

6.5 Relationship of Firms and Other Actors

There is a marked difference in the way firms related to other actors in these two production chains. In the pisco production chain, firms seem to relate closely to institutions that generate knowledge. They report establishing relationships with universities and a specialized technical training institution. On their side, local universities and some of the most important ones in Lima are also interested in establishing ties with other actors in the production chain and in conducting applied research. Pisco firms additionally report being affiliated with local business associations.

In contrast, the shoe production chain is fragmented. Firms' relationship with universities mainly involves purchasing lab tests, and universities do not seem interested in this industry's production chain. About half of shoe-producing firms report affiliation with a business association.

6.6 Policy Recommendations

There are few policy recommendations with regards to promoting technological change and innovation in the pisco and shoe production chains. However, several basic ideas need to be reinforced.

First, technological change and innovation are means of increasing productivity and promoting business growth. In that sense, the most important policy recommendation is to secure a stable economic environment that eases private investment as well as eliminate market barriers in factors markets. This includes eliminating import barriers for capital equipment, the purchase of which represents one of the most important innovation activities in low and medium-technology industries. Efforts to eliminate informality are also important so that innovative firms can face fair competition.

Second, innovation requires skilled human resources at all levels. In low and medium technology industries, incremental innovation most frequently happens in the workshop, and the presence of skilled workers makes such innovation more likely. When a firm buys new capital equipment, moreover, workers would be able to operate it. Training institutions should therefore be included in any innovation promotion policy.

Third, technological change and innovation cannot be successfully promoted if the market does not value them. Thus, technological support institutions should be created taking into account the demand that firms face, which would define firms' technological demands and their willingness to pay for those institutions' services.

Fourth, it should be remembered that firms of different size or that target different markets differ in their technological demands. Thus, different strategies to provide technological services should be used. For example, the provision of basic technological information, including information on input and equipment providers, could be delivered by extension programs in locations with firm agglomerations. On the other hand, medium and large firms may better benefit from technology support institutions like the CITEs. These institutions, however, need to upgrade of the technological services they provide.

Fifth, technical standards are important policy instruments to upgrade the quality of products and to act as a coordination mechanism. However, their implementation needs to be supported by technological infrastructure and a regulation system that eases its compliance. This does not mean necessarily that all technical standards should be compulsory instead of voluntary, but it will help if some standards related to, for example, safety should be obligatory and the institutional setting to secure its compliance is set up.

Sixth, government procurement has proved to be a good mechanism to encourage firms to implement technical standards. However, government institutions should be willing to pay for the higher quality they are asking for.

Finally, knowledge creation institutions, such as universities, should have a critical role in promoting innovation. Collaboration with technological support institutions should be reinforced and, if possible, a common research and promotion agenda should be developed having in mind the demands of firms. The pisco chain is showing that this kind of collaboration is possible to achieve.

References

- Blind, K. 2004. *The Economics of Standards: Theory, Evidence and Policy*. Cheltenham, United Kingdom: Edward Elgar Publishing.
- Centro de Innovación Tecnológica Vitivinícola (CITEvid). 2004. *La Uva y el Pisco: Potencialidades Productivas*. Lima, Peru: CITEvid/United Nations Development Programme.
- El Comercio*. 2009. “Calzado Escolar: Baja Nota en Calidad.” 2 de mayo.
- Heidenreich, M. 2009. “Innovation Patterns and Location of European Low- and Medium-Technology Industries.” *Research Policy* 38: 483-494.
- Ministerio de Industrias, Turismo, Integración y Negociaciones Comerciales Internacionales (MITINCI). 1998. *La Industria del Cuero y el Calzado en el Perú: Innovando para Competir*. Serie Cadenas Productivas. Lima, Peru: MITINCI.
- Mody, A. et al. 1991. “International Competition in the Footwear Industry: Keeping Pace with Technological Change.” Industry Series Paper 51. Washington, DC, United States: World Bank.
- Pavitt, K. 1984. “Sectoral Patterns of Technical Change: Towards a Taxonomy and Theory.” *Research Policy* 23: 533-545.
- Pisco Conqueror. 2009. “How We Make Pisco.” <http://www.piscoconqueror.com/INDEX.swf>
- Robertson, P., K. Smith and N. von Tunzelmann. 2009. “Innovation in Low- and Medium-Technology industries.” *Research Policy* 38: 441-446.
- Santamaría, L., M.J. Nieto and A. Barge-Gil. 2009. “Beyond Formal R&D: Taking Advantage of Other Sources of Innovation in Low- and Medium-Technology Industries.” *Research Policy* 38: 507-517.

Annex 1.

CUESTIONARIO PARA CLIENTES DE CITEVID

A. Datos generales de la empresa:

Nombre o razón social de la empresa: _____ RUC: _____
Dirección: _____ Provincia: _____ Distrito: _____
Teléfono: _____ E-mail: _____ Web: _____
Persona de contacto a quien dirigirse para consultas o aclaraciones de este cuestionario:

Sr. / Sra.: _____
Cargo que ocupa en la empresa: _____
Teléfono: _____ E-mail: _____

B. Características de la empresa:

1. Actividad económica: _____
2. Año de inicio de actividades de la empresa: _____
3. Tipos de vinos elaborados: _____
4. Número de litros elaboradas por mes: _____

5. Incidencias en el año 2008:

5.1 Nivel de ventas: Marcar con X

Menos de 100 mil soles	<input type="checkbox"/>
De 100 mil soles hasta 500 mil soles	<input type="checkbox"/>
De 500 mil soles hasta 2.5 millones de soles	<input type="checkbox"/>
Más de 2.5 millones de soles	<input type="checkbox"/>

5.2 De la cifra anterior indique el porcentaje de exportaciones:

5.3 Principales mercados de exportación: _____

5.4 Número total de empleados:

1 a 10 trabajadores	<input type="checkbox"/>
10 a 50 trabajadores	<input type="checkbox"/>
50 a más trabajadores	<input type="checkbox"/>

5.5 De la cifra anterior cuantos tienen educación superior:

5.6 Inversiones realizadas como consecuencia del trabajo con CITEVID:

	Montos
Compra de equipos	S/.
Contratación de servicios a CITEVID	S/.
Contratación de personal más capacitado	S/.
Cambios organizacionales o de comercialización	S/.

5.7 ¿Formó su empresa parte de un grupo empresarial?

SI NO ⇒ Pase al punto 5.8

5.7.1 Indique el nombre del grupo empresarial:

_____ ↓

5.8 Ha sido cliente de CITEVID:

SI NO ⇒ Pase al apartado D

C. Trabajo con CITEVID:

1. ¿Desde cuándo solicita los servicios de CITEVID?

_____ →

2. Frecuencia de uso de servicio en el 2008:

Tipo de servicio

Área Enológica

- Servicios de laboratorio
- Análisis físico químicos
- Análisis microbiológicos
- Ensayos de clarificación
- Tratamientos especiales
- Investigación y desarrollo de nuevos productos
- Análisis organoléptico
- Servicios de diseño
- Servicios de asesoría
- Servicios de Capacitación
- Servicios de asistencia técnica
- Servicios de información
- Servicios de certificación
- Servicios de bodega

Área vitícola

- Servicios de laboratorio
- Servicios de Diseño
- Capacitación
- Asistencia técnica
- Servicios de información
- Servicios de venta de Material Digital

Marque los servicios solicitados

D. Innovación y difusión:

* Una innovación es la introducción de un producto (bien o servicio), un proceso, un método de comercialización o un método organizativo nuevo, o significativamente mejorado, en la empresa (no necesariamente nuevo en el mercado).

* Las principales actividades de innovación son:

Investigación y desarrollo: Es el trabajo creativo realizado en forma sistemática, es decir no ocasional, con el objetivo de generar un nuevo conocimiento (científico o técnico), o aprovechar y aplicar un conocimiento ya existente desarrollado por otro.

Adquisición de bienes de capital, hardware o software: Son actividades de innovación únicamente cuando se trate de la incorporación de bienes vinculados a introducir mejoras o innovaciones de procesos, productos o técnicas organizacionales o de comercialización. El reemplazo de una máquina por otra de similares características o una nueva versión de software ya instalado no implica una actividad de innovación.

Contratación de tecnología: Adquisición de derechos de uso patentes, inventos no patentados, licencias, marcas, diseños, know-how o asistencia técnica vinculada a introducir mejoras o innovaciones en procesos, productos, técnicas organizacionales o de comercialización.

Ingeniería y diseño industrial: Preparaciones técnicas para la producción y distribución no incluidas en I+D, así como los planos y gráficos para la definición de procedimientos, especificaciones técnicas y características operativas; instalación de maquinaria; ingeniería industrial; y puesta en marcha de la producción. La ingeniería y diseño industrial a diferencia de la I y D abarca las soluciones de problemas técnicos y no la creación, desarrollo o aplicación de un nuevo conocimiento.

Gestión: Generación, adaptación y aplicación de nuevas técnicas que permitan una mejor articulación de los esfuerzos de cada área de la empresa o que permitan alcanzar los objetivos fijados por la empresa de forma más eficiente.

Capacitación: Representa una innovación siempre que no implique capacitar a nuevos trabajadores en métodos, procesos o técnicas ya existentes en la empresa.

Consultoría: contratación de servicios científicos y técnicos relacionados con las actividades de Ingeniería y Diseño Industrial o Gestión a terceros externos a la empresa.

1. ¿Realiza actividades de innovación?

SI		NO		⇒	Pase al apartado F
↓					
Producto		Proceso			

2. La innovación es en:

3. Actividades de Innovación realizadas en los dos últimos años:

Actividades de innovación	Inversión	Financiamiento (1)	Descripción de la innovación
I y D interna	S/.		
Contratación tecnológica	S/.		
Compra de bienes de capital (maquinas, equipos, hardware, software)	S/.		
Ingeniería y diseño industrial	S/.		
Capacitación Otros	S/.		
Consultoría	S/.		

(1) Las fuentes de financiamiento son:

RP=Recursos propios

GB=Gobierno

EPU=Empresas públicas

EPR=Empresas privadas

ES= Educación superior

IPSFL= Institución privada sin fines de lucro

EEX= Empresa extranjera

OEX= Organizaciones o instituciones extranjeras

4. Señale si efectivamente se dio un nuevo o mejorado producto o proceso

SI NO

5. Señale cuál es el grado de importancia para su empresa los siguientes objetivos de la innovación:

- Ampliar el mercado actual
- Abrir un nuevo mercado
- Reducción de costos de mano de obra
- Reducción de consumo de materiales
- Mejorar la calidad del producto
- Aprovechamiento de oportunidades de conocimiento científico y tecnológico nuevos

	Alta	Media	Baja	Irrelevante

6. Obstáculos a la innovación:

- Factores de Costos**
 - Dificultad para acceder al financiamiento
 - Escasez de personal calificado
 - Coste elevado de capacitación
- Conocimiento**
 - Falta de información sobre tecnologías
 - Falta de información sobre mercados
 - Escasas posibilidades de cooperar con otras empresas o instituciones
 - Falta de instituciones que impulsen el desarrollo tecnológico
- Mercado**
 - Reducido tamaño de mercado
 - Escaso dinamismo del cambio tecnológico del sector
- otros** _____

	Alta	Media	Baja	Irrelevante

7. ¿Ha replicado alguna innovación en base a la experiencia de otra empresa?

SI NO

7.1 La innovación replicada fue en:

Producto Proceso

7.1.2 Especifique la innovación:

7.2 ¿Alguna institución o agente apoyó esta innovación?

E. Apoyo de CITEVID en el desarrollo e implementación de innovaciones en las empresas:
Si no es cliente de CITEVID pase al apartado F

1. ¿Apoyó CITEVID en la implementación de la innovación?

SI

NO

Pase al punto
3

1.1 Detalle la innovación específica apoyada por CITEVID :



2. Señale la modalidad de transferencia tecnológica



- Provisión de información técnica especializada
- Programas de capacitación; cooperación en la formación de recursos humanos
- Consultoría especializada
- Desarrollo tecnológico conjunto
- Licenciamiento y cesión de patentes
- Proyectos conjuntos de I+D
- Compra/venta de bienes de equipo
- Alianzas tecnológicas

3. Financiamiento de los servicios de CITEVID

Monto de pagos para el año 2008

Monto en soles

S/.

Participación del total (%)

- Pago directo con recursos de la empresa
- Uso de bonos o instrumentos de promoción industrial
- Detalle cuáles son los instrumentos

4. Señale los efectos en los resultados de las empresas

- Mayores ventas
- Mayor cuota de mercado nacional
- Ingreso a nuevos mercados a través de la exportación
- Mejor calidad del bien o servicio brindado
- Mayor capacidad de producción
- Menores costos laborales por unidad producida
- Menos materiales y energía por unidad producida
- Cumplimiento de requisitos normativos

Grado de importancia

Alta	Media	Baja	Irrelevante

5. Señale los efectos en el proceso de aprendizaje

- Ampliación en fuentes de conocimiento
- Experimentación como actividad frecuente en la empresa
- Incorporación de nuevos procedimientos en el proceso de producción

Grado de importancia

Alta	Media	Baja	Irrelevante

6. Considera que CITEVID ha sido beneficiosa para su empresa SI NO

7. ¿Cómo calificaría los servicios de CITEVID?

Muy bueno	
Bueno	
Regular	
Malo	

8. ¿Tiene alguna sugerencia?

F. Percepción de normas técnicas:

1. ¿Hace uso de normas técnicas?

SI, y cuento con la certificación respectiva de su cumplimiento		
SI, pero no cuento con su certificación		Señale las normas: _____
NO hago uso de normas técnicas		Señale el motivo: _____

2. Considera que las normas técnicas son beneficiosas : SI NO ⇒ Pase al punto 2.2

↓
Pase al punto 2.1

2.1 SI, porque...

Mejora la calidad	
Mejora la eficiencia en producto o en proceso	
Mejora la provisión de insumos	
Abre oportunidades de mercado	
Permite un mejor trabajo con clientes	
Otros: _____	

2.2 NO, porque...

Acarrea mayores costos	
Requiere la contratación de otros servicios	
Disminuye la creación de nuevos productos	
Otros : _____	

G. Relaciones con otros actores:

1. Indique con qué agentes ha tenido relación en el desarrollo de las actividades de innovación:

- Universidades
- Institutos de formación técnica
- Otras empresas
- Centros de investigación
- Organismos públicos
- Otros: _____

2. ¿Pertenece a alguna asociación o gremio?

SI NO ⇒

↓

Pase al punto 3

2.1 Indique cuál:

SI NO ⇒

↓

Pase al punto 4

3 ¿Participa de otros programas estatales?

3.1 Indique cuál:

4. ¿El trabajo con CITEVID le ha permitido conocer e interactuar con otros productores de la rama industrial del calzado consiguiendo?

- Mejorar oportunidades de negocios
- Iniciar colaboración
- Aumentar confianza
- Mejorar relaciones con proveedores
- Mejorar relaciones con clientes

Otros: _____

Annex 2
CUESTIONARIO PARA CLIENTES DE CITECCAL

A. Datos generales de la empresa:

Nombre o razón social de la empresa: _____ RUC: _____

Dirección: _____ Provincia: _____ Distrito: _____

Teléfono: _____ E-mail: _____ Web: _____

Persona de contacto a quien dirigirse para consultas o aclaraciones de este cuestionario:

Sr. / Sra.: _____

Cargo que ocupa en la empresa: _____

Teléfono: _____ E-mail: _____

B. Características de la empresa:

1. Actividad económica: _____

2. Año de inicio de actividades de la empresa: _____

3. Tipos de calzado elaborados: _____

4. Número de pares de zapatos elaborados por mes: _____

5. Incidencias en el año 2008:

5.1 Nivel de ventas:

Menos de 100 mil soles

De 100 mil soles hasta 500 mil soles

De 500 mil soles hasta 2.5 millones de soles

Más de 2.5 millones de soles

Marcar con X

5.2 De la cifra anterior indique el porcentaje de exportaciones:

--

5.3 Principales 3 mercados de exportación:

5.4 Número total de empleados:

1 a 10 trabajadores

10 a 50 trabajadores

50 a más trabajadores

5.5 De la cifra anterior cuantos tienen educación superior:

--

5.6 Inversiones realizadas:

Compra de equipos

Contratación de servicios a CITECCAL

Contratación de personal más capacitado

Cambios organizacionales o de comercialización

Montos en soles

S/.
S/.
S/.
S/.

5.7 ¿Formó su empresa parte de un grupo empresarial?

SI

NO



Pase al punto 5.8

5.7.1 Indique el nombre del grupo empresarial:

5.8 Ha sido cliente de CITECCAL:

SI

NO

Pase al apartado D

C. Trabajo con CITECCAL:

1. ¿Desde cuándo solicita los servicios de CITECCAL?

2. Uso de servicio en el 2008:

Tipo de servicio

Laboratorio

Taller de diseño

Capacitación: cursos, talleres, seminarios

Asistencia técnica

Centro de documentación

Marque los servicios solicitados



D. Innovación y difusión:

* Una innovación es la introducción de un producto (bien o servicio), un proceso, un método de comercialización o un método organizativo nuevo, o significativamente mejorado, en la empresa (no necesariamente nuevo en el mercado).

* Las principales actividades de innovación son:

Investigación y desarrollo: Es el trabajo creativo realizado en forma sistemática, es decir no ocasional, con el objetivo de generar un nuevo conocimiento (científico o técnico), o aprovechar y aplicar un conocimiento ya existente desarrollado por otro.

Adquisición de bienes de capital, hardware o software: Son actividades de innovación únicamente cuando se trate de la incorporación de bienes vinculados a introducir mejoras o innovaciones de procesos, productos o técnicas organizacionales o de comercialización. El reemplazo de una máquina por otra de similares características o una nueva versión de software ya instalado no implica una actividad de innovación.

Contratación de tecnología: Adquisición de derechos de uso patentes, inventos no patentados, licencias, marcas, diseños, know-how o asistencia técnica vinculada a introducir mejoras o innovaciones en procesos, productos, técnicas organizacionales o de comercialización.

Ingeniería y diseño industrial: Preparaciones técnicas para la producción y distribución no incluidas en I+D, así como los planos y gráficos para la definición de procedimientos, especificaciones técnicas y características operativas; instalación de maquinaria; ingeniería industrial; y puesta en marcha de la producción. La ingeniería y diseño industrial a diferencia de la I y D abarca las soluciones de problemas técnicos y no la creación, desarrollo o aplicación de un nuevo conocimiento.

Gestión: Generación, adaptación y aplicación de nuevas técnicas que permitan una mejor articulación de los esfuerzos de cada área de la empresa o que permitan alcanzar los objetivos fijados por la empresa de forma más eficiente.

Capacitación: Representa una innovación siempre que no implique capacitar a nuevos trabajadores en métodos, procesos o técnicas ya existentes en la empresa.

Consultoría: contratación de servicios científicos y técnicos relacionados con las actividades de Ingeniería y Diseño Industrial o Gestión a terceros externos a la empresa.

1. ¿Realiza actividades de innovación?

SI NO ⇒ Pase al apartado F

↓

Producto Proceso

2. La innovación es en:

3. Actividades de Innovación realizadas en los dos últimos años:

Actividades de innovación	Inversión en soles	Financiamiento (1)	Descripción de la innovación
I y D interna	S/.		
Contratación tecnológica	S/.		
Compra de bienes de capital (maquinas, equipos, hardware, software)	S/.		
Ingeniería y diseño industrial	S/.		
Capacitación Otros	S/.		
Consultoría	S/.		

(2) Las fuentes de financiamiento son:

RP=Recursos propios

GB=Gobierno (fondos de innovación)

EPU=Empresas públicas

EPR=Empresas privadas

ES= Educación superior

IPSFL= Institución privada sin fines de lucro

EEX= Empresa extranjera

OEX= Organizaciones o instituciones extranjeras

4. Señale si efectivamente se dio un nuevo o mejorado producto o proceso

SI NO

5. Señale cuál es el grado de importancia para su empresa los siguientes objetivos de la innovación:

- Ampliar el mercado actual
- Abrir un nuevo mercado
- Reducción de costos de mano de obra
- Reducción de consumo de materiales
- Mejorar la calidad del producto
- Aprovechamiento de oportunidades de conocimiento científico y tecnológico nuevos

Alta	Media	Baja	Irrelevante

6. Obstáculos a la innovación:

- Factores de Costos**
 - Dificultad para acceder al financiamiento
 - Escasez de personal calificado
 - Coste elevado de capacitación
- Conocimiento**
 - Falta de información sobre tecnologías
 - Falta de información sobre mercados
 - Escasas posibilidades de cooperar con otras empresas o instituciones
 - Falta de instituciones que impulsen el desarrollo tecnológico
- Mercado**
 - Reducido tamaño de mercado
 - Escaso dinamismo del cambio tecnológico del sector
- otros** _____

Alta	Media	Baja	Irrelevante

7. ¿Ha replicado alguna innovación en base a la experiencia de otra empresa?

SI NO

7.1 La innovación replicada fue en:

Producto Proceso

7.1.2 Especifique la innovación:

7.2 ¿Alguna institución o agente apoyó esta innovación?

E. Apoyo de CITECCAL en el desarrollo e implementación de innovaciones en las empresas:

Si no es cliente de CITECCAL pase al apartado F

1. ¿Apoyó CITECCAL en la implementación de una o más innovaciones?

SI
↓

NO



Pase al punto 3

1.1 Detalle la innovación específica apoyada por CITECCAL :

2. Señale la modalidad de transferencia tecnológica

- Provisión de información técnica especializada
- Programas de capacitación; cooperación en la formación de recursos humanos
- Consultoría especializada
- Desarrollo tecnológico conjunto
- Licenciamiento y cesión de patentes
- Proyectos conjuntos de I+D.
- Compra/venta de bienes de equipo.
- Alianzas tecnológicas

3. Financiamiento de los servicios de CITECCAL

Monto de pagos para el año 2008

Monto en soles

Pago directo con recursos de la empresa

Uso de bonos o instrumentos de promoción industrial

Detalle cuáles son los instrumentos

Participación del total (%)

4. ¿Qué impacto ha tenido el uso de los servicios de CITECCAL en su empresa?

- Mayores ventas
- Mayor cuota de mercado nacional
- Ingreso a nuevos mercados a través de la exportación
- Mejor calidad del bien o servicio brindado
- Mayor capacidad de producción
- Menores costos laborales por unidad producida
- Menos materiales y energía por unidad producida
- Cumplimiento de requisitos normativos

	Grado de importancia			
	Alta	Media	Baja	Irrelevante

5. Señale los efectos en el proceso de aprendizaje

- Ampliación en fuentes de conocimiento
- Experimentación como actividad frecuente en la empresa
- Incorporación de nuevos procedimientos en el proceso de producción

	Grado de importancia			
	Alta	Media	Baja	Irrelevante

6. Considera que CITECCAL ha sido beneficiosa para su empresa
 SI NO

7. ¿Cómo calificaría los servicios de CITECCAL?

Muy bueno	<input type="checkbox"/>
Bueno	<input type="checkbox"/>
Regular	<input type="checkbox"/>
Malo	<input type="checkbox"/>

8. ¿Tiene alguna sugerencia?

F. Percepción de normas técnicas:

1. ¿Hace uso de normas técnicas?

SI, y cuento con la certificación respectiva de su cumplimiento	<input type="checkbox"/>	Señale las normas: _____
SI, pero no cuento con su certificación	<input type="checkbox"/>	Señale el motivo: _____
NO hago uso de normas técnicas	<input type="checkbox"/>	

2. Considera que las normas técnicas son beneficiosas :
 SI NO ⇒ Pase al punto 2.2
 ↓
 Pase al punto 2.1

2.1 SI, porque...

Mejora la calidad	<input type="checkbox"/>
Mejora la eficiencia en producto o en proceso	<input type="checkbox"/>
Mejora la provisión de insumos	<input type="checkbox"/>
Abre oportunidades de mercado	<input type="checkbox"/>
Permite un mejor trabajo con clientes	<input type="checkbox"/>
Otros: _____	<input type="checkbox"/>

2.2 NO, porque...

Acarrea mayores costos	<input type="checkbox"/>
Requiere la contratación de otros servicios	<input type="checkbox"/>
Disminuye la creación de nuevos productos	<input type="checkbox"/>
Otros : _____	<input type="checkbox"/>
	<input type="checkbox"/>

G. Relaciones con otros actores:

1. Indique con qué agentes ha tenido relación en el desarrollo de las actividades de innovación:

Universidades
Institutos de formación técnica
Otras empresas
Centros de investigación
Organismos públicos
Otros: _____

2. ¿Pertenece a alguna asociación o gremio?

SI NO ⇒

↓

Pase al punto 3

2.1 Indique cuál:

SI NO ⇒

↓

Pase al punto 4

3 ¿Participa de otros programas estatales?

3.1 Indique cuál:

4. ¿El trabajo con CITECCAL le ha permitido conocer e interactuar con otros productores de la rama industrial del calzado consiguiendo?

Mejorar oportunidades de negocios
Iniciar colaboración
Aumentar confianza
Mejorar relaciones con proveedores
Mejorar relaciones con clientes

Otros: _____