

Böhringer, Christoph; Alexeeva-Talebi, Victoria

**Working Paper**

## Unilateral climate policy and competitiveness: The implications of differential emission pricing

Wirtschaftswissenschaftliche Diskussionspapiere, No. V-338-11

**Provided in Cooperation with:**

University of Oldenburg, Department of Economics

*Suggested Citation:* Böhringer, Christoph; Alexeeva-Talebi, Victoria (2011) : Unilateral climate policy and competitiveness: The implications of differential emission pricing, Wirtschaftswissenschaftliche Diskussionspapiere, No. V-338-11, University of Oldenburg, Department of Economics, Oldenburg

This Version is available at:

<https://hdl.handle.net/10419/105022>

**Standard-Nutzungsbedingungen:**

Die Dokumente auf EconStor dürfen zu eigenen wissenschaftlichen Zwecken und zum Privatgebrauch gespeichert und kopiert werden.

Sie dürfen die Dokumente nicht für öffentliche oder kommerzielle Zwecke vervielfältigen, öffentlich ausstellen, öffentlich zugänglich machen, vertreiben oder anderweitig nutzen.

Sofern die Verfasser die Dokumente unter Open-Content-Lizenzen (insbesondere CC-Lizenzen) zur Verfügung gestellt haben sollten, gelten abweichend von diesen Nutzungsbedingungen die in der dort genannten Lizenz gewährten Nutzungsrechte.

**Terms of use:**

*Documents in EconStor may be saved and copied for your personal and scholarly purposes.*

*You are not to copy documents for public or commercial purposes, to exhibit the documents publicly, to make them publicly available on the internet, or to distribute or otherwise use the documents in public.*

*If the documents have been made available under an Open Content Licence (especially Creative Commons Licences), you may exercise further usage rights as specified in the indicated licence.*

# Wirtschaftswissenschaftliche Diskussionspapiere

## **Unilateral climate policy and competitiveness: The implications of differential emission pricing**

Christoph Böhringer and Victoria Alexeeva-Talebi

V – 338 – 11

June 2011

**Unilateral climate policy and competitiveness:  
The implications of differential emission pricing**

Christoph Böhringer<sup>a</sup> and Victoria Alexeeva-Talebi<sup>b</sup>

<sup>a</sup>University of Oldenburg

<sup>b</sup>Centre for European Economic Research, Mannheim

Emails: [christoph.boehringer@uni-oldenburg.de](mailto:christoph.boehringer@uni-oldenburg.de), [alexeeva-talebi@zew.de](mailto:alexeeva-talebi@zew.de)

**Abstract.** Unilateral emission reduction commitments raise concerns on international competitiveness and emission leakage that result in preferential regulatory treatment of domestic energy-intensive and trade-exposed industries. Our analysis illustrates the potential pitfalls of climate policy design which narrowly focuses on competitiveness concerns about energy-intensive and trade-exposed (EITE) branches. The sector-specific gains of preferential regulation in favour of these branches must be traded off against the additional burden imposed on other industries. Beyond burden shifting between industries, differential emission pricing bears the risk for substantial excess cost in emission reduction as policy concedes (too) low carbon prices to EITE industries and thereby foregoes relatively cheap abatement options in these sectors. From the perspective of global cost-effectiveness we find that differential emission pricing of EITE industries hardly reduces emission leakage since the latter is driven through robust international energy market responses to emission constraints. As a consequence the scope for efficiency compared to uniform pricing is very limited. Only towards stringent emission reduction targets will a moderate price differentiation achieve sufficient gains from leakage reduction to offset the losses of diverging marginal abatement cost.

**JEL Classification:** D58, H21, H22, Q48

**Keywords:** unilateral climate policy design, leakage, competitiveness

## 1 Introduction

At the sixteenth United Nations Climate Change Conference in Cancún, the world community committed itself to the objective of limiting the rise in global average temperature to no more than 2° Celsius above pre-industrial levels in order to hedge against dangerous anthropogenic interference with the climate system. According to scientific knowledge compiled by the Intergovernmental Panel on Climate Change in its Fourth Assessment Report (IPCC 2007), this implies that over the next decades global greenhouse gas emissions must be halved from their 1990 emission levels. To date, however, prospects for a Post-Kyoto agreement covering all major emitting countries are bleak. Even in the case of a broader follow-up agreement to the Kyoto Protocol, it is much likely that emission reduction targets will be quite unevenly spread across the signatory regions with OECD countries taking a lead role reflecting their historical responsibility and a higher ability to pay.

One-sided commitments to ambitious emission reduction targets raise competitiveness and emission leakage concerns in all the major economies implementing or proposing unilateral responses to the threat of climate change. At the fore of climate policy discussions, competitiveness and leakage concerns refer in particular to the performance of energy-intensive and trade-exposed (EITE) industries. Obviously, unilateral emission pricing of domestic industries where emission-intensive inputs represent a significant share of direct and indirect costs will put these sectors at a disadvantage compared to competing firms in countries abroad which lack comparable regulation. The loss in competitiveness is to some extent associated with the potential for emission leakage, i.e., the change of emissions in non-abating regions as a reaction to the reduction of emissions in abating regions (e.g. Hoel 1991 or Felder and Rutherford 1993). Leakage can arise when energy-intensive and trade-exposed industries in emission-constrained regions lose competitiveness, thereby increasing emission-intensive production in unconstrained regions (the trade channel). A second important leakage channel works through international energy markets (the energy channel): Emission constraints in larger open economies reduces the demand for fossil fuels, thereby depressing world energy prices which in turn lead to an increase in the level of energy demand in other regions. Competitiveness and leakage concerns have motivated claims for special treatment of energy-intensive and trade-exposed sectors ranging from reduced emission prices or output-based emission allocation to border carbon adjustments (see e.g. Böhringer et al. 2010a).

A prime example of the competitiveness and leakage issues at stake in unilateral climate policy is provided by the European Union (EU) which considers itself as a leading force in the battle against anthropogenic climate change. During the Spring Summit in March 2007, the European Council has agreed upon an ambitious climate policy with unilateral greenhouse gas emissions reductions in 2020 by at least 20% compared to 1990 levels (EC 2010). At the same time, the EU is strongly committed to the objective of increasing competitiveness, economic growth and enhancing job creation alongside the so-called Lisbon

Strategy (EU 2006).<sup>1</sup> The simultaneous pursuit of environmental and competitiveness objectives has led to the preferential treatment of EITE industries in EU climate policy. The aggregate EU emission reduction is divided between energy-intensive sectors – of which EITE industries are a subset – covered through an EU-wide emission trading system (the so-called EU ETS) and the remaining parts of the EU economy (without direct trade linkages). Mirroring competitiveness and leakage concerns, the emission reduction requirements for ETS sectors have been chosen relatively lax compared to the reduction targets for non-ETS segments of the EU economy (Convery and Redmond 2007) which effectively boils down to preferential emission pricing of EITE industries .

While the issue of competitiveness ranks high and has tangible implications for the design of unilateral emission regulation, the climate policy debate misses a rigorous clarification of competitiveness notions and a comprehensive quantitative analysis of policy proposals that respond to competitiveness concerns of specific industries. In the assessment of unilateral EU climate policy, the bulk of competitiveness research is skewed towards a partial equilibrium perspective focusing on EITE industries which are directly affected by the EU ETS (e.g. Ponssard and Walker 2008, Meunier and Ponssard 2010, Monjon and Quirion 2010). The sector-specific partial equilibrium framework does neither allow for a comparison of competitiveness implications across different industries nor a simultaneous assessment of economy-wide performance in terms of an overarching welfare metric. General equilibrium analyses of EU climate policies based on multi-sector, multi-region computable general equilibrium (CGE) models emphasize the excess cost of emission abatement induced by emission market segmentation and overlapping regulatory measures (see Böhringer et al. 2009 for a summary assessment of the EU climate and energy package) rather than competitiveness and leakage aspects.

Our paper provides an impact assessment of EU leadership in climate policy to illustrate the potential pitfalls of unilateral climate policy design that narrowly focuses on competitiveness concerns about EITE branches. Based on quantitative simulations with a large scale computable-general equilibrium model of global trade and energy we show that sector-specific gains of preferential regulation in favour of EITE branches must be traded off against the additional burden imposed on other industries to meet an economy-wide emission reduction target. Beyond burden shifting between industries, our results highlight the scope for substantial excess cost in emission reduction at the regional level as policy concedes lower carbon prices to EITE industries and thereby foregoes relatively cheap abatement options in these sectors. From the perspective of global cost-effectiveness, preferential emission pricing for domestic EITE sectors reduces leakage but nevertheless has only limited potential to lower overall cost of cutting global emissions as compared to uniform unilateral emission pricing.

The remainder of this paper is organised as follows. Section 2 discusses alternative indicators that can be used to quantify specific aspects of competitiveness at the level of sectors and countries. Section 3 lays out

---

<sup>1</sup> Focusing on the “pressing challenge for competitiveness”, the European Commission has initiated a permanent monitoring of competitiveness developments in the EU on the basis of selected competitiveness indicators in order to

a computable general equilibrium model complemented with selected competitiveness indicators to facilitate the comprehensive impact assessment of unilateral climate policies. Section 4 presents a quantitative impact assessment of EU leadership in climate policy. Section 5 summarises and concludes.

## 2 Competitiveness indicators

Competitiveness has become one of the most prominent catchwords in economics. Yet, the notion of competitiveness misses a well-defined conceptual framework and remains rather susceptible for ambiguities. As a basic orientation, scientific research distinguishes between *competitiveness determinants* governing the ability to compete and *competitiveness indicators* describing the outcome of competitiveness such as international trade performance or profitability (Reichel 2002, Aiginger 2006). For our impact assessment of climate policy interference, we adopt the outcome-based competitiveness notion and review the literature on appropriate sectoral and economy-wide competitiveness indicators.

### 2.1 Sectoral competitiveness indicators

The most widespread definition of sectoral competitiveness refers to a sector's "*ability to sell in international markets*" (Jaffe et al. 1995, Jenkins 1998, Xu 2000, Babool and Reed 2010). International competitiveness, defined in terms of foreign trade performance, is thereby closely linked with international trade theory in general and the concept of comparative advantage in particular. According to the latter, countries are likely to export those goods and services in which they have a comparative cost advantage.

The concept of a (revealed) comparative advantage has been interpreted as a "*revealed competitive advantage*" where industries with a comparative (cost) advantage are considered as internationally competitive (Jenkins 1998, Fertö and Hubbard 2003, Ahrend et al. 2007, Cai and Leung 2008).

An alternative definition of sectoral competitiveness refers to a sector's "*ability to be profitable*" (Sell 1991, EU 2005). This definition reflects the capacity to sell profitably in national and international markets. Cost pressure may not be (immediately) reflected in increasing prices as profits could play a buffer role to keep the market shares constant.<sup>2</sup>

Table 1 provides a list of sectoral competitiveness indicators for measuring the "*ability to sell in international markets*" and the "*ability to be profitable*". Indicators on international trade performance are either based on trade data or a combination of trade and production (consumption) data. Contrary to indicators of international trade performance, the empirical implementation of indicators to measure profitability is more difficult due to limited availability of appropriate data (EU 2005). Harvey (2003) suggests three types of profitability indicators at the industrial level using national accounts data: profit

---

detect divergences between member states and provide timely policy reactions (EU 2010).

<sup>2</sup> See Demailly and Quirion (2006, 2008), Smale et al. (2006) or Sato et al. (2007) for recent sector-specific applications of this concept to the EU ETS.

margin (profit over sales), rates of return (profit over capital stock) and profit shares (profit over total factor expenditures).

Table 1: List of competitiveness indicators at the sectoral level

International trade performance	Profitability performance
<ul style="list-style-type: none"> <li data-bbox="183 477 774 660">• <b>Revealed comparative advantage</b>  References: Balassa (1965), Ballance et al. (1987), Gorton et al. (2000), Fertö and Hubbard (2003), Abidin and Loke (2008)</li> <li data-bbox="183 678 774 817">• <b>Export (import) ratio in world's total exports (imports)</b>  References: Kravis and Lipsey (1992), Carlin et al. (2001), Reichel (2002)</li> <li data-bbox="183 835 774 952">• <b>Constant market share index</b>  References: Koopmann and Langer (1988), Holst and Weiss (2004)</li> <li data-bbox="183 969 774 1086">• <b>Intra-industry trade index (Grubel-Lloyd)</b>  References: EU (2005), Havrila and Gunawardana (2003)</li> <li data-bbox="183 1104 774 1191">• <b>Ratio of exports (imports) to production (consumption)</b>  References: Ballance et al. (1987)</li> </ul>	<ul style="list-style-type: none"> <li data-bbox="817 477 1380 616">• <b>Earnings before interests, tax, debt and amortisation (EBITDA)</b>  References: Smale et al. (2006), Sato et al. (2007), Demailly and Quirion (2006, 2008)</li> <li data-bbox="817 678 1380 817">• <b>Gross operating rate</b>  References: EU (2005), Peltonen et al. (2008)</li> <li data-bbox="817 835 1380 952">• <b>Rate of return</b>  References: Rossi et al. (1986), Wang (1995), Manne and Barreto (2004)</li> <li data-bbox="817 969 1380 1041">• <b>Profit share</b>  References: Torrini (2005)</li> </ul>

## 2.2 Economy-wide competitiveness indicators

At the economy-wide level the concept of competitiveness is discussed controversially. One of the most prominent critics to the popular use of the competitiveness notion, Paul Krugman, argues that „competitiveness is a meaningless word when applied to national economies” (Krugman 1994). Contrary to such fundamental criticism, competitiveness concepts at the economy-wide level are widely used in scientific studies (see Porter 1990 for an early contribution) and the public policy debate.<sup>3</sup> There are meanwhile numerous surveys of competitiveness terminologies at the economy-wide level (see e.g. Reichel 2002, Aiginger 2006 or Siggel 2007).

The conventional interpretation of national competitiveness – analogous to the “ability to sell” notion at the sectoral level – focuses on a country’s international trade performance (Durand and Giorno 1987, Fagerberg 1988, Nielsen et al. 1995). The traditional focus on “ability to sell” has shifted in the recent literature towards more general measurement concepts linked to normative economics. The argument

<sup>3</sup> The ranking of countries by competitiveness draws more and more policy attentions (see e.g. the Global Competitiveness Report issued by the World Economic Forum or the Doing Business Report established by the World Bank).

behind this shift is that the emphasis on international trade can be misleading as trade may represent only a small fraction of GDP and one-sided export orientation is not sustainable. Furthermore, expansion of exports – as an indicator of competitiveness – might have its origin in low wages, subsidies or weak currency resulting in lower standards of living in the country. The real matter then becomes “the ability to earn”, i.e. the ability to create wealth or high standards of living as a central dimension of national competitiveness (Jenkins 1998, EU 2004, Grilo and Koopman 2006, Aiginger 2006). Grilo and Koopman (2006) argue that international trade performance is only an appropriate competitiveness indicator at the sectoral level whereas competitiveness at the national level should be rigorously linked to welfare metrics such as GDP per capita or real consumption.

Dollar and Wolff (1993), Auerbach (1996), Reichel (2002), Hildebrandt and Silgoner (2007) and ECB (2009) take an intermediate position referring to both “ability to sell” and “ability to earn”. They suggest that changes in competitiveness at the economy-wide level measured by international performance indicators shall not be interpreted in isolation, but rather in combination with a country’s economic development and/or standards of living. The underlying argument is that the rise in living standards can be attributed to improved competitiveness at the national level as measured by the international trade performance indicators. Table 2 provides a summary of economy-wide competitiveness indicators.

Table 2: List of competitiveness indicators at the economy-wide level

<b>International trade performance</b>	<b>Ability to create welfare</b>
<ul style="list-style-type: none"> <li data-bbox="183 1196 758 1305">• <b>Terms of trade</b> References: Riley (1980), Di Bartolomeo (2005), Hildebrandt and Silgoner (2007)</li> <li data-bbox="183 1323 694 1433">• <b>Trade balance (Current account)</b> References: Nielsen et al. (1995), Deutsche Bundesbank (2007)</li> <li data-bbox="183 1451 742 1588">• <b>Export market share</b> References: Fagerberg (1988), Amable and Verspagen (1995), ECB (2005), Danninger and Joutz (2007)</li> <li data-bbox="183 1606 558 1682">• <b>(Real effective) exchange rate</b> References: Vitek (2009)</li> </ul>	<ul style="list-style-type: none"> <li data-bbox="813 1196 1388 1305">• <b>GDP per capita</b> References: Grilo and Koopman (2006), Aiginger (2006)</li> <li data-bbox="813 1323 1388 1433">• <b>Real consumption</b> References: Grilo and Koopman (2006), Aiginger (2006)</li> </ul>

The final conclusion which can be drawn from literature on competitiveness indicators to measure international trade performance is that it is not possible to identify a single valid measure from a theoretical (including normative) and empirical perspective.



### 3 Method for quantitative impact assessment

To quantify the economic implications of unilateral climate policies on competitiveness and welfare, we make use of a multi-sector, multi-region computable general equilibrium (CGE) model of global trade and energy use. CGE models build upon general equilibrium theory that combines behavioural assumptions on rational economic agents with the analysis of equilibrium conditions. They provide counterfactual ex-ante comparisons between a reference situation without policy intervention and the outcome triggered by policy reforms. The main virtue of the CGE approach is its comprehensive micro-consistent representation of price-dependent market interactions. The simultaneous explanation of the origin and spending of the agents' income makes it possible to address both economy-wide efficiency as well as distributional impacts of policy interference. The disaggregation of macroeconomic production, consumption and trade activities at the sector level based on national input-output accounts accommodates a coherent cross-comparison of economic performance between sectors and a trade-off analysis with economy-wide welfare. Changes in economic welfare are usually expressed in terms of the Hicksian equivalent variation (HEV) in income.<sup>4</sup> Beyond an appropriate sectoral disaggregation, a multi-region setting is indispensable for the economic impact analysis of climate policy interference: In a world which is integrated through trade, policy interference in larger open economies not only causes adjustment of domestic production and consumption patterns but also influences international prices via changes in exports and imports. The changes in international prices, i.e., the terms of trade, imply secondary effects that can significantly alter the impacts of the primary domestic policy (Böhringer and Rutherford 2002). The international dimension is also a prerequisite to track sectoral and economy-wide competitiveness implications related to the international trade performance.

Section 3.1 provides a non-technical overview of the basic CGE model structure adopted for our impact analysis of unilateral climate policies (for a detailed algebraic summary see the Appendix or Böhringer and Rutherford 2010).<sup>5</sup> Section 3.2 lays out the data sources in use for empirical parameterisation. Section 3.3 describes the CGE implementation of selected competitiveness indicators at the sector level – i.e. relative world trade shares (RWS) and revealed comparative advantage (RCA) – and the economy-wide level, i.e. the terms of trade (ToT) and real consumption. These competitiveness indicators are used in our numerical simulations in order to illustrate the meaningfulness and potential pitfalls of competitiveness analysis.

#### 3.1 Model structure

Figure 1 provides a diagrammatic structure of the static multi-sector, multi-region CGE model in use for our numerical analysis. A representative agent  $RA_r$  in each region  $r$  is endowed with three primary factors:

---

<sup>4</sup> The Hicksian equivalent variation in income denotes the amount which is necessary to add to (or deduct from) the benchmark income of the consumer so that she enjoys a utility level equal to the one in the counterfactual policy scenario on the basis of ex ante relative prices.

<sup>5</sup> The model code and data to replicate the simulation results are available from the authors upon request.

labour  $\bar{L}_r$ , capital  $\bar{K}_r$  and specific resources  $\bar{Q}_{fr}$  (the latter used for the production of fossil fuels  $f$  such as coal, gas and crude oil).

Figure 1: Diagrammatic overview of the model structure

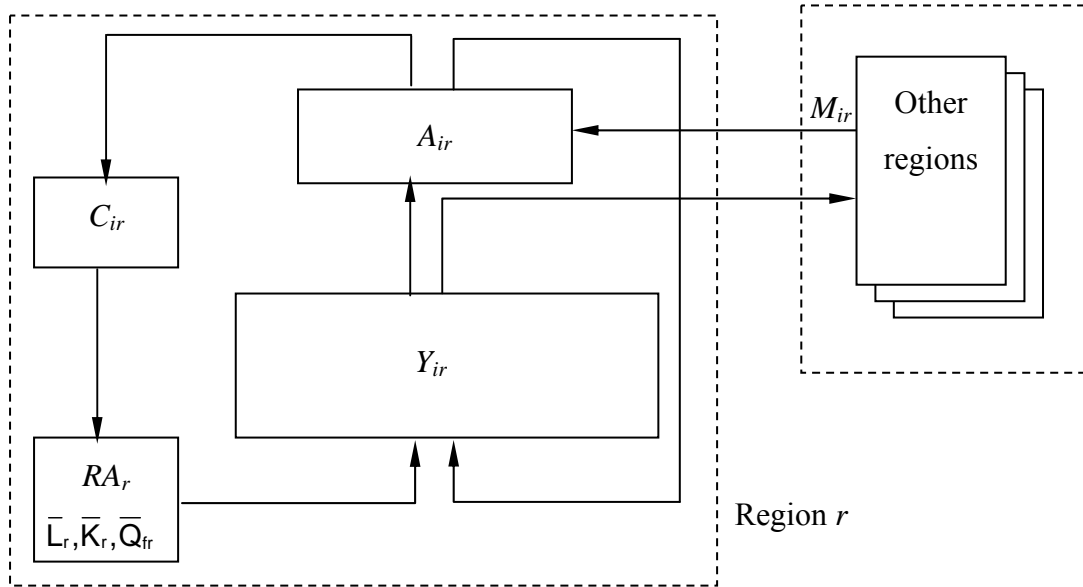

Labour and capital are assumed to be intersectorally mobile within a region but immobile between regions. Fossil-fuel resources are specific to fossil fuel production sectors in each region. Production  $Y_{ir}$  of commodity  $i$  in region  $r$  is captured by three-level constant elasticity of substitution (CES) cost functions describing the price-dependent use of capital, labour, energy and material in production. At the top level, a CES composite of intermediate material demands trades off with an aggregate of energy, capital and labour subject to a constant elasticity of substitution. At the second level, a CES function describes the substitution possibilities between demand for the energy aggregate and a value-added composite of labour and capital. At the third level, capital and labour substitution possibilities within the value-added composite are captured by a CES function whereas different energy inputs (coal, gas, oil and electricity) enter the energy composite subject to a constant elasticity of substitution. In the production of fossil fuels all inputs, except for the sector-specific fossil fuel resource, are aggregated in fixed proportions. This aggregate trades off with the sector-specific fossil fuel resource at a constant elasticity of substitution. The latter is calibrated to be generally consistent with empirical estimates for the supply elasticity of the specific fossil fuel.

Final consumption demand  $C_r$  in each region is determined by the representative agent who maximises utility subject to a budget constraint with fixed investment (i.e. a given demand for savings) and exogenous government provision of public goods and services. Total income of the representative household consists of net factor income and tax revenues. Consumption demand of the representative agent is given as a CES composite which combines consumption of non-electric energy and composite of other consumption goods.

Substitution patterns within the non-electric energy bundle are reflected by means of a CES function; other consumption goods trade off with each other subjected to a constant elasticity of substitution.

Bilateral trade is specified following the Armington approach of product heterogeneity, i.e. domestic and foreign goods are distinguished by origin (Armington 1969). All goods used on the domestic market in intermediate and final demand correspond to a CES composite  $A_{ir}$  which combines the domestically produced good ( $Y_{ir}$ ) and the imported composite ( $M_{ir}$ ) from other regions. Domestic production is split between input to the formation of the Armington good and exports to other regions subjected to a constant elasticity of transformation. The balance of payment constraint which is warranted through flexible exchange rates incorporates the base-year trade deficit or surplus for each region.

Carbon emissions are linked in fixed proportions to the use of fossil fuels; thereby carbon coefficients are differentiated by the specific carbon content of fuels. Restrictions to the use of carbon emissions in production and consumption are implemented through carbon taxes or exogenous emission constraints which keep carbon emissions to a specified limit. Carbon emission abatement then takes place by fuel switching (inter-fuel substitution) and energy savings (either by fuel-non-fuel substitution or by a scale reduction of production and final demand activities).

### **3.2 Data**

The model is based on the most recent consistent accounts of region- and sector-specific production, consumption, bilateral trade and energy flows as provided by the GTAP 7 data base for the year 2004 (Badri and Walmsley 2008). The GTAP data base features rudimentarily initial tax distortions. In our numerical analysis, we therefore abstain from the explicit representation of initial taxes. As to the sectoral and regional model resolution, the GTAP database is aggregated towards a composite dataset which accounts for the specific requirements of international climate policy analysis. At the sectoral level, the model captures details on sector-specific differences in factor intensities, degrees of factor substitutability and price elasticities of output demand in order to trace the structural change in production induced by policy interference. The energy goods identified in the model are coal, crude oil, natural gas, refined oil products and electricity. This disaggregation is essential in order to distinguish energy goods by carbon intensity and degree of substitutability. The model then incorporates explicitly carbon-(energy-)intensive commodities with significant shares of international trade that are potentially most affected by unilateral climate policies and are subject to competitiveness and leakage concerns: paper, pulp and print; chemical products; mineral products; iron and steel; non-ferrous metals and air transport. These sectors together with refined oil products are referred to as EITE industries in our numerical analysis below. The remaining sectors are summarised through a composite of all other industries and services. With respect to the regional disaggregation, the model includes the European Union (EU) together with other major industrialised and developing regions that are key players in international climate negotiations and at the same time intertwined through bilateral trade links: the United States of America, Japan, Russia, the rest of OECD, China, India, Brazil, the organisation of oil exporting countries (OPEC) and a composite region for

the rest of the developing world. Table 3 summarises the regional, sectoral and factor aggregation of the model.

Elasticities in international trade (Armington elasticities) are based on empirical estimates reported in the GTAP7 database. Substitution elasticities between production factors capital, labour, energy inputs and non-energy inputs (material) are taken from the econometric study by Okagawa and Ban (2008) who use the most recent panel data across sectors and industries for the period 1995 to 2004.

Table 3: Model dimensions

Production sectors	Regions and primary factors
<i>Energy</i>	<i>Regions</i>
Coal	European Union
Crude oil	United States of America
Natural gas	Japan
Electricity	Russia
Refined oil products	Rest of OECD
	China
<i>Non-Energy</i>	India
Paper, pulp and print	Brazil
Chemical products	OPEC
Mineral products	Rest of the developing world
Iron and steel	
Non-ferrous metals	<i>Primary factors</i>
Air transport	Labour
Other industries and services	Capital
	Fixed factor resources for coal, oil and gas

### 3.3 CGE implementation of competitiveness indicators

For our illustrative analysis of competitiveness effects triggered by unilateral climate policy, we implement a set of widely used competitiveness indicators: relative world trade shares (RWS) and revealed comparative advantage (RCA) in order to measure sectoral competitiveness effects and terms of trade (ToT) as well as real consumption to measure economy-wide competitiveness effects.

Letting  $X$  denote exports,  $P^x$  export prices,  $r$  the region and  $i$  the sector, the RWS index for sector  $i$  in region  $r$  can be written as follows (Balassa 1965, Reichel 2002):

$$RWS_{ir} = \frac{P_{ir}^x X_{ir} / \sum_r P_{ir}^x X_{ir}}{\sum_i P_{ir}^x X_{ir} / \sum_r \sum_i P_{ir}^x X_{ir}}.$$

This index compares the ratio of a country's exports in a certain sector to the world's exports in this sector with the ratio of a country's overall exports to the world's exports in all sectors. If the sectoral export-import ratio is identical to the economy-wide ratio, the RWS index takes the value of one ( $RWS_{ir} = 1$ ). A region  $r$  is said to have a comparative advantage in sector  $i$  if the RWS index exceeds unity ( $RWS_{ir} > 1$ ). Conversely, a region  $r$  has a comparative disadvantage in sector  $i$  if the RWS index takes the values between zero and one ( $0 \leq RWS_{ir} < 1$ ).

The validity of RWS as a general indicator for international trade performance is sometimes questioned because import flows are not taken into account. As an alternative metric, we therefore consider the revealed comparative advantage (RCA) indicator. The RCA index provides a measure for competitiveness of different industries within an economy. With the additional notations of  $P^m$  for import prices and  $M$  for imports, the RCA index for sector  $i$  in region  $r$  is defined as follows (Balassa 1965, Reichel 2002):

$$RCA_{ir} = \frac{P_{ir}^x X_{ir} / P_{ir}^m M_{ir}}{\sum_i P_{ir}^x X_{ir} / \sum_i P_{ir}^m M_{ir}}.$$

For a particular region and sector, this index compares the ratio of exports by a specific sector to its imports with the ratio of exports to imports across all sectors of the region. The RCA indicator ranges from  $0 \leq RCA_{ir} \leq \infty$  and can be interpreted regarding the range for comparative (dis-)advantage similarly to the RWS indicator.

While both sectoral indicators, RWS and RCA, purport to measure comparative advantage of a particular industry, they vary with respect to the point of reference: The RWS indicator measures how the relative performance of a particular sector in the country  $r$  changes compared to the relative performance of the same sector across the world. The RCA indicator compares the performance of a particular sector with performance of all sectors within the same region. In a partial equilibrium perspective, increases in exports  $X_{ir}$  of sector  $i$  in region  $r$  result ceteris paribus in increasing competitiveness according to  $RCA_{ir}$  and  $RWS_{ir}$  indicators. Vice versa, increasing imports will ceteris paribus decrease sectoral competitiveness. While RCA and RWS provide information on the quality and intensity of competitiveness implications at the sector level, they can neither be used to commensurate impacts across sectors nor as a general indication of economy-wide welfare effects.

At the economy-wide level, we implement a terms-of-trade (ToT) indicator to monitor competitiveness implications for international trade performance. The ToT indicator is defined as a Laspeyres index

measuring the ratio of the price index of exports to the price index of imports in which prices are weighted by the base-year quantities of exports  $\overline{X}_{ir}$  and imports  $\overline{M}_{ir}$  (see e.g. Krueger and Sonnenschein 1967):

$$ToT_r = \frac{\sum_i P_{ir}^x \overline{X}_{ir} / \sum_i \overline{P}_{ir}^x \overline{X}_{ir}}{\sum_i P_{ir}^m \overline{M}_{ir} / \sum_i \overline{P}_{ir}^m \overline{M}_{ir}},$$

whereas  $P_{ir}^x$  and  $\overline{P}_{ir}^x$  ( $P_{ir}^m$  and  $\overline{P}_{ir}^m$ ) represent current and base-year export (import) prices, respectively. Terms of trade deteriorate as the indicator decreases; terms of trade improve as the indicator increases.

Finally, the level of real consumption – as our alternative competitiveness indicators at the economy-wide level – is incorporated as an explicit activity variable in the CGE model. It directly captures welfare implications based on the CES expenditure function for final consumption goods.

#### 4 Impact assessment of unilateral EU climate policies

Our standard CGE framework, complemented with competitiveness indicators at the sectoral and economy-wide level, facilitates a comprehensive impact assessment of unilateral climate policies. The major drivers of economic impacts triggered by emissions constraints include (i) the stringency of the emissions reduction target, (ii) the policy implementation, (iii) the ease of emission abatement in production as well as consumption, and (iv) the spillover and feedback effects from international markets that emerge from policy action of larger economies.

We capture dimensions (i) and (ii) in the specification of our climate policy scenarios thereby reflecting the ongoing debate on the stringency of emission reduction pledges and preferential treatment of emission-intensive and trade-exposed (EITE) industries. Firstly, we vary the unilateral reduction target of the EU between 5%, 10%, 15%, 20%, 25% and 30% as compared to the reference emission level without climate policy action (the so-called business-as-usual, i.e., BaU). Higher reduction targets thereby go along with a more ambitious role of EU leadership in the fight against climate change. Secondly, we allow for differential emission pricing in favour of EITE industries, thereby mimicking actual policy legislation to ameliorate adverse competitiveness effects for these sectors.<sup>6</sup> In our simulations, the emission price ratio between the remaining segments of the economy, on the one hand, and the EITE industries, on the other hand, ranges from unity (i.e. uniform emissions pricing), via factors of 2, 5, 10 and 20 to full exemption of EITE industries. Ratios higher than one indicate that emissions prices are discriminated in favour of EITE

---

<sup>6</sup> As mentioned before, differential emissions pricing between EITE sectors and the rest of the economy corresponds to the contemporary hybrid EU climate policy legislation where energy-intensive industries covered under the EU emission trading scheme (EU ETS) face an emission price different from the marginal abatement cost in the remaining segments of the EU economy. The non-ETS segments are thereby subject to a myriad of domestic regulatory measures by each EU member state with specific marginal abatement costs in general above the EU ETS emission price.

sectors – for example, a ratio of 20 implies that the carbon price in the rest of the economy is twenty times higher than that for the EITE industries. The emission price level is thereby endogenously adjusted to warrant overall compliance with the exogenous EU-wide emission reduction target.

The remaining dimensions (iii) and (iv) are inherent to our CGE model framework: The ease of emission substitution in production and consumption is implicit to the top-down representation of technologies and preferences. That is through continuous functional forms that describe trade-offs between inputs (outputs) based on empirically estimated substitution (transformation) elasticities. The international spillover effects are captured through explicit bilateral trade relations between key trading partners at the sectoral level. Policy-induced changes in international prices, i.e. the terms of trade, may allow a country to shift part of its domestic abatement cost to trading partners or conversely suffer from a deterioration of its terms of trade (on top of purely domestic adjustment cost in the absence of terms-of-trade effects). International spillover effects furthermore provide the background for leakage concerns in the case of unilateral climate policies and the claim for preferential treatment of EITE sectors to reduce emission leakage.

For our graphical exposition of simulation results, we use bar diagrams along the different unilateral emissions abatement targets and the alternative emission price ratios. Note that in the graphs we refer to the case of full emission price exemptions in favour of EITE sectors with the label “ex”. The primary interest of our quantitative analysis is to highlight the pending trade-offs between economic performance across sectors (in terms of output and competitiveness indicators) and overall economic efficiency (in terms of real consumption) as a function of environmental stringency and preferential treatment of EITE industries. In this way, we can complement the often narrowly focused debate on competitiveness effects for EITE industries with insights on cost shifting to other segments of the economy and potential excess cost of environmental regulation. As it is customary in applied equilibrium analysis most of our results are reported in terms of percentage changes in economic indicators compared to a reference situation without climate policy interference – the business-as-usual (BaU). Our reference situation is one without climate policies, i.e. the historical outcome of the base year of the model 2004 (where neither the EU emissions trading system has been implemented nor the Kyoto Protocol had entered into force).

We start the interpretation of results with the marginal abatement cost for non-EITE segments of the economy. The marginal abatement cost for EITE industries then directly follow as a function of the imposed emission price ratio: For a carbon price ratio of 1, the marginal abatement cost are by definition uniform across all segments of the unilateral abating region.

Figure 2 illustrates how marginal abatement cost increase towards higher emission reduction targets as carbon emission abatement options through fuel switching (inter-fuel substitution) or energy savings (either via energy efficiency improvements or the scale reduction of production and final demand activities) become more and more expensive. Under uniform emission pricing, marginal abatement cost rise from roughly 30 USD per ton of carbon at a 5% unilateral emission reduction to more than 350 USD per ton of carbon at a 30% emission reduction. When policy grants preferential treatment of EITE sectors through

relatively lower emission prices it is clear that marginal abatement cost for the remaining segments of the economy must increase above the carbon value in the case of uniform emission pricing.

Figure 2: Marginal abatement cost in non-EITE segments of the EU economy (USD<sub>2004</sub> per ton of carbon)

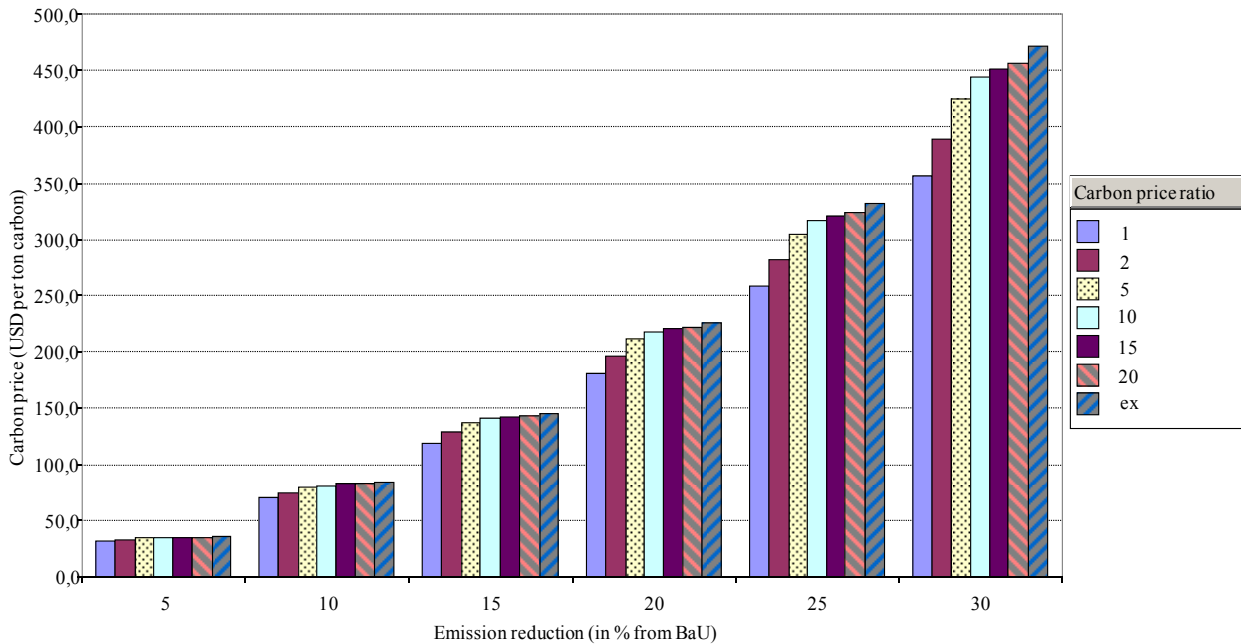

The increase in the absolute carbon price for non-EITE sectors (compared to the uniform carbon value) remains relatively moderate even for the case of total EITE exemption. The reasoning behind is that the EITE sectors are only responsible for a smaller share (less than 15%) of overall carbon emissions in the domestic economy. Yet, the additional price tag on non-EITE sectors becomes more and more pronounced towards higher emission reduction targets indicating the potential for substantial increases in direct abatement cost as the gap in marginal abatement cost between EITE and non-EITE sectors widens.

We next turn to the implications of unilateral climate policy on competitiveness at the sector level. Emission pricing has a direct impact on those sectors where emission-intensive inputs (fossil fuels) represent a significant share of direct and indirect cost. With uniform unilateral emission pricing, these sectors lose in comparative advantage not only against domestic emission-extensive industries; at the international level they are also at a disadvantage compared to competing energy-intensive industries which are not subject to emission regulation. Figures 3 and 4 depict the implications for competitiveness of EITE industries as well as for the bulk of non-EITE industries (summarised within the composite sector “Other industries and services”, OTH). Both trade-based indicators confirm competitiveness concerns for EITE sectors in the case of unilateral climate policy: EITE industries lose in competitiveness if we compare its trade performance with the average trade performance across all sectors of the unilateral abating region (RCA). Likewise, EITE industries suffer from a loss in competitiveness if we track the trade performance of this sector in the abating region compared to the performance of the same sector in other non-abating regions (RWA). The higher the emission reduction target and thus the implied emission price is, the higher



are ceteris paribus the losses in EITE competitiveness. As policy discriminates emission pricing in favour of EITE industries, these losses can be ameliorated to some extent.

Figure 3: EU Sectoral competitiveness effects – revealed comparative advantage (% change from BaU)

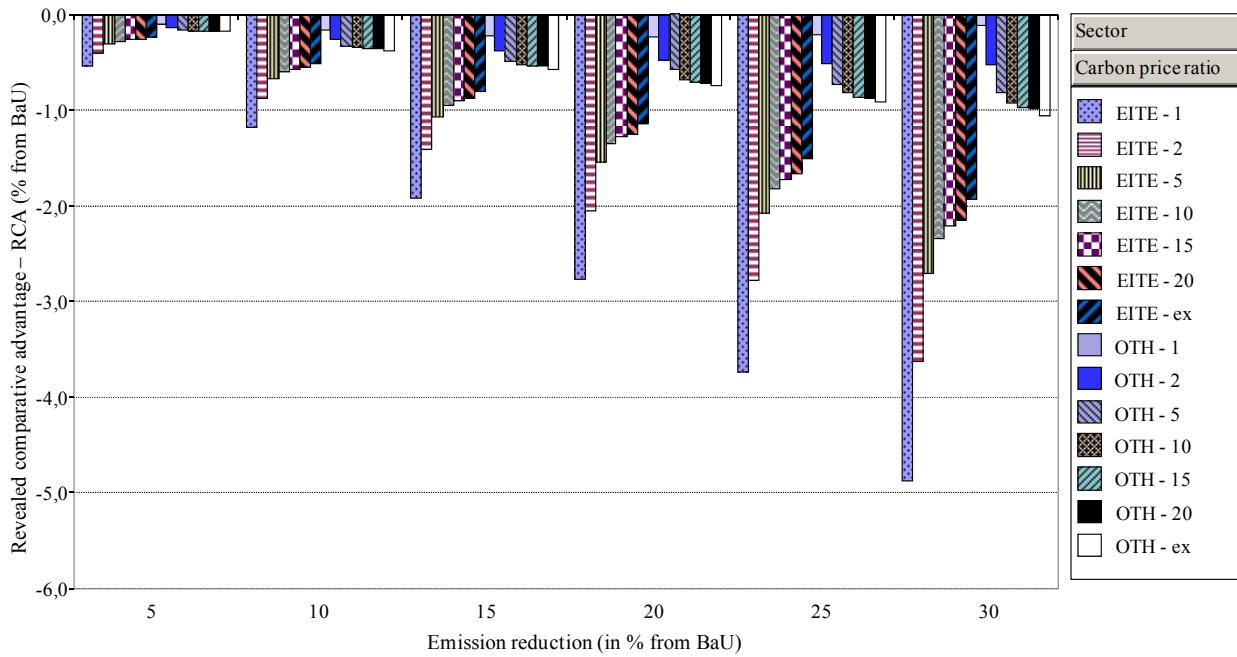
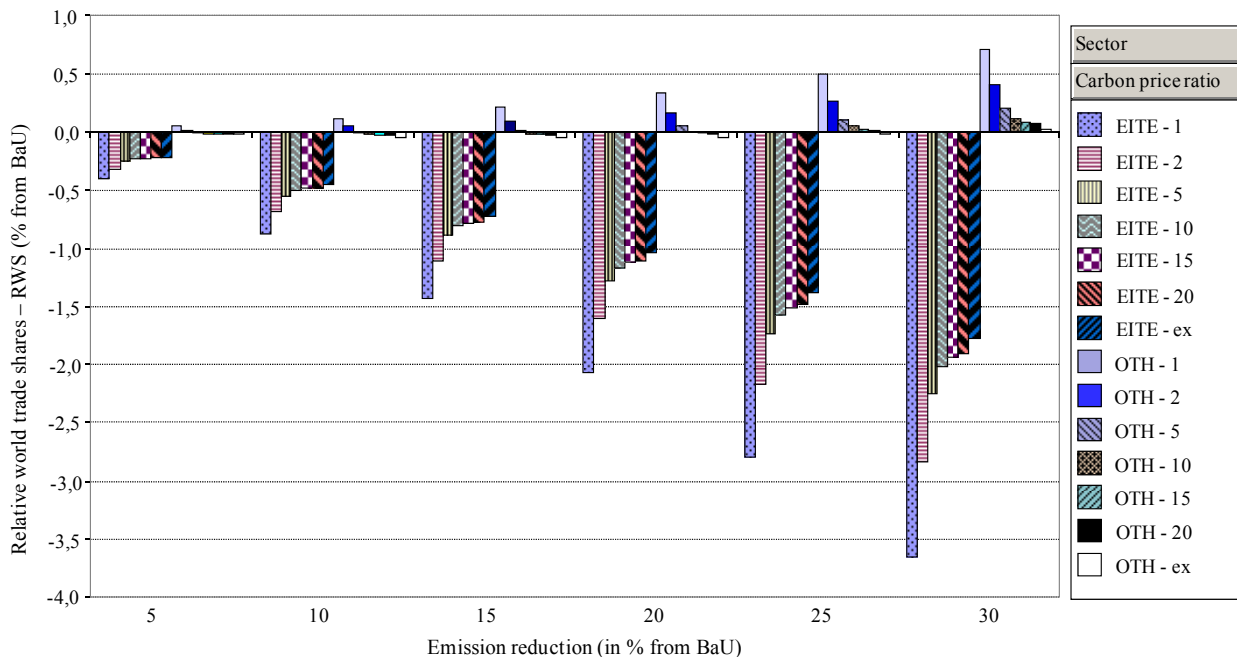

Figure 4: EU Sectoral competitiveness effects – relative world trade shares (% change from BaU)



However, Figures 3 and 4 also illustrate that preferential policies in favour of EITE sectors go at the expense of other industries whose competitiveness decrease towards higher carbon price ratios. While the specific changes in competitiveness RCA and RWS indicators provide a useful cardinal information on competitiveness implications at the sectoral level, it becomes obvious that a balanced view calls for the simultaneous assessment across various sectors of the domestic economy rather than focusing on a very narrow segment of the economy which might be most adversely affected by policy-induced structural

change. The trade-off between performances of sectors for differential emission pricing can be further visualised through the output effects in the different industries. Figure 5 indicates that EITE industries (with a BaU production share of slightly more than 10 %) suffer from substantial production losses due to emission constraints, while the rest of non-energy industries and services (OTH) industries with a much higher BaU production share may even slightly increase their output above BaU levels. The losses in EITE production can be substantially attenuated through differential emission pricing (up to roughly one-third for the extreme case of full exemption) but this works at the disadvantage of production in OTH industries.

Figure 5: Output effects in the EU (% change from BaU)

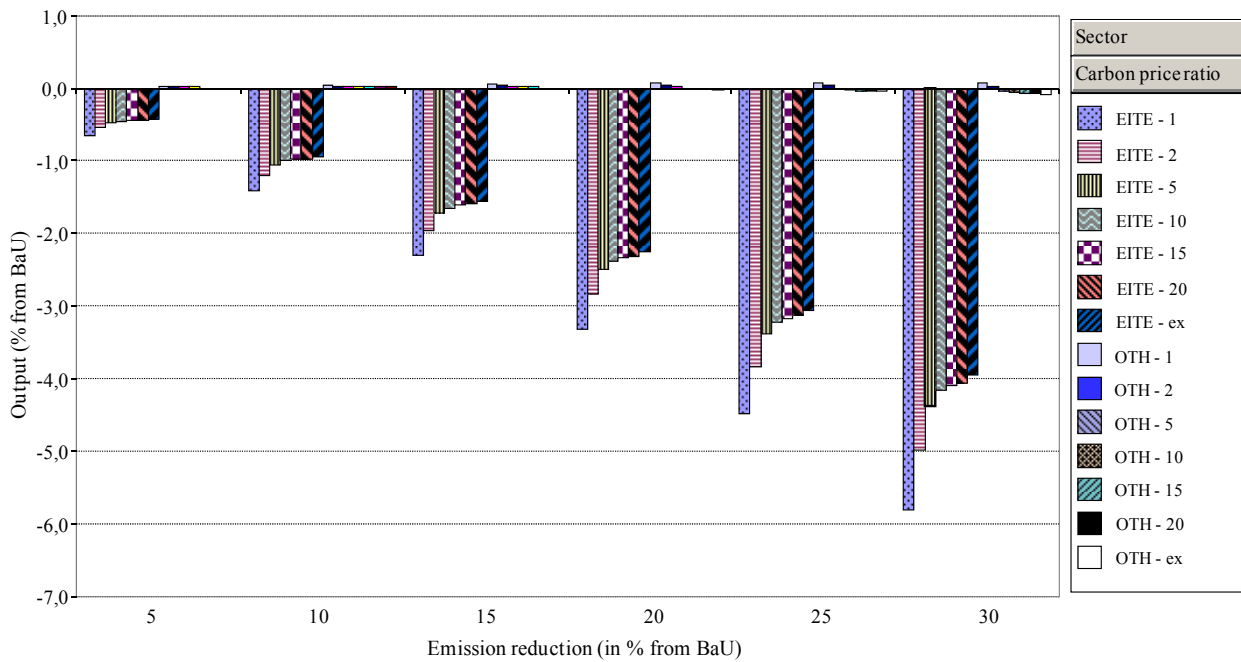

We now discuss the economy-wide implications of unilateral emission abatement. The common metric in general equilibrium analysis to report aggregate welfare changes is the Hicksian equivalent variation in income. In our analytical framework where we abstain from quantifying the (uncertain) benefits from emission reduction and keep savings demand constant, the policy-induced change in real income can be readily translated in changes of real consumption. In other words: The change in real consumption provides a consistent metric for cost-effectiveness analysis across alternative emission price ratios to reach the same level of unilateral emission abatement (for the discussion of global effectiveness incorporating leakage effects see below). Figure 6 reveals that the EU is able to achieve moderate emission reductions at negative costs as the direct costs of emission abatement are more than compensated through welfare gains from improved terms of trade. Towards higher emission reduction requirements the direct abatement costs dominate secondary terms-of-trade gains and the EU encounters non-negligible losses in real income. As climate policy deviates from uniform emission pricing in favour of EITE industries, there is an economy-wide excess burden of discriminatory climate policy. The latter becomes quite pronounced towards higher reduction targets where broader dispensation of cheap abatement options in the EITE sectors causes much higher abatement costs in the remaining segments of the economy. More generally, the EU experiences

terms-of-trade gains from unilateral emission reductions but there is no scope for additional net welfare gains (taken as the difference between direct abatement cost and indirect terms-of-trade gains) through lower emission pricing to EITE sectors.

Figure 6: Changes in real consumption in the EU (% change from BaU)

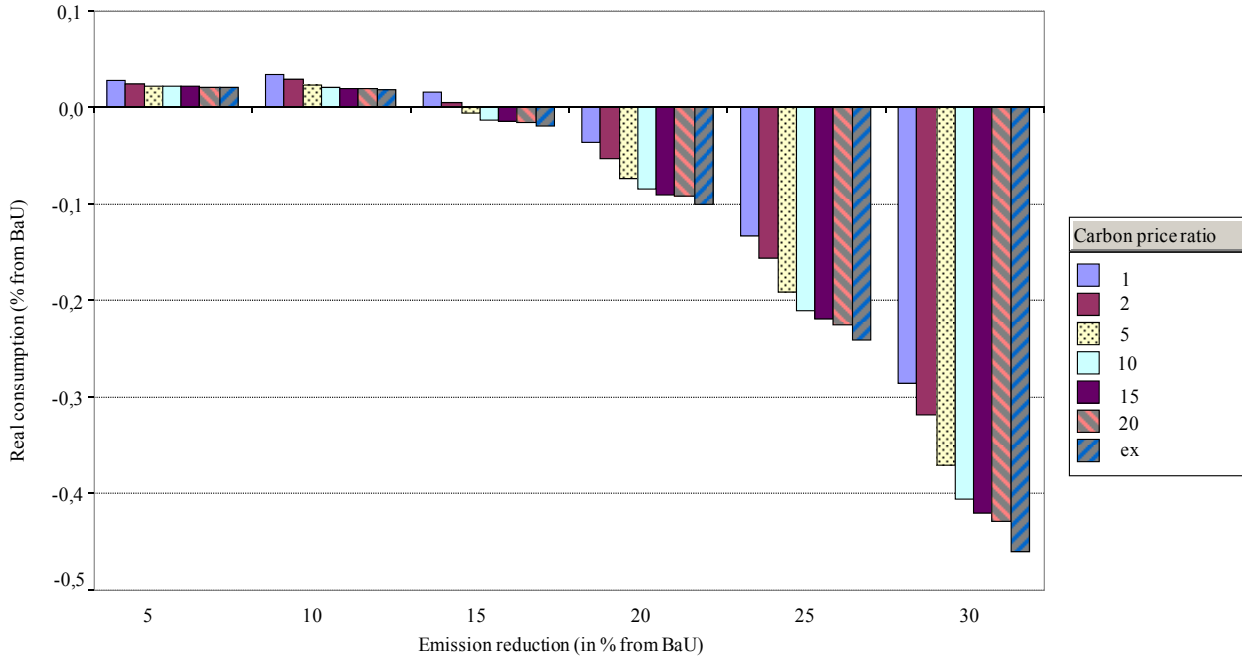

In this context, it is useful to distinguish international spillovers from fossil fuel markets, on the one hand, and from non-energy markets, on the other hand. Regarding spillovers on fossil fuel markets, cutbacks in international fuel demand of large open economies depress international fuel prices which in turn reduce the energy bill of the EU as a large fuel importer. The terms-of-trade effects on fossil fuel markets thereby dominate additional spillover effects on non-energy markets where emission price discrimination between EITE sectors and the remaining segments of the unilaterally abating region only has a secondary welfare impact (Böhringer et al 2010b). Taking real consumption as an appropriate economy-wide competitiveness indicator we can conclude that preferential treatment of EITE sectors rather worsens than alleviates the “national” competitiveness impact of unilateral climate policy for the EU. Figure 7 provides supplemental information on terms-of-trade changes for the EU triggered by unilateral climate policy. There are terms-of-trade gains for the EU from unilateral emission abatement (predominantly on international fuel markets) but these gains decrease with differential emission pricing in favour of EITE industries.

It is possible to decompose the welfare implications of secondary terms-of-trade effects by applying a simple decomposition technique described in Böhringer and Rutherford (2002). The total economic effect of unilateral abatement is thereby broken down into a primary domestic market effect (i.e. the domestic adjustment holding international prices constant) and the international spillover effect (i.e. the residual effect accounting for changes in the terms of trade). Figure 8 quantifies the primary domestic market effect at constant international prices for the EU economy. Without terms-of-trade effects, unilateral emission reduction triggers overall adjustment cost for the EU economy right away. Compliance cost increase

towards higher unilateral emission reduction pledges as well with differential emission pricing. Note that the difference in economy-wide adjustment cost between Figures 6 and 8 are equivalent to the welfare gains for the EU from policy-induced shifts in the terms of trade.

Figure 7: Terms of trade in the EU (% change from BaU)

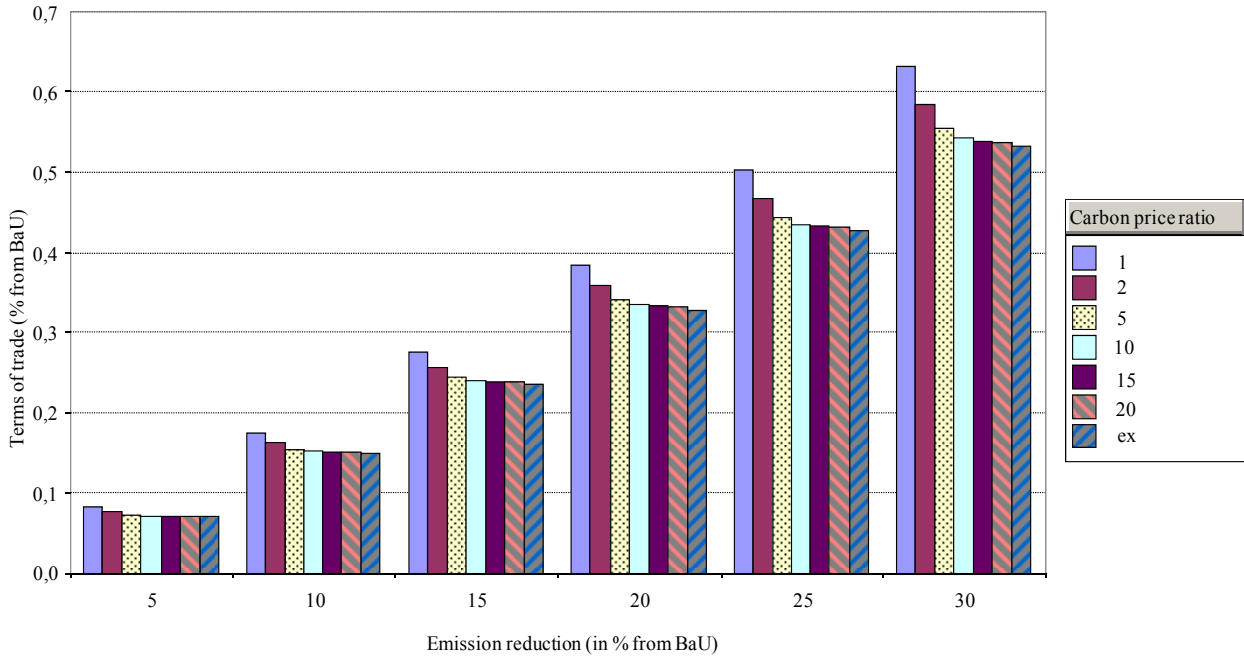
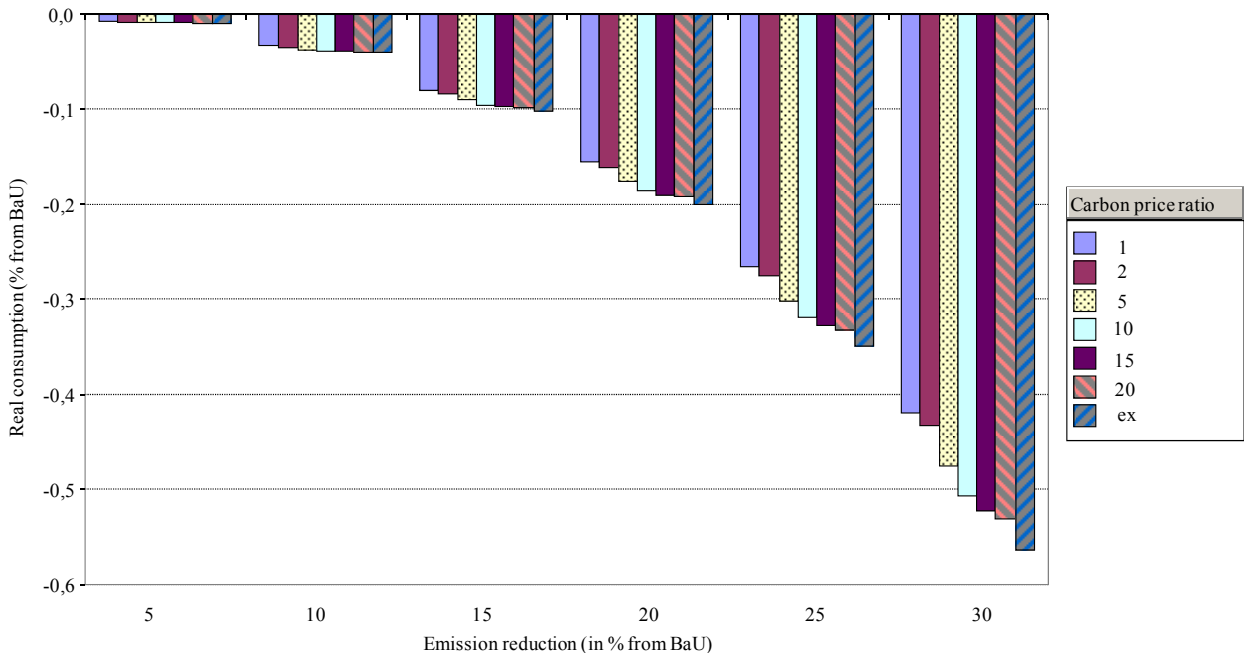

Figure 8: Changes in real consumption neglecting terms-of-trade changes in the EU (% change from BaU)



So far we have not addressed the issue of emission leakage and global cost-effectiveness of unilateral climate policy design. Compliance to regional emission targets at minimum cost for the domestic economy appeals as a realistic policy objective of the unilateral abating country. However, the focus on unilateral emission reduction neglects the different impacts of alternative policy implementations (in our case: differential emission pricing of EITE versus non-EITE sectors) on the level of global emissions via carbon

leakage. In fact, claims for preferential treatment of EITE sectors not only stem from concerns of politically influential lobbies on adverse adjustment (competitiveness) effects in these industries but may be justified as second-best strategies to reduce leakage and thereby potentially increase global cost-effectiveness of unilateral abatement. In this vein, we must investigate the question how compliance cost of the unilateral abating region change with preferential emission pricing as we keep global emissions constant. The “leakage-compensated” global emission constraint is thereby defined as sum of the BaU emissions across all non-abating regions (here: all non-EU regions) and the unilateral emission ceiling of the abating region (here: the EU). To achieve this, we endogenously scale the domestic reduction target of the unilaterally abating regions in order to offset adverse leakage impacts from non-abating regions on the global emission level (which will make unilateral action for the abating region more expensive as compared to the case without leakage compensation). While leakage compensation does not seem particularly relevant for actual policy practise of unilaterally abating regions, it provides a meaningful benchmark for judging the (global) cost-effectiveness of unilateral action without the need for evaluating the benefits from emission reduction. Against this background, Figure 9 confirms basic economic reasoning that preferential treatment of emission-intensive and trade-exposed industries will reduce leakage (defined as the change in foreign emissions as a share of the domestic emissions reductions): As the cost disadvantage of domestically regulated EITE industries is attenuated, emission-intensive production outside the EU will not increase as much.

Figure 9: Emission leakage rates (in %) in the case of unilateral leakage compensation

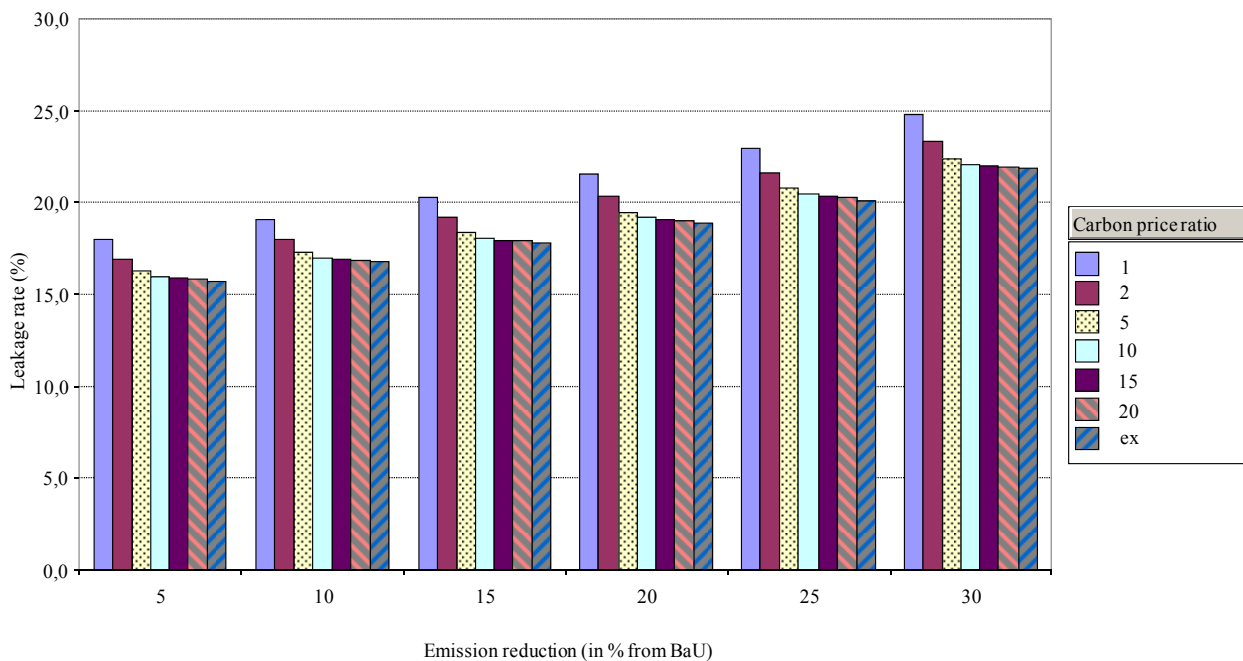

At the same time Figure 9 illustrates that emission pricing in favour of EITE industries is only a weak instrument to counteract leakage: The main part of leakage is due to the energy channel whose contribution is more or less fixed through the imposition of a constant global emission constraint (or likewise the reduction in global fossil fuel demand).

Figures 10 and 11 assess the implications of differential emission pricing under leakage compensation from the perspective of EU compliance cost and global economic adjustment cost. In both cases the potential for improved cost-effectiveness as compared to uniform pricing is very limited. Only towards stringent emission reduction targets will a moderate price differentiation achieve sufficient gains from leakage reduction to offset the losses of diverging marginal abatement cost.

Figure 10: Changes in the EU real consumption (% from BaU) in the case of leakage compensation

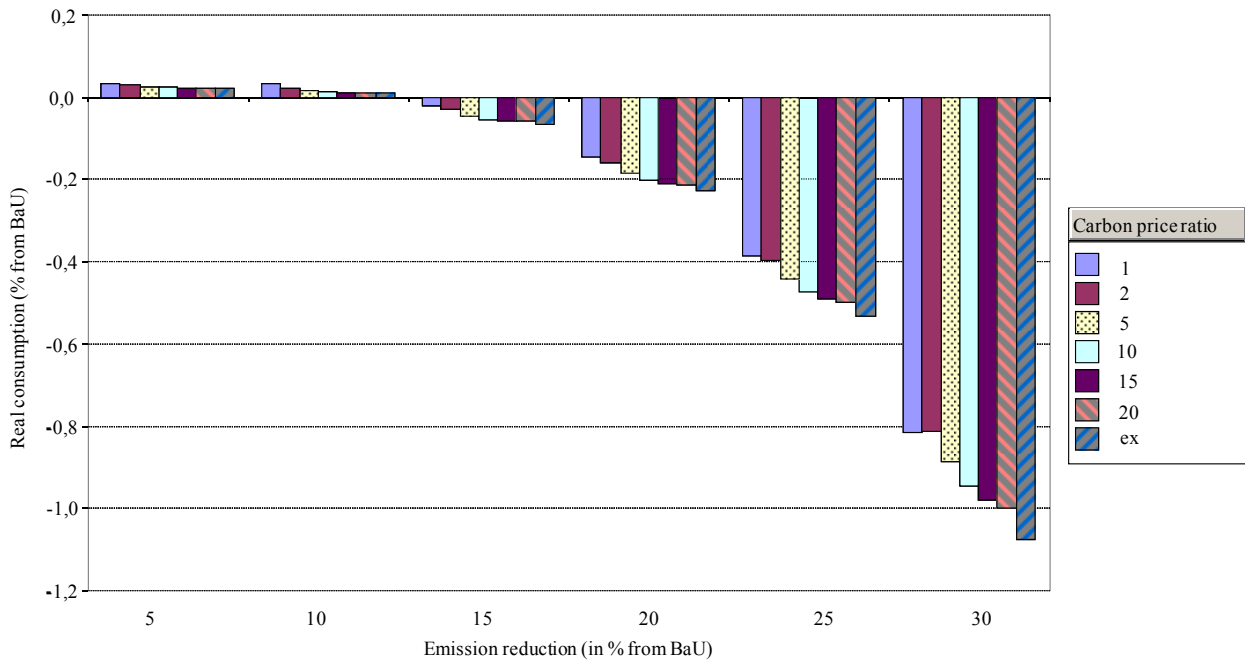
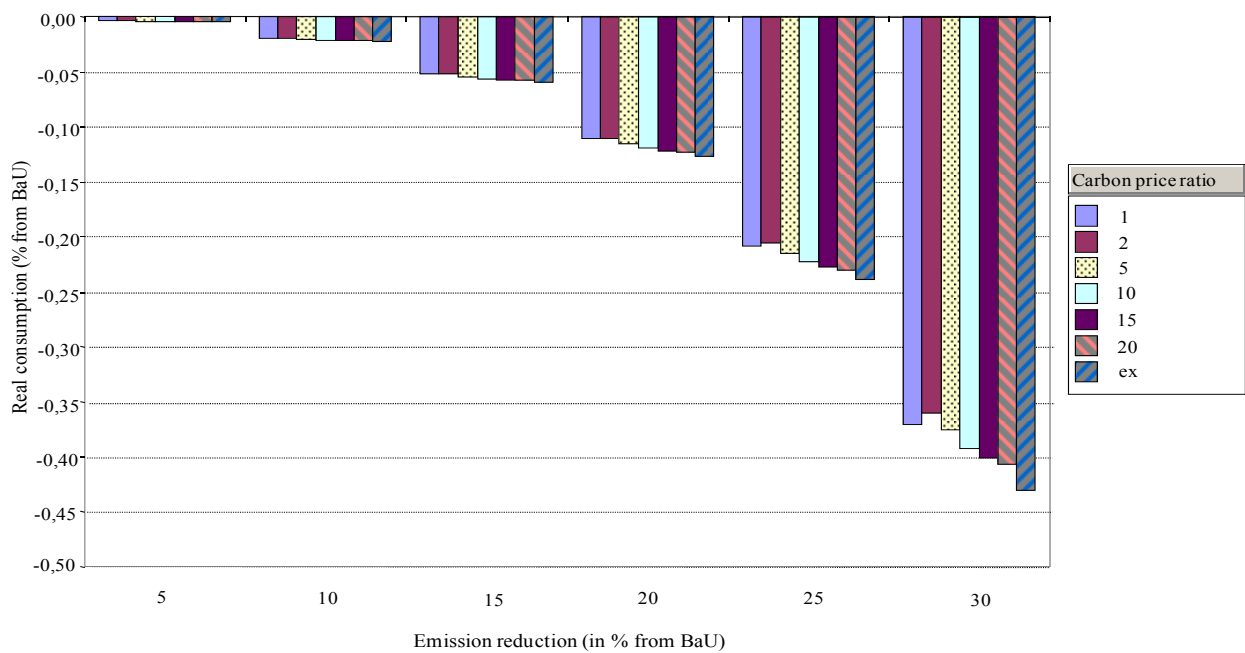

Figure 11: Changes in global real consumption (% from BaU)



## 5 Conclusions

In response to the challenges posed by climate change and the lack of a global greenhouse gas reduction treaty, individual OECD countries are in the process of legislating unilateral emission reduction strategies. As a primary example, the European Union has already committed itself to substantial unilateral greenhouse emissions reductions within the EU Climate and Energy Package. The prospect of rising carbon prices however fosters concerns on adverse competitiveness impacts for domestic energy-intensive and trade-exposed (EITE) industries compared to foreign competitors that are not constrained by comparable regulation. These competitiveness concerns joint with the potential for emission leakage provide the background for preferential treatment of EITE industries in unilateral climate policy legislation. While the climate policy debate is very much dominated by the issue of “competitiveness”, it misses a rigorous clarification of competitiveness notions and a comprehensive impact assessment of policy proposals that respond to competitiveness concerns of particular industries.

In this paper, we discussed alternative indicators that can be used to quantify specific aspects of competitiveness at the level of sectors and countries. We then used a computable general equilibrium model complemented with selected competitiveness indicators to facilitate the quantitative impact assessment of EU leadership in climate policy. Price discrimination in favour of EITE sectors may be warranted to preserve industrial competitiveness of these politically influential industries. From a broader economic perspective, however, the narrow focus on competitiveness concerns of EITE industries can be misleading. The sector-specific gains of preferential regulation in favour of these branches must be traded off against the additional burden imposed on other industries to meet an economy-wide emission reduction target. Beyond burden shifting between industries, differential emission pricing bears the risk for substantial excess cost in emission reduction as policy concedes (too) low carbon prices to EITE industries and thereby foregoes relatively cheap abatement options in these sectors. From the perspective of global cost-effectiveness we find that differential emission pricing of EITE industries hardly reduces emission leakage since the latter is driven through robust international energy market responses to emission constraints. As a consequence the scope for efficiency compared to uniform pricing is very limited. Only towards stringent emission reduction targets will a moderate price differentiation achieve sufficient gains from leakage reduction to offset the losses of diverging marginal abatement cost.

## References

- Armington, P.S. (1969), A Theory of Demand for Products Distinguished by Place of Production, *IMF Staff Papers* 16, 159–178.
- Abidin, M.Z. and W.H. Loke (2008), Revealed Comparative Advantage of Malaysian Exports: The Case for Changing Export Composition, *Asian Economic Papers*, 7(3), 130–147.
- Ahrend, R., de Rosa, D. and W. Tompson (2007), Russian Manufacturing and the Treat of “Dutch Disease”: A Comparison of Competitiveness Developments in Russian and Ukrainian Industry, *OECD Economics Department Working Paper* 540, OECD, Paris.

- Aiginger, K. (2006), Competitiveness: From a Dangerous Obsession to a Welfare Creating Ability with Positive Externalities, Special Issue on Competitiveness, *Journal of Industry, Competition and Trade*, 6(2), 161–177.
- Amable, B. and B. Verspagen (1995), The Role of Technology in Market Shares Dynamics, *Applied Economics* 27(2), 197–204.
- Auerbach P. (1996), Firms, Competitiveness and the Global Economy, in: M. Mackintosh, V. Brown, N. Costello, G. Dawson, G. Thompson and A. Trigg (eds.), *Economics and Changing Economies*, London et al.
- Babool, A. and M. Reed (2010), The Impact of Environmental Policy on International Competitiveness in Manufacturing, *Applied Economics* 42(18), 2317–2326.
- Badri N.G. and T.L. Walmsley (2008), Global Trade, Assistance, and Production: The GTAP 7 Data Base, Center for Global Trade Analysis, Purdue University
- Balassa B. (1965), Trade Liberalization and Revealed Comparative Advantage, *The Manchester School of Economic and Social Studies*, 33, 99–123.
- Ballance R.H., Forstner H. and T. Murray (1987), Consistency Tests of Alternative Measures of Comparative Advantage, *The Review of Economics and Statistics* 69(1), 157–161.
- Böhringer, C. and T.F. Rutherford (2002), Carbon Abatement and International Spillovers, *Environmental and Resource Economics* 22(3), 391–417.
- Böhringer, C., Tol, R.S.J. and T.F. Rutherford (2009), The EU 20/20/2020 Targets: An overview of the EMF22 assessment, *Energy Economics* 31(2), 268–273.
- Böhringer, C., Fischer, C. and K.E. Rosendahl (2010a), The Global Effects of Subglobal Climate Policies, *The B.E. Journal of Economic Analysis & Policy* 10 (2), Article 13.
- Böhringer, C., Lange, A. and T.F. Rutherford (2010b), Optimal Emission Pricing in the Presence of International Spillovers: Decomposing Leakage and Terms-of-Trade Motives, *NBER Working Paper* (w15899).
- Böhringer, C. and T.F. Rutherford (2010), The Costs of Compliance: A CGE Assessment of Canada's Policy Options under the Kyoto Protocol, *World Economy* 33(2), 177–211.
- Brooke, A., D. Kendrick and A. Meeraus. 1996. GAMS: A User's Guide , Washington DC, GAMS Development Corporation.
- Cai J. and P.S. Leung (2008), Towards a More General Measure of Revealed Comparative Advantage Variation, *Applied Economics Letters*, 15, 723–726.
- Carlin, W., Glyn, A. and J. van Reenen (2001), Export Market Performance of OECD Countries: An Empirical Examination of the Role of Cost Competitiveness, *The Economic Journal* 111(468), 128–162.
- Convery, F.J. and L. Redmond (2007), Market and Price Developments in the European Union Emissions Trading Scheme, *Review of Environmental Economics and Policy* 1 (1), 88–111.
- Danninger S. and F. Joutz (2007), What Explains Germany's Rebounding Export Market Share? *IMF Working Paper* WP/07/24.
- Demailly, D. and P. Quirion (2006), CO<sub>2</sub> Abatement, Competitiveness and Leakage in the European Cement Industry under the EU ETS: Grandfathering versus Output-Based Allocation, *Climate Policy* 6(1), 93–113.
- Demailly, D. and P. Quirion (2008), European Emission Trading Scheme and Competitiveness: A Case Study on the Iron and Steel Industry, *Energy Economics* 30(4), 2009–2027.
- Deutsche Bundesbank (2007), Current Account Balances and Price Competitiveness in the Euro Area, *Monthly Report June 2007*, Frankfurt am Main.



- Di Bartolomeo, G. (2005), Unions' Inflation Aversion and International Competitiveness, *Journal of Policy Modeling*, 27(2), 137–142.
- Dirkse, S. and M. Ferris (1995), 'The PATH Solver: A Non-monotone Stabilization Scheme for Mixed Complementarity Problems', *Optimization Methods & Software*, 5, 123–156
- Dollar D. and E.N. Wolff (1993), Competitiveness, Convergence, and International Specialization, The MIT-Press, Cambridge, Massachusetts, London.
- Durand, M. and C. Giorno (1987), Indicators of International Competitiveness: Conceptual Aspects and Evaluation, *OECD Economic Studies* 9, 147–197.
- ECB (2005), Competitiveness and the Export Performance of the Euro Area, *Occasional Paper Series* 30, Frankfurt am Main.
- ECB (2009), The External and Internal Dimensions of Europe's Competitiveness, Speech by Jean-Claude Trichet, President of the ECB at the Institute of International and European Affairs Dublin, 26 February 2009.
- EC (2010), Analysis of Options to Move Beyond 20% Greenhouse Gas Emission Reductions and Assessing the Risk of Carbon Leakage, Communication from the Commission to the European Parliament, the Council, the European Economic and Social Committee and the Committee of the Regions, Brussels. Available at: [http://ec.europa.eu/clima/documentation/package/docs/2010\\_05\\_26\\_communication\\_en.pdf](http://ec.europa.eu/clima/documentation/package/docs/2010_05_26_communication_en.pdf)
- EU (2004), European Competitiveness Report 2004, European Commission, Brussels. Available at: [http://trade.ec.europa.eu/doclib/docs/2005/march/tradoc\\_122064.pdf](http://trade.ec.europa.eu/doclib/docs/2005/march/tradoc_122064.pdf)
- EU (2005), EU Sectoral Competitiveness Indicators – A Pocketbook Prepared by the Enterprise and Industry Directorate-General Unit B2 "Competitiveness and Economic Reforms", European Commission, *Enterprise and Industry Publications*, Luxembourg. Available at: [http://ec.europa.eu/enterprise/newsroom/cf/document.cfm?action=display&doc\\_id=2201&userservice\\_id=1&request.id=0](http://ec.europa.eu/enterprise/newsroom/cf/document.cfm?action=display&doc_id=2201&userservice_id=1&request.id=0)
- EU (2006), Review of the EU Sustainable Development Strategy (EU SDS) – Renewed Strategy, Council of the European Union, Brussels. Available at: <http://register.consilium.europa.eu/pdf/en/06/st10/st10917.en06.pdf>
- EU (2010), Spring EU Summit to Focus on "Europe 2020" Strategy and Climate Change Policy after Copenhagen (25/03/2010). Available at: [http://ec.europa.eu/delegations/ukraine/press\\_corner/all\\_news/news/2010/2010\\_03\\_25\\_1\\_en.htm](http://ec.europa.eu/delegations/ukraine/press_corner/all_news/news/2010/2010_03_25_1_en.htm)
- Fagerberg, J. (1988), International Competitiveness, *The Economic Journal* 98, 355–374.
- Felder, S. and T.F. Rutherford (1993), Unilateral CO2 Reductions And Carbon Leakage - The Consequences Of International-Trade In Oil And Basic Materials, *Journal of Environmental Economics and Management* 25, 162-176.
- Fertő, I. and L.J. Hubbard (2003), Revealed Comparative Advantage and Competitiveness in Hungarian Agri-Food Sectors, *The World Economy*, 26(2), 247–259.
- Gorton, M., Davidova, S. and T. Ratering (2000), The Competitiveness of Agriculture in Bulgaria and the Czech Republic *Vis-à-Vis* the European Union, *Comparative Economic Studies*, 42(1), 59–86.
- Grilo I. and G.J. Koopman (2006), Productivity and Microeconomic Reforms: Strengthening EU Competitiveness, Special Issue on Competitiveness, *Journal of Industry, Competition and Trade* 6(2), 67–84.
- Harvey, R. (2003), National Accounts and Economic Statistics: Comparability of Savings and Profit Ratios, *Paper No. STD/NAES(2003)18*, OECD, Paris
- Havrila, I. and P. Gunawardana (2003), Analysing Comparative Advantage and Competitiveness: An Application to Australia's Textiles and Clothing Industries, *Australian Economic Papers* 42(1), 103–117.

- Hildebrandt, A. and M.A. Silgoner (2007), The Competitiveness Challenge: EU Member States in International Trade, *Monetary Policy & the Economy* 4, Österreichische Nationalbank, Vienna.
- IPCC (2007), Intergovernmental Panel on Climate Change, Climate Change 2007: Synthesis Report, available at: [http://www.ipcc.ch/pdf/assessment-report/ar4/syr/ar4\\_syr.pdf](http://www.ipcc.ch/pdf/assessment-report/ar4/syr/ar4_syr.pdf)
- Hoel, M. (1991), Global Environment Problems: The Effects of Unilateral Actions Taken by One Country, *Journal of Environmental Economics and Management* 20, 55–70.
- Holst, D.R. and J. Weiss (2004), ASEAN and China: Export Rivals or Partners in Regional Growth? *The World Economy* 27(8), 1255–1274.
- Jaffe, A.B., Peterson, S.R., Portney, P.R. and R.N. Stavins (1995), Environmental Regulation and the Competitiveness of U.S. Manufacturing: What does the Evidence Tell us? *Journal of Economic Literature* 33, 132–163.
- Jenkins, R. (1998), Environmental Regulation and International Competitiveness: A Review of Literature and Some European Evidence, The United Nations University Discussion Paper Series 9801, Institute for New Technologies, Maastricht.
- Koopmann, G. and C. Langer (1988), Trends in the International Competitiveness of Industrial Countries, *Intereconomics* 23(1), 8–14.
- Krueger A.O. and H. Sonnenschein (1967), The Terms of Trade, the Gains from Trade and Price Divergence, *International Economic Review* 8(1), 121–127.
- Krugman, P. (1994), Competitiveness: A Dangerous Obsession, *Foreign Affairs* 73(2), 28–44.
- Kravis, I.B. and R.E. Lipsey (1992), Sources of Competitiveness of the United States and of its Multinational Firms, *The Review of Economics and Statistics* 74(2), 193–201.
- Manne, A.S. and L. Barreto (2004), Learn-by-Doing and Carbon Dioxide Abatement, *Energy Economics*, 26(4), 621–633.
- Meunier, G. and J.-P. Ponsard (2010), A Sectoral Approach Balancing Global Efficiency and Equity, Working Paper, Ecole Polytechnique.
- Monjon, S. and P. Quirion (2010), Addressing Leakage in the EU ETS: Results from the CASE II model, Paper Presented at the Fourth World Congress of Environmental and Resource Economists, June 28 to July 2, 2010, Montreal, Canada.
- Nielsen J.U.-M., Madsen E.S., and K. Pedersen (1995), *International Economics – The Wealth of Open Nations*, McGraw-Hill Book, London et al.
- Okagawa, A. and K. Ban (2008), Estimation of Substitution Elasticities for CGE Models, mimeo, Osaka University, April 2008.
- Peltonen, T.A., Skala M., Rivera A.S. and G. Pula (2008), Imports and Profitability in the Euro Area Manufacturing Sector: The Role of Emerging Market Economies, *Working Paper* 918, European Central Bank, Frankfurt am Main.
- Ponsard, J.P. and N. Walker (2008), EU Emissions Trading and the Cement Sector: a Spatial Competition Analysis, *Climate Policy* 8(5), 467–493.
- Porter, M.E. (1990), *The Competitive Advantage of Nations*, Palgrave, New York.
- Reichel, R. (2002), *Ökonomische Theorie der Internationalen Wettbewerbsfähigkeit von Volkswirtschaften*, Deutscher Universitäts-Verlag GmbH, Wiesbaden.
- Riley, C.J. (1980), The Wage-Price Mechanism and the Long-Run Effects of Fiscal and Monetary Policies under Alternative Exchange Rate Regimes, *Scandinavian Journal of Economics*, 82(3), 332–351.
- Rossi, V., Walker, J., Todd, D. and K. Lennan (1986), Exchange Rate, Productivity and International Competitiveness, *Oxford Review of Economic Policy*, 2(3), 56–73.

- Sato, M., Grubb, M., Cust, J., Chan, K., Korppoo, A. and P. Ceppi (2007), Differentiation and Dynamics of Competitiveness Impacts from the EU ETS. Available at: <http://www.dspace.cam.ac.uk/bitstream/1810/194693/1/0712&EPRG0704.pdf>
- Sell A. (1991), Einführung in die Internationale Wirtschaftsbeziehungen, Walter de Gruyter, Berlin, New York.
- Siggel, E. (2007), The Many Dimensions of Competitiveness: International Competitiveness and Comparative Advantage: A Survey and a Proposal for Measurement, Paper Presented in CESifo Venice Summer Institute, July 20-21 2007.
- Smale, R., Hartley, M., Hepburn, C., Ward, J. and M. Grubb (2006), The Impact of CO<sub>2</sub> Emissions Trading on Firm Profits and Market Prices, *Climate Policy* 6, 31–48.
- Torrini, R. (2005), Profit Share and Returns on Capital Stock in Italy: The Role of Privatisations behind the Rise of the 1990s, *CEP Discussion Paper* 671, Centre for Economic Performance, London School of Economics and Political Science, London.
- Vitek, F. (2009), An Assessment of External Price Competitiveness for Mozambique, *IMF Working Paper* WP/09/165.
- Wang L.-J. (1995), Environmental Capital Flight and Pollution Tax, *Environmental and Resource Economics* 5(3), 273–286.
- Xu, X. (2000), International Trade and Environmental Regulation: Time Series Evidence and Cross Section Test, *Environmental and Resource Economics* 17, 233–257.

## Appendix Algebraic summary of CGE model

The computable general equilibrium model is formulated as a system of nonlinear inequalities. The inequalities correspond to the two classes of conditions associated with a general equilibrium: (i) exhaustion of product (zero profit) conditions for constant-returns-to-scale producers; and (ii) market clearance for all goods and factors. The former class determines activity levels and the latter determines price levels. In equilibrium, each of these variables is linked to one inequality condition: an activity level to an exhaustion of product constraint and a commodity price to a market clearance condition.

In our algebraic exposition, the notation  $\Pi_{ir}^z$  is used to denote the unit profit function (calculated as the difference between unit revenue and unit cost) for constant-returns-to-scale production of sector  $i$  in region  $r$  where  $z$  is the name assigned to the associated production activity. Differentiating the unit profit function with respect to input and output prices provides compensated demand and supply coefficients (Hotelling's Lemma), which appear subsequently in the market clearance conditions. We use  $g$  as an index comprising all sectors/commodities  $i$  ( $g=i$ ), the final consumption composite ( $g=C$ ), the public good composite ( $g=G$ ), and aggregate investment ( $g=I$ ). The index  $r$  (aliased with  $s$ ) denotes regions. The index  $EG$  represents the subset of all energy goods (here: coal, oil, gas, electricity) and the label  $FF$  denotes the subset of fossil fuels (here: coal, oil, gas). Tables A1–A6 explain the notations for variables and parameters

employed within our algebraic exposition. Figures A1–A3 provide a graphical exposition of the production structure. Numerically, the model is implemented in GAMS (Brooke et al. 1996) and solved using PATH (Dirkse and Ferris 1995).

Zero Profit Conditions:

1. Production of goods except fossil fuels ( $g \notin FF$ ):

$$\Pi_{gr}^Y = p_{gr} - \left[ \theta_{gr}^M p_{gr}^{M(1-\sigma_{gr}^{KLEM})} + (1-\theta_{gr}^M) \left[ \theta_{gr}^E p_{gr}^{E(1-\sigma_{gr}^{KLE})} + (1-\theta_{gr}^E) p_{gr}^{KL(1-\sigma_{gr}^{KLE})} \right]^{(1-\sigma_{gr}^{KLEM})/(1-\sigma_{gr}^{KLE})} \right]^{1/(1-\sigma_{gr}^{KLEM})} \leq 0$$

2. Sector-specific material aggregate:

$$\Pi_{gr}^M = p_{gr}^M - \left[ \sum_{i \notin EG} \theta_{igr}^{MN} p_{igr}^A 1^{-\sigma_{gr}^M} \right]^{1/(1-\sigma_{gr}^M)} \leq 0$$

3. Sector-specific energy aggregate:

$$\Pi_{gr}^E = p_{gr}^E - \left[ \sum_{i \in EG} \theta_{igr}^{EN} (p_{igr}^A + p_r^{CO_2} a_{igr}^{CO_2}) 1^{-\sigma_{gr}^E} \right]^{1/(1-\sigma_{gr}^E)} \leq 0$$

4. Sector-specific value-added aggregate:

$$\Pi_{gr}^{KL} = p_{gr}^{KL} - \left[ \theta_{gr}^K v^{(1-\sigma_{gr}^{KL})} + (1-\theta_{gr}^K) w^{(1-\sigma_{gr}^{KL})} \right]^{1/(1-\sigma_{gr}^{KL})} \leq 0$$

5. Production of fossil fuels ( $g \in FF$ ):

$$\Pi_{gr}^Y = p_{gr} - \left[ \theta_{gr}^Q q_{gr}^{1-\sigma_{gr}^Q} + (1-\theta_{gr}^Q) \left( \theta_{gr}^L w_r + \theta_{gr}^K v_r + \sum_{i \in FF} \theta_{igr}^{FF} p_{igr}^A \right)^{1-\sigma_{gr}^Q} \right]^{1/(1-\sigma_{gr}^Q)} \leq 0$$

6. Armington aggregate:

$$\Pi_{igr}^A = p_{igr}^A - \left( \theta_{igr}^A p_{ir}^{1-\sigma_{ir}^A} + (1-\theta_{igr}^A) p_{ir}^{M 1-\sigma_{ir}^A} \right)^{1/(1-\sigma_{ir}^A)} \leq 0$$

7. Aggregate imports across import regions:

$$\Pi_{ir}^{IM} = p_{ir}^{IM} - \left[ \sum_s \theta_{isr}^{IM} (p_{is})^{1-\sigma_{ir}^{IM}} \right]^{1/(1-\sigma_{ir}^{IM})} \leq 0$$

Market Clearance Conditions:

8. Labor:

$$\bar{L}_r \geq \sum_g Y_{gr}^{KL} \frac{\partial \Pi_{gr}^{KL}}{\partial w_r}$$

9. Capital:

$$\bar{K}_{gr} \geq Y_{gr}^{KL} \frac{\partial \Pi_{gr}^{KL}}{\partial v_{gr}}$$

10. Fossil fuel resources ( $g \in FF$ ):

$$\bar{Q}_{gr} \geq Y_{gr} \frac{\partial \Pi_{gr}^Y}{\partial q_{gr}}$$

11. Material composite:

$$M_{gr} \geq Y_{gr} \frac{\partial \Pi_{gr}^Y}{\partial p_{gr}^M}$$

12. Energy composite:

$$E_{gr} \geq Y_{gr} \frac{\partial \Pi_{gr}^Y}{\partial p_{gr}^E}$$

13. Value-added composite:

$$KL_{gr} \geq Y_{gr} \frac{\partial \Pi_{gr}^Y}{\partial p_{gr}^{KL}}$$

14. Import composite:

$$IM_{ir} \geq \sum_g A_{igr} \frac{\partial \Pi_{igr}^A}{\partial p_{ir}^{IM}}$$

15. Armington aggregate:

$$A_{igr} = Y_{gr} \frac{\partial \Pi_{gr}^Y}{\partial p_{igr}^A} .$$

16. Commodities ( $g=i$ ):

$$Y_{ir} \geq \sum_g A_{igr} \frac{\partial \Pi_{igr}^A}{\partial p_{ir}} + \sum_{s \neq r} IM_{is} \frac{\partial \Pi_{is}^{IM}}{\partial p_{ir}} .$$

17. Private consumption ( $g=C$ ):

$$Y_{Cr} p_{Cr} \geq w_r \bar{L}_r + \sum_g v_{gr} \bar{K}_{gr} + \sum_{i \in FF} q_{ir} \bar{Q}_{ir} + p_r^{CO_2} \bar{CO}_{2r} + \bar{B}_r .$$

18. Public consumption ( $g=G$ ):

$$Y_{Gr} \geq \bar{G}_r .$$

19. Investment ( $g=I$ ):

$$Y_{Ir} \geq \bar{I}_r .$$

20. Carbon emissions:

$$\overline{CO}_{2r} \geq \sum_g \sum_{i \in FF} E_{gr} \frac{\partial \Pi_{gr}^E}{\partial (p_{igr}^A + p_r^{CO_2} a_{igr}^{CO_2})} a_{igr}^{CO_2} .$$

Table A1: Indices (sets)

$G$	Sectors and commodities ( $g=i$ ), final consumption composite ( $g=C$ ), investment composite ( $g=I$ ), public good composite ( $g=G$ )
$I$	Sectors and commodities
$r$ (alias $s$ )	Regions
$EG$	Energy goods: Coal, crude oil, refined oil, gas and electricity
$FF$	Fossil fuels: Coal, crude oil and gas

Table A2: Activity variables

$Y_{gr}$	Production of item $g$ in region $r$
$M_{gr}$	Material composite for item $g$ in region $r$
$E_{gr}$	Energy composite for item $g$ in region $r$
$KL_{gr}$	Value-added composite for item $g$ in region $r$
$A_{igr}$	Armington aggregate of commodity $i$ for demand category (item) $g$ in region $r$
$IM_{ir}$	Aggregate imports of commodity $i$ and region $r$

Table A3: Price variables

$p_{gr}$	Price of item $g$ in region $r$
$p_{gr}^M$	Price of material composite for item $g$ in region $r$
$p_{gr}^E$	Price of energy composite for item $g$ in region $r$
$p_{gr}^{KL}$	Price of value-added composite for item $g$ in region $r$
$p_{igr}^A$	Price of Armington good $i$ for demand category (item) $g$ in region $r$
$p_{ir}^{IM}$	Price of import composite for good $i$ in region $r$
$w_r$	Price of labour (wage rate) in region $r$
$v_{ir}$	Price of capital services (rental rate) in sector $i$ and region $r$
$q_{ir}$	Rent to fossil fuel resources in region $r$ ( $i \in FF$ )
$p_r^{CO_2}$	Carbon value in region $r$

Table A4: Endowments and emissions coefficients

$\bar{L}_r$	Aggregate labour endowment for region $r$
$\bar{K}_{ir}$	Capital endowment of sector $i$ in region $r$
$\bar{Q}_{ir}$	Endowment of fossil fuel resource $i$ for region $r$ ( $i \in FF$ )
$\bar{B}_r$	Initial balance of payment deficit or surplus in region $r$ (note: $\sum_r \bar{B}_r = 0$ )
$\bar{CO}_{2r}$	Endowment of carbon emission rights in region $r$
$a_{igr}^{CO_2}$	Carbon emissions coefficient for fossil fuel $i$ in demand category $g$ of region $r$ ( $i \in FF$ )

Table A5: Cost shares

$\theta_{gr}^M$	Cost share of the material composite in production of item $g$ in region $r$
$\theta_{gr}^E$	Cost share of the energy composite in the aggregate of energy and value-added of item $g$ in region $r$
$\theta_{igr}^{MN}$	Cost share of the material input $i$ in the material composite of item $g$ in region $r$
$\theta_{igr}^{EN}$	Cost share of the energy input $i$ in the energy composite of item $g$ in region $r$
$\theta_{gr}^K$	Cost share of capital within the value-added of item $g$ in region $r$
$\theta_{gr}^Q$	Cost share of fossil fuel resource in fossil fuel production ( $g \in FF$ ) of region $r$
$\theta_{gr}^L$	Cost share of labour in non-resource inputs to fossil fuel production ( $g \in FF$ ) of region $r$
$\theta_{gr}^K$	Cost share of capital in non-resource inputs to fossil fuel production ( $g \in FF$ ) of region $r$
$\theta_{igr}^{FF}$	Cost share of good $i$ in non-resource inputs to fossil fuel production ( $g \in FF$ ) of region $r$
$\theta_{igr}^A$	Cost share of domestic output $i$ within the Armington item $g$ of region $r$
$\theta_{isr}^M$	Cost share of exports of good $i$ from region $s$ in the import composite of good $i$ in region $r$

Table A6: Elasticities

$\sigma_{gr}^{KLEM}$	Substitution between the material composite and the energy-value-added aggregate in the production of item $g$ in region $r^*$
$\sigma_{gr}^{KLE}$	Substitution between energy and the value-added nest of production of item $g$ in region $r^*$
$\sigma_{gr}^M$	Substitution between material inputs within the energy composite in the production of item $g$ in region $r^*$
$\sigma_{gr}^{KL}$	Substitution between capital and labour within the value-added composite in the production of item $g$ in region $r^*$
$\sigma_{gr}^E$	Substitution between energy inputs within the energy composite in the production of item $g$ in region $r$ (by default: 0.5)
$\sigma_{gr}^Q$	Substitution between natural resource input and the composite of other inputs in fossil fuel production ( $g \in FF$ ) of region $r$ (calibrated consistently to exogenous supply elasticities)
$\sigma_{ir}^A$	Substitution between the import composite and the domestic input to Armington production of good $i$ in region $r^{**}$
$\sigma_{ir}^{IM}$	Substitution between imports from different regions within the import composite for good $i$ in region $r^{**}$

Notes: \* see Okagawa and Ban (2008); \*\* see Badri and Walmsley (2008).



Figure A1: Nesting in Non-fossil Fuel Production

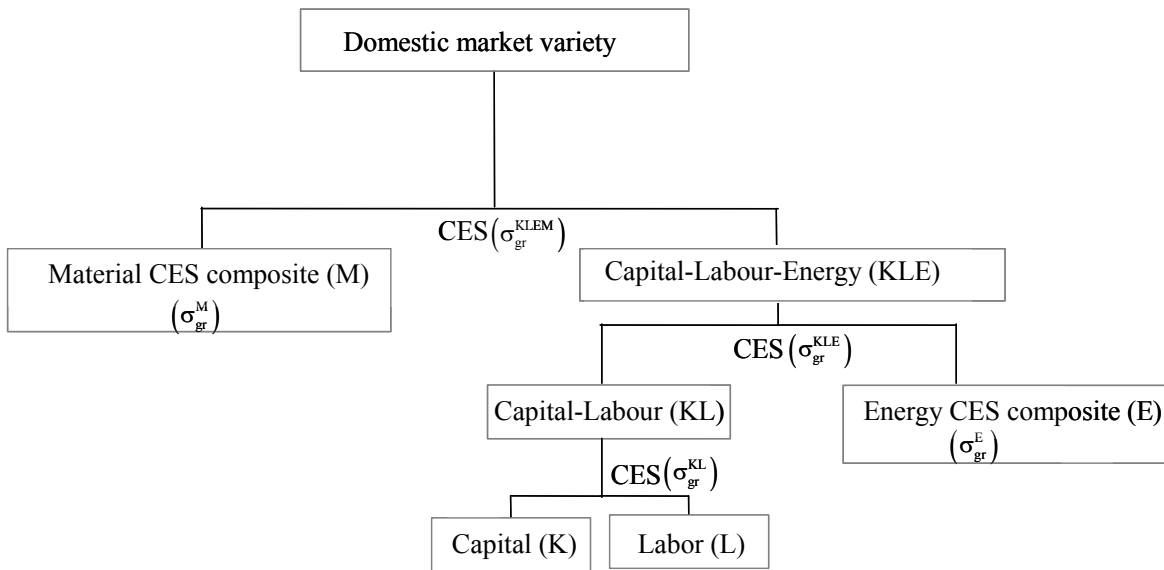

Figure A2: Nesting in Fossil Fuel Production

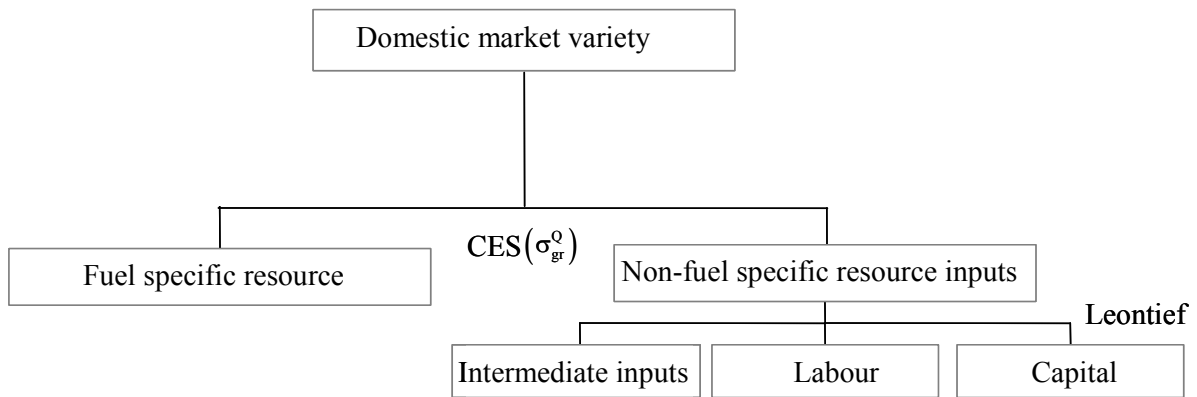
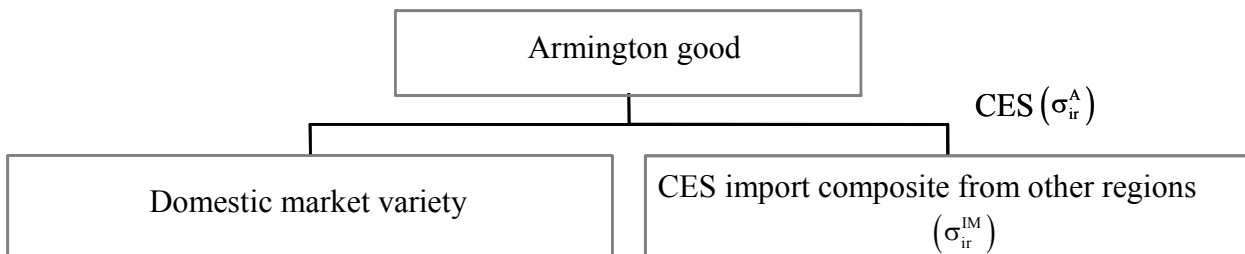

Figure A3: Nesting in Armington Production





**Bisher erschienen:**

- V-297-07 **Christoph Böhringer and Carsten Helm**, On the Fair Division of Greenhouse Gas Abatement Cost
- V-298-07 **Christoph Böhringer**, Efficiency Losses from Overlapping, Regulation of EU Carbon Emissions
- V-299-07 **Udo Ebert**, Living standard, social welfare and the redistribution of income in a heterogeneous population
- V-300-07 **Udo Ebert**, Recursively aggregable inequality measures: Extensions of Gini's mean difference and the Gini coefficient
- V-301-07 **Udo Ebert**, Does the definition of nonessentiality matter? A clarification
- V-302-07 **Udo Ebert**, Dominance criteria for welfare comparisons: Using equivalent income to describe differences in needs
- V-303-08 **Heinz Welsch, Jan Kühling**, Pro-Environmental Behavior and Rational Consumer Choice: Evidence from Surveys of Life Satisfaction
- V-304-08 **Christoph Böhringer and Knut Einar Rosendahl**, Strategic Partitioning of Emissions Allowances Under the EU Emission Trading Scheme
- V-305-08 **Niels Anger, Christoph Böhringer and Ulrich Oberndorfer**, Public Interest vs. Interest Groups: Allowance Allocation in the EU Emissions Trading Scheme
- V-306-08 **Niels Anger, Christoph Böhringer and Andreas Lange**, The Political Economy of Environmental Tax Differentiation: Theory and Empirical Evidence
- V-307-08 **Jan Kühling and Tobias Menz**, Population Aging and Air Pollution: The Case of Sulfur Dioxide
- V-308-08 **Tobias Menz, Heinz Welsch**, Population Aging and Environmental Preferences in OECD: The Case of Air Pollution
- V-309-08 **Tobias Menz, Heinz Welsch**, Life Cycle and Cohort Effects in the Valuation of Air Pollution: Evidence from Subjective Well-Being Data
- V-310-08 **Udo Ebert**, The relationship between individual and household welfare measures of WTP and WTA
- V-311-08 **Udo Ebert**, Weakly decomposable inequality measures
- V-312-08 **Udo Ebert**, Taking empirical studies seriously: The principle of concentration and the measurement of welfare and inequality
- V-313-09 **Heinz Welsch**, Implications of Happiness Research for Environmental Economics
- V-314-09 **Heinz Welsch, Jan Kühling**, Determinants of Pro-Environmental Consumption: The Role of Reference Groups and Routine Behavior
- V-315-09 **Christoph Böhringer and Knut Einar Rosendahl**, Green Serves the Dirtiest: On the Interaction between Black and Green Quotas
- V-316-09 **Christoph Böhringer, Andreas Lange, and Thomas P. Rutherford**, Beggar-thy-neighbour versus global environmental concerns: an investigation of alternative motives for environmental tax differentiation
- V-317-09 **Udo Ebert**, Household willingness to pay and income pooling: A comment
- V-318-09 **Udo Ebert**, Equity-regarding poverty measures: differences in needs and the role of equivalence scales
- V-319-09 **Udo Ebert and Heinz Welsch**, Optimal response functions in global pollution problems can be upward-sloping: Accounting for adaptation
- V-320-10 **Edwin van der Werf**, Unilateral climate policy, asymmetric backstop adoption, and carbon leakage in a two-region Hotelling model
- V-321-10 **Jürgen Bitzer, Ingo Geishecker, and Philipp J.H. Schröder**, Returns to Open Source Software Engagement: An Empirical Test of the Signaling Hypothesis
- V-322-10 **Heinz Welsch, Jan Kühling**, Is Pro-Environmental Consumption Utility-Maximizing? Evidence from Subjective Well-Being Data
- V-323-10 **Heinz Welsch und Jan Kühling**, Nutzenmaxima, Routinen und Referenzpersonen beim nachhaltigen Konsum
- V-324-10 **Udo Ebert**, Inequality reducing taxation reconsidered
- V-325-10 **Udo Ebert**, The decomposition of inequality reconsidered: Weakly decomposable measures
- V-326-10 **Christoph Böhringer and Knut Einar Rosendahl**, Greening Electricity More Than Necessary: On the Excess Cost of Overlapping Regulation in EU Climate Policy

- V-327-10 **Udo Ebert and Patrick Moyes**, Talents, Preferences and Inequality of Well-Being
- V-328-10 **Klaus Eisenack**, The inefficiency of private adaptation to pollution in the presence of endogeneous market structure
- V-329-10 **Heinz Welsch**, Stabilität, Wachstum und Well-Being: Wer sind die Champions der Makroökonomie?
- V-330-11 **Heinz Welsch and Jan Kühling**, How Has the Crisis of 2008-2009 Affected Subjective Well-Being?
- V-331-11 **Udo Ebert**, The redistribution of income when needs differ
- V-332-11 **Udo Ebert and Heinz Welsch**, Adaptation and Mitigation in Global Pollution Problems: Economic Impacts of Productivity, Sensitivity, and Adaptive Capacity
- V-333-11 **Udo Ebert and Patrick Moyes**, Inequality of Well-Being and Isoelastic Equivalence Scales
- V-334-11 **Klaus Eisenack**, Adaptation financing as part of a global climate agreement: is the adaptation levy appropriate?
- V-335-11 **Christoph Böhringer and Andreas Keller**, Energy Security: An Impact Assessment of the EU Climate and Energy Package
- V-336-11 **Carsten Helm and Franz Wirl**, International Environmental Agreements: Incentive Contracts with Multilateral Externalities
- V-337-11 **Christoph Böhringer, Bouwe Dijkstra, and Knut Einar Rosendahl**, Sectoral and Regional Expansion of Emissions Trading
- V-338-11 **Christoph Böhringer and Victoria Alexeeva-Talebi**, Unilateral climate policy and competitiveness: The implications of differential emission pricing

---

\* Die vollständige Liste der seit 1985 erschienenen Diskussionspapiere ist unter <http://www.vw.uni-oldenburg.de/51615.html> zu finden.